

Make your space work.



2023 List Pricer

WORKSPACES

Desks | Workstations | Storage | Universal Screens



Effective Date

March 2023

Updated December 2023

LIST PRICER

Effective Date: March 2023

- All illustrations and specifications in this publication are based on the latest product information available at the time of print. For the most recent version, please go to www.hon.com.
- Software support packages furnished to the customer, either by The HON Company or by another source, which support the sale of HON products are superseded by printed price lists.
- All dimensions shown in this publication are nominal.
- Pricing is subject to change without notice.
- All orders are subject to prices in effect at the time of order.
- Ordering information appears at the beginning of a section complete with examples on how to specify. These specifying information pages are referenced at the bottom center of product pages.
- HON Full Lifetime Warranty applies unless otherwise noted.
- HON nationwide customer service:
Phone: (800) 833-3964

HON LIST PRICER

Table of Contents

INTRODUCTION

Table of Contents.....	1-3
Additions.....	4-4.1
Discontinuations.....	5
HON Full Lifetime Warranty Information.....	7
HON Limited 5-Year Warranty Information.....	8
Ordering Information.....	9
Integrated Design Solutions.....	10
Tailored Solutions Ordering Information.....	11
Customer's Own Material Ordering Information.....	12-13
Partnership Textile Information.....	14
Paint Program.....	15
HON Open Line Laminate Program.....	16
Environmental Statement.....	17
Important Information.....	18
Legend.....	19
Fabric Patterns & Codes.....	20
Lead Times.....	21
Seating Fabric Patterns & Codes.....	22-24.1
Panel Fabric Patterns & Codes.....	25-26

DESKS

Features Offered on HON Laminate Casegoods.....	27
Concinnity™	28
Concinnity™ Ordering Information	29
Concinnity™ Statement of Line	30-32
Concinnity™ Laminate Design/Materials Information	33-35
Concinnity™ Laminate Ordering/Specification Information	36
Concinnity™ Stack-on Storage Applications	37-38
Concinnity™ Wall Mount Storage Applications	39-40
Concinnity™ Components	41-43
Concinnity™ Modesty/Back Panels	44
Concinnity™ Privacy Screens	45
Concinnity™ Components — Supports	46
Concinnity™ Paper Organizer Compatibility	47
Concinnity™ Cord Management	48-49
Concinnity™ Typical.....	50-54
Concinnity™ Desks.....	55-57
Concinnity™ Peninsulas.....	58-59
Concinnity™ Corner Unit.....	60
Concinnity™ Credenzas.....	61
Concinnity™ Low Credenzas.....	62
Concinnity™ Returns.....	63
Concinnity™ Bridges.....	64
Concinnity™ Stack-on Storage.....	65-69
Concinnity™ Wall Mount Storage.....	70-73
Concinnity™ Bookcase Hutches.....	74-75
Concinnity™ Reception Stations.....	76-78
Concinnity™ Mobile Pedestals.....	79
Concinnity™ Lateral Files.....	80
Concinnity™ Storage Cabinets.....	81-82
Concinnity™ Wardrobes.....	83
Concinnity™ Storage Towers.....	84
Concinnity™ Bookcases.....	85
Concinnity™ Components — Worksurfaces.....	86-91
Concinnity™ Components — Supports.....	92

Concinnity™ Components — Modesty/Back Panels.....	93-95
Concinnity™ Components — Supports.....	96
Concinnity™ Kneespace Clearance End Panels.....	97
Concinnity™ Components — Supports.....	98-102
Concinnity™ Height Adjustable Bases.....	103-105
Concinnity™ Components — Supports.....	107-109
Concinnity™ Components — Pedestal Tops.....	110
Concinnity™ Components — Pedestal Back Panels.....	111
Concinnity™ Accessories.....	112
Coordinate™	113
Coordinate™ Ordering Information	114
Coordinate™ Height Adjustable Bases.....	115-116
Coordinate™ Worksurfaces.....	117-118
Coordinate™ ETA Height Adjustable Bases.....	119
Coordinate™ Accessories.....	120
Coordinate™ Desktop PET Screens.....	121-122
Coze™	123
Coze™ Table Desks.....	124-125
Mod	126
Mod Ordering Information	127
Mod Statement of Line	128
Mod Laminate Grain Direction	129
Mod Typical.....	130-132
Mod Bundles Typical.....	133-135
Mod Laminate Modular Components.....	136-137
Mod Laminate Modular Storage Components.....	138-140
Mod Laminate and Metal Desk Modular Components.....	141
Mod Laminate Modular Storage Components.....	142
Mod Conference Table Modular Components.....	143
Mod Reception Modular Components.....	144
Valido™	145
Valido™ Ordering Information	146-147
Valido™ Typical.....	148-150
Valido™ Laminate Modular Desks.....	151
Valido™ Modular Credenzas.....	152
Valido™ Modular Returns.....	153
Valido™ Laminate Modular Components.....	154-155
Valido™ Laminate Wood Desks — Full Pedestals.....	156-157
Valido™ Laminate Wood Desks — 3/4 Pedestals.....	158-159
Valido™ Shared Components & Accessories.....	160-171
Voi™	172
Voi™ Ordering Information	173
Voi™ Statement of Line	173.1-173.2
Voi™ Laminate Typical.....	174-179
Voi™ Bundles Typical.....	180-182
Voi™ Specifying/Design Guide	183-187
Voi™ Laminate Worksurfaces — Rectangle.....	188-190
Voi™ Worksurface Supports.....	191-193
Voi™ Standing-Height Worksurface Supports.....	194
Voi™ Standing-Height Laminate Support.....	195
Voi™ — Coordinate™ Sit-to-Stand Worksurfaces.....	196
Voi™ Height Adjustable Bases.....	197
Voi™ Laminate Support/Support Pedestals.....	198
Voi™ Laminate Support/Support Storage.....	199
Voi™ Modesty Panels.....	200

Voi™ Laminate Overhead Storage.....	205
Voi™ Laminate Overhead and Stack-on Storage.....	206
Voi™ Laminate Shared Overhead Storage Components.....	207
Voi™ Overhead Storage Supports/Accessories.....	208
Voi™ Laminate Stack-on Storage — Built-up.....	209
Voi™ Laminate Low Credenzas.....	210-211
Voi™ Laminate Low Footed Credenzas.....	212-213
Voi™ Laminate Credenzas.....	214
Voi™ Laminate Mobile Storage.....	215
Voi™ Laminate Storage.....	216
Voi™ Laminate Storage Cubes.....	217
Voi™ Laminate Storage Cube Bundles.....	218
Voi™ Laminate Storage Towers.....	219-221
Voi™ Laminate Storage.....	222
Voi™ Laminate Bookcases.....	223
Workwall	225
Workwall Ordering Information	226
Workwall Statement of Line	227
Workwall Specifying/Design Guide	228-232
Workwall Typical.....	233-235
Workwall Fabric Tiles.....	236-237
Workwall Glass Markerboard Tiles.....	238
Workwall Laminate Tiles.....	239
Workwall Laminate Media Tiles.....	240
Workwall Painted Metal Tiles.....	241
Workwall Slotted Tool Tiles.....	242
Workwall Accessories.....	243-244
10500 Series™	246
10500 Series™ Ordering Information	247-249
10500 Series™ Statement of Line	249.1-249.2
10500 Series™ Typical.....	250-252
10500 Series™ Bundles Typical.....	253-255
10500 Series™ Laminate Modular Components.....	256-260
10500 Series™ Worksurfaces.....	261
10500 Series™ Worksurface Supports.....	262-266
10500 Series™ Components — Supports.....	267
10500 Series™ Height Adjustable Bases.....	268
10500 Series™ Shared Components.....	270
10500 Series™ Laminate Modular Components.....	271-273
10500 Series™ Laminate Wood Desks — Full Pedestals.....	274-277
10500 Series™ Laminate Wood Desks — 3/4 Pedestals.....	278-279
10500 Series™ Shared Components & Accessories.....	280-290
10500 Series™ Storage.....	291
10500 Series™ Shared Components & Accessories.....	292-300
10500 Series™ Laminate Occasional Tables.....	301
10500 Series™ Shared Components & Accessories.....	302
94000 Series™	329
94000 Series™ Typical.....	330-331
94000 Series™ Laminate Wood Desks.....	332-337
Metro Classic	338
Metro Classic Ordering Information	339
Metro Classic Steel Desks.....	340-341

For information regarding HON registered and unregistered trademarks, please go to hon.com/protected-marks. Haworth®, Herman Miller®, Knoll®, and Steelcase® are registered trademarks of their respective owners and use of the marks do not imply affiliation or endorsement of The HON Company or its products.

LIST PRICER

Effective Date: March 2023

- All illustrations and specifications in this publication are based on the latest product information available at the time of print. For the most recent version, please go to www.hon.com.
- Software support packages furnished to the customer, either by The HON Company or by another source, which support the sale of HON products are superseded by printed price lists.
- All dimensions shown in this publication are nominal.
- Pricing is subject to change without notice.

- All orders are subject to prices in effect at the time of order.
- Ordering information appears at the beginning of a section complete with examples on how to specify. These specifying information pages are referenced at the bottom center of product pages.
- HON Full Lifetime Warranty applies unless otherwise noted.
- HON nationwide customer service:
Phone: (800) 833-3964

HON LIST PRICER

Table of Contents

34000 Series	342	Accelerate® Tackable Raceway Panels.....	422	Gallery Panels Accessories.....	498
34000 Series Ordering Information	343	Accelerate® Top-Tier Glass Panels.....	423	Gallery Panels Tackboards and Markerboards.....	499
34000 Series Steel Desks.....	344	Accelerate® Panel Door.....	424	Gravitation™ Power Beam	500
38000 Series™	345	Accelerate® Top Caps.....	425	Gravitation™ Power Beam Ordering Information	501-502
38000 Series™ Ordering Information	346	Accelerate® Stacking Panels.....	426-427	Gravitation™ 48"™ W Bundles.....	503
38000 Series™ Typical — 3/4 Height Pedestals.....	347	Accelerate® Frameless Glass.....	428	Gravitation™ 60"™ W Bundles.....	504
38000 Series™ Typical — Modular.....	348	Accelerate® Strengthened Connection Posts.....	429	Gravitation™ 72"™ W Bundles.....	505
38000 Series™ Bundles Typical.....	349-350	Accelerate® Strengthened Connections — Connector Straps.....	430	Gravitation™ Power Beam.....	506-508
38000 Series™ Steel Desks — 3/4 Pedestals.....	351	Accelerate® Variable Height Finished End and Wall Starter Kits.....	431	Gravitation™ Power Beam Electrical.....	509
38000 Series™ Modular Desks.....	352	Accelerate® Bracket Kits and Stability Feet.....	432	Gravitation™ Power Beam Screens.....	510-512
38000 Series™ Components.....	353	Empower®	434	Systems Shared Components	513
38000 Series™ Steel Stack-on Units.....	354-355	Empower® Finish Options	435	Systems Overhead and Shelves Specifying	514-515
38000 Series™ Accessories.....	356	Empower® Fabric Screens — All Panel Models	436-437	Abound® Electrical and Data.....	516-518
WORKSTATIONS		Empower® Step-by-Step Guide	438	Accelerate® Electrical and Data.....	519-520
Abode™	357	Universal Screens Specification Guide	438.1-438.2	Systems Electrical and Data.....	521
Abode™ Ordering Information	358	Empower® Electrical Specifying Information	439-442	Systems Electrical Specifying Information	522-524
Abode™.....	359-360	Empower® 60"™ W Typical with 24"™ D Worksurfaces.....	443	Working with Cable Management.....	525
Abode™ Typical.....	361-365	Empower® 120° Workstation Typical.....	444	Systems Working with Worksurfaces and Supports.....	526-528
Abode™ Components.....	366-369	Empower® 60"™ W Height Adjustable Typical with 24"™ D Worksurfaces.....	445	Systems Overhead and Shelves.....	529
Abound®	370	Empower® Bundles.....	446-447	Systems ETA Overheads and Shelves.....	530
Abound® Ordering Information	371	Empower® Legs for Linear Applications.....	448	Systems Overhead Storage.....	531
Abound® Fabric Patterns & Codes	372-373	Empower® Legs for 120° Applications.....	449	Systems Overhead Accessories.....	532-533
Abound® Typical.....	373-375	Empower® Support Beams.....	450	Systems Electrical Components.....	534-539
Abound® Open Base Typical.....	376	Empower® Wire Troughs.....	451	Systems Electrical and Data.....	540
Abound® Frames Overview.....	377-380	Empower® Return Components.....	452	Systems Worksurfaces — Primary.....	541-542
Abound® Connector Overview.....	381	Empower® Systems Worksurfaces.....	453	Systems Worksurfaces — Wedge.....	543
Abound® Tile Overview.....	382	Systems Worksurfaces — 120 Degree Corner.....	454	Systems Worksurfaces — Corner.....	544-545
Abound® Specifying/Design Guide	383-384	Empower® Height Adjustable Bases.....	455	Systems Worksurfaces — 120 Degree Corner.....	546
Abound® Working with Tiles	385	Empower® Height Adjustable Worksurfaces.....	456	Systems Worksurfaces — Corner Cove.....	547-548
Abound® Systems Electrical and Data.....	386	Lateral Organizer Screens.....	457	Systems Worksurfaces — Jetty / Peninsula.....	549
Abound® Panel Frames.....	387-388	Empower® Shared Screens.....	459-460	Systems Worksurfaces — Half-Round / Quarter Round / 60° Wedge.....	550
Abound® Open Base Panel Frames.....	389	Empower® Modesty Panels/End of Run Screens.....	462	Systems Countertops — Straight and Corner.....	551-552
Abound® Stacking Panel Frames.....	390	Empower® Electrical and Data.....	463-464	Systems Shelves — Corner Shelves.....	553
Abound® Stiffener Supports.....	391	Empower® Electrical Accessories.....	465	Systems Worksurface Supports.....	554-556
Abound® Panel Door.....	392	Gallery Panels	466	Worksurface Brackets.....	557
Abound® Sliding Door.....	393	Gallery Panels Ordering Information	467	Systems Worksurface Supports.....	558
Abound® Connectors.....	394-395	Gallery Panels Statement of Line	468	Standing-Height Worksurface Supports.....	559
Abound® Variable Height Finished End and Wall Starter Kits.....	396	Gallery Panels Overview.....	469-470	Systems Standard Height Support Pedestals.....	560
Wall Hanger Bars and Off-Module Bracket.....	397	Gallery Panels Working with Abound®.....	471	Systems Accessories — Paper Management / Markerboards.....	561
Abound® Tackable Acoustical Tiles.....	398-399	Gallery Panels Working with Accelerate®.....	472	Versé®	562
Abound® Power/Data Fabric Tiles.....	400-401	Gallery Panels Overview.....	473-475	Versé® Panel System.....	563-566
Abound® Hard-surface Tiles.....	402	Gallery Panels Working with Accessories.....	476-478	STORAGE	
Abound® Clear Glass Tiles.....	403	Gallery Panels Wing Panels.....	479-480	Overview of Personal Storage and Pedestals	567
Abound® Frosted Glass Tiles.....	404	Gallery Panels Split Panels.....	481	HON Lateral Files at a Glance.....	568
Abound® Frameless Glass.....	405	Gallery Panels Wing, Accepts Glass.....	482-483	HON Vertical Files at a Glance.....	569
Abound® Pass-thru Tiles.....	406	Gallery Panels Split Panels, Accepts Glass.....	484	Storage and Files Ordering Information	570
Abound® Slotted Tool Tiles.....	407	Gallery Panels Gallery-to-Gallery Connections.....	485-492	Brigade®	571
Systems Paper Management Support Bar.....	407	Gallery Panels Abound® Frameless Glass.....	493	Brigade® Ordering Information	572
Abound® Markerboard Tiles.....	408	Gallery Panels Accelerate® Frameless Glass.....	494	Brigade® Standard Height Pedestals.....	573
Abound® Painted Metal Tiles.....	409	Gallery Panels Abound® Connector Kits.....	495	Brigade® 800 Series Lateral Files w/Drawers.....	574
Abound® Custom Material Bracket Kit.....	410	Gallery Panels Accelerate® Connector Kits.....	496	Brigade® 800 Series Lateral Files w/Storage.....	575
Accelerate®	412	Gallery Panels Height Adjustable Tie-In Brackets.....	497	Brigade® 700 Series Lateral Files w/Drawers.....	576
Accelerate® Ordering Information	413			Brigade® 700 Series Lateral Files w/Storage.....	577
Accelerate® Fabric Patterns & Codes	414-415				
Accelerate® Typical.....	416-417				
Accelerate® Panels Overview.....	418-419				
Accelerate® Working with Panels.....	420				
Accelerate® Connector Overview.....	421				

For information regarding HON registered and unregistered trademarks, please go to hon.com/protected-marks. Haworth®, Herman Miller®, Knoll®, and Steelcase® are registered trademarks of their respective owners and use of the marks do not imply affiliation or endorsement of The HON Company or its products.

LIST PRICER

Effective Date: March 2023

- All illustrations and specifications in this publication are based on the latest product information available at the time of print. For the most recent version, please go to www.hon.com.
- Software support packages furnished to the customer, either by The HON Company or by another source, which support the sale of HON products are superseded by printed price lists.
- All dimensions shown in this publication are nominal.
- Pricing is subject to change without notice.
- All orders are subject to prices in effect at the time of order.
- Ordering information appears at the beginning of a section complete with examples on how to specify. These specifying information pages are referenced at the bottom center of product pages.
- HON Full Lifetime Warranty applies unless otherwise noted.
- HON nationwide customer service:
Phone: (800) 833-3964

HON LIST PRICER

Table of Contents

Brigade® 600 Series Lateral Files w/Drawers.....	578	Contain® eLock Accessories.....	618	510 Series Vertical Files — 25”D.....	666
Brigade® Metal Dividers.....	579	Contain® Metal Pedestals.....	619	Lateral File Accessories.....	667
Brigade® Steel Bookcases.....	580	Contain® Footed Metal Pedestals.....	620	Vertical File Accessories.....	668
Brigade® Storage Cabinets.....	581	Contain® Pedestal Accessories.....	621	Mobile Pedestals.....	669
Contain®	582	Contain® Metal Pedestals with Laminate Fronts.....	622	Pedestal Accessories.....	670-671
Contain® Ordering Information	583-583.1	Contain® Footed Metal Pedestals with Laminate Fronts.....	623	Laminate Bookcases	672
Contain® Towers.....	584	Contain® Pedestal Accessories.....	624	Bookcases Ordering Information	673
Contain® Lockers & Wardrobes.....	585	Flagship®	625	1870 Series Laminate Bookcases.....	674
Contain® Metal Storage	586	Flagship® Ordering Information	626		
Contain® Digital Lock Specifications.....	587-588	Flagship® Hanging and Standard Height Pedestals.....	627	UNIVERSAL SCREENS	
Contain® Metal Credenzas.....	589	Flagship® Mobile Pedestals.....	628	Acoustic Solutions by unika vaev	675
Contain® Footed Metal Credenzas.....	590	Flagship® 18” Deep Lateral Files with Drawers.....	629	Acoustic Solutions Ordering Information	676-677
Contain® Metal Credenzas with Laminate Fronts.....	591	Flagship® Lateral File with Storage.....	630	Acoustic Solutions Wall.....	678
Contain® Footed Metal Credenzas with Laminate Fronts.....	592	Flagship® Modular Storage.....	631	Acoustic Solutions Ceiling Tiles and Screens.....	679
Contain® Metal Credenzas.....	592.1	Flagship® Bookcases.....	632	Acoustic Solutions Floor Screens.....	680-681
Contain® Footed Metal Credenzas.....	592.2-592.3	Flagship® Storage Cabinets.....	633	Universal Screens	682
Contain® Metal Credenzas.....	592.4-592.5	FlameSafe™ Ordering Information	634	Universal Screens Ordering Information	683
Contain® Footed Metal Credenzas with Laminate Fronts.....	592.6	FlameSafe™ Fire-Resistant Files.....	635	Universal Screens Statement of Line	684
Contain® Metal Credenzas.....	592.7	Fuse™	636	Universal Screens Specification Guide	685-687
Contain® Footed Metal Credenzas with Laminate Fronts.....	592.8	Fuse™ Ordering Information	637	Universal Screens Fabric Screens.....	688-691
Contain® Personal Files.....	593	Fuse™ Pedestals.....	638	Universal Screens Glass Screens.....	692-693
Contain® Lateral Files.....	594	Fuse™ Digital Lock Specifications.....	639	Universal Screens Acrylic Screens.....	694-696
Contain® Lateral File Accessories.....	595	Fuse™ Mobile Pedestals.....	640	Universal Screens Laminate Screens.....	697
Contain® Metal Credenzas Accessories.....	596-597	Fuse™ Mobile Pedestals with eLock.....	641	Universal Screens Metal Screens.....	698
Contain® Metal Personal Towers.....	598	Fuse™ Freestanding Pedestals.....	642		
Contain® Metal Side Access Towers.....	599	Fuse™ Freestanding Pedestals with eLock.....	643	ACCESSORIES	
Contain® Metal Personal Towers with Laminate Fronts.....	600	Fuse™ Pedestal Cushion.....	644	Core Removable Lock Kits.....	699
Contain® Metal Side Access Towers with Laminate Fronts.....	601	Fuse™ Undermount Storage.....	645	Touch-up Paint.....	700
Contain® Footed Metal Personal Towers.....	602	Fuse™ Workplace Tools.....	646		
Contain® Footed Metal Side Access Towers.....	603	Storage Islands	647	WORKPLACE TOOLS	
Contain® Footed Metal Personal Towers with Laminate Fronts.....	604	Storage Islands Ordering Information	648	Workplace Tools	701
Contain® Footed Metal Side Access Towers with Laminate Fronts.....	605	Storage Islands Specifying Guide	649-651	Workplace Tools Ordering Information	702
Contain® 18”W Slim Metal Personal Towers.....	606-607	Storage Islands Planning Typicals.....	652-653	Monitor Arms.....	703-704
Contain® 18”W Slim Personal Towers with Laminate Fronts.....	608-609	Storage Islands Top Only Applications.....	654	CPU Holders.....	705
Contain® Wardrobes.....	610	Storage Islands Tops for Use with 2 End Panels.....	655	Keyboard Trays.....	706-707
Contain® Wardrobes with eLock.....	611	Storage Islands Tops for Use with 2 End Panels and Back/Septum.....	656	Corner Sleeves.....	708
Contain® Wardrobes.....	612	Storage Islands — Island Tops for Use with 1 End Panel and Septum.....	657	Center Drawers.....	709-710
Contain® Wardrobes with eLock.....	613	Storage Islands — Islands Septum/Back and End Panels.....	658	Desktop Riser.....	711
Contain® Metal Lockers.....	614	Storage Islands Peninsula Supports.....	659	Chair Mats.....	712
Contain® Metal Lockers with Laminate Fronts.....	615	400 Series	660	Task Lights.....	713-714
Contain® Metal Lockers with eLock.....	616	400 Series Lateral Files.....	661	Paper Management & Organizational Tools.....	715-718
Contain® Metal Lockers with Laminate Fronts and eLock.....	617	Vertical Files	662	Interlink IQ Electrical.....	719-720
		Vertical Files Ordering Information	663	4-Trac Hardwire Electrical System.....	721-722
		210 Series Vertical Files — 28½”D.....	664	Power & Cable Management.....	723
		310 Series Vertical Files — 26½”D.....	665	Power.....	724-726
				Power & Cable Management.....	727
				INDEX	
				Cross Reference Index.....	728-747
				Information on Ordering Parts.....	752

For information regarding HON registered and unregistered trademarks, please go to hon.com/protected-marks. Haworth®, Herman Miller®, Knoll®, and Steelcase® are registered trademarks of their respective owners and use of the marks do not imply affiliation or endorsement of The HON Company or its products.

ADDITIONS

NEW ADDITIONS: PRODUCTS

Fabrics and Finishes	Effective Date	Fabrics and Finishes	Effective Date
<i>Fabrics continued</i>		<i>Fabrics continued</i>	
Livi with Supreen™	January 1, 2023	Oxford with Supreen™	January 1, 2023
Asphalt (LIVI01)		Armor (OXFD01)	
Atlantis (LIVI02)		Azurite (OXFD02)	
Bouquet (LIVI03)		Cadet (OXFD03)	
Branch (LIVI04)		Cider (OXFD04)	
Coastal (LIVI05)		Clover (OXFD05)	
Cowboy (LIVI06)		Coal (OXFD16)	
Dawn (LIVI07)		Coin (OXFD06)	
Earth (LIVI09)		Crema (OXFD07)	
Evergreen (LIVI10)		Currant (OXFD08)	
Fennel (LIVI11)		Deluge (OXFD09)	
Fog (LIVI12)		Dewberry (OXFD10)	
Honeycomb (LIVI13)		Falcon (OXFD11)	
Jade (LIVI14)		Gingerbread (OXFD12)	
Limestone (LIVI15)		Laurel (OXFD13)	
Monochrome (LIVI16)		Odyssey (OXFD14)	
Night (LIVI17)		Pavement (OXFD15)	
Overcast (LIVI18)		Redvine (OXFD17)	
Pebble (LIVI19)		Seadrift (OXFD18)	
Pillow (LIVI08)		Shoji (OXFD19)	
Plum (LIVI20)		Tourmaline (OXFD20)	
Pumpkin (LIVI21)		Vignette (OXFD21)	
Rhubarb (LIVI22)		Vast	January 1, 2023
Saxon (LIVI23)		Atmosphere (VST06)	
Seaside (LIVI24)		Bay (VST04)	
Twine (LIVI25)		Beach (VST11)	
Noble	January 1, 2023	Country Side (VST13)	
Aegean (NBLE18)		Desert (VST12)	
Amethyst (NBLE19)		Garden (VST02)	
Aspen (NBLE14)		Grasslands (VST03)	
Aster (NBLE20)		Highway (VST09)	
Blossom (NBLE21)		Mountain Range (VST08)	
Bluebell (NBLE22)		Ocean (VST07)	
Bordeaux (NBLE01)		Open Air (VST05)	
Brick (NBLE02)		Tundra (VST10)	
Chambray (NBLE10)		Vineyard (VST01)	
Chamomile (NBLE23)		Wavelength	January 1, 2023
Clementine (NBLE04)		Base (WVL21)	
Conifer (NBLE24)		Crest (WVL14)	
Cottage (NBLE25)		Cycle (WVL20)	
Darkness (NBLE26)		Energy (WVL03)	
Dawn (NBLE13)		Frequency (WVL04)	
Denim (NBLE09)		Infrared (WVL01)	
Desert Sand (NBLE27)		Motion (WVL13)	
Dewfall (NBLE28)		Movement (WVL05)	
Dusted Sage (NBLE29)		Peak (WVL11)	
Flax (NBLE30)		Pressure (WVL06)	
Grass (NBLE07)		Shallow (WVL02)	
Gunmetal (NBLE15)		Still (WVL07)	
Harmony (NBLE31)		Surface (WVL18)	
Harvest (NBLE12)		Surge (WVL10)	
Ice Caves (NBLE32)		Swell (WVL08)	
Icicle (NBLE33)		Tide (WVL16)	
Inky (NBLE34)		Transition (WVL15)	
Iris (NBLE35)		Trough (WVL19)	
Jade (NBLE06)		Tsunami (WVL09)	
Knight (NBLE17)		Ultraviolet (WVL12)	
Mesa (NBLE03)		White Caps (WVL17)	
Monarch (NBLE36)		Laminates	
Pacific (NBLE08)		Beigewood (LWBE)	October 1, 2022
Pitch (NBLE37)		Fawn Cypress (LFC1)	October 1, 2022
Queen Bee (NBLE38)		Field Elm (LWFE)	October 1, 2022
Rainforest (NBLE05)			
Regal (NBLE11)			
Sandcastle (NBLE39)			
Sedona (NBLE40)			
Stormy (NBLE16)			
Sunbeam (NBLE41)			
Voyager (NBLE42)			
Windy Day (NBLE43)			

DISCONTINUATIONS

Desks	Effective Date	Storage	Effective Date
Coordinate™ Models: HHABETAMEM, HHABETA2S2L, HHATW2246EA, HHATW2252EA, HHATW2258EA, HHATW2846EA, HHATW2852EA, HHATW2858EA, HHATW2448EA, HHATW2454EA, HHATW2460EA, HHATW3048EA, HHATW3054EA, HHATW3060EA, HFTPLD	June 30, 2023	FlameSafe™ Models: H34, H54, H54C, H52, H32	December 31, 2023
Voi® Models: HLSL3014L, HLSL3614L, HLSL4214L, HLSL4814L, HLSL5414L, HLSL6014L, HLSL3014MM, HLSL3614MM, HLSL4214MM, HLSL4814MM, HLSL5414MM, HLSL6014MM, HLSL2830, HLSL2836, HLSL2842, HLSL2848, HLSL2854, HLSL2860, HLSL1230, HLSL1236, HLSL1242, HLSL1248, HLSL1254, HLSL1260, HLSL2020TS, HLSL2024TS, HLSL2030TS, HLSL2036TS, HLSL1220TS, HLSL1224TS, HLSL1230TS, HLSL1236TS, HLSL1220FS, HLSL1224FS, HLSL1230FS, HLSL1236FS, HLSL1220GS, HLSL1224GS, HLSL1230GS, HLSL1236GS	June 30, 2023	Fabrics and Finishes	Effective Date
10500 Series™ Model: HLAMSHB30	April 1, 2023	Fabrics	
10700 Series™ Models: H10762, H107690, H107697, H107698, H107699, H1077292, H10730, H107313, H107318, H107318K, H10732, H10732K, H10733, H10733K, H10734, H10734G, H10734K, H107353, H107358, H10736, H10737, H10738, H107720, H107721R, H107722L, HC10734, H107290, H107291, H107293, H107295R, H107296L, H107299, H107301R, H107302L, H10752, H10753, H10754, H10755, H107569, HC10753, H107270X, H107725R, H107726L, H107727R, H107727RX, H107728L, H107728LX, H107801R, H107801RX, H107802L, H107802LX, H107803R, H107803RX, H107804L, H107804LX, H107805R, H107805RX, H107806L, H107806LX, H107807R, H107807RX, H107808L, H107808LX, H107815, H107815X, H107816, H107816X, H107817, H107817X, H107824, H107825, H107825X, H107826, H107827, H107829, H107835, H107836, H107837, H10701R, H10702L, H10705R, H10706L, H10707R, H10708L, H10709R, H10710L, H10711R, H10712L, H107191R, H107192L, H10741, H10742, H10751, H10767, H10768, H107725N, H10773, H10774, H10787R, H10787RG, H10788L, H10788LG, H10799, H10799G, H107U72108C, H10715R, H10716L, H10717R, H10718L, H107193R, H107194L, H10721, H10721E, H10721X, H10722, H10722E, H10722X, H10724, H107242, H10726, H107398, H107399, H10743, H10744, H10745R, H10746L, H10747R, H10748L, H107492, H10760, H10763R, H10764L, H10765, H10766, H10770, H10771, H10775, H107811, H10783R, H10784L, H10785R, H10786L, H107885R, H10791, H107LL7284N, H107LLH7284N, H107LR7284N, H107LRH7284N, H107UL72108N, H107ULH72108N, H107UR72108N, H107URH72108N, HC10715R, HC10716L, HC10743, HC10745R, HC10770, HC10771, HC10783R, HC10784L, HC10785R, HC10786L, HC10791, H10772108C, H10772108N, H107UL72108N2, H107UR72108C, H107UR72108N2, H1526	June 30, 2023	Analog Album (ANLG06) Cartridge (ANLG04) Cassette (ANLG09) Dial (ANLG02) Media (ANLG08) Reel (ANLG07) Signal (ANLG03) Stereo (ANLG01) Track (ANLG05) Whisper Vinyl Brick Red (WP99) Carotene (WP97) Cucumber (WP88) Forest (WP82) Gravel (WP19) Merlot (WP27) Ochre (WP96) Putty (WP84) Sangre (WP28) Zest (WP87)	December 31, 2023
94000 Series™ Models: H90033, H90032, H90031, H94223, H94229, H94234, H94234K, H94235, H94236, H94237, H94237K, H94720, H94721R, H94722L, H94210, H94220, H94221, H94222, H94224, H94225, H94291, H94430, H94435, H94211R, H94212L, H94215R, H94216L, H94226, H94243, H94244, H94245R, H94246L, H94247R, H94248L, H94251, H94260, H94270, H94271, H94276, H94283R, H94284L, H94285R, H94286L, H94011	December 31, 2023	Laminate Russet Cherry (LRC1) Paint Amethyst (P091) Cobalt Mica (P090)	June 30, 2023 December 31, 2023
Workstations	Effective Date	Electrical and Data	Effective Date
Empower® Models: HMPDFS2413, HMPDFS2420, HMPDFS3013, HMPDFS3020, HMPDMS2413, HMPDMS3013, HMPFSS4220, HMPFSS4820, HMPFSS5420, HMPFSS6020, HMPFG2413, HMPFG3013, HMPFG3613, HMPFG4213, HMPFG4813, HMPFG6013, HMPFG7213, HMPFG2420, HMPFG3020, HMPFG3620, HMPFG4220, HMPFG4820, HMPFG6020, HMPFG7220, HMPFGS3613, HMPFGS4213, HMPFGS4813, HMPFGS5413, HMPFGS6013, HMPFGS7213, HMPFGS3620, HMPFGS4220, HMPFGS4820, HMPFGS5420, HMPFGS6020, HMPFGS7220, HMPLM3613, HMPLM4813, HMPLM6013	June 30, 2023	Systems Models: HH871400, HH871400A, HH871500, HHCMT24, HHCMT36	December 31, 2023
Gravitation™ Models: HUVDSBS2048, HUVDSBS2060, HUVDSBS2072	June 30, 2023		
Systems Worksurfaces Models: HWC4224SP, HWC4824SP, HWC4230SP, HWC4830SP, HWC3624SP, HWC54224SP, HWC54824SP, HWC54230SP, HWC54830SP, HWV73AALSP, HWV73AARSP, HWV73BALSP, HWV73BARSP, HWV75AALSP, HWV75ABLSP, HWV75BALSP, HWV75BBLSP, HWV75AARSP, HWV75ABRSP, HWV75BARSP, HWV75BBRSP, HWV93AALSP, HWV93AARSP, HWV93BALSP, HWV93BARSP, HWV95AALSP, HWV95ABLSP, HWV95BALSP, HWV95BBLSP, HWV95AARSP, HWV95ABRSP, HWV95BARSP, HWV95BBRSP	June 30, 2023		

NOTES

HON FULL LIFETIME WARRANTY INFORMATION



FULL LIFETIME WARRANTY

YOUR HON FULL LIFETIME WARRANTY

Every time you purchase a HON product, you're making an investment in your future. We're proud to play a part in that future, and you can trust us to do our best for as long as you need us.

The HON Full Lifetime Warranty is our assurance to you that the HON desks, workstations, seating, tables, or storage you purchase will be free from defective material or workmanship for the life of the product.

In the unlikely event that any HON product or component covered by the HON Full Lifetime Warranty should fail under normal workplace use as a result of defective material or workmanship, HON shall repair or replace with comparable product (at HON's discretion), free of charge.

WHAT'S COVERED BY THE HON FULL LIFETIME WARRANTY?

Your HON Full Lifetime Warranty applies to product manufactured after January 1, 2011. All HON product lines, materials, and components are covered by the HON Full Lifetime Warranty except for the items described below.

The specific product lines, materials, and components listed below are covered under HON's Full 12-Year, Full 10-Year, and Full 5-Year Warranties (from date of purchase).

HON'S FULL 12-YEAR WARRANTY

- Electrical components (lamps and ballasts are not covered)
- 4-Way Stretch Mesh
- Seating controls
- Pneumatic Cylinders
- Wood Seating
- Accessories
- Laminate Surfaces

HON'S FULL 10-YEAR WARRANTY

- Coordinate™ Height Adjustable Bases (HHATB)

HON'S FULL 7-YEAR WARRANTY

- Coordinate™ Legacy Bases (HHAB and HREC)
- Workwall Markerboard Glass Tiles

HON'S FULL 5-YEAR WARRANTY

- All LED task lights
- Panel and seating textiles
- Coze™
- Between™ Multi-Purpose Table
- Acoustic Solutions by Unika Vaev
- Mod

HON'S FULL 1-YEAR WARRANTY

- Acrylic Screens

These warranties apply to HON products sold within the United States of America, U.S. Territories, and Canada, as well as U.S. Military and Federal Agency purchases (regardless of location).

IS ANYTHING NOT COVERED?

There are a few exclusions to the HON Full Lifetime Warranty and to the 12-, 10-, and 5-year warranties. These exclusions are:

- All HON products that are covered under a separate 5-year warranty.
- Color-fastness or matching of colors, woodgrains, or textures occurring in wood, leather, or other materials that naturally exhibit inherent color variations.
- Customer's own materials (COM) selected by and used at the request of the user.
- Modifications or attachments to the product that are not approved by The HON Company and product failures resulting from such modifications or attachments.
- Product normal wear and tear, which are to be expected over the course of ownership.
- Products that were not installed, used, or maintained in accordance with product instructions and warnings.
- Products used for rental purposes.
- Damage caused by cleaning chemicals.
- Dye transfer caused by external contaminants (including clothing and accessory dyes such as those used on denim jeans) may migrate to lighter colors. This phenomenon is increased by humidity and temperature and is irreversible.
- Fabric pattern match seat to back or chair to chair. If pattern match is needed, please submit a Tailored Solutions request or contact HON Customer Support/Tailored Solutions with questions.
- Storage Digilocks come with a 2-year warranty.

WARRANTY REQUESTS OR QUESTIONS?

Your HON Dealer is our mutual partner in supporting your warranty requests. To obtain service under this warranty, please contact your HON dealer. If you are not sure who your dealer is, please call HON Customer Support at 800.833.3964.

THAT'S YOUR HON FULL LIFETIME WARRANTY AS AN OWNER OF HON PRODUCT, THE WARRANTY EXPLAINED HERE IS YOUR SOLE AND EXCLUSIVE REMEDY. THERE ARE SOME EXCEPTIONS IF YOU PURCHASED THE PRODUCT FOR HOME OR PERSONAL USE WHICH ARE EXPLAINED BELOW. TO THE EXTENT ALLOWED BY LAW, THE HON COMPANY MAKES NO OTHER WARRANTY, EITHER EXPRESS OR IMPLIED, INCLUDING ANY WARRANTY OF MERCHANTABILITY OR FITNESS FOR A PARTICULAR PURPOSE. THE HON COMPANY WILL NOT BE LIABLE FOR ANY CONSEQUENTIAL OR INCIDENTAL DAMAGES.

A WORD ABOUT PURCHASES FOR HOME OR PERSONAL USE

Please note, this section only applies if you purchased your HON product for your home or for your own personal or family use. HON's warranties give you specific legal rights and you may have other rights, which vary from state to state. As a consumer purchaser, the complete exclusion of implied warranties noted in the above paragraph does not apply to you, however, to the extent allowed by applicable state law, the implied warranties are limited to the applicable term of the warranty. Some states do not allow the exclusion or limitation of incidental or consequential damages, so the above exclusion or limitation may not apply to you.

HON LIMITED 5-YEAR WARRANTY INFORMATION



LIMITED 5-YEAR WARRANTY

The HON Company promises to repair or replace HON products or components covered under this warranty that are found to be defective in material or workmanship within five (5) years from the date of original purchase so long as you, the original purchaser, still owns it. This is your sole and exclusive remedy. This warranty is subject to the provisions below. It applies to the products listed here manufactured after January 1, 2018.

LIMITATIONS:

- Upholstery on chairs is warranted for two years from date of purchase.
- Damage caused by the carrier in-transit is handled under separate terms.

EXCLUSIONS:

This warranty does not apply and no other warranty applies to:

- Normal wear and tear, which are to be expected over the course of ownership.
- Modifications or attachments to the product that are not approved by The HON Company.
- Products that were not installed, used or maintained in accordance with product instructions and warnings.
- Products used for rental purposes.

SEATING USAGE

Normal commercial use for seating is identified as the equivalent of a single shift, forty-(40) hour workweek. To the extent that a seating product is used in a manner exceeding this, the applicable warranty period will be reduced in a pro-rata manner.

A WORD ABOUT COLOR VARIATIONS, FABRICS AND FINISHES:

The HON Company does not warrant the color-fastness or matching of colors, grains or textures of covering materials.

CUSTOMER'S OWN MATERIAL (COM)

Not available on HON products covered under the HON 5-year warranty.

TO THE EXTENT ALLOWED BY LAW, THE HON COMPANY MAKES NO OTHER WARRANTY, EITHER EXPRESS OR IMPLIED, INCLUDING ANY WARRANTY OF MERCHANTABILITY OR FITNESS FOR A PARTICULAR PURPOSE. THE HON COMPANY WILL NOT BE LIABLE FOR ANY CONSEQUENTIAL OR INCIDENTAL DAMAGES.

NOTICE TO PURCHASERS FOR HOME OR PERSONAL USE:

Federal law does not permit the exclusion of certain implied warranties for consumer products. Therefore, if you are purchasing this product for home or personal use, the exclusion of implied warranties noted in the above paragraph does not apply to you. Some states do not allow the exclusion or limitation of incidental or consequential damages, so the above limitation or exclusion may not apply to you. This warranty gives you specific legal rights, and you may also have other rights which vary from state to state.

This warranty applies only to products sold within the United States of America and the Commonwealth of Canada.

TO OBTAIN SERVICE UNDER THIS WARRANTY:

Your HON® Dealer is our mutual partner in supporting your warranty requests. By following the procedures outlined below, you can be assured of the best level of service. Please note: Consent of The HON Company must be obtained before any warranty work is performed. To obtain consent, please take the following steps:

1. Contact the Dealer from whom the product was purchased within 30 days of discovery of the defect. Be prepared to affirm that you are the original purchaser of the product and to provide the serial number(s) from the product in question.
2. Your Dealer will gather all pertinent information regarding the claim, inspect the product and contact a HON Company customer service representative. (Please allow a reasonable amount of time for inspection and review.)
3. If The HON Company affirms that the product in question is eligible under the conditions of the warranty as stated above, the customer service representative or another representative of the Company will determine whether to provide replacement parts, authorize repairs or replace the product.

ORDERING

Electronic ordering is the standard order process for HON. HON supports the following primary methods for the electronic transmission of orders and order related documents:

Electronic Ordering

Available in the HONReady portal at honready.hon.com. There are multiple options available for processing orders electronically.

Integration with the standard Office Furniture business systems or other pre-approved proprietary software packages.

SIF file upload using fully optioned SIF files into the electronic ordering applications.

Manual entry of line items into the electronic ordering application.

EDI-System to System Integration

With standard Office Product systems or other pre-approved proprietary software systems.

Training, technical set-up and support is available through our Dealer Operations Team at honready@honcompany.com.

ORDER REQUIREMENTS

- Customer must provide complete and correct information, including complete model number, finishes, colors, options, and quantity.
- If a bid quotation or other special pricing applies, such information must be clearly stated on the order with applicable bid number or contract number.
- Order Management contact name and phone number.
- Delivery Appointment contact name and phone number at the dealership or installation company. HON does not accept orders with end user appointment contacts.
- Dealer Sales Representative, primary or multiple DSRs.
- “Best Date Available” for the entire order is standard service for HON. If eligible, other Date Requests may be requested and must be submitted with the order. Other Date Requests are subject to review by HON prior to acceptance:
 - “Ship After” requests are eligible on all order sizes
 - “Deliver On” requests are eligible for full truckload orders
- Additional services outside of HON’s standard services may be available through HON’s ‘Enhanced Services’ for a corresponding fee. Requested services from ‘Enhanced Services’ must be provided at time of order placement.
- Failure to provide complete and accurate information results in delayed order entry and acknowledgment. Incomplete orders will not be produced and will be returned to Dealer for correction.

ACKNOWLEDGMENT SERVICE

- E-mailed acknowledgments are available by customer request.
- An acknowledgment will be emailed the morning of the next business day, unless order is placed on credit or other order hold.
- The order will not receive an acknowledged shipment date until all order holds are released.

ORDER CHANGES OR CANCELLATIONS

For Order Changes or Cancellations, please contact Customer Support at 800-833-3964.

TERMS AND CONDITIONS

See **HON NOW** on honready.hon.com for more information about HON NOW delivery, services and ordering information.

HON DESIGN SERVICES

HON INTEGRATED DESIGN SOLUTIONS

Need design assistance? We can help! Our expert design staff will create a professional design package that is sure to put you one step ahead of the competition. And the best part is – it's free!

AUDIT

We will check your drawing and parts list for accuracy. We verify quantity, specification accuracy, product compatibility and structural support.

DESIGN

We will provide a professional design package including a 2D furniture plan, renderings, and complete parts list based on the rough sketch and project information you supply.

CONSULTATION

A 1:1 meeting will be scheduled where we will provide guidance on product positioning, answer specification questions, and recommend value engineering opportunities.

CONTACT HON DESIGN SERVICES

Questions? Please reach out to your region's dedicated designer. Not sure how to reach your designer? Send us a note at the email below.

E-Mail: integrateddesign@honcompany.com



Solve® Chair shown with Coordinate™ Height Adjustable Table.

Project Space

A place for all HON Project Services

Project Space provides one platform to access the full portfolio of HON services including:

- Design
- Audit
- Product Modification
- Special Laminates
- Consultation
- Customer's Own Material
- Dual Fabric Applications
- Special Paints
- Project Bid Pricing

Submit your request on the Community powered by HNI, Projects.

Project Space Lead Time: Within 3 business days depending on complexity and size of your project.

TAILORED SOLUTIONS ORDERING INFORMATION

PRODUCT MODIFICATIONS

Modifications include structural and dimensional modifications to existing product and Dual Fabric Applications, when standard model is not available.

The HON Company, at its own discretion, may modify standard products to meet specific needs. Product specials can be requested on HON brand product only.

List prices contained in published list pricers are for standard catalog items only. Changes or alterations to catalog items other than those listed as catalog options are subject to additional charges. Pricing will only be furnished upon approval of the special request.

Requests to have the product produced in more than one fabric (e.g., fabric on the seat is different than the fabric on the back), are considered a Dual Fabric Applications request and follow the Product Modification request process within the Community.

SPECIAL LAMINATES

Special laminates include requests for laminates not available as part of The HON Company's standard offering. Requests for special laminates are subject to manufacturing approval and minimum order quantities. The HON Company approved special laminates will be subject to a designated upcharge per unit.

Requests for special laminates should be submitted through the Community. Pricing will only be furnished upon approval of the special request.

SPECIAL PAINTS

- The HON Company's paint matching equipment can match almost any color, excluding some metallic and whites.
- Special paint requests must be submitted on the Community.
- In order to request a paint sample, the customer must have a minimum order of 10 like product units. Any requests with less than that amount will not be processed.
 - For each new paint request, there will be a \$250 net charge. A sample of the exact color desired is required for matching and approval. The HON Company will match the color and provide a production sample for the customer to review and approve.

- Once written approval is received by The HON Company, the request will be approved.
- Each unique color or finish combination incurs a designated upcharge per color per order (all standard discounts/competitive project pricing applies).

Special note: Some special colors could fall outside of this program due to production costs or not meeting The HON Company's quality standards. The HON Company may apply additional charges to some colors which are costly to apply, and refuse some orders on colors that cannot meet The HON Company's high-quality standards. The HON Company will notify the customer upon completion of The HON Company's evaluation if a change in price is required or rejection of the order.

DISCONTINUED PRODUCT

Requests for discontinued product require engineering evaluation, safety review, and testing to current standards prior to approval. Many discontinued products are not available for order. Requests for discontinued products should be submitted through the Community.

LEAD TIMES FOR SPECIALS PRODUCT

Lead times on orders containing specials are subject to production capacity and material availability. When possible, the customer should order special products separately to avoid extended lead times for standard products. Extended lead times will be noted on Compass.

CHANGES TO SPECIALS PRODUCT

A special model will be provided for each approved special item to process orders. Once an order is placed, no changes or cancellations can be made to the order without approval from Tailored Solutions.

CONTACT TAILORED SOLUTIONS

Phone: 800.833.3964 and listen for Tailored Solutions offering on the menu.

Email: HONSpecials@honcompany.com

CUSTOMER'S OWN MATERIAL ORDERING INFORMATION

CUSTOMER'S OWN MATERIAL (COM) PROGRAM

Customer's Own Material (COM) is a request to use fabrics not available as part of HON's standard fabric offering. Manufacture to Supply (MTS) and Dealer to Supply (DTS) are the two ordering methods. The HON Company has partnered with fabric manufacturers to provide competitive pricing and selection through the MTS program. MTS will be the standard offering unless The HON Company is unable to procure the fabric. If there is a DTS request submitted, The HON Company will advise at the time of the request if DTS is available.

CUSTOMER WARRANTY EXCLUSION

The HON Company shall have no responsibility for the condition, quality, value, performance, physical properties, or any other aspects of the COM.

The HON Company shall have no liability for any damages, injuries, or losses to the customer or to any third party that shall be caused by any COM or product modification, and the customer shall hold The HON Company harmless for all liability.

The HON Company assumes no responsibility for the overall appearance, flammability, normal durability, colorfastness, or any other quality of the COM or product modification after its application on a HON product beyond normal quality standards. The HON Company reserves the right to reject a COM fabric if the quality of the COM is not satisfactory for the product. Should this occur, the customer will be notified with an explanation of the issue.

The HON Company is not responsible for fabric that has become obsolete at the COM supplier, that is of poor quality, or that is delivered late to The HON Company from the COM supplier. The HON Company is not responsible for excess yardage created by DTS orders or yardage not attached to an order and reserves the right to dispose of the excess fabric.

As a standard HON does not pattern match any standard, partnership or COM fabric, therefore pattern match is not applicable under warranty. If pattern match is needed please submit a Tailored Solutions request or contact HON Customer Support/Tailored Solutions once your COM has been approved.

COM TESTING

As a result of recent legal requirements, The HON Company will need to obtain specific information from the fabric supplier about treatments and chemicals used in the fabric. To the extent the supplier is unwilling or unable to provide the necessary information, which could extend the testing lead time of the request.

To check if a COM has been tested previously, utilize the COM Search Tool on the HON Ready Portal > Design Resources > Textiles & Finishes section using the following information:

- COM Supplier's Name
- Fabric Pattern Name
- Color Name
- If the COM fabric has been tested and previously approved, the COM will not need to be re-tested unless testing standards have changed, fabric is to be used on a different series, or direction of the fabric has changed from what was previously approved. Please note that Panel product must be approved for each model and color.
- If the pattern has previously been tested and approved, but not in the specific requested color, the customer will need to request an order code for that color only. No further testing will be necessary since the pattern has already been approved.

If the fabric has not previously been tested, the customer must enter the COM request on the HON Ready Portal > Textiles & Finishes > COM Search Tool.

Complete the Supplier Name, Pattern, and Color drop-down fields. For quicker results in these fields, type the first letter of the (supplier, pattern, color) name and, when done, click Add and then Submit. (Multiple series can be added to the same request if they are the same supplier, pattern, and color.)

An email will be sent to the requestor stating the COM Request was successfully submitted. Up to four emails could be received: submitted, in testing, testing materials requested, and final approval/denial with price grade and fabric code. The testing process takes approximately 48 hours.

COM yardage in the pricer is shown as pattern cut only.

COM TESTING — FLAMMABILITY TESTING INFORMATION

The customer is responsible for ensuring that the COM fabric is certified to meet all flame-retardant requirements. All COM seating fabric must, at minimum, meet CAL 117 requirements. If the customer requires the chair be tested to meet the fire safety standards of CAL 133, additional testing and information is required.

MTS COM

As previously mentioned, MTS is the primary COM method.

If the COM fabric has not been tested, a COM request must be submitted on the HON Ready Portal.

For MTS orders, The HON Company will procure fabric needed for production. Should The HON Company not be able to obtain fabric yardage, the customer will be contacted.

CUSTOMER'S OWN MATERIAL ORDERING INFORMATION

When testing has been completed, the customer will be notified by the COM team of the test results. If the COM is approved, The HON Company will provide a COM tracking order code for MTS. That tracking code is required on the order in place of the standard fabric code.

If approved, MTS product will be assigned an appropriate fabric grade for pricing. The pricing can be found on the HON Ready Portal > Design Resources > Textiles & Finishes. (All standard discounts/competitive project pricing applies).

Written COM price quotes are valid for 90 days after the issue date.

DTS COM

DTS COM is only available if the COM fabric cannot be procured by The HON Company. If the fabric can be procured by The HON Company, the customer will be contacted to switch to MTS or cancel the request.

If your fabric is not listed as approved, and it is not a Partnership fabric you may request a "Dealer to Supply" code. Select the "Request COM Test" link on the COM Search website. Complete the Supplier Name, Pattern, and Color drop-down fields. For quicker results in these fields, type the first letter of the (supplier, pattern, color) name and, when done, click Add and then Submit. (Multiple series can be added to the same request if they are the same supplier, pattern, and color.)

An email will be sent to the requestor stating the COM Request was successfully submitted. Up to four emails could be received: submitted, in testing, testing materials requested, and final approval/denial with price grade and fabric code. It's rare actual test yardage is required. Testing is mainly done by reviewing the attributes of the fabric. The testing process takes approximately 48 hours.

If the COM has not been tested, a COM request must be submitted on the HON Ready Portal > Design Resources > Textiles & Finishes.

When testing has been completed, the customer will be notified by the COM team of the test results. If the COM is approved, The HON Company will provide a COM tracking order code. That tracking code is required on the order in the place of the standard fabric code.

DTS product is priced at the following grades (all standard discounts/competitive project pricing applies):

- Chairs are a Grade 4
- Panel product is a Grade D

Written COM price quotes are valid for 90 days after the issue date.

COM LEAD TIME

Ship dates will be based on fabric receipt and The HON Company's standard lead time. All fabric must be properly tagged and shipped to the appropriate producing location (provided in the approval email).

- Specific to DTS orders, COM orders will not receive a ship (acknowledged) date until The HON Company has the fabric in its possession for production.
- Specific to DTS orders, the customer may send the required yardage for the order to the address listed on the approval email to arrive no sooner than 4 weeks in advance of the acknowledgment date.

HON will make every effort to locate mis-directed COM shipments on behalf of the customer. However, The HON Company will not be responsible for any COM received without a tracking number or incorrectly shipped by the fabric vendor to an incorrect producing facility.

COM ORDERING INFORMATION

The following information must appear on or accompany the product purchase order:

- Approval tracking number and the customer's purchase order number
- COM supplier, pattern, and color name/number

The packing list for the COM must include the following information when The HON Company receives the shipment for production:

- Dealer or Wholesaler Name
- Purchase order number submitted to The HON Company
- Fabric name
- Yardage shipped
- Approval ordering code

Specific to DTS orders; the customer should send only the amount needed for the order. Excess yardage or yardage not tied to an order will be disposed of at The HON Company.

CHANGES TO COM PRODUCT

Once a COM product is ordered, no changes or cancellations can be made to the COM product without approval from the HON COM team.

CONTACT COM TEAM

Phone: 800.833.3964 and listen for COM TEAM offering on the menu.

COM Email: HONCOMTeam@honcompany.com

PARTNERSHIP TEXTILE INFORMATION

Partnership Textiles is the result of The HON Company's partnership with textile industry leaders Camira, HBF Textiles, Maharam, Momentum, Stinson, and Ultrafabrics, LLC. The extensive collection of design-driven textiles create a superior offering at a great value. Partnership Textiles significantly updates HON's offering, expanding it with fresh and exciting options.

- Fabric Warranty: Partnership Textiles are covered by HON's Full Lifetime Warranty.
- Lead Times: Orders specified with Partnership Textiles will be acknowledged based on the supplier's availability and delivery schedule.
- Availability: The HON Company will regularly introduce new Partnership Textiles and reserves the right to change the offering at any time.
- Fabric Cards: A curated set of Partnership Textiles are carded jointly by HON and the supplier.

Camira

- Blazer

HBF Textiles*

- Cloverleaf
- Denim Wash
- Everyday Textiles II
- Everyday Textures

*HBF Textiles patterns are graded in to HON's offering.

Maharam

- Apt
- Bluff
- Collection 1
- Lariat
- Meld
- 6M

Momentum

- Nexus
- Chroma
- Smart Fusion

Stinson

- Elevate II

Ultrafabrics, LLC

- Brisa
- Ultraleather Pro

Fabric Memo Samples: Please contact the supplier directly:

Camira: memos@camirafabrics.com

HBF Textiles: Phone: +1 (877) 494-5727, orders@hbftextiles.com

Maharam: (800) 645-3943

Momentum: customerservice@momtex.com (800) 366-6839

Stinson: (800) 841-6279

Ultrafabrics: (877) 309-6648

HON BRANDED, PARTNERSHIP AND COM PATTERN MATCH

- Pattern matching provides alignment of patterns or stripes across individual chair surfaces. Additional yardage may be required depending on pattern repeat. If Pattern Match is needed, please contact HON Customer Support/Tailored Solutions.
- Chair to Chair Pattern Match provides identical pattern alignment from unit to unit and is available with an upcharge. Chair to Chair Pattern Match is reviewed on a case by case basis as several factors are reviewed to determine additional yardage required, including repeat and pattern direction. If Chair to Chair Pattern Match is needed, please contact HON Customer Support/Tailored Solutions.



The HON Company has established paint grades to allow customers flexibility and ease in doing business with HON. HON has three paint grades P1, P2, and P3.

P1 PAINT COLORS

HON has established P1 paints which are available on a majority of core products.

P2 PAINT COLORS

Please see individual pricer pages for eligible series and upcharges for P2 paints. P2 paints are listed in the pricer pages under the column P2. Upcharges vary by product (all standard discounts/competitive project pricing applies). No minimum quantity required.

P3 PAINT COLORS

Please see individual pricer pages for eligible series and upcharges for P3 paints. P3 paints are listed in the pricer pages under the column P3. Upcharges vary by product (all standard discounts/competitive project pricing applies). No minimum quantity required.

SPECIAL PAINT COLORS (P4-P6)

With The HON Company's state of the art color matching equipment just about any color can be matched, excluding some metallic and whites. A sample of the exact color desired is required for matching and approval.

- For each newly requested paint, a net fee of \$250 will be charged to cover costs associated with the matching process.
- For existing, previously matched paints, there is no matching fee, however there is a \$100 net fee for sample panels required for the approval process. Refer to MyProjects on the HON Portal for a list of approved special paints.

For all special paint requests, HON will send a production sample for the customer to review and approve. Once the signed paint sample is received at HON the order can be entered. Upcharges vary by product (all standard discounts/competitive project pricing applies). A quantity of 10 like-model minimum order is required for special paints. For complete program details, access Tailored Solutions on the HON Ready Portal at honready.hon.com.

Some special colors could fall outside of this program due to production costs or not meeting HON quality standards. The HON Company may apply additional charges to some colors which are costly to apply, and deny some orders on colors that cannot meet our high-quality standards. We will notify the customer upon completion of our evaluation if a change in price is required or if the request is denied.

HON OPEN LINE LAMINATE PROGRAM

The Open Line Laminate (OLL) program makes it even easier for a customer to tailor their HON product for a custom look. Select HON furniture products accommodate hundreds of graded-in high-pressure laminates (HPL) from the leading laminate manufacturers' open lines.

Laminates that are currently available in the program can be viewed in specification tools.

Requests to add laminates to the standard specials program can be submitted through the CET Specials Integration tool as well as Community.

Matching edge options are not available offered for laminates in the OLL program. When selecting a laminate please select an edge option from the HON standard offering. If a matching edge is required a modification request can be submitted through the CET Specials Integration tool as well as Community.

The OLL program is available with the following HON products and series:

- Abound® Hard-Surface Tiles
- Birk™ Tables
- Build™ Tables
- Coordinate™ Worksurfaces
- Gallery Panels
- Huddle Tables
- Preside® Tops
- Sculpt™/Occasional Tables
- SmartLink® Value Teacher Desk
- Systems Worksurfaces
- Tangram™
- Universal Screens

Due to manufacturing techniques, materials, quality issues of varying laminates, and minimum order quantities, some product exclusions will apply and some requests may be declined.

Extended lead times may apply on orders containing special laminates.

Contact the Tailored Products Group for questions or additional information regarding pre-approved laminates and pricing.

HON

Phone: 888-255-7833, Option 4.5

Email: HONSpecials@honcompany.com

For edgeband recommendations from the HON standard offering, please email the HNI Workplace Colors, Materials, and Finishes team at honfinishes@honcompany.com.

For laminate samples, please contact the manufacturer directly:

Wilsonart

<https://www.wilsonart.com/>
1-800-433-3222

Formica

<https://www.formica.com/en-us/>
1-800-FORMICA (367-6422)

Nevamar and Pionite

<https://www.panolam.com>
877-726-6526

ENVIRONMENTAL STATEMENT

We continually reevaluate our purpose and processes, from fostering transparency and circularity in our supply chain to empowering our members to do and be better. We do it so the environments you create will be safer, more socially responsible, and more sustainable.

We've pursued product certifications to help communicate our commitment to developing sustainable products.

Clearing the air.

In 2006, The HON Company became one of the first office furniture manufacturer to have products certified under the Indoor Advantage™ program. Virtually all manufactured products emit chemical compounds into the air. Indoor Advantage™ certification helps assure customers that certified products will help improve the air quality within their offices and workspaces.

Developed by SCS Global Services, Indoor Advantage™ evaluates products against indoor air quality standards, like ANSI/BIFMA Furniture Emissions Standard, M7.1/X7.1 and CDPH Standard Method v1.1. The ANSI/BIFMA X7.1 standard allows manufacturers to test individual components, as well as complete products for emissions from volatile organic compounds (VOCs). This allows us to identify problematic materials and phase them out of our products.

Indoor Advantage™ certified products meet the LEED and WELL criteria for low-emitting materials.

Indoor Advantage™ offers two levels of certification, including Indoor Advantage™ and Indoor Advantage™ Gold.



On the LEVEL®.

LEVEL®, the certification program for the BIFMA e3 Sustainability Standard, was developed in response to increasing demand for proof that manufacturers were living up to their environmental claims. LEVEL® is a multi-attribute sustainability certification label for products that have met criteria in four categories of impact: Materials, Energy and Atmosphere, Human and Ecosystem Health, and Social Responsibility.

HON's products are certified to LEVEL 2 and LEVEL 3, the highest achievement. BIFMA LEVEL 2 and LEVEL 3 certified products can contribute to LEED and WELL projects.



Evaluating Our Impacts.

HON has begun studying the impacts our products have on the environment through lifecycle assessments and creating Environmental Product Declarations (EPDs). EPDs provide an understandable report of a product's environmental impact throughout its life cycle; including raw material extraction and processing, product assembly, distribution and use, and end-of-life.

Products that meet these specifications are identified throughout this publication with the following icons:

Certified SCS Indoor Advantage™

LEVEL® certified to the BIFMA e3 Sustainability Standard

Environmental Product Declarations

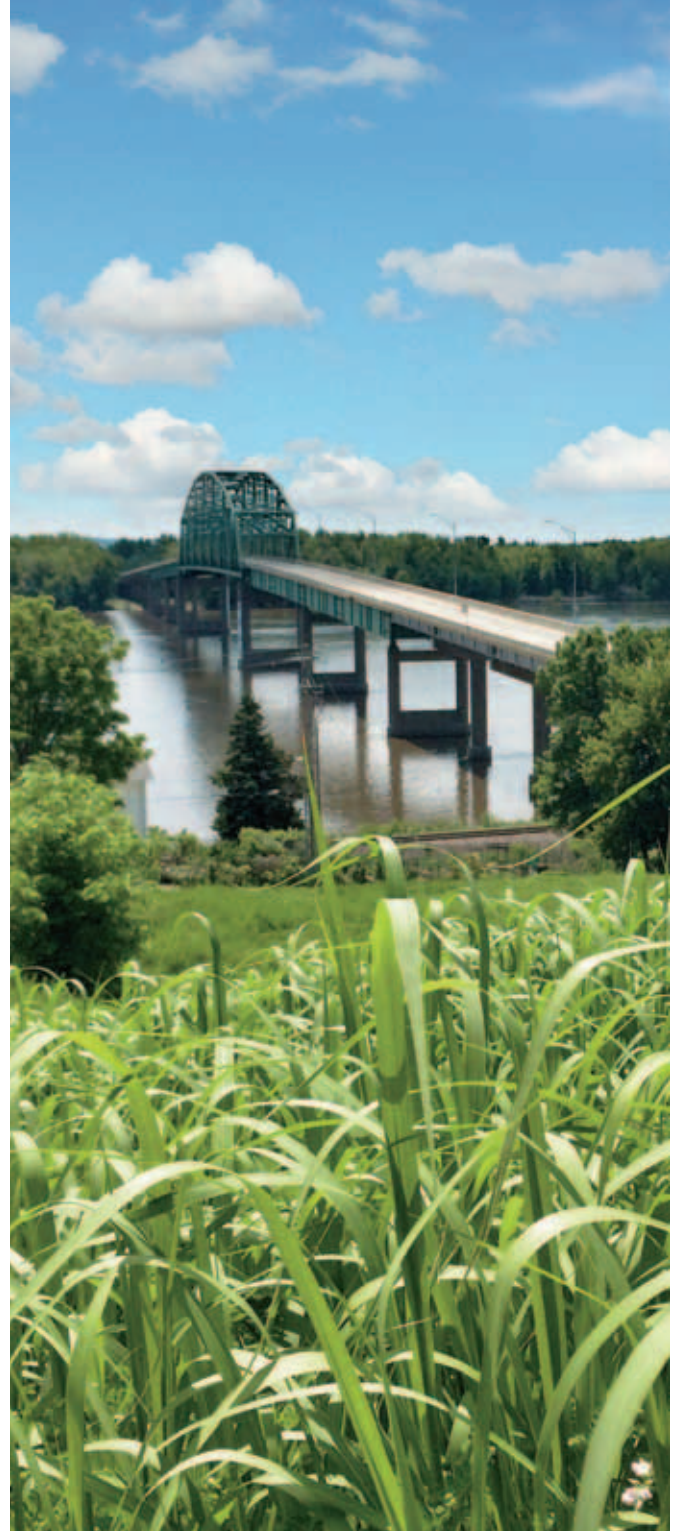

IMPORTANT INFORMATION

HON NOW™

SUPERIOR OFFICE SOLUTIONS AT THE SPEED YOU NEED

To keep your business at peak productivity, waiting is not always an option. The HON NOW™ Quickship program was designed for movers and shakers like you who want exceptional quality, durability, and versatility without compromising valuable time. Whether you're outfitting a brand new workspace or simply expanding the one you already have, we've got a variety of dependable and supportive office furniture solutions designed to fit your needs and your schedule — in a hurry, without the hassle.

To learn more, visit hon.com/hon-now.

GSA CONTRACT INFORMATION

Model numbers identified with the verbiage “**Open Market**” are not offered on HON's GSA contract GS-27F-0015S. Model numbers identified with the following verbiage “Must be purchased with a configurable end product. If ordered separately, not on GSA contract” is to mean that these configurable components or options:

- Have no functionality or capability without being integrated into an end product, and
- Are not separately orderable; an eligible Schedule ordering activity may only purchase them with a configured system that is on contract.

HON CUSTOMER SUPPORT CONTACT INFORMATION

Nationwide CS Phone – (800) 833-3964

Nationwide Order Entry – HONOE@honcompany.com

GSA Order Entry: HONGSAOE@honcompany.com

Integrated Design Solutions – integrateddesign@honcompany.com

Online Order and Tool Support – HONReady@honcompany.com

DASH (transportation and delivery assistance) – (800) 334-8057

HON Literature Fulfillment Phone – (800) 466-4808

Government Support:

GovernmentSupport@hniworkplacefurnishings.com

Product, Parts, Non-Warranty Parts Orders:

ProductSupport@hniworkplacefurnishings.com

Quick Ship Orders: QuickShip@hniworkplacefurnishings.com

Order Status: OrderStatus@hniworkplacefurnishings.com

General Inquiries: GeneralSupport@hniworkplacefurnishings.com



Nationwide CS Phone

800-833-3964

THE FOLLOWING ICONS MAY BE USED THROUGHOUT THIS PUBLICATION

	Meets or exceeds ANSI/BIFMA and ISTA performance standards		Readily Available. For additional lead time information see page 21.
	Certified SCS Indoor Advantage™ See page 17 for more details.		Available within a “standard” or “extended” lead time. For additional lead time information see page 21.
	Complies to the BIFMA e3 Sustainability Standard. See page 17 for more details.		May have extended lead times. For additional lead time information see page 21.
	Caution		Product shipped two to a carton
	Easy to assemble		Product shipped four to a carton
	Shippable by small-package carrier		Fire Code
	Wheel-chair compatible		Core Product Line
	Soft-tread caster option available		ColorCorrect® Eligible Product
	HON “One Key” Interchangeable core removable locks (see page 699)		Product scheduled for discontinuation. See page 5 for details.
	Omit core removable lock option available. Allows keyed alike workstations (see page 699).		DE-EMPHASIZED: Product or fabric/surface material is de-emphasized. Not carded.
	Base models available on the HON NOW Quickship Program with select options and finishes. View the entire NOW collection at honready.hon.com .		Warranted for multiple shift use, 24 hours a day 7 days a week

FABRIC PATTERNS & CODES



FABRIC PATTERNS & CODES

- For additional HON to Supply COM fabric grade pricing, go to honready.hon.com and search on the HON to Supply COM link.
 - All specifications in this publication are based on the latest product information available at the time of print.
 - Certain dyes (including clothing and accessory dyes such as those used on denim jeans) may migrate to lighter colors. This phenomenon is increased by humidity and temperature and is irreversible. The HON Company LLC does not assume responsibility for dye transfer caused by external contaminants.
 - COM Ordering Information and pricing on page 13.
 - See page 14 for Partnership Textile program information.
 - All standard fabrics are carded. Cards are available through HON Literature Fulfillment.
 - Fabrics and foam meet requirements for CAL-TB 117-2013.
- ! Different fabrics and finishes have different recommended cleaning and maintenance methods. For the correct product care for all finishes view the HON Product Care guide at hon.com/customer-support/product-care.

LEAD TIMES

THE FOLLOWING ICONS ARE USED TO DENOTE FABRIC OPTION LEAD TIMES

FABRIC/FINISH LEAD TIME INDICATOR



Fabric is readily available. Products using these fabrics will receive the best available product lead time and are a good option for standards programs as they will be in the HON portfolio for several years. Go to honready.hon.com and use **Compass** for product lead times by series.



Fabric is available within standard lead times. Products using these fabrics will receive a “standard” or “extended” lead time. The lead time will be determined by the combination of product and fabric. Go to honready.hon.com and use **Compass** for product lead times by series.



Fabric may have extended lead times. Products using these fabrics will typically have a 4+ week lead time. Go to honready.hon.com and use the **Compass** tool for product lead times by series.

HON EXPRESS QUICK SHIP PROGRAM

For the full list of products delivered in 5 business days or less, visit honready.hon.com.

PRODUCT LEAD TIMES

Standard lead times for products are between 2-4 weeks. For current exceptions to our standard lead time, go to honready.hon.com and use the **Compass** tool.

In order to establish accurate expectations for your project, please review this listing prior to submitting your purchase order.

Lead time calculation begins when order is free from any holds (i.e., bad lines, material, credit, etc.).

Please note, these production lead time estimates do NOT include delivery time. All published lead times are estimates, not guarantees of delivery.

For further information concerning lead times, please contact HON Customer Support via email HONTeamBox@honcompany or by phone at **800-833-3964**.

SEATING FABRIC PATTERNS & CODES

Scan here to check out our full Chair Fabrics solutions



GRADE 1

APEX	APX
◆ Basalt	APX25
◆ Beet	APX12
◆ Blackberry	APX20
◆ Chive	APX05
◆ Iris	APX03
◆ Kiwi	APX06
◆ Lemonade	APX08
◆ Navy	APX13
◆ Papaya	APX09
◆ Pumice	APX23
◆ Rain	APX19
◆ Resort	APX15
◆ Royal	APX14
◆ Tiki	APX29
◆ Tomato	APX11

BLACK FABRIC	ACCF
◆ Black	ACCF10

BLACK MESH	ACCM
◆ Black	ACCM10

CENTURION	CU
◆ Apricot	CU47
◆ Bark	CU25
◆ Black	CU10
◆ Espresso	CU49
◆ Fog	CU03
◆ Frost	CU22
◆ Goldenrod	CU27
◆ Indigo	CU06
◆ Iris	CU50
◆ Iron Ore	CU19
◆ Jade	CU83
◆ Marsala	CU63
◆ Morel	CU24
◆ Navy	CU98
◆ Peacock	CU97
◆ Pear	CU84
◆ Ruby	CU67
◆ Sapphire	CU09

COMPASS	COMP
◆ Beach	COMP16
◆ Bittersweet	COMP46
◆ Chocolate	COMP49
◆ Ink	COMP10
◆ Meadow	COMP82
◆ Midnight	COMP90
◆ Putty	COMP22
◆ Ruby	COMP62
◆ Sterling	COMP19
◆ Taupe	COMP26
◆ Tide	COMP96

GRADE 1 *continued*

COMPASS FOAM*	COMF
◆ Bittersweet	COMF46
◆ Ink	COMF10
◆ Meadow	COMF82
◆ Midnight	COMF90
◆ Putty	COMF22
◆ Sterling	COMF19

**This fabric available for Solve* Upholstered Back models only.*

CONTOURETT	UR
◆ Baltic	UR94
◆ Beach	UR23
◆ Black	UR10
◆ Bordeaux	UR63
◆ Buff	UR22
◆ Cloud	UR18
◆ Coffee Bean	UR49
◆ Crater	UR51
◆ Flame	UR62
◆ Graphite	UR19
◆ Iron	UR20
◆ Luggage	UR26
◆ Marine	UR92
◆ Navy	UR95
◆ Nimbus	UR93
◆ Ocean	UR96
◆ Pumpkin	UR42
◆ Quarry	UR24
◆ Red	UR64
◆ Safari	UR27
◆ Sage	UR82
◆ Steel	UR21
◆ Storm	UR17
◆ Taupe	UR28
◆ Trunk	UR50

DAPPER	DAPR
◆ Ash	DAPR20
◆ Breeze	DAPR06
◆ Canvas	DAPR25
◆ Charcoal	DAPR01
◆ Clover	DAPR22
◆ Currant	DAPR00
◆ Fawn	DAPR35
◆ Fern	DAPR85
◆ Gerbera	DAPR16
◆ Grape	DAPR33
◆ Jewel	DAPR08
◆ Marigold	DAPR65
◆ Onyx	DAPR10
◆ Orchid	DAPR90
◆ Parrot	DAPR59
◆ Poppy	DAPR19
◆ Sapphire	DAPR07
◆ Scarlet	DAPR45

GRADE 1 *continued*

DAPPER <i>continued</i>	DAPR
◆ Sepia	DAPR30
◆ Sky	DAPR44
◆ Slate	DAPR15
◆ Sorbet	DAPR55
◆ Spring	DAPR80
◆ Terracotta	DAPR13
◆ Titanium	DAPR17
◆ Varsity	DAPR09
◆ Zest	DAPR70

ENSEMBLE	ENSB
◆ Aquamarine	ENSB30
◆ Ash	ENSB39
◆ Greige	ENSB36
◆ Harbor	ENSB34
◆ Navy	ENSB35
◆ Oat	ENSB37
◆ Pear	ENSB33
◆ Sand	ENSB38
◆ Scarlet	ENSB32
◆ Slate	ENSB31
◆ Stone	ENSB40

HAMILTON	HAML
◆ Agave	HAML28
◆ Azure	HAML10
◆ Biscotti	HAML11
◆ Cabernet	HAML08
◆ Caribbean	HAML29
◆ Carolina	HAML21
◆ Charcoal	HAML17
◆ Chocolate	HAML13
◆ Cloud	HAML18
◆ Dane	HAML16
◆ Deep	HAML27
◆ Dove Grey	HAML33
◆ Dusty Rose	HAML07
◆ Esmeralda	HAML06
◆ Fern	HAML04
◆ Fresh	HAML03
◆ Garnet	HAML22
◆ Granola	HAML19
◆ Hearth	HAML34
◆ Lilac	HAML14
◆ Lime	HAML05
◆ Lipstick	HAML09
◆ Mellow	HAML25
◆ Mossy Green	HAML26
◆ Oxford	HAML20
◆ Passion Fruit	HAML02
◆ Pepper	HAML15
◆ Powder	HAML12
◆ Royalty	HAML31
◆ Serene	HAML30
◆ Sunny Day	HAML24
◆ Sunrise	HAML01
◆ Terracotta	HAML23
◆ Winter Sky	HAML32

GRADE 1 *continued*

INERTIA	NR
◆ Amethyst	NR61
◆ Calypso	NR98
◆ Cherry	NR66
◆ Cobalt	NR91
◆ Coffee	NR49
◆ Fog	NR19
◆ Fuchsia	NR63
◆ Gecko	NR76
◆ Glow	NR27
◆ Leaf	NR75
◆ Lime	NR82
◆ Loft	NR22
◆ Mandarin	NR47
◆ Meteor	NR30
◆ Mustard	NR26
◆ Nickel	NR23
◆ Onyx	NR10
◆ Regatta	NR90
◆ Shadow	NR20
◆ Surf	NR96
◆ Tangelo	NR46

NOBLE SEATING	SNBLE
◆ Aegean	SNBLE18
◆ Amethyst	SNBLE19
◆ Aspen	SNBLE14
◆ Aster	SNBLE20
◆ Blossom	SNBLE21
◆ Bluebell	SNBLE22
◆ Bordeaux	SNBLE01
◆ Brick	SNBLE02
◆ Chambray	SNBLE10
◆ Chamomile	SNBLE23
◆ Clementine	SNBLE04
◆ Conifer	SNBLE24
◆ Cottage	SNBLE25
◆ Darkness	SNBLE26
◆ Dawn	SNBLE13
◆ Denim	SNBLE09
◆ Desert Sand	SNBLE27
◆ Dewfall	SNBLE28
◆ Dusted Sage	SNBLE29
◆ Flax	SNBLE30
◆ Grass	SNBLE07
◆ Gunmetal	SNBLE15
◆ Harmony	SNBLE31
◆ Harvest	SNBLE12
◆ Ice Caves	SNBLE32
◆ Icicle	SNBLE33
◆ Inky	SNBLE34
◆ Iris	SNBLE35
◆ Jade	SNBLE06
◆ Knight	SNBLE17
◆ Mesa	SNBLE03
◆ Monarch	SNBLE36
◆ Pacific	SNBLE08
◆ Pitch	SNBLE37
◆ Queen Bee	SNBLE38



Scan here to check out
our full Chair Fabrics
solutions

SEATING FABRIC PATTERNS & CODES

GRADE 1 *continued*

NOBLE SEATING <i>continued</i>	SNBLE
◆ Rainforest	SNBLE05
◆ Regal	SNBLE11
◆ Sandcastle	SNBLE39
◆ Sedona	SNBLE40
◆ Stormy	SNBLE16
◆ Sunbeam	SNBLE41
◆ Voyager	SNBLE42
◆ Windy Day	SNBLE43

OPTIC	OP
◆ Aurora	OP72
◆ Bark	OP24
◆ Canopy	OP84
◆ Char	OP49
◆ Ruby	OP42
◆ Sand	OP17
◆ Sky	OP83
◆ Slate	OP19
◆ Sprout	OP74
◆ Starry Night	OP11
◆ Storm	OP56
◆ Wildfire	OP66

PEBBLE	PBLE
◆ Amber	PBLE01
◆ Chalk	PBLE02
◆ Coal	PBLE03
◆ Gravel	PBLE04
◆ Magma	PBLE06
◆ Moss	PBLE05
◆ Sandstone	PBLE07
◆ Talc	PBLE08
◆ Topaz	PBLE09
◆ Zircon	PBLE10

VIBE	VIBE
◆ Bliss	VIBE03
◆ Calm	VIBE06
◆ Carefree	VIBE08
◆ Cheerful	VIBE17
◆ Compassion	VIBE01
◆ Connected	VIBE13
◆ Content	VIBE19
◆ Courage	VIBE12
◆ Dazed	VIBE21
◆ Delight	VIBE18
◆ Euphoria	VIBE15
◆ Gleeful	VIBE04
◆ Gloomy	VIBE22
◆ Hope	VIBE07
◆ Moody	VIBE05
◆ Nostalgia	VIBE09
◆ Perplexed	VIBE10
◆ Pride	VIBE02
◆ Relaxed	VIBE20
◆ Secure	VIBE16
◆ Serenity	VIBE11
◆ Trust	VIBE14

GRADE 2

APPOINT SEATING	PNS
◆ Artichoke	PNS014
◆ Blackberry	PNS012
◆ Bronze	PNS002
◆ Carbon	PNS008
◆ Chai	PNS013
◆ Cherry	PNS010
◆ Dark Pewter	PNS017
◆ Dune	PNS015
◆ Espresso	PNS003
◆ Framboise	PNS011
◆ Frost	PNS034
◆ Jet	PNS007
◆ Lawn	PNS005
◆ Mandarin	PNS009
◆ Morel	PNS001
◆ Nimbus	PNS016
◆ Platinum	PNS004
◆ Turquoise	PNS006

BLUME	BLME
◆ Chalk	BLME03
◆ Char	BLME00
◆ Coin	BLME02
◆ Driftwood	BLME05
◆ Emerald City	BLME07
◆ Fir	BLME09
◆ Harvest	BLME04
◆ Haze	BLME08
◆ Hyacinth	BLME14
◆ Jasper	BLME13
◆ Merlot	BLME10
◆ Moonstone	BLME01
◆ Opal	BLME06
◆ Scarlet	BLME11
◆ Slate	BLME12

CLYDE	CLYD
◆ Antique	CLYD04
◆ Artifact	CLYD01
◆ Blacksmith	CLYD10
◆ Claret	CLYD13
◆ Craftsman	CLYD08
◆ Crate	CLYD12
◆ Fossil	CLYD02
◆ Heirloom	CLYD05
◆ Iron	CLYD11
◆ Keepsake	CLYD15
◆ Linen	CLYD14
◆ Relic	CLYD06
◆ Seasoned	CLYD03
◆ Trestle	CLYD07

GRADE 2 *continued*

DOTTY	DOT
◆ Candy	DOT63
◆ Gelato	DOT34
◆ Indigo	DOT31
◆ Onyx	DOT35
◆ Park	DOT83
◆ Peat	DOT24
◆ Peony	DOT32
◆ Suit	DOT20
◆ Sunflower	DOT33
◆ Tailor	DOT21
◆ Tide	DOT90
◆ Velum	DOT29
◆ Violet	DOT30

KA	KAI
◆ Algae	KAI07
◆ Barnacle	KAI19
◆ Clownfish	KAI04
◆ Coastal	KAI13
◆ Conch	KAI02
◆ Coral Reef	KAI16
◆ Crab	KAI01
◆ Ebb	KAI12
◆ Flow	KAI11
◆ Inlet	KAI03
◆ Jellyfish	KAI18
◆ Kelp	KAI08
◆ Orca	KAI26
◆ Otter	KAI22
◆ Puffer	KAI06
◆ Salty	KAI23
◆ Seahorse	KAI05
◆ Seashell	KAI20
◆ Seaweed	KAI09
◆ Shark	KAI24
◆ Shoreline	KAI21
◆ Stingray	KAI25
◆ Tide	KAI14
◆ Turtle	KAI10
◆ Urchin	KAI17
◆ Wave	KAI15

GRADE 2 *continued*

RUSH	RUSH
◆ Anchor	RUSH07
◆ Basil	RUSH16
◆ Blueberry	RUSH10
◆ Blue Sky	RUSH57
◆ Browned Butter	RUSH25
◆ Cherry Pie	RUSH40
◆ Cinnamon Sugar	RUSH35
◆ Dried Herb	RUSH62
◆ Flamingo	RUSH21
◆ Forest Green	RUSH67
◆ Greenery	RUSH15
◆ Greyhound	RUSH06
◆ Marina	RUSH13
◆ Merlot	RUSH19
◆ Midnight	RUSH11
◆ Mint	RUSH09
◆ Mulberry	RUSH18
◆ Obsidian	RUSH90
◆ Petals	RUSH77
◆ Pumice	RUSH01
◆ Punch	RUSH20
◆ Rain Drop	RUSH54
◆ Rush Smoke	RUSH84
◆ Sage	RUSH14
◆ Salsa	RUSH24
◆ Sand	RUSH05
◆ Seal	RUSH08
◆ Slate	RUSH89
◆ Soot	RUSH02
◆ Stout	RUSH03
◆ Sunshine	RUSH23
◆ Tapestry	RUSH04
◆ Tiger	RUSH22
◆ Vintage	RUSH17
◆ Wave	RUSH12

SPIN SEATING	SPNN
◆ Alabaster	SPNN02
◆ Cavern	SPNN03
◆ Cobblestone	SPNN04
◆ Ember	SPNN06
◆ Flame	SPNN07
◆ Heron	SPNN13
◆ Oat	SPNN01
◆ Ocean	SPNN12
◆ Plum	SPNN15
◆ Pool	SPNN11
◆ Raven	SPNN10
◆ Rhubarb	SPNN14
◆ Tropic	SPNN08
◆ Willow	SPNN05

SEATING FABRIC PATTERNS & CODES

Scan here to check out our full Chair Fabrics solutions



GRADE 2 *continued*

WAVELENGTH	WVL
◆ Base	WVL21
◆ Crest	WVL14
◆ Cycle	WVL20
◆ Energy	WVL03
◆ Frequency	WVL04
◆ Infrared	WVL01
◆ Motion	WVL13
◆ Movement	WVL05
◆ Peak	WVL11
◆ Pressure	WVL06
◆ Shallow	WVL02
◆ Still	WVL07
◆ Surface	WVL18
◆ Surge	WVL10
◆ Swell	WVL08
◆ Tide	WVL16
◆ Transition	WVL15
◆ Trough	WVL19
◆ Tsunami	WVL09
◆ Ultraviolet	WVL12
◆ White Caps	WVL17

WHISPER VINYL	WP
◆ Antelope	WP20
◆ Auburn	WP02
◆ Black	WP40
◆ Bone	WP17
◆ Bordeaux	WP26
◆ Breeze	WP76
◆ Brick Red *	WP99
◆ Camel	WP18
◆ Cappuccino	WP21
◆ Carotene *	WP97
◆ Cashew	WP29
◆ Cerulean	WP36
◆ Charcoal	WP39
◆ Cinnamon	WP25
◆ Coastal	WP81
◆ Cognac	WP62
◆ Cucumber *	WP88
◆ Elephant	WP38
◆ Emerald	WP80
◆ Espresso	WP49
◆ Farro	WP73
◆ Fawn	WP91
◆ Fog	WP100
◆ Forest *	WP82
◆ Fossil	WP01

GRADE 2 *continued*

WHISPER VINYL <i>continued</i>	WP
◆ Gravel *	WP19
◆ Herbal	WP79
◆ Indigo	WP86
◆ Islet	WP77
◆ Luggage	WP23
◆ Mahogany	WP93
◆ Mallard	WP90
◆ Merlot *	WP27
◆ Molten	WP98
◆ Navy	WP37
◆ Ochre *	WP96
◆ Paradise	WP85
◆ Patina	WP34
◆ Pavestone	WP74
◆ Pearl	WP71
◆ Pewter	WP83
◆ Powder	WP70
◆ Putty *	WP84
◆ Saddle	WP03
◆ Salsa	WP42
◆ Sand	WP72
◆ Sangre *	WP28
◆ Sassafras	WP89
◆ Silver Leaf	WP78
◆ Slate	WP04
◆ Storm	WP92
◆ Terracotta	WP75
◆ Truffle	WP95
◆ Wolf Grey	WP55
◆ Zest *	WP87

GRADE 3

BRADBURY	BDY
◆ Acorn	BDY01
◆ Alabaster	BDY02
◆ Aspire	BDY03
◆ Blueberry	BDY04
◆ Carbon	BDY05
◆ Concord	BDY06
◆ Cozumel	BDY07
◆ Dolphin	BDY08
◆ Gala	BDY09
◆ Honey	BDY10
◆ Mushroom	BDY11
◆ Mystic	BDY12
◆ Oat	BDY13
◆ Rhino	BDY14
◆ Scallion	BDY15
◆ Sidewalk	BDY16
◆ Terrazzo	BDY17
◆ Vellum	BDY18
◆ Walnut	BDY19

GRADE 3 *continued*

GETAWAY	GTWY
◆ Brig	GTWY15
◆ Canoe	GTWY03
◆ Catamaran	GTWY08
◆ Cruise Ship	GTWY10
◆ Cuddy	GTWY01
◆ Ferry	GTWY11
◆ Gondola	GTWY02
◆ Jet Ski	GTWY09
◆ Kayak	GTWY05
◆ Pontoon	GTWY13
◆ Runabout	GTWY14
◆ Sailboat	GTWY07
◆ Speedboat	GTWY12
◆ Wakeboard	GTWY06
◆ Yacht	GTWY04

MOXIE	SX
◆ Barnwood	SX09
◆ Basalt	SX23
◆ Bayou	SX02
◆ Bermuda	SX52
◆ Biscotti	SX08
◆ Blackberry	SX48
◆ Blarney	SX49
◆ Blueberry	SX05
◆ Bonsai	SX20
◆ Brigade	SX53
◆ Butterscotch	SX54
◆ Carob	SX24
◆ Chalk	SX50
◆ Chartreuse	SX34
◆ Cherry	SX38
◆ Cinnamon	SX13
◆ Cobalt	SX01
◆ Coconut	SX06
◆ Concrete	SX43
◆ Cozumel	SX55
◆ Cumin	SX32
◆ Dover	SX56
◆ Dragonfly	SX44
◆ Earl Grey	SX40
◆ Elysian	SX04
◆ Evergreen	SX21
◆ Fatigue	SX18
◆ Fawn	SX30
◆ Flint	SX39
◆ Forsythia	SX57
◆ Grenache	SX58
◆ Hazel	SX31
◆ Hemp	SX45
◆ Hickory	SX25
◆ Holly	SX51
◆ Jam	SX16
◆ Kelly	SX33
◆ Lemongrass	SX19

GRADE 3 *continued*

MOXIE <i>continued</i>	SX
◆ Lime	SX41
◆ Macintosh	SX12
◆ Midnight	SX59
◆ Mulberry	SX15
◆ Muslin	SX60
◆ Pacifica	SX61
◆ Parchment	SX07
◆ Peacock	SX03
◆ Phantom	SX62
◆ Pineapple	SX42
◆ Plum	SX17
◆ Punch	SX46
◆ Riverstone	SX47
◆ Russet	SX14
◆ Smokestack	SX22
◆ Tangerine	SX37
◆ Terracotta	SX11
◆ Thicket	SX35
◆ Walnut	SX10
◆ Whirlwind	SX63

NOTION

NOTION	NTN
◆ Agave	NTN01
◆ Bark	NTN02
◆ Beeswax	NTN03
◆ Carbon	NTN04
◆ Cassis	NTN05
◆ Cement	NTN06
◆ Char	NTN07
◆ Chroma	NTN08
◆ Dockside	NTN09
◆ Drifter	NTN10
◆ Fog	NTN11
◆ Fountain	NTN12
◆ Fox	NTN13
◆ Grassland	NTN14
◆ Henna	NTN15
◆ Horizon	NTN16
◆ Ivy	NTN17
◆ Linen	NTN18
◆ Mykonos	NTN19
◆ Peat	NTN20
◆ Poppy	NTN21
◆ Rockfall	NTN22
◆ Sandwash	NTN23
◆ Stoneware	NTN24
◆ Sumac	NTN25
◆ Twilight	NTN26

For a complete list of fabrics, including partnership fabrics, go to hon.com/fabricsandfinishes.

* Fabric is de-emphasized.



Scan here to check out
our full Chair Fabrics
solutions

SEATING FABRIC PATTERNS & CODES

GRADE 3 *continued*

PARKER	PRKR
◆ Aloe	PRKR01
◆ Cumulus	PRKR05
◆ Cyan	PRKR06
◆ Domino	PRKR07
◆ Fossil	PRKR10
◆ Graphite	PRKR11
◆ Grass	PRKR12
◆ Grenadine	PRKR13
◆ Griffin	PRKR14
◆ Kiln	PRKR16
◆ Magnesium	PRKR18
◆ Magnet	PRKR19
◆ Mica	PRKR20
◆ Mink	PRKR21
◆ Nightfall	PRKR22
◆ Paprika	PRKR24
◆ Pine	PRKR25
◆ Rapids	PRKR28
◆ Rioja	PRKR30

PURL	PURL
◆ Alpaca	PURL08
◆ Braid	PURL10
◆ Deep	PURL12
◆ Graze	PURL05
◆ Loom	PURL06
◆ Needle	PURL07
◆ Pasture	PURL02
◆ Ranch	PURL04
◆ Shuttle	PURL09
◆ Skein	PURL01
◆ Thistle	PURL11
◆ Yearling	PURL03

QUILL	QUL
◆ Aviary	QUL03
◆ Feather	QUL02
◆ Fountain	QUL06
◆ Ink	QUL05
◆ Metal	QUL04
◆ Reed	QUL08
◆ Scroll	QUL01
◆ Well	QUL07

GRADE 3 *continued*

SAXONY	SXNY
◆ Arctic	SXNY14
◆ Azure	SXNY11
◆ Black	SXNY21
◆ Clover	SXNY06
◆ Cobalt	SXNY12
◆ Emerald	SXNY08
◆ Flare	SXNY02
◆ Fog	SXNY18
◆ Grass	SXNY05
◆ Iron	SXNY20
◆ Lagoon	SXNY07
◆ Lipstick	SXNY01
◆ Mandarin	SXNY03
◆ Navy	SXNY13
◆ Sand	SXNY16
◆ Sea	SXNY10
◆ Shell	SXNY15
◆ Sky	SXNY09
◆ Storm Cloud	SXNY19
◆ Taupe	SXNY17
◆ Zest	SXNY04

GRADE 4

CONSTANCE WITH SUPREEN™	CNST
◆ Airy	CNST01
◆ Aztec	CNST02
◆ Cassis	CNST03
◆ Copperplate	CNST04
◆ Cornerstone	CNST05
◆ Envy	CNST06
◆ Flagstone	CNST07
◆ Flax	CNST08
◆ Frost	CNST09
◆ Gateway	CNST10
◆ Grounds	CNST11
◆ Hayfield	CNST12
◆ Inkpad	CNST13
◆ Pewter	CNST14
◆ Pistachio	CNST15
◆ Pompeii	CNST16
◆ Poseidon	CNST17
◆ Reflection	CNST18
◆ Scuba	CNST19
◆ Stoic	CNST20
◆ Stonnington	CNST21
◆ Thunder	CNST22
◆ Waterfall	CNST23

GRADE 4 *continued*

LIVI WITH SUPREEN™	LIVI
◆ Asphalt	LIVI01
◆ Atlantis	LIVI02
◆ Bouquet	LIVI03
◆ Branch	LIVI04
◆ Coastal	LIVI05
◆ Cowboy	LIVI06
◆ Dawn	LIVI07
◆ Earth	LIVI09
◆ Evergreen	LIVI10
◆ Fennel	LIVI11
◆ Fog	LIVI12
◆ Honeycomb	LIVI13
◆ Jade	LIVI14
◆ Limestone	LIVI15
◆ Monochrome	LIVI16
◆ Night	LIVI17
◆ Overcast	LIVI18
◆ Pebble	LIVI19
◆ Pillow	LIVI08
◆ Plum	LIVI20
◆ Pumpkin	LIVI21
◆ Rhubarb	LIVI22
◆ Saxon	LIVI23
◆ Seaside	LIVI24
◆ Twine	LIVI25

LUGANO WITH SUPREEN™	LUG
◆ Andromeda	LUG01
◆ Aquarelle	LUG02
◆ Bayou	LUG03
◆ Caviar	LUG04
◆ Cloud	LUG05
◆ Cobblestone	LUG06
◆ Dutch	LUG07
◆ Flirt	LUG08
◆ Florence	LUG09
◆ Frost	LUG10
◆ Ganache	LUG11
◆ Gravel	LUG12
◆ Juniper	LUG13
◆ Lapis	LUG14
◆ Moonstone	LUG15
◆ Mustard Seed	LUG16
◆ Sandstone	LUG17
◆ Sconce	LUG18
◆ Semolina	LUG19
◆ Spice Market	LUG20
◆ Sterling	LUG21

GRADE 4 *continued*

OXFORD WITH SUPREEN™	OXFD
◆ Armor	OXFD01
◆ Azurite	OXFD02
◆ Cadet	OXFD03
◆ Cider	OXFD04
◆ Clover	OXFD05
◆ Coal	OXFD16
◆ Coin	OXFD06
◆ Crema	OXFD07
◆ Currant	OXFD08
◆ Deluge	OXFD09
◆ Dewberry	OXFD10
◆ Falcon	OXFD11
◆ Gingerbread	OXFD12
◆ Laurel	OXFD13
◆ Odyssey	OXFD14
◆ Pavement	OXFD15
◆ Redvine	OXFD17
◆ Seadrift	OXFD18
◆ Shoji	OXFD19
◆ Tourmaline	OXFD20
◆ Vignette	OXFD21

GRADE L1

DENVER LEATHER	SS
◆ Black	SS11



Scan here to check out
our full Chair Fabrics
solutions

PANEL FABRIC PATTERNS & CODES

PRICE CODE AA		PRICE CODE A		PRICE CODE A <i>continued</i>		PRICE CODE A <i>continued</i>	
FACTOR	FACT	APPOINT	APN	ETCH*	ECH	NOBLE	NBLE
◇ Bark *	FACT20	◇ Artichoke	APN11	◇ Axis	ECH13	◇ Aegean	NBLE18
◇ Barley *	FACT15	◇ Blackberry	APN32	◇ Blend	ECH14	◇ Amethyst	NBLE19
◇ Cascade *	FACT25	◇ Bronze	APN22	◇ Cast	ECH12	◇ Aspen	NBLE14
◇ Feather *	FACT30	◇ Carbon	APN28	◇ Highlight	ECH10	◇ Aster	NBLE20
		◇ Chai	APN12	◇ Midtone	ECH11	◇ Blossom	NBLE21
		◇ Cherry	APN30	◇ Outline	ECH08	◇ Bluebell	NBLE22
		◇ Dark Pewter	APN17	◇ Shade	ECH09	◇ Bordeaux	NBLE01
		◇ Dune	APN15	◇ Tonal	ECH16	◇ Brick	NBLE02
		◇ Espresso	APN23	◇ Vanish	ECH15	◇ Chambray	NBLE10
		◇ Framboise	APN31			◇ Chamomile	NBLE23
		◇ Frost	APN34	LANDSCAPE*	LN	◇ Clementine	NBLE04
		◇ Jet	APN27	◇ Azure	LN55	◇ Conifer	NBLE24
		◇ Lawn	APN25	◇ Cornsilk	LN15	◇ Cottage	NBLE25
		◇ Mandarin	APN29	◇ Drift	LN05	◇ Darkness	NBLE26
		◇ Morel	APN09	◇ Khaki	LN20	◇ Dawn	NBLE13
		◇ Nimbus	APN16	◇ Sheen	LN10	◇ Denim	NBLE09
		◇ Platinum	APN24	◇ Slate	LN35	◇ Desert Sand	NBLE27
		◇ Turquoise	APN26	◇ Umber	LN25	◇ Dewfall	NBLE28
				◇ Urban	LN30	◇ Dusted Sage	NBLE29
		CENTURION	CU			◇ Flax	NBLE30
		◇ Apricot	CU47	LUCY*	LC	◇ Grass	NBLE07
		◇ Bark	CU25	◇ Aspen	LC32	◇ Gunmetal	NBLE15
		◇ Black	CU10	◇ Cornsilk	LC30	◇ Harmony	NBLE31
		◇ Espresso	CU49	◇ Dusk	LC22	◇ Harvest	NBLE12
		◇ Fog	CU03	◇ Fawn	LC33	◇ Ice Caves	NBLE32
		◇ Frost	CU22	◇ Graphite	LC34	◇ Icicle	NBLE33
		◇ Goldenrod	CU27	◇ Mist	LC20	◇ Inky	NBLE34
		◇ Indigo	CU06	◇ Neutra	LC24	◇ Iris	NBLE35
		◇ Iris	CU50	◇ Pewter	LC35	◇ Jade	NBLE06
		◇ Iron Ore	CU19	◇ Snowdrop	LC28	◇ Knight	NBLE17
		◇ Jade	CU83			◇ Mesa	NBLE03
		◇ Marsala	CU63			◇ Monarch	NBLE36
		◇ Morel	CU24			◇ Pacific	NBLE08
		◇ Navy	CU98			◇ Pitch	NBLE37
		◇ Peacock	CU97			◇ Queen Bee	NBLE38
		◇ Pear	CU84			◇ Rainforest	NBLE05
		◇ Ruby	CU67			◇ Regal	NBLE11
		◇ Sapphire	CU09			◇ Sandcastle	NBLE39
						◇ Sedona	NBLE40
						◇ Stormy	NBLE16
						◇ Sunbeam	NBLE41
						◇ Voyager	NBLE42
						◇ Windy Day	NBLE43

NOTES: Centurion fabrics not available on panels that exceed a width and height of 54"H.

Disperse is applied pattern cut and is not available on 72"W Accelerate® panels and not available on 66"W tackboards, Voi® screens, and Empower®.

◇◇◇ For lead time information see page 21.

* Directional fabrics

* Fabric is de-emphasized.

PANEL FABRIC PATTERNS & CODES

Scan here to check out our full Chair Fabrics solutions



PRICE CODE A *continued*

REFLECTIONS*	REF
◆ Galvanized	REF29
◆ Ice	REF20
◆ Loggia	REF21
◆ Mistral	REF28
◆ Moonstone	REF23
◆ Pewter	REF22
◆ Stainless	REF24
◆ Vanilla	REF25
◆ Winter	REF27

REFUGE*	RFG
◆ Artesian	RFG96
◆ Dune	RFG92
◆ Eclipse	RFG90
◆ Frost	RFG93
◆ Glacier	RFG91
◆ Mineral	RFG98
◆ Tidal	RFG94

TEMPEST*	TP
◆ Dragonfly	TP30
◆ Frost	TP15
◆ Full Stream	TP80
◆ Gold Rush	TP10
◆ Slate	TP45
◆ Tumbleweed	TP70
◆ Wind Chill	TP40
◆ Zebra	TP35

VAST	VST
◆ Atmosphere	VST06
◆ Bay	VST04
◆ Beach	VST11
◆ Country Side	VST13
◆ Desert	VST12
◆ Garden	VST02
◆ Grasslands	VST03
◆ Highway	VST09
◆ Mountain Range	VST08
◆ Ocean	VST07
◆ Open Air	VST05
◆ Tundra	VST10
◆ Vineyard	VST01

PRICE CODE B

ANALOG	ANLG
<i>Not available on Accelerate*</i>	
◆ Album *	ANLG06
◆ Cartridge *	ANLG04
◆ Cassette *	ANLG09
◆ Dial *	ANLG02
◆ Media *	ANLG08
◆ Reel *	ANLG07
◆ Signal *	ANLG03
◆ Stereo *	ANLG01
◆ Track *	ANLG05

COAST*	COA
<i>Not available on Accelerate*</i>	
◆ Channel	COA14
◆ Dune	COA03
◆ Headlands	COA10
◆ Marsh	COA02
◆ Pebble	COA12
◆ Pier	COA13
◆ Shoal	COA01
◆ Silt	COA06
◆ Tide	COA08

PRICE CODE B *continued*

DISPERSE*	DISP
◆ Autumn	DISP03
◆ Branch	DISP10
◆ Coffee Bean	DISP13
◆ Dusk	DISP09
◆ Emerald City	DISP08
◆ Gold Rush	DISP02
◆ Igloo	DISP11
◆ Ink	DISP06
◆ Mist	DISP12
◆ Oatmeal	DISP15
◆ Prince	DISP07
◆ Reservoir	DISP01
◆ Rose	DISP04
◆ Spring	DISP05
◆ Steel	DISP16
◆ Taupe	DISP14

MICA*	MCA
◆ Anthracite	MCA11
◆ Breeze	MCA18
◆ Bronze	MCA13
◆ Buff	MCA14
◆ Cremini	MCA17
◆ Crystal	MCAWIT
◆ Dew	MCA20
◆ Dove	MCA12
◆ Fresh	MCA16
◆ Mineral	MCA15
◆ Nectar	MCA19
◆ Shale	MCA10

PRICE CODE B *continued*

SPIN*	SPIN
◆ Alabaster	SPIN02
◆ Cavern	SPIN03
◆ Cobblestone	SPIN04
◆ Ember	SPIN06
◆ Flame	SPIN07
◆ Heron	SPIN13
◆ Oat	SPIN01
◆ Ocean	SPIN12
◆ Plum	SPIN15
◆ Pool	SPIN11
◆ Raven	SPIN10
◆ Rhubarb	SPIN14
◆ Tropic	SPIN08
◆ Willow	SPIN05

TERRAIN*	TRRN
◆ Bay	TRRN05
◆ Bayou	TRRN35
◆ Canyon	TRRN30
◆ Cliff	TRRN45
◆ Crest	TRRN25
◆ Delta	TRRN10
◆ Plateau	TRRN15
◆ Ridge	TRRN20
◆ Valley	TRRN40

NOTES: Disperse is applied pattern cut and is not available on 72"W Accelerate® panels and not available on 66"W tackboards, Voi® screens, and Empower®.

◆◆◆ For lead time information see page 21.

* Directional fabrics

* Fabric is de-emphasized.

FEATURES OFFERED ON HON LAMINATE CASEGOODS

	10500	10700	Valido	Concinnity	94000	Voi
Worksurfaces						
• Scratch, stain and spill-resistant surface over durable 1/4" solid core high performance particleboard	•	•		•		•
• Scratch, stain and spill-resistant surface over extra-thick 1/2" solid core high performance particleboard			•			
• Scratch, stain and spill-resistant high gloss surface over durable 1/4" solid core high performance particleboard					•	
• Contoured hardwood accent trim		•			•	
• User-friendly waterfall-shaped edges and rounded corners improves worker comfort		•				
• Edge profile options				•		
Chassis Construction						
• European-designed fastening system – Precision, metal-to-metal, fasteners eliminate need for external cleats or exposed screws; enables tops or end panels to be interchanged or replaced	•	•	•	•	•	•
• Inner frame constructed using mortise and tenon joinery for superior structural strength and precisely positioning/securing the pedestal to the modesty panel; endures frequent moving/handling; ensures a longer product life cycle	•	•	•		•	
• All fasteners and dowels are positioned by computer to maintain rigorous dimensional standards	•	•	•	•	•	•
• End panels on base units and stack-ons feature PVC bottom edgebanding for added strength and to seal out moisture	•	•	•	•	•	•
Drawer Construction						
• Steel ball-bearing drawer suspensions for smooth, quiet, long-lasting operation	•	•	•	•	•	•
• 5-sided drawer construction for added strength and easy alignment or replacement of drawer fronts	•	•	•	•	•	•
• Full extension box and file drawers	•	•	•	•	•	•
• Hangrails provided in all file drawers for side-to-side letter, legal, A4 or EDP filing; and front-to-back for letter filing	•	•	•	•	•	•
Amenities						
• Conference overhang (select models) provides visitor's kneespace on approach side of desk for meetings	•	•	•	•	•	•
• Formal, full height modesty panels	•	•	•	•	•	•
• Short modesty panel option for easy access to wall electrical outlets	•	•	•	•		•
• Patented, side-mounted drawer handles provide good ergonomics and clean appearance	•	•				
• Antique brass drawer handles					•	
• Decorative drawer/door handle design and finish options			•	•		•
• Vertical grain direction on drawer fronts and modesty panels				•	•	•
• Upscale mixed material door options (select models) on overhead storage	•	•	•	•	•	•
• Adjustable hex leveling glides to level furniture without lifting	•	•	•	•	•	•
• Pullout reference/writing shelf provides additional worksurface space					•	
• Interchangeable lock cores (allow multiple units to be keyed alike)	•	•	•	•	•	•
• Central locking on desks (one lock secures all drawers)					•	
• Cord management (standard) to route and hide wires and cables	•	•	•	•	•	
• Cord management options on modular components (worksurfaces, end and modesty panels, pedestals)				•		•
Configuration Options						
• Components for efficient "U" and "L" shaped workstation layouts	•	•	•	•	•	•
• Peninsulas and corner units	•	•	•	•		
• Worksurfaces or shells up to 96"W	•			•		
• Standing, 42"H desking solutions	•			•		•
• Overheads sized to span multiple base units	•	•	•	•	•	•
• Reception station/transaction counter	•	•	•	•	•	
• Light scale styling, including worksurface components with O-leg supports	•			•		•
• Two-tone color options	•		•	•		•
Storage Options						
• 3/4 pedestals provide increased budget flexibility	•	•	•			
• Full desktop-to-floor pedestals maximize storage space	•	•	•	•	•	•
• Modular components/storage with precise, custom cabinet-like fits				•		•
• Modular shells w/ a variety of storage-pedestal solutions	•	•	•			
• Back wall storage in conventional (65") and executive (78") heights				•		
• Overheads, storage cabinets, wardrobes, lateral files, and bookcases	•	•	•	•	•	•
Companion Products						
• Matching conference tables	•			•	•	•
• Coordinating conference tables		•	•			
Endorsements						
• Meets or exceeds current ANSI/BIFMA and ISTA standards	•	•	•	•	•	•
• Meets SCS Indoor Advantage Certification (see page 17)	•	•	•	•	•	•
• level® certified in conformance with the BIFMA e3 furniture sustainability standard	•	•	•	•	•	•

CONCINNITY™

Want to see more? Scan here
to check out hon.com.



Concinnity™ Desking shown with
Ignition® 2.0 and Ruck™ Seating.

CONCINNITY™

Clean styling. Rich woodgrains. Mixed materials. A coordinated suite of components. With Concinnity, you can create an upscale look for all types of office spaces — from open to collaborative to private. Choose from a variety of desk configurations and an extensive selection of storage options to create the ideal solution to fit your footprint and your needs.



FEATURES

- Cohesive visual signature highlighted by clean lines, vertical grain, and components that fit together like custom cabinetry.
- Modular design delivers an unbeatable combination of versatility, style, and personalization to any workspace.
- Wide array of aesthetic options, including edge profiles, handles, mixed materials, and laminate finish combinations.
- Extensive assortment of storage solutions allow users to increase functionality, maximize space and keep everything conveniently within reach.
- Products to create flat, continuous horizontal planes or multi-level, overlapping, layered surfaces.
- Standing-height workstations to support today's healthy work styles; available with adjustable or fixed height bases.

CONCINNITY™ ORDERING INFORMATION

WORKSURFACES

L1 LAMINATES CODES

Woodgrain

- ◆ Bourbon Cherry H
- ◆ Cognac COGN
- ◆ Field Elm LWFE
- ◆ Florence Walnut LFW1
- ◆ Harvest C
- ◆ Kingswood Walnut LK11
- ◆ Mahogany N
- ◆ Mocha MOCH
- ◆ Natural Maple D
- ◆ Pinnacle PINC
- ◆ Shaker Cherry F
- ◆ Sterling Ash LSA1

Solid

- ◆ Black P
- ◆ Charcoal S
- ◆ Designer White LDW1
- ◆ Loft LOFT

Patterned

- ◆ Silver Mesh B9

L2 LAMINATES CODES

Woodgrain

- ◆ Beigewood LWBE
- ◆ Fawn Cypress LFC1
- ◆ Lowell Ash LLA1
- ◆ Natural Recon LNR1
- ◆ Phantom Ecru LPE1
- ◆ Portico Teak LPT1
- ◆ Skyline Walnut LSW1

DRAWER AND DOOR FRONTS

L1 LAMINATES CODES

Woodgrain

- ◆ Bourbon Cherry H
- ◆ Cognac COGN
- ◆ Field Elm LWFE
- ◆ Florence Walnut LFW1
- ◆ Harvest C
- ◆ Kingswood Walnut LK11
- ◆ Mahogany N
- ◆ Mocha MOCH
- ◆ Natural Maple D
- ◆ Pinnacle PINC
- ◆ Shaker Cherry F
- ◆ Sterling Ash LSA1

Solid

- ◆ Black P
- ◆ Charcoal S
- ◆ Designer White LDW1
- ◆ Loft LOFT

L2 LAMINATES CODES

Woodgrain

- ◆ Beigewood LWBE
- ◆ Fawn Cypress LFC1
- ◆ Lowell Ash LLA1
- ◆ Natural Recon LNR1
- ◆ Phantom Ecru LPE1
- ◆ Portico Teak LPT1
- ◆ Skyline Walnut LSW1

HANDLE/LOCK

FINISHES CODES

P1

- ◆ Black P
- ◆ Satin SA

CHASSIS, END, MODESTY, AND BACK PANELS

L1 LAMINATES CODES

Woodgrain

- ◆ Bourbon Cherry H
- ◆ Cognac COGN
- ◆ Field Elm LWFE
- ◆ Florence Walnut LFW1
- ◆ Harvest C
- ◆ Kingswood Walnut LK11
- ◆ Mahogany N
- ◆ Mocha MOCH
- ◆ Natural Maple D
- ◆ Pinnacle PINC
- ◆ Shaker Cherry F
- ◆ Sterling Ash LSA1

Solid

- ◆ Black P
- ◆ Charcoal S
- ◆ Designer White LDW1
- ◆ Loft LOFT

L2 LAMINATES CODES

Woodgrain

- ◆ Beigewood LWBE
- ◆ Fawn Cypress LFC1
- ◆ Lowell Ash LLA1
- ◆ Natural Recon LNR1
- ◆ Phantom Ecru LPE1
- ◆ Portico Teak LPT1
- ◆ Skyline Walnut LSW1

HMBPOST AND HMBTLEG24

PAINTS CODES

P1

- ◆ Black P
- ◆ Cove P096
- ◆ Dune P094
- ◆ Harbor P097
- ◆ Sage P095

P2

- ◆ Platinum Metallic T1

SILVER COLORWAY: The following finish options are coordinating silver colorways — Satin, Satin Nickel, Matte Chrome, Platinum, and Platinum Metallic.

EDGE PROFILES “B” AND “V”

EDGEBAND COLORS CODES

Woodgrain

- ◆ Beigewood DE
- ◆ Bourbon Cherry H
- ◆ Cognac COGN
- ◆ Fawn Cypress FC
- ◆ Field Elm FE
- ◆ Florence Walnut FW
- ◆ Harvest C
- ◆ Kingswood Walnut KI
- ◆ Mahogany N
- ◆ Mocha MOCH
- ◆ Natural Maple D
- ◆ Pinnacle PINC
- ◆ Shaker Cherry F
- ◆ Sterling Ash SA

EDGE PROFILE “G”

EDGEBAND COLORS CODES

Woodgrain

- ◆ Beigewood DE
- ◆ Bourbon Cherry H
- ◆ Cognac COGN
- ◆ Fawn Cypress FC
- ◆ Field Elm FE
- ◆ Florence Walnut FW
- ◆ Harvest C
- ◆ Kingswood Walnut KI
- ◆ Lowell Ash DL
- ◆ Mahogany N
- ◆ Mocha MOCH
- ◆ Natural Maple D
- ◆ Natural Recon NR
- ◆ Phantom Ecru PE
- ◆ Pinnacle PINC
- ◆ Portico Teak DP
- ◆ Shaker Cherry F
- ◆ Skyline Walnut SW
- ◆ Sterling Ash SA

Solid

- ◆ Black P
- ◆ Brownstone EY
- ◆ Charcoal S
- ◆ Designer White DW
- ◆ Fossil EH
- ◆ Loft LOFT

Pattern laminates do not have a matching edgeband color; they are available with a woodgrain or solid color edge.

◆◆◆ For lead time information see page 21.

CONCINNITY™ Statement of Line

DESKS

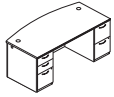

Double Pedestal, Bow Top, Recessed Modesty

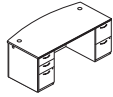

Double Pedestal, Bow Top, Breakfront Modesty

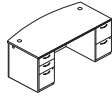

Double Pedestal, Bow Top, Breakfront Frosted Modesty

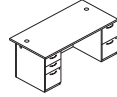

Double Pedestal, Rectangle Top, Recessed Modesty

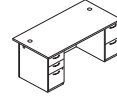

Double Pedestal, Rectangle Top, Flush Modesty

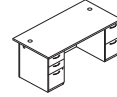

Double Pedestal, Rectangle Top, Breakfront Modesty

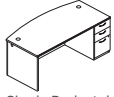

Single Pedestal, Bow Top, Recessed Modesty

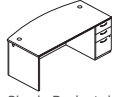

Single Pedestal, Bow Top, Breakfront Modesty

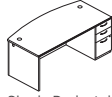

Single Pedestal, Bow Top, Breakfront Frosted Modesty

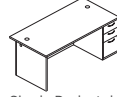

Single Pedestal, Rectangle Top, Recessed Modesty



Single Pedestal, Rectangle Top, Flush Modesty



Single Pedestal, Rectangle Top, Breakfront Modesty

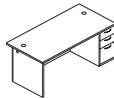

Single Pedestal, Rectangle Top, Breakfront Frosted Modesty



Bullet Peninsula with End Panel



Jetty Peninsula with End Panel



Corner Unit

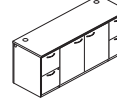

Credenza with Storage

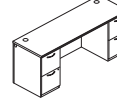

Credenza with Kneespace

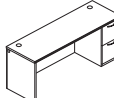

Credenza, Single Pedestal

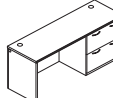

Credenza with Lateral File

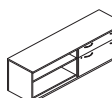

Low Credenza, Bench-Height

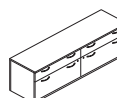

Low Credenza, 2 Box/2 File

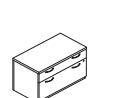

Low Credenza, Box/File

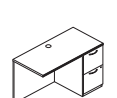

Return



Bridge



Reception Desk, Transaction Counter



Reception Return, Transaction Counter

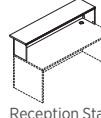

Reception Station Counter for Desk

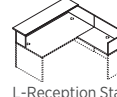

L-Reception Station, Transaction Counter for Desk

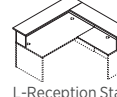

L-Reception Station, Transaction Counter for Desk and Return

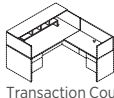

Transaction Counter Organizer



2-Leg Height Adjustable Base



3-Leg Height Adjustable Base

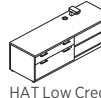

HAT Low Credenza

STORAGE



Lateral File



Mobile Pedestal, 15"W



Mobile Pedestal, 30"W

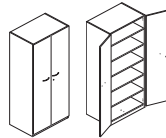

Storage Cabinet, Laminate Doors

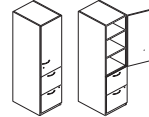

Storage/File Cabinet

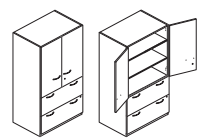

Storage Cabinet/Lateral File, Laminate Doors

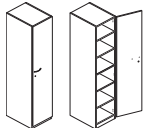

Wardrobe/Storage Cabinet, 18"W

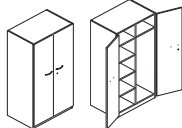

Wardrobe/Storage Cabinet, 36"W

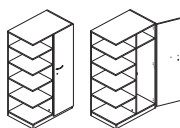

Wardrobe/Bookcase, Laminate Door

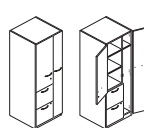

Storage Tower with Laminate Doors, 24"W

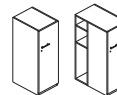

Storage Tower with Laminate Doors, 50"H



Bookcase with Adjustable Shelves

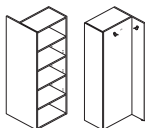

Bookcase with Coat Hooks

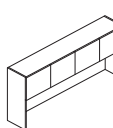

Stack-On Storage, 35 1/4"H, Laminate Doors

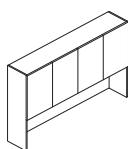

Stack-On Storage, 48 5/8"H, Laminate Doors

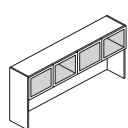

Stack-On Storage, 35 1/4"H, Frosted Doors

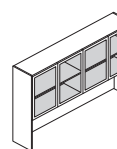

Stack-On Storage, 48 5/8"H, Frosted Doors

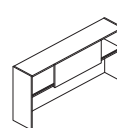

Stack-On Storage, 35 1/4"H, Sliding Door

STORAGE *continued*

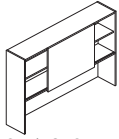

Stack-On Storage, 48 $\frac{3}{4}$ "H,
Sliding Door

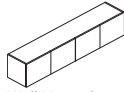

Wall Mount Storage, 15"H,
Laminate Doors

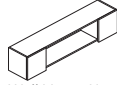

Wall Mount Hutch, 15"H,
Laminate Doors

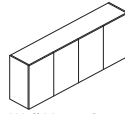

Wall Mount Storage, 28 $\frac{1}{2}$ "H,
Laminate Doors

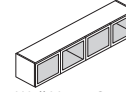

Wall Mount Storage, 15"H,
Frosted Doors

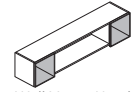

Wall Mount Hutch, 15"H,
Frosted Doors

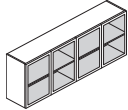

Wall Mount Storage, 28 $\frac{1}{2}$ "H,
Frosted Doors

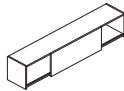

Wall Mount Storage, 15"H,
Sliding Door

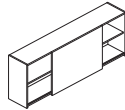

Wall Mount Storage, 28 $\frac{1}{2}$ "H,
Sliding Door

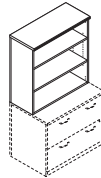

Bookcase Hutch, Open

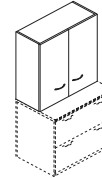

Bookcase Hutch, Laminate
Doors

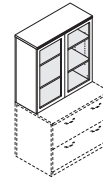

Bookcase Hutch, Frosted
Doors

WORKSURFACES/SUPPORTS

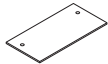

Rectangle Worksurface,
Horizontal Grain



Rectangle Worksurface,
Vertical Grain



Bow Worksurface



Bullet Worksurface



Wedge Worksurface



Blade Worksurface



P-Shaped Worksurface



Extended Corner Worksurface



O-Leg



Double-Depth O-Leg



O-Leg Shared Support



Standing-Height O-Leg

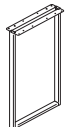

Standing-Height O-Leg
Shared Support



O-Leg Support for Low
Credenzas



Support Column



Post Leg Base



Fixed Height T-Leg Base



Box/Box/File Support
Pedestal



File/File Support Pedestal



Narrow Box/Box/File Support
Pedestal



Narrow File/File Support
Pedestal



Lateral File Support Pedestal



Box/Box/File/File Support
Pedestal



Shelf/Box/Box/File Support
Pedestal



Narrow Box/Box/File/File
Support Pedestal



Shelf/Box/Box/Lateral File
Support Pedestal



Storage Cabinet Support
Pedestal



Bookcase Support Pedestal



Bookcase End Support



Laminate End Panel



Credenza Stanchion

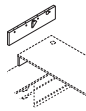

Laminate End Panel for
Worksurface



Laminate L-Shaped End Panel



Laminate T-Shaped End Panel

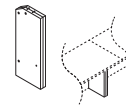

Kneespace Clearance End
Panel

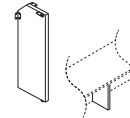

Support Brace



External Support Channel



Worksurface Wall Mount
Bracket



Worksurface to Tower Bracket
Kit

CONCINNITY™ Statement of Line

ACCESSORIES

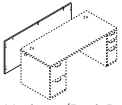

Modesty/Back Panel, Full-Length

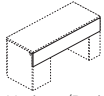

Modesty/Back Panel, Short



Full Width/Half-Height Laminate Modesty Panel

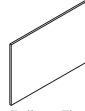

Full-to-Floor/Full-Length Laminate Modesty Panel



Modesty Panel for Desks with O-Legs



Laminate Floating Modesty Panel



Mixed Material Floating Modesty Panel



Shroud for Height Adjustable Base



Above/Below Privacy Screen



Above Privacy Screen



Above/Side Frosted Polymer Privacy Screen



Above/Side Frosted Glass Privacy Screen



Field Installable Modesty Panel, Laminate



Field Installable Modesty Panel, Frosted



Tackboards for Stack-On/Wall Mount Storage

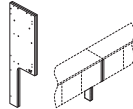

Stack-On Space Saver End Panel



Mobile Pedestal Cushion

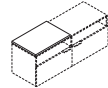

Credenza Cushion

STYLING AND CONSTRUCTION

- Conventional desking or light scale components.
- Clean, uninterrupted lines and precise fits; no gaps.
- All end, modesty, and back panels, as well as drawer and door fronts, that are specified in a woodgrain color, feature vertical grain; drawer fronts are vertically-aligned, continuous grain and are matched sets.
 - Modesty panels wider than 60" have horizontal grain on L2 and non-standard finishes.
- All desk, credenza, and return models feature full-to-the-floor pedestals to maximize storage space.
- Factory-configured (i.e., built-up; assembled) 72"W desks can be specified with breakfront or recessed modesty panels.
- Formal, full height modesty panels on factory-configured (i.e., built-up; assembled) desks, credenzas, and returns; modular components available with full or 10" modesty panels.
- Drawer and door fronts over end panels.
- Back panel-over-end panel on desks, credenzas, returns, mobile pedestals, 29½"H lateral files and storage cabinets, and full-length modesty panels for modular pedestals.
- Top-between-end panels on stack-on and wall mount storage, 66⅝"H & 79½"H storage and combination storage cabinets, wardrobes and towers.
- Option choices include:
 - Edge profile and edge color
 - Handle design
 - Handle/worksurface grommet/lock face finish
 - Worksurface color
 - Chassis color
 - Drawer front/door color
- **IMPORTANT NOTE:** Designed and sized to coordinate with 65"H Accelerate® Panels.
 - Desks, credenzas, returns, 2-drawer lateral files, and 29½"H storage cabinets, plus 35¼"H stack-on storage or bookcase hutch, are 64¾"H.
 - Additional solutions ≤65"H include the following: storage cabinet, storage/file cabinet, storage cabinet/lateral file, 18" and 36"W wardrobe/storage cabinets, wardrobe/bookcase, storage tower, and 5-shelf bookcase.

MATERIALS

- Easy-care, scratch-, spill- and stain-resistant thermal-fused laminate (TFL) over solid core, high performance particleboard;
 - Component model thickness: 1⅛" worksurfaces and end panels; ¾" modesty panel and drawer/door fronts.

- Durable, impact-resistant banding protects edges.
- Bottom of end panels on base units and stack-ons feature edgebanding for added strength and to seal out moisture.
- HPL worksurfaces are available via special request.

DRAWER SPECIFICATIONS

- Operate on steel ball-bearing slides to ensure smooth, quiet, long-lasting operation.
- Full extension drawers allow complete access to contents.
- Drawers feature 5-sided construction for added strength and easy alignment or replacement of drawer fronts.
- File drawers include integrated handrails for side-to-side letter or legal filing; and front-to-back for letter filing.
- One molded black pencil tray is included in each box/box/file pedestal.
- Drawer fronts are edgebanded on all four sides.

CORE REMOVABLE LOCKS

- All drawers/doors lock on the following products:
 - All desk, credenza, and return pedestals (NOTE: The lock is on the face of the pedestal)
 - Stack-on and wall mount storage with laminate locking doors ("LL" models)
 - Wall mount storage with sliding door
 - Mobile pedestals
 - Lateral files
 - Storage cabinets
 - Storage/file cabinet
 - Storage cabinet/lateral file
 - Wardrobe/storage cabinets
 - Storage towers
 - Modular pedestals
- On products that are equipped with two locks, the locks are keyed alike:
 - Double pedestal desks
 - Credenza with storage
 - Credenzas with kneespace
 - Low credenzas with four drawers
 - Storage and combination storage/file cabinets
 - Storage towers
 - Stack-on and wall mount storage 60" - 78"W
- Lock faces are available in black or satin.

CONCINNITY™

LAMINATE DESIGN/MATERIALS INFORMATION

- Locks feature a removable cylinder (core) that can be interchanged as needed; allows all furniture pieces within an individual workstation to be accessed with one key for convenience, and allows locks to be differentiated between workstations and offices for security. Makes re-keying quick and easy.
 - Keyed alike cores must be ordered separately by specification of the key number. For all products, except stack-on and wall mounted storage, the removable lock core kits are HF23B for Black and HF23S for Satin (Silver).
 - EXCEPTION - IMPORTANT - NOTE: The removable lock core kit for stack-on and wall mounted storage is model HF27B (Black) or HF27S (Satin).

CORD MANAGEMENT

- Cord management grommets and pass-through cutouts, for routing and hiding wires and cables, are standard in a pre-determined location on a number of factory-configured (i.e., built-up; assembled) products:
 - Two grommets are located in the tops of desks and credenzas; one grommet is located in the top of returns, bridges, jetty peninsulas, and corner units.
 - All desk, credenza, and return pedestals are designed with two cord pass-through grommets, one per side; end panels of single pedestal desks and single pedestal credenzas feature one cord pass-through grommet.
 - Pass-through in the sides of pedestals and end panels enable the routing of cords below the worksurface and connections between workstations.
 - A pass-through grommet, to facilitate reaching wall electrical outlets, is located in the back panels of credenza with storage, credenza with kneespace, single pedestal credenzas, credenzas with 36" lateral file, returns and bridges.
- See chart on page 48 for cord management options. Worksurfaces/tops, end and modesty panels, and pedestals can be specified with or without grommets.
- Grommets on worksurfaces are sized to accept optional grommet mount power hub (HGRMTAC) and USB (HGRMTUSB2) models.

- Grommet color/shape/size:
 - Worksurfaces, Black or Platinum, Round, 3" diameter hole with a 3½" plastic cap.
 - Back/modesty panels, Black, Round, 2½" diameter hole with a 3" plastic cap.
 - End panels and pedestal sides, Black, Half-round, 1¾" diameter hole with a 2" x 2½" plastic cap.

LEVELING GLIDES

- Adjustable hex glides to compensate for uneven floors; allow furniture to be easily leveled without lifting the unit.
 - Glides have a ¼" adjustable range.
 - The hex adjustment is on the foot of the glide for all products except for the 9½", 15¾", and 18"W modular pedestals, in which case it is on the top of the glide stem.









IMPORTANT — OTHER

- Products ship fully assembled, unless otherwise noted (NOTE:  — easy-to-assemble — items are designated in the "DESCRIPTIONS").
- All models must meet or exceed ANSI/BIFMA & ISTA performance standards.
- Products covered by HON Limited Lifetime Warranty.
- Indoor Advantage™ Gold. Indoor Air Quality Certified to SCS-EC10.3-2014 v3.0.
- BIFMA level® 2 certified. Conforms to ANSI/BIFMA e32014e Furniture Sustainability Standard.

CONCINNITY™ LAMINATE DESIGN/MATERIALS INFORMATION

WORKSURFACE/TOP EDGE DETAILS

- Three options; two contoured profiles and one smooth, flat edge.
- For beaded (B) and tri-oval (V) edge shapes, tops are profiled on the user and approach sides, and flat on the ends; the flat edges allow side-by-side placement of worksurfaces without gaps. The only exceptions are return, bridge, corner unit, extended corner worksurface, and rectangle worksurface with vertical grain models, tops on these items are profiled on the user's side and flat banded on the approach side and ends.
 - Bookcases have profiled edge on the front, user side only.
 - The reception station transaction counter and the L-reception station with transaction counter (for the desk) models, have profiled edgeband on the approach and user sides.
 - The L-reception station with the transaction counter models, on which the counter runs around the entire perimeter of the L-configuration, have a profiled edge on the front of the transaction counter on the desk approach side only.

Edge Options:	Profiles	Designator
Beaded	 	B
Smooth, Flat	 	G
Tri-Oval	 	V
T-Mold	 	T

WORKSURFACE EDGE COLORS

- Woodgrain and solid color laminates can be specified with a matching, complementary, or contrasting edgeband color; options include:
 - Matching the worksurface edge to a common worksurface, chassis, and drawer front color.
 - Matching the worksurface edge to the worksurface laminate and selecting a different laminate color for the chassis.
 - Matching the worksurface edge to the chassis laminate and selecting a different laminate color for the worksurface.

- Beaded (B) and tri-oval (V) edges are available in L1 woodgrain colors only.
- The smooth, flat (G) edge is available in woodgrain and solid colors.
- Pattern laminates do not have a matching edgeband color; the patterns are available with a woodgrain or solid color edge.

DRAWER/DOOR DECORATIVE HANDLES

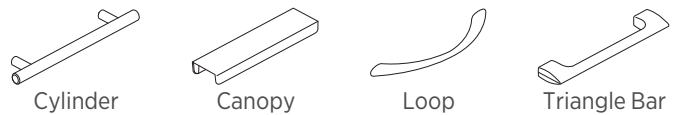

- Four handle style options.
- Distinct, easy to grasp designs.
- Handles are metal.
- The hole spacing is 128mm.
- The handle style/finish has to be specified on drawer fronts (desk/credenza/return, mobile and modular pedestals), lateral file drawer fronts, the doors of the storage cabinet, storage/file cabinet, storage cabinet/lateral file, wardrobe/storage cabinet, wardrobe/bookcase, and storage tower.
 - NOTE: Decorative handles are not used on the doors of stack-on storage units or wall mounted storage cabinets.
 - Bookcase hutches with frosted doors are equipped with a push latch release.

Handle Style	Handle Color	Lock Color	Code
Cylinder	Satin	Satin	A
Cylinder	Black	Black	B
Canopy	Satin	Satin	C
Canopy	Black	Black	D
Loop	Satin	Satin	E
Loop	Black	Black	F
Triangle Bar	Black	Black	G
Triangle Bar	Designer White	Satin	H
Triangle Bar	Champagne Metallic	Satin	I
Triangle Bar	Platinum Metallic	Satin	J
Triangle Bar	Silver	Satin	K
Triangle Bar	Solar Black	Black	L
Triangle Bar	Pyrite	Black	M

- NOTE: The Linear and Arch field installable drawer/door handle kit models can be attached using 128mm hole spacing.

CONCINNITY™

LAMINATE ORDERING/SPECIFICATION INFORMATION

CORD MANAGEMENT GROMMETS

- Grommets are standard on desk, credenza, return, bridge, jetty peninsula, and corner unit models. Specification logic includes the grommet finish for tops; choose from Black (P) or Platinum (T1). Grommets in modesty and end panels are Black only.
- Grommets are optional on modular component worksurfaces, full-length (27⁷/₈"H) modesty panels, end panels (1¹/₈", L-shaped) and the sides of support storage pedestals. On worksurfaces, choose from Black (P), Platinum (T1), or no grommet(s) (X). On modesty, end, and side panels the options are grommet Black (P) or no grommet (X).
- See cord management chart on page 48 for details.

LOCK FINISH

- Finish is determined by, and automatically aligned with, the handle finish specified. If there is no decorative handle on the product, such as on locking stack-on or wall mount storage models, the lock finish is specified separately in the option string.
 - When specification is required, the lock finish options are Black (P) or Satin (SA).
- Removable, interchangeable lock core kits must be ordered separately:
 - For all models, except stack-on and wall mount storage, specify model HF23B (Black) or HF23S (Satin), and the specific key number required.
 - For stack-on and wall mount storage, specify model HF27B (Black) or HF27S (Satin), and the specific key number required.

SILVER COLORWAY

- The following finish options are coordinating Silver colorways: Satin, Satin Nickel, Matte Chrome, Platinum, and Platinum Metallic.

LAMINATE COLORS

- Palette choices include nineteen (19) woodgrain, four (4) solid, and one (1) pattern colors.

Woodgrain		Solid Color		Pattern
Beigewood	LWBE	Black	P	Silver Mesh B9
Bourbon Cherry	H	Charcoal	S	
Cognac	COGN	Designer White	LDW1	
Fawn Cypress	LFC1	Loft	LOFT	
Field Elm	LWFE			
Florence Walnut	LFW1			
Harvest	C			
Kingswood Walnut	LK11			
Lowell Ash	LLA1			
Mahogany	N			
Mocha	MOCH			
Natural Maple	D			
Natural Recon	LNR1			
Phantom Ecru	LPE1			
Pinnacle	PINC			
Portico Teak	LPT1			
Shaker Cherry	F			
Skyline Walnut	LSW1			
Sterling Ash	LSA1			

- Worksurface, chassis and drawer/door fronts are specified separately to enable a single, color-matched visual, or a complementary or contrasting, multi-tone aesthetic.
- Worksurfaces/tops are available in woodgrain, solid, or pattern laminate colors.
- Chassis and drawer fronts are available in woodgrain or solid laminate colors.
- Pattern colors are available on worksurface tops only.

Worksurface		Chassis		Drawer/Door	
Beigewood	LWBE	Beigewood	LWBE	Beigewood	LWBE
Bourbon Cherry	H	Bourbon Cherry	H	Bourbon Cherry	H
Cognac	COGN	Cognac	COGN	Cognac	COGN
Fawn Cypress	LFC1	Fawn Cypress	LFC1	Fawn Cypress	LFC1
Field Elm	LWFE	Field Elm	LWFE	Field Elm	LWFE
Florence Walnut	LFW1	Florence Walnut	LFW1	Florence Walnut	LFW1
Harvest	C	Harvest	C	Harvest	C
Kingswood Walnut	LK11	Kingswood Walnut	LK11	Kingswood Walnut	LK11
Lowell Ash	LLA1	Lowell Ash	LLA1	Lowell Ash	LLA1
Mahogany	N	Mahogany	N	Mahogany	N
Mocha	MOCH	Mocha	MOCH	Mocha	MOCH
Natural Maple	D	Natural Maple	D	Natural Maple	D
Natural Recon	LNR1	Natural Recon	LNR1	Natural Recon	LNR1
Phantom Ecru	LPE1	Phantom Ecru	LPE1	Phantom Ecru	LPE1
Pinnacle	PINC	Pinnacle	PINC	Pinnacle	PINC
Portico Teak	LPT1	Portico Teak	LPT1	Portico Teak	LPT1
Shaker Cherry	F	Shaker Cherry	F	Shaker Cherry	F
Skyline Walnut	LSW1	Skyline Walnut	LSW1	Skyline Walnut	LSW1
Sterling Ash	LSA1	Sterling Ash	LSA1	Sterling Ash	LSA1
Black	P	Black	P	Black	P
Charcoal	S	Charcoal	S	Charcoal	S
Designer White	LDW1	Designer White	LDW1	Designer White	LDW1
Loft	LOFT	Loft	LOFT	Loft	LOFT
Silver Mesh	B9				

- Two-tone color options allow specification of different, complementary laminate combinations:

Color #1	Color #2
Top	Chassis and Drawer Fronts
Top and Drawer Fronts	Chassis
Top and Chassis	Drawer Fronts

- Modesty panels and the backs of storage chassis that are specified in L2 laminates and wider than 60"W will ship as horizontal grain.

CONCINNITY™ STACK-ON STORAGE APPLICATIONS

STACK-ON STORAGE APPLICATIONS

78"W

- Spans full-width of 78"W modular credenza or return.
- Spans total depth dimension of "L" workstation configurations comprised of:
 - 48"W return or modular return attached to a 36"D single pedestal desk with a bow front (78"D).
 - NOTE: The 36"D single pedestal desk with bow front is 30"D along end panel.
 - 48"W return or modular return attached to a 30"D single pedestal desk, modular desk, or bullet peninsula (78"D).
 - 42"W return or modular return attached to a 36"D single pedestal desk with rectangle top, modular desk, or bullet peninsula (78"D).
 - 42"W return or modular return attached to a 36" corner unit or 36"D extended corner unit (78"D).
 - 36"W modular return attached to a 42"D jetty peninsula (78"D).
 - 30"W modular return attached to a 48"D jetty peninsula (78"D).
 - 30"W modular return attached to a 48"D extended corner unit (78"D).

72"W

- Spans full-width of 72"W desks with rectangle top, credenzas, extended corner units, or modular desk, credenza, or return.
- Spans total depth dimension of "L" workstation configurations comprised of:
 - 48"W return or modular return attached to a 24"D single pedestal credenza or modular credenza (72"D).
 - 42"W return or modular return attached to a 36"D single pedestal desk with a bow front (72"D).
 - NOTE: The 36"D single pedestal desk with bow front is 30"D along end panel.
 - 42"W return or modular return attached to a 30"D single pedestal desk, modular desk, or bullet peninsula (72"D).
 - 36"W modular return attached to a 36"D single pedestal desk with rectangle top, modular desk, or bullet peninsula (72"D).
 - 36"W modular return attached to a 36" corner unit or 36"D extended corner unit (72"D).
 - 30"W modular return attached to a 42"D jetty peninsula (72"D).

66"W

- Spans full-width of 66"W desk, credenza, or modular desk, credenza, or return.
- Spans total depth dimension of "L" workstation configurations comprised of:
 - 42"W return or modular return attached to a 24"D single pedestal credenza or modular credenza (66"D).

- 36"W modular return attached to a 30"D single pedestal desk, bullet peninsula, or modular desk (66"D).
- 36"W modular return attached to a 36"D single pedestal desk with a bow front (66"D).
 - NOTE: The 36"D single pedestal desk with bow front is 30"D along end panel.
- 30"W modular return attached to a 36"D single pedestal desk with rectangle top or modular desk (66"D).
- 30"W modular return attached to a 36" corner unit (66"D).

60"W

- Spans full-width of 60"W desk, credenza, or modular desk, credenza, or return.
- Spans total depth dimension of "L" workstation configurations comprised of:
 - 36"W modular return attached to a 24"D single pedestal credenza or modular credenza (60"D).
 - 30"W modular return attached to a 30"D single pedestal desk or modular desk (60"D).

48"W

- Spans full-width of 48"W return, modular return, or modular desk or credenza.
- Spans full-depth of the 48"D jetty peninsula or extended corner unit.

42"W

- Spans full-width of 42"W return, modular return, or modular desk or credenza.
- Spans full-depth of 42"D jetty peninsula.

36"W

- Spans full-width of 36"W modular return, modular desk or credenza, two drawer lateral file, or 29½"H storage cabinet with doors.
- Spans full-depth of 36"D desks with rectangle top, bullet peninsula, extended corner unit, or 36" corner unit.

OPTIONS INCLUDE:

- Door/Storage Options:

Door(s)	Standard-Height	Executive-Height
Laminate	•	•
Laminate Locking	•	•
Frosted/Silver	•	•
Sliding	•	•

- Available in 35¼" or 78⅛"H; when positioned on 29½"H base unit, heights respectively align with 64¾" and 78⅛"H storage- and wardrobe-type cabinets.
- Paper organizers for stack-on and wall mounted storage cabinets (see application and compatibility information on page 47).

CONCINNITY™ STACK-ON STORAGE APPLICATIONS

- Fabric-Covered Tackboards:
 - Sized $\frac{3}{4}$ " narrower than the stack-on storage back enclosure, allowing $\frac{3}{8}$ " on each side to route task light cords.
 - Includes adhesive latch & hook tape for attachment to stack-on storage back panel and fasteners for wall mount applications.
 - For a list of standard fabrics, see pages 25-26. For a complete list of fabrics, please go to hon.com/fabricsandfinishes.
- Markerboards:
 - HLSL1530SOMB: 29½"W x 12½"H panel attaches to 60" and 66"W stack-on and wall mounted storage with sliding door models with double-sided tape.
 - HLSL1536SOMB: 35½"W x 12½"H panel attaches to 72" and 78"W stack-on and wall mounted storage with sliding door models with double-sided tape.
- Markerboards will not fit on stack-on storage laminate or laminate locking door models.
- Task Lights:
 - Attach to underside of stack-on and wall mount storage cabinets.
 - LED options.
 - Tackboard and LED task light solutions, by model, for each stack-on storage size:

Stack-on Storage	Tackboard	LED Task Lights
78"W	H90057	HH870960, HH870960CH, HLED31A, HLED31AUO
72"W	H90056	HH870960, HH870960CH, HLED31A, HLED31AUO
66"W	H90055	HH870960, HH870960CH, HLED31A, HLED17AUO
60"W	H90054	HH870960, HH870960CH, HLED31A, HLED17AUO
48"W	H90053	HH870942, HH870942CH, HLED31AS
42"W	H90052	HH870942, HH870942CH, HLED31AS
36"W	H90051	HH870930, HH870930CH, HLED17AS

CONCINNITY™ WALL MOUNT STORAGE APPLICATIONS

- Installation (review carefully):
 - **Attachment requires individual cabinets be secured by a minimum of two (2) wall mounting locations/studs.**
 - **Designed for interior and perimeter walls that are constructed with wood or metal studs.**
 - **Attaches to wall with horizontally mounted, interlocking brackets.**
 - **The HON Company is not responsible for any liabilities resulting from wall mounted storage cabinets that are not properly installed.**
- Laminate, laminate locking, and frosted/silver door units can be specified in eight widths (30", 36", 42", 48", 60", 66", 72", and 78"W) and two heights, standard (15"H) or executive (29½"H).
- Sliding door units can be specified in five widths (48", 60", 66", 72", and 78"W) and two heights, standard (15"H) or executive (29½"H).
- Product placement can be aligned to match the height of 64¾"H or 78⅛"H storage- and wardrobe-type cabinets.
- Available with laminate doors, frosted/silver doors, or sliding door.
 - Door design overlaps end panels so that when multiple units are placed side-by-side they appear as one continuous unit.
 - Laminate and frosted/silver door units are equipped with self-closing, adjustable hinges.
 - Laminate hinged door units are available with or without a lock.
 - Lock available in Black (P) or Satin (SA).
 - Lock is core removable; keyed alike cores must be ordered separately — for overhead storage with hinged doors specify model HF27B or HF27S and the key number.
 - Frosted/silver hinged door units do not have a lock option.
 - Sliding door units have one door per cabinet; standard with black lock, which is located on inside vertical support panel. Lock is core removable; keyed alike cores must be ordered separately — for overhead storage with a sliding door specify model HF23B (Black) and the key number.
 - Laminate and frosted/silver door cabinets in 30", 36", and 42"W have two doors; 48"W has three doors; 60", 66", 72", and 78"W have four doors.
- Inside storage dimensions of 15"H cabinets:
 - 30"W = one compartment, sized 28⅜"W x 13⅜"D x 12¾"H
 - 36"W = one compartment, sized 34⅜"W x 13⅜"D x 12¾"H
 - 42"W = one compartment, sized 40⅜"W x 13⅜"D x 12¾"H
 - 48"W = two compartments, one sized 30⅝"W x 13⅜"D x 12¾"H; one sized 14⅝"W x 13⅜"D x 12¾"H
 - 60"W = two compartments, each 28⅝"W x 13⅝"D x 12¾"H
 - 66"W = two compartments, each 31⅝"W x 13⅝"D x 12¾"H
 - 72"W = two compartments, each 34⅝"W x 13⅝"D x 12¾"H
 - 78"W = two compartments, each 37⅝"W x 13⅝"D x 12¾"H
- 28½"H units have a fixed, intermittent shelf; storage space above and below the shelf is 12⅝".
- Wall mounted storage cabinets are not designed for attachment to O-leg models HL650S or HL500S.
- Horizontal interlocking rails are included; due to varying types of walls, installers are responsible for selecting and supplying the appropriate fasteners.
- Ship fully assembled.

CONCINNITY™ WALL MOUNT STORAGE APPLICATIONS

OPTIONS INCLUDE:

- Door/Storage Options:

Door(s)	Standard-Height	Executive-Height
Laminate	•	•
Laminate Locking	•	•
Frosted/Silver	•	•
Sliding	48"-78"W only	48"-78"W only

- Paper organizers for stack-on and wall mounted storage cabinets (see compatibility information on page 47).
- Fabric-Covered Tackboards:
 - Tackboards mount directly to wall using the fasteners or hook-and-loop tape provided.
 - For a list of standard fabrics, see pages 25-26. For a complete list of fabrics, please go to hon.com/fabricsandfinishes.
 - See compatibility cross reference below.
 - NOTE: Tackboard widths differ slightly from the wall mounted storage cabinet widths. For applications where multiple wall mounted storage units are placed side-by-side, the preferred tackboard solution may be to utilize a larger tackboard size.
For example, H90057 = 75"W; H90056 = 69"W;
H90055 = 63"W; H90054 = 57"W.
- Markerboards:
 - HL1530SOMB: 29½"W x 12½"H panel attaches to 60" and 66"W stack-on and wall mounted storage with sliding door models with double-sided tape.
 - HL1536SOMB: 35½"W x 12½"H panel attaches to 72" and 78"W stack-on and wall mounted storage with sliding door models with double-sided tape.

MODULAR COMPONENTS

- Smart, adaptable, reconfigurable assortment to maximize office layout flexibility and optimize floor space.
- Components for all popular office layouts.
- Selection allows user to choose their own workstation shape, size, and storage.
- Sizes for large and small spaces:
 - 36"D x 72"W or 84"W
 - 30"D — six sizes up to 84"W
 - 24"D — in 6" increments, from 30"W to 96"W
- Worksurfaces supported by post legs with casters provide added layout flexibility.
- Mobile desks quickly convert an office into a small conference space; desks roll easily and can be repositioned in seconds.
- Grommet options provide cord management from the top, side, and back in appropriate models.
- Broad menu of under-surface storage to enable user to specify the solution that best meets their individual needs.
 - Non-handed units can be configured to meet individual tastes and reconfigured when preferences or floor space requirements change.
 - Applications include:
 - The ability to “build” contiguous customized/personalized storage behind the desk that looks like custom architectural millwork, but at a fraction of the price. Allows for multiple storage pedestals to be configured under a single top with clean lines and no gaps.
 - Choosing the storage solution to go under desks, credenzas, and returns.

WORKSURFACES

- Available in a variety of shapes and sizes.
- Scratch-, stain-, and spill-resistant laminate over durable 1½" solid core high performance particleboard; resists warping.
- An external support channel, for attachment under worksurfaces, is required for all unsupported spans — a distance in which there is not a vertical support (point of contact) between the underside of the worksurface and the floor — greater than 54"W.
- For tri-oval and beaded edge options on tops with horizontal grain, there is a shaped profile on the user and approach sides, and a flat edge on the ends.
- For tri-oval and beaded edge options on tops with vertical grain, there is a shaped profile on the user side and a flat edge on the approach side and the ends.
- Grommets are an option and require specification. If grommets are selected, grommets come in a pre-determined location.

- Must be specified with support components; for pedestal, end panel, column, and leg options, see “Components — Supports” listings.

SUPPORTS

- For use with rectangle, bow, bullet, and extended corner worksurfaces.
- Available in 28½" and 41"H.
- Adjustable hex glides allow floor-standing units to be easily leveled, without lifting, to compensate for uneven floors; glides have 1¼" adjustable range on most components; 2" on O-legs.
- Bottom of laminate end panels are edgebanded for added strength and to seal out moisture.

FOR 29½"H WORKSURFACES

- Specify from a broad assortment of solutions, including —
 - Modular Pedestals
 - Laminate end panels (must be used in conjunction with a laminate modesty panel)
 - Laminate L-shaped end panels
 - Laminate T-shaped end panels
 - Metal O-legs — for use with worksurfaces up to 78"W (when using an 84" or wider worksurface, cannot use two O-legs; must use at least one 15¾" or wider pedestal for the other support).
 - 4½" diameter metal column
 - 2" square metal post leg

FOR 42"H WORKSURFACES

- 42", fixed standing-height workstations give users the option of changing postures from sitting to standing throughout the day to help achieve their wellness goals.
- Specify supports from —
 - Modular Pedestals
 - Laminate end panels (must be used in conjunction with a laminate modesty panel)
 - Laminate L-shaped end panels
 - Metal O-legs
- When combined with a stool-height task chair, provides users the benefit of alternating their work between a seated or standing position.
- An external support channel, for attachment under worksurfaces, is required for all unsupported spans greater than 54"W.

CONCINNITY™ COMPONENTS

- Worksurface End Support (panel, leg, column, base, pedestal) requirements by product type are as follows —
 - Desk, peninsula, or credenza — qty. 2
 - Return — qty. 1
 - Island extension — qty. 1

COORDINATE™ HEIGHT ADJUSTABLE BASE

- Height adjustable bases deliver a healthier style of working by allowing a seamless transition between sitting and standing throughout the day. For open, private, or training spaces.
- Available in 2- or 3-leg rectangle C- and T-shaped foot options to accommodate your layout preferences.

2-Leg

- 2-Stage frame rises from 25⁵/₈" to 45¹/₄".
- 3-Stage frame rises from 21⁵/₈" to 47³/₄".

3-Leg

- 2-Stage frame rises from 21⁵/₈" to 47³/₄".
- Accommodates a variety of worksurface shapes.
 - **2-Leg**
 - Rectangular worksurfaces between 23"D x 40"W and 30"D x 72"W.
 - **3-Leg**
 - Two rectangular, corner cove, 120-degree worksurfaces between 23"D x 40"W and 30"D x 72"W x 72"W.
- Select from a variety of control options; memory preset, basic up/down, hands-free foot pedal, or a paddle control.
- Shipped complete with a pre-assembled electric motor.
- Requires the use of an external stiffener (purchased separately) for worksurfaces 58"W or wider when not used with a Coordinate™ worksurface.

! Only 2-Stage Coordinate™ bases will work with HAT shrouds and HAT low credenzas. 3-Stage Coordinate™ bases should not be used due to their lower height range.

HNL Support Options — External Channel (model HLSLZ5SCxx) - Recommended Use

	Support Combination		Worksurface Width											
	Support 1	Support 2	30"	36"	42"	48"	54"	60"	66"	72"	78"	84"	90"	96"
O-LEG ON ONE END	O-Leg	O-Leg	NR	NR	NR	NR	60	66	72	78	84	NA	NA	NA
	O-Leg	9½"W Ped	NR	NR	NR	NR	NR	60	66	72	78	84	NA	NA
	O-Leg	End Bookcase	NA	NR	NR	NR	NR	NR	60	66	72	78	84	NA
	O-Leg	L End Panel	NR	NR	NR	NR	NR	60	66	72	78	84	NA	NA
	O-Leg	15¾"W Ped	NA	NR	NR	NR	NR	NR	NR	60	66	72	78	NA
	O-Leg	18"W Ped	NA	NA	NR	NR	NR	NR	NR	60	66	72	78	84
	O-Leg	30"W Ped	NA	NA	NA	NA	NR	NR	NR	NR	NR	60	66	72
	O-Leg	36"W Ped	NA	NA	NA	NA	NA	NR	NR	NR	NR	NR	60	66
	NARROW PED	9½"W Ped	9½"W Ped	NA	NA	NR	NR	NR	NR	NR	60	66	72	78
9½"W Ped		End Bookcase	NA	NA	NR	NR	NR	NR	NR	60	66	72	78	84
9½"W Ped		L End Panel	NA	NR	NR	NR	NR	NR	60	66	72	78	84	NA
9½"W Ped		15¾"W Ped	NA	NA	NA	NR	NR	NR	NR	NR	60	66	72	78
9½"W Ped		18"W Ped	NA	NA	NA	NR	NR	NR	NR	NR	60	66	72	78
9½"W Ped		30"W Ped	NA	NA	NA	NA	NA	NR	NR	NR	NR	NR	60	66
9½"W Ped		36"W Ped	NA	NA	NA	NA	NA	NA	NR	NR	NR	NR	NR	60
END BOOKCASE PED	End Bookcase	End Bookcase	NA	NA	NR	NR	NR	NR	NR	NR	60	66	72	78
	End Bookcase	L End Panel	NA	NA	NR	NR	NR	NR	NR	60	66	72	78	84
	End Bookcase	15¾"W Ped	NA	NA	NA	NR	NR	NR	NR	NR	60	66	72	78
	End Bookcase	18"W Ped	NA	NA	NA	NR	NR	NR	NR	NR	60	66	72	78
	End Bookcase	30"W Ped	NA	NA	NA	NA	NA	NR	NR	NR	NR	NR	60	66
	End Bookcase	36"W Ped	NA	NA	NA	NA	NA	NA	NR	NR	NR	NR	NR	60
L END PANEL	L End Panel	L End Panel	NA	NR	NR	NR	NR	NR	60	66	72	78	84	NA
	L End Panel	15¾"W Ped	NA	NA	NR	NR	NR	NR	NR	NR	60	66	72	78
	L End Panel	18"W Ped	NA	NA	NA	NR	NR	NR	NR	NR	60	66	72	78
	L End Panel	30"W Ped	NA	NA	NA	NA	NA	NR	NR	NR	NR	NR	60	66
	L End Panel	36"W Ped	NA	NA	NA	NA	NA	NA	NR	NR	NR	NR	NR	60
TWO PEDS	15¾"W Ped	15¾"W Ped	NA	NA	NA	NA	NR	NR	NR	NR	NR	60	66	72
	15¾"W Ped	18"W Ped	NA	NA	NA	NA	NR	NR	NR	NR	NR	60	66	72
	15¾"W Ped	30"W Ped	NA	NA	NA	NA	NA	NR	NR	NR	NR	NR	NR	60
	15¾"W Ped	36"W Ped	NA	NA	NA	NA	NA	NA	NR	NR	NR	NR	NR	60
	18"W Ped	18"W Ped	NA	NR	NA	NA	NR	NR	NR	NR	NR	NR	60	66
	18"W Ped	30"W Ped	NA	NA	NA	NR	NA	NA	NR	NR	NR	NR	NR	60
	18"W Ped	36"W Ped	NA	NA	NA	NA	NA	NA	NR	NR	NR	NR	NR	60
	30"W Ped	30"W Ped	NA	NA	NA	NA	NA	NR	NR	NR	NR	NR	NR	60
	30"W Ped	36"W Ped	NA	NA	NA	NA	NA	NA	NR	NR	NR	NR	NR	60
	36"W Ped	36"W Ped	NA	NA	NA	NA	NA	NA	NR	NR	NR	NR	NR	60
RETURN CONFIGURATION	None	O-Leg	NR	NR	NR	NR	60	66	72	78	84	NA	NA	NA
	None	9½"W Ped	NR	NR	NR	NR	NR	60	66	72	78	84	NA	NA
	None	End Bookcase	NA	NR	NR	NR	NR	NR	60	66	72	78	84	NA
	None	L End Panel	NR	NR	NR	NR	NR	60	66	72	78	84	NA	NA
	None	15¾"W Ped	NA	NR	NR	NR	NR	NR	NR	60	66	72	78	NA
	None	18"W Ped	NA	NA	NR	NR	NR	NR	NR	60	66	72	78	84
	None	30"W Ped	NA	NA	NA	NA	NR	NR	NR	NR	NR	60	66	72
	None	36"W Ped	NA	NA	NA	NA	NA	NR	NR	NR	NR	NR	60	66

NA = Stiffener not applicable due to invalid worksurface width and support combination

NR = Applicable worksurface width and support combination, but stiffener not required

! The chart reference is to be used to complete the model number. It is not the actual length dimension of the external support channel.

CONCINNITY™ MODESTY/BACK PANELS

HNL Floating Modesty Panel — HSLx14L/MM — Selection Guide														
	Support Combination		Worksurface Width											
	Support 1	Support 2	30"	36"	42"	48"	54"	60"	66"	72"	78"	84"	90"	96"
O-LEG ON ONE END	O-Leg	O-Leg	NA	NA	36	42	48	54	60	60	60	60	NA	NA
	O-Leg	9½"W Ped	NA	NA	NA	30	36	42	48	54	60	60	NA	NA
	O-Leg	End Bookcase	NA	NA	NA	30	36	42	48	54	60	60	60	NA
	O-Leg	L End Panel	NA	NA	NA	36	42	48	54	60	60	60	NA	NA
	O-Leg	15¾"W Ped	NA	NA	NA	NA	30	36	42	48	54	60	60	NA
	O-Leg	18"W Ped	NA	NA	NA	NA	30	36	42	48	54	60	60	60
	O-Leg	30"W Ped	NA	NA	NA	NA	NA	NA	30	36	42	48	54	60
	O-Leg	36"W Ped	NA	NA	NA	NA	NA	NA	NA	30	36	42	48	54
NARROW PED	9½"W Ped	9½"W Ped	NA	NA	NA	NA	30	36	42	48	54	60	60	60
	9½"W Ped	End Bookcase	NA	NA	NA	NA	30	36	42	48	54	60	60	60
	9½"W Ped	L End Panel	NA	NA	NA	NA	30	36	42	48	54	60	60	NA
	9½"W Ped	15¾"W Ped	NA	NA	NA	NA	NA	30	36	42	48	54	60	60
	9½"W Ped	18"W Ped	NA	NA	NA	NA	NA	30	36	42	48	54	60	60
	9½"W Ped	30"W Ped	NA	NA	NA	NA	NA	NA	NA	NA	30	36	48	48
	9½"W Ped	36"W Ped	NA	NA	NA	NA	NA	NA	NA	NA	30	36	42	48
END BOOKCASE PED	End Bookcase	End Bookcase	NA	NA	NA	NA	NA	30	36	42	48	54	60	60
	End Bookcase	L End Panel	NA	NA	NA	NA	30	36	36	48	54	60	60	60
	End Bookcase	15¾"W Ped	NA	NA	NA	NA	NA	30	36	42	48	54	60	60
	End Bookcase	18"W Ped	NA	NA	NA	NA	NA	30	36	42	48	54	60	
	End Bookcase	30"W Ped	NA	NA	NA	NA	NA	NA	NA	NA	30	36	42	48
	End Bookcase	36"W Ped	NA	NA	NA	NA	NA	NA	NA	NA	NA	30	36	42
L END PANEL	L End Panel	L End Panel	NA	NA	NA	NA	36	36	48	54	60	60	60	NA
	L End Panel	15¾"W Ped	NA	NA	NA	NA	NA	30	36	42	48	54	60	60
	L End Panel	18"W Ped	NA	NA	NA	NA	NA	30	36	42	48	54	60	60
	L End Panel	30"W Ped	NA	NA	NA	NA	NA	NA	NA	30	36	42	48	54
	L End Panel	36"W Ped	NA	NA	NA	NA	NA	NA	NA	NA	30	36	42	48
TWO PEDS	15¾"W Ped	15¾"W Ped	NA	NA	NA	NA	NA	NA	30	36	42	48	54	60
	15¾"W Ped	18"W Ped	NA	NA	NA	NA	NA	NA	30	36	36	48	54	60
	15¾"W Ped	30"W Ped	NA	NA	NA	NA	NA	NA	NA	NA	30	36	42	48
	15¾"W Ped	36"W Ped	NA	NA	NA	NA	NA	NA	NA	NA	30	36	42	48
	18"W Ped	18"W Ped	NA	NA	NA	NA	NA	NA	NA	30	36	42	48	54
	18"W Ped	30"W Ped	NA	NA	NA	NA	NA	NA	NA	NA	NA	30	36	42
	18"W Ped	36"W Ped	NA	NA	NA	NA	NA	NA	NA	NA	NA	NA	30	36
	30"W Ped	30"W Ped	NA	NA	NA	NA	NA	NA	NA	NA	NA	NA	NA	30
	30"W Ped	36"W Ped	NA	NA	NA	NA	NA	NA	NA	NA	NA	NA	NA	NA
	36"W Ped	36"W Ped	NA	NA	NA	NA	NA	NA	NA	NA	NA	NA	NA	NA
HT ADJ BASE	Height Adjustable Electric Base (models HHATB3S2LT/C)		NA	NA	NA	42	48	54	60	60	NA	NA	NA	NA
PENINSULA	Support Column	T End Panel	NA	NA	NA	30	30	36	42	48	54	60	60	60
	Support Column	9½"W Ped	NA	NA	NA	NA	NA	30	36	42	48	54	60	60
	Support Column	15¾"W Ped	NA	NA	NA	NA	NA	NA	30	36	42	48	54	60
	Support Column	18"W Ped	NA	NA	NA	NA	NA	NA	30	36	42	48	54	60
	Support Column	30"W Ped	NA	NA	NA	NA	NA	NA	NA	NA	30	36	42	48
	Support Column	36"W Ped	NA	NA	NA	NA	NA	NA	NA	NA	NA	30	36	42
RETURN CONFIGURATION	None	O-Leg	NA	NA	36	42	48	54	60	60	60	60	NA	NA
	None	9½"W Ped	NA	NA	NA	30	36	42	48	54	60	60	NA	NA
	None	End Bookcase	NA	NA	NA	30	36	42	48	54	60	60	60	NA
	None	L End Panel	NA	NA	36	36	42	48	54	60	60	60	NA	NA
	None	15¾"W Ped	NA	NA	NA	NA	30	36	42	48	54	60	60	NA
	None	18"W Ped	NA	NA	NA	NA	30	36	42	48	54	60	60	60
	None	30"W Ped	NA	NA	NA	NA	NA	NA	30	36	42	48	54	60
	None	36"W Ped	NA	NA	NA	NA	NA	NA	NA	30	36	42	48	60

NA = Floating Modesty Panel not applicable for use with worksurface width and support combination

CONCINNITY™ PRIVACY SCREENS

HNL Above-Below Privacy Screen — HLSL28xx — Selection Guide

	Support Combination		Worksurface Width											
	Support 1	Support 2	30"	36"	42"	48"	54"	60"	66"	72"	78"	84"	90"	96"
O-LEG ON ONE END	O-Leg	O-Leg	NA	30	36	42	48	54	60	60	60	NA	NA	NA
	O-Leg	9½"W Ped	NA	NA	30	36	42	48	54	60	60	60	NA	NA
	O-Leg	End Bookcase	NA	NA	NA	30	36	42	48	54	60	60	60	NA
	O-Leg	L End Panel	NA	NA	NA	36	42	48	54	60	60	60	NA	NA
	O-Leg	15¾"W Ped	NA	NA	NA	30	36	42	48	54	60	60	60	NA
	O-Leg	18"W Ped	NA	NA	NA	NA	30	36	42	48	54	60	60	60
	O-Leg	30"W Ped	NA	NA	NA	NA	NA	NA	30	36	42	48	54	60
	O-Leg	36"W Ped	NA	NA	NA	NA	NA	NA	NA	30	36	42	48	54
NARROW PED	9½"W Ped	9½"W Ped	NA	NA	NA	NA	30	36	42	48	54	60	60	60
	9½"W Ped	End Bookcase	NA	NA	NA	NA	30	36	42	48	54	60	60	60
	9½"W Ped	L End Panel	NA	NA	NA	30	36	42	48	48	60	60	60	NA
	9½"W Ped	15¾"W Ped	NA	NA	NA	NA	30	36	42	48	54	60	60	60
	9½"W Ped	18"W Ped	NA	NA	NA	NA	30	36	42	48	54	60	60	60
	9½"W Ped	30"W Ped	NA	NA	NA	NA	NA	NA	NA	30	36	42	48	54
	9½"W Ped	36"W Ped	NA	NA	NA	NA	NA	NA	NA	NA	30	36	42	48
END BOOKCASE PED	End Bookcase	End Bookcase	NA	NA	NA	NA	30	36	42	48	54	60	60	60
	End Bookcase	L End Panel	NA	NA	NA	NA	30	36	42	48	54	60	60	60
	End Bookcase	15¾"W Ped	NA	NA	NA	NA	30	36	42	48	54	60	60	60
	End Bookcase	18"W Ped	NA	NA	NA	NA	30	36	42	48	54	60	60	60
	End Bookcase	30"W Ped	NA	NA	NA	NA	NA	NA	NA	30	36	42	48	54
	End Bookcase	36"W Ped	NA	NA	NA	NA	NA	NA	NA	NA	30	36	42	48
L END PANEL	L End Panel	L End Panel	NA	NA	NA	30	36	42	48	54	60	60	60	NA
	L End Panel	15¾"W Ped	NA	NA	NA	NA	30	36	42	48	54	60	60	60
	L End Panel	18"W Ped	NA	NA	NA	NA	30	36	42	48	54	60	60	60
	L End Panel	30"W Ped	NA	NA	NA	NA	NA	NA	NA	30	36	42	48	54
	L End Panel	36"W Ped	NA	NA	NA	NA	NA	NA	NA	NA	30	36	42	48
TWO PEDS	15¾"W Ped	15¾"W Ped	NA	NA	NA	NA	NA	NA	30	36	42	48	54	60
	15¾"W Ped	18"W Ped	NA	NA	NA	NA	NA	NA	30	36	42	48	54	60
	15¾"W Ped	30"W Ped	NA	NA	NA	NA	NA	NA	NA	NA	30	36	42	48
	15¾"W Ped	36"W Ped	NA	NA	NA	NA	NA	NA	NA	NA	30	36	42	48
	18"W Ped	18"W Ped	NA	NA	NA	NA	NA	NA	30	36	42	48	48	60
	18"W Ped	30"W Ped	NA	NA	NA	NA	NA	NA	NA	NA	30	36	42	48
	18"W Ped	36"W Ped	NA	NA	NA	NA	NA	NA	NA	NA	NA	30	36	42
	30"W Ped	30"W Ped	NA	NA	NA	NA	NA	NA	NA	NA	NA	NA	30	36
	30"W Ped	36"W Ped	NA	NA	NA	NA	NA	NA	NA	NA	NA	NA	NA	30
	36"W Ped	36"W Ped	NA	NA	NA	NA	NA	NA	NA	NA	NA	NA	NA	NA
HT ADJ BASE	Height Adjustable Base (models HHATB3S2LT/C)		NA	NA	NA	42	48	54	60	60	NA	NA	NA	NA
RETURN CONFIGURATION	None	O-Leg	NA	30	36	42	48	54	60	60	60	NA	NA	NA
	None	9½"W Ped	NA	NA	30	36	42	48	54	60	60	60	NA	NA
	None	End Bookcase	NA	NA	NA	30	36	42	48	54	60	60	60	NA
	None	L End Panel	NA	NA	30	36	42	48	54	60	60	60	NA	NA
	None	15¾"W Ped	NA	NA	NA	30	36	36	48	54	60	60	60	NA
	None	18"W Ped	NA	NA	NA	NA	30	36	42	48	54	60	60	60
	None	30"W Ped	NA	NA	NA	NA	NA	NA	30	36	42	48	54	60
	None	36"W Ped	NA	NA	NA	NA	NA	NA	NA	30	36	42	48	54

NA = Above-Below Screen not applicable for use with worksurface width and support combination

CONCINNITY™ COMPONENTS — SUPPORTS

SUPPORT STORAGE PEDESTALS — 28½”H

- Non-handed, interchangeable design reconfigures easily.
- For use with component top and modesty/back panels or pedestal top and back panels.
 - Pedestals are not fully enclosed and require a component top/worksurface and modesty/back panel or a pedestal back, both of which must be ordered separately.
 - Pedestal’s front and side panels are finished.
- The pedestal depth dimension is less than the like-size depth of the component top, to accommodate addition of a modesty/back panel.
 - 29½”D pedestals can be used under 30” or 36”D worksurfaces; 23½”D pedestals can be used under 24” or 30”D worksurfaces.
 - When specifying a 29½”D pedestal with ¾” modesty panel under a 36”D worksurface, or a 23½”D pedestal with a ¾” modesty panel under a 30”D worksurface, there will be a 6” approach side overhang.
- Bottom of side panels are edgebanded for added strength and to seal out moisture.
- Drawers:
 - Operate on steel ball-bearing suspensions to ensure smooth, quiet, long-lasting operation; full extension allows easy access to contents.
 - Fronts are edgebanded on all four sides.
 - Feature 5-sided construction for added strength and easy alignment or replacement of drawer fronts.

- Interchangeable core removable locks are located on front of all modular storage products, except the storage cabinet.
- Finish of lock is determined by, and aligned with, the handle finish specified.
- Locks feature a removable cylinder that can be interchanged as needed; allows users to access all furniture pieces in an office with a single key for convenience and security. Makes re-keying quick and easy. Keyed alike cores must be ordered separately by specification of the key number (removable lock core kit models available in Black [model HF23B] or Satin [model HF23S]).
- Ship fully assembled.
- Chassis and drawer front colors are specified separately; can be selected with common woodgrain or solid laminate color, or with different, complementary chassis and drawer/door colors.
- See chart on page 48 for cord management options. If the pedestal grommet option is chosen, two cutouts, one per end/side panel, each with a black plastic cap, are included.

SUPPORT STORAGE PEDESTALS — 41”H STANDING-HEIGHT

- Same as above except — not to be used freestanding; top and back are not enclosed.
 - Rear of pedestal can be enclosed with a full, 40¾”H back panel or with a 27⅞”H modesty panel combined with a lower, 13”H pedestal back component. Pedestal back and modesty panel must be ordered separately.

CONCINNITY™ PAPER ORGANIZER COMPATIBILITY

PAPER ORGANIZERS FOR STACK-ON AND WALL MOUNTED STORAGE CABINETS

- Laminate vertical paper manager (HLVPM1) is designed for desk, credenza, and return tops; fits under stack-on and wall mount storage units.
- Laminate desktop storage terrace (HLDST1) for use on worksurfaces, or inside overhead storage compartments >26½"W.
- Metal desktop paper shelf (HDPS1) for use on worksurfaces, can be stacked two high, or inside overhead storage compartments >28¾"W.
- Stacked paper management (HLVPM2) can be positioned inside overhead storage cabinets >32½"W.
- Metal hanging paper shelf (HHPS1) attaches quickly and easily to the underside of stack-on and wall mounted storage models.
- For applications using the organizers inside stack-on and wall mounted storage compartments, the fit compatibility is as follows:

OUTSIDE WIDTH	INSIDE WIDTH	Stacked Paper Mgt. — 32½"W HLVPM2	Desktop Paper Shelf — 28¾"W HDPS1	Desktop Storage Terrace — 26½"W HLDST1	Hanging Paper Shelf — 28¾"W HHPS1
		Yes or No	Yes or No	Yes or No	*Qty — see NOTE
STACK-ON STORAGE W/ LAM DOORS, LAM LOCKING DOORS, FROSTED DOORS					
36"W	34.34	Y	Y	Y	1
42"W	40.34	Y	Y	Y	1
48"W (large compartment)	30.60	N	Y	Y	1
60"W	28.60	N	N	Y	2
66"W	31.60	N	Y	Y	2
72"W	34.60	Y	Y	Y	2
78"W	37.60	Y	Y	Y	2
STACK-ON STORAGE W/ SLIDING DOOR					
48"W	22.60	N	N	N	1
60"W	28.60	N	N	Y	2
66"W	31.60	N	Y	Y	2
72"W	34.60	Y	Y	Y	2
78"W	37.60	Y	Y	Y	2
WALL MOUNT STORAGE W/ LAM DOORS, LAM LOCKING DOORS, FROSTED DOORS					
30"W	28.35	N	N	Y	N
36"W	33.67	Y	Y	Y	1
42"W	39.67	Y	Y	Y	1
48"W (large compartment)	30.22	N	Y	Y	1
60"W	28.22	N	N	Y	2
66"W	31.22	N	Y	Y	2
72"W	34.22	Y	Y	Y	2
78"W	37.22	Y	Y	Y	2
WALL MOUNT STORAGE W/ SLIDING DOOR					
48"W	22.46	N	N	N	1
60"W	28.46	N	N	Y	2
66"W	31.46	N	Y	Y	2
72"W	34.46	Y	Y	Y	2
78"W	37.46	Y	Y	Y	2

*NOTE: For model HHPS1, quantity represents the number that can be mounted side-by-side under the cabinet.

CONCINNITY™ CORD MANAGEMENT

	GROMMET	# OF GROMMETS	LOCATION	CUTOUT SHAPE	MATERIAL	COLOR/FINISH
BUILT-UP/FACTORY-CONFIGURED						
DESK						
Top	Standard/Fixed Location	2	Back Left & Right	3" Round	Plastic	Black or Platinum
End Panel	Standard/Fixed Location	2 (1 per EP)	Top Back Corner	1¼" Round	Plastic	Black
Modesty/Back	Not Available	0	N/A	N/A	N/A	N/A
CREDENZA						
Top	Standard/Fixed Location	2	Back Left & Right	3" Round	Plastic	Black or Platinum
End Panel	Standard/Fixed Location	2 (1 per EP)	Top Back Corner	1¼" Round	Plastic	Black
Modesty/Back	Standard/Fixed Location	1	Top Center	2½" Round	Plastic	Black
RETURN						
Top	Standard/Fixed Location	1	Top Center	3" Round	Plastic	Black or Platinum
End Panel	Standard/Fixed Location	1	Top Back Corner	1¼" Round	Plastic	Black
Modesty/Back	Standard/Fixed Location	1	Top Center	2½" Round	Plastic	Black
BRIDGE						
Top	Standard/Fixed Location	1	Back Center	3" Round	Plastic	Black or Platinum
Modesty/Back	Standard/Fixed Location	1	Top Center	2½" Round	Plastic	Black
BULLET PENINSULA						
Top	Not Available	0				
End Panel	Not Available; Pass-Thru in Brace Panel	0				
JETTY PENINSULA						
Top	Standard/Fixed Location	1	Back, Approach-Side Corner	3" Round	Plastic	Black or Platinum
End Panel	Not Available; Pass-Thru Standard in Brace Panel	0				
CORNER UNIT						
Top	Standard/Fixed Location	1	Back Corner	3" Round	Plastic	Black or Platinum
Modesty/Back	Not Available; Pass-Thru Standard in Brace Panels	0				
Stack-on	Standard/Fixed Location	1	1¼" Side-to-Side Gap at Top or Bottom of Back Panel, Below Cabinet			
MODULAR COMPONENTS – WORKSURFACES						
Rectangle – 60" to 96"W	Optional – Specify: Black (P) or Platinum (T1) or None (X)	2	Back Left & Right	3" Round	Plastic	Black or Platinum
Rectangle – 30" to 54"W	Optional – Specify: Black (P) or Platinum (T1) or None (X)	1	Back Center	3" Round	Plastic	Black or Platinum
Bullet Shape	Optional – Specify: Black (P) or Platinum (T1) or None (X)	1	Centered Along EP; Over Brace Leg Cutout	3" Round	Plastic	Black or Platinum
Ext. Corner	Optional – Specify: Black (P) or Platinum (T1) or None (X)	1	Back Corner of Top and Long End Panel	3" Round	Plastic	Black or Platinum
MODULAR COMPONENTS – MODESTY PANELS						
Full-Length – ≥30"W	Optional – Specify: Black (P) or None (X)	1	Top Center	2½" Round	Plastic	Black
10"	No	0				
MODULAR COMPONENTS – END PANELS						
1½" Thick	Optional – Specify: Black (P) or None (X)	1	Top Back Corner	1¼" Round	Plastic	Black
T-Shaped	No	0				
L-Shaped	Optional – Specify: Black (P) or None (X)	1	Top or Bottom Centered	1¼" Round	Plastic	Black
MODULAR COMPONENTS – STORAGE PEDESTALS						
Pedestal	Optional – Specify: Black (P) or None (X)	2 (1 per EP)	Top Back Corner	1¼" Round	Plastic	Black

NOTE: If customer wants a desk, credenza, return, or bridge without grommets, they can specify modular components.

Grommet Locations in Tops

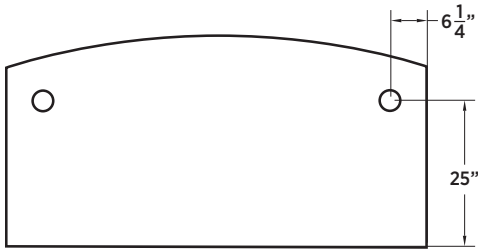

Bow Top Desks and Worksurfaces

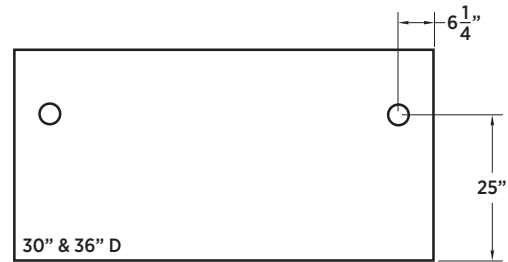

Desks and Rectangle Worksurfaces

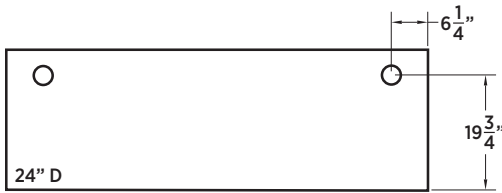

Credenzas and Rectangle Worksurfaces

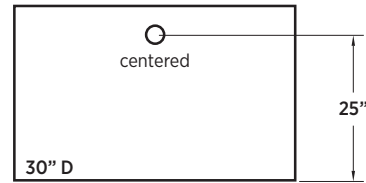

Rectangle Worksurfaces

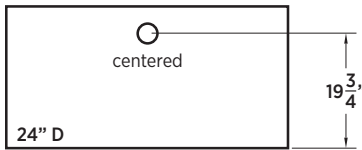

Returns, Bridges, and Rectangle Worksurfaces

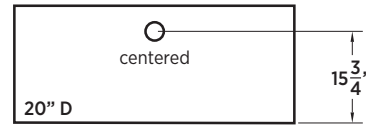

Rectangle Worksurfaces

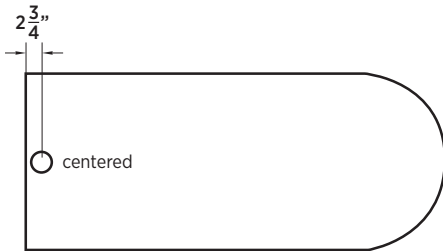

Bullet Worksurfaces

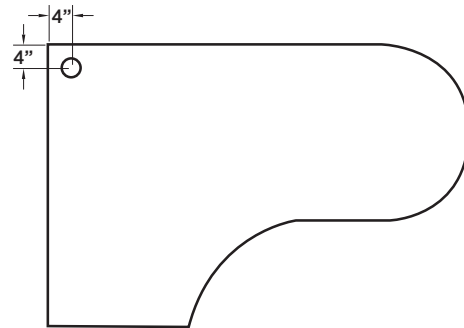

Jetty Peninsula

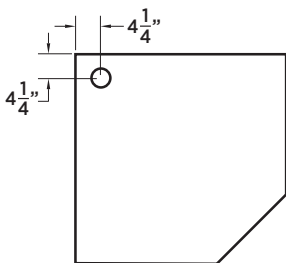

Corner Unit

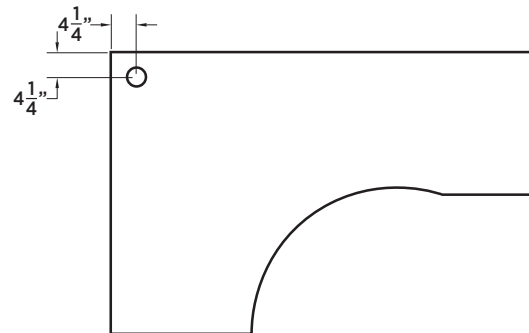

Extended Corner Worksurfaces

CONCINNITY™

Typicals



Icon Legend on page 19

QTY	DESCRIPTION	MODEL	LIST PRICE	PRICE EXTENSION
1	Double Pedestal Desk, Bow Top, Breakfront Frosted Modesty Panel 72"W x 36"D x 29½"H	HNL3672DPBBF	\$3,772	\$3,772
1	Credenza with Kneespace 72"W x 24"D x 29½"H	HNL2472DPK	\$2,380	\$2,380
1	Wall Mount Storage, Frosted Doors with Silver Frame 72"W x 15"D x 28½"H	HNL2972FD	\$3,119	\$3,119
1	Storage/File Cabinet, Hinged Right 18"W x 24"D x 64¾"H	HNL241865SFLR	\$2,277	\$2,277
1	Storage/File Cabinet, Hinged Left 18"W x 24"D x 64¾"H	HNL241865SFL	\$2,277	\$2,277
TOTAL:			\$13,825	

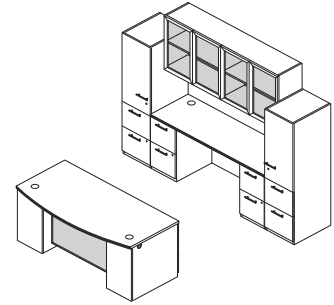
**DESK — CREDENZA — STORAGE**

QTY	DESCRIPTION	MODEL	LIST PRICE	PRICE EXTENSION
1	Left Pedestal Desk, Rectangle Top, Breakfront Modesty Panel 72"W x 36"D x 29½"H	HNL3672LPRB	\$2,501	\$2,501
1	Rectangle Worksurface with Vertical Grain 42"W x 24"D	HNLRC2442V	\$337	\$337
1	Narrow File/File Pedestal 9½"W x 23⅞"D x 28½"H	HNL231028PFF	\$905	\$905
1	Modesty/Back Panel — Full-Length 42"W x 27⅞"H	HNLMP4228	\$270	\$270
1	Stack-on Storage, Sliding Door 78"W x 15"D x 35¼"H	HNL3678SD	\$1,660	\$1,660
1	Storage/File Cabinet, Open Shelves 18"W x 24"D x 64¾"H	HNL241865SFX	\$2,163	\$2,163
TOTAL:			\$7,836	

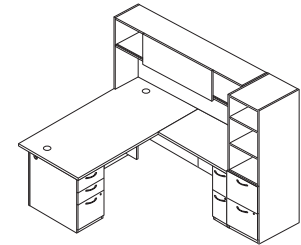
**L-WORKSTATION**

QTY	DESCRIPTION	MODEL	LIST PRICE	PRICE EXTENSION
1	Rectangle Worksurface 72"W x 30"D	HNLRC3072	\$564	\$564
1	Narrow Box/Box/File Pedestal 9½"W x 29⅞"D x 28½"H	HNL291028PBBF	\$1,011	\$1,011
1	Full Back Panel — For 9½"W Pedestal 9½"W x 27⅞"H	HNLPB1028	\$168	\$168
1	Laminate Modesty Screen 36"W x 13"H	HUSLMD1336	\$619	\$619
1	Bookcase End Support 12"W x 30"D x 28½"H	HNL123028BKE	\$666	\$666
1	Rectangle Worksurface 72"W x 24"D	HNLRC2472	\$482	\$482
1	Shelf/Box/Box/Lateral File Pedestal 36"W x 23⅞"D x 28½"H	HNL233628PSL	\$1,631	\$1,631
1	Storage Cabinet Pedestal 36"W x 23⅞"D x 28½"H	HNL233628PSC	\$1,062	\$1,062
1	Modesty/Back Panel — Full-Length 72"W x 27⅞"H	HNLMP7228	\$377	\$377
1	Stack-on Storage, Sliding Door 72"W x 15"D x 35¼"H	HNL3672SD	\$1,610	\$1,610
1	Bookcase with Coat Hooks, 5-Shelf, Left 24"W x 24"D x 64¾"H	HNL2424BK5CL	\$1,254	\$1,254
TOTAL:			\$9,444	

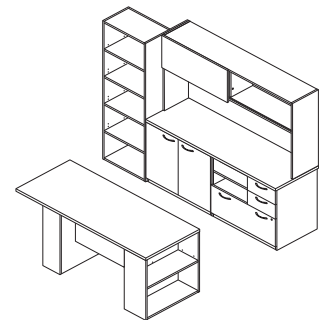
**DESK — CREDENZA — STORAGE**



Icon Legend on page 19

CONCINNITY™ Typicals

DESKS

QTY	DESCRIPTION	MODEL	LIST PRICE	PRICE EXTENSION
1	Rectangle Worksurface 60"W x 24"D	HNLRC2460	\$430	\$430
1	Height Adjustable Base	HHATB3S2LT	\$1,167	\$1,167
1	External Stiffener 48"W for 54" Worksurface	HLSLZ5SC60	\$135	\$135
1	Rectangle Worksurface 84"W x 24"D	HNLRC2484	\$647	\$647
1	End Panel, Left 1½"W x 23⅝"D x 28½"H	HNLPE2428L	\$270	\$270
1	Shelf/Box/Box/Lateral File Pedestal 36"W x 23⅝"D x 28½"H	HNL233628PSL	\$1,631	\$1,631
1	Modesty/Back Panel — Short 84"W x 10"H	HNLMP8410	\$457	\$457
1	Low Back Panel — For 28½"H Pedestal 36"W x 18"H	HNLB3618	\$198	\$198
2	Stack-on Storage, Frosted Doors with Silver Frame 42"W x 15"D x 35¼"H	HNL3642FD	\$1,736	\$3,472
1	Space Saver End Panels for Stack-on Storage ¾"W x 14¼"D x 35¼"H	HNL3605SSEP	\$500	\$500
1	Wardrobe/Storage Cabinet, Hinged Right 18"W x 24"D x 64¾"H	HNL241865WLR	\$2,081	\$2,081

TOTAL: \$10,988

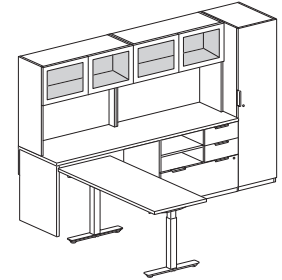

L-WORKSTATION WITH HEIGHT-ADJUSTABLE DESK — OPEN PLAN

QTY	DESCRIPTION	MODEL	LIST PRICE	PRICE EXTENSION
1	Bullet Worksurface 84"W x 30"D	HNLBU3084	\$791	\$791
1	T-Shaped End Panel — For Bullet Worksurface 11⅝"W x 29⅞"D x 28½"H	HNLTEP3028	\$463	\$463
1	Support Column — For Bullet Worksurface 3" Diameter	HPC190X	\$219	\$219
1	Bridge 48"W x 24"D x 29½"H	HNL2448BF	\$589	\$589
1	Rectangle Worksurface 84"W x 24"D	HNLRC2484	\$647	\$647
1	End Panel, Left 1½"W x 23⅝"D x 28½"H	HNLPE2428L	\$270	\$270
1	Shelf/Box/Box/Lateral File Pedestal 36"W x 23⅝"D x 28½"H	HNL233628PSL	\$1,631	\$1,631
1	Modesty/Back Panel — Full-Length 84"W x 27⅞"H	HNLMP8428	\$457	\$457
2	Stack-on Storage, Laminate Doors 42"W x 15"D x 48⅝"H	HNL4942LD	\$1,581	\$3,162
1	Space Saver End Panels for Stack-on Storage ¾"W x 14¼"D x 48⅝"H	HNL4905SSEP	\$672	\$672

TOTAL: \$8,901

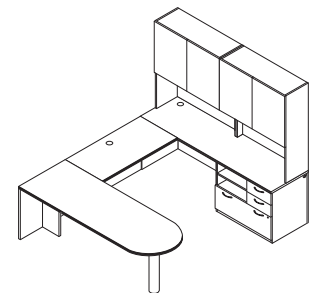

U-WORKSTATION WITH 84" W WORKSURFACE

QTY	DESCRIPTION	MODEL	LIST PRICE	PRICE EXTENSION
1	Left Pedestal Desk, Rectangle Top, Breakfront Frosted Modesty Panel 72"W x 36"D x 29½"H	HNL3672LPRBF	\$3,120	\$3,120
1	Rectangle Worksurface with Vertical Grain 48"W x 24"D	HNLRC2448V	\$362	\$362
1	Modesty/Back Panel — Short 48"W x 10"H	HNLMP4810	\$294	\$294
1	Right Credenza with Lateral File 72"W x 24"D x 29½"H	HNL2472RLC	\$2,074	\$2,074
1	Stack-on Storage, Frosted Doors with Silver Frame 72"W x 15"D x 48⅝"H	HNL4972FD	\$3,396	\$3,396
1	Vertical Paper Manager	HLVPM1	\$445	\$445
1	Wardrobe Left, Bookcase Right 36"W x 24"D x 78⅞"H	HNL243679WLBR	\$3,315	\$3,315

TOTAL: \$13,006

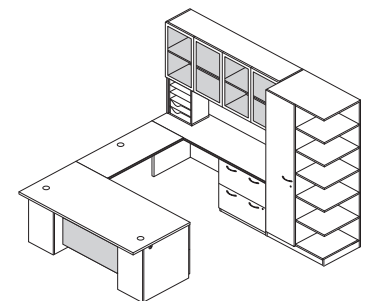

U-WORKSTATION

CONCINNITY™

Typicals



Icon Legend on page 19

QTY	DESCRIPTION	MODEL	LIST PRICE	PRICE EXTENSION
1	Rectangle Worksurface 72"W x 30"D	HNLRC3072	\$564	\$564
1	Rectangle Worksurface with Vertical Grain 42"W x 24"D	HNLRC2442V	\$337	\$337
1	Height Adjustable Base, 3-Leg	HHATB3S3LT	\$1,925	\$1,925
1	External Stiffener 60"W for 66" Worksurface	HLSLZ5SC72	\$152	\$152
1	Acrylic Modesty Screen 60"W x 13"H	HUSAMOD1360	\$1,003	\$1,003
1	Rectangle Worksurface 72"W x 24"D	HNLRC2472	\$482	\$482
1	End Panel, Right 1½"W x 23⅞"D x 28½"H	HNLEP2428R	\$270	\$270
1	Box/Box/File Pedestal 15¾"W x 23⅞"D x 28½"H	HNL231628PBFF	\$937	\$937
1	Low Back Panel — For 15¾"W Pedestal 15¾"W x 18"H	HNLLB1618	\$170	\$170
1	Modesty/Back Panel — Short 72"W x 10"H	HNLMP7210	\$377	\$377
1	Wall Mount Storage, Frosted Doors with Silver Frame 72"W x 15"D x 15"H	HNL1572FD	\$2,347	\$2,347
1	Storage/File Cabinet, Hinged Left 18"W x 24"D x 64¾"H	HNL241865SFL	\$2,277	\$2,277
TOTAL:			\$10,841	

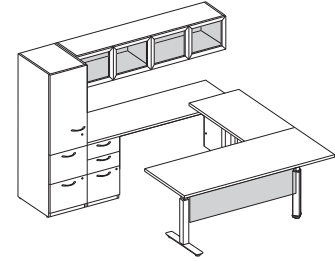

U-WORKSTATION WITH HEIGHT-ADJUSTABLE L-WORKSURFACE

QTY	DESCRIPTION	MODEL	LIST PRICE	PRICE EXTENSION
1	Rectangle Worksurface 72"W x 24"D	HNLRC2472	\$482	\$482
2	O-Leg Support for 24"D Worksurface 24"D x 28½"H	HLSL2428O	\$428	\$856
1	External Support Channel for 72"W Worksurface	HLSLZ5SC78	\$152	\$152
1	Low Credenza, Drawers Left, Bookcase Right 60"W x 20"D x 21½"H	HNL206021LD2	\$1,657	\$1,657
1	Rectangle Worksurface 54"W x 24"D	HNLRC2454	\$394	\$394
1	Standing-Height O-Leg Support for 24"D Worksurface 24"D x 41"H	HLSL2441O	\$571	\$571
1	Narrow Box/Box/File/File Pedestal 9½"W x 23⅞"D x 41"H	HNL231041PBFF	\$1,731	\$1,731
1	Full Back Panel — For 41"H Pedestal 9½"W x 40⅜"H	HNLPB1041	\$184	\$184
1	Storage Tower, Hinged Left 18"W x 24"D x 50"H	HNL241850TLL	\$1,631	\$1,631
TOTAL:			\$7,658	

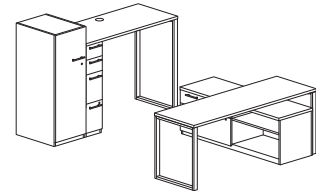

U-WORKSTATION WITH SITTING AND STANDING-HEIGHT WORKSURFACES — OPEN PLAN



Icon Legend on page 19

CONCINNITY™ Typicals

QTY	DESCRIPTION	MODEL	LIST PRICE	PRICE EXTENSION
1	Rectangle Worksurface 72"W x 30"D	HNLRC3072	\$564	\$564
1	O-Leg Support for 30"D Worksurface 30"D x 28½"H	HLSL30280	\$474	\$474
1	O-Leg Support over Low Credenza 30"D x 7"H	HLSL3070	\$366	\$366
1	External Support Channel for 72"W Worksurface	HLSLZ5SC78	\$152	\$152
1	Low Credenza, Drawers Right, Bookcase Left 60"W x 20"D x 21½"H	HNL206021RD2	\$1,657	\$1,657
1	Low Credenza, Drawers Left, Bookcase Right 60"W x 20"D x 21½"H	HNL206021LD2	\$1,657	\$1,657
2	Wall Mount Storage, Laminate Doors 30"W x 15"D x 28½"H	HNL2930LD	\$1,075	\$2,150
1	Wall Mount Storage, Frosted Doors with Silver Frame 30"W x 15"D x 28½"H	HNL2930FD	\$1,697	\$1,697
1	Wall Mount Tackboards 30"W x 48½"H	HNL4930TB	\$396	\$396
TOTAL:			\$9,113	

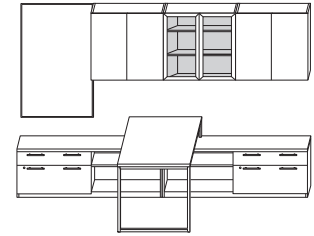

**WORKSTATION WITH
WORKWALL – OPEN PLAN**

QTY	DESCRIPTION	MODEL	LIST PRICE	PRICE EXTENSION
3	Rectangle Worksurface with Vertical Grain 48"W x 24"D	HNLRC2448V	\$362	\$1,086
3	O-Leg Support for 48"W x 24"D Worksurface 24"D x 28½"H	HLSL24280	\$428	\$1,284
3	Acrylic Modesty Screen 42"W x 13"H	HUSAMOD1342	\$818	\$2,454
3	Rectangle Worksurface 72"W x 24"D	HNLRC2472	\$482	\$1,446
3	L-Shaped End Panel, Left 15¾"W x 24"D x 28½"H	HNLLEP2428L	\$436	\$1,308
3	Shelf/Box/Box/Lateral File Pedestal 30"W x 23⅜"D x 28½"H	HNL233028PSL	\$1,598	\$4,794
3	Modesty/Pedestal Back Panel 30"W x 27⅞"H	HNLMP3028	\$231	\$693
3	Wall Mount Storage, Frosted Doors with Silver Frame 72"W x 15"D x 15"H	HNL1572FD	\$2,347	\$7,041
TOTAL:			\$20,106	

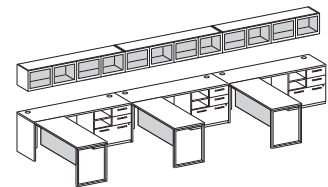

L-WORKSTATIONS – OPEN PLAN

CONCINNITY™

Typicals



Icon Legend on page 19

QTY	DESCRIPTION	MODEL	LIST PRICE	PRICE EXTENSION
1	Rectangle Worksurface with Vertical Grain 48"W x 24"D	HNLRC2448V	\$362	\$362
1	O-Leg Support for 48"W x 24"D Worksurface 24"D x 28½"H	HLSL2428O	\$428	\$428
1	Rectangle Worksurface 96"W x 24"D	HNLRC2496	\$699	\$699
1	Storage Cabinet Pedestal 36"W x 23⅞"D x 28½"H	HNL233628PSC	\$1,062	\$1,062
1	End Panel, Left 1⅞"W x 23⅞"D x 28½"H	HNL2428L	\$270	\$270
1	Modesty/Back Panel — Full-Length 96"W x 27⅞"H	HNLMP9628	\$565	\$565
1	Bookcase Hutch, Frosted Doors with Silver Frame 36"W x 15"D x 48⅝"H	HNL4936BHFD	\$2,219	\$2,219
1	Wall Mount Storage, Frosted Doors with Silver Frame 60"W x 15"D x 28½"H	HNL2960FD	\$2,930	\$2,930
1	Vertical Paper Manager	HLVPM1	\$445	\$445
1	Storage Tower, Wardrobe Right, Cabinet Left 24"W x 24"D x 78⅞"H	HNL242465TLR	\$2,925	\$2,925
TOTAL:			\$11,905	

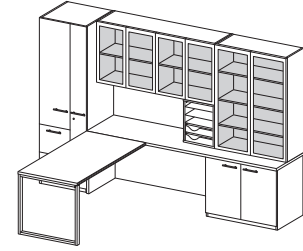

WORKSTATION WITH WORKWALL — OPEN PLAN

QTY	DESCRIPTION	MODEL	LIST PRICE	PRICE EXTENSION
4	Rectangle Worksurface 60"W x 24"D	HNLRC2460	\$430	\$1,720
4	Shelf/Box/Box/File Pedestal 15¾"W x 23⅞"D x 41"H	HNL231641PSBBF	\$1,969	\$7,876
4	Full Back Panel — For 15¾"W Pedestal 15¾"W x 40⅝"H	HNL231641	\$202	\$808
4	Narrow Box/Box/File/File Pedestal 9½"W x 23⅞"D x 41"H	HNL231041PBBFF	\$1,731	\$6,924
4	Full Back Panel — For 9½"W Pedestal 9½"W x 40⅝"H	HNL231041	\$184	\$736
2	5-Shelf Bookcase with Coat Hooks, Right 24"W x 24"D x 64¾"H	HNL2424BK5CR	\$1,254	\$2,508
2	5-Shelf Bookcase with Coat Hooks, Left 24"W x 24"D x 64¾"H	HNL2424BK5CL	\$1,254	\$2,508
TOTAL:			\$23,080	

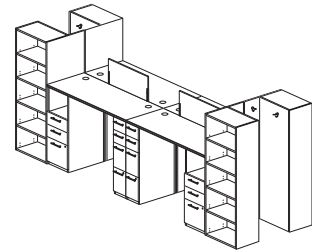

STANDING-HEIGHT — TEAMING WORKSTATION — OPEN PLAN

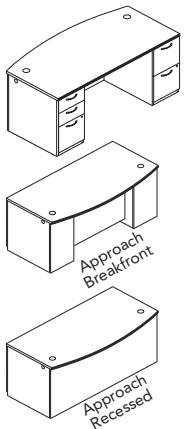

DESCRIPTION	APPROACH SIDE OVERHANG	MODEL	SHIP WEIGHT	CUBE	L1 LIST	L2 UPCHARGES		
						WORKSURFACES	CHASSIS	FRONTS
Double Pedestal Desk — Bow Top 72"W x 36"D x 29½"H, Recessed Modesty Panel	6"	HNL3672DPBR	298	51.8	\$3021	\$27	\$42	\$11
72"W x 36"D x 29½"H, Breakfront Modesty Panel	6-12"	HNL3672DPBB	282	51.8	\$3141	\$27	\$42	\$11
72"W x 36"D x 29½"H, Breakfront Frosted Modesty Panel	6-12"	HNL3672DPBBF	266	51.8	\$3772	\$27	\$42	\$11

NOTES: For laminate center drawer, see page 112. For pull-out collaborative shelf, for desks with breakfront modesty panel, see page 112.

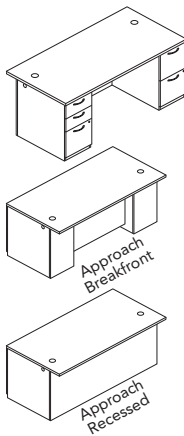

Double Pedestal Desk — Rectangle Top 72"W x 36"D x 29½"H, Rectangle Top, Recessed Modesty Panel	6"	HNL3672DPRR	292	51.8	\$2558	\$27	\$42	\$11
66"W x 30"D x 29½"H, Rectangle Top, Flush Modesty Panel		HNL3066DPRF	267	40.2	\$2407	\$21	\$37	\$11
60"W x 30"D x 29½"H, Rectangle Top, Flush Modesty Panel		HNL3060DPRF	257	40.2	\$2249	\$21	\$48	\$21
72"W x 36"D x 29½"H, Rectangle Top, Breakfront Modesty Panel	6-12"	HNL3672DPRB	287	51.8	\$2847	\$27	\$42	\$11
72"W x 36"D x 29½"H, Rectangle Top, Breakfront Frosted Modesty Panel	6-12"	HNL3672DPRBF	270	51.8	\$3478	\$27	\$42	\$11

NOTES: For laminate center drawer, see page 112. For pull-out collaborative shelf, for desks with breakfront modesty panel, see page 112.

NOTES:

- Feature full-to-the-floor pedestals to maximize storage space.
- Double pedestal desks have 3/2 drawer configuration (box/box/file on left pedestal, file/file on right pedestal).
- Single pedestal desks have a box/box/file pedestal.
- One molded black pencil tray is included in each box/box/file pedestal.
- 72"W models are available with Rectangle- or bow-shaped tops.
- Bow top desk models measure 36"D at the crest and 30"D along the end panels.
- Breakfront desk features a floating modesty panel which can be specified in laminate or frosted material. Floating design provides space for optional pull-out collaborative shelf for visitors. See page 112.
- Recessed modesty panel design has a full-width conference overhang, providing worksurface and kneespace for guests.
- 66"W and 60"W desks have a flush modesty panel (i.e., no conference overhang).
- Two cord management grommets, for routing and hiding wires and cables, are located in desktops.
- Grommets can be replaced with optional Power (model HGRMTAC) or USB Hub (HGRMTUSB2).
- Pedestal sides and end panels are standard with pass-through grommets to enable the routing of cords below the worksurface, and connections between workstations.
- See "Modular Components" for cord management options. Worksurfaces/tops, end and modesty panels, and pedestals can be specified with or without grommets.
- Finish of pedestal lock(s) is determined by, and aligned with, the handle finish specified.
- Adjustable hex leveling glides.
- Ship fully assembled.

ⓘ Side grommets on pedestal are black only.

HOW TO SPECIFY

Select Model Number	Select Edge Profile and Edge Color See page 29	Select Handle and Lock Color See page 35	Select Worksurface Grommet Finish P Black T1 Platinum	Select Worksurface Color See page 29	Select Chassis Color See page 29	Select Drawer Front Color See page 29
H N L 3 6 7 2 D P B R .	B H .	E .	T 1 .	H .	H .	H .

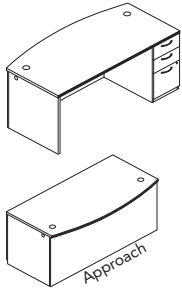

DESCRIPTION	APPROACH SIDE OVERHANG	MODEL	SHIP WEIGHT	CUBE	L1 LIST	L2 UPCHARGES		
						WORKSURFACES	CHASSIS	FRONTS
Single Pedestal Desk — Bow Top 72"W x 36"D x 29½"H, Right, Recessed Modesty Panel (shown)	6"	HNL3672RPBR	238	51.8	\$2427	\$27	\$42	\$11
72"W x 36"D x 29½"H, Left, Recessed Modesty Panel	6"	HNL3672LPBR	238	51.8	\$2427	\$27	\$42	\$11
72"W x 36"D x 29½"H, Right, Breakfront Modesty Panel	6-12"	HNL3672RPBB	237	51.8	\$2737	\$27	\$42	\$11
72"W x 36"D x 29½"H, Left, Breakfront Modesty Panel	6-12"	HNL3672LPBB	237	51.8	\$2737	\$27	\$42	\$11
72"W x 36"D x 29½"H, Right, Breakfront Frosted Modesty Panel	6-12"	HNL3672RPBBF	221	51.8	\$3356	\$27	\$42	\$11
72"W x 36"D x 29½"H, Left, Breakfront Frosted Modesty Panel	6-12"	HNL3672LPBBF	221	51.8	\$3356	\$27	\$42	\$11

NOTES: For laminate center drawer, see page 112. For pull-out collaborative shelf, for desks with breakfront modesty panel, see page 112.

NOTES:

- Feature full-to-the-floor pedestals to maximize storage space.
- Double pedestal desks have 3/2 drawer configuration (box/box/file on left pedestal, file/file on right pedestal).
- Single pedestal desks have a box/box/file pedestal.
- One molded black pencil tray is included in each box/box/file pedestal.
- 72"W models are available with Rectangle- or bow-shaped tops.
- Bow top desk models measure 36"D at the crest and 30"D along the end panels.
- Formal breakfront or recessed modesty panel.
- Breakfront desk features a floating modesty panel which can be specified in laminate or frosted material. Floating design provides space for optional pull-out collaborative shelf for visitors. See page 112.
- Recessed modesty panel design has a full-width conference overhang, providing workspace and kneespace for guests.
- 66"W and 60"W desks have a flush modesty panel (i.e., no conference overhang).
- Two cord management grommets, for routing and hiding wires and cables, are located in desktops.
- Grommets can be replaced with optional Power (model HGRMTAC) or USB Hub (HGRMTUSB2).
- Pedestal sides and end panels are standard with pass-through grommets to enable the routing of cords below the workspace, and connections between workstations.
- See "Modular Components" for cord management options. Worksurfaces/tops, end and modesty panels, and pedestals can be specified with or without grommets.
- Finish of pedestal lock(s) is determined by, and aligned with, the handle finish specified.
- Adjustable hex leveling glides.
- Ship fully assembled.

❗ Side grommets on pedestal are black only.

HOW TO SPECIFY

Select Model Number	Select Edge Profile and Edge Color	Select Handle and Lock Color	Select Worksurface Grommet Finish	Select Worksurface Color	Select Chassis Color	Select Drawer Front Color
See page 29	See page 29	See page 35	P Black T1 Platinum	See page 29	See page 29	See page 29
H N L 3 6 7 2 R P B R .	B H .	E .	T 1 .	H .	H .	H .



DESCRIPTION	APPROACH SIDE OVERHANG	MODEL	SHIP WEIGHT	CUBE	L1 LIST	L2 UPCHARGES		
						WORKSURFACES	CHASSIS	FRONTS
 <p>Single Pedestal Desk — Rectangle Top 72"W x 36"D x 29½"H, Right, Recessed Modesty Panel (shown) 72"W x 36"D x 29½"H, Left, Recessed Modesty Panel 66"W x 30"D x 29½"H, Right, Flush Modesty Panel 66"W x 30"D x 29½"H, Left, Flush Modesty Panel 72"W x 36"D x 29½"H, Right, Breakfront Modesty Panel 72"W x 36"D x 29½"H, Left, Breakfront Modesty Panel 72"W x 36"D x 29½"H, Right, Breakfront Frosted Modesty Panel 72"W x 36"D x 29½"H, Left, Breakfront Frosted Modesty Panel</p>	6"	HNL3672RPRR	242	51.8	\$2098	\$27	\$42	\$11
	6"	HNL3672LPRR	242	51.8	\$2098	\$27	\$42	\$11
		HNL3066RPRF	217	40.2	\$2048	\$21	\$37	\$11
		HNL3066LPRF	217	40.2	\$2048	\$21	\$37	\$11
	6-12"	HNL3672RPRB	242	51.8	\$2501	\$27	\$42	\$11
	6-12"	HNL3672LPRB	242	51.8	\$2501	\$27	\$42	\$11
	6-12"	HNL3672RPRBF	225	51.8	\$3120	\$27	\$42	\$11
	6-12"	HNL3672LPRBF	225	51.8	\$3120	\$27	\$42	\$11

NOTES: For laminate center drawer, see page 112. For pull-out collaborative shelf, for desks with breakfront modesty panel, see page 112.

NOTES:

- Feature full-to-the-floor pedestals to maximize storage space.
- Double pedestal desks have 3/2 drawer configuration (box/box/file on left pedestal, file/file on right pedestal).
- Single pedestal desks have a box/box/file pedestal.
- One molded black pencil tray is included in each box/box/file pedestal.
- 72"W models are available with Rectangle- or bow-shaped tops.
- Bow top desk models measure 36"D at the crest and 30"D along the end panels.
- Formal breakfront or recessed modesty panel.
- Breakfront desk features a floating modesty panel which can be specified in laminate or frosted material. Floating design provides space for optional pull-out collaborative shelf for visitors. See page 112.
- Recessed modesty panel design has a full-width conference overhang, providing worksurface and kneespace for guests.
- 66"W and 60"W desks have a flush modesty panel (i.e., no conference overhang).
- Two cord management grommets, for routing and hiding wires and cables, are located in desktops.
- Grommets can be replaced with optional Power (model HGRMTAC) or USB Hub (HGRMTUSB2).
- Pedestal sides and end panels are standard with pass-through grommets to enable the routing of cords below the worksurface, and connections between workstations.
- See "Modular Components" for cord management options. Worksurfaces/tops, end and modesty panels, and pedestals can be specified with or without grommets.
- Finish of pedestal lock(s) is determined by, and aligned with, the handle finish specified.
- Adjustable hex leveling glides.
- Ship fully assembled.

❗ Side grommets on pedestal are black only.

HOW TO SPECIFY

<p>Select Model Number</p> <p>See page 29</p> <p>H N L 3 6 7 2 R P R R</p>	<p>Select Edge Profile and Edge Color</p> <p>See page 29</p> <p>B H</p>	<p>Select Handle and Lock Color</p> <p>See page 35</p> <p>E</p>	<p>Select Worksurface Grommet Finish</p> <p>P Black T1 Platinum</p> <p>T 1</p>	<p>Select Worksurface Color</p> <p>See page 29</p> <p>H</p>	<p>Select Chassis Color</p> <p>See page 29</p> <p>H</p>	<p>Select Drawer Front Color</p> <p>See page 29</p> <p>H</p>
--	---	---	--	---	---	--

CONCINNITY™

Peninsulas

GSA SIN 33721



Icon Legend on page 19

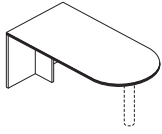

Support column sold separately



DESCRIPTION	MODEL	SHIP WEIGHT	CUBE	L1 LIST	L2 UPCHARGES	
					WORKSURFACE	CHASSIS
Bullet Peninsula with End Panel						
72"W x 36"D x 29½"H	HNL3672BUEP	131	6.6	\$1177	\$27	\$42
72"W x 30"D x 29½"H	HNL3072BUEP	112	5.6	\$1027	\$21	\$27
66"W x 30"D x 29½"H	HNL3066BUEP	105	5.1	\$919	\$21	\$37

NOTES: For use in "U" or "L" shaped furniture layouts; not to be used freestanding. Comprised of top and end/brace panels (Note: Must specify support column; sold separately). Cord routing notch in the brace panel. Adjustable hex leveling glides. For cord grommet options, see "Modular Components". Options include center drawers and modesty panels. Modesty panel is available in laminate or frosted material. Ships

Not designed to be used freestanding.

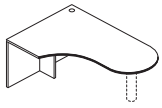
Right-hand model
HNL4872JREP shown

Support column sold separately



DESCRIPTION	MODEL	SHIP WEIGHT	CUBE	L1 LIST	L2 UPCHARGES	
					WORKSURFACE	CHASSIS
Jetty Peninsula with End Panel						
72"W x 30/48"D x 29½"H, Right	HNL4872JREP	147	8.9	\$1414	\$32	\$27
72"W x 30/48"D x 29½"H, Left	HNL4872JLEP	147	8.9	\$1414	\$32	\$27
72"W x 30/42"D x 29½"H, Right	HNL4272JREP	134	17.0	\$1316	\$32	\$27
72"W x 30/42"D x 29½"H, Left	HNL4272JLEP	134	17.0	\$1316	\$32	\$27

NOTES: Worksurface designed and sized to efficiently serve as both a computing and conferencing space. Two sizes, 42"D and 48"D. The 48"D unit is specifically intended to be used with the 48"D extended corner modular top/back components to form a two-piece U-shaped workstation with a 42" cockpit area. For use in "U" or "L" shaped furniture layouts; not to be used freestanding. Comprised of top and end/brace panels (Note: Must specify support column; sold separately). One cord management grommet in the top; cord routing notch in the brace panel. Adjustable hex leveling glides. Field installable modesty panel is optional. Ships

Not designed to be used freestanding.

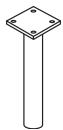

DESCRIPTION	MODEL	SHIP WEIGHT	CUBE	LIST PRICE
Support Column for Bullet and Jetty Peninsulas 3" Diameter. Specify: HPC190X.P. Black only.	HPC190X	12	1.0	\$219
Support Column for Bullet and Jetty Peninsulas 3" Diameter. Specify: HPC191X.X. Available in Silver only.	HPC191X	12	1.0	\$219

Support Column must be specified/ordered with Bullet and Jetty peninsulas.



NOTES:

- See pages 98-102 for shared components.

HOW TO SPECIFY

Select Model Number H N L 3 6 7 2 B U E P	Select Edge Profile and Edge Color See page 29 B H	Select Worksurface Color See page 29 H	Select Chassis Color See page 29 H	
Select Model Number H N L 4 8 7 2 J R E P	Select Edge Profile and Edge Color See page 29 B H	Select Worksurface Grommet Finish P Black T1 Platinum	Select Worksurface Color See page 29 H	Select Chassis Color See page 29 H



	DESCRIPTION	MODEL	SHIP WEIGHT	CUBE	LIST PRICE BY PAINT GRADE		
					P1	P2	P3
	Post Leg Base 28½" H x 2" square NOTES: Can only be used as the outbound support in a peninsula or island extension worksurface application. Glides have 2" of adjustability. Ship 1/pack. SPECIFYING EXAMPLE: HLSL28P.T1	HLSL28P	15	1.0	\$385	\$390	\$406
	Field Installable Modesty Panel for Bullet and Jetty Peninsulas, Laminate (Vertical Grain) 50¼"W x ¾" Thick x 18"H NOTES: Center drawer model H1522 can be used in conjunction with laminate modesty panel model HPC180W. Cord pass-through notch in top corner. SPECIFYING EXAMPLE: HPC180W.H	HPC180W	28	3.6			\$294
	Field Installable Modesty Panel for Bullet and Jetty Peninsulas, Frosted with Silver Frame 50¼"W x ¾" Thick x 18"H ⚠ Cord pass-through notch is not available on the Frosted/Silver model HPC180G. Notch is on laminate model HPC180W only. ⚠ Center drawers not designed to be used with the frosted/silver modesty panel model HPC180G.	HPC180G	33	1.5			\$941

NOTES:

- See pages 98-102 for shared components.

HOW TO SPECIFY

Select
Model Number

H L S L 2 8 P

CONCINNITY™

Corner Unit

GSA SIN 33721



Icon Legend on page 19

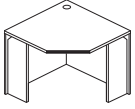

DESCRIPTION	MODEL	SHIP WEIGHT	CUBE	L1 LIST	L2 UPCHARGES	
					WORKSURFACE	CHASSIS
Corner Unit 24"W x 36"D x 24" x 29½"H	HNL3636CU	109	26.4	\$1238	\$16	\$21
NOTES: Designed for use with 24"D returns or bridges. Can be used freestanding. Can be used with two 36"W modular returns to achieve an efficient 6' x 6' layout. One cord management grommet in the top; cord routing notches in the leg panels. The worksurface grommet can be replaced with optional power (model HGRMTAC) or USB (model HGRMTUSB2) hub. Adjustable hex leveling glides. When connected to a 42"W return or modular return, the 78"W stack-on storage unit spans the total depth dimension (78"D). When connected to a 36"W modular return, the 72"W stack-on storage unit spans the total depth dimension (72"D). Edgebanding on the corner unit is profiled on the user's side and flat on the back (approach side) and ends. Ships fully assembled.						

NOTES:

- For Extended Corner Worksurface sizes, see "Modular Components" on page 41.

HOW TO SPECIFY

Select
Model Number

H N L 3 6 3 6 C U .

Select
Edge Profile and Edge
Color

See page 29

B H .

Select
Worksurface Grommet
Finish

P Black
T1 Platinum

P .

Select
Worksurface Color

See page 29

H .

Select
Chassis Color

See page 29

H

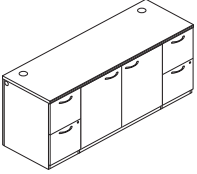
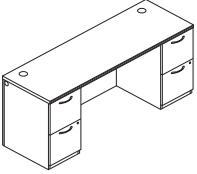
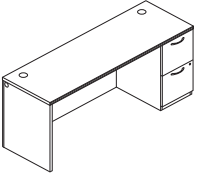
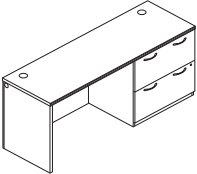

DESCRIPTION	MODEL	SHIP WEIGHT	CUBE	L1 LIST	L2 UPCHARGES		
					WORKSURFACES	CHASSIS	FRONTS
 <p>Credenza with Storage 72"W x 24"D x 29½"H</p> <p>NOTES: For use behind a desk or as a stand-alone storage piece. Four file drawers, 2-left, 2-right and one storage cabinet with hinged doors. One adjustable shelf, which adjusts in 2½" increments, behind doors. Drawers lock. Finish of locks is determined by, and aligned with, the handle finish specified. Storage cabinet doors are non-locking.</p>	HNL2472DPS	323	35.6	\$3144	\$21	\$48	\$42
 <p>Credenza with Kneespace 72"W x 24"D x 29½"H 66"W x 24"D x 29½"H 60"W x 24"D x 29½"H</p> <p>NOTES: For use behind a desk or as a stand-alone storage piece. Four locking file drawers, 2-left, 2-right. Finish of locks determined by, and aligned with, the handle finish specified.</p>	HNL2472DPK	247	35.6	\$2380	\$21	\$42	\$21
	HNL2466DPK	239	32.7	\$2271	\$21	\$42	\$21
	HNL2460DPK	230	29.9	\$2235	\$21	\$37	\$21
 <p>Credenza, Single Pedestal 72"W x 24"D x 29½"H, Right 72"W x 24"D x 29½"H, Left</p> <p>NOTES: Primary use is as part of a connected U-shaped workstation with a bridge and single pedestal desk. Two locking file drawers. Finish of lock determined by, and aligned with, the handle finish specified. Can be used with modular or mobile pedestals.</p>	HNL2472RP	199	35.6	\$1898	\$21	\$37	\$11
	HNL2472LP	199	35.6	\$1898	\$21	\$37	\$11
 <p>Credenza with Lateral File 72"W x 24"D x 29½"H, Right 72"W x 24"D x 29½"H, Left</p> <p>NOTES: Storage file measures 30"W (36"W can be specified using modular components). Mechanical interlock inhibits the extension of more than one drawer at a time. Finish of lock is determined by, and aligned with, the handle finish specified. Can be used with modular or mobile pedestals.</p>	HNL2472RLC	245	35.6	\$2074	\$21	\$37	\$21
	HNL2472LLC	245	35.6	\$2074	\$21	\$37	\$21

NOTES:

- Optional 72"W, 66"W and 60"W stack-on sizes maximize storage space.
- Two cord management grommets, for routing and hiding wires and cables, are located in top.
- Modesty panel and pedestal grommets are black only.
- A cord pass-through grommet is located in the sides of the pedestal and top center of the back (modesty panel) to facilitate reaching wall electrical outlets.
- Worksurfaces/tops, end and modesty panels, and pedestals can be specified with or without grommets. See "Modular Components" on page 48 for cord management options.
- For paper organizers, see pages 715-717.

HOW TO SPECIFY

<p>Select Model Number</p> <p>See page 29</p> <p>H N L 2 4 7 2 D P S</p>	<p>Select Edge Profile and Edge Color</p> <p>See page 35</p> <p>B H</p>	<p>Select Handle and Lock Color</p> <p>See page 29</p> <p>T 1</p>	<p>Select Worksurface Grommet Finish</p> <p>See page 29</p> <p>P Black T1 Platinum</p>	<p>Select Worksurface Color</p> <p>See page 29</p> <p>H</p>	<p>Select Chassis Color</p> <p>See page 29</p> <p>H</p>	<p>Select Drawer Front Color</p> <p>See page 29</p> <p>H</p>
--	---	---	---	---	---	--

CONCINNITY™

Low Credenzas

GSA SIN 33721



Icon Legend on page 19

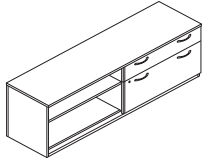

DESCRIPTION	MODEL	SHIP WEIGHT	CUBE	L1 LIST	L2 UPCHARGES		
					WORKSURFACES	CHASSIS	FRONTS
Low Credenza (Bench-Height) 72"W x 20"D x 21½"H, Drawers Right, Bookcase Left (shown)	HNL207221RD2	219	21.6	\$1844	\$16	\$27	\$21
72"W x 20"D x 21½"H, Drawers Left, Bookcase Right	HNL207221LD2	219	21.6	\$1844	\$16	\$27	\$21
60"W x 20"D x 21½"H, Drawers Right, Bookcase Left	HNL206021RD2	187	18.1	\$1657	\$21	\$16	\$21
60"W x 20"D x 21½"H, Drawers Left, Bookcase Right	HNL206021LD2	187	18.1	\$1657	\$21	\$16	\$21

NOTES: Combination storage design comprised of two locking drawers (1-box/supply and 1-file) plus a bookcase. File drawers include integrated hangrails for letter- or legal-sized folders. Bookcase has one adjustable shelf; adjusts in 2½" increments.

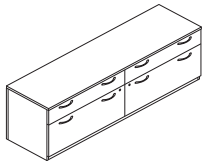

Low Credenza, 2 Box/2 File 72"W x 20"D x 21½"H	HNL207221D4	308	21.6	\$2243	\$16	\$27	\$42
60"W x 20"D x 21½"H	HNL206021D4	260	18.1	\$1986	\$16	\$21	\$42

NOTES: Four locking drawers (2-box/supply and 2-file). File drawers include integrated hangrails for letter- or legal-sized folders.

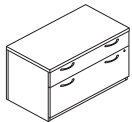

Low Credenza, Box/File 36"W x 20"D x 21½"H	HNL203621D2	143	11.8	\$1300	\$11	\$16	\$21
30"W x 20"D x 21½"H	HNL203021D2	121	10.0	\$1221	\$11	\$16	\$21

NOTES: Unit contains two drawers, one box and one lateral file.

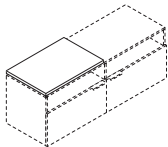

DESCRIPTION	MODEL	SHIP WEIGHT	CUBE	LIST PRICE BY FABRIC GRADE					
				1	2	3	4	5	6
Credenza Cushion 36"W x 20"D x 1"H for 72" and 36"W Low Credenzas	HLSL2036CH2	11	2.2	\$541	\$581	\$621	\$662	\$713	\$765
30"W x 20"D x 1"H for 60" and 30"W Low Credenzas	HLSL2030CH2	9	1.9	\$501	\$539	\$577	\$614	\$662	\$712

NOTES: See pages 22-24 for available fabrics.

Seat cushions are optional; HLSL2036CH2 for 72" and 36"W, HLSL2030CH2 for 60" and 30"W.

! For model HLSL2030CH2 must order two cushions to cover entire 60" Credenza surface.

SPECIFYING EXAMPLE: HLSL2036CH2.APN23

NOTES:

- Versatile, space-saving solutions double as a compact storage unit and convenient bench seat.
- When combined with 29½"H worksurfaces, the 21½"H credenzas can be positioned to create multi-level, overlapping surfaces that optimize floor space, organization and display needs.
- The distinct, clean horizontal planes provide a light scale, layered look.
- Low-heights help facilitate team collaboration.
- Overlapping surfaces can be supported by a 28½"H or 7"H O-leg or 7"H laminate end panel.

HOW TO SPECIFY

Select Model Number	Select Edge Profile and Edge Color	Select Handle and Lock Color	Select Top Color	Select Chassis Color	Select Drawer Front Color
See page 29	See page 29	See page 35	See page 29	See page 29	See page 29
H N L 2 0 7 2 2 1 R D 2 .	B H .	E .	H .	H .	H .

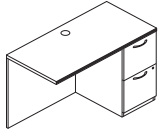

DESCRIPTION	MODEL	SHIP		L1 LIST	L2 UPCHARGES		
		WEIGHT	CUBE		WORKSURFACES	CHASSIS	FRONTS
Return							
48"W x 24"D x 29½"H, Right (shown)	HNL2448RP	141	24.8	\$1363	\$16	\$16	\$11
48"W x 24"D x 29½"H, Left	HNL2448LP	141	24.8	\$1363	\$16	\$16	\$11
42"W x 24"D x 29½"H, Right	HNL2442RP	132	22.0	\$1305	\$16	\$16	\$11
42"W x 24"D x 29½"H, Left	HNL2442LP	132	22.0	\$1305	\$16	\$16	\$11

NOTES: For L-shaped workstations. Connects to single pedestal desk, peninsula (bullet or jetty), or component worksurface with end panel. Drawers lock. Finish of lock is determined by, and aligned with, the handle finish specified. Formal, full-height modesty panel. One cord grommet in top for routing and hiding wires and cables. One cord pass-through grommet is located in the sides of the pedestal and top center of the back (modesty panel) to facilitate reaching wall electrical outlets. Specification logic includes the grommet finish for tops; choose from Black (P) or Platinum (T1). Modesty panel and pedestal grommets are black only. Edgebanding on 42"W and 48"W returns is profiled on the user's side and flat on the back (approach side) and ends. Woodgrain direction on worksurface runs vertical (i.e., front-to-back). Smaller and larger return sizes can be specified using modular worksurface and modesty panel components. Optional stack-on solutions maximize storage space. Ship fully assembled.

See chart on page 48 for cord management options. Worksurfaces/tops, end and modesty panels, and pedestals can be specified with or without grommets. For easy access to wall electrical outlets, options include a short (10") modesty panel or no back panel.

For paper organizers, see pages 715-717.

HOW TO SPECIFY

<p>Select Model Number</p> <p>See page 29</p> <p>H N L 2 4 4 8 R P</p>	<p>Select Edge Profile and Edge Color</p> <p>See page 35</p> <p>B H</p>	<p>Select Handle and Lock Color</p> <p>See page 29</p> <p>E</p>	<p>Select Worksurface Grommet Finish</p> <p>P Black T1 Platinum</p> <p>T 1</p>	<p>Select Worksurface Color</p> <p>See page 29</p> <p>H</p>	<p>Select Chassis Color</p> <p>See page 29</p> <p>H</p>	<p>Select Drawer Front Color</p> <p>See page 29</p> <p>H</p>
--	---	---	--	---	---	--

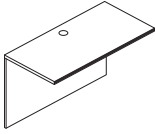

DESCRIPTION	MODEL	SHIP WEIGHT	CUBE	L1 LIST	L2 UPCHARGES	
					WORKSURFACES	CHASSIS
Bridge 48"W x 24"D x 29½"H	HNL2448BF	71	3.0	\$589	\$16	\$16
42"W x 24"D x 29½"H	HNL2442BF	62	2.5	\$563	\$16	\$16

NOTES: For U-shaped workstation layouts. Connects single pedestal desk, peninsula (bullet or jetty), or component worksurface to corner unit or to single pedestal credenza, credenza with lateral file, or rectangle worksurface. Formal, full-height modesty panel. One cord grommet in top for routing and hiding wires and cables. One cord pass-through grommet in top center of back (modesty panel). Specification logic includes the grommet finish for tops; choose from Black (P) or Platinum (T1). Clear inside depth 22⁷/₈"D. Edgebanding on 42"W and 48"W bridges is profiled on the user's side and flat on the back (approach side) and ends. Woodgrain direction on worksurface runs vertical (i.e., front-to-back). Additional sizes, including 30"W and 36"W for use with corner or extended corner units, as well as jetty peninsulas, can be specified using modular worksurface and modesty panel components. Ship — quick, simple assembly. See chart on page 48 for cord management options. Worksurfaces/tops and modesty panels can be specified with or without grommets. For easy access to wall electrical outlets, options include a short (10") modesty panel or no back panel.

HOW TO SPECIFY

<p>Select Model Number</p> <p>H N L 2 4 4 8 B F</p>	<p>Select Edge Profile and Edge Color</p> <p>See page 29</p> <p>B H</p>	<p>Select Worksurface Grommet Finish</p> <p>P Black T1 Platinum</p> <p>P</p>	<p>Select Worksurface Color</p> <p>See page 29</p> <p>H</p>	<p>Select Chassis Color</p> <p>See page 29</p> <p>H</p>
--	--	---	--	--



CONCINNITY™ Stack-on Storage

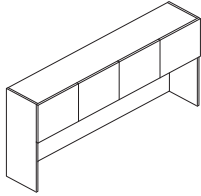

DESCRIPTION

Stack-on Storage, Laminate Doors
 78"W x 15"D x 35¼"H — 4 doors, 2 compartments
 72"W x 15"D x 35¼"H — 4 doors, 2 compartments
 66"W x 15"D x 35¼"H — 4 doors, 2 compartments
 60"W x 15"D x 35¼"H — 4 doors, 2 compartments
 48"W x 15"D x 35¼"H — 3 doors, 2 compartments
 42"W x 15"D x 35¼"H — 2 doors, 1 compartment
 36"W x 15"D x 35¼"H — 2 doors, 1 compartment

MODEL	SHIP WEIGHT	CUBE	L1 LIST	L2 UPCHARGES	
				CHASSIS	FRONTS
HNL3678LD	173	31.8	\$1731	\$48	\$21
HNL3672LD	162	29.0	\$1660	\$37	\$21
HNL3666LD	151	26.7	\$1639	\$37	\$21
HNL3660LD	139	24.3	\$1494	\$37	\$21
HNL3648LD	117	19.6	\$1348	\$32	\$21
HNL3642LD	100	18.1	\$1316	\$32	\$11
HNL3636LD	88	15.3	\$1112	\$32	\$11

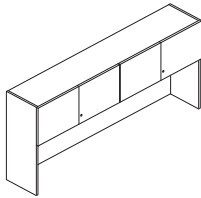

Stack-on Storage, Laminate Locking Doors
 78"W x 15"D x 35¼"H — 4 doors, 2 compartments
 72"W x 15"D x 35¼"H — 4 doors, 2 compartments
 66"W x 15"D x 35¼"H — 4 doors, 2 compartments
 60"W x 15"D x 35¼"H — 4 doors, 2 compartments
 48"W x 15"D x 35¼"H — 3 doors, 2 compartments
 42"W x 15"D x 35¼"H — 2 doors, 1 compartment
 36"W x 15"D x 35¼"H — 2 doors, 1 compartment

HNL3678LL	173	31.8	\$1844	\$48	\$21
HNL3672LL	162	29.0	\$1767	\$37	\$21
HNL3666LL	151	26.7	\$1745	\$37	\$21
HNL3660LL	139	24.3	\$1600	\$37	\$21
HNL3648LL	117	19.6	\$1428	\$32	\$21
HNL3642LL	100	18.1	\$1368	\$32	\$11
HNL3636LL	88	15.3	\$1167	\$32	\$11

ⓘ Lock available in Black (P) or Satin (SA) finish. Lock is core removable. Keyed alike cores must be ordered separately. For stack-on and wall mount storage with locking hinged doors, specify model HF27B (Black) or HF27S (Satin) and the key number, see page 699. Model HNL3648LL has one lock, which secures two of the three doors.

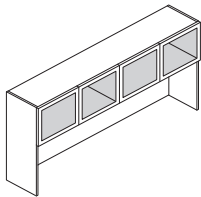

Stack-on Storage, Frosted Doors with Silver Frame
 78"W x 15"D x 35¼"H — 4 doors, 2 compartments
 72"W x 15"D x 35¼"H — 4 doors, 2 compartments
 66"W x 15"D x 35¼"H — 4 doors, 2 compartments
 60"W x 15"D x 35¼"H — 4 doors, 2 compartments
 48"W x 15"D x 35¼"H — 3 doors, 2 compartments
 42"W x 15"D x 35¼"H — 2 doors, 1 compartment
 36"W x 15"D x 35¼"H — 2 doors, 1 compartment

HNL3678FD	153	31.8	\$2565	\$48	N/A
HNL3672FD	143	29.0	\$2493	\$37	N/A
HNL3666FD	134	26.7	\$2471	\$37	N/A
HNL3660FD	124	24.3	\$2325	\$37	N/A
HNL3648FD	104	19.6	\$1973	\$32	N/A
HNL3642FD	89	18.1	\$1736	\$32	N/A
HNL3636FD	79	15.3	\$1532	\$32	N/A

ⓘ Frosted/silver door units do not have a lock option.

NOTES:

- 35¼"H stack-on storage models ship fully assembled.
- Fully enclosed back provides privacy; includes a 1¼", full-width pass-through for 3-prong electrical plugs; facilitates routing cords and reaching wall electrical outlets.
- Lower back panel can be attached with cord pass-through at bottom next to the worksurface or at top for close proximity to task light cord.
- Lower back panel can be removed to facilitate collaboration in teaming configurations.
- Valance hides task light.
- Vertical clearance for computer monitor is 20".
- Laminate vertical paper organizer (HLVPM1) sized to fit below storage compartments.
- Doors are sized to overlap the top, end panels and light valance, to provide a clean design.
- Laminate and frosted/silver door units are equipped with self-closing, adjustable hinges.
- Laminate hinged door units are available with or without a lock.
- For task lights and paper organizers, see pages 714-718.

HOW TO SPECIFY

<p>Select Model Number</p> <p>H N L 3 6 7 2 L D</p>	<p>Select Chassis Color</p> <p>See page 29</p> <p>H</p>	<p>Select Door Front Color</p> <p>See page 29</p> <p>H</p>	
<p>Select Model Number</p> <p>H N L 3 6 7 2 L L</p>	<p>Select Lock Finish</p> <p>See page 29</p> <p>P</p>	<p>Select Chassis Color</p> <p>See page 29</p> <p>H</p>	<p>Select Door Front Color</p> <p>See page 29</p> <p>H</p>
<p>Select Model Number</p> <p>H N L 3 6 7 2 F D</p>	<p>Select Chassis Color</p> <p>See page 29</p> <p>H</p>		

CONCINNITY™

Stack-on Storage

GSA SIN 33721

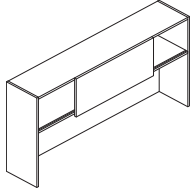

Icon Legend on page 19

**DESCRIPTION****Stack-on Storage, Sliding Door**

78"W x 15"D x 35¼"H
 72"W x 15"D x 35¼"H
 66"W x 15"D x 35¼"H
 60"W x 15"D x 35¼"H
 48"W x 15"D x 35¼"H

MODEL

HNL3678SD
HNL3672SD
HNL3666SD
HNL3660SD
HNL3648SD

SHIP WEIGHT

161
 151
 141
 131
 110

CUBE

31.8
 29.0
 26.7
 24.3
 19.6

L1 LIST

\$1660
\$1610
\$1484
\$1444
\$1365

L2 UPCHARGES**CHASSIS**

\$48
\$37
\$37
\$37
\$32

FRONTS

\$21
\$21
\$21
\$21
\$21

NOTES: Sliding door units have one door per cabinet; standard with black lock, which is located on inside vertical support panel. Lock is core removable. Keyed alike cores must be ordered separately. For stack-on and wall mount storage with sliding door, specify model HF23B (Black) and the key number, see page 699. Sliding door availability limited to select sizes.

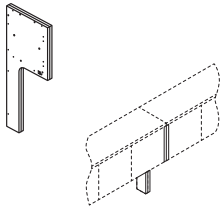
**Stack-on Space Saver End Panels**

¾"W x 14¼"D x 35¼"H

HNL3605SSEP

14

1.7

\$500**\$16****N/A**

NOTES: Two field installable end panels (1-right; 1-left) for use in ganging two stack-on storage units. Combining stack-on allows users to span longer worksurfaces, including 84" (2 - 42"W), 96" (2 - 48"W), 120" (2 - 60"W), and 144" (2 - 72"W). Narrow, space-saving panel size replaces the full 15"D end panels to expand worksurface space. The 4¼" right end panel is to replace the standard 15"D right end panel on one stack-on storage unit, the 4¼" left end panel is to replace the standard 15"D left end panel on a separate, adjacent stack-on storage unit that is in linear alignment with the first unit. Kit includes: (2) narrow end panel supports; European-style fasteners; dowels; joint connector bolts with sleeve nuts (for ganging stack-on storage units). Can be used to connect up to two stack-on storage units in a line (requires 1 kit). Can be specified in a woodgrain or solid laminate color only.

SPECIFYING EXAMPLE: HNL3605SSEP.H

NOTES:

- 35¼"H stack-on storage models ship fully assembled.
- Fully enclosed back provides privacy; includes a 1¼", full-width pass-through for 3-prong electrical plugs; facilitates routing cords and reaching wall electrical outlets.
- Lower back panel can be attached with cord pass-through at bottom next to the worksurface or at top for close proximity to task light cord.
- Lower back panel can be removed to facilitate collaboration in teaming configurations.
- Valance hides task light.
- Vertical clearance for computer monitor is 20".
- Laminate vertical paper organizer (HLVPM1) sized to fit below storage compartments.
- Doors are sized to overlap the top, end panels and light valance, to provide a clean design.
- Laminate and frosted/silver door units are equipped with self-closing, adjustable hinges.
- Laminate hinged door units are available with or without a lock.
- For task lights and paper organizers, see pages 714-718.

HOW TO SPECIFY**Select Model Number**

H N L 3 6 7 2 S D

Select Chassis Color

See page 29

H

Select Door Front Color

See page 29

H



CONCINNITY™ Stack-on Storage

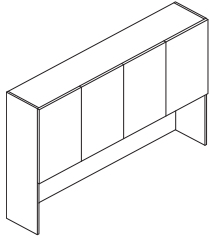

DESCRIPTION

- Stack-on Storage, Laminate Doors**
 78"W x 15"D x 48⁵/₈"H — 4 doors, 2 compartments
 72"W x 15"D x 48⁵/₈"H — 4 doors, 2 compartments
 66"W x 15"D x 48⁵/₈"H — 4 doors, 2 compartments
 60"W x 15"D x 48⁵/₈"H — 4 doors, 2 compartments
 48"W x 15"D x 48⁵/₈"H — 3 doors, 2 compartments
 42"W x 15"D x 48⁵/₈"H — 2 doors, 1 compartment
 36"W x 15"D x 48⁵/₈"H — 2 doors, 1 compartment

MODEL	SHIP WEIGHT	CUBE	L1 LIST	L2 UPCHARGES	
				CHASSIS	FRONTS
HNL4978LD	264	31.3	\$2336	\$63	\$21
HNL4972LD	243	29.1	\$2149	\$53	\$21
HNL4966LD	229	26.8	\$2032	\$53	\$21
HNL4960LD	212	24.5	\$1890	\$53	\$21
HNL4948LD	175	26.4	\$1803	\$48	\$21
HNL4942LD	149	23.2	\$1581	\$48	\$21
HNL4936LD	145	20.3	\$1529	\$48	\$21

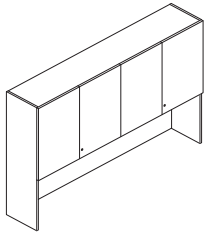

- Stack-on Storage, Laminate Locking Doors**
 78"W x 15"D x 48⁵/₈"H — 4 doors, 2 compartments
 72"W x 15"D x 48⁵/₈"H — 4 doors, 2 compartments
 66"W x 15"D x 48⁵/₈"H — 4 doors, 2 compartments
 60"W x 15"D x 48⁵/₈"H — 4 doors, 2 compartments
 48"W x 15"D x 48⁵/₈"H — 3 doors, 2 compartments
 42"W x 15"D x 48⁵/₈"H — 2 doors, 1 compartment
 36"W x 15"D x 48⁵/₈"H — 2 doors, 1 compartment

HNL4978LL	264	31.3	\$2442	\$63	\$21
HNL4972LL	243	29.1	\$2256	\$53	\$21
HNL4966LL	229	26.8	\$2139	\$53	\$21
HNL4960LL	212	24.5	\$1996	\$53	\$21
HNL4948LL	175	26.4	\$1881	\$48	\$21
HNL4942LL	149	23.2	\$1634	\$48	\$21
HNL4936LL	145	20.3	\$1583	\$48	\$21

! Lock available in Black (P) or Satin (SA) finish. Lock is core removable. Keyed alike cores must be ordered separately. For stack-on and wall mount storage with locking hinged doors, specify model HF27B (Black) or HF27S (Satin) and the key number, see page 699. Model HNL4948LL has one lock, which secures two of the three doors.

NOTES:

- 48⁵/₈"H units have a fixed, intermittent shelf; storage space above and below the shelf is 12⁵/₈".
- Product applications are detailed on pages 37-38.
- Fully enclosed back provides privacy; includes a 1¹/₄", full-width pass-through for 3-prong electrical plugs; facilitates routing cords and reaching wall electrical outlets.
- Lower back panel can be attached with cord pass-through at bottom next to the worksurface or at top for close proximity to task light cord.
- Lower back panel can be removed to facilitate collaboration in teaming configurations.
- Valance hides task light.
- Vertical clearance for computer monitor is 20".
- Laminate vertical paper organizer (HLVPM1) sized to fit below storage compartments.
- Doors are sized to overlap the top, end panels and light valance, to provide a clean design.
- Laminate and frosted/silver door units are equipped with self-closing, adjustable hinges.
- Laminate hinged door units are available with or without a lock.
- For task lights and paper organizers, see pages 714-718.

HOW TO SPECIFY

<p>Select Model Number</p> <p>H N L 4 9 7 8 L D</p>	<p>Select Chassis Color</p> <p>See page 29</p> <p>H</p>	<p>Select Door Front Color</p> <p>See page 29</p> <p>H</p>	
<p>Select Model Number</p> <p>H N L 4 9 7 8 L L</p>	<p>Select Lock Finish</p> <p>See page 29</p> <p>P</p>	<p>Select Chassis Color</p> <p>See page 29</p> <p>H</p>	<p>Select Door Front Color</p> <p>See page 29</p> <p>H</p>

CONCINNITY™

Stack-on Storage

GSA SIN 33721



Icon Legend on page 19

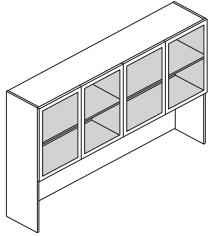

DESCRIPTION	MODEL	SHIP WEIGHT	CUBE	L1 LIST	L2 UPCHARGES	
					CHASSIS	FRONTS
Stack-on Storage, Frosted Doors with Silver Frame						
78"W x 15"D x 48 $\frac{5}{8}$ "H — 4 doors, 2 compartments	HNL4978FD	225	31.3	\$3583	\$63	N/A
72"W x 15"D x 48 $\frac{5}{8}$ "H — 4 doors, 2 compartments	HNL4972FD	207	29.1	\$3396	\$53	N/A
66"W x 15"D x 48 $\frac{5}{8}$ "H — 4 doors, 2 compartments	HNL4966FD	196	26.8	\$3280	\$53	N/A
60"W x 15"D x 48 $\frac{5}{8}$ "H — 4 doors, 2 compartments	HNL4960FD	182	24.5	\$3133	\$53	N/A
48"W x 15"D x 48 $\frac{5}{8}$ "H — 3 doors, 2 compartments	HNL4948FD	152	26.4	\$2739	\$48	N/A
42"W x 15"D x 48 $\frac{5}{8}$ "H — 2 doors, 1 compartment	HNL4942FD	128	23.2	\$2209	\$48	N/A
36"W x 15"D x 48 $\frac{5}{8}$ "H — 2 doors, 1 compartment	HNL4936FD	114	20.3	\$2156	\$48	N/A

Frosted/silver door units do not have a lock option.

NOTES:

- 48 $\frac{5}{8}$ "H units have a fixed, intermittent shelf; storage space above and below the shelf is 12 $\frac{5}{8}$ ".
- Product applications are detailed on pages 37-38.
- Fully enclosed back provides privacy; includes a 1 $\frac{1}{4}$ ", full-width pass-through for 3-prong electrical plugs; facilitates routing cords and reaching wall electrical outlets.
- Lower back panel can be attached with cord pass-through at bottom next to the worksurface or at top for close proximity to task light cord.
- Lower back panel can be removed to facilitate collaboration in teaming configurations.
- Valance hides task light.
- Vertical clearance for computer monitor is 20".
- Laminate vertical paper organizer (HLVPM1) sized to fit below storage compartments.
- Doors are sized to overlap the top, end panels and light valance, to provide a clean design.
- Laminate and frosted/silver door units are equipped with self-closing, adjustable hinges.
- Laminate hinged door units are available with or without a lock.
- For task lights and paper organizers, see pages 714-718.

HOW TO SPECIFY

Select
Model Number

H N L 4 9 7 8 F D

Select
Chassis Color

See page 29

H



CONCINNITY™

Stack-on Storage

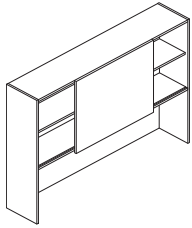
**DESCRIPTION****Stack-on Storage, Sliding Door**

78"W x 15"D x 48⁵/₈"H
 72"W x 15"D x 48⁵/₈"H
 66"W x 15"D x 48⁵/₈"H
 60"W x 15"D x 48⁵/₈"H
 48"W x 15"D x 48⁵/₈"H

MODEL

HNL4978SD
HNL4972SD
HNL4966SD
HNL4960SD
HNL4948SD

COM**SHIP WEIGHT****CUBE****L1 LIST****L2 UPCHARGES**
CHASSIS FRONTS

COM	SHIP WEIGHT	CUBE	L1 LIST	L2 UPCHARGES CHASSIS	L2 UPCHARGES FRONTS
	236	31.3	\$2371	\$63	\$21
	221	29.1	\$2243	\$53	\$21
	207	26.8	\$2191	\$53	\$21
	192	24.5	\$1932	\$53	\$21
	162	26.4	\$1840	\$48	\$21

NOTES: Sliding door units have one door per cabinet; standard with black lock, which is located on inside vertical support panel. Lock is core removable. Keyed alike cores must be ordered separately. For stack-on and wall mount storage with sliding door, specify model HF23B (Black) and the key number, see page 699. Sliding door availability limited to select sizes.

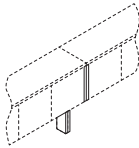
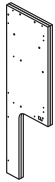
**Stack-on Space Saver End Panels**

3/4"W x 14 1/4"D x 48⁵/₈"H

HNL4905SSEP

23

2.2

\$672**\$16****N/A**

NOTES: Two field installable end panels (1-right; 1-left) for use in ganging two stack-on storage units. Combining stack-on allows users to span longer worksurfaces, including 84" (2 - 42"W), 96" (2 - 48"W), 120" (2 - 60"W), and 144" (2 - 72"W). Narrow, space-saving panel size replaces the full 15"D end panels to expand worksurface space. The 4 1/4" right end panel is to replace the standard 15"D right end panel on one stack-on storage unit, the 4 1/4" left end panel is to replace the standard 15"D left end panel on a separate, adjacent stack-on storage unit that is in linear alignment with the first unit. Kit includes: (2) narrow end panel supports; European-style fasteners; dowels; joint connector bolts with sleeve nuts (for ganging stack-on storage units). Can be used to connect up to two stack-on storage units in a line (requires 1 kit). Can be specified in a woodgrain or solid laminate color only.

SPECIFYING EXAMPLE: HNL4905SSEP.H

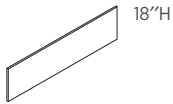

18"H

Tackboards for use with Stack-on Storage

75"W - for 78"W
 69"W - for 72"W
 63"W - for 66"W
 57"W - for 60"W
 45"W - for 48"W
 39"W - for 42"W
 33"W - for 36"W
 26³/₄"W

H90057
H90056
H90055
H90054
H90053
H90052
H90051
H90050

3.0
 2.0
 2.0
 2.0
 2.0
 2.0
 1.0
 1.0

13
 12
 11
 10
 8
 7
 6
 5

3.2
 2.7
 2.5
 2.2
 1.8
 1.6
 1.4
 1.2

\$427
\$405
\$385
\$339
\$325
\$300
\$264
\$264

N/A
N/A
N/A
N/A
N/A
N/A
N/A
N/A

N/A
N/A
N/A
N/A
N/A
N/A
N/A
N/A

NOTES: Specify fabric, see pages 25-26. Upcharges may apply to premium fabric grades.

Disperse (DISP) fabric not available on sizes wider than 60". Analog (ANLG) and Exchange (EXG) not available on sizes wider than 60".

SPECIFYING EXAMPLE: H90057.APN15

NOTES:

- 48⁵/₈"H units have a fixed, intermittent shelf; storage space above and below the shelf is 12⁵/₈".
- Fully enclosed back provides privacy; includes a 1/4", full-width pass-through for 3-prong electrical plugs; facilitates routing cords and reaching wall electrical outlets.
- Lower back panel can be attached with cord pass-through at bottom next to the worksurface or at top for close proximity to task light cord.
- Lower back panel can be removed to facilitate collaboration in teaming configurations.
- Valance hides task light.
- Vertical clearance for computer monitor is 20".
- Laminate vertical paper organizer (HLVPM1) sized to fit below storage compartments.
- Doors are sized to overlap the top, end panels and light valance, to provide a clean design.
- Laminate and frosted/silver door units are equipped with self-closing, adjustable hinges.
- Laminate hinged door units are available with or without a lock.
- For task lights and paper organizers, see pages 714-718.

HOW TO SPECIFY**Select Model Number**

H N L 4 9 7 8 S D

Select Chassis Color

See page 29

H

Select Door Front Color

See page 29

H

CONCINNITY™

Wall Mount Storage

GSA SIN 33721

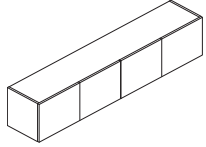

Icon Legend on page 19

**DESCRIPTION****Wall Mount Storage, Laminate Doors**

78"W x 15"D x 15"H — 4 doors, 2 compartments
 72"W x 15"D x 15"H — 4 doors, 2 compartments
 66"W x 15"D x 15"H — 4 doors, 2 compartments
 60"W x 15"D x 15"H — 4 doors, 2 compartments
 48"W x 15"D x 15"H — 3 doors, 2 compartments
 42"W x 15"D x 15"H — 2 doors, 1 compartment
 36"W x 15"D x 15"H — 2 doors, 1 compartment
 30"W x 15"D x 15"H — 2 doors, 1 compartment

MODEL	SHIP WEIGHT	CUBE	L1 LIST	L2 UPCHARGES	
				CHASSIS	FRONTS
HNL1578LD	126	17.1	\$1631	\$37	\$21
HNL1572LD	118	15.9	\$1515	\$27	\$21
HNL1566LD	109	14.6	\$1444	\$27	\$21
HNL1560LD	100	13.3	\$1296	\$27	\$21
HNL1548LD	83	10.9	\$1170	\$21	\$21
HNL1542LD	68	9.7	\$1105	\$21	\$11
HNL1536LD	60	8.4	\$1008	\$21	\$11
HNL1530LD	51	7.2	\$931	\$21	\$11

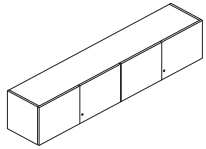
**Wall Mount Storage, Laminate Locking Doors**

78"W x 15"D x 15"H — 4 doors, 2 compartments
 72"W x 15"D x 15"H — 4 doors, 2 compartments
 66"W x 15"D x 15"H — 4 doors, 2 compartments
 60"W x 15"D x 15"H — 4 doors, 2 compartments
 48"W x 15"D x 15"H — 3 doors, 2 compartments
 42"W x 15"D x 15"H — 2 doors, 1 compartment
 36"W x 15"D x 15"H — 2 doors, 1 compartment
 30"W x 15"D x 15"H — 2 doors, 1 compartment

HNL1578LL	126	17.1	\$1736	\$37	\$21
HNL1572LL	118	15.9	\$1620	\$27	\$21
HNL1566LL	109	14.6	\$1550	\$27	\$21
HNL1560LL	100	13.3	\$1403	\$27	\$21
HNL1548LL	83	10.9	\$1250	\$21	\$21
HNL1542LL	68	9.7	\$1157	\$21	\$11
HNL1536LL	60	8.4	\$1062	\$21	\$11
HNL1530LL	51	7.2	\$985	\$21	\$11

ⓘ Lock available in Black (P) or Satin (SA) finish. Lock is core removable. Keyed alike cores must be ordered separately. For stack-on and wall mount storage with locking hinged doors, specify model HF27B (Black) or HF27S (Satin) and the key number, see page 699. Model HNL1548LL has one lock, which secures two of the three doors.

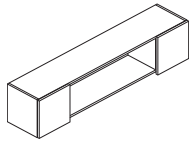
**Wall Mount Open Hutch, Laminate Doors**

78"W x 15"D x 15"H
 72"W x 15"D x 15"H
 66"W x 15"D x 15"H
 60"W x 15"D x 15"H
 48"W x 15"D x 15"H

HNL1578LO	123	17.3	\$1893	\$37	\$37
HNL1572LO	115	16.1	\$1762	\$37	\$37
HNL1566LO	106	14.8	\$1614	\$32	\$32
HNL1560LO	97	13.6	\$1462	\$32	\$32
HNL1548LO	80	11.1	\$1310	\$32	\$32

NOTES:

- Doors are sized to overlap the top, end panels and light valance, to provide a clean design.
- Laminate and frosted/silver door units are equipped with self-closing, adjustable hinges.
- Laminate hinged door units are available with or without a lock.
- For task lights and paper organizers, see pages 714-718.
- **IMPORTANT: See installation guidelines at top of page 39.**

HOW TO SPECIFY

Select Model Number H N L 1 5 7 8 L D	Select Chassis Color See page 29 H	Select Door Front Color See page 29 H	
Select Model Number H N L 1 5 7 8 L L	Select Lock Finish See page 29 P	Select Chassis Color See page 29 H	Select Door Front Color See page 29 H

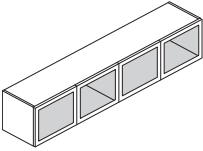
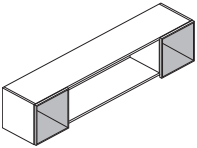
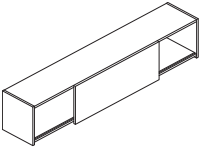

CONCINNITY™ Wall Mount Storage

DESCRIPTION	MODEL	SHIP WEIGHT	CUBE	L1 LIST	L2 UPCHARGES	
					CHASSIS	FRONTS
 <p>Wall Mount Storage, Frosted Doors with Silver Frame 78"W x 15"D x 15"H — 4 doors, 2 compartments 72"W x 15"D x 15"H — 4 doors, 2 compartments 66"W x 15"D x 15"H — 4 doors, 2 compartments 60"W x 15"D x 15"H — 4 doors, 2 compartments 48"W x 15"D x 15"H — 3 doors, 2 compartments 42"W x 15"D x 15"H — 2 doors, 1 compartment 36"W x 15"D x 15"H — 2 doors, 1 compartment 30"W x 15"D x 15"H — 2 doors, 1 compartment</p>	HNL1578FD	106	17.1	\$2465	\$37	N/A
	HNL1572FD	99	15.9	\$2347	\$27	N/A
	HNL1566FD	92	14.6	\$2274	\$27	N/A
	HNL1560FD	85	13.3	\$2126	\$27	N/A
	HNL1548FD	71	10.9	\$1793	\$21	N/A
	HNL1542FD	57	9.7	\$1525	\$21	N/A
	HNL1536FD	50	8.4	\$1428	\$21	N/A
	HNL1530FD	43	7.2	\$1350	\$21	N/A
 <p>Wall Mount Open Hutch, Frosted Doors with Silver Frame 78"W x 15"D x 15"H 72"W x 15"D x 15"H 66"W x 15"D x 15"H 60"W x 15"D x 15"H 48"W x 15"D x 15"H</p> <p>! Frosted door models do not have a lock option.</p>	HNL1578FO	103	17.3	\$2522	\$37	\$37
	HNL1572FO	96	16.1	\$2390	\$37	\$37
	HNL1566FO	89	14.8	\$2242	\$32	\$32
	HNL1560FO	82	13.6	\$2092	\$32	\$32
	HNL1548FO	68	11.1	\$1939	\$32	\$32
 <p>Wall Mount Storage, Sliding Door 78"W x 15"D x 15"H 72"W x 15"D x 15"H 66"W x 15"D x 15"H 60"W x 15"D x 15"H 48"W x 15"D x 15"H</p> <p>NOTES: One door per unit. Standard with black lock, which is located on the inside vertical support panel. Lock is core removable. Keyed alike cores must be ordered separately. For stack-on and wall mount storage with sliding door, specify model HF23B (Black) and the key number, see page 699.</p>	HNL1578SD	114	17.1	\$1586	\$37	\$21
	HNL1572SD	107	15.9	\$1456	\$27	\$21
	HNL1566SD	99	14.6	\$1358	\$27	\$21
	HNL1560SD	91	13.3	\$1234	\$27	\$21
	HNL1548SD	76	10.9	\$1155	\$21	\$21

NOTES:

- Doors are sized to overlap the top, end panels and light valance, to provide a clean design.
- Laminate and frosted/silver door units are equipped with self-closing, adjustable hinges.
- Laminate hinged door units are available with or without a lock.
- For task lights and paper organizers, see pages 714-718.
- **IMPORTANT: See installation guidelines at top of page 39.**

HOW TO SPECIFY

<p>Select Model Number</p> <p>H N L 1 5 7 8 F D</p>	<p>Select Chassis Color</p> <p>See page 29</p> <p>H</p>	
<p>Select Model Number</p> <p>H N L 1 5 7 8 S D</p>	<p>Select Chassis Color</p> <p>See page 29</p> <p>H</p>	<p>Select Door Front Color</p> <p>See page 29</p> <p>H</p>

CONCINNITY™

Wall Mount Storage

GSA SIN 33721

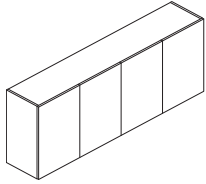

Icon Legend on page 19

**DESCRIPTION****Wall Mount Storage, Laminate Doors**

78"W x 15"D x 28½"H — 4 doors, 2 compartments
 72"W x 15"D x 28½"H — 4 doors, 2 compartments
 66"W x 15"D x 28½"H — 4 doors, 2 compartments
 60"W x 15"D x 28½"H — 4 doors, 2 compartments
 48"W x 15"D x 28½"H — 3 doors, 2 compartments
 42"W x 15"D x 28½"H — 2 doors, 1 compartment
 36"W x 15"D x 28½"H — 2 doors, 1 compartment
 30"W x 15"D x 28½"H — 2 doors, 1 compartment

MODEL	SHIP WEIGHT	CUBE	L1 LIST	L2 UPCHARGES	
				CHASSIS	FRONTS
HNL2978LD	213	30.8	\$1976	\$53	\$42
HNL2972LD	199	28.6	\$1874	\$42	\$42
HNL2966LD	185	26.4	\$1816	\$42	\$42
HNL2960LD	170	24.1	\$1686	\$42	\$42
HNL2948LD	142	19.7	\$1537	\$37	\$32
HNL2942LD	116	17.4	\$1262	\$37	\$21
HNL2936LD	101	15.2	\$1203	\$37	\$21
HNL2930LD	87	12.9	\$1075	\$37	\$21

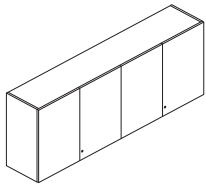
**Wall Mount Storage, Laminate Locking Doors**

78"W x 15"D x 28½"H — 4 doors, 2 compartments
 72"W x 15"D x 28½"H — 4 doors, 2 compartments
 66"W x 15"D x 28½"H — 4 doors, 2 compartments
 60"W x 15"D x 28½"H — 4 doors, 2 compartments
 48"W x 15"D x 28½"H — 3 doors, 2 compartments
 42"W x 15"D x 28½"H — 2 doors, 1 compartment
 36"W x 15"D x 28½"H — 2 doors, 1 compartment
 30"W x 15"D x 28½"H — 2 doors, 1 compartment

HNL2978LL	213	30.8	\$2082	\$53	\$42
HNL2972LL	199	28.6	\$1981	\$42	\$42
HNL2966LL	185	26.4	\$1922	\$42	\$42
HNL2960LL	170	24.1	\$1793	\$42	\$42
HNL2948LL	142	19.7	\$1617	\$37	\$32
HNL2942LL	116	17.4	\$1316	\$37	\$21
HNL2936LL	101	15.2	\$1257	\$37	\$21
HNL2930LL	87	12.9	\$1128	\$37	\$21

! Lock available in Black (P) or Satin (SA) finish. Lock is core removable. Keyed alike cores must be ordered separately. For stack-on and wall mount storage with locking hinged doors, specify model HF27B (Black) or HF27S (Satin) and the key number, see page 699. Model HNL2948LL has one lock, which secures two of the three doors.

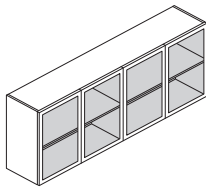
**Wall Mount Storage, Frosted Doors with Silver Frame**

78"W x 15"D x 28½"H — 4 doors, 2 compartments
 72"W x 15"D x 28½"H — 4 doors, 2 compartments
 66"W x 15"D x 28½"H — 4 doors, 2 compartments
 60"W x 15"D x 28½"H — 4 doors, 2 compartments
 48"W x 15"D x 28½"H — 3 doors, 2 compartments
 42"W x 15"D x 28½"H — 2 doors, 1 compartment
 36"W x 15"D x 28½"H — 2 doors, 1 compartment
 30"W x 15"D x 28½"H — 2 doors, 1 compartment

HNL2978FD	174	30.8	\$3221	\$53	N/A
HNL2972FD	163	28.6	\$3119	\$42	N/A
HNL2966FD	152	26.4	\$3061	\$42	N/A
HNL2960FD	140	24.1	\$2930	\$42	N/A
HNL2948FD	118	19.7	\$2472	\$37	N/A
HNL2942FD	94	17.4	\$1888	\$37	N/A
HNL2936FD	83	15.2	\$1829	\$37	N/A
HNL2930FD	72	12.9	\$1697	\$37	N/A

! Frosted door models do not have a lock option.

NOTES:

- Doors are sized to overlap the top, end panels and light valance, to provide a clean design.
- Laminate and frosted/silver door units are equipped with self-closing, adjustable hinges.
- Laminate hinged door units are available with or without a lock.
- 28½"H units have a fixed, intermittent shelf; storage space above and below the shelf is 12⅝".
- For task lights and paper organizers, see pages 714-718.
- **IMPORTANT: See installation guidelines at top of page 39.**

HOW TO SPECIFY

Select Model Number <input type="text" value="HNL2978LD"/>	Select Chassis Color See page 29 <input type="text" value="H"/>	Select Door Front Color See page 29 <input type="text" value="H"/>	
Select Model Number <input type="text" value="HNL2978LL"/>	Select Lock Finish See page 29 <input type="text" value="P"/>	Select Chassis Color See page 29 <input type="text" value="H"/>	Select Door Front Color See page 29 <input type="text" value="H"/>
Select Model Number <input type="text" value="HNL2978FD"/>	Select Chassis Color See page 29 <input type="text" value="H"/>		



CONCINNITY™ Wall Mount Storage

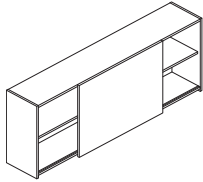

DESCRIPTION	MODEL	COM	SHIP WEIGHT	CUBE	L1 LIST	L2 UPCHARGES	
						CHASSIS	FRONTS
Wall Mount Storage, Sliding Door							
78"W x 15"D x 28½"H	HNL2978SD		189	30.8	\$2055	\$53	\$42
72"W x 15"D x 28½"H	HNL2972SD		177	28.6	\$1960	\$42	\$42
66"W x 15"D x 28½"H	HNL2966SD		165	26.4	\$1914	\$42	\$42
60"W x 15"D x 28½"H	HNL2960SD		153	24.1	\$1792	\$42	\$42
48"W x 15"D x 28½"H	HNL2948SD		129	19.7	\$1572	\$37	\$32

NOTES: One door per unit. Standard with black lock, which is located on the inside vertical support panel. Lock is core removable. Keyed alike cores must be ordered separately. For stack-on and wall mount storage with sliding door, specify model HF23B (Black) and the key number, see page 699.

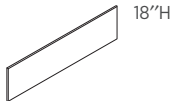

Tackboards for use with Wall Mount Storage

75"W - for 78"W	H90057	3.0	13	3.2	\$427	N/A	N/A
68¾"W - for 72"W	H90056	2.0	12	2.7	\$405	N/A	N/A
62¾"W - for 66"W	H90055	2.0	11	2.5	\$385	N/A	N/A
56¾"W - for 60"W	H90054	2.0	10	2.2	\$339	N/A	N/A
44¾"W - for 48"W	H90053	2.0	8	1.8	\$325	N/A	N/A
39"W - for 42"W	H90052	2.0	7	1.6	\$300	N/A	N/A
33"W - for 36"W	H90051	1.0	6	1.4	\$264	N/A	N/A
26¾"W	H90050	1.0	5	1.2	\$264	N/A	N/A

NOTES: Specify fabric, see pages 25-26. Upcharges may apply to premium fabric grades.

Tackboard widths differ slightly from the wall mounted storage cabinet widths. For applications where multiple wall mounted storage units are placed side-by-side, the preferred tackboard solution may be to utilize a larger tackboard size. For example, H90057 = 75"W; H90056 = 68¾"W; H90055 = 62¾"W; H90054 = 56¾"W.

ⓘ Disperse (DISP) fabric not available on sizes wider than 60". Analog (ANLG) and Exchange (EXG) not available on sizes wider than 60".

SPECIFYING EXAMPLE: H90057.APN15

NOTES:

- Valance hides task light.
- Doors are sized to overlap the top, end panels and light valance, to provide a clean design.
- Laminate and frosted/silver door units are equipped with self-closing, adjustable hinges.
- Laminate hinged door units are available with or without a lock.
- 28½"H units have a fixed, intermittent shelf; storage space above and below the shelf is 12⅝".
- For task lights and paper organizers, see pages 714-718.
- **IMPORTANT: See installation guidelines at top of page 39.**

HOW TO SPECIFY

<p>Select Model Number</p> <p>See page 29</p> <p>H N L 2 9 7 8 S D</p>	<p>Select Chassis Color</p> <p>See page 29</p> <p>H</p>	<p>Select Door Front Color</p> <p>See page 29</p> <p>H</p>
--	---	--

CONCINNITY™

Bookcase Hutches

GSA SIN 33721

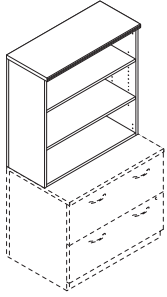

Icon Legend on page 19

**DESCRIPTION****Bookcase Hutch, No Doors/Open**

36"W x 14¼"D x 35¼"H (shown)
30"W x 14¼"D x 35¼"H

36"W x 14¼"D x 48⅝"H
30"W x 14¼"D x 48⅝"H

MODEL**SHIP WEIGHT****CUBE****L1 LIST****L2 UPCHARGES****CHASSIS****FRONTS**

HNL3636BHxD
HNL3630BHxD

213
199

15.3
12.5

\$766
\$750

\$16
\$16

N/A
N/A

HNL4936BHxD
HNL4930BHxD

213
199

125.0
109.0

\$967
\$904

\$27
\$27

N/A
N/A

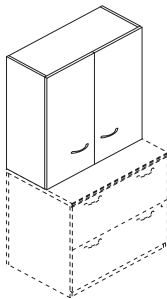
**Bookcase Hutch, Laminate Doors**

36"W x 15"D x 35¼"H (shown)
30"W x 15"D x 35¼"H

36"W x 15"D x 48⅝"H
30"W x 15"D x 48⅝"H

HNL3636BHLD
HNL3630BHLD

213
199

15.3
12.5

\$990
\$928

\$16
\$16

\$21
\$21

HNL4936BHLD
HNL4930BHLD

213
199

165.0
142.0

\$1187
\$1112

\$27
\$27

\$32
\$32

NOTES:

- Designed for use on worksurfaces, or on 30" or 36" W x 29½" H lateral file or storage cabinet with doors.
- Two widths, 30" and 36"; two heights, 35¼" and 48⅝".
- The 35¼" H unit has three shelves, two are adjustable in 1¼" increments with a total range of 17½"; bottom shelf is fixed.
- The 48⅝" H unit has four shelves, three are adjustable in 1¼" increments with a total range of 25"; bottom shelf is fixed.
- Door units equipped with self-closing, adjustable hinges.
- Laminate doors have decorative handles.
- Frosted door units have push/touch latch release.
- Doors are non-locking.
- To align with the top of the 35¼" H bookcase hutch, use 64¾" H floor-standing storage models; to align with the top of the 48⅝" H bookcase hutch, use 78⅝" H models.
- Ship fully assembled.

HOW TO SPECIFY

Select
Model Number

H N L 3 6 3 6 B H X D .

Select
Laminate Color

See page 29

H

Select
Model Number

H N L 3 6 3 6 B H L D .

Select
Handle and Lock Color

See page 35

E

Select
Chassis Color

See page 29

H

Select
Door Front Color

See page 29

H



CONCINNITY™

Bookcase Hutches

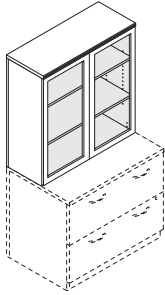
**DESCRIPTION**

Bookcase Hutch, Frosted Doors with Silver Frame
36"W x 15"D x 35¼"H (shown)

36"W x 15"D x 48⅝"H

MODEL	SHIP WEIGHT	CUBE	L1 LIST	L2 UPCHARGES	
				CHASSIS	FRONTS
HNL3636BHFD	199	15.3	\$1817	\$16	N/A
HNL4936BHFD	213	134.0	\$2219	\$27	N/A

NOTES:

- Designed for use on worksurfaces, or on 30" or 36"W x 29½"H lateral file or storage cabinet with doors.
- Two widths, 30" and 36"; two heights, 35¼" and 48⅝".
- The 35¼"H unit has three shelves, two are adjustable in 1¼" increments with a total range of 17½"; bottom shelf is fixed.
- The 48⅝"H unit has four shelves, three are adjustable in 1¼" increments with a total range of 25"; bottom shelf is fixed.
- Door units equipped with self-closing, adjustable hinges.
- Laminate doors have decorative handles.
- Frosted door units have push/touch latch release.
- Doors are non-locking.
- To align with the top of the 35¼"H bookcase hutch, use 64¾"H floor-standing storage models; to align with the top of the 48⅝"H bookcase hutch, use 78⅝"H models.
- Ship fully assembled.

HOW TO SPECIFY

Select
Model Number

H N L 3 6 3 6 B H F D .

Select
Chassis Color

See page 29

H

CONCINNITY™ Reception Stations

GSA SIN 33721



Icon Legend on page 19

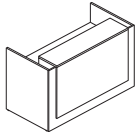

DESCRIPTION	MODEL	SHIP WEIGHT	CUBE	L1 LIST	L2 UPCHARGES		ACCENT PANEL
					WORKSURFACE	CHASSIS	
Reception Desk with Transaction Counter 72"W x 36¾"D x 44"H	HLAM3772RD	324	13.5	\$1821	\$37	\$74	\$27

NOTES: Non-handed. Counter measures 60"W x 15¼"D. Flat edge (G) matches 10500 Series™. For beaded (B) and tri-oval (V) edge shapes, the transaction counter is profiled on the approach and user sides, and the desk worksurface is profiled on the user's side. Beaded (B) and tri-oval (V) edges are available in L1 woodgrains colors only. Smooth and flat (G) edge available in all woodgrains and solid colors. Vertical grain on approach side and front accent panel for L1 laminates except Kingswood Walnut and Florence Walnut. Horizontal grain on L2 laminates and Kingswood and Florence Walnut. Vertical grain on end panels and horizontal grain on worksurface and transaction counter. Two worksurface cord management grommets for routing and hiding wires and cables; can be specified in Black (P) or Platinum (TI) finish.

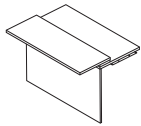

Reception Return with 32'H Transaction Counter 48¼"W x 32⅞"D x 32"H	HLAM3348RR	145	3.7	\$1025	\$37	\$37	N/A
---	-------------------	-----	-----	---------------	-------------	-------------	------------

NOTES: Non-handed. For use with HLAM3772RD and Reception Desk Shell (H105724). Counter facilitates accessibility; measures 48"W x 12"D x 32"H. Flat edge (G) matches 10500 Series™. For beaded (B) and tri-oval (V) edge shapes, the transaction counter is profiled on the approach side, and the return worksurface is profiled on the user's side. All other edges are flat banded. Beaded (B) and tri-oval (V) available in L1 woodgrain colors only. Flat edge (G) available in all woodgrains and solid colors. Pattern laminates do not have matching edge color; patterns can be specified with woodgrain or solid edge. Vertical grain on approach side, end panel, worksurface, and transaction counter. Assembly required. Cam covers used to allow for non-handed design.

Specify: Model.Edge Profile & EdgeColor.Worksurface & Counter Color.Chassis Color

SPECIFYING EXAMPLE: HLAM3348RR.GN.N.N

HOW TO SPECIFY

<p>Select Model Number</p> <p>HLAM3772RD</p>	<p>Select Edge Profile and Edge Color</p> <p>See page 29</p> <p>GN</p>	<p>Select Grommet Color</p> <p>P Black TI Platinum Not specified for model HLAM3348RR</p> <p>P</p>	<p>Select Worksurface Laminate</p> <p>See page 29</p> <p>N</p>	<p>Select Chassis Laminate</p> <p>See page 29</p> <p>N</p>	<p>Select Accent Panel Laminate</p> <p>See page 29 Not specified for model HLAM3348RR</p> <p>LDW1</p>
---	---	---	---	---	--

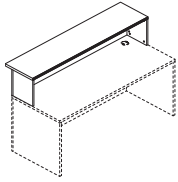

DESCRIPTION

Reception Station Counter for Desk
72"W x 17"D x 14⁵/₈"H

MODEL	SHIP WEIGHT	CUBE	L1 LIST	L2 UPCHARGES	
				COUNTER	CHASSIS
HNL1772RT	74	4.3	\$725	\$11	\$16

Compatible for use on 72"W x 30" or 36"D desktops and worksurfaces. For cleanest approach-side aesthetic, use on desk built with modular components; desk comprised of either 72"W x 30"D rectangle worksurface and 72"W x 27⁷/₈"H modesty/back panel, supported by 29¹/₈"D pedestal(s) and/or end panel(s), or 72"W x 36"D worksurface and 72"W x 27⁷/₈"H modesty/back panel, supported by 35"D left and right end panels. The counter is 17"D with a 4" approach-side overhang; end panels are 12³/₈"D. Ships with Transaction counter organizer (model HTCOL52) is available as an option; fits under transaction counter; organizer is available in black only.

SPECIFYING EXAMPLE: HNL1772RT.BH.H.H

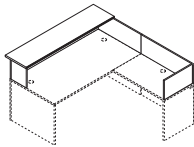

For Station with Right Return

L-Reception Station with Transaction Counter for Desk (NON-HANDED)

72"W x 88"D x 14⁵/₈"H
72"W x 82"D x 14⁵/₈"H

HNL8472RT	103	4.5	\$1155	\$11	\$27
HNL7872RT	101	4.5	\$1127	\$11	\$27

NOTES: Non-Handed can be configured left-hand or right-hand. Intended for use on desk built with modular components, for clean approach-side aesthetic, connected to a return or modular return. Layout for 78" and 84"D footprints:

- 72"W x 78"D:
 - Desk = 72"W x 30"D worksurface, 72"W x 27⁷/₈"H modesty/back panel, supported by 29¹/₈"D pedestal(s) and/or end panel(s).
 - Return = 48"W x 24"D return; or 48"W x 24"D worksurface with vertical grain, 48"W x 27⁷/₈"H modesty/back panel, supported by a 23¹/₈"D pedestal and/or end panel.
- 72"W x 84"D:
 - Desk = 72"W x 36"D worksurface, 72"W x 27⁷/₈"H modesty/back panel, supported by 1-left and 1-right 35"D panel.
 - Return = 42"W x 24"D return; or 42"W x 24"D worksurface with vertical grain, 42"W x 27⁷/₈"H modesty/back panel, supported by a 23¹/₈"D pedestal and/or end panel.
- 72"W x 84"D:
 - Desk = 72"W x 36"D worksurface, 72"W x 27⁷/₈"H modesty/back panel, supported by 1-left and 1-right 35"D end panel.
 - Return = 48"W x 24"D return; or 48"W x 24"D worksurface with vertical grain, 48"W x 27⁷/₈"H modesty/back panel, supported by a 23¹/₈"D pedestal and/or end panel.

Comprised of 17"D transaction counter, with 4" approach-side overhang, for the desk and a vertical privacy panel extending the depth of the desk and width of the return. Ships with Transaction counter organizer (model HTCOL52) is available as an option; fits under transaction counter; organizer is available in black only.

SPECIFYING EXAMPLE: HNL8472RT.BH.H.H

NOTES:

- Reception Station Counter for Desk, and L-Reception Station with Transaction Counter for Desk, have profiled edgeband on the approach and user sides.
- L-Reception Station with Transaction Counter for Desk and Return has profiled edgeband on front side of transaction counter on desk approach-side only.
- For L-reception station layouts where the return is not against a wall, specify return using modular components, as the modesty/back panel can be specified without a grommet. Assembled returns come standard with cord grommet in modesty/back panel.

HOW TO SPECIFY

<p>Select Model Number</p> <p>H N L 1 7 7 2 R T</p>	<p>Select Edge Profile and Edge Color</p> <p>See page 29</p> <p>B H</p>	<p>Select Counter Color</p> <p>See page 29</p> <p>H</p>	<p>Select Chassis Color</p> <p>See page 29</p> <p>H</p>
--	--	--	--

CONCINNITY™

Reception Stations

GSA SIN 33721



Icon Legend on page 19

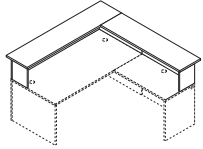

For Station with Right Return

DESCRIPTION	MODEL	SHIP WEIGHT	CUBE	L1 LIST	L2 UPCHARGES	
					COUNTER	CHASSIS
L-Reception Station with Transaction Counter for Desk and Return (NON-HANDED)						
76"W x 88"D x 14 $\frac{5}{8}$ "H	HNL8472RLT	145	5.6	\$1382	\$11	\$27
76"W x 82"D x 14 $\frac{5}{8}$ "H	HNL7872RLT	139	5.6	\$1334	\$11	\$27

NOTES: Non-Handed can be configured left-hand or right-hand. Intended for use on desk built with modular components, for clean approach-side aesthetic, connected to a return or modular return. Layout for 78" and 84"D footprints:

- 72"W x 78"D:
 - Desk = 72"W x 30"D worksurface, 72"W x 27 $\frac{7}{8}$ "H modesty/back panel, supported by 29 $\frac{1}{8}$ "D pedestal(s) and/or end panel(s).
 - Return = 48"W x 24"D worksurface with vertical grain, 48"W x 27 $\frac{7}{8}$ "H modesty/back panel, supported by a 23 $\frac{1}{8}$ "D pedestal and/or end panel.
- 72"W x 78"D:
 - Desk = 72"W x 36"D worksurface, 72"W x 27 $\frac{7}{8}$ "H modesty/back panel, supported by 1-left and 1-right 35"D panel.
 - Return = 42"W x 24"D worksurface with vertical grain, 42"W x 27 $\frac{7}{8}$ "H modesty/back panel, supported by a 23 $\frac{1}{8}$ "D pedestal and/or end panel.
- 72"W x 84"D:
 - Desk = 72"W x 36"D worksurface, 72"W x 27 $\frac{7}{8}$ "H modesty/back panel, supported by 1-left and 1-right 35"D end panel.
 - Return = 48"W x 24"D worksurface with vertical grain, 48"W x 27 $\frac{7}{8}$ "H modesty/back panel, supported by a 23 $\frac{1}{8}$ "D pedestal and/or end panel.

! The 17"D transaction counter, with 4" overhang, extends around the perimeter of the station, across the width of the desk, as well as along the depth of the desk and width of the return. Ships with Transaction counter organizer (model HTCOL52) is available as an option; fits under transaction counter; organizer is available in black only.

SPECIFYING EXAMPLE: HNL8472RLT.BH.H.H

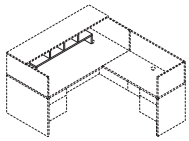

Transaction Counter Organizer

48 $\frac{3}{4}$ "W x 11 $\frac{1}{8}$ "D x 13"H

HTCOL52

24

1.1

\$351

N/A

N/A

NOTES: Fits under reception station counters.

! Black only.

SPECIFYING EXAMPLE: HTCOL52.P

NOTES:

- Reception Station Counter for Desk, and L-Reception Station with Transaction Counter for Desk, have profiled edgeband on the approach and user sides.

! L-Reception Station with Transaction Counter for Desk and Return has profiled edgeband on front side of transaction counter on desk approach-side only.

! For L-reception station layouts where the return is not against a wall, specify return using modular components, as the modesty/back panel can be specified without a grommet. Assembled returns come standard with cord grommet in modesty/back panel.

HOW TO SPECIFY

Select Model Number H N L 8 4 7 2 R L T .	Select Edge Profile and Edge Color See page 29 B H .	Select Counter Color See page 29 H .	Select Chassis Color See page 29 H
---	---	---	---



CONCINNITY™ Mobile Pedestals

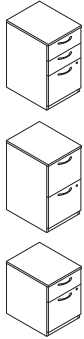

DESCRIPTION	MODEL	SHIP WEIGHT	CUBE	L1 LIST	L2 UPCHARGES		
					TOP	CHASSIS	FRONTS
Mobile Pedestal — 15¾”W							
15¾”W x 20⅞”D x 28⅜”H, Box/Box/File	HNL2116MBBF	69	7.4	\$1177	N/A	\$21	\$11
15¾”W x 20⅞”D x 28⅜”H, File/File	HNL2116MFF	70	7.4	\$1177	N/A	\$21	\$11
15¾”W x 20⅞”D x 21½”H, Box/File	HNL2116MBF	55	5.8	\$998	N/A	\$21	\$11

NOTES: Design positions the center of gravity towards the back of the cabinet to inhibit tipping. All drawers lock; interchangeable core removable lock makes re-keying quick and easy. Finish of lock is determined by, and aligned with, the handle finish specified. Keyed alike cores must be ordered separately; specify model HF23B (Black) or HF23S (Satin) and specific key number required. Pedestals, excluding cushion option, are sized to be positioned under 29½”H worksurfaces. Seat cushion model HLSL2016PH2 is optional. Cushion adds 1” to the height of the pedestal. Box/File unit with cushion will fit below 29½”H worksurface. ¾” thick top with flat edgeband; back inside end panel construction. Ships fully assembled.

SPECIFYING EXAMPLE: HNL2116MBBF.E.H.H

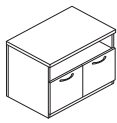

Mobile Pedestal — 30”W							
30”W x 20”D x 21½”H, Shelf/File/Cabinet	HNL2030MSFC	105	10.7	\$1478	\$11	\$27	\$16

NOTES: Sized to align with 20”D x 20½”H low credenzas. Open shelf over file drawer left and cabinet with door right. Design positions the center of gravity towards the back of the cabinet to inhibit tipping. Seat cushion model HLSL2030CH2 is optional. Cushion adds 1” to the height of the pedestal. 1⅞” thick top matches low credenza design. Ships fully assembled.

SPECIFYING EXAMPLE: HNL2030MSFC.BH.E.H.H.H

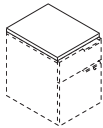

DESCRIPTION	MODEL	SHIP WEIGHT	CUBE	LIST PRICE BY FABRIC GRADE					
				1	2	3	4	5	6
Mobile Pedestal Cushion									
30”W x 20”D x 1”H	HLSL2030CH2	9	1.9	\$501	\$539	\$577	\$614	\$662	\$712
15⅞”W x 20”D x 1”H	HLSL2016PH2	6	1.1	\$416	\$442	\$467	\$492	\$524	\$557

NOTES: See pages 22-24 for available fabrics.

SPECIFYING EXAMPLE: HLSL2016PH2.APN23

NOTES:

- Mobile pedestals roll easily on four casters.
- Drawers operate on steel ball-bearing suspension with full extension.
- ① 28⅜”H mobile pedestals are not designed for use with the 28½”H metal O-leg due to interference caused by (1) the O-leg worksurface attachment bracket, and (2) the external support channel on the underside of a 72”, 66”, and 60”W rectangle worksurface supported by O-leg(s).

HOW TO SPECIFY

<p>Select Model Number</p> <p>H N L 2 1 1 6 M B B F .</p>	<p>Select Handle and Lock Color</p> <p>See page 35</p> <p>E .</p>	<p>Select Chassis Color</p> <p>See page 29</p> <p>H .</p>	<p>Select Drawer Front Color</p> <p>See page 29</p> <p>H</p>
--	--	--	---

<p>Select Model Number</p> <p>H N L 2 0 3 0 M S F C .</p>	<p>Select Edge Profile and Edge Color</p> <p>See page 29</p> <p>B H .</p>	<p>Select Handle and Lock Color</p> <p>See page 35</p> <p>E .</p>	<p>Select Top Color</p> <p>See page 29</p> <p>H .</p>	<p>Select Chassis Color</p> <p>See page 29</p> <p>H .</p>	<p>Select Drawer/Door Front Color</p> <p>See page 29</p> <p>H</p>
--	--	--	--	--	--

CONCINNITY™ Lateral Files

GSA SIN 33721



Icon Legend on page 19

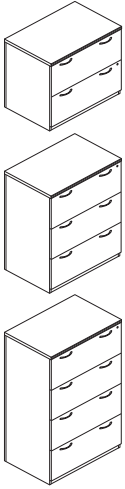

DESCRIPTION	MODEL	SHIP WEIGHT	CUBE	L1 LIST	L2 UPCHARGES		
					TOP	CHASSIS	FRONTS
Lateral File 36"W x 24"D x 55½"H, 4-Drawer	HNL2436LD4	276	34.3	\$2781	\$16	\$32	\$32
36"W x 24"D x 42½"H, 3-Drawer	HNL2436LD3	222	26.0	\$2308	\$16	\$27	\$27
36"W x 24"D x 29½"H, 2-Drawer	HNL2436LD2	178	18.4	\$1529	\$16	\$21	\$21

NOTES: Equipped with safety restraints; mechanical interlock inhibits the extension of more than one drawer at a time; counterweight positions the center of gravity towards the back of the cabinet to inhibit tipping. 24" depth aligns evenly with credenzas, returns, storage cabinet, storage/file cabinet, storage cabinet/lateral file, wardrobe/storage cabinet, wardrobe/bookcase, storage towers, and 24"D modular components. 29½"H unit is sized to accommodate 36"W stack-on storage or bookcase hutch options. Drawers lock; interchangeable core removable lock makes re-keying quick and easy. Finish of lock is determined by, and aligned with, the handle finish specified. Keyed alike cores must be ordered separately; specify model HF23B (Black) or HF23S (Satin) and specific key number required. Ship fully assembled. 30"W two-drawer size can be specified and assembled using modular components. Drawers include hangrails to accept folders in letter or legal size.

SPECIFYING EXAMPLE: HNL2436LD2.BH.E.H.H.H

HOW TO SPECIFY

<p>Select Model Number</p> <p>H N L 2 4 3 6 L D 4 .</p>	<p>Select Edge Profile and Edge Color</p> <p>See page 29</p> <p>B H .</p>	<p>Select Handle and Lock Color</p> <p>See page 35</p> <p>E .</p>	<p>Select Top Color</p> <p>See page 29</p> <p>H .</p>	<p>Select Chassis Color</p> <p>See page 29</p> <p>H .</p>	<p>Select Drawer Front Color</p> <p>See page 29</p> <p>H .</p>
--	--	--	--	--	---



CONCINNITY™ Storage Cabinets

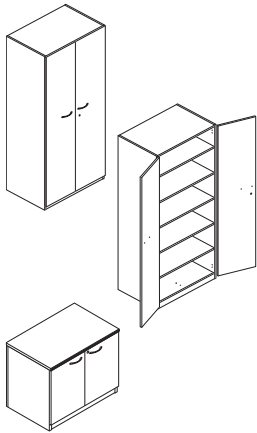

DESCRIPTION	MODEL	SHIP WEIGHT	CUBE	L1 LIST	L2 UPCHARGES		
					TOP	CHASSIS	FRONTS
Storage Cabinet with Laminate Doors							
36"W x 24"D x 78 1/8"H (shown)	HNL243679SC	317	47.4	\$3011	N/A	\$63	\$27
36"W x 24"D x 64 3/4"H	HNL243665SC	252	40.8	\$2831	N/A	\$58	\$21
36"W x 24"D x 29 1/2"H	HNL243629SC	158	18.4	\$1363	\$16	\$21	\$21

NOTES: 29 1/2"H size has one adjustable interior shelf. Shelf adjusts in 2 1/2" increments over a total range of 10"H, 64 3/4"H and 78 1/8" have five shelves (four adjustable) and six shelves (five adjustable), respectively; shelves adjust in 2 1/2" increments. Locking doors. 24" depth aligns evenly with credenzas, returns, lateral files, storage/file cabinet, storage cabinet/lateral file, wardrobe/storage cabinet, wardrobe/bookcase, storage tower, bookcase with coat hook, and 24"D modular components. 29 1/2"H unit is sized to accommodate 36"W stack-on storage or bookcase hutch options. Ships fully assembled. 30"W x 24"D x 29 1/2"H freestanding unit can be built using modular components.

SPECIFYING EXAMPLE (29 1/2"H): HNL243629SC.BH.E.H.H.H

SPECIFYING EXAMPLE (64 3/4-78 1/8"H): HNL243665SC.E.H.H

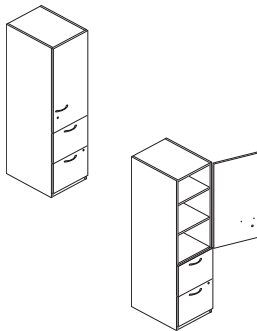

DESCRIPTION	MODEL	SHIP WEIGHT	CUBE	L1 LIST	TOP	CHASSIS	FRONTS
Storage/File Cabinet							
18"W x 24"D x 64 3/4"H, File/File, Laminate Door Hinged Right (shown)	HNL241865SFLR	184	21.6	\$2277	N/A	\$27	\$16
18"W x 24"D x 64 3/4"H, File/File, Laminate Door Hinged Left	HNL241865SFLL	184	21.6	\$2277	N/A	\$27	\$16
18"W x 24"D x 64 3/4"H, File/File, Open Shelves	HNL241865SFXX	169	21.6	\$2163	N/A	\$27	\$16

NOTES: Versatile unit features a storage cabinet plus two file drawers. Storage cabinet includes three shelves, two are adjustable; shelves adjust in 2 1/2" increments. Can be specified with door hinged left, door hinged right, or no door/open shelves. File drawers operate on steel ball-bearing suspensions with full extension. File drawers include hangrails to accept folders in letter or legal size. Storage cabinet door and file drawers lock separately; the two locks are keyed alike. Unit height is designed to match desk, credenza, or return plus 35 1/4"H stack-on storage (= 64 3/4"). Ships fully assembled.

SPECIFYING EXAMPLE (WITH DOOR): HNL241865SFLR.E.H.H

SPECIFYING EXAMPLE (WITHOUT DOOR): HNL241865SFXX.E.H.H

NOTES:

- Interchangeable core removable lock makes re-keying quick and easy.
- Finish of lock is determined by, and aligned with, the handle finish specified.
- Keyed alike cores must be ordered separately; specify model HF23B (Black) or HF23S (Satin) and specific key number required.

HOW TO SPECIFY

Select Model Number	Select Edge Profile and Edge Color	Select Handle and Lock Color	Select Top Color	Select Chassis Color	Select Drawer Front Color
See page 29	See page 29	See page 35	See page 29	See page 29	See page 29
H N L 2 4 3 6 2 9 S C .	B H .	E .	H .	H .	H .

Select Model Number	Select Handle and Lock Color	Select Chassis Color	Select Drawer Front Color
See page 29	See page 35	See page 29	See page 29
H N L 2 4 3 6 6 5 S C .	E .	H .	H .
H N L 2 4 1 8 6 5 S F X .	E .	H .	H .

CONCINNITY™

Storage Cabinets

GSA SIN 33721



Icon Legend on page 19

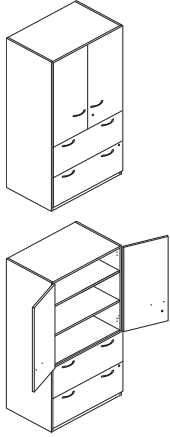

DESCRIPTION	MODEL	SHIP WEIGHT	CUBE	L1 LIST	L2 UPCHARGES		
					TOP	CHASSIS	FRONTS
Storage Cabinet/Lateral File, Laminate Doors 36"W x 24"D x 64¾"H	HNL243665SLL	328	40.8	\$3054	N/A	\$58	\$21

NOTES: Cabinet includes one fixed and two full-width adjustable shelves; adjustable shelves can be removed. Overall storage compartment measures 34"W x 22"D x 34½"H and will accommodate supplies, books and binders. Lateral file equipped with mechanical interlock to inhibit the extension of more than one drawer at a time. Lateral file drawers include hangrails to accept folders in letter or legal size. Storage cabinet and lateral file lock independently; upper lock secures cabinet; lower locks secure file drawers. Locks are keyed alike. Door hinges rotate to 94 degrees. Unit height is designed to match desk, credenza, or return plus 35¼"H stack-on storage (= 64¾"). Ships fully assembled.

SPECIFYING EXAMPLE: HNL243665SLL.E.H.H

NOTES:

- Interchangeable core removable lock makes re-keying quick and easy.
- Finish of lock is determined by, and aligned with, the handle finish specified.
- Keyed alike cores must be ordered separately; specify model HF23B (Black) or HF23S (Satin) and specific key number required.

HOW TO SPECIFY

Select Model Number H N L 2 4 3 6 6 5 S L L .	Select Handle and Lock Color See page 35 E .	Select Chassis Color See page 29 H .	Select Door/Drawer Front Color See page 29 H
---	---	---	---

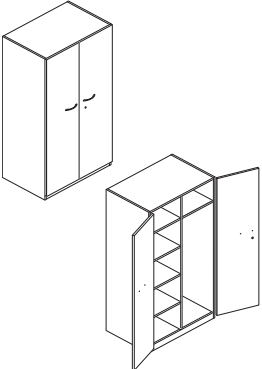
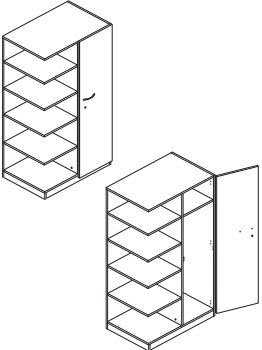

DESCRIPTION	MODEL	SHIP WEIGHT	CUBE	L1 LIST	L2 UPCHARGES		
					CHASSIS	FRONTS	
Wardrobe/Storage Cabinet, Laminate Doors — 36"W 36"W x 24"D x 78 ¹ / ₈ "H 36"W x 24"D x 64 ³ / ₄ "H	HNL243679WL	303	40.8	\$3457	\$63	\$27	
	HNL243665WL	284	40.8	\$3315	\$58	\$21	
NOTES: Spacious design combines a cabinet with adjustable shelves and a generous personal wardrobe compartment with a coat rod and upper shelf. 64 ³ / ₄ "H and 78 ¹ / ₈ "H have five shelves (four adjustable) and six shelves (five adjustable), respectively; shelves adjust in 2 ¹ / ₂ " increments. One lock secures both doors. Ships fully assembled. SPECIFYING EXAMPLE: HNL243665WL.E.H.H							
	Wardrobe/Storage Cabinet, Laminate Door — 18"W						
	18"W x 24"D x 78 ¹ / ₈ "H, Hinged Right (shown)	HNL241879WLR	205	24.8	\$2270	\$32	\$21
	18"W x 24"D x 78 ¹ / ₈ "H, Hinged Left	HNL241879WLL	205	24.8	\$2270	\$32	\$21
	18"W x 24"D x 64 ³ / ₄ "H, Hinged Right	HNL241865WLR	157	21.6	\$2081	\$27	\$16
18"W x 24"D x 64 ³ / ₄ "H, Hinged Left	HNL241865WLL	157	21.6	\$2081	\$27	\$16	
NOTES: Design includes coat rod and shelves. 64 ³ / ₄ "H and 78 ¹ / ₈ "H have five shelves (four adjustable) and six shelves (five adjustable), respectively; shelves adjust in 2 ¹ / ₂ " increments. Middle shelves can be removed to provide space for garments; coat rod can be removed for storage only applications. Lock to secure contents. Ships fully assembled. SPECIFYING EXAMPLE: HNL241865WLR.E.H.H							
	Wardrobe/Bookcase, Laminate Door						
	36"W x 24"D x 78 ¹ / ₈ "H, Wardrobe Left, Bookcase Right	HNL243679WLBR	302	47.4	\$3315	\$63	\$27
	36"W x 24"D x 78 ¹ / ₈ "H, Wardrobe Right, Bookcase Left	HNL243679WRBL	302	47.4	\$3315	\$63	\$27
	36"W x 24"D x 64 ³ / ₄ "H, Wardrobe Left, Bookcase Right	HNL243665WLBR	230	40.8	\$3133	\$58	\$21
	36"W x 24"D x 64 ³ / ₄ "H, Wardrobe Right, Bookcase Left (shown)	HNL243665WRBL	230	40.8	\$3133	\$58	\$21
NOTES: Combination closed-door wardrobe closet and open shelf bookcase. 64 ³ / ₄ "H and 78 ¹ / ₈ "H bookcases have five and six fixed shelves, respectively. Locking wardrobe compartment includes a coat rod and one shelf; shelf is positioned above the coat rod. Bookcase can be accessed from front or side. Left (L) model is wardrobe on left, bookcase on right; Right (R) model is wardrobe on right, bookcase on left. Ships fully assembled. SPECIFYING EXAMPLE: HNL243665WRBL.E.H.H							

NOTES:

- Heights designed to match desk, credenza, or return plus 35¹/₄"H stack-on storage (= 64³/₄"H) or 48⁵/₈"H stack-on storage (= 78¹/₈"H).
- Finish of locks is determined by, and aligned with, the handle finish specified.
- Keyed alike cores must be ordered separately; specify model HF23B (Black) or HF23S (Satin) and specific key number required.

HOW TO SPECIFY

Select Model Number H N L 2 4 3 6 5 W L .	Select Handle and Lock Color See page 35 E .	Select Chassis Color See page 29 H .	Select Door Front Color See page 29 H
---	---	---	--

CONCINNITY™

Storage Towers

GSA SIN 33721

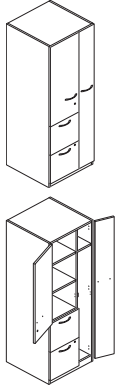

Icon Legend on page 19

**DESCRIPTION****Storage Towers, Laminate Doors — 24”W**24”W x 24”D x 78⁵/₈”H, Wardrobe Hinged Left, Cabinet Hinged Right**MODEL****SHIP WEIGHT****CUBE****L1 LIST****L2 UPCHARGES**
CHASSIS FRONTS24”W x 24”D x 78⁵/₈”H, Wardrobe Hinged Right, Cabinet Hinged Left**HNL242479TLL**

284

32.4

\$3211**\$74****\$48**24”W x 24”D x 64³/₄”H, Wardrobe Hinged Left, Cabinet Hinged Right**HNL242479TLR**

284

32.4

\$3211**\$74****\$48**24”W x 24”D x 64³/₄”H, Wardrobe Hinged Right, Cabinet Hinged Left (shown)**HNL242465TLL**

241

27.6

\$2925**\$63****\$37****HNL242465TLR**

241

27.6

\$2925**\$63****\$37**

NOTES: Versatile design includes a wardrobe closet, storage cabinet, and two file drawers, in one compact unit. Wardrobe contains a coat rod and upper shelf. 64³/₄”H and 78⁵/₈”H cabinets have three shelves (two adjustable) and four shelves (three adjustable), respectively; shelves adjust in 2¹/₂” increments. File drawers operate on ball-bearing suspensions with full extension. File drawer design includes integrated hangrails for side-to-side letter or legal filing; and front-to-back for letter filing. Upper lock secures wardrobe closet and storage cabinet; lower lock secures file drawers; the two locks are keyed alike. Left (L) model is wardrobe hinged left, cabinet hinged right; Right (R) model is wardrobe hinged right, cabinet hinged left. Ships fully assembled.

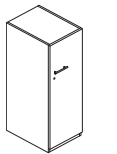
SPECIFYING EXAMPLE: HNL242465TLR.E.H.HHinged Right
HNL241850TLR shown**Storage Towers, Laminate Door — 50”H**

18”W x 30”D x 50”H, Hinged Right

HNL301850TLR

135

19.8

\$1813**\$53****\$37**

18”W x 30”D x 50”H, Hinged Left

HNL301850TLL

135

19.8

\$1813**\$53****\$37**

18”W x 24”D x 50”H, Hinged Right

HNL241850TLR

121

15.9

\$1631**\$53****\$37**

18”W x 24”D x 50”H, Hinged Left

HNL241850TLL

121

15.9

\$1631**\$53****\$37**

NOTES: Can be used next to 29¹/₂”H to standing, 42”H worksurfaces. Cabinet includes coat hook on back of door, perfect for jackets, sweaters, and purses. Two adjustable interior shelves, plus bottom of unit; shelves adjust in 2¹/₂” increments. 30”D size has a slim side access storage space at rear of unit with two fixed interior shelves; the lower shelf is positioned to align with a 29¹/₂”H worksurface, the upper shelf with a 42”H worksurface. Hardware bag includes an extra coat hook which can be positioned on the side of the unit, below the worksurface; ideal for back packs. Left (L) model is door hinged left; Right (R) model is door hinged right. Worksurface tower bracket kit (model HSTB2W) can be used to attach a worksurface directly to the tower. Bracket (1) eliminates the need for one end panel or O-leg support; (2) is not designed to be used as a support when a stack-on storage unit is placed over bracket. Ships fully assembled.

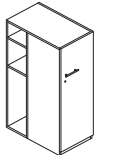
SPECIFYING EXAMPLE: HNL182450TLR.E.H.HHinged Right
HNL301850TLR shown**NOTES:**

- Equipped with interchangeable core removable locks.
- Finish of locks is determined by, and aligned with, the handle finish specified.
- Keyed alike cores must be ordered separately; specify model HF23B (Black) or HF23S (Satin) and specific key number required.

CABINET/WARDROBE/TOWER SOLUTIONS BY SIZE

	Low/50”H	Standard/64 ³ / ₄ ”H	Executive/78 ⁵ / ₈ ”H
Storage Cabinet with Doors		•	•
Storage/File Cabinet		•	
Storage Cabinet/Lateral File		•	
Wardrobe/Storage Cabinet		•	•
Wardrobe/Bookcase		•	•
Storage Tower		•	•
Storage Tower with Side Access on 30”D	•		
Bookcase with Coat Hook		•	

HOW TO SPECIFY**Select Model Number**

H N L 2 4 2 4 6 5 T L R .

Select Handle and Lock Color

See page 35

E .

Select Chassis Color

See page 29

H .

Select Door Front Color

See page 29

E

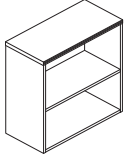

DESCRIPTION

Bookcase with Adjustable Shelves

- 30"W x 14 1/4"D x 78 1/8"H, 6-Shelf
- 30"W x 14 1/4"D x 65"H, 5-Shelf
- 30"W x 14 1/4"D x 52 3/4"H, 4-Shelf
- 30"W x 14 1/4"D x 42"H, 3-Shelf
- 30"W x 14 1/4"D x 29 1/2"H, 2-Shelf

MODEL	SHIP WEIGHT	CUBE	L1 LIST	L2 UPCHARGES	
				TOP	CHASSIS
HNL1530BK6	170	25.7	\$1242	\$32	\$37
HNL1530BK5	143	21.1	\$1102	\$27	\$32
HNL1530BK4	118	17.4	\$956	\$21	\$27
HNL1530BK3	95	14.1	\$840	\$16	\$21
HNL1530BK2	69	10.2	\$738	\$16	\$16

NOTES: Profiled top edge; choose from edge detail options. Number of total and adjustable shelves:

Height	Shelves	Adjustable Shelves
29 1/2"	2	1
42"	3	2
52 3/4"	4	3
65"	5	4
78 1/8"	6	5

3/4" thick shelves adjust in 1/4" increments. Inside shelf dimensions on all units are 28 1/2"W x 13 1/4"D. Ships fully assembled.

SPECIFYING EXAMPLE: HNL1530BK2.BH.H.H

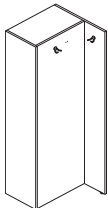
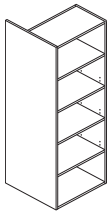

Back View

DESCRIPTION

Bookcase with Coat Hooks

- 24"W x 24"D x 64 3/4"H, 5-Shelf, with Coat Hooks, Right (shown)
- 24"W x 24"D x 64 3/4"H, 5-Shelf, with Coat Hooks, Left

MODEL	SHIP WEIGHT	CUBE	L1 LIST PRICE	L2
				UPCHARGE
HNL2424BK5CR	133	27.6	\$1254	\$32
HNL2424BK5CL	133	27.6	\$1254	\$32

NOTES: Inside shelf dimensions are 28 1/2"W x 13 1/4"D. Two out of sight coat hooks for garments are secluded behind bookcase. One end panel measures 14 1/4"D, the other 24"D. "R" indicates coat hook access is on the right and the full 24"D end panel on the left; for use next to credenza or return with pedestal on right. "L" indicates coat hook access is on the left and the full 24"D end panel is on the right; for use next to credenza or return with pedestal on left. Unit height is designed to match desk, credenza, or return plus 35 1/4"H stack-on storage (= 64 3/4"). 3/4" thick, non-profiled top edge. Not available in two-tone laminate color combinations. Ships fully assembled.

SPECIFYING EXAMPLE: HNL2424BK5CR.H

HOW TO SPECIFY

Select Model Number

H N L 1 5 3 0 B K 2 .

Select Edge Profile and Edge Color

See page 29

B H .

Select Top Color

See page 29

H .

Select Chassis Color

See page 29

H

Select Model Number

H N L 2 4 2 4 B K 5 C R .

Select Laminate

See page 29

H

CONCINNITY™

Components — Worksurfaces

GSA SIN 33721



Icon Legend on page 19

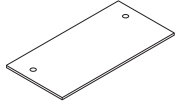

DESCRIPTION	MODEL	SHIP WEIGHT	CUBE	L1 LIST PRICE	L2 UPCHARGE
Rectangle Worksurface with Horizontal Grain					
84"W x 36"D	HNLRC3684	105	7.7	\$840	\$32
72"W x 36"D	HNLRC3672	90	6.7	\$703	\$32
84"W x 30"D	HNLRC3084	88	6.5	\$679	\$27
78"W x 30"D	HNLRC3078	81	6.1	\$616	\$27
72"W x 30"D	HNLRC3072	75	5.6	\$564	\$21
66"W x 30"D	HNLRC3066	69	5.2	\$520	\$21
60"W x 30"D	HNLRC3060	62	4.7	\$484	\$21
48"W x 30"D	HNLRC3048	50	3.9	\$397	\$16
96"W x 24"D	HNLRC2496	80	5.8	\$699	\$32
90"W x 24"D	HNLRC2490	75	5.5	\$686	\$32
84"W x 24"D	HNLRC2484	70	5.3	\$647	\$27
78"W x 24"D	HNLRC2478	65	4.9	\$578	\$21
72"W x 24"D	HNLRC2472	60	4.6	\$482	\$21
66"W x 24"D	HNLRC2466	55	4.2	\$464	\$21
60"W x 24"D	HNLRC2460	50	3.9	\$430	\$21
54"W x 24"D	HNLRC2454	45	3.5	\$394	\$21
48"W x 24"D	HNLRC2448	40	3.1	\$362	\$16
42"W x 24"D	HNLRC2442	35	2.8	\$337	\$16
36"W x 24"D Rectangle Worksurface/Pedestal Top	HNLRC2436	30	2.4	\$305	\$16
30"W x 24"D Rectangle Worksurface/Pedestal Top	HNLRC2430	25	2.1	\$305	\$16

NOTES: See chart on page 48 for cord management options.

- When grommets are specified for 30"D and 36"D rectangle worksurfaces, pre-drilled holes will not be included for a 4½" diameter support column.

NOTES:

- Grain direction on all rectangle worksurfaces runs horizontal (side-to-side) except as follows: 30"W - 36"W - 42"W - 48"W - 54"W - 60"W x 24"D tops can be specified with horizontal (side-to-side) or vertical (front-to-back) grain.
- 42"W and 48"W x 20"D tops are available with vertical (front-to-back) grain only.
- For standing-height requirements, use worksurface with 41"H O-leg, end panel, L-shaped end panel, or pedestal supports.
- For mobile desks and tables, use post leg with casters.
- If using worksurfaces with Coordinate™ Height Adjustable Bases, an External Stiffener must be used.
- Attachment of above privacy screen models requires a minimum 1" clear space/overhang on the underside of worksurface.
- Worksurfaces used with Coordinate™ Height Adjustable Bases should have 1" perimeter gap on each side to provide clearance between other furniture. Failure to do so risks injury or product damage (not covered by warranty).
- When using end panels or O-legs with 84", 90", or 96"W worksurfaces, interior weight-bearing support components are required to minimize worksurface deflection.
- Attachment of above/below privacy screen models requires a minimum 2" clear space/overhang on the underside of the worksurface.
- Steel external support channel can be attached to the underside of worksurfaces that are subjected to heavier loads. Channel is recommended to provide extra support on unsupported spans of 54"W or greater or per user preference. Ordered separately from worksurface.
- If using a 54"W or 60"W floating modesty panel, it is not necessary to specify an external support channel.
- When using an external support channel under the worksurface, the depth clearance for center drawers and keyboard platforms decreases by 8".
- See "External Channel (Recommended Use)" chart on page 43.

HOW TO SPECIFY

Select Model Number See page 29 H N L R C 3 6 8 4	Select Edge Profile and Edge Color See page 29 B H	Select Worksurface Grommet Finish P Black T1 Platinum X No Grommet P	Select Worksurface Color See page 29 H
---	--	--	--

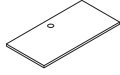

DESCRIPTION	MODEL	SHIP WEIGHT	CUBE	L1	L2
				LIST PRICE	UPCHARGE
Rectangle Worksurface with Vertical Grain					
60"W x 24"D	HNLRC2460V	50	3.9	\$430	\$21
54"W x 24"D	HNLRC2454V	45	3.5	\$394	\$21
48"W x 24"D	HNLRC2448V	40	3.1	\$362	\$16
42"W x 24"D	HNLRC2442V	35	2.8	\$337	\$16
36"W x 24"D Rectangle Worksurface/Pedestal Top	HNLRC2436V	30	2.4	\$305	\$16
30"W x 24"D Rectangle Worksurface/Pedestal Top	HNLRC2430V	25	2.1	\$305	\$16
48"W x 20"D	HNLRC2048V	33	2.7	\$338	\$11
42"W x 20"D	HNLRC2042V	29	2.3	\$312	\$11

NOTES: Can be used in a host of applications, including as a desk, credenza, return, bridge, stationary or mobile table surface, in U- or L-shaped configurations, as part of a work wall layout with an island extension, or with the height adjustable electric base. The conference overhang dimension on the approach side of worksurfaces varies depending on the supports and modesty panels specified. Top can be positioned with a cantilevered conference overhang on one end when used with select worksurface supports, including an O-leg or 9½"W modular pedestal. For return applications in which there is an unsupported span wider than 54", such as a 72"W x 24"D worksurface supported by a 15¾"W modular pedestal (= 56¼") or a 60"W x 24"D worksurface supported by a 1½" thick end panel (= 58⅞"), use internal support panel model HNL11SUPP. For bridges wider than 54", use internal support panel HNL11SUPP. When using a 30"W, 36"W, 42"W, or 48"W rectangle worksurface as a bridge, no support legs are needed. When specifying a 84"W, 90"W, or 96"W worksurface, cannot use two O-legs for the supports. In these applications, the maximum number of supports that can be an O-leg is one; must choose from a 15¾" or wider modular pedestal for use as the additional support component. For applications requiring connection to an adjoining worksurface, two flat brackets are included with 24"D and 20"D worksurfaces that are ≤48"W; one flat bracket is included with 24"D worksurfaces that are ≥54"W. Underside of worksurface includes pilot mounting holes for O-leg, 1½" thick laminate end panel, pedestals, and flat brackets. See chart on page 48 for cord management options.

ⓘ When grommets are specified for 30"D and 36"D rectangle worksurfaces, pre-drilled holes will not be included for attachment of a 4½" diameter support column.

NOTES:

- Grain direction on all rectangle worksurfaces runs horizontal (side-to-side) except as follows: 30"W - 36"W - 42"W - 48"W - 54"W - 60"W x 24"D tops can be specified with horizontal (side-to-side) or vertical (front-to-back) grain.
- 42"W and 48"W x 20"D tops are available with vertical (front-to-back) grain only.
- For standing-height requirements, use worksurface with 41"H O-leg, end panel, L-shaped end panel, or pedestal supports.
- For mobile desks and tables, use post leg with casters.
- ⓘ If using worksurfaces with Coordinate™ Height Adjustable Bases, an External Stiffener must be used.
- ⓘ Attachment of above privacy screen models requires a minimum 1" clear space/overhang on the underside of worksurface.
- ⓘ Worksurfaces used with Coordinate™ Height Adjustable Bases should have 1" perimeter gap on each side to provide clearance between other furniture. Failure to do so risks injury or product damage (not covered by warranty).
- ⓘ Attachment of above/below privacy screen models requires a minimum 2" clear space/overhang on the underside of the worksurface.
- ⓘ Steel external support channel can be attached to the underside of worksurfaces that are subjected to heavier loads. Channel is recommended to provide extra support on unsupported spans of 54"W or greater or per user preference. Ordered separately from worksurface.
- ⓘ If using a 54"W or 60"W floating modesty panel, it is not necessary to specify an external support channel.
- ⓘ When using an external support channel under the worksurface, the depth clearance for center drawers and keyboard platforms decreases by 8".
- ⓘ See "External Channel (Recommended Use)" chart on page 43.

HOW TO SPECIFY

Select Model Number H N L R C 2 4 6 0 V	Select Edge Profile and Edge Color See page 29 B H	Select Worksurface Grommet Finish P Black T1 Platinum X No Grommet P	Select Worksurface Color See page 29 H
---	---	---	---



CONCINNITY™

Components — Worksurfaces

GSA SIN 33721

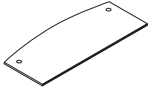

Icon Legend on page 19

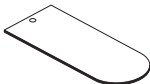
	DESCRIPTION	MODEL	SHIP WEIGHT	CUBE	L1 LIST PRICE	L2 UPCHARGE
	Bow Worksurface					
	84"W x 36"D	HNLBW3684	94	7.7	\$896	\$32
	72"W x 36"D	HNLBW3672	80	6.7	\$809	\$32
	NOTES: 84"W size is ideal for executive layouts or for user's who require additional worksurface space. 72"W top can be combined with different pedestal support options to allow users to personalize their storage needs. Underside of worksurface includes pilot mounting holes for 1½" and L-shaped laminate end panels, and 29½"D pedestals. Grain direction runs horizontal (side-to-side). See chart on page 48 for cord management options.					
	Wedge Worksurface					
	84"W x 36"D	HNL3684WT	166	20.3	\$975	\$27
	78"W x 36"D	HNL3678WT	157	19.4	\$925	\$21
	72"W x 36"D	HNL3672WT	144	17.7	\$812	\$21
	66"W x 36"D	HNL3666WT	137	17.7	\$766	\$21
	60"W x 36"D	HNL3660WT	131	17.7	\$706	\$21
	84"W x 30"D	HNL3084WT	150	20.3	\$815	\$27
	78"W x 30"D	HNL3078WT	142	19.4	\$775	\$21
	72"W x 30"D	HNL3072WT	126	13.4	\$672	\$21
	66"W x 30"D	HNL3066WT	121	13.4	\$643	\$21
	60"W x 30"D	HNL3060WT	116	13.4	\$597	\$21
	84"W x 24"D	HNL2484WT	134	20.3	\$785	\$27
	78"W x 24"D	HNL2478WT	127	19.4	\$741	\$21
	72"W x 24"D	HNL2472WT	109	11.2	\$598	\$21
66"W x 24"D	HNL2466WT	101	10.6	\$593	\$21	
60"W x 24"D	HNL2460WT	92	9.5	\$547	\$21	
	NOTES: Wedge tops have boring for support column, post legs, and stanchion.					
	Bullet Worksurface					
	84"W x 30"D	HNLBU3084	84	6.3	\$791	\$27
	78"W x 30"D	HNLBU3078	78	6.3	\$752	\$21
	72"W x 30"D	HNLBU3072	72	5.5	\$653	\$21
	66"W x 30"D	HNLBU3066	66	5.5	\$624	\$21
	60"W x 30"D	HNLBU3060	60	4.7	\$579	\$21
	48"W x 30"D	HNLBU3048	54	3.7	\$508	\$16
	NOTES: Applications include U- or L-shaped peninsula configurations and island extensions. Underside of worksurface includes pilot mounting holes for O-leg, T-shaped end panel, 29½"D pedestals, 4½" diameter support column, and 2" square post leg. One flat bracket is packaged with each worksurface for applications requiring connection to an adjoining worksurface. Grain direction runs horizontal (side-to-side). Can be used in combination with a 15¾"W or 9½"W x 29½"D x 28¼"H modular pedestal to create a freestanding desk. See chart on page 48 for cord management options.					

NOTES:

- ❗ When specifying an 84"W size, cannot use two O-legs; must use another type of support component such as a pedestal.
- ❗ Steel external support channel can be attached to the underside of worksurfaces that are subjected to heavier loads. Channel is recommended to provide extra support on unsupported spans of 54"W or greater or per user preference. Ordered separately from worksurface.
- ❗ If using a 54"W or 60"W floating modesty panel, it is not necessary to specify an external support channel.
- ❗ When using an external support channel under the worksurface, the depth clearance for center drawers and keyboard platforms decreases by 8".
- ❗ See "External Channel (Recommended Use)" chart on page 43.

HOW TO SPECIFY

Select Model Number See page 29 H N L B W 3 6 8 4	Select Edge Profile and Edge Color See page 29 B H	Select Worksurface Grommet Finish P Black T1 Platinum X No Grommet P	Select Worksurface Color See page 29 H
---	--	--	--



CONCINNITY™ Components — Worksurfaces

	DESCRIPTION	MODEL	SHIP WEIGHT	CUBE	L1 LIST PRICE	L2 UPCHARGE
	Blade Worksurface, Left					
	84"W x 36"D	HNL3684LBT	159	20.3	\$975	\$27
	78"W x 36"D	HNL3678LBT	150	19.4	\$925	\$21
	72"W x 36"D	HNL3672LBT	138	17.7	\$812	\$21
	66"W x 36"D	HNL3666LBT	131	17.7	\$766	\$21
	60"W x 36"D	HNL3660LBT	125	17.7	\$706	\$21
	84"W x 30"D	HNL3084LBT	144	20.3	\$815	\$27
	78"W x 30"D	HNL3078LBT	136	19.4	\$775	\$21
	72"W x 30"D	HNL3072LBT	121	13.4	\$672	\$21
	66"W x 30"D	HNL3066LBT	115	13.4	\$643	\$21
	60"W x 30"D	HNL3060LBT	110	13.4	\$597	\$21
	84"W x 24"D	HNL2484LBT	129	20.3	\$785	\$27
	78"W x 24"D	HNL2478LBT	122	19.4	\$741	\$21
	72"W x 24"D	HNL2472LBT	104	11.2	\$598	\$21
	66"W x 24"D	HNL2466LBT	97	10.6	\$593	\$21
60"W x 24"D	HNL2460LBT	88	9.5	\$547	\$21	
	Blade Worksurface, Right					
	84"W x 36"D	HNL3684RBT	159	20.3	\$975	\$27
	78"W x 36"D	HNL3678RBT	150	19.4	\$925	\$21
	72"W x 36"D	HNL3672RBT	138	17.7	\$812	\$21
	66"W x 36"D	HNL3666RBT	131	17.7	\$766	\$21
	60"W x 36"D	HNL3660RBT	125	17.7	\$706	\$21
	84"W x 30"D	HNL3084RBT	144	20.3	\$815	\$27
	78"W x 30"D	HNL3078RBT	136	19.4	\$775	\$21
	72"W x 30"D	HNL3072RBT	121	13.4	\$672	\$21
	66"W x 30"D	HNL3066RBT	115	13.4	\$643	\$21
	60"W x 30"D	HNL3060RBT	110	13.4	\$597	\$21
	84"W x 24"D	HNL2484RBT	129	20.3	\$785	\$27
	78"W x 24"D	HNL2478RBT	122	19.4	\$741	\$21
	72"W x 24"D	HNL2472RBT	104	11.2	\$598	\$21
	66"W x 24"D	HNL2466RBT	97	10.6	\$593	\$21
60"W x 24"D	HNL2460RBT	88	9.5	\$547	\$21	

NOTES:

- Blade tops have boring for support column, post legs, and stanchion.
- ! Support column cannot be used on stanchion applications for tops larger than 72"W.

HOW TO SPECIFY



<p>Select Model Number</p> <p>H N L 3 0 7 8 L B T .</p>	<p>Select Edge Profile and Edge Color</p> <p>See page 29</p> <p>B H .</p>	<p>Select Worksurface Grommet Finish</p> <p>P Black T1 Platinum X No Grommet</p> <p>P .</p>	<p>Select Worksurface Color</p> <p>See page 29</p> <p>H</p>
--	--	--	--

CONCINNITY™ Components — Worksurfaces

GSA SIN 33721

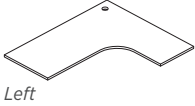
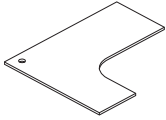

Icon Legend on page 19

	DESCRIPTION	MODEL	SHIP WEIGHT	CUBE	L1 LIST PRICE	L2 UPCHARGE	
 Left	Height Adjustable Corner Cove Worksurface, Left						
	72"W x 36"D x 60"R	HNL723660LCH	179	23.2	\$1130	\$37	
	72"W x 30"D x 60"R	HNL723060LCH	171	23.2	\$1076	\$37	
	72"W x 30"D x 54"R	HNL723054LCH	166	23.2	\$1021	\$37	
	66"W x 36"D x 60"R	HNL663660LCH	172	20.3	\$1024	\$32	
	66"W x 30"D x 60"R	HNL663060LCH	164	20.3	\$968	\$32	
	66"W x 30"D x 54"R	HNL663054LCH	160	20.3	\$914	\$32	
	60"W x 36"D x 60"R	HNL603660LCH	165	19.3	\$939	\$27	
	60"W x 30"D x 60"R	HNL603060LCH	159	19.3	\$885	\$27	
	60"W x 30"D x 54"R	HNL603054LCH	154	19.3	\$830	\$27	
	 Right	Height Adjustable Corner Cove Worksurface, Right					
		72"W x 36"D x 60"R	HNL723660RCH	179	23.2	\$1130	\$37
72"W x 30"D x 60"R		HNL723060RCH	171	23.2	\$1076	\$37	
72"W x 30"D x 54"R		HNL723054RCH	166	23.2	\$1021	\$37	
66"W x 36"D x 60"R		HNL663660RCH	172	20.3	\$1024	\$32	
66"W x 30"D x 60"R		HNL663060RCH	164	20.3	\$968	\$32	
66"W x 30"D x 54"R		HNL663054RCH	160	20.3	\$914	\$32	
60"W x 36"D x 60"R		HNL603660RCH	165	19.3	\$939	\$27	
60"W x 30"D x 60"R		HNL603060RCH	159	19.3	\$885	\$27	
60"W x 30"D x 54"R		HNL603054RCH	154	19.3	\$830	\$27	
		P-Shaped Worksurface					
		72"W x 36"D, Left (shown)	HNL3672LPT	132	15.0	\$1093	\$27
	72"W x 30"D, Left	HNL3072LPT	115	13.1	\$1038	\$21	
	72"W x 36"D, Right	HNL3672RPT	132	15.0	\$1093	\$27	
	72"W x 30"D, Right	HNL3072RPT	115	13.1	\$1038	\$21	

NOTES:

- Corner Cove worksurfaces have 1" shorter top size on credenza side to accommodate for pinch points.
- P-Shaped worksurfaces have boring for support column, post legs, stanchion, O-leg, and laminate T-shaped end panel.

HOW TO SPECIFY

<p>Select Model Number</p> <p>H N L 6 6 3 0 6 0 L C H .</p>	<p>Select Edge Profile and Edge Color</p> <p>See page 29</p> <p>B H .</p>	<p>Select Worksurface Grommet Finish</p> <p>P Black TI Platinum X No Grommet</p> <p>P .</p>	<p>Select Worksurface Color</p> <p>See page 29</p> <p>H</p>
--	--	--	--



CONCINNITY™ Components — Worksurfaces

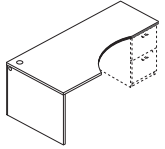

Right-hand model
HNLEC367224R shown

DESCRIPTION	MODEL	SHIP WEIGHT	CUBE	L1 LIST	L2 UPCHARGES	
					WORKSURFACE	END PANEL
Extended Corner Worksurface						
72"W x 48"D, Right	HNLEC487224R	130	8.9	\$1363	\$53	\$53
72"W x 48"D, Left	HNLEC487224L	130	8.9	\$1363	\$53	\$53
72"W x 36"D, Right	HNLEC367224R	106	6.6	\$1127	\$48	\$48
72"W x 36"D, Left	HNLEC367224L	106	6.6	\$1127	\$48	\$48

NOTES: For use in U- or L-shaped layouts. Includes top and long (47"D or 35"D) end panel components. Installation also requires modesty panel and either a 1½" thick end panel or 15¾" x 23⅞" D pedestal support for opposite end; both ordered separately. 72"W x 24/48"D or 48/24"D top is intended for use with 30/48"D or 48/30"D jetty peninsula to create a 2-piece "U" station with a curved cockpit on user's side. 72"W x 24/36"D or 36/24"D size is intended for use with 24"D returns or bridges. Underside of worksurface has pilot mounting holes for 1½" thick end panel and 15¾" x 23⅞" D modular pedestal. Edgebanding on the extended corner worksurface is profiled on the user's side and flat on the back (approach side) and ends. Grain direction runs horizontal (side-to-side).

❗ One flat bracket is packaged with each 48"D worksurface for applications requiring connection to a 48"D jetty peninsula. For 36"D extended corner worksurface, the flat bracket is shipped with the adjoining return or bridge. See chart on page 48 for cord management options. If grommet option is chosen, the worksurface component will match the color specified; the long end panel grommet color will be black.

NOTES:

- ❗ When specifying an 84"W size, cannot use two O-legs; must use another type of support component such as a pedestal.
- ❗ Steel external support channel can be attached to the underside of worksurfaces that are subjected to heavier loads. Channel is recommended to provide extra support on unsupported spans of 54"W or greater or per user preference. Ordered separately from worksurface.
- ❗ If using a 54"W or 60"W floating modesty panel, it is not necessary to specify an external support channel.
- ❗ When using an external support channel under the worksurface, the depth clearance for center drawers and keyboard platforms decreases by 8".
- ❗ See "External Channel (Recommended Use)" chart on page 43.

HOW TO SPECIFY

<p>Select Model Number</p> <p>HNLEC487224R</p>	<p>Select Edge Profile and Edge Color</p> <p>See page 29</p> <p>BH</p>	<p>Select Worksurface Grommet Finish</p> <p>P Black T1 Platinum X No Grommet</p> <p>X</p>	<p>Select Worksurface Color</p> <p>See page 29</p> <p>H</p>	<p>Select End Panel Color</p> <p>See page 29</p> <p>H</p>
---	---	--	--	--

CONCINNITY™

Components — Supports

GSA SIN 33721 EXCEPT AS NOTED



Icon Legend on page 19

**DESCRIPTION****External Support Channel**

72"W for a 78" Worksurface
66"W for a 72" Worksurface
60"W for a 66" Worksurface
54"W for a 60" Worksurface
48"W for a 54" Worksurface

! Available in Graphite paint only.

! Attaches to underside of worksurface; required for unsupported spans greater than 54"W.

! When specifying a 54"W or 60"W Floating Modesty Panel, it is not necessary to specify an external channel.

MODEL**SHIP WEIGHT****CUBE****LIST PRICE**

HLSLZ5SC84	12	0.7	\$152
HLSLZ5SC78	7	0.5	\$152
HLSLZ5SC72	7	0.5	\$152
HLSLZ5SC66	7	0.5	\$141
HLSLZ5SC60	6	0.5	\$135

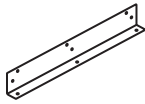

HVPWLBK24 shown

OPEN MARKET

Worksurface Wall Mount Bracket

For 30"
For 24"

HVPWLBK30

2

0.3

\$127**HVPWLBK24**

2

0.3

\$114

NOTES: Can be used in place of an end panel to support a worksurface. Cannot be used as a support when placing a stack-on storage unit on worksurface over bracket; must have two full-sized floor supports when using stack-on storage. Finish option not required.

SPECIFYING EXAMPLE: HVPWLBK30**DESCRIPTION****Worksurface to Tower Bracket Kit**

18½" long bracket for attaching 24"D worksurface directly to storage tower, wardrobe/bookcase, wardrobe/storage cabinet, storage cabinet/lateral file, storage cabinet, or lateral file.

NOTES: Can be used in place of end panel or O-leg to support worksurfaces.

! Bracket not designed for use as a support if placing Stack-on Storage on worksurface over/above bracket. Two full-sized supports required when using Stack-on Storage.

MODEL**SHIP WEIGHT****CUBE****LIST PRICE BY PAINT GRADE****P1****P2****P3****HSTB2W1**

4

0.6

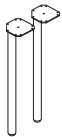
\$112**\$126****\$128****Post Leg, 2-Pack**

28"H

HMBPOST2

12

3.0

\$295**\$300****\$312**

NOTES: Pricing shown is per carton. Ordering 2 of the model will result in 2 cartons being shipped, giving you 4 legs.

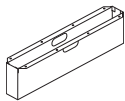
**Credenza Stanchion**

Stanchion for use on 30"D and 36"D tops
Stanchion for use on 18"D and 24"D tops

HNL28XS

9

1.0

\$384**\$389****\$401****HNL16XS**

6

1.0

\$281**\$286****\$298**

NOTES: Includes pass-through grommet for easy cord management.

NOTES:

• Use the worksurface to tower bracket kit to attach worksurfaces to Storage Tower models.

! Depending on your support combination, an external channel may be required for extra support on unsupported spans greater than 54"W.

HOW TO SPECIFY

Select
Model Number

H L S L Z 5 S C 8 4

Select
Model Number

H N L 2 8 X S .

Select
Paint Color

See page 29

P



CONCINNITY™ Components — Modesty/Back Panels

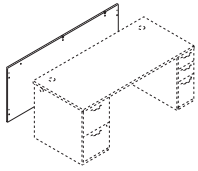

DESCRIPTION

Modesty/Back Panels — Full-Length

- 96"W x 27⁷/₈"H
- 90"W x 27⁷/₈"H
- 84"W x 27⁷/₈"H
- 78"W x 27⁷/₈"H
- 72"W x 27⁷/₈"H
- 66"W x 27⁷/₈"H
- 60"W x 27⁷/₈"H
- 54"W x 27⁷/₈"H
- 48"W x 27⁷/₈"H
- 42"W x 27⁷/₈"H

MODEL

SHIP WEIGHT

CUBE

L1 LIST PRICE

L2 UPCHARGE

HNLMP9628	62	7.2	\$565	\$27
HNLMP9028	58	6.7	\$550	\$27
HNLMP8428	54	6.1	\$457	\$27
HNLMP7828	50	5.5	\$406	\$21
HNLMP7228	46	5.3	\$377	\$21
HNLMP6628	42	4.8	\$355	\$21
HNLMP6028	38	4.4	\$321	\$21
HNLMP5428	34	4.0	\$310	\$21
HNLMP4828	30	3.6	\$294	\$16
HNLMP4228	26	3.2	\$270	\$16

- 36"W x 27⁷/₈"H Modesty/Pedestal Back Panel
- 30"W x 27⁷/₈"H Modesty/Pedestal Back Panel

HNLMP3628	22	2.8	\$250	\$13
HNLMP3028	18	2.4	\$231	\$13

Modesty/Back Panels — Short

- 96"W x 10"H
- 90"W x 10"H
- 84"W x 10"H
- 78"W x 10"H
- 72"W x 10"H
- 66"W x 10"H
- 60"W x 10"H
- 54"W x 10"H
- 48"W x 10"H
- 42"W x 10"H
- 36"W x 10"H
- 30"W x 10"H

HNLMP9610	22	3.0	\$565	\$16
HNLMP9010	21	2.8	\$550	\$16
HNLMP8410	20	2.8	\$457	\$16
HNLMP7810	19	2.3	\$406	\$13
HNLMP7210	18	2.1	\$377	\$13
HNLMP6610	17	1.9	\$355	\$13
HNLMP6010	16	1.8	\$321	\$13
HNLMP5410	15	1.6	\$310	\$13
HNLMP4810	14	1.4	\$294	\$11
HNLMP4210	13	1.3	\$270	\$11
HNLMP3610	12	1.1	\$250	\$11
HNLMP3010	11	0.9	\$231	\$11

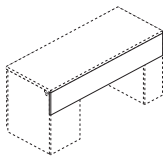

Back View

NOTES: For use with modular worksurface and support components. Component is 3/4" thick. Full-to-floor sizes can be specified with or without grommet; see chart on page 48 for cord management options. For standing-height applications, a worksurface supported by 1 1/8" thick x 41"H laminate end panel(s) and/or 41"H support pedestal(s), the recommended modesty panel length extends 27 7/8" below the underside of the top, leaving 13" of wall access; 9 1/2" and 15 3/4" W x 13"H backs are available to enclose the balance of the pedestal back. Worksurfaces supported by a 1 1/8" thick x 41"H laminate end panel and 41"H support pedestal, or by two 41"H support pedestals, can be used with a 10" modesty panel to increase the amount of wall access, however in this application the pedestal(s) should be positioned against a wall, as there is not a 30 7/8"H panel to cover the back of the pedestal that is exposed below the modesty panel. The 10"H modesty panel is not recommended for use in a standing-height shell, where both supports are 41"H laminate end panels; for this solution use the 27 7/8"H modesty panel. For standing-height applications with the worksurface supported by 41"H O-legs or L-shaped end panels, use the appropriate floating modesty panel size.

NOTES:

- Provide approach-side kneespace privacy for user seated at desks, credenzas, returns, and bridges.
- Full-width laminate panel can be specified in 6" increments from 30"-96"W, and in full-length (27 7/8"H) or short (10"H).
- Formal, full-length, 27 7/8"H models extend from the underside of the worksurface to the floor.
- 10"H sizes allow quick and easy access to wall power outlets.
- 30"W and 36"W x 27 7/8"H are sized to serve as a modesty panel, or pedestal back for respective 30"W and 36"W support storage pedestal models.
- ❗ The full-width panel designs are specifically for use when the worksurface supports are two 1 1/8" thick end panels, two support storage pedestals, or one 1 1/8" thick end panel and one support storage pedestal; not for use with O-legs or L-shaped end panels.
- ❗ Full-length modesty panels not for use with height adjustable desks/shrouds.

HOW TO SPECIFY

<p>Select Model Number</p> <p>H N L M P 7 2 2 8</p>	<p>Select Grommet</p> <p>P Black X No Grommet</p> <p>X</p>	<p>Select Laminate Color</p> <p>See page 29</p> <p>H</p>
--	---	---

<p>Select Model Number</p> <p>H N L M P 7 2 1 0</p>	<p>Select Laminate Color</p> <p>See page 29</p> <p>H</p>
--	---

CONCINNITY™

Components — Modesty/Back Panels

GSA SIN 33721



Icon Legend on page 19

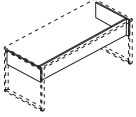

Not available in
two-tone laminate

DESCRIPTION	MODEL	SHIP WEIGHT	CUBE	L1	L2
				LIST PRICE	UPCHARGE
Modesty Panels for Desks with O-Legs 68 $\frac{3}{8}$ "W x $\frac{3}{4}$ "D x 10"H — For 72" x 30" Desks	HLAMMP7230	26	2.1	\$358	\$16
56 $\frac{3}{8}$ "W x $\frac{3}{4}$ "D x 10"H — For 60" x 30" Desks	HLAMMP6030	23	1.8	\$328	\$16

NOTES: For use with 60"W or 72"W worksurfaces supported by O-legs. Comprised of three panels: one approach side and one for each end. Length below bottom of worksurface is 10". Steel external support channel (ordered separately) is recommended for unsupported spans greater than 54"W (i.e.: a distance in which there is not a vertical support between the underside of the worksurface and floor). Grain direction is vertical on approach and side panels for 56 $\frac{3}{8}$ "W (all laminate colors) and 68 $\frac{3}{8}$ "W (L1 laminate except Florence Walnut and Kingswood Walnut). Vertical on 27 $\frac{5}{8}$ " end panels (all laminate colors). Horizontal on all panels for L2 laminates as well as Florence Walnut and Kingswood Walnut.

Specify: Model.Laminate

SPECIFYING EXAMPLE: HLAMMP7230.N

! \$16 upcharge for L2 laminates. See pages 247-248 for laminate options.

NOTES:

- Floating panel options attach under worksurfaces and are available in laminate or mixed (frosted translucent) material. The modesty panel and attachment bracket are packaged separately.
- If using a 54"W or 60"W floating modesty panel, it is not necessary to specify an external support channel.
- When using a floating modesty panel under the worksurface, the depth clearance for center drawers and keyboard platforms decreases by 8".
- The full width/half-height and full-to-floor/full-height panels are filler options designed only for use on 60", 66", and 72"W x 29 $\frac{1}{2}$ "H, double, 15 $\frac{3}{4}$ "W, pedestal desks and credenzas that are specified/built with modular components.

HOW TO SPECIFY

Select
Model Number

H L A M M P 7 2 3 0 .

Select
Laminate Color

See page 29

N



CONCINNITY™

Components — Modesty/Back Panels

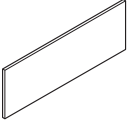
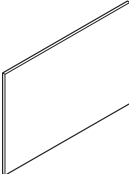
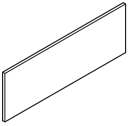
	DESCRIPTION	MODEL	SHIP WEIGHT	CUBE	L1 LIST PRICE	L2 UPCHARGE
	Full Width/Half-Height Laminate Modesty Panel					
	40"W x 14"H, for use with 72" desks	HLSL4014LM	29	2.4	\$270	\$11
	34"W x 14"H, for use with 66" desks	HLSL3414LM	23	1.9	\$259	\$11
	28"W x 14"H, for use with 60" desks	HLSL2814LM	19	1.6	\$250	\$11
	NOTES: Filler piece that can only be used between the following supports: two 15¾"W modular pedestals, two 15¾"W L-shaped end panels, or one 15¾"W modular pedestal and one 15¾"W L-shaped end panel. Attachment brackets included.					
	Full-to-Floor/Full-Length Laminate Modesty Panel					
	40"W x 28½"H, for use with 72" desks	HLSL4028LM	44	3.6	\$411	\$13
	34"W x 28½"H, for use with 66" desks	HLSL3428LM	38	3.2	\$391	\$13
	28"W x 28½"H, for use with 60" desks	HLSL2828LM	33	2.7	\$333	\$13
	NOTES: Filler piece that can only be used between the following supports: two 15¾"W modular pedestals, two 15¾"W L-shaped end panels, or one 15¾"W modular pedestal and one 15¾"W L-shaped end panel. Attachment brackets included.					
	Half-Height Laminate Modesty Panel					
	40"W x 14"H, for use with 72" HAT tops	HNL4014LM	29	2.3	\$368	\$21
	34"W x 14"H, for use with 66" HAT tops	HNL3414LM	23	2.2	\$346	\$21
	28"W x 14"H, for use with 60" HAT tops	HNL2814LM	19	1.9	\$324	\$21
	NOTES: For use with height adjustable base and top applications with low credenza.					

NOTES:

- Floating panel options attach under worksurfaces and are available in laminate or mixed (frosted translucent) material. The modesty panel and attachment bracket are packaged separately.
- If using a 54"W or 60"W floating modesty panel, it is not necessary to specify an external support channel.
- When using a floating modesty panel under the worksurface, the depth clearance for center drawers and keyboard platforms decreases by 8".
- The full width/half-height and full-to-floor/full-height panels are filler options designed only for use on 60", 66", and 72"W x 29½"H, double, 15¾"W, pedestal desks and credenzas that are specified/built with modular components.

❗ Full-to-floor/full-length modesty panels not for use with height adjustable desks/shrouds.

HOW TO SPECIFY

Select Model Number	Select Laminate Color
HL SL 2814LM .	See page 29
<input type="text" value="N"/>	

CONCINNITY™

Components — Supports

GSA SIN 33721

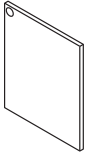
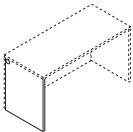
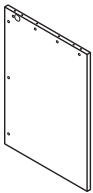

Icon Legend on page 19

	DESCRIPTION	MODEL	SHIP WEIGHT	CUBE	L1 LIST PRICE	L2 UPCHARGE
 HNLEP2428R shown	1 1/8" Laminate End Panels — For 29 1/2"H 1 1/8"W x 35"D x 28 1/2"H for 36"D, Right 1 1/8"W x 35"D x 28 1/2"H for 36"D, Left	HNLEP3628R HNLEP3628L	39 39	2.8 2.8	\$344 \$344	\$21 \$21
	1 1/8"W x 29 1/8"D x 28 1/2"H for 30"D, Right 1 1/8"W x 29 1/8"D x 28 1/2"H for 30"D, Left	HNLEP3028R HNLEP3028L	32 32	2.3 2.3	\$303 \$303	\$16 \$16
 HNLEP2428L shown	1 1/8"W x 23 1/8"D x 28 1/2"H for 24"D, Right 1 1/8"W x 23 1/8"D x 28 1/2"H for 24"D, Left	HNLEP2428R HNLEP2428L	22 22	1.9 1.9	\$270 \$270	\$11 \$11
	1 1/8" Laminate End Panels — For 42"H 1 1/8"W x 29 1/8"D x 41"H for 30"D, Right 1 1/8"W x 29 1/8"D x 41"H for 30"D, Left	HNLEP3041R HNLEP3041L	47 47	3.2 3.2	\$340 \$340	\$21 \$21
 HNLEP2441R shown	1 1/8"W x 23 1/8"D x 41"H for 24"D, Right 1 1/8"W x 23 1/8"D x 41"H for 24"D, Left	HNLEP2441R HNLEP2441L	37 37	2.6 2.6	\$321 \$321	\$16 \$16

NOTES: Supports the end of a component worksurface where there is no modular pedestal. 1 1/8" Laminate End Panels must be used with a full-length (27 7/8"H) or short (10"H) modesty/back panel; ordered separately, see page 93. The depth of an end panel is 3/4" less than the depth of the worksurface, to accommodate the modesty/back panel. Handed design (left and right models). Bottom of end panel is edgebanded for added strength and to seal out moisture. Applications include — For the non-pedestal end of single pedestal desks or credenzas utilizing modular storage components. For returns that do not have a modular storage pedestal to support the worksurface. For extended corner units that do not utilize a 15 3/4"W x 23 1/8"D modular storage pedestal to support the 24"D worksurface dimension. For building desk or credenza shells comprised of a worksurface top and modesty/back panel components, and left and right end panel. Available in a woodgrain or solid laminate color only. Can be specified with or without grommet; see chart on page 48 for cord management options. If grommet option is chosen, the color is black only.

NOTES:

! 1 1/8" Laminate End Panels must be used with a full-length (27 7/8"H) or short (10"H) modesty/back panel; ordered separately, see page 93.

HOW TO SPECIFY

Select Model Number <input type="text" value="HNLEP2428R"/>	Select Grommet <input type="checkbox"/> Black <input checked="" type="checkbox"/> No Grommet	Select Laminate Color <input type="text" value="H"/> See page 29
---	---	--

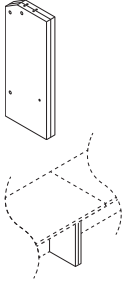

DESCRIPTION	MODEL	SHIP WEIGHT	CUBE	L1	L2
				LIST PRICE	UPCHARGE
Kneespace Clearance End Panels 1½"W x 11¼"D x 41"H for 24"D, 2 pk	HNLEP1141	25	2.8	\$377	\$11
1½"W x 11¼"D x 28½"H for 24"D, 2 pk	HNLEP1128	25	2.0	\$308	\$11

NOTES: Creates additional kneespace for the user. Two 1½"W x 11¼"D laminate end panels, one left, one right; sized to support two adjoining, contiguous 24"D worksurfaces. Can be specified with worksurfaces at time of installation or ordered as replacement for two side-by-side 1½"W x 23"D end panels. Available in 28½" and 41"H. Can be used to connect up to three credenzas in line (2 kits). Not designed for use with returns. Allows conversion of units currently in the field; European fasteners make installation quick and easy. Cord routing notch in top back of each panel. Includes two 1½" thick panels; European fastening hardware; flat connector bracket; self-tapping wood screws for ganging credenza to adjacent worksurface; and adjustable leveling glides. Can be specified in a woodgrain or solid laminate color only; not in a two-tone combination.

SPECIFYING EXAMPLE: HNLEP1128.H

HOW TO SPECIFY

<p>Select Model Number</p> <p>HNLEP1128</p>	<p>Select Grommet</p> <p>P Black X No Grommet</p> <p>X</p>
--	---

CONCINNITY™

Components — Supports

GSA SIN 33721



Icon Legend on page 19

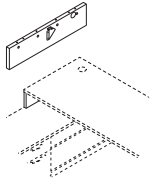

HNLEP307L shown

DESCRIPTION	MODEL	SHIP WEIGHT	CUBE	L1 LIST PRICE	L2 UPCHARGE
Laminate End Panel — 7”H Support for Worksurfaces					
1 $\frac{1}{8}$ ”W x 30”D x 7”H, Right	HNLEP307R	7	0.7	\$177	\$11
1 $\frac{1}{8}$ ”W x 30”D x 7”H, Left	HNLEP307L	7	0.7	\$177	\$11
1 $\frac{1}{8}$ ”W x 24”D x 7”H, Right	HNLEP247R	6	0.7	\$177	\$11
1 $\frac{1}{8}$ ”W x 24”D x 7”H, Left	HNLEP247L	6	0.7	\$177	\$11

NOTES: Specifically for layered surface applications; used to support a 29 $\frac{1}{2}$ ”H component worksurface over a 21 $\frac{1}{2}$ ”H low credenza unit. 1 $\frac{1}{8}$ ” thick. Handed design (left and right models). Includes cord routing notch. Bottom of end panel is edgebanded for added strength and to seal out moisture. Attaches to underside of worksurface via cam fasteners and L-bracket; attaches to top of low credenza with double-sided tape. Can be specified in a woodgrain or solid laminate color only. For 7”H metal O-leg support see page 100.

SPECIFYING EXAMPLE: HNLEP307R.H

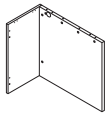

HNLLEP3028R shown

DESCRIPTION	MODEL	SHIP WEIGHT	CUBE	L1 LIST PRICE	L2 UPCHARGE
Laminate L-Shaped End Panels — For 29$\frac{1}{2}$”H					
15 $\frac{3}{4}$ ”W x 30”D x 28 $\frac{1}{2}$ ”H, Right	HNLLEP3028R	38	4.3	\$484	\$16
15 $\frac{3}{4}$ ”W x 30”D x 28 $\frac{1}{2}$ ”H, Left	HNLLEP3028L	38	4.3	\$484	\$16
15 $\frac{3}{4}$ ”W x 24”D x 28 $\frac{1}{2}$ ”H, Right	HNLLEP2428R	32	2.8	\$436	\$16
15 $\frac{3}{4}$ ”W x 24”D x 28 $\frac{1}{2}$ ”H, Left	HNLLEP2428L	32	2.8	\$436	\$16

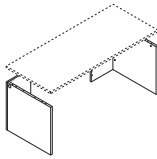

HNLLEP3028R and HNLLEP3028L shown

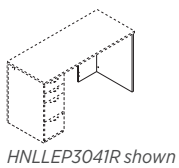
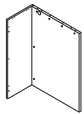

HNLLEP3041R shown



DESCRIPTION	MODEL	SHIP WEIGHT	CUBE	L1 LIST PRICE	L2 UPCHARGE
Laminate L-Shaped End Panels — For 42”H					
15 $\frac{3}{4}$ ”W x 30”D x 41”H, Right	HNLLEP3041R	55	4.3	\$537	\$21
15 $\frac{3}{4}$ ”W x 30”D x 41”H, Left	HNLLEP3041L	55	4.3	\$537	\$21
15 $\frac{3}{4}$ ”W x 24”D x 41”H, Right	HNLLEP2441R	47	2.8	\$479	\$21
15 $\frac{3}{4}$ ”W x 24”D x 41”H, Left	HNLLEP2441L	47	2.8	\$479	\$21

NOTES: Supports the end of a component worksurface where there is no modular pedestal. Provides easy, open access to wall electrical outlets. For configurations requiring a modesty panel, options include a laminate floating modesty panel or a mixed material floating modesty panel — see page 94. Tops and bottoms of panels are edgebanded. Two pieces; 1 $\frac{1}{8}$ ” end panel and $\frac{3}{4}$ ” back panel. Ships simple assembly. Can be specified in a woodgrain or solid laminate color only; not available in a two-tone combination. See chart on page 48 for cord management options. If grommet option is chosen for the end panel, the color is black only.

SPECIFYING EXAMPLE: HNLLEP2428R.X.H

HOW TO SPECIFY

Select Model Number HNLEP307R	Select Laminate Color See page 29 H
---	--

Select Model Number HNLLEP3028R	Select Grommet P Black X No Grommet X	Select Laminate Color See page 29 H
---	---	--



CONCINNITY™ Components — Supports

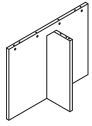

DESCRIPTION

Laminate T-Shaped End Panels — For 29½”H

11⅝”W x 35⅞”D x 28½”H

11⅝”W x 29⅞”D x 28½”H

11⅝”W x 23⅞”D x 28½”H

MODEL

SHIP WEIGHT

CUBE

**L1
LIST PRICE**

**L2
UPCHARGE**

HNLTEP3628

45

3.7

\$496

\$21

HNLTEP3028

39

3.3

\$463

\$21

HNLTEP2428

33

2.9

\$436

\$21

NOTES: Supports the end of a component worksurface where there is no modular pedestal. Available in 24”, 30”, and 36”D x 28½”H. Two 1⅝” thick pieces; one end and one brace panel. Cord routing notch in brace panel. Non-handed. Ships ; simple assembly. Can be specified in a woodgrain or solid laminate color only; not available in a two-tone combination.

SPECIFYING EXAMPLE: HNLTEP3628.H

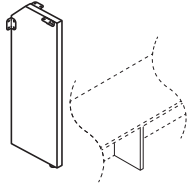

Support Brace — For 29½”H

1⅝”W x 10½”D x 28½”H

HNL11SUPP

11

0.9

\$198

\$11

NOTES: Minimizes worksurface deflection by providing added internal support under 24”D tops with an unsupported span of 54” or wider (distance for which there is no panel, leg, or pedestal support component). Not for use as an end panel. 11”D size provides kneespace clearance. Attaches with brackets to both the underside of the worksurface top and either a conventional full-length or 10” laminate modesty panel; not for use with O-leg or L-shaped end panel supports. 1⅝” thick. Cord routing notch in brace panel. Can be specified in a woodgrain or solid laminate color only.

SPECIFYING EXAMPLE: HNL11SUPP.H

HOW TO SPECIFY

<p>Select Model Number</p> <p>H N L 1 1 S U P P . H</p>	<p>Select Laminate Color</p> <p>See page 29</p> <p>H</p>
--	---

CONCINNITY™

Components — Supports

GSA SIN 33721

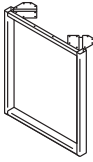
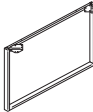
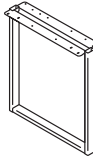
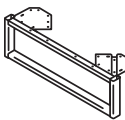
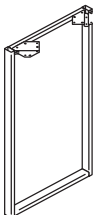
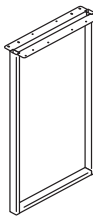

Icon Legend on page 19

	DESCRIPTION	MODEL	SHIP WEIGHT	CUBE	LIST PRICE BY PAINT GRADE		
					P1	P2	P3
	O-Leg 30"D x 28½"H 24"D x 28½"H	HLSL30280 ⓘ HLSL24280	19 17	5.4 3.7	\$474 \$428	\$479 \$433	\$495 \$449
	NOTES: Ship fully assembled, 1/pack. Non-handed. IMPORTANT: The O-leg attachment bracket interferes with placement of 28¾"H mobile pedestals, preventing them from being positioned directly next to (flush with) the O-leg. Box/file mobile pedestal (model HNL2116MBF) can be positioned along side the O-leg. SPECIFYING EXAMPLE: HLSL24280.T1						
	Double-Depth O-Leg Support for Worksurfaces 60"D x 28½"H 48"D x 28½"H	HLSL60280 HLSL48280	19 18	8.7 7.0	\$893 \$803	\$902 \$812	\$914 \$824
	NOTES: Ship fully assembled, 1/pack. Non-handed. 48"D and 60"D sizes span back-to-back 24"D and 30"D worksurfaces, respectively.						
	O-Leg Shared Support for Worksurfaces 30"D x 28½"H 24"D x 28½"H	HLSL3028SL ⓘ HLSL2428SL	19 17	5.4 3.7	\$589 \$531	\$594 \$536	\$610 \$552
	NOTES: Ship fully assembled, 1/pack. Non-handed. ⓘ Specify paint only. SPECIFYING EXAMPLE: HLSL2028SL.T1						
	O-Leg Support for Low Credenzas 30"D x 7"H 24"D x 7"H	HLSL3070 ⓘ HLSL2470	7 6	1.0 1.0	\$366 \$288	\$371 \$293	\$387 \$309
	NOTES: Ship fully assembled, 1/pack. Non-handed. For 7"H laminate support see page 98. ⓘ Specify paint only. SPECIFYING EXAMPLE: HLSL2070.T1						
	Standing-Height O-Leg Support for Worksurfaces 30"D x 41"H 24"D x 41"H	HLSL30410 HLSL24410	17 16	6.5 5.3	\$639 \$571	\$646 \$578	\$660 \$592
	NOTES: Ship fully assembled, 1/pack. Non-handed.						
	Standing-Height O-Leg Shared Support for Worksurfaces 30"D x 41"H 24"D x 41"H	HLSL3041SL HLSL2441SL	17 16	6.5 5.3	\$711 \$644	\$718 \$651	\$732 \$665
	NOTES: Ship fully assembled, 1/pack. Non-handed. For use with two 24"D or 30"D worksurfaces positioned side-by-side along the depth dimension.						



NOTES:

- Open frame, metal design.
- O-leg ships fully assembled with mounting hardware.
- O-leg glides have 2" adjustability.
- Will have 6" overhang when using 30"D O-legs with a 36"D worksurface.
- Shared O-legs create a cleaner aesthetic in all applications where two legs are used side-by-side.
- ⓘ O-legs may only be attached to worksurfaces, not storage units.
- ⓘ O-leg installation requires 6" of clearance from the worksurface end.
- ⓘ For use with worksurfaces up to 78"W. When using an 84"W or wider worksurface, cannot use two O-legs; must use one 15¾" or wider pedestal for the other support.

HOW TO SPECIFY

Select Model Number	Select Paint Color
HLSL30280	See page 173
T1	

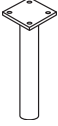

	DESCRIPTION	MODEL	SHIP WEIGHT	CUBE	LIST PRICE
	Support Column 3" Diameter. Specify: HPC190X.P. Black only.	HPC190X	12 	1.0	\$219
	Support Column 3" Diameter. Specify: HPC191X.X. Available in Silver only.	HPC191X	12 	1.0	\$219
	NOTES: For peninsula or island extension worksurface application.				

	DESCRIPTION	MODEL	SHIP WEIGHT	CUBE	LIST PRICE BY PAINT GRADE	
					P1	P2
	Post Leg Base 28½"H x 2" square	HLSL28P	15	1.0	\$385	\$390
	NOTES: Can only be used as the outbound support in a peninsula or island extension worksurface application. Glides have 2" of adjustability. Ship 1/pack. SPECIFYING EXAMPLE: HLSL28P.T1					

NOTES:

- All bases allow tops to sit at 29½" from the floor with glides half-way seated.
- Both glides and casters attach to the foot easily without tools for assembly.
- Bases specified with casters include two locking and two non-locking casters.
- Bases specified with glides have four adjustable glides, which adjust 1".
- When post legs are used with 18"W tops, post leg to be specified with glides only.
- ! Support column must be specified for worksurfaces used as peninsulas or as an island extension.
- ! Post leg can only be used to support peninsula, not as primary supports for a top.

HOW TO SPECIFY

Select Model Number	Select Paint Color See page 173
H P C 1 9 0 X .	T 1

CONCINNITY™

Components — Supports

GSA SIN 33721

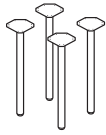
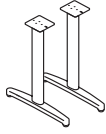

Icon Legend on page 19

	DESCRIPTION	MODEL	SHIP WEIGHT	CUBE	LIST PRICE
	<p>Post Leg Base (Includes 4 Post Legs) 24"D and 30"D Worksurfaces up to 72"W</p> <p>NOTES: For 54" and 60" worksurfaces, use one external channel, centered between user and approach sides. For 66" and 72"W worksurfaces, use two external channels; if no grommets, locate the channels 3" from user and approach sides; if grommets are in the worksurface, locate channels 3" from user and 6" from approach sides. 1¾" diameter Post Leg Base with glide (HMBPOST.G); qty. 4; for 30" to 72"W x 24"D and 48" to 72"W x 30"D tops 1¾" diameter Post Leg Base with casters (HMBPOST.C); qty. 4; for 30" to 72"W x 24"D and 48" to 72"W x 30"D tops</p>	HMBPOST	18	2.3	\$510
	<p>Fixed Height T-Leg Base (Includes 2 T-legs) For 24"D and 30"D Worksurfaces up to 72"W</p> <p>NOTES: Use external channel when space between the two legs is 54"W or greater. Center the channel between approach and user sides. See model listing on page 92. Fixed Height T-Leg Base with glide (HMBTLEG24.G); qty. 2; for 24" and 30"D tops up to 72"W; adjustable glides have 1" range Fixed Height T-Leg Base with casters (HMBTLEG24.C); qty. 2; for 24" and 30"D tops up to 72"W; two locking and two non-locking casters</p>	HMBTLEG24	14	3.6	\$602

NOTES:

- All bases allow tops to sit at 29½" from the floor with glides half-way seated.
 - Both glides and casters attach to the foot easily without tools for assembly.
 - Bases specified with glides have four adjustable glides, which adjust 1".
 - When post legs are used with 18"W tops, post leg to be specified with glides only.
- ⚠ Support column must be specified for worksurfaces used as peninsulas or as an island extension.
- ⚠ Post leg can only be used to support peninsula, not as primary supports for a top.

HOW TO SPECIFY**Select Model Number**

HMBTLEG24

Select Glide/Caster Option

- G Glide
 - C Caster
- 18"D tops are not available in Concinnity™

G

Select Paint Color

See page 29
\$21 upcharge per model, for Metallic paint

T1



CONCINNITY™ Height Adjustable Bases

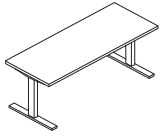

Base shown with work surface attached.

DESCRIPTION

Coordinate™ Height Adjustable Base – 2-Stage
2-Leg Rectangle T Foot

MODEL

HHATB2S2LT ©

SHIP WEIGHT

66 **Ⓢ**

CUBE

2.4

LIST PRICE

\$1058

NOTES:

- Dual motor two-leg design. Legs raise from 25 $\frac{5}{8}$ " to 45 $\frac{1}{4}$ ".
- Base accommodates any rectangular worksurface between 23"D x 40"W and 30"D x 72"W.
- Weight capacity of 250 lbs. (excluding the weight of the worksurface) distributed evenly.
- For use in combination applications where one end will be installed into a HAT shroud base or HAT low credenzas and the other end will have an exposed T Foot.
- Model includes quantity 2 feet. The unused foot will need to be discarded at time of install.

! Only 2-Stage Coordinate™ bases will work with HAT shrouds and HAT low credenzas. 3-Stage Coordinate™ bases should not be used due to their lower height range.

NOTES:

Height Adjustable Base

- Control Box: 120V, 4A, 60Hz, 400W.
- 9' grounded power cord.
- 1 $\frac{1}{2}$ " / second travel speed.
- <50 dB noise rating.
- **HON 10-Year Warranty.**

- ! Requires the use of an external stiffener (purchased separately) for worksurfaces over 60"W when not used with a Coordinate™ worksurface.**
- ! Full-to-floor/full-length modesty panels not for use with height adjustable desks/shrouds.**

HOW TO SPECIFY

Select Model Number

H H A T B 2 S 2 L T .

Select Paint Color

See page 114

P R 6 .

Select Foot

- X Standard Foot
- S Slide Glide

X .

Select Keypad

- UD Basic Up/Down
- MEM Memory Preset
- PDL Paddle

M E M

CONCINNITY™ Height Adjustable Bases

OPEN MARKET



Icon Legend on page 19

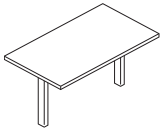

DESCRIPTION

2-Leg Height Adjustable Base — 2-Stage

MODEL

HNLAB2SIL

SHIP WEIGHT

66

CUBE

3.5

LIST PRICE

\$977

NOTES: Base's design is without feet, which allows the leg to be directly installed into a shroud or low credenza.

❗ Base cannot be used as a stand-alone model. Base must be directly installed into a shroud or low credenza. Base ships without feet.

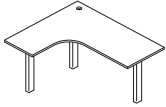

3-Leg Height Adjustable Base — 2-Stage

HNLAB3SIL

91

5.7

\$1630

NOTES: Base's design is without feet, which allows the leg to be directly installed into a shroud or low credenza.

❗ Base cannot be used as a stand-alone model. Base must be directly installed into a shroud or low credenza. Base ships without feet.

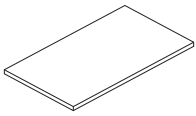

DESCRIPTION

Return Top for Height Adjustable Base

MODEL

HNLRR4623

SHIP WEIGHT

38

CUBE

3.8

L1 LIST PRICE

\$362

L2 UPCHARGE

\$16

46"W x 23"D

HNLRR4023

33

3.4

\$337

\$16

40"W x 23"D

HNLRR3423

28

3.0

\$305

\$16

34"W x 23"D

HNLRR2823

23

2.6

\$305

\$16

NOTES: Tops are 1" shorter to accommodate for pinch points.

NOTES:

- Base is a two motor 2-stage design. Legs raise from 25⁹/₁₆"H to 45¹/₁₆"H.
- Base telescopes to accommodate corner cove and rectangle/return worksurfaces.
- Supports weight capacity of 325 lbs. for 3-leg bases and 275 lbs. for 2-leg bases (excluding worksurface weight).
- 1¹/₈" per second travel speed.
- See page 90 for Corner Cove Tops for use with Height Adjustable Base.
- See pages 86-87 for Concinnity™ worksurfaces for Height Adjustable Bases and page 117 for Coordinate™ worksurfaces.
- See page 92 for HAT Half-Height Modesty Panels.
- **HON 7-Year Limited Warranty.**

❗ Only 2-Stage Coordinate™ bases will work with HAT shrouds and HAT low credenzas. 3-Stage Coordinate™ bases should not be used due to their lower height range.

HOW TO SPECIFY

<p>Select Model Number</p> <p>H N L A B 2 S I L</p>	<p>Select Paint Color</p> <p>See page 29</p> <p>P</p>	<p>Select Control</p> <p>UD Basic Up/Down MEM Memory Preset PDL Paddle</p> <p>MEM</p>
<p>Select Model Number</p> <p>H N L R R 4 0 2 3</p>	<p>Select Edge Color</p> <p>See page 29</p> <p>H</p>	<p>Select Laminate Color</p> <p>See page 29</p> <p>H</p>



CONCINNITY™ Height Adjustable Bases

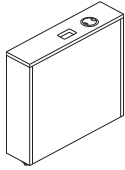

DESCRIPTION

MODEL

SHIP WEIGHT

CUBE

L1 LIST PRICE

L2 UPCHARGE

Shroud for Height Adjustable Base

36"D	HNL36SHR	48	4.7	\$1122	\$32
30"D	HNL30SHR	40	3.9	\$1100	\$27
24"D	HNL24SHR	33	3.1	\$1078	\$27

NOTES: Depths designed to match worksurface depths. Right- or left-handed determines which side the grommet is on.

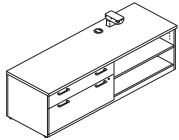

HAT Low Credenza

72"W x 24"D x 21½"H, Left (shown)	HNL247221LH	254	27.2	\$2034	\$21
60"W x 24"D x 21½"H, Left	HNL246021LH	215	22.8	\$1895	\$21
72"W x 24"D x 21½"H, Right	HNL247221RH	254	27.2	\$2034	\$21
60"W x 24"D x 21½"H, Right	HNL246021RH	215	22.8	\$1895	\$21

NOTES: When specifying a grommet application, the grommet is near the front leg for cord management and has a grommet on the backside for cord management to wall power. See lock and grommet color matrix on page 35.

SPEC TIPS:

- HAT base is bolted directly into unit for a solid connection without the need for the HAT base freestanding on feet.
- In combination applications with one HAT leg integrated and one HAT leg with an exposed T Foot use footed Coordinate™ base model HHATB2S2LT on page 103 and discard the unused foot at time of install.
- In applications with both ends integrated into a shroud or credenza use the non-footed Coordinate™ bases HNLAB2SIL or HNLAB3SIL on page 104.
- For HAT shrouds the leg cut-out standard. Grommet optional.
- For HAT credenzas the leg cut-out and grommet are optional.

! Only 2-Stage Coordinate™ bases will work with HAT shrouds and HAT low credenzas. 3-Stage Coordinate™ bases should not be used due to their lower height range.

! Only 2-Stage Coordinate™ bases will work with HAT shrouds and HAT low credenzas. 3-Stage Coordinate™ bases should not be used due to their lower height range.

HOW TO SPECIFY

<p>Select Model Number</p> <p>H N L 3 0 S H R .</p>	<p>Select Grommet and Color (Leg Cut-Out Standard)</p> <p>See page 29</p> <p>X No Grommet R Right Hand L Left Hand</p> <p>R .</p>	<p>Select Laminate Color</p> <p>See page 29</p> <p>H</p>
--	---	---

<p>Select Model Number</p> <p>H N L 2 4 6 0 2 1 L H .</p>	<p>Select Edge Profile and Edge Color</p> <p>See page 29</p> <p>G H .</p>	<p>Select Handle</p> <p>See page 35</p> <p>J .</p>	<p>Select Grommet and Color</p> <p>See page 29</p> <p>X No Grommet 2L 2-Leg 3L 3-Leg</p> <p>2 L .</p>	<p>Select Top Laminate</p> <p>See page 29</p> <p>H .</p>	<p>Select Chassis Laminate</p> <p>See page 29</p> <p>H .</p>	<p>Select Drawer Front Laminate</p> <p>See page 29</p> <p>H</p>
--	--	---	---	---	---	--

NOTES



CONCINNITY™

Components — Supports

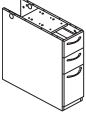
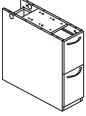
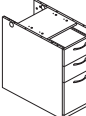
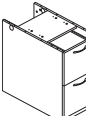
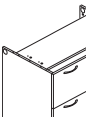
	DESCRIPTION	MODEL	SHIP WEIGHT	CUBE	L1 LIST	L2 UPCHARGES	
						CHASSIS	FRONTS
	Narrow Box/Box/File Pedestal 9½"W x 29⅞"D x 28½"H	HNL291028PBBF	64	10.6	\$1011	\$27	\$11
	9½"W x 23⅞"D x 28½"H	HNL231028PBBF	53	8.6	\$905	\$21	\$11
	NOTES: Efficient, space saving design for smaller footprints. Three locking drawers; two box (supply) drawers, one for files. File drawer has high sides to accept hanging folders. Pedestal's top and back are open and require top and back panel components — ordered separately. See chart on page 48 for cord management options. Ships fully assembled. SPECIFYING EXAMPLE: HNL291028PBBF.E.X.H.H						
	Narrow File/File Pedestal 9½"W x 29⅞"D x 28½"H	HNL291028PFF	69	10.6	\$1011	\$27	\$11
	9½"W x 23⅞"D x 28½"H	HNL231028PFF	54	10.6	\$905	\$21	\$11
	NOTES: Efficient, space saving design for smaller footprints. Two locking file drawers. Drawers have high sides to accept hanging folders. Pedestal's top and back are open and require top and back panel components — ordered separately. See chart on page 48 for cord management options. Ships fully assembled. SPECIFYING EXAMPLE: HNL291028PFF.E.X.H.H						
	Box/Box/File Pedestal 15¾"W x 29⅞"D x 28½"H	HNL291628PBBF	76	10.6	\$1027	\$27	\$11
	18"W x 23⅞"D x 28½"H	HNL231828PBBF	72	9.8	\$1030	\$21	\$11
	15¾"W x 23⅞"D x 28½"H	HNL231628PBBF	69	8.6	\$937	\$21	\$11
	NOTES: Three locking drawers; two box (supply) drawers, one for files. File drawer has high sides to accept hanging folders and front-to-back for letter filing. Pedestal's top and back are open and require top and back panel components — ordered separately. See chart on page 48 for cord management options. Ships fully assembled. SPECIFYING EXAMPLE: HNL291628PBBF.E.X.H.H						
	File/File Pedestal 15¾"W x 29⅞"D x 28½"H	HNL291628PFF	78	10.6	\$1027	\$27	\$11
	18"W x 23⅞"D x 28½"H	HNL231828PFF	72	9.8	\$1030	\$21	\$11
	15¾"W x 23⅞"D x 28½"H	HNL231628PFF	70	8.6	\$937	\$21	\$11
	NOTES: Two locking file drawers. Drawers have high sides to accept hanging folders and front-to-back for letter filing. Pedestal's top and back are open and require top and back panel components — ordered separately. See chart on page 48 for cord management options. Ships fully assembled. SPECIFYING EXAMPLE: HNL291628PFF.E.X.H.H						
	Lateral File Pedestal 36"W x 23⅞"D x 28½"H	HNL233628PLF	134	18.4	\$1382	\$42	\$21
	30"W x 23⅞"D x 28½"H	HNL233028PLF	115	15.0	\$1262	\$37	\$21
	NOTES: Two locking file drawers; drawers include hangrails to accept folders in letter or legal size. For use under 24"D rectangle worksurface. Widths can also span depth dimension of respective 30" or 36"D rectangle worksurface. Anti-tip design includes mechanical interlock to inhibit the extension of more than one drawer at a time. Pedestal's top and back are open and require top and back panel components — ordered separately. See chart on page 48 for cord management options. Ships fully assembled. SPECIFYING EXAMPLE: HNL233628PLF.E.X.H.H						

NOTES:

- 29⅞"D pedestals can be used under 30" or 36"D worksurfaces; 23⅞"D pedestals can be used under 24"D worksurfaces only (30"D top grommet locations are not designed to create overhang desks with 23⅞"D pedestals).
- Drawers operate on steel ball-bearing suspensions to ensure smooth, quiet, long-lasting operation; full extension allows easy access to contents.
- Interchangeable core removable locks allow users to access all furniture pieces in an office with a single key for convenience and security. Makes re-keying quick and easy.
- See chart on page 48 for cord management options. If the pedestal grommet option is chosen, two cutouts, one per end/side panel, each with a black plastic cap, are included.

! Pedestal tops and backs are open and require top and back panel components — ordered separately.

! 9½"W pedestals are not designed to be used independently in a stand-alone application.

HOW TO SPECIFY

Select Model Number	Select Handle See page 35	Select Grommet P Black X No Grommet	Select Chassis Color See page 29	Select Drawer Front Color See page 29
H N L 2 9 1 0 2 8 P B B F .	E .	X .	H .	H .

CONCINNITY™

Components — Supports

GSA SIN 33721

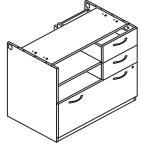

Icon Legend on page 19

**DESCRIPTION****Shelf/Box/Box/Lateral File Pedestal**

36"W x 23½"D x 28½"H

30"W x 23½"D x 28½"H

MODEL**HNL233628PSL****HNL233028PSL****SHIP WEIGHT**

145

126

CUBE

18.4

15.0

L1 LIST**\$1631****\$1598****L2 UPCHARGES****CHASSIS****\$42****\$37****FRONTS****\$21****\$21**

NOTES: Versatile unit features an open shelf and three drawers; two for supplies and one for files. For use under 24"D rectangle worksurface. Widths can also span depth dimension of respective 30" or 36"D rectangle worksurface. Box (supply) drawers are located on the right and open shelves on the left. All drawers lock. Pedestal's top and back are open and require top and back panel components — ordered separately. See chart on page 48 for cord management options. Ships fully assembled.

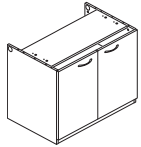
SPECIFYING EXAMPLE: HNL233628PSL.E.X.H.H**Storage Cabinet Pedestal**

36"W x 23½"D x 28½"H

30"W x 23½"D x 28½"H

HNL233628PSC**HNL233028PSC**

104

91

18.4

15.0

\$1062**\$1027****\$42****\$37****\$21****\$21**

NOTES: One adjustable shelf, which adjusts in 2½" increments. For use under 24"D rectangle worksurface. Widths can also span depth dimension of respective 30" or 36"D rectangle worksurface. Doors are non-locking. Pedestal's top and back are open and require top and back panel components — ordered separately. See chart on page 48 for cord management options. Ships fully assembled.

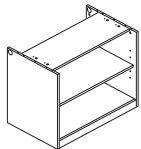
SPECIFYING EXAMPLE: HNL233628PSC.E.X.H.H**Bookcase Pedestal**

36"W x 23½"D x 28½"H

30"W x 23½"D x 28½"H

HNL233628PBK**HNL233028PBK**

82

73

18.4

15.0

\$934**\$913****\$42****\$37****N/A****N/A**

NOTES: Two shelves; bottom of unit plus one adjustable shelf, which adjusts in 2½" increments. For use under 24"D rectangle worksurface. Widths can also span depth dimension of respective 30" or 36"D rectangle worksurface. Pedestal's top and back are open and require top and back panel components — ordered separately. See chart on page 48 for cord management options. Ships fully assembled.

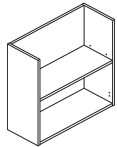
SPECIFYING EXAMPLE: HNL233628PBK.X.H**Bookcase End Support**

12"W x 36"D x 28½"H

12"W x 30"D x 28½"H

12"W x 24"D x 28½"H

HNL123628BKE**HNL123028BKE****HNL122428BKE**

48

48

41

11.0

10.2

7.4

\$703**\$666****\$633****\$27****\$21****\$21****N/A****N/A****N/A**

NOTES: Two shelves; bottom of unit plus one adjustable shelf, which adjusts in 1¼" increments. Designed to span the depth dimension of 24", 30", or 36"D rectangle worksurface; shelves can be oriented facing outwards, or inwards towards the user's kneespace. Includes fully finished back. Ships with two (2) extra L-brackets for applications requiring attachment of a laminate modesty panel; the panel brackets to the back of the bookcase end support. Modesty panel specified should be 12" less than the worksurface width. Open top; for use under worksurface only — ordered separately. Ships fully assembled.

SPECIFYING EXAMPLE: HNL123628BKE.H**NOTES:**

- 23½"D pedestals can be used under 24"D worksurfaces only (30"D top grommet locations are not designed to create overhang desks with 23½"D pedestals).
- Drawers operate on steel ball-bearing suspensions to ensure smooth, quiet, long-lasting operation; full extension allows easy access to contents.
- Interchangeable core removable locks allow users to access all furniture pieces in an office with a single key for convenience and security. Makes re-keying quick and easy.
- See chart on page 48 for cord management options. If the pedestal grommet option is chosen, two cutouts, one per end/side panel, each with a black plastic cap, are included.

! Pedestal tops and backs are open and require top and back panel components — ordered separately.

HOW TO SPECIFY

Select Model Number H N L 2 3 3 6 2 8 P S L .	Select Handle See page 35 E .	Select Grommet P Black X No Grommet X .	Select Chassis Color See page 29 H .	Select Drawer Front Color See page 29 H
---	--	---	---	--



CONCINNITY™

Components — Supports

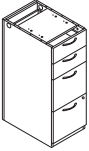
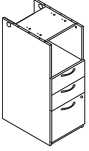
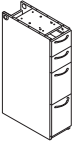
	DESCRIPTION	MODEL	SHIP WEIGHT	CUBE	L1 LIST	L2 UPCHARGES	
						CHASSIS	FRONTS
	Box/Box/File/File Pedestal 15¾"W x 29⅞"D x 41"H	HNL291641PBBFF	114	14.7	\$2098	\$48	\$11
	15¾"W x 23⅞"D x 41"H	HNL231641PBBFF	102	11.9	\$1969	\$42	\$11
	NOTES: Four drawers: two box (supply) and two file. File drawer has high sides to accept hanging folders; hangrails are included for side-to-side letter or legal filing; and front-to-back for letter filing. The two box drawers do not lock. Pedestal's top and back are open and require top and back panel components — ordered separately. See chart on page 48 for cord management options. Ships fully assembled. SPECIFYING EXAMPLE: HNL291641PBBFF.E.X.H.H						
	Shelf/Box/Box/File Pedestal 15¾"W x 29⅞"D x 41"H	HNL291641PSBBF	99	14.7	\$2098	\$48	\$11
	15¾"W x 23⅞"D x 41"H	HNL231641PSBBF	89	11.9	\$1969	\$42	\$11
	NOTES: Open shelf over three drawers: two box (supply) and one file. Interior dimensions of the open storage area are: 14⅞"W x 28¼"D x 12¼"H for the 29⅞"D pedestal. 14⅞"W x 22¼"D x 12¼"H for the 23⅞"D pedestal. File drawer has high sides to accept hanging folders; hangrails are included for side-to-side letter or legal filing; and front-to-back for letter filing. All drawers lock. Pedestal's top and back are open and require top and back panel components — ordered separately. See chart on page 48 for cord management options. Ships fully assembled. SPECIFYING EXAMPLE: HNL291641PSBBF.E.X.H.H						
	Narrow Box/Box/File/File Pedestal 9½"W x 29⅞"D x 41"H	HNL291041PBBFF	88	14.7	\$1847	\$48	\$21
	9½"W x 23⅞"D x 41"H	HNL231041PBBFF	79	11.9	\$1731	\$42	\$21
	NOTES: Efficient, space saving design for smaller footprints. Four drawers: two box (supply) and two file. File drawers have high sides to accept hanging folders; hangrails are included for side-to-side letter or legal filing. When used in a double pedestal configuration under a 60" and 48"W worksurface, provides 41" and 29" of kneespace width, respectively. The two box drawers do not lock. Pedestal's top and back are open and require top and back panel components — ordered separately. See chart on page 48 for cord management options. Ships fully assembled. SPECIFYING EXAMPLE: HNL291041PBBFF.E.X.H.H						

NOTES:

- Pedestals for standing-height workstations.
- 29⅞"D pedestals can be used under 30" or 36"D worksurfaces; 23⅞"D pedestals can be used under 24"D worksurfaces only (30"D top grommet locations are not designed to create overhang desks with 23⅞"D pedestals).
- Drawers operate on steel ball-bearing suspensions to ensure smooth, quiet, long-lasting operation; full extension allows easy access to contents.
- See chart on page 48 for cord management options. If the pedestal grommet option is chosen, two cutouts, one per end/side panel, each with a black plastic cap, are included.

! Pedestal tops and backs are open and require top and back panel components — ordered separately.

! 9½"W pedestals are not designed to be used independently in a stand-alone application.

HOW TO SPECIFY

Select Model Number	Select Handle See page 35	Select Grommet P Black X No Grommet	Select Chassis Color See page 29	Select Drawer Front Color See page 29
H N L 2 9 1 6 4 1 P B B F F .	E .	X .	H .	H .

CONCINNITY™ Components — Pedestal Tops

GSA SIN 33721



Icon Legend on page 19

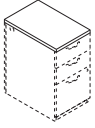

DESCRIPTION	MODEL	SHIP WEIGHT	CUBE	L1 LIST PRICE	L2 UPCHARGE
Pedestal Tops					
15¾"W x 30"D	HNLPT3016	16	1.4	\$306	\$11
18"W x 24"D	HNLPT2418	15	1.3	\$286	\$11
15¾"W x 24"D	HNLPT2416	13	1.2	\$286	\$11

NOTES: Component is 1½" thick. Underside of top includes pilot mounting holes for pedestals. Grain direction on 15¾" and 18"W pedestal tops runs horizontal (side-to-side). Component tops for 30" and 36"W pedestals are listed with rectangle worksurface sizes. Grain direction on 30" and 36"W pedestal tops can be specified horizontal (side-to-side) or vertical (front-to-back). For tri-oval and beaded edge options, there is a shaped profile on the user and approach sides, and a flat edge on the ends.

- ⓘ For modular pedestals used in freestanding applications; not compatible when pedestal is positioned under a worksurface.
- ⓘ 9½"W pedestals are not designed to be used independently in a freestanding application, so 9½"W tops are not available to order.

HOW TO SPECIFY

Select Model Number

H N L P T 3 0 1 6 .

Select Edge Profile and Edge Color

See page 29

B H .

Select Top Color

See page 29

H



CONCINNITY™

Components — Pedestal Back Panels

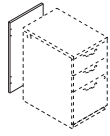
**DESCRIPTION****Full Back Panels — For 28½”H Pedestals**

18”W x 27⅞”H

15¾”W x 27⅞”H

9½”W x 27⅞”H

MODEL**HNLBP1828****HNLBP1628****HNLBP1028****SHIP WEIGHT**

11

10

6

CUBE

1.5

1.3

0.9

L1 LIST PRICE**\$198****\$177****\$168****L2 UPCHARGE****\$11****\$11****\$11**

NOTES: Encloses the rear of 28½”H modular support pedestals, which come standard with an open, unfinished back. For use when a support storage pedestal is positioned under a 29½”H worksurface and a conventional worksurface width x 27⅞”H modesty/back panel is not specified to cover the back of the pedestal. For 30” and 36”W pedestals, use the respective modesty/pedestal back panel size, see page 93.

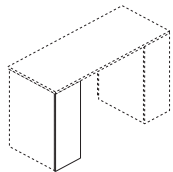
SPECIFYING EXAMPLE (9½”, 15¾”, 18”W): HNLBP1028.H

Back View

Full Back Panels — For 41”H Pedestals

15¾”W x 40⅜”H

9½”W x 40⅜”H

HNLBP1641**HNLBP1041**

15

9

1.8

1.2

\$202**\$184****\$16****\$16**

NOTES: Encloses the rear of 41”H modular support pedestals, which come standard with an open, unfinished back. For use when a support storage pedestal is positioned under a 42”H worksurface and no full-width, 27⅞”H laminate modesty and low, 13”H pedestal back panel are specified.

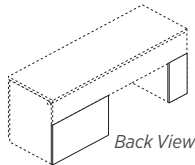
SPECIFYING EXAMPLE: HNLBP1641.H

Back View

Shown with HNLLB3018 and HNLLB1018

Low Back Panels — For 28½”H Pedestals

36”W x 18”H

30”W x 18”H

18”W x 18”H

15¾”W x 18”H

9½”W x 18”H

HNLLB3618**HNLLB3018****HNLLB1818****HNLLB1618****HNLLB1018**

15

12

7

6

4

1.9

1.6

1.0

0.9

0.6

\$198**\$198****\$177****\$170****\$159****\$16****\$16****\$16****\$11****\$11**

NOTES: Encloses the rear of 28½”H modular support pedestals when positioned under a 29½”H worksurface with a full-width, 10” laminate modesty panel. The modesty panel extends down from the underside of the worksurface to cover the upper back portion of the pedestal, the lower panel component encloses the remainder of the pedestal back. When used in combination, the 10” modesty and pedestal low back panels fully conceal the rear of the pedestal. The pedestal low back panel is only for use when a modular pedestal is used in conjunction with a worksurface with a 10” laminate modesty panel and the customer wants/needs to fully enclose the back section of the pedestal.

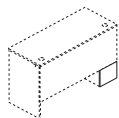

Back View

Low Back Panels — For 41”H Pedestals

15¾”W x 13”H

9½”W x 13”H

HNLLB1613**HNLLB1013**

4

3

0.7

0.5

\$170**\$159****\$11****\$11**

NOTES: Encloses the rear of 41”H modular support pedestals when positioned under a 42”H worksurface with a full-width, 27⅞” laminate modesty panel. The modesty panel extends down from the underside of the worksurface to cover the upper back portion of the pedestal, the lower panel component encloses the remainder of the pedestal back. When used in combination, the 27⅞” modesty and pedestal low back panels fully conceal the rear of the pedestal. The pedestal low back panel is only for use when a modular pedestal is used in conjunction with a worksurface with a 27⅞” laminate modesty panel and the customer wants/needs to fully enclose the back section of the pedestal.

HOW TO SPECIFY**Select Model Number**

H N L P B 1 8 2 8

Select Laminate Color

See page 29

H

Select Model Number

H N L L B 3 6 1 8

Select Laminate Color

See page 29

H



Refer to page 112 for Center Drawer compatibility information

DESCRIPTION	MODEL	SHIP WEIGHT	CUBE	L1 LIST PRICE	L2 UPCHARGE
Laminate Center Drawer 22" x 15 ³ / ₈ " <ul style="list-style-type: none"> • 12" drawer extension (3/4). • Inside drawer dimension for H1522: 18⁷/₈"W x 15¹/₂"D x 1¹/₂"H. • Minimum clearance for mounting H1522: 22³/₄"W x 18¹/₂"D compatible with 72"W x 36"D, 66"W x 30"D, 60"W x 30"D Double Pedestal Desks, 72"W x 36"D, 66"W x 30"D Single Pedestal Desks, Bullet and P-shaped Peninsulas, 72"W x 24"D, 66"W x 24"D, 60"W x 24"D Credenza w/Kneespace, 72"W x 24"D, 66"W x 24"D Single Pedestal Credenzas, 48"W x 24"D, 42"W x 24"D Returns NOTES: Specify laminate for drawer. Model H1522 or H1022 can be used on peninsulas with modesty panel, model HPC180W. Laminate center drawers include pencil tray. For center drawer laminate colors, see page 29.	H1522	11	1.1	\$252	\$16

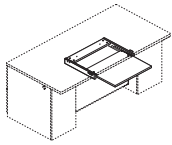

Collaborative Desk Shelf 25"W x 23"D x 2 ¹ / ₂ "H	HNLCDSEHF	18	1.5	\$469	\$21
---	------------------	----	-----	--------------	-------------

NOTES: Convenient slide-out shelf on approach-side of desk provides workspace for guests. For use with 72"W x 36"D breakfront desk designs — see listings on page 55 — or with 60" or wider worksurface, supported by pedestals, and no modesty panel. Minimum clearance for mounting: 28"W x 19³/₄"D. Fully extended shelf dimensions: 24"W x 19"D. Shelf extends 12³/₈". ³/₄" thick. Not compatible on desks with under-surface center drawer or keyboard platform attached. Can be specified in a woodgrain or solid laminate color only.

Collaborative desk shelf for use with 72"W x 36"D breakfront, floating modesty panel desk designs or with 60" or wider worksurface, supported by pedestals, and no modesty panel.

SPECIFYING EXAMPLE: HNLCDSEHF.H

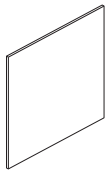

DESCRIPTION	MODEL	SHIP WEIGHT	CUBE	LIST PRICE
Wall Mount Tackboard 36"W x 35 ¹ / ₄ "H 30"W x 35 ¹ / ₄ "H	HNL3636TB	20	2.9	\$409
	HNL3630TB	16	2.9	\$348
36"W x 48 ⁵ / ₈ "H 30"W x 48 ⁵ / ₈ "H	HNL4936TB	27	5.5	\$454
	HNL4930TB	22	3.7	\$396

NOTES: For a list of standard fabrics, see pages 25-26. For a complete list of fabrics, please go to hon.com/fabricsandfinishes. When positioned above 29¹/₂"H floor-standing storage, the sizes align with overhead storage height options. Can be positioned side-by-side with corresponding wall mount markerboard sizes. Easy to install; includes mounting hardware. Attaches to wall with horizontally mounted, interlocking Z-clip brackets. For the space directly below stack-on and wall mount storage cabinets, use the 18"H tackboard models listed on Pricer pages 69 and 73.

SPECIFYING EXAMPLE: HNL3636TB.APN15

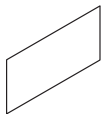

Markerboard 36"W x 15"D 30"W x 15"D	HLSL1536SOMB	8	1.0	\$243
	HLSL1530SOMB	6	1.0	\$182

NOTES: Markerboard laminate material with black edges, no frame. Adheres to laminate doors. Includes double-sided tape. No specification necessary.

HOW TO SPECIFY

Select Model Number H N L C D S H E L F .	Select Laminate Color See page 29 H
---	--



Coordinate™ Height Adjustable Base shown with Ignition® 2.0 Seating and 10500 Series™ Desking.

COORDINATE™

The power to choose is now at your fingertips — sit tight or stretch out with a Coordinate height adjustable base! It doesn't matter if you're perfecting that project in a private office or collaborating with the crew from your cubicle, Coordinate easily adapts to your body and your day with streamlined style and effortless versatility.



FEATURES

- Make quick and easy adjustments all day long with a variety of control options: standard memory preset, basic up/down, paddle control, or a Wireless option.
- Bases available in 2- or 3-leg rectangle C- and T-shaped foot options to accommodate your layout preferences.
- Newly designed base is lighter scale with a clean aesthetic and easy assembly.
- All bases are compatible with electrical accessories and select worksurfaces.

COORDINATE™ ORDERING INFORMATION

BASE PAINT

PAINT	CODES
◆ Black	P71
◆ Charcoal	S
◆ Designer White	PJW
◆ Loft	LOFT
◆ Silver	PR6

GROMMET

GROMMET	CODES
◆ Black	P
◆ Charcoal	S
◆ Designer White	DW
◆ Greige	T5
◆ Light Gray	Q
◆ Loft	LOFT
◆ Muslin	T3
◆ Platinum	T1

DESKTOP PET

PET	CODES
◆ Dark Blue	DDB1
◆ Dark Gray	DGY4
◆ Green	DGN1
◆ Medium Gray	DGY3

LAMINATE

L1 LAMINATES CODES

Woodgrain	
◆ Bourbon Cherry	H
◆ Cognac	COGN
◆ Field Elm	LWFE
◆ Florence Walnut	LFW1
◆ Harvest	C
◆ Kingswood Walnut	LKI1
◆ Mahogany	N
◆ Mocha	MOCH
◆ Natural Maple	D
◆ Pinnacle	PINC
◆ Shaker Cherry	F
◆ Sterling Ash	LSA1

Solid	
◆ Black	P
◆ Charcoal	S
◆ Designer White	LDW1
◆ Loft	LOFT

Patterned	
◆ Handspun Chestnut	LAHC
◆ Handspun Dove	LAHD
◆ Handspun Pearl	LAHP
◆ Handspun Slate	LAHS
◆ Silver Mesh	B9
◆ Steel Mesh	A9
◆ Gray	G2
◆ White	G1

L2 LAMINATES CODES

Woodgrain	
◆ Beigewood	LWBE
◆ Fawn Cypress	LFC1
◆ Lowell Ash	LLA1
◆ Natural Recon	LNRI
◆ Phantom Ecrú	LPE1
◆ Portico Teak	LPT1
◆ Skyline Walnut	LSW1

EDGE

EDGE CODES

Woodgrain	
◆ Beigewood	DE
◆ Bourbon Cherry	H
◆ Cognac	COGN
◆ Fawn Cypress	FC
◆ Field Elm	FE
◆ Florence Walnut	FW
◆ Harvest	C
◆ Kingswood Walnut	KI
◆ Light Gray	Q
◆ Lowell Ash	DL
◆ Mahogany	N
◆ Mocha	MOCH
◆ Natural Maple	D
◆ Natural Recon	NR
◆ Phantom Ecrú	PE
◆ Pinnacle	PINC
◆ Portico Teak	DP
◆ Shaker Cherry	F
◆ Skyline Walnut	SW
◆ Sterling Ash	SA

Solid	
◆ Black	P
◆ Brownstone	EY
◆ Charcoal	S
◆ Designer White	DW
◆ Fossil	EH
◆ Greige	R
◆ Loft	LOFT
◆ Muslin	T
◆ Platinum	K

TIE-IN BRACKETS

PAINT CODES

P1	
◆ Black	P
◆ Brownstone	P7D
◆ Charcoal	S
◆ Designer White	PJW
◆ Fossil	P28
◆ Greige	T5
◆ Light Gray	Q
◆ Loft	LOFT
◆ Muslin	T3
◆ Putty	L
◆ Titanium	P8T

P2	
◆ Champagne Metallic	T4
◆ Platinum Metallic	T1
◆ Silver	PR6
◆ Solar Black	P8X

SCREEN PAINT

PAINT CODES

P1	
◆ Black	P
◆ Brownstone	P7D
◆ Charcoal	S
◆ Designer White	PJW
◆ Fossil	P28
◆ Greige	T5
◆ Light Gray	Q
◆ Loft	LOFT
◆ Muslin	T3
◆ Putty	L
◆ Titanium	P8T

P2	
◆ Champagne Metallic	T4
◆ Gunmetal Metallic	PR3
◆ Platinum Metallic	T1
◆ Silver	PR6
◆ Solar Black	P8X

P3	
◆ Amethyst	P091
◆ Atom	P8S
◆ Blossom	P8K
◆ Bullseye	PJF
◆ Cobalt Mica	P090
◆ Ember	P8P
◆ Ion	P8N
◆ Iris	P8J
◆ Krypton	P8F
◆ Ochre	P093
◆ Regatta	P8M
◆ Sienna	P092
◆ Succulent	P8A

LEG OPTIONS



Rectangle Leg, T Foot



Rectangle Leg, C Foot

CONTROL OPTIONS



Memory Control



Basic Up/Down



Paddle



Wireless Dongle*

* Wireless dongle can be used with the AiDesk App. Wireless dongle is backwards compatible with previously ordered bases. Not compatible with ETA Coordinate™ base.

◆◆◆ For lead time information see page 21.

* De-emphasized



COORDINATE™ Height Adjustable Bases

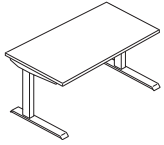
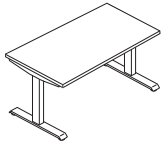

DESCRIPTION	MODEL	SHIP WEIGHT	CUBE	LIST PRICE
Coordinate™ Height Adjustable Base – 2-Stage				
2-Leg Rectangle T Foot	HHATB2S2LT ☺	66 Ⓔ	2.4	\$1058
2-Leg Rectangle C Foot	HHATB2S2LC	66 Ⓔ	2.4	\$1058
NOTES:				
<ul style="list-style-type: none"> • Dual motor two-leg design. Legs raise from 26½” to 45¾” (without worksurface). • Base accommodates any rectangular worksurface between 23”D x 24”W and 30”D x 72”W. • Weight capacity of 250 lbs. (including the weight of the worksurface) distributed evenly. 				
Coordinate™ Height Adjustable Base – 3-Stage				
2-Leg Rectangle T Foot	HHATB3S2LT ☺	66 Ⓔ	2.4	\$1167
2-Leg Rectangle C Foot	HHATB3S2LC	66 Ⓔ	2.4	\$1167
NOTES:				
<ul style="list-style-type: none"> • Dual motor two-leg design. Legs raise from 21¾” to 47½” (without worksurface). • Base accommodates any rectangular worksurface between 23”D x 24”W and 30”D x 72”W. • Weight capacity of 250 lbs. (including the weight of the worksurface) distributed evenly. 				
Coordinate™ Height Adjustable Base – Max 3-Stage				
2-Leg Rectangle T Foot	HHATM3S2LT	66 Ⓔ	2.4	\$1307
NOTES:				
<ul style="list-style-type: none"> • Dual motor two-leg design. Legs raise from 21¾” to 47½” (without worksurface). • Base accommodates any rectangular worksurface between 23”D x 24”W and 30”D x 96”W. • Weight capacity of 350 lbs. (including the weight of the worksurface) distributed evenly. 				

NOTES:

- Control Box: 120V, 4A, 60Hz, 400W.
- 9’ grounded power cord.
- 1½”/second travel speed.
- <50 dB noise rating.
- 2-Leg Height Adjustable Bases can accommodate rectangular worksurfaces down to 24”W. 10500 Series™, Concinnity™, and Voi® all have rectangular worksurfaces shorter than 40”W.
- Collision detection featured on base.
- **HON 10-Year Warranty.**

ⓘ Requires the use of an external stiffener (purchased separately) for worksurfaces over 58”W or wider when not used with a Coordinate™ worksurface.

HOW TO SPECIFY

<p>Select Model Number</p> <p>HHATB3S2LT</p>	<p>Select Paint Color</p> <p>See page 114</p> <p>PR6</p>	<p>Select Foot</p> <p>X Standard Foot S Slide Glide</p> <p>X</p>	<p>Select Keypad</p> <p>UD Basic Up/Down MEM Memory Preset PDL Paddle</p> <p>MEM</p>
---	---	---	---

COORDINATE™

Height Adjustable Bases

GSA SIN 33721



Icon Legend on page 19

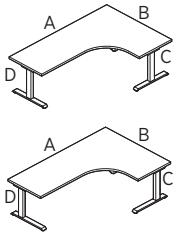

DESCRIPTION	MODEL	SHIP WEIGHT	CUBE	LIST PRICE
Coordinate™ Height Adjustable Base – 2-Stage				
3-Leg Rectangle T Foot	HHATB2S3LT	72.5	2.3	\$1819
3-Leg Rectangle C Foot	HHATB2S3LC	72.5	2.3	\$1819
NOTES:				
<ul style="list-style-type: none"> • Tri-motor three-leg design. Legs raise from 26½" to 45¾". • Base accommodates worksurfaces between 24"D x 48"W x 36"W and 30"D x 72"W x 48"W. Can be used with 48" 120° work surface models. • Weight capacity of 375 lbs. (including the weight of the work surface) distributed evenly. 				
<ul style="list-style-type: none"> ⚠ Not compatible with 2-piece top configurations (Max base required). ⚠ Each work surface 58"W or wider requires the use of an external stiffener; including secondary return work surface in an "L" 3-leg base application if wider than 58"W. External stiffener purchased separately when not used with a Coordinate™ work surface. 				
Coordinate™ Height Adjustable Base – 3-Stage				
3-Leg Rectangle T Foot	HHATB3S3LT	91.0	3.6	\$1925
3-Leg Rectangle C Foot	HHATB3S3LC	91.0	3.6	\$1925
NOTES:				
<ul style="list-style-type: none"> • Tri-motor three-leg design. Legs raise from 21¾" to 47½". • Base accommodates corner cove work surfaces between 24"D x 48"W x 36"W and 30"D x 72"W x 48"W. Can be used with 48" 120° work surface models. • Weight capacity of 375 lbs. (including the weight of the work surface) distributed evenly. 				
<ul style="list-style-type: none"> ⚠ Not compatible with 2-piece top configurations (Max base required). ⚠ Each work surface 58"W or wider requires the use of an external stiffener; including secondary return work surface in an "L" 3-leg base application if wider than 58"W. External stiffener purchased separately when not used with a Coordinate™ work surface. 				
Coordinate™ Height Adjustable Base – Max 3-Stage				
3-Leg Rectangle T Foot	HHATM3S3LT	78.0	2.3	\$2456
NOTES:				
<ul style="list-style-type: none"> • Tri-motor three-leg design. Legs raise from 21¾" to 47½". • Base accommodates work surfaces between 24"D x 48"W x 36"W and 30"D x 72"W x 72"W. Can be used with 48" 120° work surface models. • Weight capacity of 500 lbs. (including the weight of the work surface) distributed evenly. 				
<ul style="list-style-type: none"> ⚠ When using two work surfaces, a flat bracket is required. Bracket purchased separately — HHN831124, HHN831130 — see page 556. ⚠ Each work surface 58"W or wider requires the use of an external stiffener; including secondary return work surface in an "L" 3-leg base application if wider than 58"W. External stiffener purchased separately when not used with a Coordinate™ work surface. ⚠ Certain 2-piece top configurations may require two stiffeners depending on the footprint of your station. 				

NOTES:

- Control Box: 120V, 4A, 60Hz, 400W.
- 9' grounded power cord.
- 1½"/second travel speed.
- <50 dB noise rating.
- 2-Leg Height Adjustable Bases can accommodate rectangular work surfaces down to 24"W. 10500 Series™, Concinnity™, and Voi® all have rectangular work surfaces shorter than 40"W.
- Collision detection featured on base.
- **HON 10-Year Warranty.**

⚠ Requires the use of an external stiffener (purchased separately) for work surfaces over 58"W or wider when not used with a Coordinate™ work surface.

HOW TO SPECIFY

Select Model Number HHATB3S3LT	Select Paint Color See page 114 PR6	Select Foot X Standard Foot	Select Keypad UD Basic Up/Down MEM Memory Preset PDL Paddle MEM
--	--	---------------------------------------	--

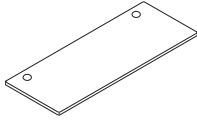

DESCRIPTION	MODEL	SHIP WEIGHT	CUBE	LIST PRICE BY LAMINATE GRADE	
				L1	L2
Rectangle Worksurfaces for Standard C/T Bases, Flat Edge					
40"W x 22"D	HHATW2240CT	40	2.8	\$468	\$484
46"W x 22"D	HHATW2246CT	58	3.1	\$497	\$513
52"W x 22"D	HHATW2252CT	64	3.9	\$527	\$548
58"W x 22"D	HHATW2258CT	70	3.9	\$603	\$624
64"W x 22"D	HHATW2264CT	86	4.3	\$648	\$669
70"W x 22"D	HHATW2270CT	89	4.6	\$667	\$688
76"W x 22"D	HHATW2276CT	91	5.0	\$718	\$745
82"W x 22"D	HHATW2282CT	92	5.4	\$801	\$828
88"W x 22"D	HHATW2288CT	94	5.7	\$848	\$880
94"W x 22"D	HHATW2294CT	95	6.1	\$865	\$897
40"W x 28"D	HHATW2840CT	55	3.4	\$508	\$524
46"W x 28"D	HHATW2846CT	68	3.9	\$537	\$553
52"W x 28"D	HHATW2852CT	80	4.8	\$576	\$597
58"W x 28"D	HHATW2858CT	101	4.8	\$656	\$677
64"W x 28"D	HHATW2864CT	105	5.3	\$699	\$720
70"W x 28"D	HHATW2870CT	105	5.7	\$745	\$766
76"W x 28"D	HHATW2876CT	107	6.1	\$763	\$790
82"W x 28"D	HHATW2882CT	108	6.6	\$840	\$867
88"W x 28"D	HHATW2888CT	110	7.0	\$890	\$922
94"W x 28"D	HHATW2894CT	111	7.5	\$908	\$940

ⓘ Must be used as worksurfaces on Coordinate™ Height Adjustable Bases within Panel Systems. These are shorter in width and depth on each side to provide clearance between panels and other worksurfaces.

42"W x 24"D	HHATW2442CT	52	2.8	\$468	\$484
48"W x 24"D	HHATW2448CT	58	3.1	\$497	\$513
54"W x 24"D	HHATW2454CT	64	3.9	\$527	\$548
60"W x 24"D	HHATW2460CT	70	3.9	\$587	\$608
66"W x 24"D	HHATW2466CT	86	4.3	\$637	\$658
72"W x 24"D	HHATW2472CT	89	4.6	\$654	\$675
78"W x 24"D	HHATW2478CT	96	5.0	\$708	\$735
84"W x 24"D	HHATW2484CT	103	5.4	\$801	\$828
90"W x 24"D	HHATW2490CT	113	5.7	\$848	\$880
96"W x 24"D	HHATW2496CT	121	6.1	\$865	\$897
42"W x 30"D	HHATW3042CT	48	3.4	\$508	\$524
48"W x 30"D	HHATW3048CT	68	3.9	\$537	\$553
54"W x 30"D	HHATW3054CT	80	4.8	\$576	\$597
60"W x 30"D	HHATW3060CT	101	4.8	\$639	\$660
66"W x 30"D	HHATW3066CT	105	5.3	\$690	\$711
72"W x 30"D	HHATW3072CT	105	5.7	\$731	\$752
78"W x 30"D	HHATW3078CT	123	6.1	\$753	\$780
84"W x 30"D	HHATW3084CT	127	6.6	\$840	\$867
90"W x 30"D	HHATW3090CT	145	7.0	\$890	\$922
96"W x 30"D	HHATW3096CT	155	7.5	\$908	\$940

ⓘ For use with Coordinate™ Height Adjustable Bases only in Freestanding Applications where the tables/desks are not attached or adjacent to another work surface or systems panel. If used in other than Freestanding Applications, worksurfaces will not provide proper clearance and may cause injury or work surface damage (not covered by warranty).

HOW TO SPECIFY

<p>Select Model Number</p> <p>HHATW2448CT</p>	<p>Select Laminate</p> <p>See page 114</p> <p>LSA1</p>	<p>Select Edge Color</p> <p>See page 114</p> <p>SA</p>	<p>Select Grommet and Color</p> <p>See page 114</p> <p>X No Grommet G1 1 Grommet, Centered G2 2 Grommets, Offset (not available on C-leg base)</p> <p>G2P</p>	<p>Select Stiffener Paint</p> <p>Specify for worksurfaces 58"W or greater</p> <p>P Black</p> <p>P</p>
--	---	---	--	--

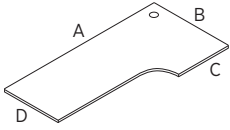

DESCRIPTION

Corner Cove Worksurfaces, Left Hand

58" A x 34" B x 22" C x 22" D
 58" A x 46" B x 22" C x 22" D
 58" A x 46" B x 28" C x 28" D

70" A x 34" B x 22" C x 22" D
 70" A x 46" B x 22" C x 22" D
 70" A x 46" B x 28" C x 28" D

Corner Cove Worksurfaces, Right Hand

58" A x 34" B x 22" C x 22" D
 58" A x 46" B x 22" C x 22" D
 58" A x 46" B x 28" C x 28" D

70" A x 34" B x 22" C x 22" D
 70" A x 46" B x 22" C x 22" D
 70" A x 46" B x 28" C x 28" D

MODEL

HHATCC583422L
 HHATCC584622L
 HHATCC584628L

HHATCC703422L
 HHATCC704622L
 HHATCC704628L

HHATCC583422R
 HHATCC584622R
 HHATCC584628R

HHATCC703422R
 HHATCC704622R
 HHATCC704628R

SHIP WEIGHT

67
85
99

75
105
112

67
85
99

75
105
112

CUBE

6.1
7.4
7.4

6.8
8.8
8.8

6.1
7.4
7.4

6.8
8.8
8.8

L1 LIST PRICE

\$765
\$836
\$897

\$837
\$1039
\$1102

\$765
\$836
\$897

\$837
\$1039
\$1102

L2 LIST PRICE

\$792
\$868
\$929

\$869
\$1076
\$1139

\$792
\$868
\$929

\$869
\$1076
\$1139

NOTES: Use the 3-Leg Coordinate™ Base when specifying Coordinate™ Corner Cove Worksurfaces.

! Must be used as worksurfaces on Coordinate™ Height Adjustable Bases within Panel Systems. These are shorter in width and depth on each side to provide clearance between panels and other worksurfaces.

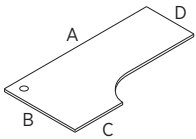

Corner Cove Worksurfaces, Left Hand

60" A x 36" B x 24" C x 24" D
 60" A x 48" B x 24" C x 24" D
 60" A x 48" B x 30" C x 30" D

72" A x 36" B x 24" C x 24" D
 72" A x 48" B x 24" C x 24" D
 72" A x 48" B x 30" C x 30" D

Corner Cove Worksurfaces, Right Hand

60" A x 36" B x 24" C x 24" D
 60" A x 48" B x 24" C x 24" D
 60" A x 48" B x 30" C x 30" D

72" A x 36" B x 24" C x 24" D
 72" A x 48" B x 24" C x 24" D
 72" A x 48" B x 30" C x 30" D

HHATCC603624L
 HHATCC604824L
 HHATCC604830L

HHATCC723624L
 HHATCC724824L
 HHATCC724830L

HHATCC603624R
 HHATCC604824R
 HHATCC604830R

HHATCC723624R
 HHATCC724824R
 HHATCC724830R

67
85
99

75
105
115

67
85
99

75
96
112

6.1
7.4
7.4

6.8
8.8
8.8

6.1
7.4
7.4

6.8
8.8
8.8

\$765
\$836
\$897

\$837
\$1039
\$1102

\$765
\$836
\$897

\$837
\$1039
\$1102

\$792
\$868
\$929

\$869
\$1076
\$1139

\$792
\$868
\$929

\$869
\$1076
\$1139

NOTES: Use the 3-leg Coordinate™ Base when specifying Coordinate™ Corner Cove Worksurfaces.

! For use with Coordinate™ Height Adjustable Bases only in Freestanding Applications where the tables/desks are not attached or adjacent to another work surface or systems panel. If used in other than Freestanding Applications, worksurfaces will not provide proper clearance and may cause injury or work surface damage (not covered by warranty).

HOW TO SPECIFY

<p>Select Model Number</p> <p>HHATCC584622L</p>	<p>Select Laminate</p> <p>See page 114</p> <p>LSA1</p>	<p>Select Edge Color</p> <p>See page 114</p> <p>SA</p>	<p>Select Grommet and Color</p> <p>See page 114</p> <p>X No Grommet G1 1 Grommet, Corner G2 2 Grommets, Offset (not available on C-leg base)</p> <p>G2P</p>	<p>Select Stiffener Paint</p> <p>P Black</p> <p>P</p>
--	---	---	--	--



Icon Legend on page 19

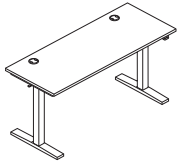

DESCRIPTION

Coordinate™ Easy to Assemble 2-Leg Height Adjustable Base – 2-Stage
24”D Feet

MODEL

HHABETA2S2L

SHIP WEIGHT

77.0 **Ⓞ**

CUBE

4.0

LIST PRICE

\$838

NOTES:

- Legs raise from 26¼” to 43½”, excluding worksurface.
- Supports weight capacity of 180 lbs. and rectangular worksurfaces between 24”D x 48”W and 30”D x 72”W.
- Control Box: 100-240V, 3.6A, 50/60Hz, 400W.
- 9’ grounded power cord.
- 1½”/second travel speed.
- **HON 5-Year Limited Warranty.**

ⓘ Available in SVR Silver finish with Basic Up/Down control only.

SPECIFYING EXAMPLE: HHABETA2S2L.SVR.X.UD

HOW TO SPECIFY

Select Model Number

HHABETA2S2L .

Select Paint Color

See page 114

SVR .

Select Foot

- X** Standard Foot
- S** Slide Glide

X .

Select Keypad

- UD** Basic Up/Down
- MEM** Memory Preset
- PDL** Paddle

UD



DESCRIPTION	MODEL	SHIP WEIGHT	CUBE	LIST PRICE
Height Adjustable Base Wireless Module NOTES: Allows users to control their base by pairing via the AiDesk App (compatible with both iOS and Android phones). No specification needed.	HHABBT	1	0.1	\$149



Caster 4-Pack Field installable. No specification needed. Use on 2-leg bases only.	HHABCSTRPK	1	0.1	\$90
--	-------------------	---	-----	-------------



Slide Glide 4-Pack Field installable. When placed under base, allows table to be pushed/pulled to move. No specification needed. Use on 2-leg bases only.	HHABGLIDE	1	0.1	\$73
---	------------------	---	-----	-------------



G1 Glide 4-Pack Glide enables 3-stage base to reach G1 requirement heights. Glide is always black.	HHABG1GLIDE			\$79
--	--------------------	--	--	-------------

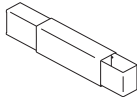
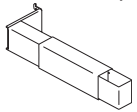
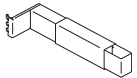

DESCRIPTION	MODEL	SHIP WEIGHT	CUBE	LIST PRICE BY PAINT GRADE		
				P1	P2	P3
Rectangle Leg, T-Foot Brackets HAT to Panel, Left Hand	HHALRETL	4.0	0.2	\$181	\$197	\$206
HAT to Panel, Right Hand	HHALRETR	4.0	0.2	\$181	\$197	\$206
HAT to Gallery Panel	HHALRETG	3.5	0.2	\$181	\$197	\$206

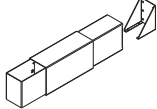
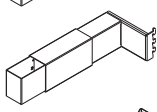
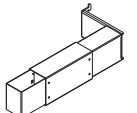

Rectangle Leg, C-Foot Brackets HAT to Panel, Left Hand	HHALRECL	4.0	0.2	\$181	\$197	\$206
HAT to Panel, Right Hand	HHALRECR	4.0	0.2	\$181	\$197	\$206
HAT to Gallery Panel	HHALRECG	3.5	0.2	\$181	\$197	\$206

HOW TO SPECIFY

<p>Select Model Number</p> <p>HHALRECL .</p>	<p>Select Paint Color</p> <p>See page 467</p> <p>PR6</p>
--	--

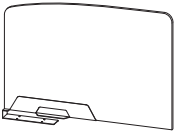
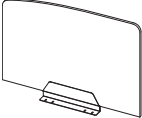
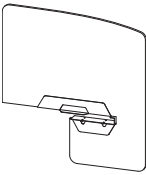
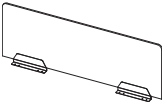

COORDINATE™ Desktop PET Screens

	DESCRIPTION	MODEL	SHIP WEIGHT	CUBE	LIST PRICE
	Coordinate™ Side/Middle Desktop PET Screens				
	23¼"W x 13"H	HUVDSM1324	3.0	1.5	\$239
	29¼"W x 13"H	HUVDSM1330	3.3	1.8	\$282
	23¼"W x 20"H	HUVDSM2024	3.6	2.3	\$282
	29¼"W x 20"H	HUVDSM2030	4.1	2.7	\$331
	Coordinate™ Side/End Desktop PET Screens				
	23¼"W x 13"H	HUVDSSE1324	3.0	1.5	\$267
	29¼"W x 13"H	HUVDSSE1330	3.0	1.8	\$311
	23¼"W x 20"H	HUVDSSE2024	3.5	2.3	\$311
	29¼"W x 20"H	HUVDSSE2030	4.1	2.7	\$352
NOTES: Screen attachment method involves screwing into the underside of the worksurface.					
	Coordinate™ Pacman PET Screens				
	23¼"W x 13"H, for 23"D Surfaces	HUVDPS1324	5.7	1.8	\$318
	29¼"W x 13"H, for 29"D Surfaces	HUVDPS1330	6.2	2.1	\$374
	23¼"W x 20"H, for 23"D Surfaces	HUVDPS2024	6.3	2.7	\$374
	29¼"W x 20"H, for 29"D Surfaces	HUVDPS2030	7.0	3.2	\$439
NOTES: Screen extends 6" from front of surface and 9" below surface.					
	Coordinate™ Above Desktop PET Screens				
	46"W x 13"H	HUVDSAO1348	5.0	2.7	\$448
	58"W x 13"H	HUVDSAO1360	5.6	3.3	\$496
	70"W x 13"H	HUVDSAO1372	6.2	4.0	\$551
	46"W x 20"H	HUVDSAO2048	6.2	4.1	\$559
	58"W x 20"H	HUVDSAO2060	7.1	5.0	\$620
	70"W x 20"H	HUVDSAO2072	8.0	5.9	\$688
NOTES: Screen attachment method involves screwing into the underside of the worksurface. Brackets can be positioned as needed to clear worksurface supports.					

NOTES:

- PET material is 12mm thick.
- Brackets painted in PR6 Silver.
- Brackets and screens ship in same box.
- PET material is tackable.

HOW TO SPECIFY

<p>Select Model Number</p> <p>H U V D S S M 1 3 3 0 .</p>	<p>Select PET Desktop</p> <p>See page 114</p> <p>D G Y 3 .</p>	<p>Select Paint Color</p> <p>PR6 Silver</p> <p>P R 6</p>
---	--	--

COORDINATE™ Desktop PET Screens

OPEN MARKET

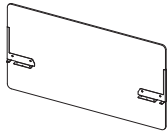
**DESCRIPTION****Coordinate™ Above/Below PET Screens**

46"W x 32"H, 13"H Above
58"W x 32"H, 13"H Above
70"W x 32"H, 13"H Above

46"W x 32"H, 20"H Above
58"W x 32"H, 20"H Above
70"W x 32"H, 20"H Above

NOTES: Screen attachment method involves screwing into the underside of the worksurface.

MODEL**SHIP WEIGHT****CUBE****LIST PRICE**

HUVDSHAB4813 9.7 6.3 **\$853**
HUVDSHAB6013 11.0 7.7 **\$948**
HUVDSHAB7213 12.8 9.1 **\$1053**

HUVDSHAB4820 9.7 6.3 **\$853**
HUVDSHAB6020 11.0 7.7 **\$948**
HUVDSHAB7220 12.8 9.1 **\$1053**

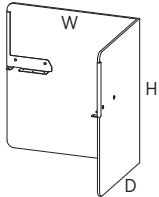
**Coordinate™ Above/Below "L" PET Screens**

23¼"D x 23"W x 32"H, 13"H Above, Right Hand
23¼"D x 29"W x 32"H, 13"H Above, Right Hand
23¼"D x 35"W x 32"H, 13"H Above, Right Hand

29¼"D x 23"W x 32"H, 20"H Above, Right Hand
29¼"D x 29"W x 32"H, 20"H Above, Right Hand
29¼"D x 35"W x 32"H, 20"H Above, Right Hand

23¼"D x 23"W x 32"H, 13"H Above, Left Hand
23¼"D x 29"W x 32"H, 13"H Above, Left Hand
23¼"D x 35"W x 32"H, 13"H Above, Left Hand

29¼"D x 23"W x 32"H, 20"H Above, Left Hand
29¼"D x 29"W x 32"H, 20"H Above, Left Hand
29¼"D x 35"W x 32"H, 20"H Above, Left Hand

NOTES: Screen attachment method includes screwing into the underside of the worksurface.

HUVABLS2424R 9.2 6.3 **\$981**
HUVABLS3024R 9.9 7.0 **\$1035**
HUVABLS3624R 9.9 7.7 **\$1089**

HUVABLS2430R 10.6 6.3 **\$1190**
HUVABLS3030R 10.6 7.0 **\$1252**
HUVABLS3630R 10.6 7.7 **\$1367**

HUVABLS2424L 9.2 6.3 **\$981**
HUVABLS3024L 9.9 7.0 **\$1035**
HUVABLS3624L 9.9 7.7 **\$1089**

HUVABLS2430L 10.6 6.3 **\$1190**
HUVABLS3030L 10.6 7.0 **\$1252**
HUVABLS3630L 10.6 7.7 **\$1367**

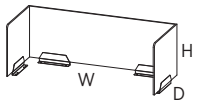
**Coordinate™ Above "U" PET Screens**

23¼"D x 46"W x 13"H
23¼"D x 58"W x 13"H
23¼"D x 70"W x 13"H

23¼"D x 46"W x 20"H
23¼"D x 58"W x 20"H
23¼"D x 70"W x 20"H

29¼"D x 46"W x 13"H
29¼"D x 58"W x 13"H
29¼"D x 70"W x 13"H

29¼"D x 46"W x 20"H
29¼"D x 58"W x 20"H
29¼"D x 70"W x 20"H

NOTES: Screen attachment method involves screwing into the underside of the worksurface.

Screens are for use with Coordinate™ and Empower® Height Adjustable.

HUVAUS482413 12.0 4.0 **\$1101**
HUVAUS602413 12.6 4.6 **\$1157**
HUVAUS722413 13.2 5.2 **\$1220**

HUVAUS482420 14.5 5.9 **\$1376**
HUVAUS602420 15.4 6.8 **\$1447**
HUVAUS722420 16.3 7.7 **\$1526**

HUVAUS483013 12.6 4.0 **\$1205**
HUVAUS603013 13.2 4.6 **\$1262**
HUVAUS723013 13.7 5.2 **\$1325**

HUVAUS483020 15.4 5.9 **\$1504**
HUVAUS603020 16.3 6.8 **\$1575**
HUVAUS723020 17.1 7.7 **\$1655**

NOTES:

- PET material is 12mm thick.
- Brackets painted in PR6 Silver.
- Brackets and screens ship in same box except for Gravitation™ Beam PET Screens.
- PET material is tackable.

HOW TO SPECIFY

Select
Model Number

H U V D S H A B 6 0 1 3 .

Select
PET Desktop

See page 114

D G Y 3 .

Select
Paint Color

PR6 Silver

P R 6



Coze™ Table Desk shown with Cliq™ Seating and Fuse™ Storage.

COZE™

There's no place like home, especially when you're working. Stay as productive in your own digs as you are in the office with Coze table desks. Designed to keep things nice and easy, Coze features simple and quick assembly and optional fast shipping so you can get down to business in no time. Not too big and not too small, Coze comes in three sizes, so it's just right for whatever space you're working in. With optional built-in storage to help you stay organized and a clean, light-scale look in a variety of laminate and finish colors, Coze feels right at home no matter your personal style.



FEATURES

- Enjoy a higher quality desk at a lower price.
- Simple one-tool installation with video takes only minutes.
- Light scale design and small footprint fit any room in the house.
- Optional integrated storage lets you decide how to best stay organized.
- Available in a variety of laminate and paint colors so you can get exactly what you need in the look you want.
- Leveling glides adjust for uneven floors.
- Durable laminate surfaces resist scratches, spills, and stains.

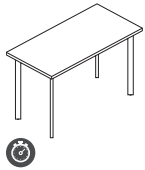
**DESCRIPTION****Table Desk with Post Legs**

54"W x 24"D
48"W x 24"D
42"W x 24"D

54"W x 30"D
48"W x 30"D

NOTES: Product ships with desk top and 4 legs in 2 cartons.

MODEL

HLCRPL5424WFH
HLCRPL4824WFH
HLCRPL4224WFH

SHIP WEIGHT

71
66
61

CUBE

5.7
5.4
5.2

LIST PRICE

\$684
\$653
\$620

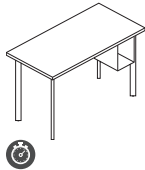
**Table Desk with Post Legs and U-Storage**

54"W x 24"D
48"W x 24"D
42"W x 24"D

54"W x 30"D
48"W x 30"D

NOTES: Product ships with desk top, 4 legs, and U-storage in 2 cartons.

HLCRPL5424WFH-US
HLCRPL4824WFH-US
HLCRPL4224WFH-US

78
73
68

5.7
5.4
5.2

\$756
\$725
\$692

HLCRPL5430WFH-US
HLCRPL4830WFH-US

88
83

6.3
5.9

\$852
\$826

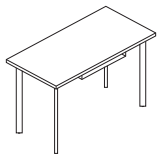
**Table Desk with Post Legs and Pencil Storage**

54"W x 24"D
48"W x 24"D
42"W x 24"D

54"W x 30"D
48"W x 30"D

NOTES: Product ships with desk top, 4 legs, and pencil storage in 2 cartons.

HLCRPL5424WFH-PS
HLCRPL4824WFH-PS
HLCRPL4224WFH-PS

77
72
67

5.7
5.4
5.2

\$756
\$725
\$692

HLCRPL5430WFH-PS
HLCRPL4830WFH-PS

87
82

6.3
5.9

\$852
\$826

NOTES:

- HON 5-Year Limited Warranty.

HOW TO SPECIFY**Select Model Number**

H L C R P L 4 8 2 4 W F H - U S .

Select Laminate and Edge

PP Black
LDW1DW Designer White
LFW1FW Florence Walnut
LNR1NR Natural Recon

L F W 1 F W .

Select Paint Color

P71 Black
PJW Designer White
PR6 Silver

P R 6

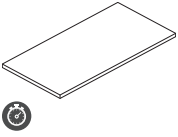
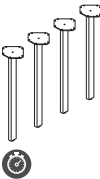
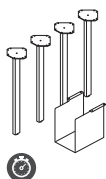
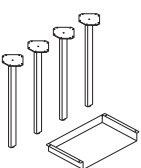
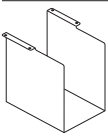
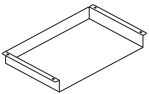

	DESCRIPTION	MODEL	SHIP WEIGHT	CUBE	LIST PRICE
	Coze™ Rectangle Worksurface				
	42"W x 24"D	HLCR2442WFH	35	2.1	\$323
	48"W x 24"D	HLCR2448WFH	40	2.4	\$356
	54"W x 24"D	HLCR2454WFH	45	2.7	\$387
	48"W x 30"D	HLCR3048WFH	50	2.9	\$457
	54"W x 30"D	HLCR3054WFH	55	3.3	\$483
NOTES: Base telescopes to accommodate worksurfaces between 24"D x 48"W and 30"D x 60"W. Worksurfaces include pre-drilled pilot holes. Worksurfaces come with threaded inserts for ease of installation with Post Legs models HLCPL29WFH, HLCPL29WFH-US, and HLCPL29WFH-PS.					
	Post Legs, Pack of 4	HLCPL29WFH	26	3.0	\$297
	NOTES: Metal storage ships same color as legs.				
	Post Legs, Pack of 4 with U-Storage	HLCPL29WFH-US	33	3.0	\$369
	NOTES: Metal storage ships same color as legs.				
	Post Legs, Pack of 4 with Pencil Storage	HLCPL29WFH-PS	32	3.0	\$369
	NOTES: Metal storage ships same color as legs.				
ⓘ Hardware included is specific to the attachment of the following models: HLCR2442WFH, HLCR2448WFH, HLCR2454WFH.					
	U-Storage	HLCWFH-US	9	1.2	\$182
	NOTES: Metal storage ships same color as legs.				
	Pencil Storage	HLCWFH-PS	8	1.2	\$182
	ⓘ Hardware included is specific to the attachment of the following models: HLCR2442WFH, HLCR2448WFH, HLCR2454WFH.				

NOTES:
• HON 5-Year Limited Warranty.

HOW TO SPECIFY

<p>Select Model Number</p> <p>H L C R 2 4 4 8 W F H .</p>	<p>Select Laminate and Edge</p> <p>PP Black LDW1DW Designer White LFW1FW Florence Walnut LNR1NR Natural Recon</p> <p>L F W 1 F W</p>
<p>Select Model Number</p> <p>H L C P L 2 9 W F H - P S .</p>	<p>Select Paint Color</p> <p>P71 Black PJW Designer White PR6 Silver</p> <p>P R 6</p>

MOD

Want to see more? Scan here
to check out hon.com.



Mod Desks shown with Coordinate™
Height Adjustable Desks and Solve® Seating.

MOD

There is always beauty in simplicity, but with the Mod desk collection you'll also find variety and value. The contemporary design feels perfectly at home in either a private office or an open floor plan, giving it the versatility that allows you to unify your space. Choose from a selection of finishes that express your modern sense of style, or dress it up with a classic look. Whether setting up a single desk, shared workstations, or full private office suite with storage, this collection is totally adaptable. Totally productive. Totally Mod.



FEATURES

- The Mod collection allows you to create a premium workspace at an affordable price.
- Straightforward styling blends with any office design with the option for metal A- and U-legs.
- Available in 5 laminate finishes.
- Storage options that let you create spaces that work the way you do.
- All components feature a scratch- and stain-resistant laminate for unbeatable beauty and durability.

MOD ORDERING INFORMATION

LAMINATES

L1 LAMINATES CODES

Woodgrain

- ◆ Java Oak LJA1
- ◆ Sepia Walnut LSE1
- ◆ Slate Teak LSL1
- ◆ Traditional Mahogany LTM1

Solid

- ◆ Simply White LPW1

METAL A-LEGS, U-LEGS, AND SUPPORT LEGS

PAINTS CODES

- ◆ Black BLKP
- ◆ Silver SLVR

FABRIC CUSHIONS & TACKBOARDS

FABRIC CODES

- ◆ Cool Neutral CN02
- ◆ Warm Neutral WM01

◆◆◆ For lead time information see page 21.

MOD Statement of Line

DESKS

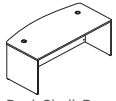

Desk Shell, Bow and Rectangle Top

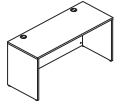

Rectangle Credenza Shell

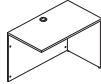

Return Shell



Bridge Shell



Corner Shell



Peninsula with End Panel



Reception Desk Shell



Reception Return Shell

STORAGE



Mobile Pedestal



Hanging Pedestal



Lateral



Wardrobe

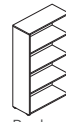

Bookcase

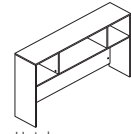

Hutch

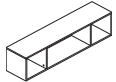

Wall Mounted Storage

WORKSURFACES/SUPPORTS



Rectangular Worksurface



A-Leg Support



U-Leg Support



Credenza Leg Support



Support Pedestal, Box/Box/File and File/File



Support Cabinet



Low Credenza, 2 Drawers



Low Credenza, Open

TABLES



Round Conference Table Top



Rectangle Conference Table Top



Round Conference Table Base



Rectangle Conference Table Base

ACCESSORIES



Laminate Doors for Hutch and Wall Mounted Storage



Glass Doors for Hutch and Wall Mounted Storage



Tackboards



Markerboard



Pedestal Cushion



External Stiffener

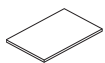

Low Credenza Cabinet Top



Low Credenza Cushion



Transaction Top

MOD LAMINATE GRAIN DIRECTION

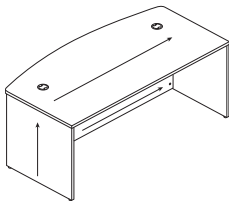

Bow Top Desk Shell

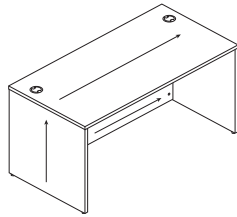

Rectangle Desk Shell

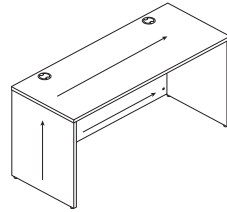

Rectangle Credenza Shell

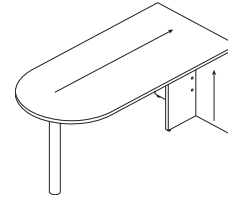

Peninsula

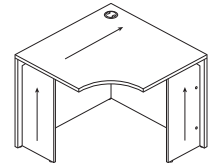

Corner Shell

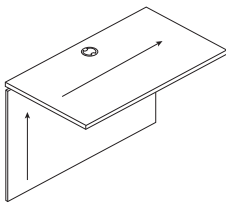

Bridge

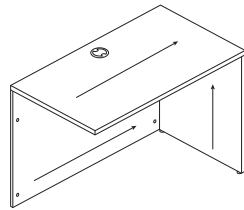

Return

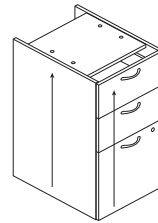

Pedestals

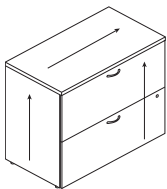
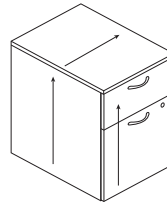

Laterals

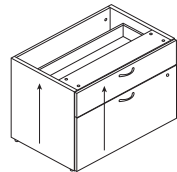

Low Credenzas

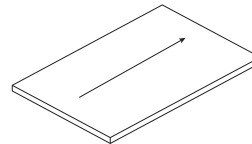
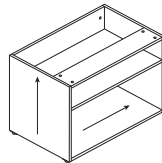

Low Credenza Top



Wardrobe

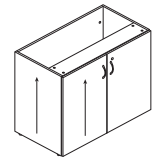

Storage Cabinet

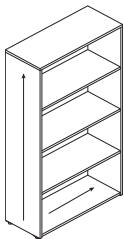

Bookcase

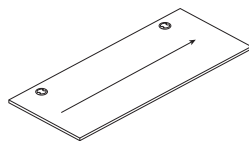

Rectangle Worksurface

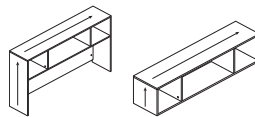

Overhead Hutch, Storage, and Laminate Doors

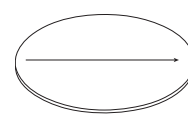

Conference Table Tops and Bases

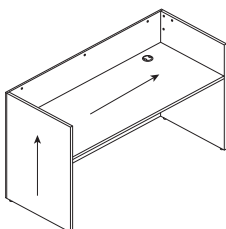
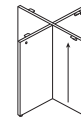

Reception Desk and Transaction Top

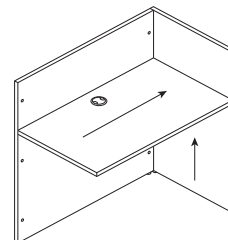
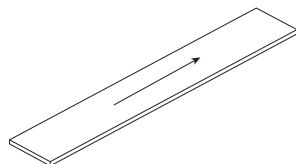

Reception Return Shell

MOD Typicals

Components used are listed on pages 136-144. Order components individually. Other configurations are possible, including various sizes of some components.

QTY	DESCRIPTION	MODEL	LIST PRICE	PRICE EXTENSION
1	Desk Shell 66"W x 30"D	HLPLDS6630	\$362	\$362
1	Credenza Shell 66"W x 24"D	HLPLCS6624	\$337	\$337
1	Bridge 42"W x 24"D	HLPLB4224	\$208	\$208
1	Pedestal - B/B/F 15"W x 20"D x 28"H	HLPLPSBBF	\$418	\$418
1	Pedestal - F/F 15"W x 20"D x 28"H	HLPLPSFF	\$418	\$418
1	Hutch without Doors 66"W x 14"D x 39 ³ / ₄ "H	HLPLDH66	\$406	\$406
2	Laminate Hutch Doors Pack of 2 Doors	HLPLDR66LM	\$51	\$102
TOTAL:			\$2,251	

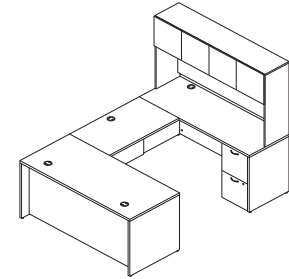

U-STATION (NON-HANDED)

66"W x 96"D

QTY	DESCRIPTION	MODEL	LIST PRICE	PRICE EXTENSION
1	Peninsula 66"W x 30"D	HLPLPEN6630E	\$385	\$385
1	Credenza Shell 66"W x 24"D	HLPLCS6624	\$337	\$337
1	Bridge 42"W x 24"D	HLPLB4224	\$208	\$208
1	Pedestal - B/B/F 15"W x 20"D x 28"H	HLPLPSBBF	\$418	\$418
1	Hutch without Doors 66"W x 14"D x 39 ³ / ₄ "H	HLPLDH66	\$406	\$406
1	Laminate Hutch Doors Pack of 2 Doors	HLPLDR66LM	\$51	\$51
TOTAL:			\$1,805	

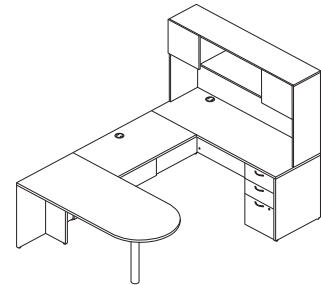

**U-STATION WITH PENINSULA
(NON-HANDED)**

66"W x 96"D

QTY	DESCRIPTION	MODEL	LIST PRICE	PRICE EXTENSION
1	Desk Shell 66"W x 30"D	HLPLDS6630	\$362	\$362
1	Return Shell 42"W x 24"D	HLPLRS4224	\$247	\$247
1	Pedestal - B/B/F 15"W x 20"D x 28"H	HLPLPSBBF	\$418	\$418
1	Pedestal - F/F 15"W x 20"D x 28"H	HLPLPSFF	\$418	\$418
1	Hutch without Doors 66"W x 14"D x 39 ³ / ₄ "H	HLPLDH66	\$406	\$406
2	Glass Hutch Doors Pack of 2 Doors	HLPLDR66GS	\$177	\$354
TOTAL:			\$2,205	

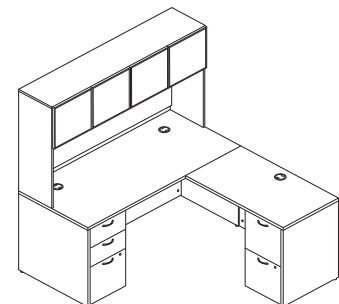

L-STATION (NON-HANDED)

66"W x 72"D

Components used are listed on pages 136-144. Order components individually. Other configurations are possible, including various sizes of some components.

QTY	DESCRIPTION	MODEL	LIST PRICE	PRICE EXTENSION
1	Bow Front Desk Shell 72"W x 36"D	HLPLDS7236B	\$457	\$457
1	Credenza Shell 72"W x 24"D	HLPLCS7224	\$349	\$349
1	Pedestal - B/B/F 15"W x 20"D x 28"H	HLPLPSBBF	\$418	\$418
1	Pedestal - F/F 15"W x 20"D x 28"H	HLPLPSFF	\$418	\$418
1	Hutch without Doors 72"W x 14"D x 39 ³ / ₄ "H	HLPLDH72	\$426	\$426
2	Laminate Hutch Doors Pack of 2 Doors	HLPLDR72LM	\$51	\$102
TOTAL:			\$2,170	

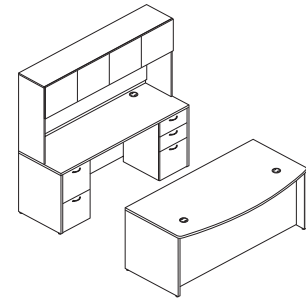

OFFICE SUITE
72"W x 96"D

QTY	DESCRIPTION	MODEL	LIST PRICE	PRICE EXTENSION
1	Reception Desk Shell 72"W x 30"D	HLPLRCPNDS7230	\$525	\$525
1	Reception Return Shell 42"W x 25"D	HLPLRCPNRS4225	\$318	\$318
1	Reception Laminate Transaction Top 72"W x 12"D	HLPLRCPNTPLM	\$114	\$114
1	Pedestal - B/B/F 15"W x 20"D x 28"H	HLPLPSBBF	\$418	\$418
TOTAL:			\$1,375	

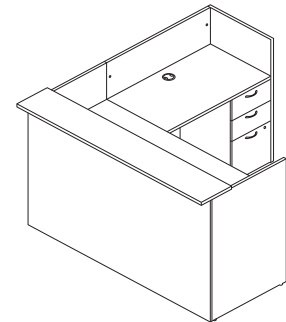

**RECEPTION STATION
(NON-HANDED)**
72"W x 72"D

QTY	DESCRIPTION	MODEL	LIST PRICE	PRICE EXTENSION
1	Rectangle Conference Table Top 48"W x 120"L, 2-Piece	HLPLTBL4812ORCT	\$849	\$849
1	Conference Table Base For 120" Table Tops	HLPLTBL120BASE	\$139	\$139
2	Wardrobe 24"W x 24"D x 65"H	HLPLW2424	\$1,066	\$2,132
2	Low Open Storage Credenza 36"W x 20"D x 21"H	HLPLCL3620S	\$326	\$652
1	Low Credenza Top 72"W x 20"D	HLPLCL7220TOP	\$166	\$166
TOTAL:			\$3,938	

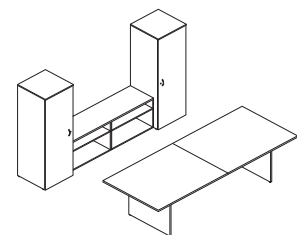

CONFERENCE ROOM
144"W x 180"D

MOD Typicals

Components used are listed on pages 136-144. Order components individually. Other configurations are possible, including various sizes of some components.

QTY	DESCRIPTION	MODEL	LIST PRICE	PRICE EXTENSION
1	Rectangle Worksurface 66"W x 30"D	HLPLRW6630	\$233	\$233
1	Rectangle Worksurface 48"W x 24"D	HLPLRW4824	\$178	\$178
1	Flat Bracket 24"D	HLPLFB24	\$63	\$63
2	U-Leg Support 30"W	HLPLLEG30U	\$195	\$390
1	U-Leg Support 24"W	HLPLLEG24U	\$184	\$184
1	External Stiffener For 66"W Worksurfaces	HLPLXS66	\$96	\$96
1	Mobile Pedestal - B/F 15"W x 20"D x 20"H	HLPLPMBF	\$364	\$364
1	Pedestal Cushion 15"W x 20"D	HLPLPSEAT1520	\$114	\$114
TOTAL:				\$1,622

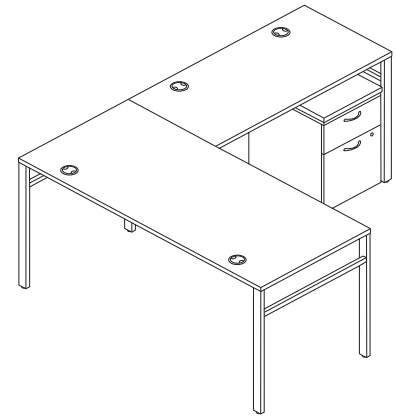

L-STATION (NON-HANDED)
66"W x 78"D

QTY	DESCRIPTION	MODEL	LIST PRICE	PRICE EXTENSION
1	Rectangle Worksurface 66"W x 30"D	HLPLRW6630	\$233	\$233
1	U-Leg Support 30"W	HLPLLEG30U	\$195	\$195
1	External Stiffener For 66"W Worksurfaces	HLPLXS66	\$96	\$96
1	Credenza Leg Support 7"H x 30"D	HLPLSL30	\$128	\$128
1	Low 2-Drawer Credenza 30"W x 20"D x 21"H	HLPLCL3020BF	\$678	\$678
1	Low Open Storage Credenza 30"W x 20"D x 21"H	HLPLCL3020S	\$314	\$314
1	Low Credenza Top 60"W x 20"D	HLPLCL6020TOP	\$154	\$154
TOTAL:				\$1,798

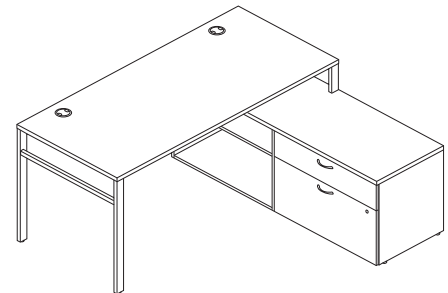

**L-STATION WITH CREDEZA
(NON-HANDED)**
66"W x 60"D

MOD Bundles Typicals

Traditional Mahogany
HLPLDS72PSTM1

Slate Teak
HLPLDS72PSSL1

Sepia Walnut
HLPLDS72PSSE1

Java Oak
HLPLDS72PSJA1

QTY	DESCRIPTION	MODEL	LIST PRICE	PRICE EXTENSION
1	Rectangular Desk Shell	HLPLDS7230	\$383	\$383
1	B/B/F Support Pedestal	HLPLPSBBF	\$418	\$418
1	F/F Support Pedestal	HLPLPSFF	\$418	\$418
TOTAL:			\$1,219	

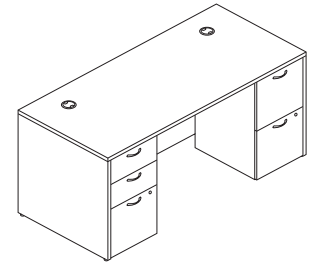

LAMINATE DESK WITH 2 PEDESTALS
72"W

Traditional Mahogany
HLPLDS66PSTM1

Slate Teak
HLPLDS66PSSL1

Sepia Walnut
HLPLDS66PSSE1

Java Oak
HLPLDS66PSJA1

QTY	DESCRIPTION	MODEL	LIST PRICE	PRICE EXTENSION
1	Rectangular Desk Shell	HLPLDS6630	\$362	\$362
1	B/B/F Support Pedestal	HLPLPSBBF	\$418	\$418
1	F/F Support Pedestal	HLPLPSFF	\$418	\$418
TOTAL:			\$1,198	

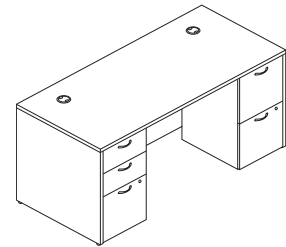

LAMINATE DESK WITH 2 PEDESTALS
66"W

Traditional Mahogany
HLPLDS60PSTM1

Slate Teak
HLPLDS60PSSL1

Sepia Walnut
HLPLDS60PSSE1

Java Oak
HLPLDS60PSJA1

QTY	DESCRIPTION	MODEL	LIST PRICE	PRICE EXTENSION
1	Rectangular Desk Shell	HLPLDS6030	\$331	\$331
1	B/B/F Support Pedestal	HLPLPSBBF	\$418	\$418
TOTAL:			\$749	

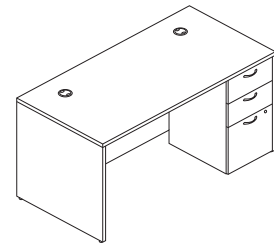

LAMINATE DESK WITH 1 PEDESTAL
60"W

Traditional Mahogany
HLPLDS48HBFTM1

Slate Teak
HLPLDS48HBFSL1

Sepia Walnut
HLPLDS48HBFSE1

Java Oak
HLPLDS48HBFJA1

QTY	DESCRIPTION	MODEL	LIST PRICE	PRICE EXTENSION
1	Rectangular Desk Shell	HLPLDS4830	\$318	\$318
1	B/F Hanging Pedestal	HLPLPHBF	\$306	\$306
TOTAL:			\$624	

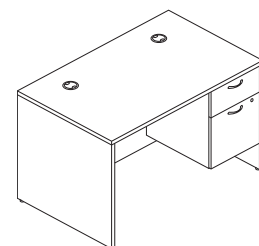

SMALL OFFICE DESK WITH 3/4 PEDESTAL
48"W

MOD Bundles Typicals

Black/Traditional Mahogany
HLPLW60LEG30UBLKPTM1

Black/Java Oak
HLPLW60LEG30UBLKPJA1

Black/Sepia Walnut
HLPLW60LEG30UBLKPSE1

Black/Slate Teak
HLPLW60LEG30UBLKPSL1

Black/Simply White
HLPLW60LEG30UBLKPPW1

Silver/Traditional Mahogany
HLPLW60LEG30USLVRTM1

Silver/Java Oak
HLPLW60LEG30USLVRJA1

Silver/Sepia Walnut
HLPLW60LEG30USLVRSE1

Silver/Slate Teak
HLPLW60LEG30USLVRSL1

Silver/Simply White
HLPLW60LEG30USLVRPW1

QTY	DESCRIPTION	MODEL	LIST PRICE	PRICE EXTENSION
1	Rectangular Worksurface	HLPLRW6030	\$220	\$220
1	External Stiffener	HLPLXS60	\$89	\$89
2	U-Leg Support 30"W	HLPLLEG30U	\$195	\$390
TOTAL:				\$699

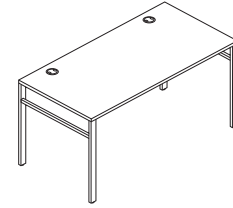

**TABLE DESK WITH U-LEG
60"W x 30"D**

Black/Traditional Mahogany
HLPLW66LEG30UBLKPTM1

Black/Java Oak
HLPLW66LEG30UBLKPJA1

Black/Sepia Walnut
HLPLW66LEG30UBLKPSE1

Black/Slate Teak
HLPLW66LEG30UBLKPSL1

Black/Simply White
HLPLW66LEG30UBLKPPW1

Silver/Traditional Mahogany
HLPLW66LEG30USLVRTM1

Silver/Java Oak
HLPLW66LEG30USLVRJA1

Silver/Sepia Walnut
HLPLW66LEG30USLVRSE1

Silver/Slate Teak
HLPLW66LEG30USLVRSL1

Silver/Simply White
HLPLW66LEG30USLVRPW1

QTY	DESCRIPTION	MODEL	LIST PRICE	PRICE EXTENSION
1	Rectangular Worksurface	HLPLRW6630	\$233	\$233
1	External Stiffener	HLPLXS66	\$96	\$96
2	U-Leg Support 30"W	HLPLLEG30U	\$195	\$390
TOTAL:				\$719

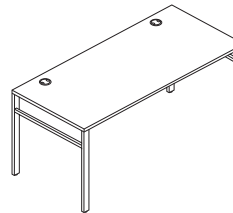

**TABLE DESK WITH U-LEG
66"W x 30"D**

MOD Bundles Typical

Nickel/Traditional Mahogany
HLPLRW6024CONHATTM1

Nickel/Slate Teak
HLPLRW6024CONHATSL1

Nickel/Java Oak
HLPLRW6024CONHATJA1

Nickel/Simply White
HLPLRW6024CONHATPW1

Nickel/Sepia Walnut
HLPLRW6024CONHATSE1

QTY	DESCRIPTION	MODEL	LIST PRICE	PRICE EXTENSION
1	Coordinate™ Height Adjustable Base — 2-Stage	HHATB2S2LT	\$1,058	\$1,058
1	Rectangular Worksurface	HLPLRW6024	\$182	\$182
TOTAL:			\$1,240	

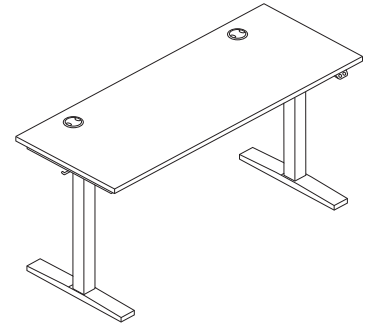

HEIGHT ADJUSTABLE TABLE
60"W x 24"D

Nickel/Traditional Mahogany
HLPLRW6030CONHATTM1

Nickel/Slate Teak
HLPLRW6030CONHATSL1

Nickel/Java Oak
HLPLRW6030CONHATJA1

Nickel/Simply White
HLPLRW6030CONHATPW1

Nickel/Sepia Walnut
HLPLRW6030CONHATSE1

QTY	DESCRIPTION	MODEL	LIST PRICE	PRICE EXTENSION
1	Coordinate™ Height Adjustable Base — 2-Stage	HHATB2S2LT	\$1,058	\$1,058
1	Rectangular Worksurface	HLPLRW6030	\$220	\$220
TOTAL:			\$1,278	

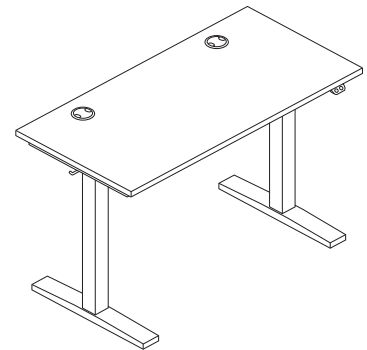

HEIGHT ADJUSTABLE TABLE
60"W x 30"D

Nickel/Traditional Mahogany
HLPLRW4824CONHATTM1

Nickel/Slate Teak
HLPLRW4824CONHATSL1

Nickel/Java Oak
HLPLRW4824CONHATJA1

Nickel/Simply White
HLPLRW4824CONHATPW1

Nickel/Sepia Walnut
HLPLRW4824CONHATSE1

QTY	DESCRIPTION	MODEL	LIST PRICE	PRICE EXTENSION
1	Coordinate™ Height Adjustable Base — 2-Stage	HHATB2S2LT	\$1,058	\$1,058
1	Rectangular Worksurface	HLPLRW4824	\$178	\$178
TOTAL:			\$1,236	

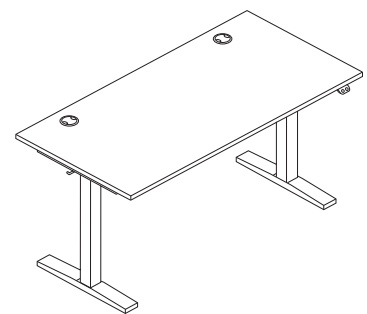

HEIGHT ADJUSTABLE TABLE
48"W x 24"D

MOD

Laminate Modular Components

OPEN MARKET

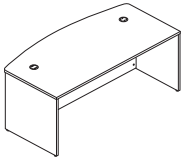
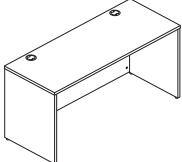
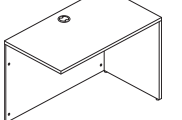
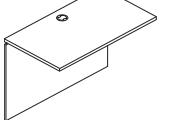

Icon Legend on page 19

	DESCRIPTION	MODEL	SHIP WEIGHT	CUBE	LIST PRICE
 <p>HLPLDS7236B shown</p>	Desk Shell				
	72"W x 36"/30"D x 29"H, Bow Top	HLPLDS7236B	149	6.6	\$457
	72"W x 36"D x 29"H, Rectangle Top	HLPLDS7236	149	6.6	\$389
	72"W x 30"D x 29"H, Rectangle Top	HLPLDS7230	149	5.6	\$383
	66"W x 30"D x 29"H, Rectangle Top	HLPLDS6630	116	5.1	\$362
	60"W x 30"D x 29"H, Rectangle Top	HLPLDS6030	111	4.7	\$331
48"W x 30"D x 29"H, Rectangle Top	HLPLDS4830	75	4.7	\$318	
	Credenza Shell				
	72"W x 24"D x 29"H	HLPLCS7224	108	5.3	\$349
	66"W x 24"D x 29"H	HLPLCS6624	96	4.8	\$337
	60"W x 24"D x 29"H	HLPLCS6024	96	4.4	\$312
48"W x 24"D x 29"H	HLPLCS4824	75	3.7	\$306	
	Return Shell				
	48"W x 24"D x 29"H	HLPLRS4824	66	4.2	\$259
	42"W x 24"D x 29"H	HLPLRS4224	60	4.2	\$247
36"W x 24"D x 29"H	HLPLRS3624	54	2.8	\$205	
	Bridge				
	48"W x 24"D x 29"H	HLPLB4824	53	4.2	\$210
	42"W x 24"D x 29"H	HLPLB4224	46	4.2	\$208
36"W x 24"D x 29"H	HLPLB3624	40	3.7	\$174	

NOTES:

- Scratch- and stain-resistant thermal-fused laminate surfaces.
- Durable 1" thick tops and end panels.
- Full height modesty panels.
- Desk, Credenza, Return Shells, and Bridge assemble quickly and easily.
- Desks, Credenzas, Return Shells, and Bridges come standard with 3" round Black grommets.
- Adjustable floor leveling glides provide 3/4" of adjustment.
- **HON 5-Year Limited Warranty.**

HOW TO SPECIFY

Select Model Number	Select Laminate See page 127
<div style="display: flex; gap: 5px;"> <div style="border: 1px solid black; padding: 2px;">H</div> <div style="border: 1px solid black; padding: 2px;">L</div> <div style="border: 1px solid black; padding: 2px;">P</div> <div style="border: 1px solid black; padding: 2px;">L</div> <div style="border: 1px solid black; padding: 2px;">D</div> <div style="border: 1px solid black; padding: 2px;">S</div> <div style="border: 1px solid black; padding: 2px;">6</div> <div style="border: 1px solid black; padding: 2px;">0</div> <div style="border: 1px solid black; padding: 2px;">3</div> <div style="border: 1px solid black; padding: 2px;">0</div> </div>	<div style="display: flex; gap: 5px;"> <div style="border: 1px solid black; padding: 2px;">L</div> <div style="border: 1px solid black; padding: 2px;">S</div> <div style="border: 1px solid black; padding: 2px;">L</div> <div style="border: 1px solid black; padding: 2px;">1</div> </div>

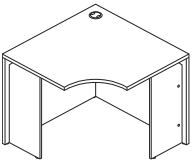

MOD Laminate Modular Components

	DESCRIPTION	MODEL	SHIP WEIGHT	CUBE	LIST PRICE
	Corner Shell 36"W x 36"D x 29"H 30"W x 30"D x 29"H	HLPLCS36 HLPLCS30	114 93	5.3 3.2	\$330 \$296
	Peninsula w/End Panel 72"W x 36"D x 29½"H 66"W x 30"D x 29½"H	HLPLPEN7236E HLPLPEN6630E	124 117	7.1 6.6	\$432 \$385

⚠ Peninsula must be ganged to another unit, return, or bridge.
 ⚠ Support column available in Black (P) paint only. Matches BLKP paint option.
 Specify: Model.Woodgrain Laminate.Paint
SPECIFYING EXAMPLE: HLPLPEN6630E.LSL1.P

NOTES:

- Scratch- and stain-resistant thermal-fused laminate surfaces.
- Durable 1" thick tops and end panels.
- Full height modesty panels.
- Corner Shells and Peninsula assemble quickly and easily.
- Corner Shells come standard with 3" round Black grommets.
- Adjustable floor leveling glides provide ¾" of adjustment.
- **HON 5-Year Limited Warranty.**

HOW TO SPECIFY

<p>Select Model Number</p> <p>HLPLPEN7236E .</p>	<p>Select Laminate</p> <p>See page 127</p> <p>LSL1 .</p>	<p>Select Paint Color</p> <p>P Black</p> <p>P</p>
---	---	--

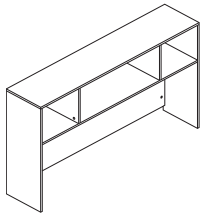
**DESCRIPTION****Hutch without Doors**

72"W x 14½"D x 39¾"H

66"W x 14½"D x 39¾"H

60"W x 14½"D x 39¾"H

NOTES: Full back with gap at bottom for wire management.

Specify: Model.Woodgrain Laminate

! Hutch and Wall Mounted Storage units are sold without doors. 2 Doors or 4 Doors can be added to 72"W, 66"W, and 60"W units. 48"W

Wall Mounted Storage Doors are sold in packages of 3 only.

SPECIFYING EXAMPLE: HPLPDH66.LSL1**MODEL****SHIP WEIGHT****CUBE****LIST PRICE****HPLPDH72**

106

7.1

\$426**HPLPDH66**

99

7.2

\$406**HPLPDH60**

92

5.3

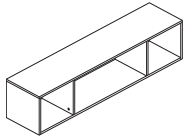
\$395**Wall Mounted Storage without Doors**

72"W x 14½"D x 13½"H

66"W x 14½"D x 13½"H

60"W x 14½"D x 13½"H

48"W x 14½"D x 13½"H

! Hutch and Wall Mounted Storage units are sold without doors. 2 Doors or 4 Doors can be added to 72"W, 66"W, and 60"W units. 48"W

Wall Mounted Storage Doors are sold in packages of 3 only.

HLPLWMH72

66

3.1

\$506**HLPLWMH66**

62

3.6

\$484**HLPLWMH60**

57

3.0

\$474**HLPLWMH48**

48

2.5

\$454**Laminate Doors for Hutch and Wall Mounted Storage**

2 Pack, for HPLPDH72 and HLPLWMH72

2 Pack, for HPLPDH66 and HLPLWMH66

2 Pack, for HPLPDH60 and HLPLWMH60

3 Pack, for HLPLWMH48

HLPLDR72LM

12

0.8

\$51**HLPLDR66LM**

12

0.8

\$51**HLPLDR60LM**

12

0.8

\$51**HLPLDR48LM**

17

0.8

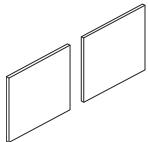
\$74**Glass Doors for Hutch and Wall Mounted Storage**

2 Pack, for HPLPDH72 and HLPLWMH72

2 Pack, for HPLPDH66 and HLPLWMH66

2 Pack, for HPLPDH60 and HLPLWMH60

3 Pack, for HLPLWMH48

HLPLDR72GS

9

0.8

\$177**HLPLDR66GS**

9

0.8

\$177**HLPLDR60GS**

9

0.8

\$177**HLPLDR48GS**

13

0.8

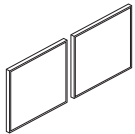
\$268

NOTES: No specification needed.

SPECIFYING EXAMPLE: HPLDR66GS**Tackboards**

72"W x 18"H

66"W x 18"H

60"W x 18"H

48"W x 18"H

HLPLTACK72

12

2.4

\$153**HLPLTACK66**

12

2.2

\$144**HLPLTACK60**

10

2.1

\$139**HLPLTACK48**

8

1.7

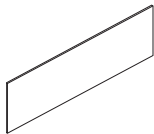
\$125

Specify: Model.Fabric

SPECIFYING EXAMPLE: HLPLTACK66.CN02**Markerboard**

12"W x 12"H

HLPLDR12MB

3

0.6

\$89

NOTES: No specification needed. Markerboard is designed to fit over the top of the laminate doors for hutches to create a writable/movable surface.

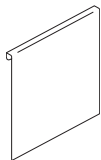
SPECIFYING EXAMPLE: HPLDR12MB**NOTES:**

- Scratch- and stain-resistant thermal-fused laminate surfaces.
- Durable 5/8" thick tops and end panels.
- 72"W, 66"W, and 60"W hutches include fully enclosed back.
- Hutches and Wall Mounted Storage assemble quickly and easily.
- **HON 5-Year Limited Warranty.**

HOW TO SPECIFYSelect
Model NumberSelect
Laminate

See page 127

H L P L W M H 6 6 .

L S L 1

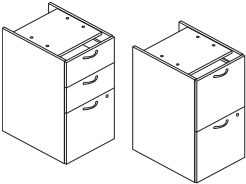
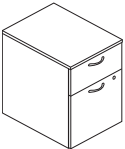

	DESCRIPTION	MODEL	SHIP WEIGHT	CUBE	LIST PRICE
	Support Pedestal 15½"W x 20"D x 28"H, Box/Box/File 15½"W x 20"D x 28"H, File/File NOTES: Optional Pulls available, see below. ⓘ Top is unfinished. Not to be used freestanding.	HLPLPSBBF HLPLPSFF	81.0 79.0	7.4 7.4	\$418 \$418
	Hanging Pedestal 15½"W x 20"D x 20½"H, Box/File NOTES: Optional Pulls available, see below. ⓘ Top is unfinished. Not to be used freestanding. ⓘ Hanging Pedestal is designed to attach to the underside of the worksurface and is non-handed (can be assembled on left or right side).	HLPLPHBF	63.0	5.8	\$306
 HLPLPMBF shown	Mobile Pedestal 15½"W x 20"D x 28"H, Box/Box/File 15½"W x 20"D x 28"H, File/File 15½"W x 20½"D x 21½"H, Box/File NOTES: Optional Pulls available, see below.	HLPLPMBBF HLPLPMFF HLPLPMBF	81.0 79.0 63.0	7.4 7.4 5.8	\$515 \$515 \$364
	Pedestal Cushion 15½"W x 20"D Specify: Model.Fabric SPECIFYING EXAMPLE: HLPLPSEAT1520.CN02	HLPLPSEAT1520	6.0	1.1	\$114
	Field Installed Contemporary Pull — 2-pack Silver NOTES: For use on Lateral Files, Pedestals, Wardrobe, and 2-Drawer Low Credenza. ⓘ Silver finish only, no specification needed.	HBLPCONTEMP	0.4 ⓘ	0.1	\$17
Field Installed Bridge Pull — 2-pack Silver NOTES: For use on Lateral Files, Pedestals, Wardrobe, and 2-Drawer Low Credenza. ⓘ Polished finish only, no specification needed.	HBLPBRIDGE	0.4 ⓘ	0.1	\$17	
Field Installed Classic Pull — 2-pack Black NOTES: For use on Lateral Files, Pedestals, Wardrobe, and 2-Drawer Low Credenza. ⓘ Black finish only, no specification needed.	HBLPCLASSIC	0.4 ⓘ	0.1	\$17	

NOTES:

- Pedestals ship assembled.
- Support Pedestals are designed to be used under a desk, credenza, or return shell and installed by leveling up the glides to a tight fit under tops (hardware not included).
- Drawers operate on full extension, ball-bearing suspensions to ensure smooth, quiet, and long-lasting operation.
- Pedestals come standard with Arch pull in Silver finish.
- **HON 5-Year Limited Warranty.**

HOW TO SPECIFY

Select Model Number HLPLPSBBF	Select Laminate See page 127 LSL1
--	---

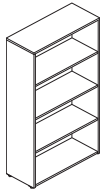

HLPLBC3013B5 shown

DESCRIPTION**Bookcase**

30½"W x 13"D x 65½"H, 5-Shelf, 3 Adjustable Shelves, 1 Fixed Shelf
 30½"W x 13"D x 53"H, 4-Shelf, 2 Adjustable Shelves, 1 Fixed Shelf
 30½"W x 13"D x 29"H, 2-Shelf, 1 Fixed Shelf

MODEL

HLPLBC3013B5
HLPLBC3013B4
HLPLBC3013B2

SHIP WEIGHT

137
 112
 63

CUBE

6.1
 5.2
 3.2

LIST PRICE

\$412
\$296
\$203

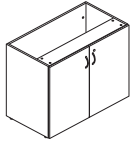
**Storage Cabinet**

36"W x 20"D x 29"H

HLPLSC3620

76

15.7

\$478

NOTES: Optional Pulls available, see page 139.

! Top is unfinished, not to be used freestanding. To convert to a freestanding cabinet, order model HLPLCL3620TOP, see page 142.

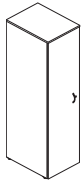
**Wardrobe**

24"W x 24"D x 65½"H
 18"W x 24"D x 65½"H

HLPLW2424
HLPLW1824

99
 84

4.2
 4.2

\$1066
\$698

NOTES: Optional Pulls available, see page 139. Non-handed door which can be installed in left- or right-hand configuration. Coat rod, fixed shelf, and lock included.

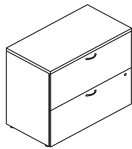

HLPLLF3620L2 shown

Lateral

36½"W x 20"D x 53"H, 4-Drawer
 36½"W x 20"D x 40"H, 3-Drawer
 36½"W x 20"D x 29"H, 2-Drawer w/Removable Top

HLPLLF3620L4
HLPLLF3620L3
HLPLLF3620L2

193
 166
 145

27.4
 21.1
 15.7

\$1187
\$1050
\$676

NOTES: Optional Pulls available, see page 139.

! 2-Drawer Lateral, HLPLLF3620L2, available in all Laminate finishes including Simply White.

NOTES:

- Lateral files ship assembled.
- Drawers operate on full extension, ball-bearing suspensions to ensure smooth, quiet, and long-lasting operation.
- Hangrails are included in each file drawer for side-to-side legal filing, and for front-to-back letter and legal filing.
- Storage Cabinet, Wardrobe, and Lateral Files come standard with Arch pull in Silver finish.
- **HON 5-Year Limited Warranty.**

HOW TO SPECIFY

Select
Model Number

H L P L B C 3 0 1 3 B 5 .

Select
Laminate

See page 127

L S L 1



	DESCRIPTION	MODEL	SHIP WEIGHT	CUBE	LIST PRICE		
	Rectangular Worksurface 72"W x 30"D 72"W x 24"D	HLPLRW7230 HLPLRW7224	110 89	6.0 4.9	\$249 \$205		
	66"W x 30"D 66"W x 24"D	HLPLRW6630 HLPLRW6624	101 82	5.5 4.5	\$233 \$192		
	60"W x 30"D 60"W x 24"D	HLPLRW6030 HLPLRW6024	92 75	5.0 4.1	\$220 \$182		
	48"W x 30"D 48"W x 24"D	HLPLRW4830 HLPLRW4824	75 61	4.1 3.4	\$210 \$178		
	Specify: Model.Laminate SPECIFYING EXAMPLE: HLPLRW6630.LSL1						
		External Stiffener For 72"W Worksurfaces For 66"W Worksurfaces For 60"W Worksurfaces	HLPLXS72 HLPLXS66 HLPLXS60	7 7 6	0.7 0.6 0.6	\$102 \$96 \$89	
		ⓘ Available in Graphite paint only. SPECIFYING EXAMPLE: HLPLXS66.BLKP					
			A-Leg Support 30"W Angled Leg 24"W Angled Leg	HLPLLEG30A HLPLLEG24A	16 14	5.1 3.7	\$195 \$184
			NOTES: A-Leg will have adjustable floor leveling glides which provide 2" of adjustment.				
		U-Leg Support 30"W U-Leg 24"W U-Leg	HLPLLEG30U HLPLLEG24U	17 15	5.1 3.7	\$195 \$184	
NOTES: U-Leg will have adjustable floor leveling glides which provide 3" of adjustment.							
	Credenza Leg Support 7"H x 30"D Support Leg 7"H x 24"D Support Leg	HLPLSL30 HLPLSL24	6 5	1.0 1.0	\$128 \$118		
		Overhead Support Leg 23"H, Pack of 2 10½"H, Pack of 2	HLPLOS23 HLPLOS10	13 9	1.1 0.8	\$184 \$144	
		Flat Bracket 24"D Bracket	HLPLFB24	3	0.6	\$63	
ⓘ Available in Graphite paint only, no paint selection. SPECIFYING EXAMPLE: HLPLFB24							

NOTES:

- Scratch- and stain-resistant thermal-fused laminate surfaces.
- Durable 1" thick tops.
- Worksurfaces come standard with 3" round Black grommets.
- **HON 5-Year Limited Warranty.**

HOW TO SPECIFY

<p>Select Model Number</p>	<p>Select Paint Color</p> <p>See page 127</p>
<p>H L P L L E G 3 0 A .</p>	<p>B L K P</p>

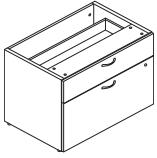
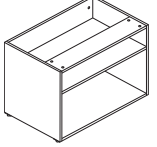
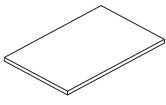
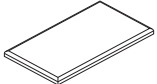

	DESCRIPTION	MODEL	SHIP WEIGHT	CUBE	LIST PRICE
	Low Credenza, 2 Drawers, Personal Cabinet, No Top 36½"W x 20"D x 21"H 30½"W x 20"D x 21"H NOTES: Optional Pulls available, see page 139. Unit ships fully assembled. Two low credenza units (2 drawer or Open Storage) can be combined using 1 top to create 60", 66", or 72" low credenzas. ! Top is unfinished, not to be used freestanding. Use with low credenza tops below to create a finished credenza.	HLPLCL3620BF	113	11.8	\$693
		HLPLCL3020BF	80	10.1	\$678
	Low Credenza, 2 Open Shelves, Open Storage Cabinet, No Top 36½"W x 20"D x 21"H 30½"W x 20"D x 21"H NOTES: Unit ships flat packed; assembly required. Two low credenza units (2 drawer or Open Storage) can be combined using 1 top to create 60", 66", or 72" low credenzas. ! Top is unfinished, cannot be used without a top. Use with low credenza tops below to create a finished credenza.	HLPLCL3620S	63	3.0	\$326
		HLPLCL3020S	48	2.5	\$314
	Low Credenza Cabinet Top 73"W x 20"D 67"W x 20"D 61"W x 20"D 36½"W x 20"D 30½"W x 20"D	HLPLCL7220TOP	74	4.2	\$166
		HLPLCL6620TOP	68	3.9	\$164
		HLPLCL6020TOP	63	3.5	\$154
		HLPLCL3620TOP	37	2.2	\$107
		HLPLCL3020TOP	30	1.9	\$99
	Low Credenza Cushion 36"W x 20"D 30"W x 20"D Specify: Model.Fabric SPECIFYING EXAMPLE: HLPLCSEAT3620.CN02	HLPLCSEAT3620	11	2.2	\$228
		HLPLCSEAT3020	9	1.9	\$234

NOTES:

- Scratch- and stain-resistant thermal-fused laminate surfaces.
- Durable 1" thick tops.
- Low credenzas ship assembled.
- Drawers operate on full extension, ball-bearing suspensions to ensure smooth, quiet, and long-lasting operation.
- Hangrails are included in each file drawer for side-to-side legal filing, and for front-to-back letter and legal filing.
- Low Credenza, 2 Drawer comes standard with Arch pull in Silver finish.
- **HON 5-Year Limited Warranty.**

! Top must be specified with low credenza when using a cushion.

HOW TO SPECIFY

Select Model Number HLPLCL3620BF	Select Laminate See page 127 LSL1
--	--

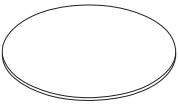
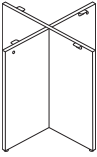
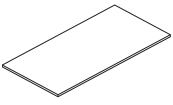
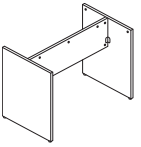

Conference Table Modular Components

	DESCRIPTION	MODEL	SHIP WEIGHT	CUBE	LIST PRICE
	Round Conference Table Tops				
	48" Round Top	HLPLTBL48RND	63	6.5	\$263
	42" Round Top	HLPLTBL42RND	50	5.1	\$255
	36" Round Top	HLPLTBL36RND	39	3.8	\$210
	Round Conference Table Bases				
	X-Base for 48" Table Tops	HLPLTBL48BASE	45	3.2	\$111
	X-Base for 42" Table Tops	HLPLTBL42BASE	42	3.2	\$106
	X-Base for 36" Table Tops	HLPLTBL36BASE	36	2.5	\$103
	Rectangle Conference Table Tops				
	48"W x 120"L Rectangular Top, 2-Piece	HLPLTBL48120RCT	293	7.8	\$849
	42"W x 96"L Rectangular Top	HLPLTBL4296RCT	205	10.7	\$586
	36"W x 72"L Rectangular Top	HLPLTBL3672RCT	132	7.1	\$346
	Rectangle Conference Table Bases				
	Slab Base for 120" Table Tops	HLPLTBL120BASE	86	4.2	\$139
	Slab Base for 96" Table Tops	HLPLTBL96BASE	64	5.1	\$133
	Slab Base for 72" Table Tops	HLPLTBL72BASE	48	3.0	\$125

NOTES:

- Scratch- and stain-resistant thermal-fused laminate surfaces.
- Durable 1" thick tops and support legs.
- **HON 5-Year Limited Warranty.**

HOW TO SPECIFY

<p>Select Model Number</p> <p>HLPLTBL42RND</p>	<p>Select Laminate</p> <p>See page 127</p> <p>LSL1</p>
--	--

MOD

Reception Modular Components

OPEN MARKET

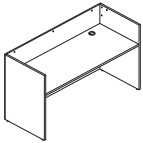
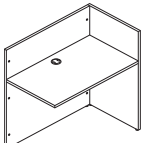
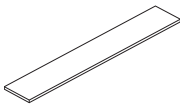

Icon Legend on page 19

	DESCRIPTION	MODEL	SHIP WEIGHT	CUBE	LIST PRICE
	Reception Desk Shell 72"W x 30"D x 41"H	HLPLRCPNDS7230	182	8.3	\$525
	Reception Return Shell 42"W x 25"D x 41"H	HLPLRCPNRS4225	110	5.1	\$318
	Transaction Tops 73"W x 12"D Laminate 73"W x 12"D Frosted Glass	HLPLRCPNTPLM HLPLRCPNTPGS	45 35	3.5 3.2	\$114 \$395
	<p>! No selection for Glass Transaction Top, only one finish option.</p>				

NOTES:

- Scratch- and stain-resistant thermal-fused laminate surfaces.
- Durable 1" thick tops and end panels.
- Adjustable floor leveling glides provide $\frac{3}{4}$ " of adjustment.
- Reception stations assemble quickly and easily.
- 3" round Black grommet(s) in tops of desks to route cords.
- **HON 5-Year Limited Warranty.**

HOW TO SPECIFY

Select Model Number HLPLRCPNDS7230	Select Laminate See page 127 LSL1
--	--



Valido® shown with Flock®
and Ignition® Seating.

VALIDO®

Valido knows how to make them. Impeccable design. Quality craftsmanship. A tailored, signature style that lasts. With precision-machined edges and more than 100 different surface combinations, Valido lets you create a custom-built look with an executive edge. And thanks to a variety of flexible component options — plus high-quality laminate that resists scratches, stains, spills and wear — Valido is the very definition of form meeting function.



FEATURES

- Formal 1½-thick worksurfaces are finished with an elegant, ribbon-edge detail.
- Multiple storage options let you create spaces that work the way you do.
- Valido components are designed to fit, form and grow into every area and any space.
- Metal-to-metal fastening system for precise fit and unsurpassed durability.
- Available in durable mix-and-match laminates, including woodgrain, solid, and pattern colors.
- Four decorative handle options to choose from.

VALIDO® ORDERING INFORMATION

LAMINATE FINISHES AVAILABILITY

L1 LAMINATES CODES

Woodgrain

- ◆ Bourbon Cherry **HH**
- ◆ Cognac **COGNCOGN**
- ◆ Field Elm **LWFELWFE**
- ◆ Florence Walnut **LFW1LFW1**
- ◆ Harvest **CC**
- ◆ Kingswood Walnut **LKI1LKI1**
- ◆ Mahogany **NN**
- ◆ Mocha **MOCHMOCH**
- ◆ Natural Maple **DD**
- ◆ Pinnacle **PINCPINC**
- ◆ Shaker Cherry **FF**
- ◆ Sterling Ash **LSA1LSA1**

Solid

- ◆ Black **PP**
- ◆ Charcoal **SS**
- ◆ Designer White **LDW1LDW1**
- ◆ Loft **LOFT**

Patterned Top

- ◆ Handspun Chestnut **LAHC**
- ◆ Handspun Dove **LAHD**
- ◆ Handspun Pearl **LAHP**
- ◆ Handspun Slate **LAHS**
- ◆ Silver Mesh **B9(*)**

L2 LAMINATES CODES

Two-Tone Top/Base

- ◆ Beigewood **LWBELWBE**
- ◆ Fawn Cypress **LFC1LFC1**

TWO-TONE LAMINATE TOP / BASE

L1 LAMINATES CODES

Two-Tone Top/Base

- ◆ Black/Charcoal **PS**
- ◆ Black/Designer White ... **PLDW1**
- ◆ Bourbon Cherry/Black **HP**
- ◆ Bourbon Cherry/Charcoal ... **HS**
- ◆ Bourbon Cherry/Designer
White **HLDW1**
- ◆ Charcoal/Black **SP**
- ◆ Charcoal/Designer
White **SLDW1**
- ◆ Cognac/Black **COGNP**
- ◆ Cognac/Charcoal **COGNS**
- ◆ Cognac/Designer
White **COGNLDW1**
- ◆ Designer White/Black ... **LDW1P**
- ◆ Designer White/Bourbon
Cherry **LDW1H**
- ◆ Designer
White/Charcoal **LDW1S**
- ◆ Designer
White/Cognac **LDW1COGN**
- ◆ Designer
White/Harvest **LDW1C**
- ◆ Designer
White/Mahogany **LDW1N**
- ◆ Designer
White/Mocha **LDW1MOCH**
- ◆ Designer White/Natural
Maple **LDW1D**
- ◆ Designer
White/Pinnacle **LDW1PINC**
- ◆ Designer White/Shaker
Cherry **LDW1F**
- ◆ Field Elm/Black **LWFEP**
- ◆ Field Elm/Charcoal **LWFES**
- ◆ Field Elm/Designer
White **LWFELDW1**
- ◆ Field Elm/Loft **LWFELOFT**
- ◆ Florence Walnut/Black . **LFW1P**
- ◆ Florence
Walnut/Charcoal **LFW1S**
- ◆ Florence Walnut/Designer
White **LFW1LDW1**
- ◆ Handspun Chestnut/
Black **LAHCP**
- ◆ Handspun Chestnut/
Charcoal **LAHCS**
- ◆ Handspun Chestnut/
Designer White **LAHCLDW1**
- ◆ Handspun Chestnut/
Loft **LAHCLOFT**
- ◆ Handspun Dove/Black .. **LAHDP**
- ◆ Handspun Dove/
Charcoal **LAHDS**
- ◆ Handspun Dove/
Designer White **LAHDLDW1**
- ◆ Handspun Dove/
Loft **LAHDLOFT**
- ◆ Handspun Pearl/Black .. **LAHPP**
- ◆ Handspun Pearl/
Charcoal **LAHPS**

TWO-TONE LAMINATE TOP / BASE

continued

L1 LAMINATES CODES

Two-Tone Top/Base

- ◆ Handspun Pearl/
Designer White **LAHPLDW1**
- ◆ Handspun Pearl/
Loft **LAHPLOFT**
- ◆ Handspun Slate/Black ... **LAHSP**
- ◆ Handspun Slate/
Charcoal **LAHSS**
- ◆ Handspun Slate/
Designer White **LAHSLDW1**
- ◆ Handspun Slate/
Loft **LAHSLOFT**
- ◆ Harvest/Black **CP**
- ◆ Harvest/Charcoal **CS**
- ◆ Harvest/Designer
White **CLDW1**
- ◆ Kingswood
Walnut/Black **LKI1P**
- ◆ Kingswood
Walnut/Charcoal **LKI1S**
- ◆ Kingswood Walnut/Designer
White **LKI1LDW1**
- ◆ Mahogany/Black **NP**
- ◆ Mahogany/Charcoal **NS**
- ◆ Mahogany/Designer
White **NLDW1**
- ◆ Mocha/Black **MOCHP**
- ◆ Mocha/Charcoal **MOCHS**
- ◆ Mocha/Designer
White **MOCHLDW1**
- ◆ Natural Maple/Black **DP**
- ◆ Natural Maple/Charcoal **DS**
- ◆ Natural Maple/Designer
White **DLDW1**
- ◆ Pinnacle/Black **PINCP**
- ◆ Pinnacle/Charcoal **PINCS**
- ◆ Pinnacle/Designer
White **PINCLDW1**
- ◆ Shaker Cherry/Black **FP**
- ◆ Shaker Cherry/Charcoal **FS**
- ◆ Shaker Cherry/Designer
White **FLDW1**
- ◆ Sterling Ash/Black **LSA1P**
- ◆ Sterling Ash/Charcoal **LSA1S**
- ◆ Sterling Ash/Designer
White **LSA1LDW1**

L2 LAMINATES CODES

Two-Tone Top/Base

- ◆ Beigewood/Black **LWBEP**
- ◆ Beigewood/Charcoal ... **LWBES**
- ◆ Beigewood/
Designer White **LWBELDW1**
- ◆ Beigewood/Loft **LWBELOFT**
- ◆ Fawn Cypress/Black **LFC1P**
- ◆ Fawn Cypress/Charcoal . **LFC1S**
- ◆ Fawn Cypress/
Designer White **LFC1LDW1**
- ◆ Fawn Cypress/Loft .. **LFC1LOFT**

(*) Patterned top laminates are available with the following base/edgebanding laminate selection: C, COGN, D, F, H, MOCH, N, P, PINC, S, DW, FW, KI, or SA. Edgebanding will match base laminate selected.

SPECIFYING EXAMPLE: H11592.L6N

The following Valido products are not available as two-tone and require only one color code:

- Modular pedestals — box/file, box/box/file, file/file, lateral file, multi file, and cabinet.

◆◆◆ For lead time information see page 21.

◆◆◆ For lead time information see page 21.

VALIDO® ORDERING INFORMATION

Patterned Top

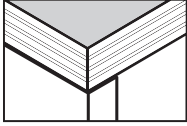

Edgeband Around Top / Laminate Base

- Edgebanding on patterned laminates matches the laminate base selected.
- LAMINATE DESKS
SPECIFY: Model Number.
Laminate
EXAMPLE: H11596.NN
- WORKSURFACES
SPECIFY: Model Number.
Top Laminate
Edgeband
- **All specifications in this publication are based on the latest product information available at the time of print.**

! Tops with a patterned color are not available with a matching edgeband.

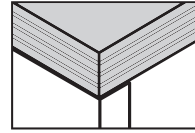

Laminate Base

Two-tone laminates: Top and edgebanding are the same, base is different laminate color.

- Edgebanding on two-tone laminates matches top, base is a different laminate color. A complete selection of Conference Room and Occasional Tables is shown in the Tables section in the 2023 Shared Spaces Pricer.
- LAMINATE DESKS
SPECIFY: Model Number.
Laminate
EXAMPLE: H11596.HP
- **All specifications in this publication are based on the latest product information available at the time of print.**

Edge Option:

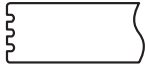

Ribbon Edge "A"

Handle Options:



Sweep Designator
Black
Satin Nickel
A
C

4⁵/₈"W



Crescent Designator
Black
Satin Nickel
D
F

5"W

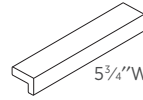

Linear
Black
Matte Chrome
G
J

5³/₄"W

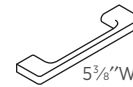

Arch
Black
Matte Chrome
K
M

5³/₈"W



Components used are listed on pages 151-171. Order components individually. Other configurations are possible, including various sizes of some components.

QTY	DESCRIPTION	MODEL	LIST PRICE	PRICE EXTENSION
1	Double Pedestal Desk - 2/2 72"W x 36"D x 29½"H	H11593	\$2,595	\$2,595
1	Credenza with Kneespace - 2/2 72"W x 24"D x 29½"H	H11543	\$2,403	\$2,403
1	Stack-on Storage 72"W x 14⅝"D x 37½"H	H11534	\$1,868	\$1,868
2	Vertical Paper Manager	HLVPM1	\$445	\$890
TOTAL:			\$7,756	

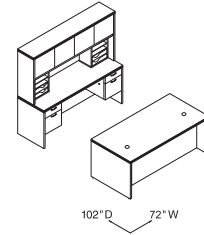

DESK/CREDENZA
72"W x 102"D

QTY	DESCRIPTION	MODEL	LIST PRICE	PRICE EXTENSION
1	Double Pedestal Bow Top Desk - 2/2 72"W x 36"D x 29½"H	H11595	\$2,832	\$2,832
1	Credenza with Kneespace - 2/2 72"W x 24"D x 29½"H	H115900	\$2,989	\$2,989
1	Stack-on Storage 72"W x 14⅝"D x 37½"H	H11534	\$1,868	\$1,868
1	Personal Wardrobe/Storage Cabinet, Left 18"W x 24"D x 67"H	H115296L	\$2,570	\$2,570
1	Storage/File Cabinet, Right 18"W x 24"D x 67"H	H115297R	\$2,972	\$2,972
TOTAL:			\$13,231	

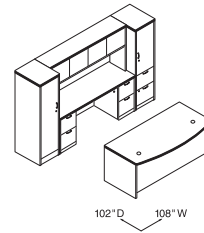

DESK/CREDENZA
108"W x 102"D

QTY	DESCRIPTION	MODEL	LIST PRICE	PRICE EXTENSION
1	Single Pedestal Desk, Left - B/F 72"W x 36"D x 29½"H	H11586L	\$2,206	\$2,206
1	Return, Right - B/F 48"W x 24"D x 29½"H	H11515R	\$1,605	\$1,605
1	Stack-on Storage 48"W x 14⅝"D x 37½"H	H115323	\$1,519	\$1,519
1	Square End Cap Bookshelf 24"W x 24"D x 29½"H	H115525R	\$1,089	\$1,089
TOTAL:			\$6,419	

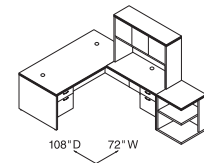

"L" WORKSTATION
72"W x 108"D

QTY	DESCRIPTION	MODEL	LIST PRICE	PRICE EXTENSION
1	Single Pedestal Desk, Left - B/F 66"W x 30"D x 29½"H	H11584L	\$2,061	\$2,061
1	Return, Right - B/F 48"W x 24"D x 29½"H	H11515R	\$1,605	\$1,605
1	Stack-on Storage 78"W x 14⅝"D x 37½"H	H115327	\$2,077	\$2,077
1	Vertical Paper Manager	HLVPM1	\$445	\$445
1	End Cap Bookshelf 24"W x 24"D x 29½"H	H115520	\$1,106	\$1,106
1	End Cap Bookshelf 15"W x 15"D x 37½"H	H115523	\$978	\$978
TOTAL:			\$8,272	

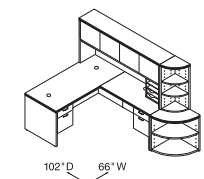

"L" WORKSTATION
66"W x 102"D



Icon Legend on page 19

Components used are listed on pages 151-171. Order components individually. Other configurations are possible, including various sizes of some components.

QTY	DESCRIPTION	MODEL	LIST PRICE	PRICE EXTENSION
1	Single Pedestal Desk, Right - B/F 72"W x 36"D x 29½"H	H11585R	\$2,206	\$2,206
1	Bridge 47"W x 24"D x 29½"H	H11570	\$732	\$732
1	Credenza with 36" Lateral, Left 72"W x 24"D x 29½"H	H11548L	\$2,578	\$2,578
1	Stack-on Storage 72"W x 14⅝"D x 37½"H	H11534	\$1,868	\$1,868
1	Storage Cabinet/Lateral File 36"W x 24"D x 67"H	H115293	\$3,851	\$3,851
TOTAL:			\$11,235	

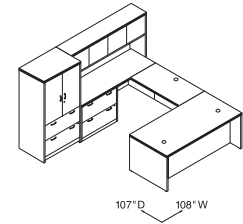

"U" WORKSTATION
108"W x 107"D

QTY	DESCRIPTION	MODEL	LIST PRICE	PRICE EXTENSION
1	Single Full Pedestal Bow Front Desk 72"W x 36"D x 29½"H	H115893R	\$3,091	\$3,091
1	Bridge 42"W x 24"D x 29½"H	H11560	\$700	\$700
1	Left Single Full Pedestal Credenza 72"W x 24"D x 29½"H	H115904L	\$2,460	\$2,460
1	Stack-on Storage 72"W x 14⅝"D x 37½"H	H11534	\$1,868	\$1,868
1	Vertical Paper Manager	HLVPM1	\$445	\$445
1	Personal Wardrobe/Storage Cabinet 36"W x 24"D x 67"H	H11530	\$3,761	\$3,761
TOTAL:			\$12,325	

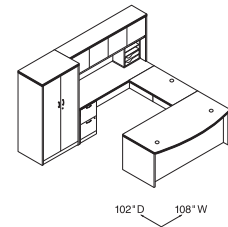

"U" WORKSTATION
108"W x 102"D

QTY	DESCRIPTION	MODEL	LIST PRICE	PRICE EXTENSION
1	Single Pedestal Bow Front Desk, Right - B/F 72"W x 36"D x 29½"H	H11587R	\$2,496	\$2,496
1	Bridge 36"W x 24"D x 29½"H	H115599	\$700	\$700
1	36" Corner Unit	H115811	\$1,304	\$1,304
1	Return, Left	H11512L	\$1,588	\$1,588
1	Stack-on Storage 78"W x 14⅝"D x 37½"H	H115327	\$2,077	\$2,077
1	Vertical Paper Manager	HLVPM1	\$445	\$445
1	Personal Storage Tower 24"W x 24"D x 67"H	H115301R	\$3,761	\$3,761
TOTAL:			\$12,371	

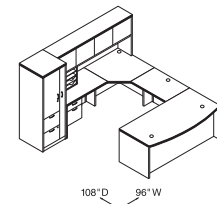

"U" WORKSTATION
102"W x 108"D

QTY	DESCRIPTION	MODEL	LIST PRICE	PRICE EXTENSION
1	Extended Corner Unit, Left 24"D x 72"W x 36"D x 24"W x 29½"H	H115816L	\$1,892	\$1,892
1	Box/Box/File Mobile Pedestal 15⅝"W x 22¾"D x 28"H	H115102	\$1,359	\$1,359
1	Stack-on Storage 72"W x 14⅝"D x 37½"H	H11534	\$1,868	\$1,868
1	Vertical Paper Manager	HLVPM1	\$445	\$445
1	Return Shell (with Full Modesty Panel) 48"W x 24"D x 29½"H	H11561	\$997	\$997
1	File/File Mobile Pedestal 15⅝"W x 22¾"D x 28"H	H115104	\$1,359	\$1,359
TOTAL:			\$7,920	

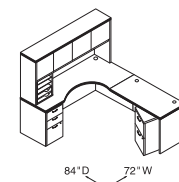

MODULAR "L" WORKSTATION
72"W x 84"D



Components used are listed on pages 151-171. Order components individually. Other configurations are possible, including various sizes of some components.

QTY	DESCRIPTION	MODEL	LIST PRICE	PRICE EXTENSION
1	Jetty Peninsula, Left 72"W x 42"/30"D x 29½"H	H115202LE	\$2,006	\$2,006
1	File/File Mobile Pedestal 15⅝"W x 22¾"D x 28"H	H115104	\$1,359	\$1,359
1	Return Shell 72"W x 24"D x 29½"H	H115686	\$1,302	\$1,302
1	Multi File Pedestal 36"W x 20"D x 28"H	H11505	\$2,034	\$2,034
2	Wall Mounted Storage Cabinet 42"W x 14⅝"D x 18⅞"H	H115382	\$1,428	\$2,856
1	Wall Mounted Storage Cabinet 30"W x 14⅝"D x 18⅞"H	H115380	\$1,262	\$1,262
1	End Cap Bookshelf 24"W x 24"D x 29½"H	H115520	\$1,106	\$1,106
TOTAL:			\$11,925	

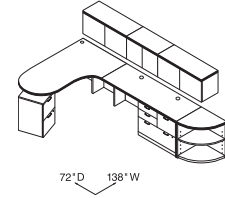

MODULAR "L" WORKSTATION
138" W x 72" D

QTY	DESCRIPTION	MODEL	LIST PRICE	PRICE EXTENSION
1	Storage/File Cabinet, Left 18"W x 24"D x 67"H	H115298L	\$2,972	\$2,972
1	Return Shell 72"W x 24"D x 29½"H	H115686	\$1,302	\$1,302
1	File/File Modular Pedestal 15⅝"W x 22¾"D x 28"H	H11504	\$1,111	\$1,111
1	Mobile Printer/Fax Cart 20"W x 19⅞"D x 14⅞"H	H105679	\$526	\$526
1	Stack-on Storage 72"W x 14⅝"D x 37½"H	H11534	\$1,868	\$1,868
1	Vertical Paper Manager	HLVPM1	\$445	\$445
1	36" Corner Unit	H115811	\$1,304	\$1,304
1	Stack-on Storage 36"W x 14⅝"D x 37½"H	H115321	\$1,252	\$1,252
1	Return Shell 60"W x 24"D x 29½"H	H115684	\$1,218	\$1,218
1	Multi File Pedestal 36"W x 20"D x 28"H	H11505	\$2,034	\$2,034
TOTAL:			\$14,032	

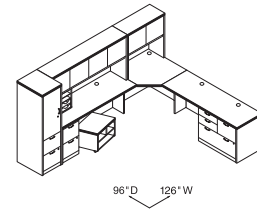

MODULAR "L" CORNER WORKSTATION
126" W x 96" D

QTY	DESCRIPTION	MODEL	LIST PRICE	PRICE EXTENSION
1	Boomerang Peninsula, Left 72"W x 42"/30"D x 29½"H	H115204LE	\$2,006	\$2,006
1	Box/Box/File Mobile Pedestal 15⅝"W x 22¾"D x 28"H	H115102	\$1,359	\$1,359
1	Bridge 30"W x 24"D x 29½"H	H115598	\$700	\$700
1	Extended Corner Unit, Right 24"W x 36"D x 72"W x 24"D x 29½"H	H115815R	\$1,892	\$1,892
1	File/File Modular Pedestal 15⅝"W x 22¾"D x 28"H	H11504	\$1,111	\$1,111
1	Stack-on Storage 72"W x 14⅝"D x 37½"H	H11534	\$1,868	\$1,868
1	Storage/File Cabinet, Right 18"W x 24"D x 67"H	H115297R	\$2,972	\$2,972
1	End Cap Bookshelf 24"W x 24"D x 67"H	H115524	\$1,754	\$1,754
TOTAL:			\$13,662	

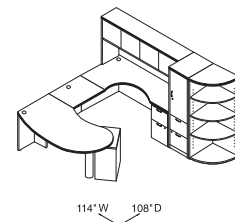

MODULAR "U" WORKSTATION
114" W x 108" D



Icon Legend on page 19

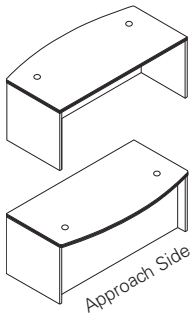

Model H11596 shown

DESCRIPTION	INSIDE DIMENSIONS	FULL WIDTH OVERHANG	MODEL	SHIP WEIGHT	SHIP CUBE	LIST PRICE BY LAMINATE GRADE	
						L1	L2
Desk Shell (with Full Modesty Panel)							
72"W x 36"D x 29½"H, Bow Top (end panels 30"D)	69½"W x 24⅝"D	10½"	H11596	218	5.8	\$1545	\$1598
72"W x 36"D x 29½"H, Rectangle Top	69½"W x 24⅝"D	10½"	H11594	239	5.8	\$1479	\$1532
72"W x 30"D x 29½"H, Rectangle Top	69½"W x 24⅝"D	4½"	H11592	206	6.6	\$1380	\$1422
66"W x 30"D x 29½"H, Rectangle Top	63½"W x 24⅝"D	4½"	H11579	194	4.5	\$1302	\$1344
60"W x 30"D x 29½"H, Rectangle Top	57½"W x 24⅝"D	4½"	H11578	182	4.1	\$1248	\$1290
48"W x 30"D x 29½"H, Rectangle Top (1 grommet)	45½"W x 24⅝"D	4½"	H11598	154	4.0	\$1178	\$1210

NOTES: See pages 709-710 for optional center drawers.

NOTES:

- Non-handed desk, credenza, and return shells, combined with a variety of under-the-worksurface storage solutions, maximize office layout flexibility. Shells and pedestals can be reconfigured quickly and easily when user preferences or space needs change.
- Tops are abrasion- and stain-resistant laminate over extra-thick 1½" solid core high-performance particleboard; resists warping.
- "Ribbon" edge profile; shape is on all four sides.
- Full height modesty panels.
- Cord management grommets, for routing and hiding wires and cables, are located in the tops of desk and return shells.
- 3" round worksurface grommet can be replaced with optional Power Hub (model HGRMTAC) or Power/USB Hub (model HGRMTUSB2) to bring the ease of plug-and-play to the desktop. See page 723.
- Credenza shells have a cord pass-through grommet in the top center of the modesty panel.
- The narrow design of the kneespace clearance end panel kits replace full end panels to provide added kneespace.
- Adjustable hex leveling glides allow floor-standing furniture to be easily leveled; glides have ¾" adjustable range.
- For conference table options, see the Preside® table tops and bases in the Tables section in the 2023 Shared Spaces Pricer. Order edge option "K".
- See pages 154-155 for modular storage components.

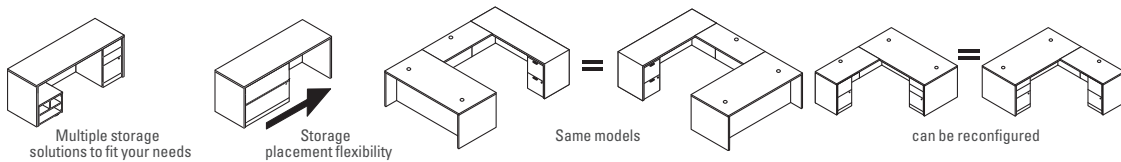

HOW TO SPECIFY

<p>Select Model Number</p> <p>H 1 1 5 9 6</p>	<p>Select Edge Profile</p> <p>See page 146</p> <p>A</p>	<p>Select Laminate</p> <p>See page 146</p> <p>NN</p>
--	--	---

VALIDO® Modular Credenzas

GSA SIN 33721



Icon Legend on page 19

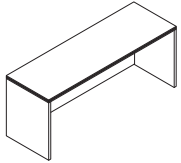

Model H11541 shown

DESCRIPTION	INSIDE DIMENSIONS	MODEL	SHIP WEIGHT	CUBE	LIST PRICE BY LAMINATE GRADE	
					L1	L2
24"D Credenza Shell (with Full Modesty Panel)						
72"W x 24"D x 29½"H	69½"W x 22¾"D	H11541	169	4.5	\$1302	\$1344
66"W x 24"D x 29½"H	63½"W x 22¾"D	H11542	159	4.2	\$1266	\$1308
60"W x 24"D x 29½"H	57½"W x 22¾"D	H11564	148	3.8	\$1218	\$1255
48"W x 24"D x 29½"H	45½"W x 22¾"D	H115692	135	2.8	\$1144	\$1176
42¼"W x 24"D x 29½"H	39¾"W x 22¾"D	H115691	118	3.4	\$1089	\$1121

NOTES: Cord pass-through grommet in top center of modesty panel. See pages 163-164 for optional stack-on storage.

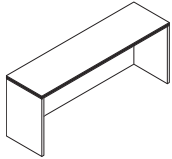

20"D Credenza Shell (with Full Modesty Panel)						
72"W x 20"D x 29½"H	69½"W x 18¾"D	H115581	154	5.3	\$1233	\$1270
66"W x 20"D x 29½"H	63½"W x 18¾"D	H115582	145	4.8	\$1195	\$1232
60"W x 20"D x 29½"H	57½"W x 18¾"D	H115583	135	4.4	\$1152	\$1184

NOTES: Cord pass-through grommet in top center of modesty panel. See pages 163-164 for optional stack-on storage.

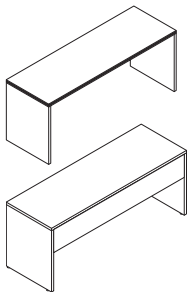

24"D Credenza Shell (with 10" Modesty Panel)						
72"W x 24"D x 29½"H	69½"W x 22¾"D	H11541X	162	5.0	\$1302	\$1344
66"W x 24"D x 29½"H	63½"W x 22¾"D	H11542X	124	4.0	\$1266	\$1308
60"W x 24"D x 29½"H	57½"W x 22¾"D	H11564X	120	4.0	\$1218	\$1255
48"W x 24"D x 29½"H	45½"W x 22¾"D	H115692X	107	4.0	\$1144	\$1176
42¼"W x 24"D x 29½"H	39¾"W x 22¾"D	H115691X	98	4.0	\$1089	\$1121

20"D Credenza Shell (with 10" Modesty Panel)						
72"W x 20"D x 29½"H	69½"W x 18¾"D	H115581X	124	4.6	\$1233	\$1270
66"W x 20"D x 29½"H	63½"W x 18¾"D	H115582X	117	4.2	\$1195	\$1232
60"W x 20"D x 29½"H	57½"W x 18¾"D	H115583X	110	3.8	\$1152	\$1184

NOTES: Makes reaching wall electrical outlets quick and easy. Provides more than 18" of clearance. See pages 163-164 for optional stack-on storage.



Not available in two-tone laminate

Kneespace Clearance End Panel Kits (field installable)						
1½"W x 11¼"D x 28⅞"H		H105098	13	0.9	\$261	\$272
For use at either end of Valido, 10500 Series™ 24"D Credenza Shells (with full or 10" modesty panel) or non-pedestal end of single pedestal credenzas or credenzas with lateral files.						

1½"W x 17¼"D x 28⅞"H		H105099	11	0.8	\$274	\$285
----------------------	--	---------	----	-----	-------	-------

For use at either end of Valido, 10500 Series™ 30"D Desk Shells or non-pedestal end of 30"D single pedestal desks.

Kits include: (1) support panel; European fastening hardware; flat connector bracket; joint connector bolts with sleeve nuts (for ganging credenza to adjacent worksurface); and adjustable leveling glides. Allows conversion of units currently in the field.

NOTES: Can be used to connect up to three 24"D credenzas or 30"D desks in line (requires 4 kits).

⚠ Not designed to be used freestanding. Not designed to be used with returns, 36"D desks or desk shells.

SPECIFYING EXAMPLE: H105098.N**NOTES:**

- Non-handed desk, credenza, and return shells, combined with a variety of under-the-worksurface storage solutions, maximize office layout flexibility. Shells and pedestals can be reconfigured quickly and easily when user preferences or space needs change.
- Tops are abrasion- and stain-resistant laminate over extra-thick 1½" solid core high-performance particleboard; resists warping.
- "Ribbon" edge profile; shape is on all four sides.
- Cord management grommets, for routing and hiding wires and cables, are located in the tops of desk and return shells.
- Credenza shells have a cord pass-through grommet in the top center of the modesty panel.
- The narrow design of the kneespace clearance end panel kits replace full end panels to provide added kneespace.
- Adjustable hex leveling glides allow floor-standing furniture to be easily leveled; glides have ¾" adjustable range.
- Credenza Shells available with Full or 10" Modesty Panel options.
- For conference table options, see the Preside® table tops and bases in the Tables section in the 2023 Shared Spaces Pricer. Order edge option "K".
- See pages 154-155 for modular storage components.

HOW TO SPECIFYSelect
Model Number

H 1 1 5 4 1 .

Select
Edge Profile

See page 146

A .

Select
Laminate

See page 146

N N



Icon Legend on page 19

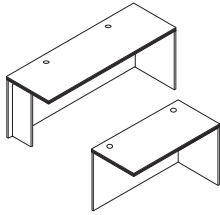

Model H115686 shown

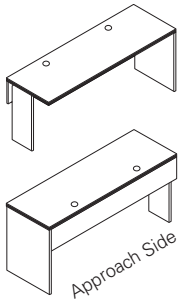

DESCRIPTION	INSIDE DIMENSIONS	MODEL	SHIP WEIGHT	CUBE	LIST PRICE BY LAMINATE GRADE	
					L1	L2
24"D Return Shell (with Full Modesty Panel)						
72"W x 24"D x 29½"H, (w/support; 2 grommets)	67"W x 22¾"D	H115686	161	5.4	\$1302	\$1344
60"W x 24"D x 29½"H, (w/support; 2 grommets)	55"W x 22¾"D	H115684	142	4.9	\$1218	\$1255
48"W x 24"D x 29½"H, (1 grommet)	47"W x 22¾"D	H11561	97	3.2	\$997	\$1029
42"W x 24"D x 29½"H, (1 grommet)	41"W x 22¾"D	H115681	97	2.5	\$976	\$1008
36"W x 24"D x 29½"H, (1 grommet)	34⅞"W x 22¾"D	H115680	91	3.2	\$976	\$1003
30"W x 24"D x 29½"H, (1 grommet)	28⅞"W x 22¾"D	H11568	78	2.8	\$907	\$944

24"D Return Shell (with 10" Modesty Panel)						
72"W x 24"D x 29½"H	67"W x 22¾"D	H115686X	124	5.0	\$1302	\$1344
60"W x 24"D x 29½"H	55"W x 22¾"D	H115684X	108	4.0	\$1218	\$1255
48"W x 24"D x 29½"H	47"W x 22¾"D	H11561X	90	3.0	\$997	\$1029
42"W x 24"D x 29½"H	41"W x 22¾"D	H115681X	80	3.0	\$976	\$1008
36"W x 24"D x 29½"H	34⅞"W x 22¾"D	H115680X	76	3.0	\$976	\$1003
30"W x 24"D x 29½"H	28⅞"W x 22¾"D	H11568X	65	2.8	\$907	\$934

NOTES: Shells are non-handed. No pre-drilled grommet in modesty panel (field installable grommet included). Woodgrain direction on modesty/back panel runs vertical on 30"W-60"W sizes and horizontal on 72"W unit. 36"W return shell can be used to achieve an efficient 6' x 6' footprint when connected to either a 72"W x 36"D single pedestal desk, desk shell, or peninsula, or when two are connected to a 36"W corner unit model H115811. 30"W return shell can be used to accomplish a 5' x 5' footprint when connected to a 60"W x 30"D desk shell or peninsula. See pages 163-164 for optional stack-on storage.

NOTES:

- Non-handed desk, credenza, and return shells, combined with a variety of under-the-worksurface storage solutions, maximize office layout flexibility. Shells and pedestals can be reconfigured quickly and easily when user preferences or space needs change.
- Tops are abrasion- and stain-resistant laminate over extra-thick 1½" solid core high-performance particleboard; resists warping.
- "Ribbon" edge profile; shape is on all four sides.
- Cord management grommets, for routing and hiding wires and cables, are located in the tops of desk and return shells.
- Credenza shells have a cord pass-through grommet in the top center of the modesty panel.
- The narrow design of the kneespace clearance end panel kits replace full end panels to provide added kneespace.
- Adjustable hex leveling glides allow floor-standing furniture to be easily leveled; glides have ¾" adjustable range.
- Credenza Shells available with Full or 10" Modesty Panel options.
- For conference table options, see the Preside® table tops and bases in the Tables section in the 2023 Shared Spaces Pricer. Order edge option "K".
- For work-in-process paper management tools, see pages 715-717.
- See pages 154-155 for modular storage components.

HOW TO SPECIFY

<p>Select Model Number</p> <p>H 1 1 5 6 8 6</p>	<p>Select Edge Profile</p> <p>See page 146</p> <p>A</p>	<p>Select Laminate</p> <p>See page 146</p> <p>NN</p>
--	--	---

VALIDO® Laminate Modular Components

GSA SIN 33721



Icon Legend on page 19

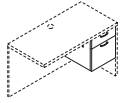

Not available in two-tone laminate

DESCRIPTION	MODEL	SHIP WEIGHT	CUBE	LIST PRICE BY LAMINATE GRADE	
				L1	L2
Box/File Pedestal (with core removable lock) 15 $\frac{5}{8}$ "W x 22 $\frac{3}{4}$ "D x 17 $\frac{3}{4}$ "H NOTES: For use under 24"D, 30"D and 36"D desk, credenza and return shells. Hangrails included. Lock can be positioned on either the right or left side. Attaches to underside of worksurface top. Unfinished top and back. ! Not designed to be used freestanding.	H11501	57	5.5	\$859	\$880
Narrow Box/Box/File Pedestal — floor-standing 9 $\frac{1}{2}$ "W x 22 $\frac{3}{4}$ "D x 28"H NOTES: For use under 24"D, 30"D and 36"D modular desk, credenza and return shells. Unfinished top and back. ! Handle choices for this model are the Sweep, Crescent and Arch designs only. The linear handle (options "G" and "J") is not available on this product as the width of the component interferes with lock on the drawer face. ! Not designed to be used freestanding.	H115093	61	5.6	\$1093	\$1120
Box/Box/File Pedestal (with core removable lock) — floor-standing 15 $\frac{5}{8}$ "W x 22 $\frac{3}{4}$ "D x 28"H — for use under 24"D, 30"D and 36"D desk, credenza and return shells 15 $\frac{5}{8}$ "W x 18 $\frac{3}{4}$ "D x 28"H — for use under 20"D, 24"D, 30"D and 36"D desk, credenza and return shells NOTES: Top box drawer does not lock. Hangrails included. Unfinished top and back. ! Not designed to be used freestanding.	H11502	90	8.4	\$1111	\$1138
	H115012	73	7.0	\$1047	\$1068
File/File Pedestal (with core removable lock) — floor-standing 15 $\frac{5}{8}$ "W x 22 $\frac{3}{4}$ "D x 28"H — for use under 24"D, 30"D and 36"D desk, credenza and return shells 15 $\frac{5}{8}$ "W x 18 $\frac{3}{4}$ "D x 28"H — for use under 20"D, 24"D, 30"D and 36"D desk, credenza and return shells NOTES: Hangrails included. Unfinished top and back. ! Not designed to be used freestanding.	H11504	85	8.4	\$1111	\$1138
	H115014	72	7.0	\$1047	\$1068

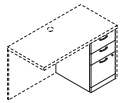

Not available in two-tone laminate

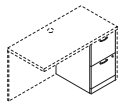

Not available in two-tone laminate

NOTES:

- Pedestals can be reconfigured quickly and easily when user preferences or space needs change.
- File drawers accept hanging folders in letter or legal size.
- Narrow pedestal features a compact design that is ideal for use in U- and L-shaped layouts for smaller spaces, such as a 5' x 8' U-shaped workstation or a 5' x 5' L-shaped workstation.
- Pedestal drawers operate on full extension, ball-bearing suspensions to ensure smooth, quiet, long-lasting operation.
- Handle options shown on page 146.
- Pedestal sides are notched to enable the routing of cords and cables.
- Mobile pedestals shown on page 167, work well in a variety of configurations.
- Pedestal models ship assembled unless designated
- Modular pedestals to be used with 24"D, 30"D and 36"D Modular Shells.
- Pedestal models not designed to be used freestanding.
- See pages 151-153 for desk, credenza and return shells.

HOW TO SPECIFY

Select Model Number

H 1 1 5 0 1

Select Handle Option

Linear handles "G" and "J" not available on model H115093
See page 146

C

Select Laminate

See page 146

N

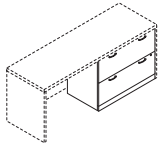

Not available in two-tone laminate

DESCRIPTION

Lateral File Pedestal (with core removable lock) — floor-standing
 36"W x 20"D x 28"H — for use under 24"D, 30"D and 36"D desk, credenza and return shells

MODEL

H11503

SHIP WEIGHT

127

CUBE

15.6

LIST PRICE BY LAMINATE GRADE

L1

\$1705

L2

\$1747

NOTES: Hangrails included. **Unfinished top and back.** Mechanical interlock inhibits extension of more than one drawer at a time.

⚠ Not designed to be used freestanding.

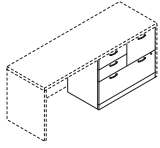

Not available in two-tone laminate

Multi File Pedestal (with core removable lock) — floor-standing
 36"W x 20"D x 28"H — for use under 24"D, 30"D and 36"D desk, credenza and return shells

H11505

155

15.6

\$2034

\$2076

NOTES: Versatile four drawer unit features one lateral file drawer, one vertical file drawer, and two box drawers. Box drawers do not lock. Hangrails included. **Unfinished top and back.** Mechanical interlock in lateral drawer inhibits extension of more than one drawer at a time.

⚠ Not designed to be used freestanding.

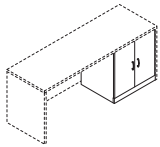

Not available in two-tone laminate

Cabinet Pedestal — floor-standing

26"W x 21 1/4"D x 28"H — for use under 24"D, 30"D and 36"D desk, credenza and return shells

H11508

78

12.2

\$1237

\$1279

NOTES: One adjustable shelf at 2 1/2" increments. Doors are non-locking. **Unfinished top and back.**

⚠ Not designed to be used freestanding.

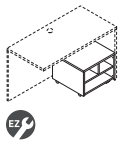

Mobile Printer/Fax Cart
 20"W x 19 7/8"D x 14 1/8"H

H105679

52

2.9

\$526

\$547

NOTES: Holds laser printers, inkjet printers or fax machines. Ideal for limited space. Low profile cart stores conveniently and easily under desks and workstations. Interior compartment shelving is Black. Four casters. **1 1/8" thick top with flat, non-profiled edge.**

SPECIFYING EXAMPLE: H105679.NN

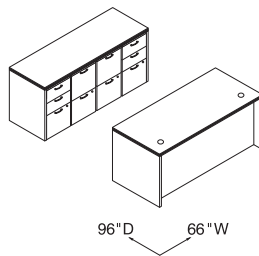

- 1 - H11579
- 1 - H11542
- 2 - H115102
- 2 - H115104

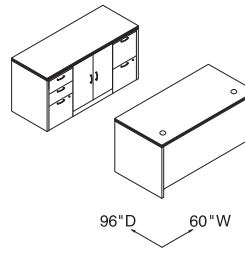

- 1 - H11578
- 1 - H11564
- 1 - H11502
- 1 - H11504
- 1 - H11508

NOTES:

- Pedestals can be reconfigured quickly and easily when user preferences or space needs change.
- See page 146 for handle design/finish options.
- File drawers accept hanging folders in letter or legal size.
- Pedestal drawers operate on full extension, ball-bearing suspensions to ensure smooth, quiet, long-lasting operation.
- Pedestal sides are notched to enable the routing of cords and cables.
- Mobile pedestals shown on page 167, work well in a variety of configurations.
- Pedestal models ship assembled unless designated ⚠.
- See pages 151-153 for desk, credenza and return shells.

HOW TO SPECIFY

<p>Select Model Number</p> <p>H 1 1 5 0 3</p>	<p>Select Handle Option</p> <p>See page 146 Not specified for model H105679</p> <p>C</p>	<p>Select Laminate</p> <p>See page 146</p> <p>N</p>
--	---	--

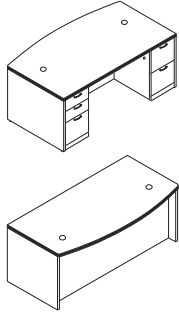

DESCRIPTION	FULL WIDTH OVERHANG	MODEL	SHIP WEIGHT	CUBE	LIST PRICE BY LAMINATE GRADE	
					L1	L2
Double Pedestal Desk						
72"W x 36"D x 29½"H, Bow Top	10½"	H115899	362	52.2	\$3523	\$3607
72"W x 36"D x 29½"H, Rectangle Top	10½"	H115890	370	52.2	\$3352	\$3431
66"W x 30"D x 29½"H, Rectangle Top	4½"	H115891	312	40.9	\$3224	\$3292
60"W x 30"D x 29½"H, Rectangle Top	4½"	H115892	303	37.3	\$3062	\$3125

NOTES: All drawers lock. Two worksurface grommets to route/hide cords. See pages 709-710 for optional center drawers. Bow top model measures 36"D at the crest and 30" along the end panels.

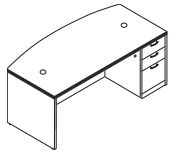

Single Pedestal Desk, Bow Top

72"W x 36"D x 29½"H, Right	10½"	H115893R	308	52.2	\$3091	\$3165
72"W x 36"D x 29½"H, Left	10½"	H115894L	308	52.2	\$3091	\$3165

NOTES: Box/box/file drawer configuration. Drawers lock. Two worksurface grommets to route/hide cords. See pages 709-710 for optional center drawers. Bow top model measures 36"D at the crest and 30" along the end panels.

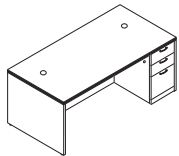

Single Pedestal Desk, Rectangle Top

72"W x 36"D x 29½"H, Right	10½"	H115895R	316	52.2	\$2893	\$2967
66"W x 30"D x 29½"H, Right	4½"	H115897R	269	40.9	\$2628	\$2686
72"W x 36"D x 29½"H, Left	10½"	H115896L	316	52.2	\$2893	\$2967
66"W x 30"D x 29½"H, Left	4½"	H115898L	269	40.9	\$2628	\$2686

NOTES: Box/box/file drawer configuration. Drawers lock. Two worksurface grommets to route/hide cords. See pages 709-710 for optional center drawers.

NOTES:

- Full pedestal design provides a more formal styling aesthetic and maximizes storage space.
- Drawers in pedestal extend from underside of worksurface to the floor.
- Tops are abrasion- and stain-resistant laminate over extra-thick 1½" solid core high-performance particleboard; resists warping.
- 3" round worksurface grommet can be replaced with optional Power Hub (model HGRMTAC) or Power/USB Hub (model HGRMTUSB2) to bring the ease of plug-and-play to the desktop. See page 723.
- Recessed modesty panel design facilitates conferencing. See approach side illustration at left.
- Full height modesty panels.
- Drawers operate on full extension, ball-bearing suspensions to ensure smooth, quiet, long-lasting operation.
- See page 146 for handle design/finish options.
- File drawer design includes integrated hangrails for side-to-side letter or legal filing; and front-to-back for letter filing.
- All drawers are 5-sided construction, which allows easy drawer alignment or replacement of drawer fronts.
- Desk, credenza and return models ship assembled.
- For conference table options, see the Preside® table tops and bases in the Tables section in the 2023 Shared Spaces Pricer. Order edge option "K".
- See pages 160-171 for shared components.

HOW TO SPECIFY

Select Model Number H 1 1 5 8 9 9	Select Edge Profile See page 146 A	Select Handle Option See page 146 C	Select Laminate See page 146 NN
---	---	--	--

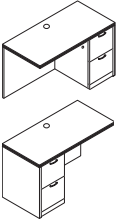
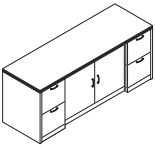
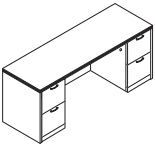
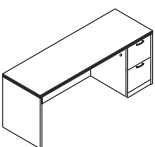

	DESCRIPTION	FULL WIDTH OVERHANG	MODEL	SHIP WEIGHT	CUBE	LIST PRICE BY LAMINATE GRADE	
						L1	L2
	Return, File/File						
	48"W x 24"D x 29½"H, Right		H115905R	168	24.9	\$1921	\$1963
	42"W x 24"D x 29½"H, Right		H115907R	159	20.5	\$1900	\$1942
	48"W x 24"D x 29½"H, Left		H115906L	168	24.9	\$1921	\$1963
	42"W x 24"D x 29½"H, Left		H115908L	159	20.5	\$1900	\$1942
NOTES: Return is for use with single pedestal desks, desk shells, peninsulas or corner units. Drawers lock. One worksurface grommet and one cord pass-through grommet in top center of modesty panel to reach wall electrical outlets. See pages 163-164 for optional stack-on storage.							
	Credenza with Doors						
	72"W x 24"D x 29½"H	3½"	H115909	340	36.0	\$3507	\$3575
NOTES: All drawers lock. Doors are non-locking. One cord pass-through grommet in top center of modesty panel. Includes a fixed shelf located at the bottom of the center storage area. No intermittent shelf. See pages 163-164 for optional stack-on storage.							
	Credenza with Kneespace						
	72"W x 24"D x 29½"H	3½"	H115900	296	36.0	\$2989	\$3052
	66"W x 24"D x 29½"H	3½"	H115901	286	31.6	\$2843	\$2906
	60"W x 24"D x 29½"H	3½"	H115902	257	28.8	\$2752	\$2810
NOTES: All drawers lock. One cord pass-through grommet in top center of modesty panel. See pages 163-164 for optional stack-on storage.							
! Not designed to be used with Valido Series 22¾"D modular or mobile pedestals. Modesty/back panel is inset 3½".							
	Single Pedestal Credenza, File/File						
	72"W x 24"D x 29½"H, Right (shown)	3½"	H115903R	251	36.0	\$2460	\$2518
	72"W x 24"D x 29½"H, Left	3½"	H115904L	251	36.0	\$2460	\$2518
NOTES: Drawers lock. One cord pass-through grommet in top center of modesty panel. See pages 163-164 for optional stack-on storage.							
! Not designed to be used with Valido Series 22¾"D modular or mobile pedestals. Modesty/back panel is inset 3½".							

NOTES:

- Full pedestal design provides a more formal styling aesthetic and maximizes storage space.
- Drawers in pedestal extend from underside of worksurface to the floor.
- Tops are abrasion- and stain-resistant laminate over extra-thick 1½" solid core high-performance particleboard; resists warping.
- Recessed modesty panel design facilitates conferencing. See approach side illustration at left.
- Full height modesty panels.
- Drawers operate on full extension, ball-bearing suspensions to ensure smooth, quiet, long-lasting operation.
- See page 146 for handle design/finish options.
- File drawer design includes integrated hangrails for side-to-side letter or legal filing; and front-to-back for letter filing.
- All drawers are 5-sided construction, which allows easy drawer alignment or replacement of drawer fronts.
- Valido® 18¾"D modular and mobile pedestals can be positioned under credenza with kneespace and single pedestal credenza models.
- Desk, credenza and return models ship assembled.
- For conference table options, see the Preside® table tops and bases in the Tables section in the 2023 Shared Spaces Pricer. Order edge option "K".
- See pages 160-171 for shared components.

HOW TO SPECIFY

Select Model Number H 1 1 5 9 0 5 R .	Select Edge Profile See page 146 A .	Select Handle Option See page 146 C .	Select Laminate See page 146 N N
---	---	--	---



	DESCRIPTION	FULL WIDTH OVERHANG	MODEL	SHIP WEIGHT	CUBE	LIST PRICE BY LAMINATE GRADE	
						L1	L2
	Double Pedestal Desk						
	72"W x 36"D x 29½"H, Bow Top	10½"	H11595	356	52.2	\$2832	\$2916
	72"W x 36"D x 29½"H, Rectangle Top	10½"	H11593	364	52.2	\$2595	\$2674
	66"W x 30"D x 29½"H, Rectangle Top	4½"	H11571	304	40.9	\$2475	\$2543
	60"W x 30"D x 29½"H, Rectangle Top	4½"	H11573	288	37.3	\$2335	\$2398
	NOTES: All drawers lock. Two worksurface grommets to route/hide cords. See pages 709-710 for optional center drawers.						
	Single Pedestal Desk, Bow Top						
	72"W x 36"D x 29½"H, Right	10½"	H11587R	264	52.9	\$2496	\$2570
	72"W x 36"D x 29½"H, Left	10½"	H11588L	264	52.9	\$2496	\$2570
	NOTES: Drawers lock. Two worksurface grommets to route/hide cords. See pages 709-710 for optional center drawers. Bow top models measure 36"D at the crest and 30"D along the end panels.						
	Single Pedestal Desk, Rectangle Top						
	72"W x 36"D x 29½"H, Right	10½"	H11585R	303	52.2	\$2206	\$2274
	66"W x 30"D x 29½"H, Right	4½"	H11583R	247	40.9	\$2061	\$2119
	72"W x 36"D x 29½"H, Left	10½"	H11586L	303	52.2	\$2206	\$2274
	66"W x 30"D x 29½"H, Left	4½"	H11584L	247	40.9	\$2061	\$2119
	NOTES: Drawers lock. Two worksurface grommets to route/hide cords. See pages 709-710 for optional center drawers.						
	Small Office Desk						
48"W x 30"D x 29½"H	4½"	H115885R	183	30.0	\$1664	\$1706	
	NOTES: Small footprint makes this desk ideal for limited space. Drawers lock. One cord grommet in top for routing and hiding wires and cables. 3/4 length modesty panel facilitates reaching wall electrical outlets. Optional stack-on storage model H115323 maximizes storage space; see pages 163-164 for additional stack-on storage models.						
	Return, Box/File						
	48"W x 24"D x 29½"H, Right		H11515R	158	24.9	\$1605	\$1647
	42"W x 24"D x 29½"H, Right		H11511R	146	20.5	\$1588	\$1630
	48"W x 24"D x 29½"H, Left		H11516L	158	24.9	\$1605	\$1647
	42"W x 24"D x 29½"H, Left		H11512L	146	20.5	\$1588	\$1630
	NOTES: Return is for use with single pedestal desks, desk shells, peninsulas or corner units. Drawers lock. One worksurface grommet and one cord pass-through grommet in top center of modesty panel to reach wall electrical outlets. See pages 163-164 for optional stack-on storage.						
	❗ Not designed to be used freestanding.						
			H11584L H11515R H115327 H115520 H115523 HLVPM1				
						H11587R H115598 H115811 H11516L H115301	H115524 H115327 HLVPM1

NOTES:

- For components that can be shared with Valido Series, see pages 160-171.
- Tops are abrasion- and stain-resistant laminate over extra-thick 1½" solid core high-performance particleboard; resists warping.
- 3/4 pedestal design increases budget flexibility.
- Formal, full height modesty panels.
- 3" round worksurface grommet can be replaced with optional Power Hub (model HGRMTAC) or Power/USB Hub (model HGRMTUSB2) to bring the ease of plug-and-play to the desktop. See page 723.
- All drawers are 5-sided construction, which allows easy drawer alignment or replacement of drawer fronts.
- The small footprint of the Small Office Desk is ideal for limited space.

- Drawers operate on full extension, ball-bearing suspensions to ensure smooth, quiet, long-lasting operation.
- See page 146 for handle design/finish options.
- Center drawers conveniently store writing instruments, paper and other miscellaneous items. Includes pencil tray. See pages 709-710.
- File drawer design includes integrated hangrails for side-to-side letter or legal filing; and front-to-back for letter filing.
- Desk, credenza and return models ship assembled.
- See pages 163-164 for optional stack-on storage.
- For conference table options, see the Preside® table tops and bases in the Tables section in the 2023 Shared Spaces Pricer. Order edge option "K".

HOW TO SPECIFY

Select Model Number	Select Edge Profile	Select Handle Option	Select Laminate
See page 146	See page 146	See page 146	See page 146
H 1 1 5 9 5	A	C	NN



Laminate Wood Desks – 3/4 Pedestals

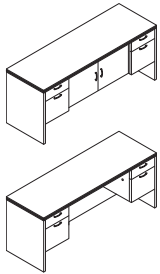

DESCRIPTION	FULL WIDTH OVERHANG	MODEL	SHIP WEIGHT	CUBE	LIST PRICE BY LAMINATE GRADE	
					L1	L2
Credenza with Doors 72"W x 24"D x 29½"H	3½"	H11544	294	36.0	\$2855	\$2923
Credenza with Kneespace 72"W x 24"D x 29½"H	3½"	H11543	259	36.0	\$2403	\$2466
66"W x 24"D x 29½"H	3½"	H11566	249	31.6	\$2335	\$2398
60"W x 24"D x 29½"H	3½"	H11565	239	28.8	\$2250	\$2308

NOTES: Includes one fixed shelf at the bottom of the center storage area. All drawers lock. Doors are non-locking.

NOTES: One cord pass-through grommet in top center of modesty panel to reach wall electrical outlets. All drawers lock. See pages 163-164 for optional stack-on storage.

⚠ Not designed to be used with Valido Series 22¾"D modular or mobile pedestals. Modesty/back panel is inset 3½".

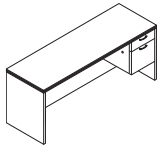

Credenza, Single Pedestal, Box/File 72"W x 24"D x 29½"H, Right (shown)	3½"	H11545R	228	36.0	\$2017	\$2075
72"W x 24"D x 29½"H, Left	3½"	H11546L	228	36.0	\$2017	\$2075

NOTES: One cord pass-through grommet in top center of modesty panel to reach wall electrical outlets. Drawers lock. See pages 163-164 for optional stack-on storage.

⚠ Not designed to be used with Valido Series 22¾"D modular or mobile pedestals. Modesty/back panel is inset 3½".

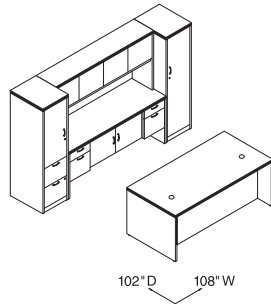

H11593
H11544
H115295R
H115298L
H11534

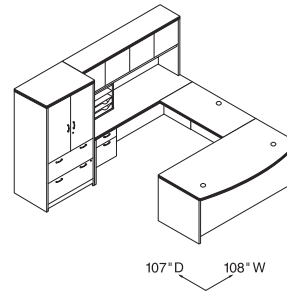

H11587R
H11570
H11546L
H11534
H115293
HLVPM1

NOTES:

- For components that can be shared with Valido/10500 Series, see pages 160-171.
- Tops are abrasion- and stain-resistant laminate over extra-thick 1½" solid core high-performance particleboard; resists warping.
- Formal, full height modesty panels.
- Cord management grommets, for routing and hiding wires and cables, are located in the tops of desks, returns, bridges and corner units.
- All drawers are 5-sided construction, which allows easy drawer alignment or replacement of drawer fronts.
- Drawers operate on full extension, ball-bearing suspensions to ensure smooth, quiet, long-lasting operation.
- See page 146 for handle design/finish options.
- File drawer design includes integrated hangrails for side-to-side letter or legal filing; and front-to-back for letter filing.
- For conference table options, see the Preside® table tops and bases in the Tables section in the 2023 Shared Spaces Pricer. Order edge option "K".

HOW TO SPECIFY

<p>Select Model Number</p> <p>H 1 1 5 4 4 .</p>	<p>Select Edge Profile</p> <p>See page 146</p> <p>A .</p>	<p>Select Handle Option</p> <p>See page 146</p> <p>C .</p>	<p>Select Laminate</p> <p>See page 146</p> <p>N N</p>
--	--	---	--

VALIDO®

Shared Components & Accessories

GSA SIN 33721

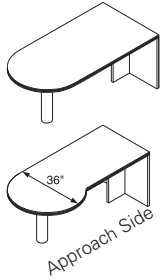

Icon Legend on page 19

**DESCRIPTION****Peninsula w/End Panel**

72"W x 36"D x 29½"H
66"W x 30"D x 29½"H
60"W x 30"D x 29½"H

MODEL**SHIP WEIGHT****CUBE****LIST PRICE BY LAMINATE GRADE****L1****L2**

H11521E
H11522E
H11523E

167
138
115

8.1
6.6
6.6

\$1554
\$1417
\$1317

\$1602
\$1465
\$1365

P-shaped Peninsula w/End Panel

72"W x 30/36"D x 29½"H, Right
72"W x 36/30"D x 29½"H, Left

H11525RE
H11526LE

159
159

8.1
8.1

\$1729
\$1729

\$1777
\$1777

NOTES: Use for "U" or "L" configuration. 60"W ideal for smaller spaces. Cord routing notch in brace panel. Accept field installable modesty panel model H10528 (see page 161). See pages 709-710 for optional center drawers. Peninsulas ship complete with end panel and support column. Support column is black.

❗ Not designed to be used freestanding.

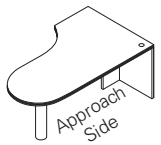

Right-hand model
H115201RE shown

Jetty Peninsula w/End Panel

72"W x 30/42"D x 29½"H, Right
72"W x 42/30"D x 29½"H, Left

H115201RE
H115202LE

175
175

9.4
9.4

\$2006
\$2006

\$2064
\$2064

NOTES: For use in "U" or "L" configuration. Designed and sized to efficiently serve as both a computing and conferencing space. One cord management grommet in the top; cord routing notch in brace panel. Jetty units manufactured on or after 10/24/2005 accept field installable modesty panel H10528 (see page 161). Peninsulas ship complete with end panel and support column. Support column is black.

❗ Not designed to be used freestanding.

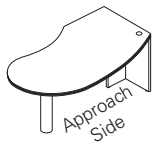
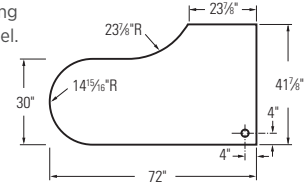

Right-hand model
H115203RE shown

Boomerang Peninsula w/End Panel

72"W x 30/42"D x 29½"H, Right
72"W x 42/30"D x 29½"H, Left

H115203RE
H115204LE

175
175

9.4
9.4

\$2006
\$2006

\$2064
\$2064

NOTES: For use in "U" or "L" configuration. Designed and sized to efficiently serve as both a computing and conferencing space. One cord management grommet in the top; cord routing notch in brace panel. Accepts field installable modesty panel H10528 (see page 161). Peninsulas ship complete with end panel and support column. Support column is black.

❗ Not designed to be used freestanding.

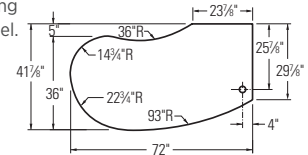
**NOTES:**

- Shared components shown on this page can be used with modular components shown on pages 151-155, full pedestal models shown on pages 156-157, and 3/4 pedestal models shown on pages 158-159.
- Mobile pedestals shown on page 167 work well in a variety of configurations.
- Peninsulas ship complete with end panel and black 3" diameter support column. For a silver support column option, please see model HPC191X on page 263 (ordered separately).
- Jetty and Boomerang peninsulas are designed and sized to efficiently serve as both a computing and conferencing space.
- Adjustable hex leveling glides allow floor-standing furniture to be easily leveled; glides have 3/4" adjustable range.
- For conference table options, see the Preside® table tops and bases in the Tables section in the 2023 Shared Spaces Pricer. Order edge option "K".
- See pages 160-171 for shared components.

HOW TO SPECIFY

Select Model Number	Select Edge Profile	Select Laminate	Select Paint Color
See page 146	See page 146	See page 146	P Black
H 1 1 5 2 1 E .	A .	N N .	P



DESCRIPTION	MODEL	SHIP WEIGHT	CUBE	LIST PRICE BY LAMINATE GRADE	
				L1	L2
Field Installable Modesty Panel for Peninsulas 50¼"W x ¾"Thick x 18"H NOTES: Center drawer model H1522 can be used in conjunction with modesty panel. Laminate Modesty Panel has a cord pass-through notch in top corner. ⓘ Not designed to be used on jetty peninsulas manufactured prior to 10/24/2005. SPECIFYING EXAMPLE: H10528.N	H10528	25	1.3	\$238	\$249



DESCRIPTION	MODEL	SHIP WEIGHT	CUBE	LIST PRICE
Field Installable Modesty Panel for Bullet, Jetty and Boomerang Peninsulas, Frosted with Silver Frame 50¼"W x ¾"Thick x 18"H NOTES: For use on 72"W peninsulas. Frosted/silver modesty panel HPC180G can be used with Valido and 10500 Series™ peninsula models. Cord pass-through notch is not available on the Frosted/Silver model HPC180G. Notch is on laminate model H10528 only. ⓘ Center drawers not designed to be used with the frosted/silver modesty panel model HPC180G.	HPC180G	33 ⓘ	1.5	\$941

NOTES:

- Shared components shown on this page can be used with modular components shown on pages 151-155, full pedestal models shown on pages 156-157, and 3/4 pedestal models shown on pages 158-159.
- For conference table options, see the Preside® table tops and bases in the Tables section in the 2023 Shared Spaces Pricer. Order edge option "K".
- See pages 160-171 for shared components.

HOW TO SPECIFY

Select Model Number H 1 0 5 2 8 .	Select Laminate See page 146 N N
--------------------------------------	--

VALIDO®

Shared Components & Accessories

GSA SIN 33721



Icon Legend on page 19



DESCRIPTION	MODEL	SHIP WEIGHT	CUBE	LIST PRICE BY LAMINATE GRADE	
				L1	L2
Bridge (Single Ped. Desk, Desk Shell or Peninsula, to Corner Unit, Single Ped. Credenza or Credenza Shell)					
47"W x 24"D x 29½"H, (Clear inside depth = 21⅞"D)	H11570	86	3.2	\$732	\$764
42"W x 24"D x 29½"H, (Clear inside depth = 21⅞"D)	H11560	81	2.9	\$700	\$732
36"W x 24"D x 29½"H, (Clear inside depth = 21⅞"D) (see notes below)	H115599	69	2.9	\$700	\$732
30"W x 24"D x 29½"H, (Clear inside depth = 21⅞"D) (see notes below)	H115598	57	2.2	\$700	\$732
47"W x 20"D x 29½"H, (Clear inside depth = 17⅞"D) (see notes below)	H115699	70	3.2	\$700	\$732
42"W x 20"D x 29½"H, (Clear inside depth = 17⅞"D) (see notes below)	H115698	62	2.9	\$670	\$702

NOTES: One worksurface grommet and one grommet in top and in top center of modesty panel. Grommet can be replaced with optional Power Hub or Power/USB Hub for easy plug-and-play (see page 723). Kneespace of desk limited to 24¾"W if bridge is used with 66"W single pedestal desk. H115599 is for use with corner or extended corner units or jetty or boomerang peninsulas. H115598 is for use with corner or extended corner units. H115699 and H115698 are for use with single pedestal desks, desk shells or peninsulas (excluding jetty and boomerang).

Specify: Model.Edge.Laminate

SPECIFYING EXAMPLE: H11570.A.NN

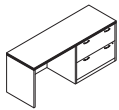

Credenza with 36" Lateral (with core removable locks)

72"W x 24"D x 29½"H, Right (shown)	H11547R	264	36.0	\$2578	\$2641
72"W x 24"D x 29½"H, Left	H11548L	264	36.0	\$2578	\$2641

NOTES: Includes hangrails. Mechanical interlock inhibits the extension of more than one drawer at a time. See pages 163-164 for optional stack-on storage.

⚠ Not designed to be used with Valido Series 22¾"D modular or mobile pedestals. Modesty/back panel is inset 3½".

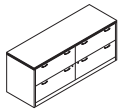

Credenza with two Lateral Files (with core removable locks)

72"W x 24"D x 29½"H	H115491	330	36.0	\$3614	\$3693
---------------------	----------------	-----	------	---------------	---------------

NOTES: 4 locking drawers. Each lock secures 2 drawers. Includes hangrails; mechanical interlock inhibits the extension of more than one drawer at a time. If side-by-side drawers are opened or closed simultaneously, one drawer may interfere with the other. See pages 163-164 for optional stack-on storage.

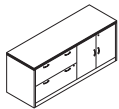

Credenza with Lateral File, left and Storage Cabinet, right (with core removable locks)

72"W x 24"D x 29½"H	H115492	323	36.0	\$3277	\$3356
---------------------	----------------	-----	------	---------------	---------------

NOTES: Includes hangrails; mechanical interlock inhibits the extension of more than one drawer at a time. Storage cabinet locks and includes one adjustable interior shelf. Shelf adjusts in 1¼" increments with a total range of 5"H. See pages 163-164 for optional stack-on storage.

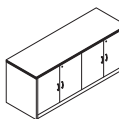

Credenza w/Two Storage Cabinets

72"W x 24"D x 29½"H	H115493	320	35.6	\$2909	\$2988
---------------------	----------------	-----	------	---------------	---------------

NOTES: Each storage cabinet has one interior shelf which adjusts in 1¼" increments over a total range of 5". Each cabinet locks independently. Locks are keyed alike. For optional stack-on storage, see pages 163-164 for additional stack-on storage models.

NOTES:

- Shared components shown on this page can be used with modular components shown on pages 151-155, full pedestal models shown on pages 156-157, and 3/4 pedestal models shown on pages 158-159.
- Mobile pedestals shown on page 167 work well in a variety of configurations.
- Locking units equipped with interchangeable core removable locks.
- File drawers accept hanging folders in letter or legal size.
- See page 146 for handle design/finish options.
- Adjustable hex leveling glides allow floor-standing furniture to be easily leveled; glides have ¾" adjustable range.
- See pages 160-171 for shared components.

⚠ Keyed alike cores must be ordered separately — see page 699.

HOW TO SPECIFY

Select Model Number See page 146 H 1 1 5 4 7 R .	Select Edge Profile See page 146 A .	Select Handle Option See page 146 Not specified on Bridge models C .	Select Laminate See page 146 NN
--	--	---	---

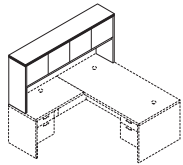
**DESCRIPTION****Stack-on Storage for an "L" Workstation**78"W x 14⁵/₈"D x 37¹/₂"H

MODEL	SHIP WEIGHT	CUBE	LIST PRICE BY LAMINATE GRADE	
			L1	L2

H115327	209	17.6	\$2077	\$2145
----------------	-----	------	---------------	---------------

Stack-on Storage for an "L" Workstation, Locking78"W x 14⁵/₈"D x 37¹/₂"H

H115327K	209	17.6	\$2194	\$2262
-----------------	-----	------	---------------	---------------

NOTES: Spans the total depth dimension of configurations comprised of: 48"W return or return shell attached to a 30"D single pedestal desk, desk shell or peninsula (78"D); 42"W return or return shell attached to a 36"D single pedestal desk, desk shell or peninsula (78"D). 42"W return or return shell attached to a 36" corner unit (78"D); or 42"W curved return attached to 36" curved corner unit (78"D). Use back enclosure model H105857 and tackboard model H90057 (see page 165). Use task light models HH870960, or HH870960CH (see page 714). For vertical paper manager model HLVPM1, see page 715.

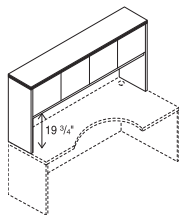
**Stack-on Storage (See page 165 for Back Enclosures and Fabric Tackboards)**72"W x 14⁵/₈"D x 37¹/₂"H, 4 doors (Use Task Light model HH870960, see page 714)

H11534	195	16.9	\$1868	\$1926
---------------	-----	------	---------------	---------------

66"W x 14⁵/₈"D x 37¹/₂"H, 4 doors (Use Task Light model HH870960, see page 714)

H11533	184	15.3	\$1824	\$1882
---------------	-----	------	---------------	---------------

60"W x 14⁵/₈"D x 37¹/₂"H, 4 doors (Use Task Light model HH870960, see page 714)

H115324	172	14.0	\$1746	\$1804
----------------	-----	------	---------------	---------------

48"W x 14⁵/₈"D x 37¹/₂"H, 3 doors (Use Task Light model HH870942, see page 714)

H115323	148	11.3	\$1519	\$1567
----------------	-----	------	---------------	---------------

42"W x 14⁵/₈"D x 37¹/₂"H, 2 doors (Use Task Light model HH870942, see page 714)

H115322	141	4.0	\$1307	\$1355
----------------	-----	-----	---------------	---------------

36"W x 14⁵/₈"D x 37¹/₂"H, 2 doors (Use Task Light model HH870930, see page 714)

H115321	107	3.5	\$1252	\$1294
----------------	-----	-----	---------------	---------------

Stack-on Storage, Locking (See page 165 for Back Enclosures and Fabric Tackboards)72"W x 14⁵/₈"D x 37¹/₂"H, 4 doors (Use Task Light model HH870960, see page 714)

H11534K	195	16.9	\$1988	\$2046
----------------	-----	------	---------------	---------------

66"W x 14⁵/₈"D x 37¹/₂"H, 4 doors (Use Task Light model HH870960, see page 714)

H11533K	184	15.3	\$1942	\$2000
----------------	-----	------	---------------	---------------

60"W x 14⁵/₈"D x 37¹/₂"H, 4 doors (Use Task Light model HH870960, see page 714)

H115324K	172	14.0	\$1865	\$1923
-----------------	-----	------	---------------	---------------

48"W x 14⁵/₈"D x 37¹/₂"H, 3 doors (Use Task Light model HH870942, see page 714)

H115323K	148	11.3	\$1608	\$1656
-----------------	-----	------	---------------	---------------

42"W x 14⁵/₈"D x 37¹/₂"H, 2 doors (Use Task Light model HH870942, see page 714)

H115322K	141	4.0	\$1366	\$1414
-----------------	-----	-----	---------------	---------------

36"W x 14⁵/₈"D x 37¹/₂"H, 2 doors (Use Task Light model HH870930, see page 714)

H115321K	107	3.5	\$1312	\$1354
-----------------	-----	-----	---------------	---------------

NOTES: Models H11534 and H11534K can be used for "L" configuration comprised of 30"D desk, desk shell or peninsula and 42"W return or return shell. Model H115323K has one lock which secures two of the three doors. For vertical paper manager, see page 715.

NOTES:

- Shared components shown on this page can be used with modular components shown on pages 151-155, full pedestal models shown on pages 156-157, and 3/4 pedestal models shown on pages 158-159.
- Stack-on storage models are equipped with self-closing, adjustable hinged doors and valance to hide task light.
- For work-in-process paper management tools, see pages 715-717.
- See pages 160-171 for shared components.

! Removable lock core kit for stack-on and wall mount storage is model HF27B, see page 699.

! The HON Company is not responsible for any liabilities resulting from wall mounted storage cabinets that are not properly installed.

HOW TO SPECIFY

Select Model Number <div style="border: 1px solid black; padding: 2px; display: flex; gap: 5px;"> H11534 </div>	Select Edge Profile See page 146 <div style="border: 1px solid black; padding: 2px; display: flex; gap: 5px;"> A </div>	Select Laminate See page 146 <div style="border: 1px solid black; padding: 2px; display: flex; gap: 5px;"> NN </div>
---	---	---

VALIDO® Shared Components & Accessories

GSA SIN 33721



Icon Legend on page 19

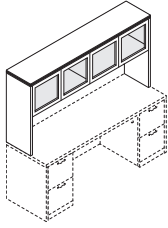

DESCRIPTION	MODEL	SHIP		LIST PRICE BY LAMINATE GRADE	
		WEIGHT	CUBE	L1	L2
Stack-on Storage for an "L" Workstation, Frosted Doors with Silver Frame 78"W x 14 ⁵ / ₈ "D x 37 ¹ / ₂ "H, 4 doors (Use Task Light model HH870960, see page 714)	H115327G	210	18.4	\$3072	\$3125
NOTES: Spans the total depth dimension of configurations comprised of: 48"W return or return shell attached to a 30"D single pedestal desk, desk shell or peninsula (78"D); 42"W return or return shell attached to a 36"D single pedestal desk or desk shell with a rectangle top, or to a peninsula (78"D). 42"W return or return shell attached to a 36" corner unit (78"D); 42"W curved return attached to 36" curved corner unit (78"D); or 36"W return shell attached to a jetty peninsula (78"D). Use back enclosure model H105857 and tackboard model H90057. Use task light models HH870960 or HH870960CH. For vertical paper manager model HLVPM1, see page 715.					
Stack-on Storage, w/Frosted Doors with Silver Frame 72"W x 14 ⁵ / ₈ "D x 37 ¹ / ₂ "H, 4 doors (Use Task Light model HH870960, see page 714)	H11534G	196	17.0	\$2855	\$2897
66"W x 14 ⁵ / ₈ "D x 37 ¹ / ₂ "H, 4 doors (Use Task Light model HH870960, see page 714)	H11533G	185	15.6	\$2808	\$2850
60"W x 14 ⁵ / ₈ "D x 37 ¹ / ₂ "H, 4 doors (Use Task Light model HH870960, see page 714)	H115324G	173	14.2	\$2727	\$2769
48"W x 14 ⁵ / ₈ "D x 37 ¹ / ₂ "H, 3 doors (Use Task Light model HH870942, see page 714)	H115323G	148	11.5	\$2261	\$2293
42"W x 14 ⁵ / ₈ "D x 37 ¹ / ₂ "H, 2 doors (Use Task Light model HH870942, see page 714)	H115322G	141	4.1	\$1813	\$1845
36"W x 14 ⁵ / ₈ "D x 37 ¹ / ₂ "H, 2 doors (Use Task Light model HH870930, see page 714)	H115321G	107	4.1	\$1754	\$1781
NOTES: For respective desk, credenza or return widths. Model 11534 can be used for "L" configuration comprised of a 42"W return or return shell attached to a 30"D single pedestal desk, desk shell or peninsula (72"); 36"W return shell attached to a 36"D single pedestal desk, desk shell or peninsula (72"); or 30"W return shell attached to a jetty peninsula (72"). Back enclosures, tackboards for use with back enclosures and task lights are available as options. See vertical paper manager model HLVPM1 on page 715. Stack-on Storage models H115327G, H11534G, H11533G and H115324G use task light model HH870960. Models H115323G and H115322G use task light model HH870942 and model H115321G uses task light model HH870930. All task lights can be found on page 714.					

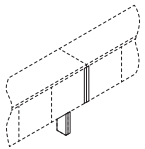

Stack-on Storage Clearance End Panel Kit 1 ¹ / ₈ "W x 4 ⁵ / ₈ -14 ⁵ / ₈ "D x 36"H	H105349	29	3.4	\$446	\$462
Two field installable end panels (1-right; 1-left) for use in ganging two 10500 or Valido® Series stack-on storage units. See page 284. NOTES: Can be used to connect up to two stack-on storage units in a line (requires 1 kit). Not available in two-tone laminate.					
SPECIFYING EXAMPLE: H105349.N					

NOTES:

- Shared components shown on this page can be used with modular components shown on pages 151-155, full pedestal models shown on pages 156-157, and 3/4 pedestal models shown on pages 158-159.
- Stack-on storage models are equipped with self-closing, adjustable hinged doors and valance to hide task light.
- For work-in-process paper management tools, see pages 715-717.
- See pages 160-171 for shared components.

❗ Removable lock core kit for stack-on and wall mount storage is model HF27B, see page 699.

❗ The HON Company is not responsible for any liabilities resulting from wall mounted storage cabinets that are not properly installed.

HOW TO SPECIFY

Select Model Number H 1 1 5 3 2 7 G .	Select Edge Profile See page 146 A .	Select Laminate See page 146 N N
---	---	---

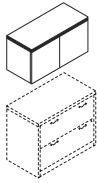

DESCRIPTION

Wall Mounted Storage Cabinet

30"W x 14 5/8"D x 17 7/8"H, 2 doors
(Use Task Light model HH870930, see page 714)
36"W x 14 5/8"D x 17 7/8"H, 2 doors
(Use Task Light model HH870930, see page 714)
42"W x 14 5/8"D x 17 7/8"H, 2 doors
(Use Task Light model HH870942, see page 714)
48"W x 14 5/8"D x 17 7/8"H, 3 doors
(Use Task Light model HH870942, see page 714)

Wall Mounted Storage Cabinet, Locking

30"W x 14 5/8"D x 17 7/8"H, 2 doors
(Use Task Light model HH870930, see page 714)
36"W x 14 5/8"D x 17 7/8"H, 2 doors
(Use Task Light Model HH870930, see page 714)
42"W x 14 5/8"D x 17 7/8"H, 2 doors
(Use Task Light Model HH870942, see page 714)
48"W x 14 5/8"D x 17 7/8"H, 3 doors
(Use Task Light Model HH870942, see page 714)

NOTES: Horizontal interlocking rails are included; due to varying types of walls, installers are responsible for selecting and supplying the appropriate fasteners. Tackboard widths differ slightly from wall mounted storage cabinet widths. For applications where multiple wall mounted storage cabinets are placed side-by-side, the preferred tackboard solution may be to utilize a larger tackboard size. For example, H90057 = 75"W; H90056 = 68 3/4"W; H90055 = 62 1/4"W; H90054 = 56 3/4"W. For paper organizer tools, see pages 715-717.

MODEL	COM	SHIP WEIGHT	CUBE	LIST PRICE BY LAMINATE GRADE	
				L1	L2
H115380		77	8.7	\$1262	\$1299
H115381		92	10.2	\$1328	\$1365
H115382		103	11.7	\$1428	\$1465
H115383		121	14.0	\$1544	\$1581
H115380K		77	8.7	\$1322	\$1359
H115381K		92	10.2	\$1388	\$1425
H115382K		103	11.7	\$1489	\$1526
H115383K		121	14.0	\$1635	\$1672

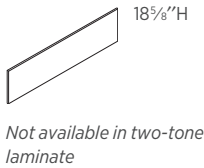

Back Enclosure for Stack-on Storage

75 3/4"W - for 78"W model #H115327
69 3/4"W - for 72"W model #H11534
63 3/4"W - for 66"W model #H11533
57 3/4"W - for 60"W model #H115324
45 3/4"W - for 48"W model #H115323
39 3/4"W - for 42"W model #H115322
33 3/4"W - for 36"W model #H115321

NOTES: Non-tackable. Specify laminate.

SPECIFYING EXAMPLE: H105857.N

H105857		39	1.4	\$321	\$332
H105856		33	1.3	\$295	\$306
H105855		31	1.3	\$275	\$286
H105854		29	1.3	\$262	\$273
H105853		23	0.9	\$262	\$273
H105852		21	0.9	\$250	\$261
H105851		18	0.9	\$237	\$248

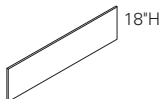

DESCRIPTION

Tackboards for use with Stack-on Back Enclosures

75"W - for 78"W model #H115327 Hutch with #H105857 Enclosure
68 3/4"W - for 72"W model #H11534 Hutch with #H105856 Enclosure
62 3/4"W - for 66"W model #H11533 Hutch with #H105855 Enclosure
56 3/4"W - for 60"W model #H115324 Hutch with #H105854 Enclosure
44 3/4"W - for 48"W model #H115323 Hutch with #H105853 Enclosure
39"W - for 42"W model #H115322 Hutch with #H105852 Enclosure
33"W - for 36"W model #H115321 Hutch with #H105851 Enclosure

NOTES: Specify fabric, see pages 25-26. Upcharges may apply to premium fabric grades.

ⓘ Disperse (DISP) fabric not available on sizes wider than 60". Analog (ANLG) and Exchange (EXG) not available on sizes wider than 60".

ⓘ Back Enclosures must be ordered separately.

SPECIFYING EXAMPLE: H90057.APN15

MODEL	COM	SHIP WEIGHT	CUBE	LIST PRICE
H90057	3.0	13	3.2	\$427
H90056	2.0	12	2.7	\$405
H90055	2.0	11	2.5	\$385
H90054	2.0	10	2.2	\$339
H90053	2.0	8	1.8	\$325
H90052	2.0	7	1.6	\$300
H90051	1.0	6	1.4	\$264

NOTES:

- Shared components shown on this page can be used with modular components shown on pages 151-155, full pedestal models shown on pages 156-157, and 3/4 pedestal models shown on pages 158-159.
- Back enclosure features full-width 1 1/8" slot at the bottom to facilitate routing cords and reaching wall electrical outlets.
- Tackboard is sized 3/4" narrower than stack-on storage back enclosure, allowing 3/8" on each side to route task light cord.
- Wall mounted storage cabinet attachment requires individual cabinets be secured by a minimum of two wall mounting locations/studs.
- Wall mounted storage cabinets are designed for interior and perimeter walls that are constructed with wood or metal studs.
- Wall attachment methodology: horizontally mounted, interlocking brackets.
- Wall mounted storage cabinet door design overlaps end panels so that when multiple units are placed side-by-side they appear as one continuous unit.
- See pages 160-171 for shared components.

ⓘ Removable lock core kit for stack-on and wall mount storage is model HF27B, see page 699.

ⓘ The HON Company is not responsible for any liabilities resulting from wall mounted storage cabinets that are not properly installed.

HOW TO SPECIFY

<p>Select Model Number</p> <p>H 1 1 5 3 8 0</p>	<p>Select Edge Profile</p> <p>See page 146</p> <p>A</p>	<p>Select Laminate</p> <p>See page 146</p> <p>NN</p>
---	---	--

VALIDO® Shared Components & Accessories

GSA SIN 33721



Icon Legend on page 19

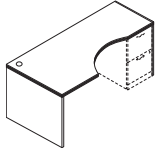

Right-hand model
H115815R shown

DESCRIPTION

Extended Corner Unit

24"W x 36"D x 72"W x 24"D x 29½"H, Right (shown)
24"D x 72"W x 36"D x 24"W x 29½"H, Left

MODEL	SHIP WEIGHT	CUBE	LIST PRICE BY LAMINATE GRADE	
			L1	L2
H115815R	203	7.0	\$1892	\$1940
H115816L	203	7.0	\$1892	\$1940

NOTES: Can be used freestanding. One grommet in top and in modesty panel. Accept Valido Series modular or mobile pedestals. See pages 163-164 for optional stack-on storage.

⚠ Designed to be used with returns or bridges.

SPECIFYING EXAMPLE: H115815R.A.NN

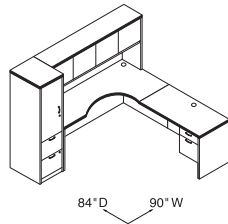
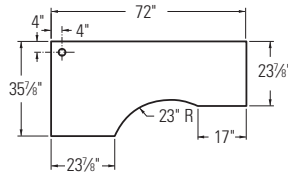

H115298L
H115816L
H11534
H11515R

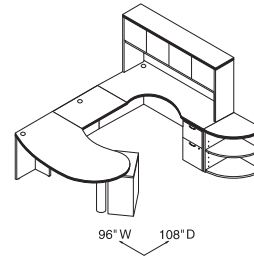

H115103
H115204L
H115598
H115815R
H115104
H11534
H115520

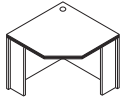

Corner Unit

24" x 36" x 36" x 24" x 29½"H

H115811	141	3.1	\$1304	\$1341
----------------	-----	-----	---------------	---------------

NOTES: Can be used freestanding.

⚠ Designed to be used with 24"D x 29½"H returns or bridges.

SPECIFYING EXAMPLE: H115811.A.NN

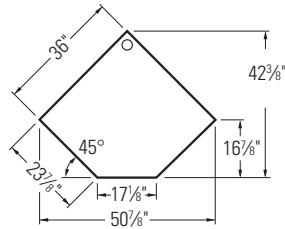









NOTES:

- Shared components shown on this page can be used with modular components shown on pages 151-155, full pedestal models shown on pages 156-157, and 3/4 pedestal models shown on pages 158-159.
- Mobile pedestals, shown on page 167, work well in a variety of configurations.
- Extended corner units (H115815R and H115816L) can be used with 36"W return shell (H115680) to achieve a 6' x 6' layout.
- 36" corner unit (H115811) can be used with two 36"W return shells (H115680) to achieve a 6' x 6' layout.
- For conference table options, see the Preside® table tops and bases in the Tables section in the 2023 Shared Spaces Pricer. Order edge option "K".
- For work-in-process paper management tools, see pages 715-717.
- See pages 160-171 for shared components.

HOW TO SPECIFY

<p>Select Model Number</p> <p>H 1 1 5 8 1 7 R .</p>	<p>Select Edge Profile</p> <p>See page 146</p> <p>A .</p>	<p>Select Laminate</p> <p>See page 146</p> <p>NN</p>
--	--	---



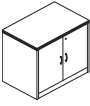
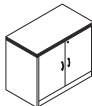
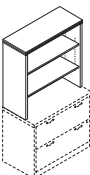



	DESCRIPTION	MODEL	SHIP WEIGHT	CUBE	LIST PRICE BY LAMINATE GRADE	
					L1	L2
	Mobile Pedestal (with core removable lock) — Box/Box/File 15 ³ / ₄ "W x 22 ³ / ₄ "D x 28 ³ / ₈ "H — use freestanding or under 24"D, 30"D and 36"D modular shells	H115102	121	8.4	\$1359	\$1401
	NOTES: Top box drawer does not lock.					
	Mobile Pedestal (with core removable lock) — File/File 15 ³ / ₄ "W x 22 ³ / ₄ "D x 28 ³ / ₈ "H — use freestanding or under 24"D, 30"D and 36"D modular shells	H115104	121	8.4	\$1359	\$1401
	Mobile Pedestal (with core removable lock) — Box/File 15 ³ / ₄ "W x 18 ³ / ₄ "D x 21 ¹ / ₈ "H — use freestanding or under 20"D, 24"D, 30"D and 36"D modular shells	H115106	68	5.8	\$1139	\$1171
	Mobile Pedestal — Shelf/Box/File 15 ³ / ₄ "W x 18 ³ / ₄ "D x 28 ³ / ₈ "H — use freestanding or under 20"D, 24"D, 30"D and 36"D modular shells	H115109	76	7.3	\$1249	\$1291
	NOTES: All mobile pedestals have a 1 ¹ / ₈ " thick top with flat, non-profiled edge. SPECIFYING EXAMPLE: H115102.C.NN					
	Lateral File (with core removable lock) 36"W x 24"D x 29 ¹ / ₂ "H — two drawer	H115690	199	18.4	\$1903	\$1961
	36"W x 20"D x 29 ¹ / ₂ "H — two drawer	H11563	177	15.6	\$1813	\$1866
	36"W x 20"D x 45 ¹ / ₂ "H — three drawer	H11517	247	23.2	\$2752	\$2820
	36"W x 20"D x 59 ¹ / ₈ "H — four drawer	H11516	312	31.0	\$3834	\$3908
	NOTES: Includes hangrails, mechanical interlock, and in H11563 and H115690, a counterweight. Stack-on storage (H115321) and bookcase hutch (H115292) can be used with H11563 and H115690. Interlock inhibits the extension of more than one drawer from opening at a time. 24"D two-drawer model aligns with the depth of 24"D credenzas and returns. SPECIFYING EXAMPLE: H11563.A.C.NN					
	Storage Cabinet with Doors (with core removable lock) 36"W x 24"D x 29 ¹ / ₂ "H	H115290	176	18.4	\$1638	\$1696
	36"W x 20"D x 29 ¹ / ₂ "H	H115291	154	15.0	\$1408	\$1461
	NOTES: Includes one adjustable shelf. Shelf adjusts in 1 ¹ / ₄ " increments with a total range of 5"H. Stack-on storage (H115321) and bookcase hutch (H115292) can be used with H115290 or H115291. 24"D model aligns with the depth of 24"D credenzas and returns. SPECIFYING EXAMPLE: H115291.A.C.NN					
	Bookcase Hutch (for use with lateral file models H11563 or H115690 or storage cabinet with door models H115291 or H115290) 36"W x 14 ⁵ / ₈ "D x 37 ¹ / ₂ "H	H115292	108	3.8	\$1097	\$1113
	NOTES: Cord pass-through gap behind shelves and a 1 ¹ / ₈ "H full-width cord management slot at the bottom of the back panel to facilitate routing cords and reaching wall electrical outlets. When placed on top of 29 ¹ / ₂ "H base unit the total height (67"H) matches the height of credenzas with stack-on storage and the height of the wardrobe/storage cabinets and storage cabinet/lateral file. Two shelves are adjustable in 1 ¹ / ₄ " increments with a total range of 17 ¹ / ₂ "H. SPECIFYING EXAMPLE: H115292.A.NN					

**NOTES:**

- For additional components that can be shared with Valido Series, see pages 160-171.
- Drawers operate on full extension, ball-bearing suspensions to ensure smooth, quiet, long-lasting operation.
- Versatile mobile pedestals work well in a variety of configurations. Can be used freestanding or under modular shells. 1¹/₈" thick top with a square, non-profiled edge.
- 24"D two drawer lateral file and 24"D storage cabinet with door models align with 24"D credenzas and returns, credenza and return shells as well as wardrobe/storage cabinets to provide linear layout continuity.
- Mobile printer/fax cart shown on page 155 is ideal for limited space.
- File drawer design includes integrated hangrails for side-to-side letter or legal filing; and front-to-back for letter filing.
- Adjustable hex leveling glides allow floor-standing furniture to be easily leveled; glides have 3/4" adjustable range.
- For conference table options, see the Preside® table tops and bases in the Tables section in the 2023 Shared Spaces Pricer. Order edge option "K".

HOW TO SPECIFY

Select Model Number See page 146 	Select Edge Profile See page 146 Not specified for models H115102, H115103 and H115104 	Select Handle Option See page 146 Not specified for models H115292, H115520, H115523 and H115524 	Select Laminate See page 146 
---	--	--	---

VALIDO®

Shared Components & Accessories

GSA SIN 33721



Icon Legend on page 19

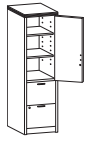

Right-hand model
H115297R shown

DESCRIPTION**MODEL****SHIP WEIGHT****CUBE****LIST PRICE BY LAMINATE GRADE****L1****L2****Storage/File Cabinet (with core removable locks)**

18"W x 24"D x 67"H, Hinged Right (shown)

H115297R

262

22.7

\$2972**\$3051**

18"W x 24"D x 67"H, Hinged Left

H115298L

262

22.7

\$2972**\$3051**

NOTES: Versatile unit features a storage cabinet and two file drawers. Storage cabinet includes three shelves, two are adjustable in 2½" increments. Door hinged left or right models available. File drawers operate on ball-bearing suspensions with full extension. File drawers have high sides to accept hanging folders in letter or legal size. Drawers standard with hangrails. Both the storage cabinet and the file drawers are equipped with an interchangeable core removable lock. Unit height is designed to match credenza or return plus stack-on storage height.



Doors open 110 degrees from
closed position.

Storage Cabinet/Lateral File (with core removable lock)

36"W x 24"D x 67"H

H115293

373

41.0

\$3851**\$3956**

NOTES: Storage cabinet is standard with one fixed and two full-width adjustable shelves in top compartment; adjustable shelves can be removed. Overall storage compartment measures 31¼"W x 22"D x 36⅞"H and will accommodate supplies, books and binders, as well as business machines and electronic equipment. Cord pass-through gap behind shelves and grommet in back of cabinet to facilitate routing cords and reaching wall electrical outlets. Two drawer lateral file on bottom. Lateral file comes with mechanical interlock and hangrails. Cabinet and lateral file lock independently. Unit height is designed to match credenza or return plus stack-on storage height.



Doors open 110 degrees from
closed position.

Storage Cabinet w/Doors (with core removable lock)

36"W x 24"D x 67"H

H115299

349

41.0

\$3442**\$3547**

NOTES: Large capacity storage area includes five, full-width (side-to-side) shelves; three are adjustable in 2½" increments. Unit height matches credenza or return plus stack-on storage height.

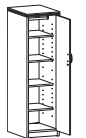

Right-hand model
H115295R shown

Personal Wardrobe/Storage Cabinet (with core removable lock)

18"W x 24"D x 67"H, Hinged Right (shown)

H115295R

227

22.9

\$2570**\$2649**

18"W x 24"D x 67"H, Hinged Left

H115296L

227

22.9

\$2570**\$2649**

NOTES: Unit is standard with four adjustable shelves, coat rod, and core removable lock. Shelves adjust in 2½" increments. Unit height is designed to match credenza or return plus stack-on storage height. Cabinet can be used as a wardrobe by removing four adjustable shelves. Coat rod can be removed from cabinet for storage only applications.

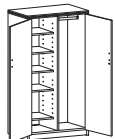

Doors open 110 degrees from
closed position.

Personal Wardrobe/Storage Cabinet (with core removable lock)

36"W x 24"D x 67"H

H11530

349

41.0

\$3761**\$3866**

NOTES: Spacious design is standard with four adjustable shelves (one shelf is fixed), coat rod and core removable lock which locks both doors. Shelves adjust in 2½" increments. Unit height is designed to match credenza or return plus stack-on storage height.

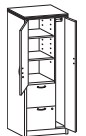

Right-hand model
H115301R shown

Personal Storage Tower (with core removable locks)

24"W x 24"D x 67"H, Wardrobe Hinged Right, Storage Cabinet Hinged Left (shown)

H115301R

304

27.9

\$3761**\$3861**

24"W x 24"D x 67"H, Wardrobe Hinged Left, Storage Cabinet Hinged Right

H115302L

304

27.9

\$3761**\$3861**

NOTES: Spacious design includes a wardrobe closet, storage cabinet, and two file drawers in one compact unit. Wardrobe closet contains a coat rod. Storage cabinet includes three shelves, two are adjustable in 2½" increments. Door hinged left or right models available. File drawers operate on ball-bearing suspensions with full extension. File drawers have high sides to accept hanging folders in letter or legal size. Drawers standard with hangrails. Equipped with interchangeable core removable locks. Upper lock secures storage cabinet and wardrobe closet doors; lower lock secures file drawers. Unit height is designed to match credenza or return plus stack-on storage height.

NOTES:









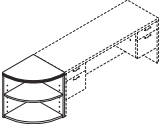

- Adjustable hex leveling glides allow floor-standing furniture to be easily leveled; glides have ¾" adjustable range.
- Locking units equipped with interchangeable core removable locks.
- For conference table options, see the Preside® table tops and bases in the Tables section in the 2023 Shared Spaces Pricer. Order edge option "K".
- See pages 160-171 for shared components.

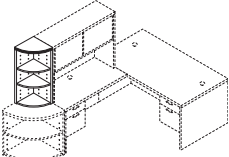
ⓘ Keyed alike cores must be ordered separately — see model HF23B on page 699.

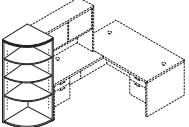
HOW TO SPECIFY

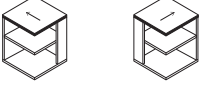
Select Model Number	Select Edge Profile	Select Handle Option	Select Laminate
See page 146	See page 146	See page 146	See page 146
H 1 1 5 2 9 7 R .	A .	C .	NN

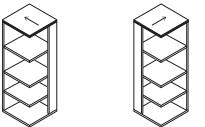

	DESCRIPTION	MODEL	SHIP WEIGHT	CUBE	LIST PRICE BY LAMINATE GRADE	
					L1	L2
 H11552 shown	Bookcase					
	36"W x 13 1/8"D x 29 5/8"H, 2-Shelf	H11552	94	10.2	\$942	\$958
	36"W x 13 1/8"D x 43 3/8"H, 3-Shelf	H11553	126	15.6	\$1105	\$1126
	36"W x 13 1/8"D x 57 1/8"H, 4-Shelf	H11554	160	20.3	\$1313	\$1340
	36"W x 13 1/8"D x 71"H, 5-Shelf	H11555	191	25.3	\$1479	\$1511
	NOTES: Fixed shelves. Inside shelf dimensions on all units is 33 3/4"W x 12"D x 13"H. No assembly required. SPECIFYING EXAMPLE: H11552.A.NN					
 	End Cap Bookshelf					
	24"W x 24"D x 29 1/2"H (2 shelves, 1 fixed, 1 adjustable. Adjusts in 2 1/2" increments with a total range of 10"H)	H115520	87	2.6	\$1106	\$1122
	NOTES: Unit is freestanding. Designed to be positioned at the end of 24"D credenzas and returns. Holds books and personal items. SPECIFYING EXAMPLE: H115520.A.NN					
 	End Cap Bookshelf					
	15"W x 15"D x 37 1/2"H (3 shelves, 1 fixed, 2 adjustable. Adjusts in 2 1/2" increments with a total range of 25"H)	H115523	54	2.2	\$978	\$994
	NOTES: Unit is designed to be positioned at the end of stack-on storage and on top of model H115520. Combined height of models H115520 and H115523 matches credenza plus stack-on storage height. Can be used freestanding. SPECIFYING EXAMPLE: H115523.A.NN					
 	End Cap Bookshelf					
	24"W x 24"D x 67"H	H115524	167	4.8	\$1754	\$1781
	NOTES: Designed to be positioned at the end of 24"D credenzas with stack-on storage, 24"D returns with stack-on storage, 24"D storage/file cabinet, 24"D storage cabinet/lateral file, 24"D wardrobe/storage cabinets, or the 24"D personal storage tower. Unit has four shelves, three are adjustable in 2 1/2" increments, with a total range of 45"H; bottom shelf is fixed. SPECIFYING EXAMPLE: H115524.A.NN					
 Model H115525R Model H115526L 	Square End Cap Bookshelf — 2-Fixed Shelves					
	24"W x 24"D x 29 1/2"H, Right	H115525R	98	3.7	\$1089	\$1105
	24"W x 24"D x 29 1/2"H, Left	H115526L	98	3.7	\$1089	\$1105
	SPECIFYING EXAMPLE: H115525R.A.NN					
 Model H115527R Model H115528L 	Square End Cap Bookshelf — 4-Fixed Shelves					
	24"W x 24"D x 67"H, Right	H115527R	178	11.4	\$1679	\$1706
	24"W x 24"D x 67"H, Left	H115528L	178	11.4	\$1679	\$1706
	SPECIFYING EXAMPLE: H115527R.A.NN NOTES: Units are freestanding. Designed to be positioned next to 24"D models or as a corner bookcase. End cap, left: grain direction on top aligns with grain direction on tops of left pedestal returns and left credenza models or when positioned to the left side of credenzas with doors or kneespace models. End cap, right: grain direction on top aligns with grain direction on tops of right pedestal returns and right credenza models or when positioned to the right side of credenzas with doors or kneespace models.					

NOTES:

- Choose from square or rounded versions of the end cap bookshelves.
- End Cap Bookcases are designed to be positioned at the end of 24"D credenzas and returns.
- Adjustable hex leveling glides allow floor-standing furniture to be easily leveled; glides have 3/4" adjustable range.
- End cap bookshelf units are ideal for books, photos and mementos.
- For conference table options, see the Preside® table tops and bases in the Tables section in the 2023 Shared Spaces Pricer. Order edge option "K".
- See pages 160-171 for shared components.

HOW TO SPECIFY

<p>Select Model Number</p> <p>H 1 1 5 5 2 7 R .</p>	<p>Select Edge Profile</p> <p>See page 146</p> <p>A .</p>	<p>Select Laminate</p> <p>See page 146</p> <p>NN</p>
---	---	--

VALIDO®

Shared Components & Accessories

GSA SIN 33721



Icon Legend on page 19

	DESCRIPTION	MODEL	SHIP WEIGHT	CUBE	LIST PRICE BY LAMINATE GRADE	
					L1	L2
	Reception Station with Transaction Counter for 72"W x 36"D Desk, or Desk Shell, with rectangle top 72"W x 36"D x 14 ⁵ / ₈ "H NOTES: For desk tops without grommets, see field installable grommet kit, model HFLDGRMT or HFLDGRMT3 on page 723. Transaction counter organizer (HTCOL52) fits under/inside of transaction counter (see below).	H115720	100	3.0	\$1049	\$1086
	Reception Station for 42"W x 24"D Return or Return Shell 42"W x 24"D x 13"H Reception Station for 48"W x 24"D Return or Return Shell 48"W x 24"D x 13"H NOTES: For return tops without grommets, see field installable grommet kit, model HFLDGRMT or HFLDGRMT3 on page 723. ⓘ Not available in two tone laminate.	H105722	21	1.0	\$314	\$335
	Reception Station for 48"W x 24"D Return or Return Shell 48"W x 24"D x 13"H NOTES: For return tops without grommets, see field installable grommet kit, model HFLDGRMT or HFLDGRMT3 on page 723. ⓘ Not available in two tone laminate.	H105721	25	3.6	\$357	\$378
	Reception Desk Shell 72"W x 39 ⁷ / ₈ "D x 44 ¹³ / ₁₆ "H NOTES: Non-handed design. Integrated 18 ⁵ / ₈ "D transaction counter with a 4" full-width overhang. Two cord management grommets in top for routing and hiding wires and cables. Transaction counter organizer (HTCOL52) fits under/inside of transaction counter.	H115724	328	16.8	\$2100	\$2158
	Reception Return Shell 42"W x 24"D x 43 ⁵ / ₁₆ "H NOTES: Non-handed design. Attaches to reception desk shell to form an L-shaped workstation. One cord management grommet in top for routing and hiding wires and cables. Woodgrain on approach side is vertical to match grain direction on end panels of reception desk.	H115726	140	16.8	\$1363	\$1400
	DESCRIPTION	MODEL	SHIP WEIGHT	CUBE	LIST PRICE	
	Transaction Counter Organizer 48 ³ / ₄ "W x 11 ¹ / ₈ "D x 13"H NOTES: Fits under reception station with transaction counter model H115720 or reception desk shell H115724. ⓘ Black only.	HTCOL52	24	1.1	\$351	

NOTES:

- Two welcoming reception station designs to choose from — stack-on enclosure or full-to-floor shell.
- See pages 160-171 for shared components.



HOW TO SPECIFY

Select Model Number H 1 1 5 7 2 4	Select Edge Profile See page 146 A	Select Laminate See page 146 N N
---	---	---

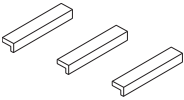
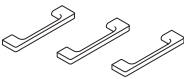

VALIDO®

Shared Components & Accessories

	DESCRIPTION	MODEL	SHIP WEIGHT	CUBE	LIST PRICE
  	Field Installable Drawer/Door Handle Kits (fit Valido® 96mm hole spacing)				
	Linear, Black, 2-pack	HLINEARA2	0.4	0.3	\$79
	Linear, Matte Chrome, 2-pack	HLINEARC2	0.4	0.3	\$79
	Linear, Black, 3-pack	HLINEARA3	0.5	0.3	\$88
	Linear, Matte Chrome, 3-pack	HLINEARC3	0.5	0.3	\$88
	NOTES: The Linear and Arch handles attach using the same 96mm hole spacing as the Valido® Sweep and Crescent handles. The Linear handle is not recommended for use on the Valido® Narrow/Box/Box/File Modular Pedestal — model H115093.				
Arch, Black, 2-pack	HARCHA2	0.4	0.3	\$79	
Arch, Matte Chrome, 2-pack	HARCHC2	0.4	0.3	\$79	
Arch, Black, 3-pack	HARCHA3	0.5	0.3	\$88	
Arch, Matte Chrome, 3-pack	HARCHC3	0.5	0.3	\$88	
	! Must be ordered with a configurable end product. If ordered separately, not on GSA contract.				

NOTES:

- Linear and Arch field installable handles attach using Valido® 96mm (approx. 3¾") hole spacing. No drilling required.
- For conference table options, see the Preside® table tops and bases in the Tables section in the 2023 Shared Spaces Pricer. Order edge option "K".

VOI®

Want to see more? Scan here
to check out hon.com.



Voi® Desking shown with Ignition® Seating.

VOI®

Voi gets you. Your needs. Your style. Your environment. Voi packs a lot of functionality into a little space, so you can maximize yours. Plus, versatile Voi integrates easily with a variety of spaces, systems — even open plans. Solidly built and strikingly designed, Voi combines classic warmth and contemporary cool with an extensive variety of laminates, colors, components and configurations. So you can create a sophisticated, professional look that is uniquely yours.



FEATURES

- Big. Small. Functional. Adaptable. Voi has multiple options to meet your storage needs and available space.
- To create an office look that's uniquely yours, mix things up — with tasteful modesty panels, stylish storage cubes and mixed surface materials.
- Refined scale. Layered workspaces. Together they help streamline your office to create small-footprint spaces that work BIG.
- With so many configurations and combinations, Voi® makes it easy to create a stylish, unified look across your entire office.

WORKSURFACES

L1 LAMINATES CODES

- Woodgrain**
- ◆ Bourbon Cherry H
 - ◆ Cognac COGN
 - ◆ Field Elm LWFE
 - ◆ Florence Walnut LFW1
 - ◆ Harvest C
 - ◆ Kingswood Walnut LK11
 - ◆ Mahogany N
 - ◆ Mocha MOCH
 - ◆ Natural Maple D
 - ◆ Pinnacle PINC
 - ◆ Shaker Cherry F
 - ◆ Sterling Ash LSA1

- Solid**
- ◆ Black P
 - ◆ Charcoal S
 - ◆ Designer White LDW1
 - ◆ Loft LOFT

- Patterned**
- ◆ Handspun Chestnut LAHC
 - ◆ Handspun Dove LAHD
 - ◆ Handspun Pearl LAHP
 - ◆ Handspun Slate LAHS
 - ◆ Silver Mesh* B9

L2 LAMINATES** CODES

- Woodgrain**
- ◆ Beigewood LWBE
 - ◆ Fawn Cypress LFC1
 - ◆ Lowell Ash LLA1
 - ◆ Natural Recon LNRI
 - ◆ Phantom Ecru LPE1
 - ◆ Portico Teak LPT1
 - ◆ Skyline Walnut LSW1

WORKSURFACE EDGE BAND

- Woodgrain**
- ◆ Beigewood DE
 - ◆ Bourbon Cherry H
 - ◆ Cognac COGN
 - ◆ Fawn Cypress FC
 - ◆ Field Elm FE
 - ◆ Florence Walnut FW
 - ◆ Harvest C
 - ◆ Kingswood Walnut KI
 - ◆ Lowell Ash DL
 - ◆ Mahogany N
 - ◆ Mocha MOCH
 - ◆ Natural Maple D
 - ◆ Natural Recon NR
 - ◆ Phantom Ecru PE
 - ◆ Pinnacle PINC
 - ◆ Portico Teak DP
 - ◆ Shaker Cherry F
 - ◆ Skyline Walnut SW
 - ◆ Sterling Ash SA

- Solid**
- ◆ Black P
 - ◆ Brownstone EY
 - ◆ Charcoal S
 - ◆ Designer White DW
 - ◆ Fossil EH
 - ◆ Greige R
 - ◆ Light Gray Q
 - ◆ Loft LOFT
 - ◆ Muslin T
 - ◆ Platinum K

CHASSIS/CABINET DRAWER/DOOR FRONTS, LAMINATE END PANELS, LAYERING SHELVES AND MODESTY PANELS

L1 LAMINATES CODES

- Woodgrain**
- ◆ Bourbon Cherry H
 - ◆ Cognac COGN
 - ◆ Field Elm LWFE
 - ◆ Florence Walnut LFW1
 - ◆ Harvest C
 - ◆ Kingswood Walnut LK11
 - ◆ Mahogany N
 - ◆ Mocha MOCH
 - ◆ Natural Maple D
 - ◆ Pinnacle PINC
 - ◆ Shaker Cherry F
 - ◆ Sterling Ash LSA1

- Solid**
- ◆ Black P
 - ◆ Charcoal S
 - ◆ Designer White LDW1
 - ◆ Loft LOFT

L2 LAMINATES** CODES

- Woodgrain**
- ◆ Beigewood LWBE
 - ◆ Fawn Cypress LFC1
 - ◆ Lowell Ash LLA1
 - ◆ Natural Recon LNRI
 - ◆ Phantom Ecru LPE1
 - ◆ Portico Teak LPT1
 - ◆ Skyline Walnut LSW1

WORKSURFACE GROMMETS

- PLASTIC CODES**
- ◆ Black P
 - ◆ Brownstone EY
 - ◆ Charcoal S
 - ◆ Designer White DW
 - ◆ Fossil EH
 - ◆ Greige R
 - ◆ Loft LOFT
 - ◆ Muslin T3
 - ◆ Platinum T1
 - ◆ Titanium T1

PULLS & FEET

- PAINT CODES**
- P1**
- ◆ Black P
 - ◆ Designer White PJW
- P2**
- ◆ Champagne Metallic T4
 - ◆ Gunmetal Metallic PR3
 - ◆ Platinum Metallic T1
 - ◆ Silver PR6
 - ◆ Solar Black P8X

O-LEGS, STEEL LEGS, POST LEGS, SHELF BRACKETS, SHARED LEGS, STORAGE CUBES

PAINTS CODES

- P1**
- ◆ Black P
 - ◆ Brownstone P7D
 - ◆ Charcoal S
 - ◆ Cove P096
 - ◆ Designer White PJW
 - ◆ Dune P094
 - ◆ Fossil P28
 - ◆ Greige T5
 - ◆ Harbor P097
 - ◆ Loft LOFT
 - ◆ Muslin T3
 - ◆ Sage P095
 - ◆ Titanium P8T

- P2**
- ◆ Champagne Metallic T4
 - ◆ Gunmetal Metallic PR3
 - ◆ Platinum Metallic T1
 - ◆ Silver PR6
 - ◆ Solar Black P8X

O-LEGS, STEEL LEGS, POST LEGS, SHELF BRACKETS, SHARED LEGS, STORAGE CUBES *continued*

PAINTS CODES

- P3**
- ◆ Amethyst* P091
 - ◆ Atom P8S
 - ◆ Blossom*** P8K
 - ◆ Bullseye PJF
 - ◆ Cobalt Mica* P090
 - ◆ Ember P8P
 - ◆ Ion P8N
 - ◆ Iris P8J
 - ◆ Krypton P8F
 - ◆ Ochre P093
 - ◆ Regatta P8M
 - ◆ Sienna P092
 - ◆ Succulent*** P8A

ANGLED WOOD LEGS

- ◆ Clear Ash LA400
- ◆ Medium Ash LA484

WORKSURFACE LAMINATES	CODES	EDGE BAND OPTIONS					
		Matching Edge	Designer White (DW)	Loft (LOFT)	Muslin (T)	Black (P)	Charcoal Edge (S)
Beigewood	LWBE	•	•	•	•	•	•
Black	P					•	
Bourbon Cherry	H	•	•		•		
Charcoal	S	•					
Cognac	COGN	•	•		•		
Designer White	LDW1		•				
Fawn Cypress	LFC1	•	•	•	•	•	•
Field Elm	LWFE	•	•	•	•	•	•
Handspun Chestnut	LAHC		•	•	•	•	•
Handspun Dove	LAHD		•	•	•	•	•
Handspun Pearl	LAHP		•	•	•	•	•
Handspun Slate	LAHS		•	•	•	•	•
Harvest	C	•	•		•		
Loft	LOFT			•			
Lowell Ash	LLA1	•	•	•	•		
Mahogany	N	•	•	•			
Mocha	MOCH	•	•		•		
Natural Maple	D	•	•	•	•		
Natural Recon	LNRI	•	•	•	•		
Phantom Ecru	LPE1	•	•	•	•		
Pinnacle	PINC	•	•		•		
Portico Teak	LPT1	•	•	•	•		
Shaker Cherry	F	•	•	•	•		
Silver Mesh	B9			•			
Skyline Walnut	LSW1	•	•	•	•		•
Sterling Ash	LSA1	•	•	•		•	•
Kingswood Walnut	LK11	•	•	•	•	•	
Florence Walnut	LFW1	•	•	•	•	•	•

* Silver Mesh laminate will have Loft Edgeband. Silver Mesh NOT available on Chassis/Cabinet, Drawer/Door Fronts, Laminate End Panels, Layering Shelves and Modesty Panels.

** Storage chassis that are specified in L2 laminates and are longer than 60"W will ship with back panels that are horizontal grain.

*** TREND COLORS: These colors are intended to be an inspirational option for the trending market. Product application is limited and color availability is approximately two years to coincide with evolving workplace trends.

◆◆◆ For lead time information see page 21.

* De-emphasized

VOI® Statement of Line

WORKSURFACES/SUPPORTS

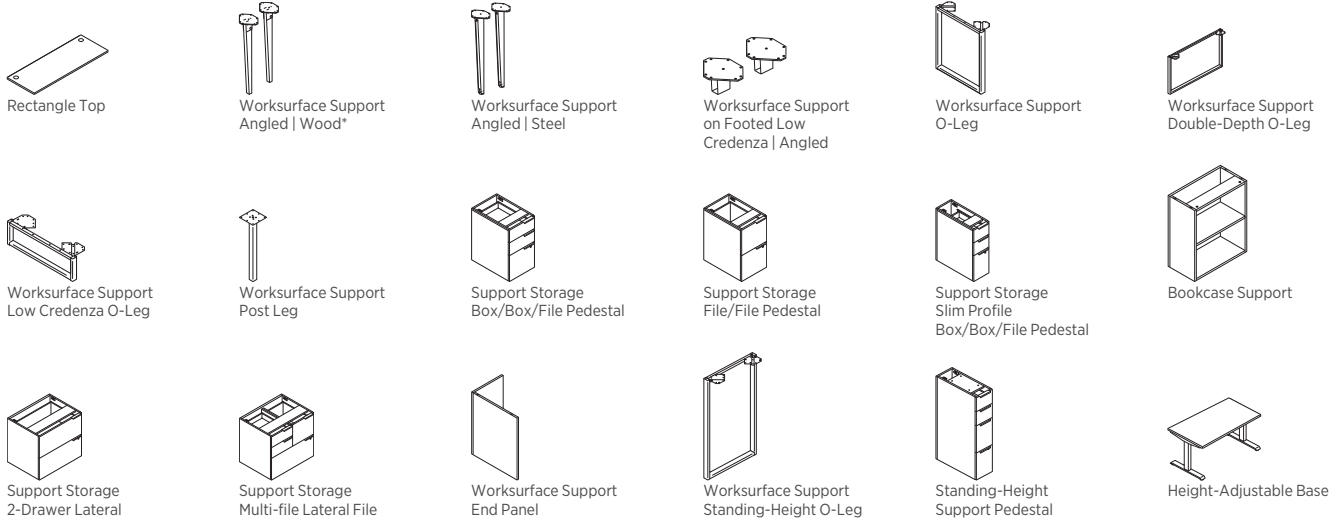

*Wood legs are available in Clear Ash and Medium Ash. Finish may vary due to natural variance of the wood.

STORAGE

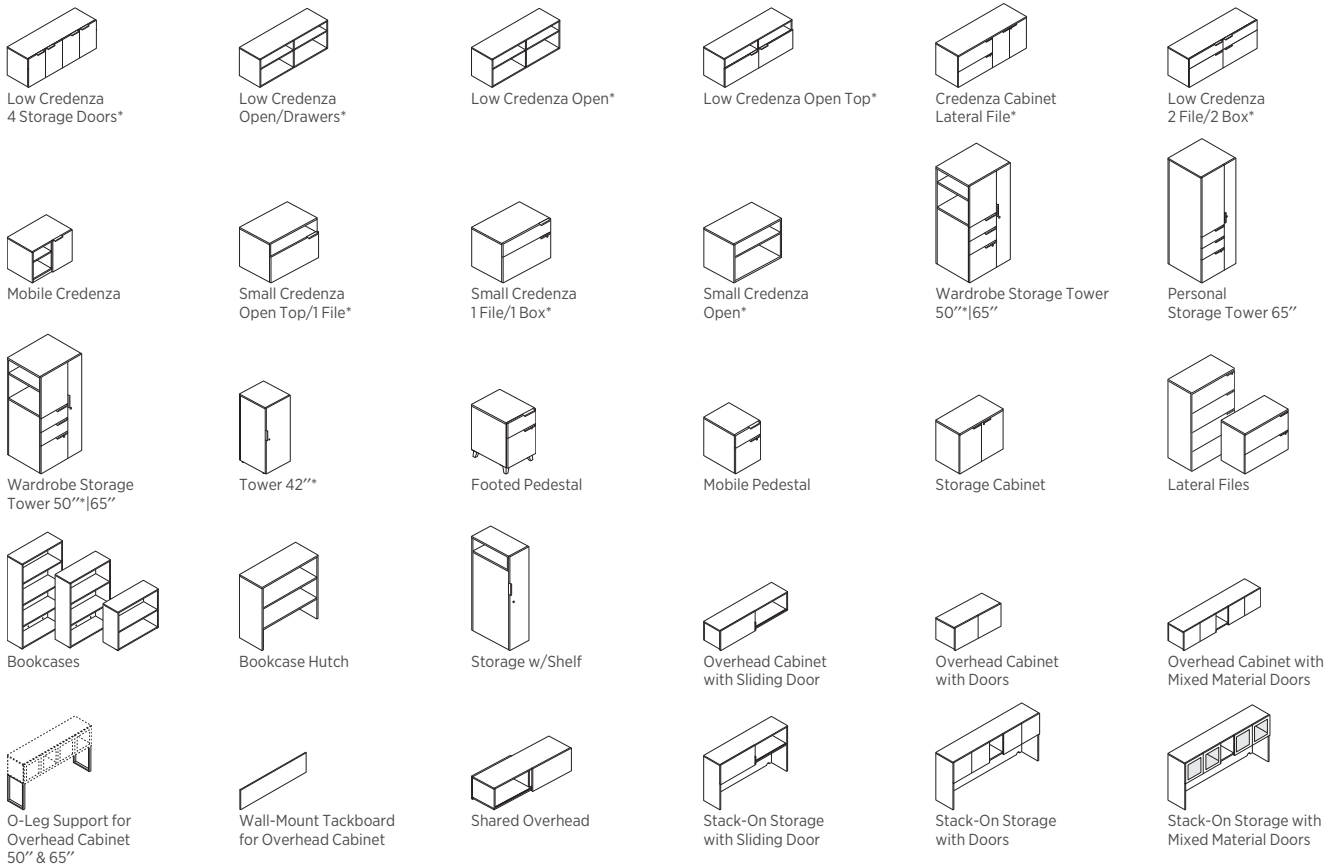

*Wood legs are available in Clear Ash and Medium Ash. Finish may vary due to natural variance of the wood.

ACCESSORIES



Storage Cube
15" w/Door



Storage Cube
15" Open

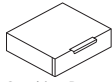

Stacking Drawer

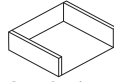

Open Stacker



Wall-Mounted Shelf



Metal Storage Cube 12"



Layering Shelf

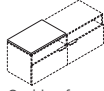

Cushion for
Pedestal or Credenza



Markerboard



Laminate Modesty
Panel, Half-Height

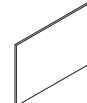

Laminate Modesty
Panel, Full-Height

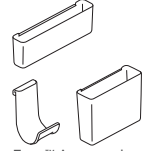

Fuse™ Accessories

VOI® Laminate Typicals



Icon Legend on page 19

QTY	DESCRIPTION	MODEL	LIST PRICE	PRICE EXTENSION
1	External Channel 54"W	HLSLZ5SC66	\$141	\$141
1	Rectangle Worksurface 24"D x 66"W	HLSLR2466	\$514	\$514
1	Low Credenza (Right hand drawers) 60"W x 20"D x 21½"H	HLSL2060LR2	\$1,690	\$1,690
1	Layering Shelf 60"W x 14½"D x 5½"H	HLSL1460LS	\$492	\$492
2	O-Leg Support for Worksurface (1 pack) 24"D x 28½"H	HLSL24280	\$428	\$856
1	Overhead Cabinet with Wall Bracket with One Sliding Door 60"W x 14¼"D x 14"H	HLSL1460S	\$1,715	\$1,715
TOTAL:			\$5,408	

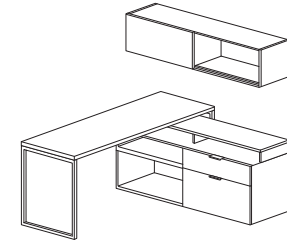
**SMALL FOOTPRINT****66" x 60"**

QTY	DESCRIPTION	MODEL	LIST PRICE	PRICE EXTENSION
1	External Channel 54"W	HLSLZ5SC66	\$141	\$141
1	Rectangle Worksurface 24"D x 66"W	HLSLR2466	\$514	\$514
1	Low Credenza (2 file/2 box) 60"W x 20"D x 21½"H	HLSL2060LD4	\$1,971	\$1,971
2	O-Leg Support for Worksurface (1 pack) 24"D x 28½"H	HLSL24280	\$428	\$856
1	Overhead Cabinet with 4 Doors 60"W x 14¼"D x 14"H	HLSL1460D	\$1,558	\$1,558
1	O-Leg Support for Overhead Cabinet 14½"D x 20½"H for 65"H Overhead Cabinet	HLSL650S	\$630	\$630
TOTAL:			\$5,670	

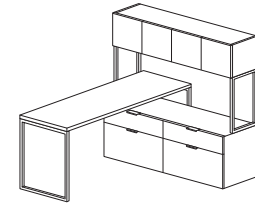
**SMALL FOOTPRINT****66" x 60"**

QTY	DESCRIPTION	MODEL	LIST PRICE	PRICE EXTENSION
1	Low Credenza, Right Hand Drawers, Footed 60"W x 20"D x 24½"H	HLSL2060LR2F	\$1,758	\$1,758
1	Cube Bundle A	HLSL15-SOO	\$414	\$414
2	Drawer Cube 15"W x 13"D x 4"H	HLSL154LSD	\$308	\$616
1	Voi® Shelf 30"W x 13"D	HLSLR1330	\$252	\$252
1	Angled Steel Leg 29"H	HLSL28AM2	\$427	\$427
1	4"H Steel Stanchion	HLSL4AM2	\$201	\$201
1	Rectangle Worksurface 72"W x 30"D	HLSLR3072	\$633	\$633
1	Acrylic Modesty Screen 42"W x 13"H	HUSAMOD1342	\$818	\$818
TOTAL:			\$5,119	

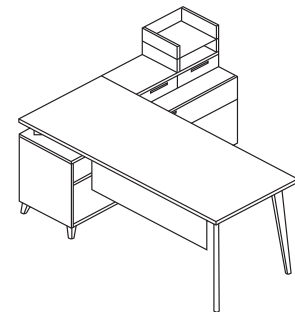
**SMALL FOOTPRINT****60"W x 72"D**



Icon Legend on page 19

VOI®

Laminate Typicals

DESKS

QTY	DESCRIPTION	MODEL	LIST PRICE	PRICE EXTENSION
1	Acrylic Modesty Screen 42"W x 13"H	HUSAMOD1342	\$818	\$818
1	Rectangular Worksurface 48"W x 24"D	HLSLR2448	\$405	\$405
2	Drawer Cube 15"W x 13"D x 4"H	HLSL154LSD	\$308	\$616
1	Cube Bundle A	HLSL15-SOO	\$414	\$414
2	Angled Steel Leg 29"H	HLSL28AM2	\$427	\$854
1	Rectangle Worksurface 60"W x 30"D	HLSLR3060	\$541	\$541
1	Voi® Shelf 30"W x 13"D	HLSLR1330	\$252	\$252
1	Support Pedestal 24"W x 28"D	HLSL2428B	\$1,025	\$1,025
TOTAL:			\$4,925	

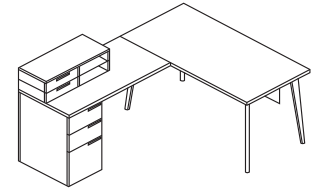

SMALL FOOTPRINT
78"W x 60"D

QTY	DESCRIPTION	MODEL	LIST PRICE	PRICE EXTENSION
1	Box/File Pedestal, Footed 16"W x 20"D x 28½"H	HLSL2016FP2	\$1,137	\$1,137
2	Drawer Cube 15"W x 13"D x 4"H	HLSL154LSD	\$308	\$616
1	Cube Bundle A	HLSL15-SOO	\$414	\$414
1	Short Open Cube 15"W x 13"D x 4"H	HLSL154LSO	\$207	\$207
1	Voi® Shelf 30"W x 13"D	HLSLR1330	\$252	\$252
2	Voi® Shelf 45"W x 13"D	HLSLR1345	\$308	\$616
1	4"H Steel Stanchion	HLSL4AM2	\$201	\$201
1	Rectangle Worksurface 72"W x 30"D	HLSLR3072	\$633	\$633
1	Rectangular Worksurface 48"W x 24"D	HLSLR2448	\$405	\$405
1	Shelf Brackets	HLSLSB	\$129	\$129
1	Acrylic Modesty Screen 54"W x 13"H	HUSAMOD1354	\$981	\$981
2	Angled Wood Leg 29"H	HLSL28AW2	\$553	\$1,106
TOTAL:			\$6,697	

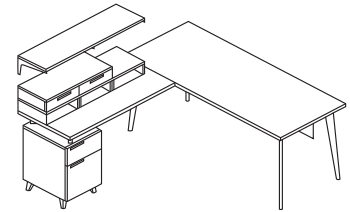

SMALL FOOTPRINT WITH SHELF
78"W x 72"D

QTY	DESCRIPTION	MODEL	LIST PRICE	PRICE EXTENSION
1	Low Credenza, 2 File/Open, Footed 60"W x 20"D x 24½"H	HLSL2060LD2F	\$1,915	\$1,915
1	Cabinet Cube, Left Handed 15"W x 13"D x 12"H	HLSL1512LSCL	\$308	\$308
1	Short Open Cube 15"W x 13"D x 4"H	HLSL154LSO	\$207	\$207
2	Drawer Cube 15"W x 13"D x 4"H	HLSL154LSD	\$308	\$616
1	Voi® Shelf 45"W x 13"D	HLSLR1345	\$308	\$308
2	Angled Steel Leg 29"H	HLSL28AM2	\$427	\$854
1	Rectangle Worksurface with Stiffener 60"W x 30"D	HLSLR3060W	\$638	\$638
1	Acrylic Modesty Screen 42"W x 13"H	HUSAMOD1342	\$818	\$818
TOTAL:			\$5,664	

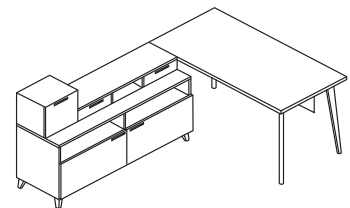

SMALL FOOTPRINT
90"W x 60"D

VOI® Laminate Typicals



Icon Legend on page 19

QTY	DESCRIPTION	MODEL	LIST PRICE	PRICE EXTENSION
1	Cube Bundle A	HLSL15-SOO	\$414	\$414
2	Angled Steel Leg 29"H	HLSL28AM2	\$427	\$854
1	Rectangle Worksurface 72"W x 30"D	HLSLR3072	\$633	\$633
1	Acrylic Modesty Screen 54"W x 13"H	HUSAMOD1354	\$981	\$981
1	Low Credenza, 2 File/Open, Footed 60"W x 20"D x 24½"H	HLSL2060LD2F	\$1,915	\$1,915
4	Drawer Cube 15"W x 13"D x 4"H	HLSL154LSD	\$308	\$1,232
2	Voi® Shelf 30"W x 13"D	HLSLR1330	\$252	\$504
TOTAL:			\$6,533	

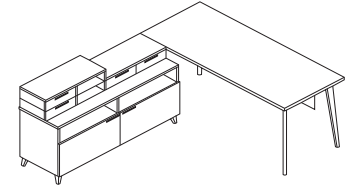

**SMALL FOOTPRINT WITH
SIX CUBES**
90" W x 72" D

QTY	DESCRIPTION	MODEL	LIST PRICE	PRICE EXTENSION
1	Low Credenza, 2 File/Open, Footed 60"W x 20"D x 24½"H	HLSL2060LD2F	\$1,915	\$1,915
1	Low Credenza, Open, Footed 30"W x 20"D x 24½"H	HLSL2030LD0F	\$1,238	\$1,238
1	Cube Bundle C	HLSL15-SODLOC	\$1,070	\$1,070
2	Voi® Shelf 45"W x 13"D	HLSLR1345	\$308	\$616
1	Angled Steel Leg 29"H	HLSL28AM2	\$427	\$427
1	4"H Steel Stanchion	HLSL4AM2	\$201	\$201
1	Rectangle Worksurface 72"W x 30"D	HLSLR3072	\$633	\$633
1	Acrylic Modesty Screen 42"W x 13"H	HUSAMOD1342	\$818	\$818
TOTAL:			\$6,918	

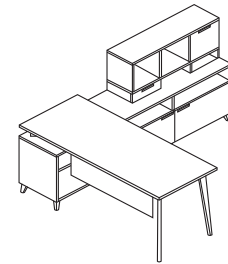

**MEDIUM FOOTPRINT WITH
CUBE BUNDLE C**
90" W x 72" D

QTY	DESCRIPTION	MODEL	LIST PRICE	PRICE EXTENSION
1	External Channel 48"W	HLSLZ5SC60	\$135	\$135
1	Rectangle Worksurface 30"D x 72"W	HLSLR3072	\$633	\$633
1	Rectangle Worksurface 20"D x 72"W	HLSLR2072	\$526	\$526
1	Low Credenza (2 file drawers) 60"W x 20"D x 21½"H	HLSL2060LD2	\$1,847	\$1,847
1	Overhead Cabinet - Metal Frame, Glass Doors 72"W x 14¼"D x 14"H	HLSL1472M	\$2,886	\$2,886
1	O-Leg Stack-on Storage Support (2 pack) 65"H	HLSL65OS	\$630	\$630
1	O-Leg Support for Worksurface (1 pack) 20"D x 28½"H	HLSL2028O	\$394	\$394
2	O-Leg Support for Worksurface (1 pack) 30"D x 28½"H	HLSL3028O	\$474	\$948
1	Box/Box/File Pedestal Support 20"D x 28½"H	HLSL2028B	\$926	\$926
1	Acrylic Modesty Screen 60"W x 13"H	HUSAMOD1360	\$1,003	\$1,003
1	Storage Cube 12" x 12"	HLSL1212	\$400	\$400
TOTAL:			\$10,328	

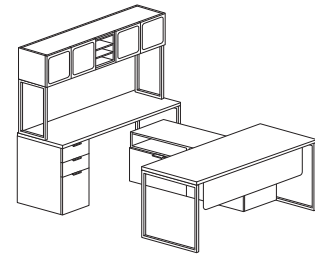

PRIVATE OFFICE
92" x 72"



Icon Legend on page 19

QTY	DESCRIPTION	MODEL	LIST PRICE	PRICE EXTENSION
1	Box/Box/File Pedestal Support 30"D x 28"H	HLSL3028B	\$1,152	\$1,152
1	Rectangle Worksurface 36"D x 72"W	HLSLR3672	\$819	\$819
1	End Panel Support 24"D x 28½"H	HLSL2428E	\$274	\$274
1	End Panel Support 30"D x 28½"H	HLSL3028E	\$293	\$293
1	Rectangle Worksurface 20"D x 42"W	HLSLR2042	\$355	\$355
1	Rectangle Worksurface 24"D x 72"W	HLSLR2472	\$531	\$531
1	Acrylic Modesty Screen 42"W x 13"H	HUSAMOD1342	\$818	\$818
1	Lateral File 31⅝"W x 24"D x 28½"H	HLSL2430L	\$1,586	\$1,586
1	Overhead Cabinet - Metal Frame, Glass Doors 72"W x 14¼"D x 14"H	HLSL1472M	\$3,043	\$3,043
1	Storage Cube 12" x 12"	HLSL1212	\$400	\$400
TOTAL:			\$9,271	

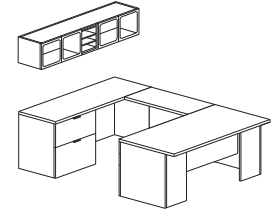

PRIVATE OFFICE
102" x 72"

QTY	DESCRIPTION	MODEL	LIST PRICE	PRICE EXTENSION
1	Low Credenza, 2 File/Open, Footed 60"W x 20"D x 24½"H	HLSL2060LD2F	\$1,915	\$1,915
1	Low Credenza, 1 File/Open, Footed 30"W x 20"D x 24½"H	HLSL2030LD1F	\$1,367	\$1,367
1	Left Hand Door, Footed 18"W x 20"D x 4"H	HLSLW084LF	\$1,712	\$1,712
2	Drawer Cube 15"W x 13"D x 4"H	HLSL154LSD	\$308	\$616
2	Cube Bundle A	HLSL15-SOO	\$414	\$828
1	Cube Bundle D	HLSL15-SDDLCC	\$1,232	\$1,232
2	Voi® Shelf 45"W x 13"D	HLSLR1345	\$308	\$616
2	Voi® Shelf 30"W x 13"D	HLSLR1330	\$252	\$504
2	Angled Wood Leg 29"H	HLSL28AW2	\$553	\$1,106
1	Rectangle Top, Knife Edge 72"W x 30"D	HLSLR3072J	\$863	\$863
1	Acrylic Modesty Screen 54"W x 13"H	HUSAMOD1354	\$981	\$981
TOTAL:			\$11,740	

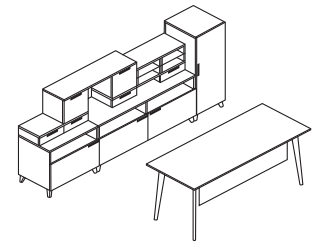

PRIVATE OFFICE WITH TABLE DESK
108"W x 50"D

QTY	DESCRIPTION	MODEL	LIST PRICE	PRICE EXTENSION
1	Tower (Right hand drawers/Left hand door) 24"W x 20"D x 65"H, Left	HLSLW046L	\$2,930	\$2,930
1	Layering Shelf 60"W x 14½"D x 5½"H	HLSL1460LS	\$492	\$492
1	Rectangle Worksurface 30"D x 72"W	HLSLR3072	\$633	\$633
1	Acrylic Modesty Screen 42"W x 13"H	HUSAMOD1342	\$818	\$818
2	O-Leg Support for Worksurface (1 pack) 30"D x 28½"H	HLSL3028O	\$474	\$948
1	Low Credenza (2 file/2 box) 60"W x 20"D x 21½"H	HLSL2060LD4	\$1,971	\$1,971
1	Low Credenza (Open/Right hand drawers) 60"W x 20"D x 21½"H	HLSL2060LR2	\$1,690	\$1,690
1	Credenza Cushion 20"W x 30"D x 1"H	HLSL2030CH2	\$501	\$501
TOTAL:			\$9,983	

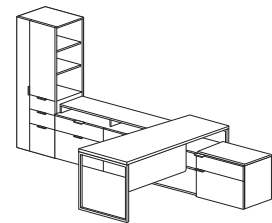

PRIVATE OFFICE
144" x 72"

VOI® Laminate Typicals



Icon Legend on page 19

QTY	DESCRIPTION	MODEL	LIST PRICE	PRICE EXTENSION
1	Personal Storage Tower (Left handed) 24"W x 24"D x 65"H	HLSLW446LP	\$3,493	\$3,493
2	Lateral File 31 ³ / ₈ "W x 24"D x 28 ¹ / ₂ "H	HLSL2430L	\$1,586	\$3,172
1	Rectangle Worksurface 24"D x 60"W	HLSLR2460	\$473	\$473
1	Rectangle Worksurface 30"D x 72"W	HLSLR3072	\$633	\$633
1	Rectangle Worksurface 24"D x 54"W	HLSLR2454	\$435	\$435
2	O-Leg Support for Worksurface (1 pack) 30"D x 28 ¹ / ₂ "H	HLSL30280	\$474	\$948
2	Overhead Cabinet with Wall Bracket with One Sliding Door 72"W x 14 ¹ / ₄ "D x 13"H	HLSL1472S	\$2,032	\$4,064
2	Storage Cube 12" x 12"	HLSL1212	\$400	\$800
1	External Channel 60"W	HLSLZ55C72	\$152	\$152
TOTAL:			\$14,170	

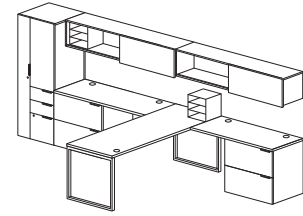

OPEN PLAN
168'' x 72''

QTY	DESCRIPTION	MODEL	LIST PRICE	PRICE EXTENSION
4	External Channel 48"W	HLSLZ55C60	\$135	\$540
2	Accelerate® Raceway Panels 42 ¹ / ₂ "H x 60"W	HETP4260FP	\$552	\$1,104
2	Accelerate® Raceway Panels 50"H x 60"W	HETP5060FP	\$616	\$1,232
2	Electrical Power Harness, 3-1 & 2-2 60"W	HH871260	\$286	\$572
4	Duplex Receptacle Circuit 3, 3-1	HH871503	\$58	\$232
1	Power In-Feed	HH879072	\$303	\$303
2	Low Credenza (Right hand drawers) 60"W x 20"D x 21 ¹ / ₂ "H	HLSL2060LR2	\$1,690	\$3,380
2	Low Credenza (Left hand drawers) 60"W x 20"D x 21 ¹ / ₂ "H	HLSL2060LL2	\$1,690	\$3,380
4	Credenza Cushion 20"W x 30"D x 1"H	HLSL2030CH2	\$501	\$2,004
4	O-Leg Support for Worksurface (1 pack) 30"D x 28 ¹ / ₂ "H	HLSL24280	\$428	\$1,712
2	Left O-Leg to Panel Bracket	HLSLPBL	\$134	\$268
2	Right O-Leg to Panel Bracket	HLSLPBR	\$134	\$268
4	Accelerate® Top Cap 60"W	HETC60	\$111	\$444
2	Accelerate® Variable Height Finishing Kit	HECVH07P	\$71	\$142
2	Accelerate® Finished End Cover 50"H	HEFEC50P	\$78	\$156
2	Accelerate® Finished End Cover 42¹/₂"H	HEFEC42P	\$72	\$144
1	Accelerate® "X" Connector 50"H	HEC50PXN	\$156	\$156
4	O-Leg Support for Worksurface 24"D x 7"H	HLSL2470	\$288	\$1,152
4	Rectangle Worksurface 24"D x 60"W	HLSLR2460	\$473	\$1,892
TOTAL:			\$19,081	

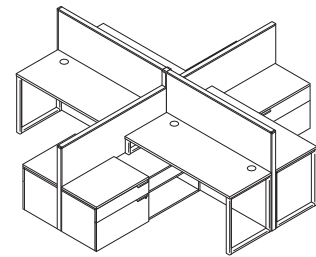

OPEN PLAN
120'' x 120''



Icon Legend on page 19

VOI®

Laminate Typicals

DESKS

QTY	DESCRIPTION	MODEL	LIST PRICE	PRICE EXTENSION
4	External Channel 60"W	HLSLZ5SC72	\$152	\$608
4	Rectangle Worksurface 24"D x 72"W	HLSLR2472	\$531	\$2,124
2	O-Leg Shared Support for Low Credenzas	HLSL247SL	\$359	\$718
2	Double Depth O-Leg Support for Worksurface 48"D x 28½"H	HLSL4828O	\$803	\$1,606
2	Low Credenza (Right hand drawers) 60"W x 20"D x 21½"H	HLSL2060LR2	\$1,690	\$3,380
2	Low Credenza (Left hand drawers) 60"W x 20"D x 21½"H	HLSL2060LL2	\$1,690	\$3,380
2	Acrylic Fixed Above/Below Screen 60"W x 27"H	HUSAABF2760	\$1,923	\$3,846
TOTAL:				\$15,662

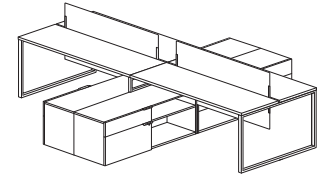

OPEN PLAN
144" x 120"

QTY	DESCRIPTION	MODEL	LIST PRICE	PRICE EXTENSION
1	Low Credenza, Right Hand Drawers, Footed 60"W x 20"D x 24½"H	HLSL2060LR2F	\$1,758	\$1,758
1	Low Credenza, Left Hand Drawers, Footed 60"W x 20"D x 24½"H	HLSL2060LL2F	\$1,758	\$1,758
1	Cube Bundle A	HLSL15-SOO	\$414	\$414
2	Drawer Cube 15"W x 13"D x 4"H	HLSL154LSD	\$308	\$616
1	Cabinet Cube, Right Handed 15"W x 13"D x 12"H	HLSL1512LSCR	\$308	\$308
1	Cabinet Cube, Left Handed 15"W x 13"D x 12"H	HLSL1512LSCL	\$308	\$308
3	Voi® Shelf 30"W x 13"D	HLSLR1330	\$252	\$756
4	Angled Steel Leg 29"H	HLSL28AM2	\$427	\$1,708
2	Rectangle Top, Knife Edge 60"W x 30"D	HLSLR3060J	\$738	\$1,476
TOTAL:				\$9,102

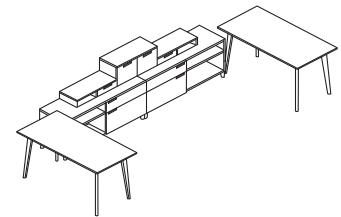

LARGE FOOTPRINT
TEAMING
180" W x 80" D

VOI® Bundles Typicals



Icon Legend on page 19

VT6030MB

Worksurface is Silver Mesh, Mobile Pedestal is Harvest, O-Leg Supports and grommets are Platinum Metallic.

QTY	DESCRIPTION	MODEL	LIST PRICE	PRICE EXTENSION
1	Rectangle Worksurface with External Support Channel	HLSLR3060W*	\$638	\$638
2	O-Leg Support for Worksurface	HLSL3028O	\$479	\$958
1	Mobile Pedestal	HLSL2016MP2	\$1,070	\$1,070
TOTAL:			\$2,666	

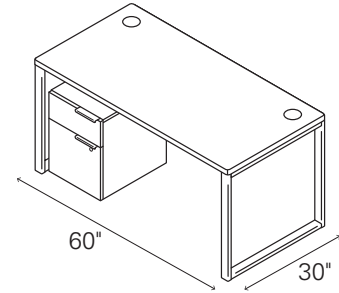
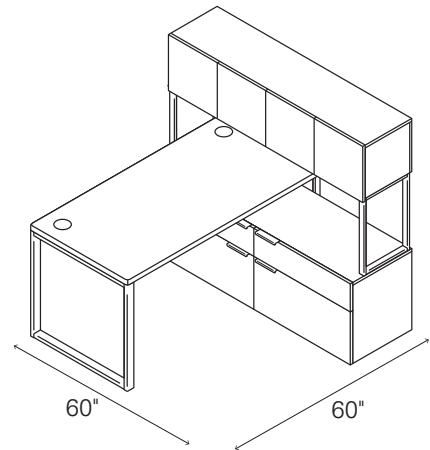

**TABLE DESK WITH MOBILE PEDESTAL
(NON-HANDED)**

VS6060L1B

Worksurface is Silver Mesh, Low Credenza and Overhead Cabinet are Harvest, O-Leg Supports and grommets are Platinum Metallic.

QTY	DESCRIPTION	MODEL	LIST PRICE	PRICE EXTENSION
1	Rectangle Worksurface with External Support Channel	HLSLR3060W*	\$638	\$638
2	O-Leg Support for Worksurface	HLSL3028O	\$479	\$958
1	Low Credenza, 2 File/2 Box	HLSL2060LD4	\$1,971	\$1,971
1	Overhead Cabinet with 4 Doors	HLSL1460D	\$1,558	\$1,558
1	O-Leg Support for Overhead Cabinet (Pair)	HLSL650S	\$635	\$635
TOTAL:			\$5,760	



**SMALL FOOTPRINT L-STATION
(NON-HANDED)**

VS6060L6B

Worksurface is Silver Mesh, Low Credenza and Layering Shelf are Harvest, O-Leg Supports and grommets are Platinum Metallic.

QTY	DESCRIPTION	MODEL	LIST PRICE	PRICE EXTENSION
1	Rectangle Worksurface with External Support Channel	HLSLR3060W*	\$638	\$638
2	O-Leg Support for Worksurface	HLSL3028O	\$479	\$958
1	Low Credenza, Right-hand Drawers	HLSL2060LR2	\$1,690	\$1,690
1	Layering Shelf	HLSL1460LS	\$492	\$492
TOTAL:			\$3,778	

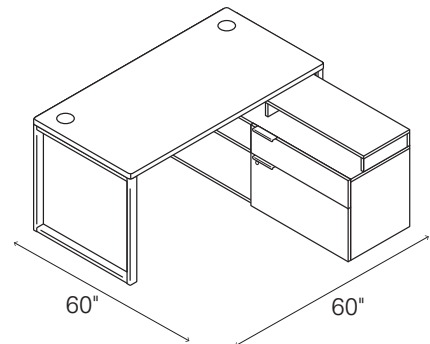

**SMALL FOOTPRINT L-STATION
(RIGHT HANDED, LOW CREDENZA)**

*Worksurface model **HLSLR3060W** can only be ordered with bundles.



Icon Legend on page 19

VOI® Bundles Typicals

DESKS

VS6060L4B

Worksurface is Silver Mesh, Low Credenza and Layering Shelf are Harvest, O-Leg Supports and grommets are Platinum Metallic.

QTY	DESCRIPTION	MODEL	LIST PRICE	PRICE EXTENSION
1	Rectangle Worksurface with External Support Channel	HLSLR3060W*	\$638	\$638
2	O-Leg Support for Worksurface	HLSL30280	\$479	\$958
1	Low Credenza, Left-hand Drawers	HLSL2060LL2	\$1,690	\$1,690
1	Layering Shelf	HLSL1460LS	\$492	\$492
TOTAL:			\$3,778	

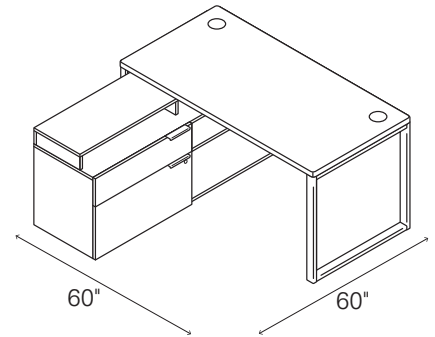

**SMALL FOOTPRINT L-STATION
(LEFT HANDED, LOW CREDENZA)**

VS6060L5B

Worksurface is Silver Mesh, Low Credenza and Overhead Cabinet are Harvest, O-Leg Supports and grommets are Platinum Metallic.

QTY	DESCRIPTION	MODEL	LIST PRICE	PRICE EXTENSION
1	Rectangle Worksurface with External Support Channel	HLSLR3060W*	\$638	\$638
2	O-Leg Support for Worksurface	HLSL30280	\$479	\$958
1	Low Credenza, Right-hand Drawers	HLSL2060LR2	\$1,690	\$1,690
1	Overhead Cabinet with 4 Doors	HLSL1460D	\$1,558	\$1,558
1	O-Leg Support for Overhead Cabinet (Pair)	HLSL650S	\$635	\$635
TOTAL:			\$5,479	

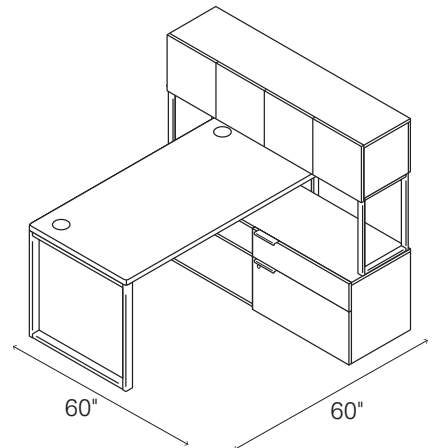

**SMALL FOOTPRINT L-STATION
(RIGHT HANDED, LOW CREDENZA)**

VS6060L3B

Worksurface is Silver Mesh, Low Credenza and Overhead Cabinet are Harvest, O-Leg Supports and grommets are Platinum Metallic.

QTY	DESCRIPTION	MODEL	LIST PRICE	PRICE EXTENSION
1	Rectangle Worksurface with External Support Channel	HLSLR3060W*	\$638	\$638
2	O-Leg Support for Worksurface	HLSL30280	\$479	\$958
1	Low Credenza, Left-hand Drawers	HLSL2060LL2	\$1,690	\$1,690
1	Overhead Cabinet with 4 Doors	HLSL1460D	\$1,558	\$1,558
1	O-Leg Support for Overhead Cabinet (Pair)	HLSL650S	\$635	\$635
TOTAL:			\$5,479	

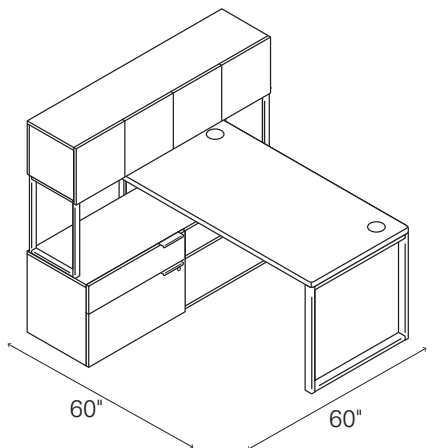

**SMALL FOOTPRINT L-STATION
(LEFT HANDED, LOW CREDENZA)**

*Worksurface model **HLSLR3060W** can only be ordered with bundles.

VOI® Bundles Typicals



Icon Legend on page 19

VS6060L2B

Worksurface is Silver Mesh, Low Credenza and Layering Shelf are Harvest, O-Leg Supports and grommets are Platinum Metallic.

QTY	DESCRIPTION	MODEL	LIST PRICE	PRICE EXTENSION
1	Rectangle Worksurface with External Support Channel	HLSLR3060W*	\$638	\$638
2	O-Leg Support for Worksurface	HLSL30280	\$479	\$958
1	Low Credenza, 2 File/2 Box	HLSL2060LD4	\$1,971	\$1,971
1	Layering Shelf	HLSL1460LS	\$492	\$492
TOTAL:			\$4,059	

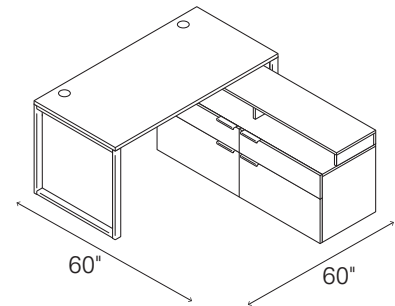

**SMALL FOOTPRINT L-STATION
(LOW CREDENZA, LAYERING SHELF)
(NON-HANDED)**

VC7260L2B

Worksurface is Silver Mesh, Low Credenza is Harvest, O-Leg Supports and grommets are Platinum Metallic.

QTY	DESCRIPTION	MODEL	LIST PRICE	PRICE EXTENSION
1	Rectangle Worksurface with External Support Channel	HLSLR3072W*	\$739	\$739
2	O-Leg Support for Worksurface	HLSL30280	\$479	\$958
1	Low Credenza, 2 File/2 Box	HLSL2060LD4	\$1,971	\$1,971
TOTAL:			\$3,668	

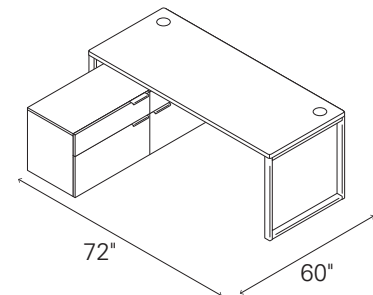

**CONTEMPORARY L-STATION
(NON-HANDED)**

*Worksurface models **HLSLR3060W** and **HLSLR3072W** can only be ordered with bundles.

This Specifying Guide is designed to walk you through the steps when choosing the Voi desks elements that will meet your particular workplace needs. From private office to open plan, there are endless combinations that will fit your style and need.

Regardless of the application, Voi presents an integrated, unified aesthetic for the entire workplace.

The step-by-step instructions make it easy to specify elements that personalize workspaces and achieve the right mix of functionality and style.

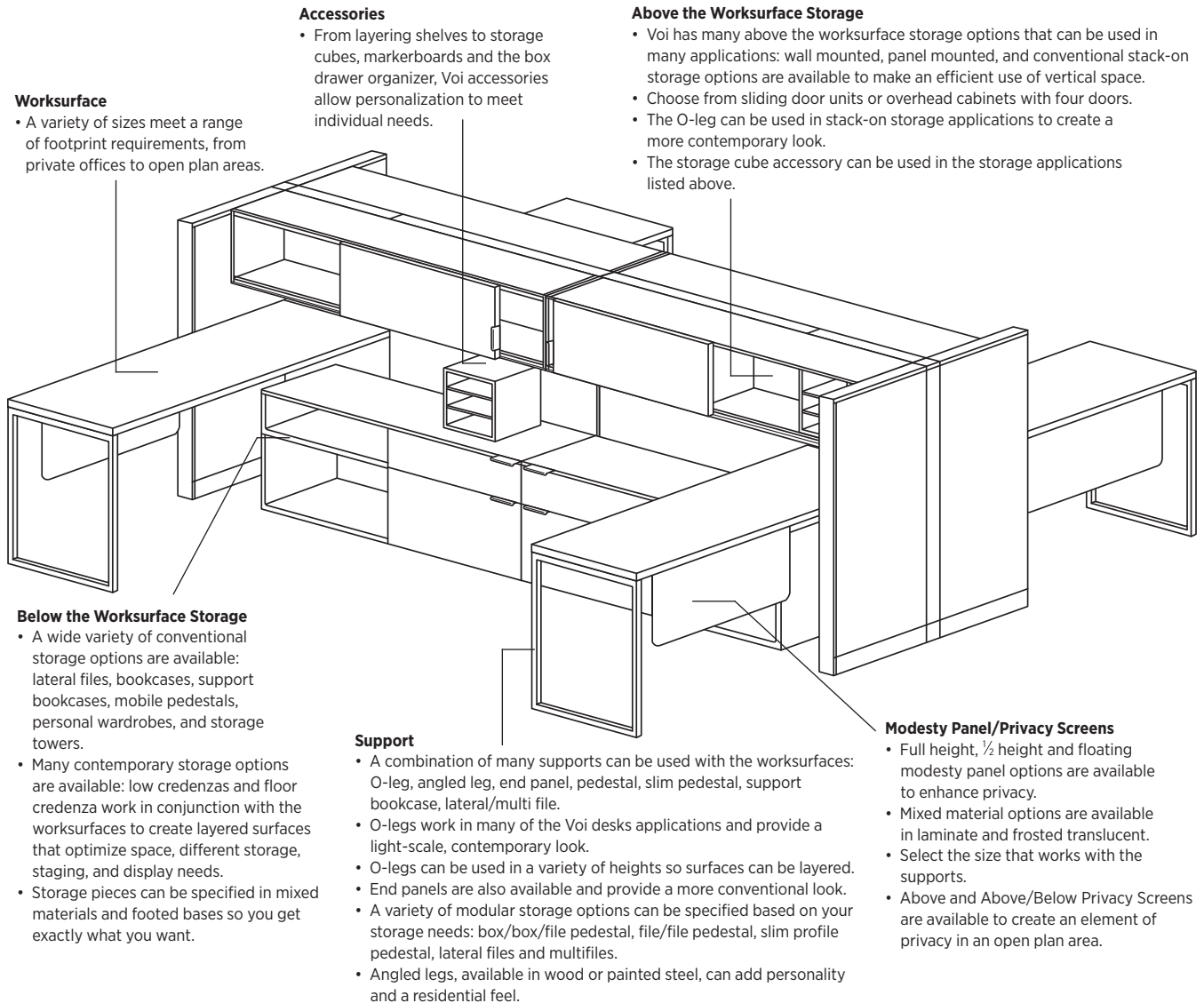

Worksurface

- A variety of sizes meet a range of footprint requirements, from private offices to open plan areas.

Accessories

- From layering shelves to storage cubes, markerboards and the box drawer organizer, Voi accessories allow personalization to meet individual needs.

Above the Worksurface Storage

- Voi has many above the worksurface storage options that can be used in many applications: wall mounted, panel mounted, and conventional stack-on storage options are available to make an efficient use of vertical space.
- Choose from sliding door units or overhead cabinets with four doors.
- The O-leg can be used in stack-on storage applications to create a more contemporary look.
- The storage cube accessory can be used in the storage applications listed above.

Below the Worksurface Storage

- A wide variety of conventional storage options are available: lateral files, bookcases, support bookcases, mobile pedestals, personal wardrobes, and storage towers.
- Many contemporary storage options are available: low credenzas and floor credenza work in conjunction with the worksurfaces to create layered surfaces that optimize space, different storage, staging, and display needs.
- Storage pieces can be specified in mixed materials and footed bases so you get exactly what you want.

Support

- A combination of many supports can be used with the worksurfaces: O-leg, angled leg, end panel, pedestal, slim pedestal, support bookcase, lateral/multi file.
- O-legs work in many of the Voi desks applications and provide a light-scale, contemporary look.
- O-legs can be used in a variety of heights so surfaces can be layered.
- End panels are also available and provide a more conventional look.
- A variety of modular storage options can be specified based on your storage needs: box/box/file pedestal, file/file pedestal, slim profile pedestal, lateral files and multifiles.
- Angled legs, available in wood or painted steel, can add personality and a residential feel.

Modesty Panel/Privacy Screens

- Full height, ½ height and floating modesty panel options are available to enhance privacy.
- Mixed material options are available in laminate and frosted translucent.
- Select the size that works with the supports.
- Above and Above/Below Privacy Screens are available to create an element of privacy in an open plan area.

VOI® SPECIFYING/DESIGN GUIDE

Steps for specification:

1. Select the right worksurface.

Choose the worksurface shape and size that best fits your office layout.

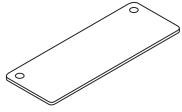

Rectangle Flat Edge Worksurface

Depths: 20", 24", 30", 36"
Widths: 36", 42", 48", 54",
60", 66", 72", 84"

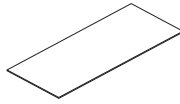

Rectangle Knife Edge Worksurface

Depths: 24", 30"
Widths: 48", 60", 72"

2. Select the supports.

Countless combinations of support options meet a variety of support and storage needs.

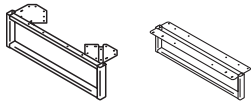

O-Leg and Shared Support for Low Credenza

20"D x 7"H, 24"D x 7"H, 30"D x 7"H
7"H only O-legs attach to worksurface and sit on top of credenzas.

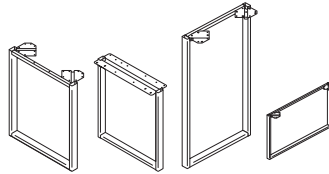

O-Leg and Shared Support for Worksurfaces

20"D x 28½"H, 24"D x 28½"H, 30"D x 28½"H
28½"H, 24"D x 41"H, 30"D x 41"H, 48"D x 28½"H,
60"D x 28½"H O-legs provide support for the worksurface.

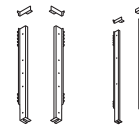

O-Leg-to-Panel Attachment Bracket

Left handed bracket (quantity 1)
Right handed bracket (quantity 1)

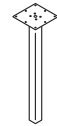

Post Leg

28½"H, 2" square

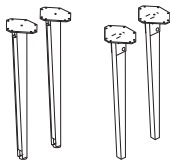

Angled Legs

12"W x 8"D x 32"H, Steel
12"W x 8"D x 32"H, Wood

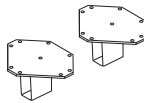

Steel Stanchions

4"H
Stanchions attach to worksurface and sit on top of credenzas.

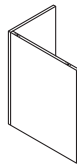

End Panel Support

16"W x 20"D x 28½"H,
16"W x 24"D x 28½"H,
16"W x 30"D x 28½"H



Laminate End Panel Support With Panel Attachment Bracket

24"D x 28½"H, 30"D x 28"H

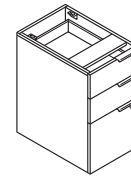

B/B/F Pedestals

16"W x 20"D x 28½"H,
16"W x 24"D x 28½"H,
16"W x 30"D x 28½"H

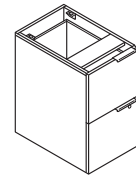

F/F Pedestals

16"W x 20"D x 28½"H,
16"W x 24"D x 28½"H,
16"W x 30"D x 28½"H

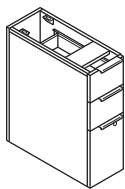

B/B/F Standard Slim Profile Pedestals

9½"W x 24"D x 28½"H,
9½"W x 30"D x 28½"H

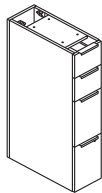

Standing-Height Pedestals

9½"W x 24"D x 41"H,
9½"W x 30"D x 41"H

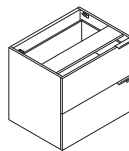

2 Drawer Lateral with Pulls

30"W x 24"D x 28½"H

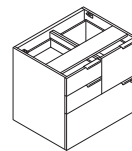

Multi-Drawer Standard File Center

30"W x 24"D x 28½"H

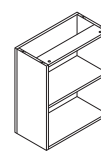

Bookcase Support

30"W x 12"D x 28½"H,
24"W x 12"D x 28½"H

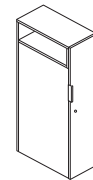

Standing-Height Towers

12"W x 30"D x 50"H,
12"W x 24"D x 50"H

Tips

- When using an O-leg in open plan, panel supported, applications, you must specify an O-leg to panel attachment bracket separately (available in 28"H and 41"H).
- Bookcase Support can only be used exterior facing.
- Telescoping ball-bearing slides used on box and file drawers. Lateral drawers use a progressive ball-bearing slide.
- When specifying a 30"D support on a 36"D worksurface, there will be a 6" overhang.
- All modular pedestals have an easy attach method to the worksurface for quick assembly.
- One double-depth O-leg can replace two regular O-legs in teaming applications.
- Shared O-legs create cleaner aesthetic where two legs are used side-by-side.
- 2" adjustable glides on O-leg supports.
- Standing-Height Support Pedestals bottom two file drawers are locking.
- Standing-Height Bookcase Support contains easy-access, fixed storage shelves.

3. Select the modesty panel/privacy screen that works in conjunction with the supports you have specified.

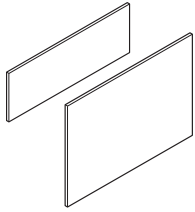

**14" H Full Width/
Half-height
Laminate Modesty
Panel**
28", 34", 40"W
(Modesty Size)
**28" H Full-to-Floor/
Full-Length
Laminate Modesty
Panel**
28", 34", 40"W
(Modesty Size)

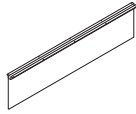

**Laminate Floating
Modesty Panel**
30"W x 14"H, 36"W x
14"H, 42"W x 14"H,
48"W x 14"H, 54"W x
14"H, 60"W x 14"H

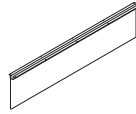

**Mixed Material
Floating Modesty
Panel**
30"W x 14"H, 36"W x
14"H, 42"W x 14"H,
48"W x 14"H, 54"W x
14"H, 60"W x 14"H
Available in Frosted
Translucent only

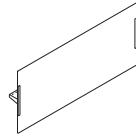

**Above/Below
Privacy Screen**
30"W x 28"H, 36"W x
28"H, 42"W x 28"H,
48"W x 28"H, 54"W
x 28"H, 60"W x 28"H
Available in Frosted
Translucent only

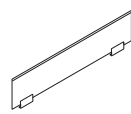

**Above Privacy
Screen**
30"W x 13"H, 36"W x
13"H, 42"W x 13"H,
48"W x 13"H, 54"W x
13"H, 60"W x 13"H
Available in Frosted
Glass only

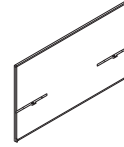

**Above/Below Fabric
Screen**
36"W x 35"H, 42"W
x 35"H, 48"W x 35"H,
54"W x 35"H, 60"W
x 35"H, 66"W x 35"H,
72"W x 35"H

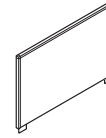

Above Fabric Screen
20"W x 20"H, 20"W
x 13"H, 24"W x 20"H,
24"W x 13"H, 30"W x
20"H, 30"W x 13"H,
36"W x 20"H, 36"W
x 13"H

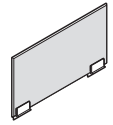

**Above Polymer or
Glass (Side) Screen**
20"W x 13"H, 24"W x
13"H, 30"W x 13"H,
36"W x 13"H

Tips

- Mixed material and laminate floating modesty panels create a lighter scale look by attaching to the top of the worksurface.
- Choose from a variety of materials to create your desired look.
- Laminate modesty panels to create a more conventional look.
- 54"W and 60"W Floating Modesty panels eliminate the need for an external channel.
- Above Privacy Screens provide a division between two worksurfaces and create a division of space in an open plan area.
- Modesty panels cannot be used as a support.
- See modesty panel chart to choose proper modesty size depending on support options.

4. Select Above the Worksurface Storage (Stack-on Storage) or Overhead Cabinets

Select the above the worksurface storage that meets your storage criteria, choose from overhead cabinets, panel mounted storage, conventional or contemporary stack-on storage.

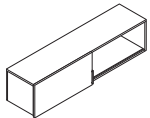

**14 1/4" D x 14" H Shared Overhead
Cabinet with One Sliding Door**
60", 72"

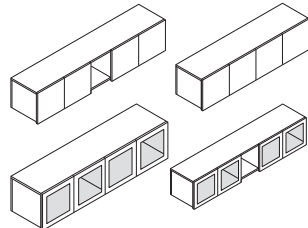

**14 1/4" Overhead Cabinet with 4 Laminate
Doors with or without Cubbie or 4 Frosted
Metal Doors with or without Cubbie**
36", 42", 48" and 60" with 4 Laminate or
Frosted Doors
60", 66" and 72" with Laminate or
Frosted Doors and Cubbie

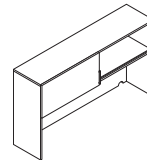

**14 1/4" D x 35" H Stack-on Storage,
Built-up, with Sliding Doors**
72" W only

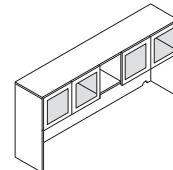

**14 1/4" D x 35" H Stack-on Storage, Built-up,
4 Frosted Metal Doors with Cubbie**
72" W only with Laminate or Frosted Doors
and Cubbie

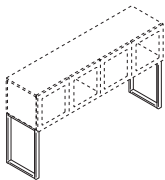

**O-Leg Support for Overhead
Cabinet**
50"-14 1/8" D x 5 1/2" H
65"-14 1/8" D x 20 1/2" H

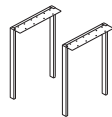

Post Legs for Shared Storage
14" H and 22" H

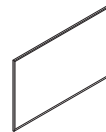

**Tackboard for Overhead Cabinet Applications
Tackboard for Built-up Stack-on Storage**
72" W only

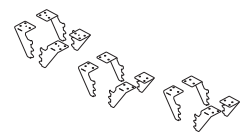

**Panel Mount Bracket for Shared
Overhead**
Abound and Accelerate

Tips

- Select sliding or hinged doors.
- Specify O-leg separately for a contemporary look.
- Optional storage shelf works in conjunction with the O-leg design to provide additional storage space. Only works with 65" H O-legs.
- O-legs come in two sizes to make a 50" H or 65" H stack-on storage unit.
- Wall mount brackets carry a \$157 upcharge and are specified the model ordering logic.
- Use shared overhead and attachments in small footprint applications.
- Shared overhead must be ordered as left or right to determine open storage location.
- Shared overhead panel mount brackets and overhead post legs allow overhead to span over all panels systems or run down the spine wall, centered on top of the panel.
- Use the 65" H for a more conventional design. 65" H and 50" H aligns with Abound and Accelerate.
- Stack-on Storage must be placed over two full-height supports. Cannot be placed over non-supported sections such as returns using a flat bracket or tower-to-worksurface bracket.
- If the end panel conventional look is preferred, order the built-up stack-on storage models.
- There are two types of tackboards for use on Overhead Cabinet and Stack-on Storage.

VOI® SPECIFYING/DESIGN GUIDE

5. Select the right storage.

Choose from a variety of below the worksurface, as well as traditional, storage options.

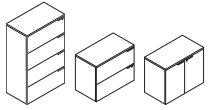

Laterals and Storage Cabinet

2-Drawer Lateral, 4-Drawer Lateral, Storage Cabinet
 36"W x 24"D x 29½"H, 36"W x 20"D x 29½"H,
 36"W x 24"D x 57"H, 36"W x 20"D x 57"H,
 36"W x 24"D x 29½"H, 36"W x 20"D x 29½"H

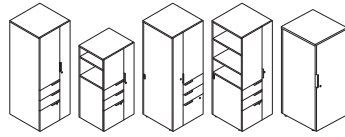

Storage Towers

18"W x 20"D, 18"W x 24"D, 24"W x 20"D, 24"W x 24"D, 50"H and 65"H
Storage Tower, One Door
 18"W x 20"D x 42"H
 Available in Footed Option

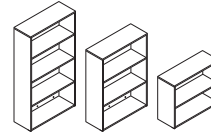

Bookshelves

36"W x 13"D x 29½"H (2 Shelf)
 36"W x 13"D x 50"H (3 Shelf)
 36"W x 13"D x 65"H (4 Shelf)

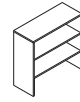

Bookcase Hutch without Doors

36"W x 14"D x 35"H

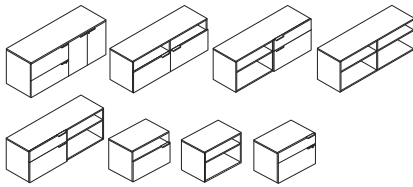

Credenzas

Credenza: 24"D x 72"W x 29½"H
 Low Credenzas: 20"D x 21½"H x 30", 36", 60", 72"W
 Low Credenzas with a variety of door/drawer options
 Limited dimensions available in Footed Option

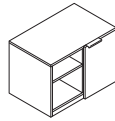

Mobile Credenza

30"W x 20"D x 21½"H

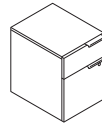

Mobile Pedestal

15¾"W x 20¼"D x 21⅞"H
 Available in Footed Option

Tips

- Small credenza models can be used in small footprint applications.
- Can use pedestal or credenza seat cushions on smaller credenza models.
- Low credenzas work in conjunction with worksurface 7" O-leg designed to create a unique layering design.
- Bookcase/laterals and other conventional storage components provide additional storage space.
- Must specify chassis and drawer front color separately.
- Low Credenzas, Laterals and Mobile Pedestals have seat cushions to create additional seating in the workspace.
- Storage and Personal Tower models offer conventional storage as well as wardrobes with a coat rod.
- A worksurface-to-tower bracket kit allows the attachment of worksurfaces to Storage and Personal Tower models.
- Telescoping ball-bearing slides used on box and file drawers. Lateral drawers use a progressive ball-bearing slide.

6. Select Accessories to add color, additional storage and organization to your workspace.

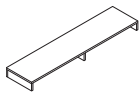

Layering Shelf

60"W x 14¼"D x 5½"H
 72"W x 14¼"D x 5½"H

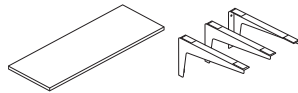

Shelves and Shelf Brackets

Shelf Depth: 13"
 Shelf Widths: 30", 36", 45"
 Bracket sold separately, set of three

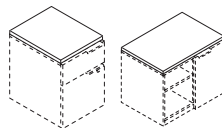

Seat Cushion for Credenzas and Mobile Credenza/Pedestal

Pedestal Cushion
 15⅞"W x 20"D x 2"H
Credenza Cushion
 20"W x 30"D x 2"H, 20"W x 36"D x 2"H

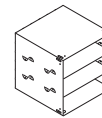

Metal Storage Cube

12" x 12"

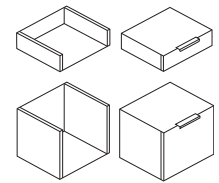

Laminate Storage Cubes

15"W x 13"D x 4"H
 15"W x 13"D x 12"H

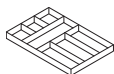

Drawer Organizer

12"W x 14½"D x 1½"H

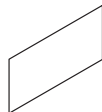

Markerboard for Shared Overhead

30"W x 15"D for use with 60"W Shared Overhead
 36"W x 15"D for use with 72"W Shared Overhead

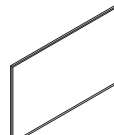

Markerboard

48"W x 31"H



LED Task Light

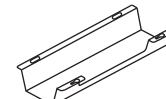

Cable Management Trough

17"W

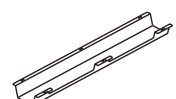

Cable Management Trough

36"W

Tips

- Choose from many bright Storage Cube colors for a colorful design element while providing additional storage.
- Use the Drawer Organizer to keep small items in order. Also offered in the same bright Storage Cube colors.
- Layering shelves are great for filing and piling or in conjunction with the lower credenza.
- Optimize shared overhead capabilities by adding the Markerboard for Shared Overhead.

VOI® AND SYSTEMS INTEGRATION

Worksurface Applications

Either Voi or Systems worksurfaces can be used with Voi in an open plan application. There are several support options:

- A. Completely panel supported.
- B. Combination of panel supported and another worksurface support such as:
 - Bookcase support
 - Pedestal (Brigade®, Flagship®, Contain®, or Voi®)
 - Systems open leg
 - Voi O-leg
 - End panel (Systems or Voi)
 - Tower to worksurface bracket
 - Support column
 - Systems round post leg
 - Voi post leg
- C. Freestanding:
 - Bookcase support
 - Two pedestals (Brigade®, Flagship®, Contain®, or Voi®)
 - Two Voi O-legs
 - One Voi O-leg and one Voi O-leg support for lower credenzas
 - Two end panels (metal or Voi)—requires metal or Voi modesty panel
 - Four (Two 2-Pack) Voi angled legs, wood or steel
 - Two Voi angled legs, steel and two Voi steel stanchion supports for low credenzas

Additional application guidelines for worksurfaces:

- Systems worksurfaces are available with grommets or no grommets.
- When Voi lower credenzas are used along the spine wall and are placed adjacent to the wing wall, one electrical/data cutout on the wing wall will be blocked.
- When Voi credenzas are used along the wing wall and are placed adjacent to the spine wall, one electrical/data cutout on the spine wall will be blocked.
- When the Voi O-leg support for credenzas is used, it is recommended to also panel attach the worksurface with the worksurface anti-dislodgement bracket kit HWSA2.
- When the Voi O-leg support is used with panels, it is recommended to also panel attach the O-leg to the panel with the O-leg to panel bracket kit HLSPPB (left) and/or HLSPPR (right). This bracket will provide additional workstation rigidity.
- When the Voi end panel support is used with panels, it is recommended to use the end panel support with panel bracket model. This model will provide additional workstation rigidity.
- The worksurface to tower bracket kit, HSTB2W1, will work with Voi towers, Voi worksurfaces, and systems worksurfaces.
- Knife Edge surfaces are recommended to only use angled post legs as supports.
- Knife Edge worksurfaces are intended to be stand-alone. Surface gaps may occur if connecting to a panel or using return worksurfaces.

Application Guidelines—Combination of Panel Supported and Another Worksurface Support

- For applications where 1) the worksurface is perpendicular to the spine wall; 2) the worksurface is panel supported off the spine wall; and 3) there are Voi credenzas placed under the worksurface along the spine: there is not enough clearance to use standard worksurface cantilevers to attach the worksurface to the spine. Use the worksurface anti-dislodgement bracket kit HWSA2 to panel attach the worksurface in lieu of cantilevers.

Panel Mounted Stack-on Storage Applications

- The Voi stack-on storage cabinets can be used on Abound and Accelerate as panel mounted overheads.
- The sliding door stack-on storage units are available in 36", 42", 48" widths in addition to 60", 66", and 72" widths.
- The 4 door stack-on storage units are only available in 36", 42", 48", 60", 66", and 72" widths.
- The storage units require a storage to panel bracket kit, model HLSPMB. This model includes one left hand, one right hand, and one center bracket. The brackets are available in all P1 and P2 paint colors.
- The storage cabinets do not have off modular capabilities.
- For proper installation and support, the storage units must follow the following specification rules:
 - There should be a storage unit of the same construction on each side of a given panel.
 - The storage units on opposite sides of a given panel should be in the same location vertically and horizontally.
 - Only one storage unit per panel, per side.
 - The wing panel adjacent to the spine wall needs to be the same height as the spine wall.

Contact HON's Integrated Design Services team with specification questions.

VOI® Laminate Worksurfaces — Rectangle

GSA SIN 33721



Icon Legend on page 19

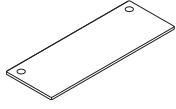

DESCRIPTION	MODEL	SHIP WEIGHT	CUBE	LIST PRICE BY LAMINATE GRADE	
				L1	L2
Rectangle Worksurfaces					
36"W x 20"D	HLSLR2036	40	2.2	\$319	\$330
42"W x 20"D	HLSLR2042	46	2.6	\$355	\$366
48"W x 20"D	HLSLR2048	52	2.9	\$382	\$393
54"W x 20"D	HLSLR2054	64	3.5	\$428	\$444
60"W x 20"D	HLSLR2060	70	3.5	\$471	\$487
66"W x 20"D	HLSLR2066	76	4.2	\$512	\$528
72"W x 20"D	HLSLR2072	82	4.2	\$526	\$542
36"W x 24"D	HLSLR2436	47	2.6	\$333	\$349
42"W x 24"D	HLSLR2442	54	3.0	\$374	\$390
48"W x 24"D	HLSLR2448	61	3.4	\$405	\$421
54"W x 24"D	HLSLR2454	68	4.2	\$435	\$456
60"W x 24"D	HLSLR2460	75	4.2	\$473	\$494
66"W x 24"D	HLSLR2466	82	5.0	\$514	\$535
72"W x 24"D	HLSLR2472	89	5.0	\$531	\$552
84"W x 24"D	HLSLR2484	103	5.7	\$779	\$806

NOTES:

- Systems worksurfaces can be used with all Voi components.
- Worksurfaces are abrasion- and stain-resistant laminate over durable 1/8" solid core high performance particleboard: resists wrapping.
- There is one 3" grommet in 36"W and 42"W worksurfaces and two in 48"W-84"W worksurfaces.
- One flat bracket ships with each worksurface.
- When attaching tops to panels, refer to Systems section of this pricer.
- Square edge detail.
- When using a floating modesty panel or an external channel under the worksurface, the depth clearance for keyboard trays and center drawers decreases by 8". See accessory matrix in accessory section of the pricer.
- 3" Power Hub model HGRMTAC can be interchanged with 3" standard grommet.
- ! Voi® worksurfaces cannot be used with Abode™ Desks components.
- ! Grommets in worksurfaces must be specified. If grommets are specified, grommets come in predetermined location.
- ! Edgeband option only on all Voi worksurfaces. For edgeband options, see matrix on page 173.
- ! When specifying an 84" Worksurface, cannot use two O-legs, must use at least one additional support such as a pedestal or lateral file.
- ! When using a worksurface as a bridge, no additional supports are needed. One support is required for returns, two supports are required for desks and credenzas.
- ! Lateral file or multi files must be used with surfaces 24"D and 60"W or greater.
- ! Depending on your support combination, an external channel may be required for extra support on unsupported spans greater than 54"W. Please see the matrix on page 191 for more details.
- ! If using a 54"W or 60"W floating modesty, it is not necessary to spec an external channel.
- ! When attaching worksurfaces to panels, one or more of the following are required: anti-dislodgement brackets, end panel, support leg and/or cantilevers. Cantilevers and anti-dislodgement brackets must be ordered separately when attaching worksurfaces to panels.
- ! A return worksurface is considered 48"W or shorter. Longer returns cannot be supported by a flat bracket only.

HOW TO SPECIFY**Select Model Number**

HLSLR2036

Select Worksurface Laminate and Edge Color

See page 173

NN

Select Grommet Option and Color

- X** No Grommet If choosing the grommet option
G Grommet Select Grommet Color
 See page 173

GT5



	DESCRIPTION	MODEL	SHIP WEIGHT	CUBE	LIST PRICE BY LAMINATE GRADE	
					L1	L2
	Rectangle Worksurfaces					
	36"W x 30"D	HLSLR3036	58	3.2	\$382	\$398
	42"W x 30"D	HLSLR3042	67	3.7	\$410	\$426
	48"W x 30"D	HLSLR3048	75	4.2	\$435	\$451
	54"W x 30"D	HLSLR3054	84	5.1	\$483	\$504
	60"W x 30"D	HLSLR3060 Ⓞ	92	5.1	\$541	\$562
	66"W x 30"D	HLSLR3066 Ⓞ	101	6.1	\$582	\$603
	72"W x 30"D	HLSLR3072 Ⓞ	110	6.1	\$633	\$654
	84"W x 30"D	HLSLR3084	127	7.0	\$861	\$888
	60"W x 36"D	HLSLR3660	110	6.1	\$676	\$703
66"W x 36"D	HLSLR3666	120	7.2	\$731	\$758	
72"W x 36"D	HLSLR3672	130	7.2	\$819	\$846	

NOTES:

- Systems worksurfaces can be used with all Voi components.
- Worksurfaces are abrasion- and stain-resistant laminate over durable 1½" solid core high performance particleboard: resists wrapping.
- There is one 3" grommet in 36"W and 42"W worksurfaces and two in 48"W-84"W worksurfaces.
- One flat bracket ships with each worksurface.
- When attaching tops to panels, refer to Systems section of this pricer.
- Square edge detail.
- When using a floating modesty panel or an external channel under the worksurface, the depth clearance for keyboard trays and center drawers decreases by 8". See accessory matrix in accessory section of the pricer.
- 3" Power Hub model HGRMTAC can be interchanged with 3" standard grommet.
- ⚠ Voi® worksurfaces cannot be used with Abode™ Desks components.
- ⚠ Grommets in worksurfaces must be specified. If grommets are specified, grommets come in predetermined location.
- ⚠ Edgeband option only on all Voi worksurfaces.
- ⚠ When specifying an 84" Worksurface, cannot use two O-legs, must use at least one additional support such as a pedestal or lateral file.
- ⚠ When using a worksurface as a bridge, no additional supports are needed. One support is required for returns, two supports are required for desks and credenzas.
- ⚠ Lateral file or multi files must be used with surfaces 24"D and 60"W or greater.
- ⚠ Depending on your support combination, an external channel may be required for extra support on unsupported spans greater than 54"W. Please see page 191 for models and a matrix to aid in specifying.
- ⚠ If using a 54"W or 60"W floating modesty, it is not necessary to spec an external channel.
- ⚠ When attaching worksurfaces to panels, one or more of the following are required: anti-dislodgement brackets, end panel, support leg and/or cantilevers. Cantilevers and anti-dislodgement brackets must be ordered separately when attaching worksurfaces to panels.
- ⚠ A return worksurface is considered 48"W or shorter. Longer returns cannot be supported by a flat bracket only.

HOW TO SPECIFY

Select Model Number <div style="border: 1px solid black; padding: 2px; display: flex; gap: 5px;"> HLSLR3036 </div>	Select Worksurface Laminate and Edge Color See page 173 <div style="border: 1px solid black; padding: 2px; display: flex; gap: 5px;"> NN </div>	Select Grommet Option and Color X No Grommet If choosing the grommet option G Grommet Select Grommet Color See page 173 <div style="border: 1px solid black; padding: 2px; display: flex; gap: 5px;"> GT5 </div>
---	--	--

Laminate Worksurfaces — Rectangle

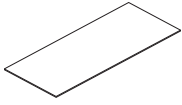
	DESCRIPTION	MODEL	SHIP WEIGHT	CUBE	LIST PRICE BY LAMINATE GRADE	
					L1	L2
	Rectangle Worksurfaces Top with Knife Edge					
	48"W x 24"D	HLSLR2448J	54	3.4	\$553	\$569
	60"W x 24"D	HLSLR2460J	75	4.2	\$645	\$666
	72"W x 24"D	HLSLR2472J	89	5.0	\$725	\$746
	48"W x 30"D	HLSLR3048J	75	4.2	\$595	\$611
	60"W x 30"D	HLSLR3060J	92	5.1	\$738	\$759
	72"W x 30"D	HLSLR3072J	110	6.1	\$863	\$884

NOTES:

- Systems worksurfaces can be used with all Voi® components.
- Worksurfaces are abrasion- and stain-resistant laminate over durable 1½" solid core high performance particleboard: resists wrapping.
- There are two 3" grommets in Knife Edge worksurfaces, if specified.
- When using a floating modesty panel or an external channel under the worksurface, the depth clearance for keyboard trays and center drawers decreases by 8". See accessory matrix in accessory section of the pricer.
- 3" Power Hub model HGRMTAC can be interchanged with 3" standard grommet.
- ! Voi® worksurfaces cannot be used with Abode™ Desks components.
- ! Grommets in worksurfaces must be specified. If grommets are specified, grommets come in predetermined location.
- ! Depending on your support combination, an external channel may be required for extra support on unsupported spans greater than 54"W. Please see the matrix on page 191 for more details.
- ! If using a 54"W or 60"W floating modesty, it is not necessary to spec an external channel.
- ! Voi® Knife Edge surfaces are recommended to only use angled post legs as supports.
- ! Knife Edge worksurfaces are intended to be stand-alone. Surface gaps may occur if connecting to a panel or using return worksurfaces.

HOW TO SPECIFY

Select Model Number HLSLR2448J	Select Worksurface Laminate and Edge Color See page 173 NN	Select Grommet Option and Color X No Grommet G Grommet If choosing the grommet option, select Grommet Color. See page 173. GT1
--	---	---

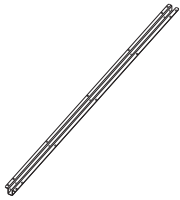

DESCRIPTION

External Support Channel
 36"W for a 48" Worksurface
 42"W for a 54" Worksurface
 48"W for a 60" Worksurface
 54"W for a 66" Worksurface
 60"W for a 72" Worksurface
 72"W for an 84" Worksurface

MODEL

SHIP WEIGHT

CUBE

LIST PRICE

HLSLZ5SC48	5	0.5	\$118
HLSLZ5SC54 Ⓞ	5	0.5	\$129
HLSLZ5SC60 Ⓞ	6	0.5	\$135
HLSLZ5SC66 Ⓞ	7	0.5	\$141
HLSLZ5SC72 Ⓞ	7	0.5	\$152
HLSLZ5SC84	12	0.7	\$152

- ⓘ Available in Graphite paint only.
- ⓘ When specifying panel-hung worksurfaces, specify external channel as if supported by two O-legs via selection chart.
- ⓘ When specifying a 54"W or 60"W Floating Modesty Panel, it is not necessary to specify an external channel.

EXTERNAL CHANNEL SELECTION GUIDE

Support Combination		Worksurface Width for Rectangle, Wedge, and Saddle				
Support 1	Support 2	84 in	72 in	66 in	60 in	54 in
O-Leg	O-Leg	NA	HLSLZ5SC72	HLSLZ5SC66	HLSLZ5SC60	HLSLZ5SC54
O-Leg	Slim Profile Pedestal	HLSLZ5SC84	HLSLZ5SC66	HLSLZ5SC60	HLSLZ5SC54	NA
O-Leg	Bookcase	HLSLZ5SC72	HLSLZ5SC66	HLSLZ5SC60	HLSLZ5SC54	NA
O-Leg	Pedestal	HLSLZ5SC72	HLSLZ5SC60	HLSLZ5SC54	NA	NA
O-Leg	End-Panel	HLSLZ5SC84	HLSLZ5SC60	HLSLZ5SC54	NA	NA
Slim Profile Pedestal	Slim Profile Pedestal	HLSLZ5SC72	HLSLZ5SC60	HLSLZ5SC54	NA	NA
Slim Profile Pedestal	Bookcase	HLSLZ5SC72	HLSLZ5SC60	HLSLZ5SC54	NA	NA
Slim Profile Pedestal	Pedestal	HLSLZ5SC66	HLSLZ5SC54	NA	NA	NA
Slim Profile Pedestal	End-Panel	HLSLZ5SC66	HLSLZ5SC54	NA	NA	NA
Pedestal	Bookcase	HLSLZ5SC66	HLSLZ5SC54	NA	NA	NA
End-Panel	Bookcase	HLSLZ5SC66	HLSLZ5SC54	NA	NA	NA
Bookcase	Bookcase	HLSLZ5SC66	HLSLZ5SC54	NA	NA	NA
End-Panel	End-Panel	HLSLZ5SC60	NA	NA	NA	NA
Pedestal	Pedestal	HLSLZ5SC60	NA	NA	NA	NA
Pedestal	End-Panel	HLSLZ5SC60	NA	NA	NA	NA
O-Leg	Lateral/Multifile	HLSLZ5SC54	NA	NA	NA	NA
Bookcase	Lateral/Multifile	NA	NA	NA	NA	NA
Slim Profile Pedestal	Lateral/Multifile	NA	NA	NA	NA	NA
Pedestal	Lateral/Multifile	NA	NA	NA	NA	NA
End-Panel	Lateral/Multifile	NA	NA	NA	NA	NA
Height Adjustable Base	NA	HLSLZ5SC72	HLSLZ5SC60	HLSLZ5SC54	HLSLZ5SC48	NA

*All Rudder worksurfaces use external channel model HLSLZ5SC60.

HOW TO SPECIFY

<p>Select Model Number</p> <p>H L S L Z 5 S C 8 4 .</p>	<p>Select Paint Color</p> <p>See page 173</p> <p>P</p>
--	---

VOI® Worksurface Supports

GSA SIN 33721

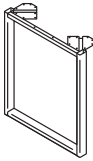
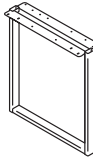
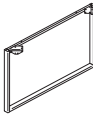
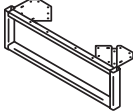
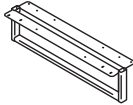

Icon Legend on page 19

	DESCRIPTION	MODEL	SHIP WEIGHT	CUBE	LIST PRICE BY PAINT GRADE		
					P1	P2	P3
	O-Leg Support for Worksurfaces						
	20"D x 28½"H	HLSL2028O	15	3.7	\$394	\$399	\$415
	24"D x 28½"H	HLSL2428O	17	3.7	\$428	\$433	\$449
	30"D x 28½"H	HLSL3028O ⓘ	19	5.4	\$474	\$479	\$495
	NOTES: Ship fully assembled, 1/pack. Non-handed. ⓘ Specify paint only. SPECIFYING EXAMPLE: HLSL2028O.T1						
	O-Leg Shared Support for Worksurfaces						
	20"D x 28½"H	HLSL2028SL	15	3.7	\$471	\$476	\$492
	24"D x 28½"H	HLSL2428SL	17	3.7	\$531	\$536	\$552
	30"D x 28½"H	HLSL3028SL ⓘ	19	5.4	\$589	\$594	\$610
	NOTES: Ship fully assembled, 1/pack. Non-handed. ⓘ Specify paint only. SPECIFYING EXAMPLE: HLSL2028SL.T1						
	Double-Depth O-Leg Support for Worksurfaces						
	48"D x 28½"H	HLSL4828O	18	7.0	\$803	\$812	\$824
	60"D x 28½"H	HLSL6028O	19	8.7	\$893	\$902	\$914
	NOTES: Ship fully assembled, 1/package. Non-handed.						
	O-Leg Support for Low Credenzas						
	20"D x 7"H	HLSL207O	5	1.0	\$267	\$272	\$288
	24"D x 7"H	HLSL247O	6	1.0	\$288	\$293	\$309
	30"D x 7"H	HLSL307O ⓘ	7	1.0	\$366	\$371	\$387
	NOTES: Ship fully assembled, 1/pack. Non-handed. ⓘ Specify paint only. SPECIFYING EXAMPLE: HLSL207O.T1						
	O-Leg Shared Support for Low Credenzas						
	20"D x 7"H	HLSL207SL	5	1.0	\$331	\$336	\$352
	24"D x 7"H	HLSL247SL	6	1.0	\$359	\$364	\$380
	30"D x 7"H	HLSL307SL	7	1.0	\$455	\$460	\$476
	NOTES: Ship fully assembled, 1/pack. Non-handed. ⓘ Specify paint only. SPECIFYING EXAMPLE: HLSL207SL.T1						

NOTES:









- A variety of pedestals, end panels, and O-legs can be combined to create a conventional or contemporary desk.
- O-leg ships fully assembled with mounting hardware.
- Shared O-Legs create a cleaner aesthetic in all applications where two legs are used side-by-side.
- Shared O-Leg bracket will span both worksurfaces to provide the same support with the look of a single O-leg.
- Will have a 6" overhang when using 30" worksurface supports with a 36"D worksurface.
- Glides on O-Leg Support for Worksurfaces and Post Leg Base have 2" of adjustability. No glides on 7"H O-leg. Glides on end panels have 1¼" adjustability.

ⓘ O-legs may only be attached to worksurfaces, not storage units.

HOW TO SPECIFY

Select Model Number	Select Paint Color
	See page 173
HLSL2028O	T1

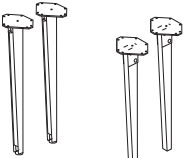
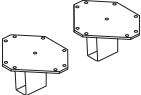
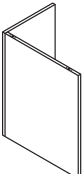
Icon Legend on page 19

	DESCRIPTION	MODEL	SHIP WEIGHT	CUBE	LIST PRICE BY PAINT GRADE		
					P1	P2	P3
  	Post Leg Base 28½" H x 2" square ! Post leg cannot be used on primary worksurface with an O-leg as the other support. ! Post leg can only be used to support peninsula, not as primary supports for a top.	HLSL28P	15	1.0	\$385	\$390	\$406
  	28½" H O-Leg-to-Panel Attachment Bracket 28½" H Left handed bracket (quantity 1) 28½" H Right handed bracket (quantity 1) NOTES: Used to connect Voi O-Leg to a systems panel for additional workstation rigidity. Bracket designed to work with edgeband worksurfaces only. Brackets are handed, come one per package and include self-tapping screws. Specify paint.	HLSLPBL ☺ HLSLPBR ☺	3 ☹ 3 ☹	0.4 0.4	\$134 \$134	\$139 \$139	N/A N/A
 HLSL28AM2 HLSL28AW2	Angled Legs 12" W x 8" D x 32" H Steel — 2-Pack 12" W x 8" D x 32" H Wood — 2-Pack NOTES: Angled Steel Legs come equipped with a removable wire management channel in each leg. ! 4" H Stanchions to be used on floor storage with feet ONLY. ! O-Leg Support to be used on floor storage without feet ONLY. ! Wood legs use natural wood material. The color on each leg may contain natural variation. ? Pricing shown is <u>per carton</u> . Ordering 2 of either model will result in 2 cartons being shipped, giving you 4 legs.	HLSL28AM2 ☺ HLSL28AW2	15 ☹ 14 ☹	1.3 1.5	\$427 \$553	\$436 \$553	\$448 \$553
	Steel Stanchions — 2-Pack 4" H ! 4" H Stanchions to be used on floor storage with feet ONLY. ! O-Leg Support to be used on floor storage without feet ONLY. ! Wood legs use natural wood material. The color on each leg may contain natural variation. ? Pricing shown is <u>per carton</u> . Ordering 2 of either model will result in 2 cartons being shipped, giving you 4 legs.	HLSL4AM2	5 ☹	0.2	\$201	\$210	\$222
  	End Panel Support 16" W x 20" D x 28½" H 16" W x 24" D x 28½" H 16" W x 30" D x 28½" H NOTES: Ship in two pieces.	HLSL2028E HLSL2428E HLSL3028E	39 44 50	3.2 3.7 4.2	\$255 \$274 \$293	\$266 \$285 \$304	

NOTES:

- A variety of pedestals, end panels, and O-legs can be combined to create a conventional or contemporary desk.
- Voi® square support column is interchangeable with the Systems worksurface round support column: HCNLEG29.
- Glides on Post Leg Base have 2" of adjustability. Glides on end panels have 1¼" adjustability.

HOW TO SPECIFY

<p>Select Model Number</p> <p>H L S L 2 0 2 8 E</p>	<p>Select Laminate/Paint</p> <p>See page 173</p> <p>H</p>
---	---

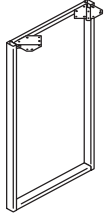
**DESCRIPTION****Standing-Height O-Leg Support for Worksurfaces**

24"D x 41"H

30"D x 41"H

MODEL**HLSL2441O****HLSL3041O****SHIP WEIGHT**

16

17

CUBE

5.3

6.5

LIST PRICE BY PAINT GRADE**P1****\$571****\$639****P2****\$578****\$646****P3****\$592****\$660**

NOTES: Ship fully assembled, 1/package. Non-handed.

Coordinate™ Power Modules will work with standing-height applications for 10500™ and Voi® desks. Please see pages 723-724 for more information.

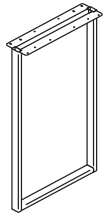
**Standing-Height O-Leg Shared Support for Worksurfaces**

24"D x 41"H

30"D x 41"H

HLSL2441SL**HLSL3041SL**

16

17

5.3

6.5

\$644**\$711****\$651****\$718****\$665****\$732**

NOTES: Ship fully assembled, 1/package. Non-handed.

Coordinate™ Power Modules will work with standing-height applications for 10500™ and Voi® desks. Please see pages 723-724 for more information.

**Standing-Height O-Leg to Panel Attachment Bracket**

41"H Left-hand Bracket

41"H Right-hand Bracket

HLSLSPBL**HLSLSPBR**

6

6

1.0

1.0

\$169**\$169****\$174****\$174****N/A****N/A**

NOTES: 1/package. Brackets are handed as shown above. To be used with 41"H O-legs shown above (HLSL2441O and HLSL3041O).

NOTES:

- O-leg glides have 2" adjustability.
- O-Leg to Panel Attachment Brackets are used to connect Voi® O-Legs to a systems panel for additional worksurface rigidity.

 O-legs may only be attached to worksurfaces, not storage units.

HOW TO SPECIFY**Select Model Number**

HLSL2441O

Select Paint Color

See page 173

T1



Icon Legend on page 19

Standing-Height Laminate Support

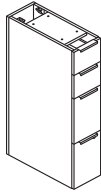

DESCRIPTION

MODEL

SHIP WEIGHT

CUBE

L1 LIST

L2 UPCHARGES
CHASSIS FRONTS

Standing-Height Support Pedestals — Box/Box/File/File

9½"W x 24"D x 41"H

HLSL2441S

94

11.9

\$1983

\$42

\$21

9½"W x 30"D x 41"H

HLSL3041S

113

14.7

\$2060

\$48

\$21

NOTES: Top two drawers are non-locking.

❗ Cannot use grommet worksurfaces with Standing-Height Support Storage.

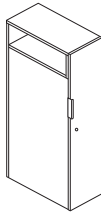

Standing-Height Side Access Storage Tower

12"W x 24"D x 50"H - Left

HLSLW1224L

100

11.0

\$1808

\$37

\$21

12"W x 24"D x 50"H - Right

HLSLW1224R

100

11.0

\$1808

\$37

\$21

12"W x 30"D x 50"H - Left

HLSLW1230L

121

13.6

\$1886

\$37

\$21

12"W x 30"D x 50"H - Right

HLSLW1230R

121

13.6

\$1886

\$37

\$21

NOTES:

- Tower includes coat hook on back of door.
- Chassis and drawer front panels can be specified separately.
- Tower door is locking. Ships with one handle.
- Support Pedestals bottom file drawers will lock, top box drawers will not.
- Standing-Height Pedestals will have 6" overhang when using 30"D support storage with a 36"D worksurface.
- Use the worksurface to tower bracket kit model HSTB2W1 on page 219 to attach worksurfaces to the Storage Tower models.

❗ Pedestals ship fully assembled but must attach to a worksurface with a quick release bracket, provided. Pedestals are non-handed and are interchangeable.

❗ Locking units equipped with HON "One Key" interchangeable core removable locks. Keyed alike core must be ordered separately.

HOW TO SPECIFY

<p>Select Model Number</p> <p>H L S L 2 4 4 1 S</p>	<p>Select Chassis Laminate</p> <p>See page 173</p> <p>N</p>	<p>Select Drawer Front Laminate</p> <p>See page 173</p> <p>N</p>	<p>Select Pull Color</p> <p>See page 173</p> <p>T 4</p>
--	--	---	--

VOI® Coordinate™ Sit-to-Stand Worksurfaces

GSA SIN 33721



Icon Legend on page 19

	DESCRIPTION	MODEL	SHIP WEIGHT	CUBE	LIST PRICE BY LAMINATE GRADE	
					L1	L2
	Rectangle Worksurfaces					
	48"W x 24"D	HLSLR2448	61	3.4	\$405	\$421
	54"W x 24"D	HLSLR2454	68	4.2	\$435	\$456
	60"W x 24"D	HLSLR2460	75	4.2	\$473	\$494
	66"W x 24"D	HLSLR2466	82	5.0	\$514	\$535
	72"W x 24"D	HLSLR2472	89	5.0	\$531	\$552
	Rectangle Worksurfaces					
	48"W x 30"D	HLSLR3048	75	4.2	\$435	\$451
	54"W x 30"D	HLSLR3054	84	5.1	\$483	\$504
	60"W x 30"D	HLSLR3060	92	5.1	\$541	\$562
	66"W x 30"D	HLSLR3066	101	6.1	\$582	\$603
	72"W x 30"D	HLSLR3072	110	6.1	\$633	\$654

HOW TO SPECIFY

<p>Select Model Number</p> <p>HLSLR2448</p>	<p>Select Worksurface Laminate and Edge Color</p> <p>See page 173</p> <p>NN</p>	<p>Select Grommet Option and Color</p> <p>X No Grommet If choosing the grommet option G Grommet Select Grommet Color See page 173</p> <p>GT5</p>
--	--	---

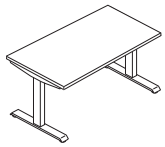

DESCRIPTION

Coordinate™ Height Adjustable Base – 2-Stage

2-Leg Rectangle T Foot
2-Leg Rectangle C Foot

MODEL

HHATB2S2LT ⓘ
HHATB2S2LC

SHIP WEIGHT

66 ⓘ
66 ⓘ

CUBE

2.4
2.4

LIST PRICE

\$1058
\$1058

NOTES:

- Dual motor two-leg design. Legs raise from 25⁵/₈" to 45¹/₄".
- Base accommodates any rectangular worksurface between 23"D x 40"W and 30"D x 72"W.
- Weight capacity of 250 lbs. (including the weight of the worksurface) distributed evenly.

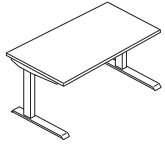

Coordinate™ Height Adjustable Base – 3-Stage

2-Leg Rectangle T Foot
2-Leg Rectangle C Foot

HHATB3S2LT ⓘ
HHATB3S2LC

66 ⓘ
66 ⓘ

2.4
2.4

\$1167
\$1167

NOTES:

- Dual motor two-leg design. Legs raise from 21⁵/₈" to 47³/₄".
- Base accommodates any rectangular worksurface between 23"D x 40"W and 30"D x 72"W.
- Weight capacity of 250 lbs. (including the weight of the worksurface) distributed evenly.

Coordinate™ Height Adjustable Base – Max 3-Stage

2-Leg Rectangle T Foot

HHATM3S2LT

66 ⓘ

2.4

\$1307

NOTES:

- Dual motor two-leg design. Legs raise from 21⁵/₈" to 47³/₄".
- Base accommodates any rectangular worksurface between 23"D x 40"W and 30"D x 96"W.
- Weight capacity of 350 lbs. (including the weight of the worksurface) distributed evenly.

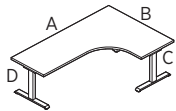

Coordinate™ Height Adjustable Base – 3-Stage

3-Leg Rectangle T Foot
3-Leg Rectangle C Foot

HHATB3S3LT
HHATB3S3LC

91
91

3.6
3.6

\$1925
\$1925

NOTES:

- Tri-motor three-leg design. Legs raise from 21⁵/₈" to 47³/₄".
- Base accommodates worksurfaces between 23"D x 40"W x 40"W and 30"D x 72"W x 72"W. Can be used with 48" 120° worksurface models.
- Weight capacity of 375 lbs. (including the weight of the worksurface) distributed evenly.

- ⓘ When using two worksurfaces, a flat bracket is required. Bracket purchased separately — HHN831124, HHN831130 — see page 556.
- ⓘ Each worksurface 58"W or wider requires the use of an external stiffener; including secondary return worksurface in an "L" 3-leg base application if wider than 58"W. External stiffener purchased separately when not used with a Coordinate™ worksurface.

NOTES:





- Control Box: 120V, 4A, 60Hz, 400W.
- 9' grounded power cord.
- 1¹/₈" /second travel speed.
- <50 dB noise rating.
- **HON 10-Year Warranty.**

ⓘ Requires the use of an external stiffener (purchased separately) for worksurfaces over 58"W or wider when not used with a Coordinate™ worksurface.

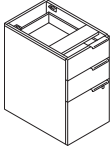

HOW TO SPECIFY

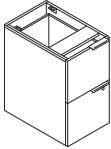
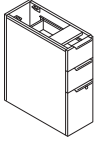
<p>Select Model Number</p> <p>HHATB3S2LT</p>	<p>Select Paint Color</p> <p>See page 114</p> <p>P71</p>	<p>Select Foot</p> <p>X Standard Foot S Slide Glide</p> <p>X</p>	<p>Select Keypad</p> <p>UD Basic Up/Down MEM Memory Preset PDL Paddle</p> <p>MEM</p>
---	---	---	---



	DESCRIPTION	MODEL	SHIP WEIGHT	CUBE	L1 LIST	L2 UPCHARGES	
						CHASSIS	FRONTS
	Support Pedestals — Box/Box/File						
	16"W x 20"D x 28½"H	HLSL2028B	73	7.3	\$926	\$16	\$11
	16"W x 24"D x 28½"H	HLSL2428B 	85	8.5	\$1025	\$21	\$11
	16"W x 30"D x 28½"H	HLSL3028B	105	10.5	\$1152	\$27	\$11
	NOTES: Top box drawer does not lock.						
	Support Pedestals — File/File						
	16"W x 20"D x 28½"H	HLSL2028F	72	7.3	\$926	\$16	\$11
	16"W x 24"D x 28½"H	HLSL2428F	84	8.5	\$1025	\$21	\$11
	16"W x 30"D x 28½"H	HLSL3028F	104	10.5	\$1152	\$27	\$11
	NOTES: Unit is locking.						
	Slim Profile Pedestals — Box/Box/File						
	9½"W x 24"D x 28½"H	HLSL2428S	69	6.9	\$1015	\$21	\$11
	9½"W x 30"D x 28½"H	HLSL3028S	56	5.6	\$1114	\$27	\$11
	NOTES: Top box drawer does not lock.						
	 Grommet will be located under Slim Pedestal when attached.						



NOTES:

- A variety of pedestals, end panels, and O-legs can be combined to create a conventional or contemporary desk.
- Chassis and drawer front woodgrain and solid laminates are specified separately (see SIF options below).
- Will have a 6" overhang when using 30" worksurface supports with a 36"D worksurface.
- File drawers accept hanging folders in letter or legal size.
- Multiple handle locations possible per customer preference.
- Ships with one handle per drawer.
- Drawer Organizer model HLSLDRWORG works with box drawers.
- Box and file drawers operate on ball-bearing suspension with full extension.
- Adjustable hex leveling glides allow floor-standing furniture to be easily leveled without lifting the unit; glides have 1¼" adjustable range.
-  Pedestals ship fully assembled but must attach to a worksurface with a quick release bracket, provided. Pedestals are non-handed and are interchangeable.
-  Locking units equipped with HON "One Key" interchangeable core removable locks. Keyed alike core must be ordered separately.

HOW TO SPECIFY

Select Model Number HLSL2028B	Select Chassis Laminate See page 173 N	Select Drawer Front Laminate See page 173 N	Select Pull Color See page 173 T4
---	---	--	--

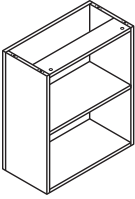
Laminate Support/Support Storage

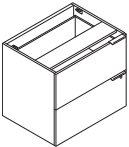
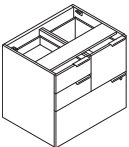
	DESCRIPTION	MODEL	SHIP WEIGHT	CUBE	L1 LIST	L2 UPCHARGES	
						CHASSIS	FRONTS
	Bookcase Support 24"W x 12"D x 28½"H 30"W x 12"D x 28½"H Specify: Model.Laminate SPECIFYING EXAMPLE: HLSL24OBC.N	HLSL24OBC HLSL30OBC	60 75	3.0 3.0	\$725 \$758	\$21 \$27	N/A N/A
							
	Lateral File — 2 Drawer 31⅜"W x 24"D x 28½"H NOTES: Unit is locking.	HLSL2430L	121	15.6	\$1586	\$37	\$21
	Multi File Lateral File 31⅜"W x 24"D x 28½"H NOTES: Box drawers do not lock.	HLSL2430MF	163	15.6	\$1884	\$37	\$21

NOTES:

- Ships with one handle per drawer on all units.
 - A variety of pedestals, end panels, and O-legs can be combined to create conventional or contemporary desk.
 - Bookcase can only mount exterior facing under a worksurface.
 - Chassis and drawer front woodgrain and solid laminates are specified separately (see SIF options below).
 - File drawers accept hanging folders in letter or legal size.
 - Multiple handle locations possible per customer preference.
 - Storage accessory model HLSLDRWORG works with box doors.
 - Standard box drawers operate on ball-bearing suspension with full extension. File, lateral, and wide box drawers operate on ball-bearing suspension with full extension.
 - Adjustable hex leveling glides allow floor-standing furniture to be easily leveled without lifting the unit; glides have 2" adjustable range.
 - When using two lateral files, a 60" worksurface cannot be used, a 66" worksurface must be specified, which will show a gap.
- ⚠ A single multi file or lateral file must be specified under a worksurface 60"W or wider.
- ⚠ Locking units equipped with HON "One Key" interchangeable core removable locks. Keyed alike core must be ordered separately.

HOW TO SPECIFY

Select Model Number HLSL2430L .	Select Chassis Laminate See page 173 N .	Select Laminate See page 173 N .	Select Pull Color See page 173 T4
---	---	---	--

VOI® Modesty Panels

GSA SIN 33721

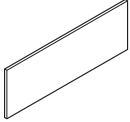
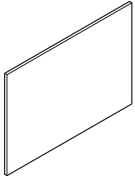

Icon Legend on page 19

	DESCRIPTION	MODEL	SHIP WEIGHT	CUBE	LIST PRICE BY LAMINATE GRADE	
					L1	L2
	Full Width/Half-height Laminate Modesty Panel					
	28"W x 14"H, for use with 60" desks	HLSL2814LM	19	1.6	\$250	\$261
	34"W x 14"H, for use with 66" desks	HLSL3414LM	23	1.9	\$259	\$270
	40"W x 14"H, for use with 72" desks	HLSL4014LM	29	2.4	\$270	\$281
	NOTES: Three sizes available for 60", 66" and 72" desks. Can only be used when using end panels and pedestals for support.					
	Full-to-Floor/Full-Length Laminate Modesty Panel					
	28"W x 28½"H, for use with 60" desks	HLSL2828LM	33	2.7	\$333	\$346
	34"W x 28½"H, for use with 66" desks	HLSL3428LM	38	3.2	\$391	\$404
	40"W x 28½"H, for use with 72" desks	HLSL4028LM	44	3.6	\$411	\$424
	NOTES: Three sizes available for 60", 66" and 72" desks. Can only be used when using end panels and pedestals for support.					

NOTES:

- Full width laminate modesty panel (14"H) and full width/full-length laminate modesty panels are designed to work with 60", 66", & 72" desks.
- Laminate and frosted translucent laminate are available options on modesty panels.
- Full height and half height laminate modesty panels can only be used when specifying a pedestal and/or end panel.

HOW TO SPECIFY

Select
Model Number

H L S L 2 8 1 4 L M .

Select
Laminate

See page 173

N

NOTES

NOTES



Laminate Overhead Storage

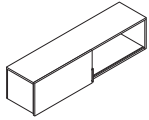

DESCRIPTION

Overhead Cabinet with One Sliding Door

36"W x 14¼"D x 14"H
 42"W x 14¼"D x 14"H
 48"W x 14¼"D x 14"H
 60"W x 14¼"D x 14"H
 66"W x 14¼"D x 14"H
 72"W x 14¼"D x 14"H

MODEL	SHIP WEIGHT	CUBE	L1 LIST	L2 UPCHARGES	
				CABINET	DOOR
HLSL1436S	39	9.7	\$1341	\$27	\$21
HLSL1442S	48	9.7	\$1405	\$27	\$21
HLSL1448S	57	12.1	\$1446	\$27	\$21
HLSL1460S	69	13.3	\$1558	\$32	\$27
HLSL1466S	83	14.6	\$1718	\$32	\$27
HLSL1472S	95	15.9	\$1875	\$37	\$27

NOTES:

- Sliding door overhead does not ship with a pull — door overhangs chassis to slide.
- If locking unit is selected, HF23 is used for lock core.

HOW TO SPECIFY

<p>Select Model Number</p> <p>For locking overhead models, add an "L" suffix (\$50 upcharge per model)</p> <p>H L S L 1 4 7 2 S</p>	<p>Select Cabinet Laminate</p> <p>See page 173</p> <p>N</p>	<p>Select Door Laminate</p> <p>See page 173</p> <p>N</p>	<p>Select Pull Option</p> <p>X No Pull</p> <p>X</p>	<p>Specify Bracket Option</p> <p>X No Bracket W Wall Bracket (\$157 upcharge)</p> <p>W</p>
---	---	--	--	---

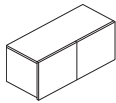

DESCRIPTION

Overhead Cabinet with Doors

36"W x 14¼"D x 14"H, 2 doors
 42"W x 14¼"D x 14"H, 2 doors
 48"W x 14¼"D x 14"H, 3 doors
 60"W x 14¼"D x 14"H, 4 doors

MODEL	SHIP WEIGHT	CUBE	L1 LIST	L2 UPCHARGES	
				CABINET	DOOR
HLSL1436D	39	9.7	\$1131	\$27	\$21
HLSL1442D	48	9.7	\$1258	\$27	\$21
HLSL1448D	57	12.1	\$1396	\$27	\$32
HLSL1460D	115	13.3	\$1558	\$32	\$32

❗ 2-Door and 3-Door Overhead Cabinet with Doors models HLSL1436D–HLSL1448D available in laminate only. The 60" model HLSL1460D is available in all door finish options—see "Select Door Material for 2/3/4 Door Models" below.

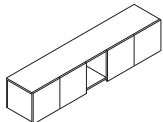

Overhead Cabinet with 4 Doors/Cubbies

66"W x 14¼"D x 14"H with 6" Cubbie
 72"W x 14¼"D x 14"H with 12" Cubbie

HLSL1466D	126	14.6	\$1718	\$32	\$32
HLSL1472D	139	15.9	\$1875	\$37	\$37

NOTES: Doors available in laminate or mixed materials.

NOTES:

- All Overhead Cabinets shown above can be used as a wall mount, panel mount or stack-on storage with O-leg.
- Tackboards are available for wall mount storage applications and conventional stack-on. Use wall mount tackboards when using O-leg supports.
- 5½"H and 20½"H O-legs can be purchased to create stack-on storage. Heights line up with Abound® and Accelerate® panels.
- Overhead cabinets with four doors are available in laminate or mixed materials.
- Wall mount brackets specified with unit. Brackets attach to case horizontally.
- Storage cases accept binder height items.
- The Metal Storage Cube HLSL1212 fits inside stack-on storage or overhead cabinet units to provide paper management.
- For panel mounted applications, brackets and hardware are ordered separately, see page 207. Brackets attach to panel and case is screwed into brackets. Two brackets needed for 60" unit.
- If locking unit is selected, HF27 is used for lock core.

❗ Stack-on Storage must be placed over two full-height supports. Cannot be placed over non-supported sections such as returns using a flat bracket or tower-to-worksurface bracket.

❗ TIG doors not available with a locking option.

HOW TO SPECIFY

<p>Select Model Number</p> <p>For locking overhead models, add an "L" suffix (\$50 upcharge per model)</p> <p>H L S L 1 4 6 0 D</p>	<p>Select Cabinet Laminate</p> <p>See page 173</p> <p>N</p>	<p>Select Door Material for 2/3/4 Door Models</p> <p>Upcharge for door selection: 4-Door \$330</p> <p>TIG Platinum Polymer with Frosted glass</p> <p>Also available in laminate doors. See page 173. Not specified for models HLSL1436D–HLSL1448D. These models are available in laminate only.</p> <p>TIG</p>	<p>Select Bracket Option</p> <p>X No Bracket W Wall Bracket (\$157 upcharge)</p> <p>X</p>
---	---	---	--

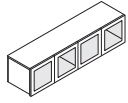
**DESCRIPTION**

Overhead Cabinet with 4 Frosted, Metal Frame Doors
60"W x 14¼"D x 14"H

MODEL**HLSL1460M****SHIP WEIGHT**

115

CUBE

11.4

LIST PRICE BY LAMINATE GRADE**L1****\$2562****L2****\$2594**

! Must specify an X or W for attachment bracket option below.

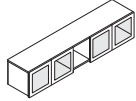
**Overhead Cabinet with 4 Frosted, Metal Frame Doors**

72"W x 14¼"D x 14"H with 12" Cubbie
66"W x 14¼"D x 14"H with 6" Cubbie

HLSL1472M

139

13.6

\$2886**\$2923****HLSL1466M**

126

12.5

\$2723**\$2755**

! Must specify an X or W for attachment bracket option below.

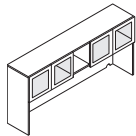
**Stack-on Storage, Built-up with 4 Frosted Doors with Metal Frame with Cubbies**

72"W x 14¼"D x 35"H with 12" Cubbie

HLSL1472MB

165

30.4

\$3040**\$3088**

NOTES: Ships complete with Back Enclosure and laminate End Panels. Ships factory assembled.

! Does not require bracket specification.

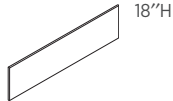

18"H

DESCRIPTION**Tackboard for Wall Mount Overhead Cabinets**

For 78"W

HLSL78TW

13

1.4

\$525**\$538**

For 72"W

HLSL72TW

12

1.4

\$500**\$513**

For 66"W

HLSL66TW

11

1.4

\$478**\$491**

For 60"W

HLSL60TW

10

1.1

\$425**\$438**

For 48"W

HLSL48TW

13

1.4

\$371**\$382**

For 42"W

HLSL42TW

12

1.4

\$345**\$356**

For 36"W

HLSL36TW

11

1.4

\$325**\$336**

SPECIFYING EXAMPLE: HLSL48TW.DB30

LIST PRICE BY FABRIC GRADE**A****B****NOTES:**

- Use O-Leg Support models for Overhead Cabinets. See page 208.
- The Metal Storage Cube HLSL1212 fits inside stack-on storage or wall mount units to provide paper management. See page 208.

! Metal Frame Overhead and Stack-on Storage units are not available with a lock.

! Stack-on Storage must be placed over two full-height supports. Cannot be placed over non-supported sections such as returns using a flat bracket or tower-to-worksurface bracket.



! Specify fabric, see pages 25-26. Upcharges may apply to premium fabric grades. Analog (ANLG), Disperse (DISP), and Exchange (EXG) not available on sizes wider than 72".

HOW TO SPECIFY

Select Model Number	Select Cabinet Laminate	Select Door Material	Select Bracket Option
See page 173	See page 173	TIG Platinum Metal Doors with Frosted Glass (no upcharge)	X No Bracket W Wall Bracket (\$157 upcharge) Not specified for model HLSL1472MB
HLSL1460M	N	TIG	X

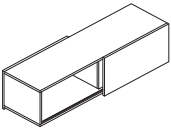
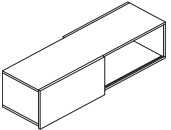

Laminate Shared Overhead Storage Components

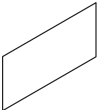
	DESCRIPTION	MODEL	SHIP WEIGHT	CUBE	L1 LIST	L2 UPCHARGES	
						CABINET	DOOR
	Shared Overhead Storage — Left						
	60"W x 17"D x 14"H 72"W x 17"D x 14"H	HLSL1760SOL HLSL1772SOL	115 139	14.8 17.0	\$1710 \$2061	\$21 \$27	\$42 \$42
	Shared Overhead Storage — Right						
	60"W x 17"D x 14"H 72"W x 17"D x 14"H	HLSL1760SOR HLSL1772SOR	115 139	14.8 17.0	\$1710 \$2061	\$21 \$27	\$42 \$42
	DESCRIPTION	MODEL	SHIP WEIGHT	CUBE	LIST PRICE BY PAINT GRADE		
					P1	P2	P3
	Panel Mount Bracket for Shared Overhead						
	Panel Mount Bracket for Overhead Storage — Accelerate®	HLSLPMBSOA	4 Ⓢ	0.1	\$181	\$186	N/A
	Panel Mount Bracket for Overhead Storage — Abound®	HLSLPMBSOB	4 Ⓢ	0.1	\$181	\$186	N/A
	Panel Mount Bracket for Overhead Storage — Accelerate®/Abound® 42½"H panels only	HLSLPMBSO42	4 Ⓢ	0.1	\$169	\$174	N/A
	NOTES: Specify paint. SPECIFYING EXAMPLE: HLSLPMBSOA.T4						
	Markerboard for Shared Storage						
	30"W x 13"H for use with 60"W Shared Overhead 36"W x 13"H for use with 72"W Shared Overhead	HLSL1530SOMB HLSL1536SOMB	6 Ⓢ 8 Ⓢ	1.0 1.0	\$182 \$243		
	NOTES: No specification necessary.						

NOTES:

- Overall case depth is 19"D including the sliding door.
- Use Shared Overhead and attachments in small footprint applications.
- Sliding door is 15"H, providing a 1" valance below the case which can be used as a finger pull if desired.
- Shared Overhead panel mount brackets allow overhead to span over all panels systems or run down the spine wall, centered on top of the panel.
- Markerboard insert is markerboard laminate with black edges, no frame.

- ! Shared Overhead must be ordered as left or right to determine open storage location.
- ! Shared Overhead Storage is not available with a lock.

HOW TO SPECIFY

Select Model Number HLSL1760SOL	Select Chassis Laminate See page 173 N	Select Door Front Laminate See page 173 N
---	---	--

Overhead Storage Supports/Accessories

Icon Legend on page 19

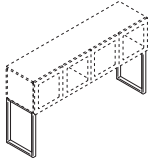
**DESCRIPTION****O-Leg Support for Overhead Cabinet**

Ships 2/pack
 14 $\frac{1}{8}$ "D x 20 $\frac{1}{2}$ "H
 14 $\frac{1}{8}$ "D x 5 $\frac{1}{2}$ "H

MODEL

HLSL650S
HLSL500S

SHIP WEIGHT

8
 6

CUBE

1.1
 1.0

LIST PRICE BY PAINT GRADE

P1 **P2** **P3**

\$630 **\$635** **\$651**
\$524 **\$529** **\$545**

NOTES: 20 $\frac{1}{2}$ "H legs used to reach 65"H when overhead storage is stacked on top of a worksurface. 5 $\frac{1}{2}$ "H legs used to reach 50"H when overhead storage is stacked on top of a worksurface. O-leg ships fully assembled with mounting hardware. O-legs can be used with all overhead cabinet models. See pages 205 and 206.

! Not for use on Shared Overhead Storage, use post leg models on page 207.

! Stack-on Storage must be placed over two full-height supports. Cannot be placed over non-supported sections such as returns using a flat bracket or tower-to-worksurface bracket.

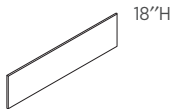
**DESCRIPTION****Wall Mounted Tackboards**

For 78"W
 For 72"W
 For 66"W
 For 60"W
 For 48"W
 For 42"W
 For 36"W

MODEL

HLSL78TW
HLSL72TW
HLSL66TW
HLSL60TW
HLSL48TW
HLSL42TW
HLSL36TW

SHIP WEIGHT

13
 12
 11
 10
 13
 12
 11

CUBE

1.4
 1.4
 1.4
 1.1
 1.4
 1.4
 1.4

LIST PRICE BY FABRIC GRADE

A **B**

\$525 **\$538**
\$500 **\$513**
\$478 **\$491**
\$425 **\$438**
\$371 **\$382**
\$345 **\$356**
\$325 **\$336**

NOTES: Specify fabric, see pages 25-26. Upcharges may apply to premium fabric grades. Analog (ANLG), Disperse (DISP), and Exchange (EXG) not available on sizes wider than 72".

SPECIFYING EXAMPLE: HLSL78TW.APN23

**DESCRIPTION****Storage Cube**

12"W x 12"D

MODEL

HLSL1212

SHIP WEIGHT

1

CUBE

0.3

LIST PRICE

\$400

SPECIFYING EXAMPLE: HLSL1212.P8S

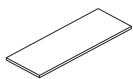
**DESCRIPTION****Shelves**

30"W x 13"D
 36"W x 13"D
 45"W x 13"D

MODEL

HLSLR1330
HLSLR1336
HLSLR1345

SHIP WEIGHT

10 Ⓞ
 12 Ⓞ
 15 Ⓞ

CUBE

1.3
 1.5
 1.9

L1**LIST PRICE**

\$252
\$284
\$308

L2**UPCHARGE**

\$11
\$11
\$11

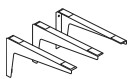
**DESCRIPTION****Shelf Bracket (set of 3)****MODEL**

HLSLSB

SHIP WEIGHT

3 Ⓞ

CUBE

0.2

LIST PRICE BY PAINT GRADE

P1 **P2** **P3**

\$129 **\$138** **\$150**

HOW TO SPECIFY

Select
Model Number

Select
Laminate/Paint

See page 173

HLSL650S . T1



Laminate Stack-on Storage — Built-up

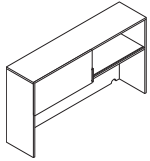

DESCRIPTION	MODEL	SHIP WEIGHT	CUBE	L1 LIST	L2 UPCHARGES	
					CABINET	DOOR
Stack-on Storage, Built-up, with Sliding Doors 72"W x 14¼"D x 35"H	HLSL1472SB	139	30.4	\$2040	\$48	\$21

NOTES: Ships complete with Back Enclosure and laminate End Panels. Ships factory assembled.

HOW TO SPECIFY

Select Model Number	Select Cabinet Laminate	Select Door Laminate	Select Pull Option
See page 173	See page 173	See page 173	X No Pull
L2 (\$48 upcharge)	L2 (\$21 upcharge)		
HLSL1472SB	N	N	X

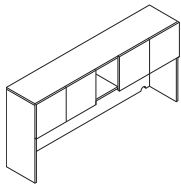

DESCRIPTION	MODEL	SHIP WEIGHT	CUBE	L1 LIST	L2 UPCHARGES	
					CABINET	DOOR
Stack-on Storage, Built-up, with 4 Doors/Cubbies 72"W x 14¼"D x 35"H with 12" Cubbie	HLSL1472DB	144	30.4	\$2040	\$48	N/A

NOTES: Ships complete with Back Enclosure and laminate End Panels. Ships factory assembled.

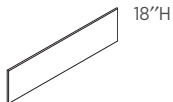

18"H

DESCRIPTION	MODEL	SHIP WEIGHT	CUBE	LIST PRICE BY FABRIC GRADE	
				A	B
Tackboard for Built-up Stack-on Storage For 72"	HLSL7265TE	12	1.4	\$500	\$513

NOTES: For a list of standard fabrics, see pages 25-26. For a complete list of fabrics, please go to hon.com/fabricsandfinishes. Analog (ANLG), Disperse (DISP), and Exchange (EXG) not available on sizes wider than 72".

SPECIFYING EXAMPLE: HLSL7265TE.APN23

NOTES:

- The Metal Storage Cube HLSL1212 fits inside stack-on storage or wall mount units to provide paper management.

❗ Stack-on Storage is not available with a lock.

❗ Tackboards are available for Built-up models only. Tackboards cannot be added to O-leg supported units.

❗ Stack-on Storage must be placed over two full-height supports. Cannot be placed over non-supported sections such as returns using a flat bracket or tower-to-worksurface bracket.

HOW TO SPECIFY

Select Model Number	Select Cabinet Chassis Laminate	Select Door Material for 4-Door Models
See page 173	See page 173	Upcharge for door selection: 4-Door
L2 (\$48 upcharge)	L2 (\$48 upcharge)	T1G Platinum Polymer with Frosted glass \$330
HLSL1472DB	N	Also available in laminate doors. See page 173.

VOI® Laminate Low Credenzas

GSA SIN 33721



Icon Legend on page 19

	DESCRIPTION	MODEL	SHIP WEIGHT	CUBE	L1 LIST	L2 UPCHARGES	
						CHASSIS	FRONTS
	Low Credenza, 2 File/2 Box 72"W x 20"D x 21½"H 60"W x 20"D x 21½"H NOTES: Unit is locking.	HLSL2072LD4	230	21.9	\$2162	\$42	\$42
		HLSL2060LD4	190	18.9	\$1971	\$37	\$42
	Low Credenza, 2 File Drawers, Open Top 72"W x 20"D x 21½"H 60"W x 20"D x 21½"H NOTES: Unit is non-locking.	HLSL2072LD2	200	21.9	\$2020	\$42	\$32
		HLSL2060LD2 	160	18.9	\$1847	\$37	\$32
	Low Credenza, Left Hand Drawers 72"W x 20"D x 21½"H 60"W x 20"D x 21½"H NOTES: Unit is locking.	HLSL2072LL2	200	21.9	\$2001	\$42	\$21
		HLSL2060LL2	160	18.9	\$1690	\$37	\$21
	Low Credenza, Right Hand Drawers 72"W x 20"D x 21½"H 60"W x 20"D x 21½"H NOTES: Unit is locking.	HLSL2072LR2	200	21.9	\$2001	\$42	\$21
		HLSL2060LR2	160	18.9	\$1690	\$37	\$21
	Low Credenza, Open 72"W x 20"D x 21½"H 60"W x 20"D x 21½"H SPECIFYING EXAMPLE: HLSL2072LDO.Z (model.chassis only)	HLSL2072LDO	170	21.9	\$1701	\$42	N/A
		HLSL2060LDO	130	18.9	\$1413	\$37	N/A
	Low Credenza, 4 Storage Doors 72"W x 20"D x 21½"H 60"W x 20"D x 21½"H NOTES: Unit is locking.	HLSL2072S4	190	21.9	\$2145	\$42	\$42
		HLSL2060S4	160	18.9	\$1843	\$37	\$42

NOTES:

- Worksurfaces with 7" O-legs, may be placed upon low credenzas to create layering.
- Chassis and drawer fronts woodgrains and solid laminates are specified separately (see SIF options below).
- File drawers accept hanging folders in letter size.
- Multiple handle locations possible per customer preference.
- Seat cushions are available for low credenzas and mobile pedestals (specify separately).
- Storage accessory model HLSLDRWORG works with box doors.
- Layering shelf works with low credenzas to provide additional storage areas.
- File, lateral, and wide box drawers operate on ball-bearing suspension with full extension.
- Adjustable hex leveling glides allow floor-standing furniture to be easily leveled without lifting the unit; glides have 1/4" adjustable range.
- Ships with one handle per drawer on all units.

 Locking units equipped with HON "One Key" interchangeable core removable locks. Keyed alike core must be ordered separately.

HOW TO SPECIFY

Select Model Number HLSL2072LD4	Select Chassis Laminate See page 173 N	Select Drawer Front Laminate See page 173 N	Select Pull Color See page 173 Not specified for Open Credenza models HLSL2072LDO, HLSL2060LDO T4
---	---	--	---

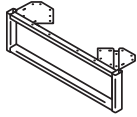

DESCRIPTION

7" O-Leg Support for Worksurfaces

30"D x 7"H

24"D x 7"H

20"D x 7"H

Specify: Model.Paint HL3070.T1.

NOTES: 7" O-Leg Support to be placed upon Low Credenza models to support worksurfaces. Ship 1/pack.

MODEL	SHIP WEIGHT	CUBE	LIST PRICE BY PAINT GRADE		
			P1	P2	P3
HL3070 ☺	7	1.0	\$366	\$371	\$387
HL2470	6	1.0	\$288	\$293	\$309
HL2070	5	1.0	\$267	\$272	\$288

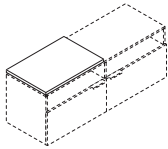

DESCRIPTION

Credenza Cushion

20"W x 36"D x 1"H for 72" Credenzas

20"W x 30"D x 1"H for 60" Credenzas

NOTES: See pages 22-24 for available fabrics.

COM: .75

SPECIFYING EXAMPLE: HL2036CH2.APN23

MODEL	SHIP WEIGHT	CUBE	LIST PRICE BY FABRIC GRADE					
			1	2	3	4	5	6
HL2036CH2	11	2.2	\$541	\$581	\$621	\$662	\$713	\$765
HL2030CH2	9	1.9	\$501	\$539	\$577	\$614	\$662	\$712

NOTES:

- Worksurfaces with 7" O-legs, may be placed upon low credenzas to create layering.
- Chassis and drawer fronts woodgrains and solid laminates are specified separately (see SIF options on preceding page).
- Seat cushions are available for low credenzas and mobile pedestals (specify separately).
- Storage accessory model HL3DRWORG works with box doors.
- Layering shelf works with low credenzas to provide additional storage areas.
- File, lateral, and wide box drawers operate on ball-bearing suspension with full extension.
- Adjustable hex leveling glides allow floor-standing furniture to be easily leveled without lifting the unit; glides have 1/4" adjustable range.
- Ships with one handle per drawer on all units.

HOW TO SPECIFY

<p>Select Model Number</p> <p>HL3070.</p>	<p>Select Paint Color</p> <p>See page 173</p> <p>T1</p>
--	--

Laminate Low Footed Credenzas

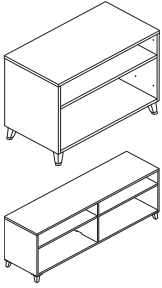
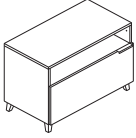
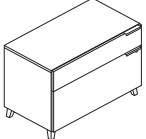
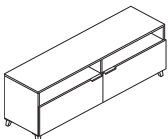
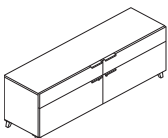
	DESCRIPTION	MODEL	SHIP WEIGHT	CUBE	L1 LIST	L2 UPCHARGES	
						CHASSIS	FRONTS
	Low Credenza, Open, Footed						
	30"W x 20"D x 24½"H	HLSL2030LD0F Ⓜ	67	9.8	\$1238	\$27	N/A
	36"W x 20"D x 24½"H	HLSL2036LD0F	87	11.9	\$1272	\$32	N/A
	60"W x 20"D x 24½"H	HLSL2060LD0F	132	19.9	\$1481	\$37	N/A
	72"W x 20"D x 24½"H	HLSL2072LD0F	172	23.7	\$1769	\$42	N/A
	Low Credenza, 1 File/Open, Footed						
	30"W x 20"D x 24½"H	HLSL2030LD1F	77	9.8	\$1367	\$27	\$16
	36"W x 20"D x 24½"H	HLSL2036LD1F	97	11.9	\$1407	\$32	\$16
	Low Credenza, 1 File/1 Box, Footed						
	30"W x 20"D x 24½"H	HLSL2030LD2F	82	9.8	\$1512	\$27	\$21
	36"W x 20"D x 24½"H	HLSL2036LD2F	102	11.9	\$1553	\$32	\$21
	Low Credenza, 2 File/Open, Footed						
	60"W x 20"D x 24½"H	HLSL2060LD2F	162	19.9	\$1915	\$37	\$32
	72"W x 20"D x 24½"H	HLSL2072LD2F	202	23.7	\$2088	\$42	\$32
	Low Credenza, 2 File/2 Box, Footed						
	60"W x 20"D x 24½"H	HLSL2060LD4F	192	19.9	\$2039	\$37	\$42
	72"W x 20"D x 24½"H	HLSL2072LD4F	232	23.7	\$2229	\$42	\$42

NOTES:

- Worksurfaces with 4" stanchions may be placed upon low credenzas to create layering.
- Chassis and drawer fronts woodgrains and solid laminates are specified separately (see SIF options below).
- File drawers accept hanging folders in letter size.
- Multiple handle locations possible per customer preference.
- Seat cushions are available for low credenzas (specify separately).
- Storage accessory model HLSLDRWORG works with box drawers.
- Layering shelf works with low credenzas to provide additional storage areas.
- File, lateral, and wide box drawers operate on ball-bearing suspension with full extension.
- Adjustable hex leveling glides allow floor-standing furniture to be easily leveled without lifting the unit; glides have 1/4" adjustable range.
- Ships with one handle per drawer on all units.

- ⚠ Center stability foot is included on units 60"W or larger and is always black.
- ⚠ Locking units equipped with HON "One Key" interchangeable core removable locks. Keyed alike core must be ordered separately.
- ⚠ 7" O-legs cannot be used as a support on footed credenzas.

HOW TO SPECIFY

Select Model Number	Select Chassis Laminate	Select Drawer Front Laminate	Select Pull Color	Select Foot Color
See page 173	See page 173	See page 173	See page 173 Not specified for Open Credenza models	See page 173
HLSL2030LD0F	C	C	T1	T1

Laminate Low Footed Credenzas

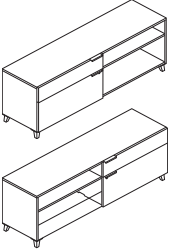
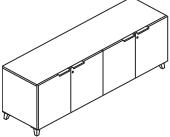
	DESCRIPTION	MODEL	SHIP WEIGHT	CUBE	L1 LIST	L2 UPCHARGES	
						CHASSIS	FRONTS
	Low Credenza, Box/File, Open, Footed						
	60"W x 20"D x 24½"H — Left Hand Drawers	HLSL2060LL2F	162	19.9	\$1758	\$37	\$21
	72"W x 20"D x 24½"H — Left Hand Drawers	HLSL2072LL2F	202	23.7	\$2069	\$42	\$21
	60"W x 20"D x 24½"H — Right Hand Drawers	HLSL2060LR2F	162	19.9	\$1758	\$42	\$21
	72"W x 20"D x 24½"H — Right Hand Drawers	HLSL2072LR2F	202	23.7	\$2069	\$42	\$21
	Low Credenza, 4 Storage Doors, Footed						
	60"W x 20"D x 24½"H	HLSL2060S4F	162	19.9	\$1911	\$37	\$42
	72"W x 20"D x 24½"H	HLSL2072S4F	192	23.7	\$2213	\$42	\$42

NOTES:

- Worksurfaces with 4" stanchions may be placed upon low credenzas to create layering.
- Chassis and drawer fronts woodgrains and solid laminates are specified separately (see SIF options below).
- File drawers accept hanging folders in letter size.
- Multiple handle locations possible per customer preference.
- Seat cushions are available for low credenzas and mobile pedestals (specify separately).
- Storage accessory model HSLDRWORG works with box doors.
- Layering shelf works with low credenzas to provide additional storage areas.
- File, lateral, and wide box drawers operate on ball-bearing suspension with full extension.
- Adjustable hex leveling glides allow floor-standing furniture to be easily leveled without lifting the unit; glides have 1/4" adjustable range.
- Ships with one handle per drawer on all units.

❗ Center stability foot is included on units 60"W or larger and is always black.

❗ HLSL2060S4F and HLSL2072S4F require model HF27 lock cores.

❗ Locking units equipped with HON "One Key" interchangeable core removable locks. Keyed alike core must be ordered separately.

❗ 7" O-legs cannot be used as a support on footed credenzas.

HOW TO SPECIFY



Select Model Number	Select Chassis Laminate See page 173	Select Drawer Front Laminate See page 173	Select Pull Color See page 173 Not specified for Open Credenza models	Select Foot Color See page 173
HLSL2060LL2F	C	C	T1	T1

VOI® Laminate Credenzas

GSA SIN 33721

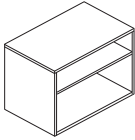

Icon Legend on page 19

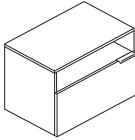
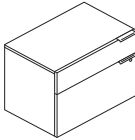
	DESCRIPTION	MODEL	SHIP WEIGHT	CUBE	L1 LIST	L2 UPCHARGES	
						CHASSIS	FRONTS
	Low Credenza — Open						
	30"W x 20"D x 21½"H 36"W x 20"D x 21½"H	HLSL2030LDO  HLSL2036LDO	65 85	9.8 12.0	\$1170 \$1204	\$27 \$32	N/A N/A
	Low Credenza — Open Top, File Drawer						
	30"W x 20"D x 21½"H 36"W x 20"D x 21½"H NOTES: Unit is non-locking.	HLSL2030LD1 HLSL2036LD1	75 95	9.8 12.0	\$1299 \$1339	\$27 \$32	\$16 \$16
	Low Credenza — 1 File Drawer, 1 Box Drawer						
	30"W x 20"D x 21½"H 36"W x 20"D x 21½"H NOTES: Unit is locking.	HLSL2030LD2 HLSL2036LD2	80 100	9.8 12.0	\$1444 \$1485	\$27 \$32	\$21 \$21

NOTES:

- Worksurfaces with 7" O-legs, may be placed upon low credenzas to create layering.
- File drawers accept hanging folders in letter size.
- Multiple handle locations possible per customer preference.
- Post legs on Shared Overhead are compatible to attach to low credenzas.
- Storage accessory model HLSLDRWORG works with box doors.
- File, lateral, and wide box drawers operate on ball-bearing suspension with full extension.
- Utilize in small footprint applications.
- Adjustable hex leveling glides allow floor-standing furniture to be easily leveled without lifting the unit; glides have 1/4" adjustable range.
- Ships with one handle per drawer on all units.

 Locking units equipped with HON "One Key" interchangeable core removable locks. Keyed alike core must be ordered separately.

HOW TO SPECIFY**Select Model Number**

HLSL2030LDO

Select Chassis Laminate

See page 173

N

Select Drawer Front Laminate

See page 173

Not specified for Open Credenza models HLSL2030LDO, HLSL2036LDO

N

Select Pull Color

See page 173

Not specified for Open Credenza models HLSL2030LDO, HLSL2036LDO

T4



Icon Legend on page 19

Laminate Mobile Storage

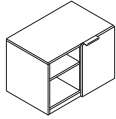

DESCRIPTION

Mobile Credenza
30"W x 20"D x 21½"H
NOTES: Unit is non-locking.

MODEL	SHIP WEIGHT	CUBE	L1 LIST	L2 UPCHARGES	
				CHASSIS	FRONTS
HLSL2030MCO	80	9.8	\$1874	\$27	\$11

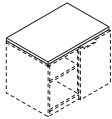

DESCRIPTION

Credenza Cushion
20"W x 30"D x 1"H for 60" Credenzas
NOTES: See pages 22-24 for available fabrics.

COM: .75
SPECIFYING EXAMPLE: HLSL2030CH2.APN23

MODEL	SHIP WEIGHT	CUBE	LIST PRICE BY FABRIC GRADE					
			1	2	3	4	5	6
HLSL2030CH2	9	1.9	\$501	\$539	\$577	\$614	\$662	\$712

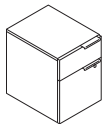

DESCRIPTION

Mobile Pedestal
15¾"W x 20½"D x 21¾"H
NOTES: Unit is locking.

MODEL	SHIP WEIGHT	CUBE	L1 LIST	L2 UPCHARGES	
				CHASSIS	FRONTS
HLSL2016MP2	65	5.7	\$1070	\$21	\$11

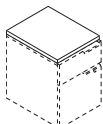

DESCRIPTION

Mobile Pedestal Cushion
15¾"W x 20"D x 1"H for Pedestals
NOTES: See pages 22-24 for available fabrics.

SPECIFYING EXAMPLE: HLSL2016PH2.APN23

MODEL	SHIP WEIGHT	CUBE	LIST PRICE BY FABRIC GRADE					
			1	2	3	4	5	6
HLSL2016PH2	6	1.1	\$416	\$442	\$467	\$492	\$524	\$557

NOTES:

- Chassis and drawer fronts woodgrains and solid laminates are specified separately (see SIF options below).
- File drawers accept hanging folders in letter or legal size.
- Multiple handle locations possible per customer preference.
- Seat cushions are available for low credenzas, floor credenzas, and mobile pedestals (specify separately).
- Storage accessory model HSLDRWORG works with box doors.
- Standard box drawers operate on ball-bearing suspension with 70% extension. File drawers operate on ball-bearing suspension with 70% extension.
- Ships with one handle per drawer on all units.

! Locking units equipped with HON "One Key" interchangeable core removable locks. Keyed alike core must be ordered separately.

HOW TO SPECIFY

<p>Select Model Number</p> <p>H L S L 2 0 3 0 M C O . N .</p>	<p>Select Chassis Laminate</p> <p>See page 173</p> <p>N .</p>	<p>Select Drawer Front Laminate</p> <p>See page 173</p> <p>N .</p>	<p>Select Pull Color</p> <p>See page 173</p> <p>T 4</p>
--	--	---	--

VOI® Laminate Storage

GSA SIN 33721

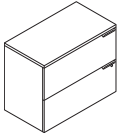
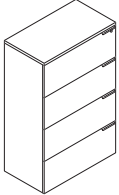
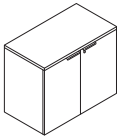
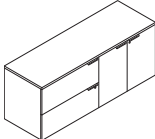
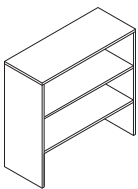

Icon Legend on page 19

	DESCRIPTION	MODEL	SHIP WEIGHT	CUBE	L1 LIST	L2 UPCHARGES	
						CHASSIS	FRONTS
	2-Drawer Lateral Files 36"W x 24"D x 29½"H 36"W x 20"D x 29½"H	HLSL2436L2	305	29.8	\$1721	\$37	\$21
		HLSL2036L2	170	15.7	\$1545	\$32	\$21
	4-Drawer Lateral Files 36"W x 24"D x 57"H 36"W x 20"D x 57"H	HLSL2436L4	366	35.9	\$2447	\$48	\$32
		HLSL2036L4	204	18.3	\$2298	\$42	\$32
	Storage Cabinet 36"W x 24"D x 29½"H 36"W x 20"D x 29½"H	HLSL2436SC	150	18.3	\$1304	\$37	\$21
		HLSL2036SC	147	15.7	\$1225	\$32	\$21
	Lateral/Storage Cabinet Credenza 72"W x 24"D x 29½"H	HLSL2472LC	300	35.6	\$3468	\$48	\$32
	Bookcase Hutch (no doors) 36"W x 14"D x 35"H NOTES: Bookcase Hutch model works with Storage Cabinet and Lateral File models shown above. ⚠ Specify: Chassis laminate only. ⚠ Top two shelves have 12" spacing to allow for binder storage and bottom shelf has 8¼" spacing.	HLSL1436BH	125	3.7	\$942	\$21	N/A

NOTES:

- Ships with one handle per drawer on all units.
 - All models are locking.
 - Chassis and drawer fronts woodgrains and solid laminates are specified separately (see SIF options below).
 - File drawers accept hanging folders in letter or legal size.
 - Multiple handle locations possible per customer preference.
 - Adjustable hex leveling glides allow floor-standing furniture to be easily leveled without lifting the unit; glides have 1¼" adjustable range.
- ⚠ Locking units equipped with HON "One Key" interchangeable core removable locks. Keyed alike core must be ordered separately.

HOW TO SPECIFY

<p>Select Model Number</p> <p>H L S L 2 0 3 6 L 2 .</p>	<p>Select Chassis Laminate</p> <p>See page 173</p> <p>N .</p>	<p>Select Drawer Front Laminate</p> <p>See page 173</p> <p>Not specified for model HLSL1436BH</p> <p>N .</p>	<p>Select Pull Color</p> <p>See page 173</p> <p>Not specified for Bookcase Hutch model HLSL1436BH</p> <p>T 4</p>
--	--	---	---



Icon Legend on page 19

Laminate Storage Cubes

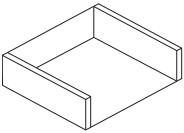
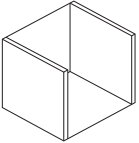
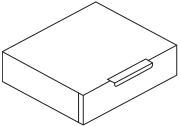
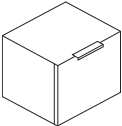
	DESCRIPTION	MODEL	SHIP WEIGHT	CUBE	L1 LIST	L2/P2 UPCHARGES		
						CHASSIS	DOOR FRONT	PAINT
	Short Open Cube 15"W x 13"D x 4"H	HLSL154LSO	9	1.4	\$207	\$11	N/A	\$9
	Tall Open Cube 15"W x 13"D x 12"H	HLSL1512LSO	16	2.9	\$247	\$11	N/A	\$9
	Drawer Cube 15"W x 13"D x 4"H	HLSL154LSD	19	1.4	\$308	\$11	\$6	\$9
	Cabinet Cube 15"W x 13"D x 12"H – Right Handed	HLSL1512LSCR	24	2.9	\$308	\$11	\$6	\$9
	15"W x 13"D x 12"H – Left Handed	HLSL1512LSC L	24	2.9	\$308	\$11	\$6	\$9

NOTES:

- 4"H and 12"H cubes attach to credenzas, worksurfaces, or wall mounted shelves.
- Configurable components are assembled using double-sided tape.
- Three 4"H cubes can be stacked to the height of one 12"H cube.
- ⓘ Do not leave a gap wider than 15" between cubes while assembled with a shelf.
- ⓘ Do not stack cube and shelf configurations higher than 30".
- ⓘ Do not span cubes across worksurface-to-credenza applications.

HOW TO SPECIFY

<p>Select Model Number</p> <p>HLSL154LSD</p>	<p>Select Chassis Laminate</p> <p>See page 173</p> <p>C</p>	<p>Select Front Laminate</p> <p>See page 173</p> <p>Not specified on HLSL154LSO and HLSL1512LSO</p> <p>C</p>	<p>Select Paint Color</p> <p>See page 173</p> <p>P3 upcharge (+ \$21)</p> <p>T1</p>	<p>Select Pull Color</p> <p>See page 173</p> <p>Not specified on HLSL154LSO and HLSL1512LSO</p> <p>T1</p>
---	--	---	--	--

	DESCRIPTION	MODEL	SHIP WEIGHT	CUBE	L1 LIST PRICE	L2 UPCHARGE
	Shelves					
	30"W x 13"D	HLSLR1330	10	1.3	\$252	\$11
	36"W x 13"D	HLSLR1336	12	1.5	\$284	\$11
	45"W x 13"D	HLSLR1345	15	1.9	\$308	\$11

NOTES:

- Use shelves in between cubes to create another layering element, if desired.

HOW TO SPECIFY

<p>Select Model Number</p> <p>HLSLR1330</p>	<p>Select Laminate</p> <p>See page 173</p> <p>C</p>
--	--

VOI® Laminate Storage Cube Bundles

QTY	DESCRIPTION	MODEL	LIST PRICE	PRICE EXTENSION
2	Cube Bundle A Short Open Cube 15"W x 13"D x 4"H	HLSL154LSO	\$207	\$414
HLSL15-SOO			TOTAL:	\$414

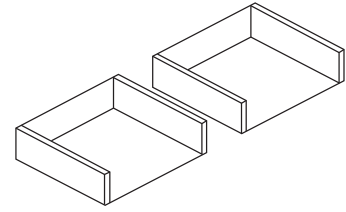

HLSL15-SOO

QTY	DESCRIPTION	MODEL	LIST PRICE	PRICE EXTENSION
3	Cube Bundle B Short Open Cube 15"W x 13"D x 4"H	HLSL154LSO	\$207	\$621
1	Tall Open Cube 15"W x 13"D x 12"H	HLSL1512LSO	\$247	\$247
HLSL15-SOOOLO			TOTAL:	\$868

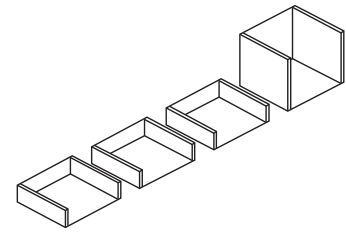

HLSL15-SOOOLO

QTY	DESCRIPTION	MODEL	LIST PRICE	PRICE EXTENSION
1	Cube Bundle C Short Open Cube 15"W x 13"D x 4"H	HLSL154LSO	\$207	\$207
1	Tall Open Cube 15"W x 13"D x 12"H	HLSL1512LSO	\$247	\$247
1	Drawer Cube 15"W x 13"D x 4"H	HLSL154LSD	\$308	\$308
1	Cabinet Cube, Right Handed 15"W x 13"D x 12"H	HLSL1512LSCR	\$308	\$308
HLSL15-SODLOC			TOTAL:	\$1,070

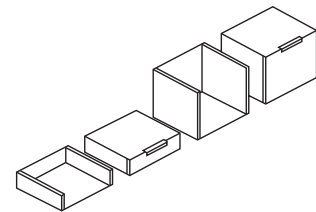

HLSL15-SODLOC

QTY	DESCRIPTION	MODEL	LIST PRICE	PRICE EXTENSION
2	Cube Bundle D Drawer Cube 15"W x 13"D x 4"H	HLSL154LSD	\$308	\$616
2	Cabinet Cube, Right Handed 15"W x 13"D x 12"H	HLSL1512LSCR	\$308	\$616
HLSL15-SDDLCC			TOTAL:	\$1,232

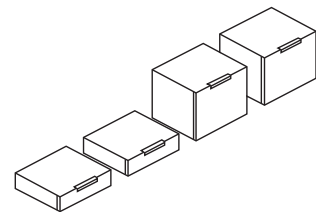

HLSL15-SDDLCC

QTY	DESCRIPTION	MODEL	LIST PRICE	PRICE EXTENSION
2	Cube Bundle E Drawer Cube 15"W x 13"D x 4"H	HLSL154LSD	\$308	\$616
2	Short Open Cube 15"W x 13"D x 4"H	HLSL154LSO	\$207	\$414
1	Tall Open Cube 15"W x 13"D x 12"H	HLSL1512LSO	\$247	\$247
1	Cabinet Cube, Right Handed 15"W x 13"D x 12"H	HLSL1512LSCR	\$308	\$308
HLSL15-SOODDLOC			TOTAL:	\$1,585

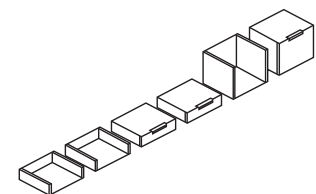

HLSL15-SOODDLOC



Laminate Storage Towers

	DESCRIPTION	MODEL	SHIP WEIGHT	CUBE	L1 LIST	L2 UPCHARGES	
						CHASSIS	FRONTS
	24"W x 20"D Storage Tower — Right Hand Drawers, Left Hand Door						
	24"W x 20"D x 50"H, Left	HLSLW045L	167	17.4	\$2584	\$53	\$37
	24"W x 20"D x 65"H, Left	HLSLW046L	200	22.5	\$2930	\$58	\$37
	24"W x 20"D Storage Tower — Left Hand Drawers, Right Hand Door						
	24"W x 20"D x 50"H, Right	HLSLW045R	167	17.4	\$2584	\$53	\$37
	24"W x 20"D x 65"H, Right	HLSLW046R	200	22.5	\$2930	\$58	\$37
	24"W x 24"D Storage Tower — Right Hand Drawers, Left Hand Door						
	24"W x 24"D x 50"H, Left	HLSLW445L	200	20.7	\$2799	\$58	\$37
	24"W x 24"D x 65"H, Left	HLSLW446L	240	27.8	\$3084	\$63	\$37
	24"W x 24"D Storage Tower — Left Hand Drawers, Right Hand Door						
	24"W x 24"D x 50"H, Right	HLSLW445R	200	20.7	\$2799	\$58	\$37
	24"W x 24"D x 65"H, Right	HLSLW446R	240	27.8	\$3084	\$63	\$37
	24"W x 24"D Personal Storage Tower						
	24"W x 24"D x 65"H, Left	HLSLW446LP	250	27.8	\$3493	\$63	\$37
	24"W x 24"D x 65"H, Right	HLSLW446RP	250	27.8	\$3493	\$63	\$37
	Worksurface to Tower Bracket Kit				LIST PRICE BY PAINT GRADE		
	Bracket to attach storage towers or pedestal to worksurfaces.	HSTB2W1	4	0.6	P1	P2	P3
	NOTES: Can be used in place of end panel or O-leg to support worksurfaces.						
	! Bracket cannot be used as a support when placing Stack-on Storage on worksurface over bracket. Must use two full-sized supports when using Stack-on Storage.						

NOTES:

- Use the worksurface to tower bracket kit to attach worksurfaces to Storage Towers models shown above.
- Chassis and drawer fronts woodgrains and solid laminates are specified separately (see SIF options below).
- File drawers accept hanging folders in letter or legal size.
- Wardrobe, middle box drawer and file drawer are locking.
- Standard box drawers operate on ball-bearing suspension with full extension. File, lateral, and wide box drawers operate on ball-bearing suspension with full extension.
- Ships with one handle per drawer on all units.
- Adjustable hex leveling glides allow floor-standing furniture to be easily leveled without lifting the unit; glides have 1/4" adjustable range.
- Wardrobe/storage cabinet includes coat rod.
- Wardrobes contain easy access side storage shelves.

! Locking units equipped with HON "One Key" interchangeable core removable locks. Keyed alike core must be ordered separately.

HOW TO SPECIFY

<p>Select Model Number</p> <p>HL SLW045L</p>	<p>Select Chassis Laminate</p> <p>See page 173</p> <p>N</p>	<p>Select Drawer Front Laminate</p> <p>See page 173</p> <p>N</p>	<p>Select Pull Color</p> <p>See page 173</p> <p>T4</p>
---	--	---	---

VOI® Laminate Storage Towers

GSA SIN 33721



Icon Legend on page 19

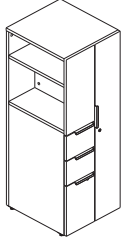

DESCRIPTION	MODEL	SHIP WEIGHT	CUBE	L1 LIST	L2 UPCHARGES	
					CHASSIS	FRONTS
18"W x 20"D Storage Towers — Right Hand Drawers, Left Hand Door						
18"W x 20"D x 50"H, Left	HLSLW085L	139	13.4	\$2325	\$48	\$37
18"W x 20"D x 65"H, Left	HLSLW086L	167	17.3	\$2641	\$53	\$37
18"W x 20"D Storage Towers — Left Hand Drawers, Right Hand Door						
18"W x 20"D x 50"H, Right	HLSLW085R	139	13.4	\$2325	\$48	\$37
18"W x 20"D x 65"H, Right	HLSLW086R	167	17.3	\$2641	\$53	\$37

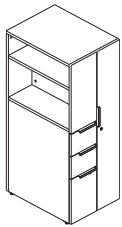

18"W x 24"D Storage Towers — Right Hand Drawers, Left Hand Door						
18"W x 24"D x 50"H, Left	HLSLW485L	167	15.8	\$2647	\$53	\$37
18"W x 24"D x 65"H, Left	HLSLW486L	200	21.5	\$2933	\$58	\$37
18"W x 24"D Storage Towers — Left Hand Drawers, Right Hand Door						
18"W x 24"D x 50"H, Right	HLSLW485R	167	15.8	\$2647	\$53	\$37
18"W x 24"D x 65"H, Right	HLSLW486R	200	21.5	\$2933	\$58	\$37

NOTES:

- Ships with one handle per drawer on all units.
 - Chassis and drawer fronts woodgrains and solid laminates are specified separately (see SIF options below).
 - File drawers accept hanging folders in letter or legal size.
 - Standard box drawers operate on ball-bearing suspension with full extension. File and box drawers operate on ball-bearing suspension with full extension.
 - Adjustable hex leveling glides allow floor-standing furniture to be easily leveled without lifting the unit; glides have 1/4" adjustable range.
 - Wardrobe/storage cabinet includes coat rod.
 - Wardrobes contain easy access side storage shelves.
 - Wardrobe, middle box drawer and file drawer are locking.
- ! Locking units equipped with HON "One Key" interchangeable core removable locks. Keyed alike core must be ordered separately.
- ! Worksurface-to-tower bracket cannot be used as a support when placing Stack-on Storage on worksurface over bracket. Must use two full-sized supports when using Stack-on Storage.

HOW TO SPECIFY

Select Model Number	Select Chassis Laminate	Select Door/Drawer Front Laminate	Select Pull Color
See page 173	See page 173	See page 173	See page 173
HL SLW085L	N	N	T4

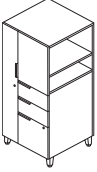
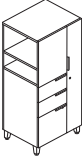
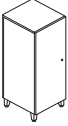
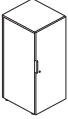
	DESCRIPTION	MODEL	SHIP WEIGHT	CUBE	L1 LIST	L2 UPCHARGES	
						CHASSIS	FRONTS
	Storage Towers, Right Hand Drawers, Left Hand Doors, Footed						
	20"W x 18"D x 54"H	HLSLW085LF	141	13.7	\$2393	\$48	\$37
	24"W x 18"D x 54"H	HLSLW485LF	169	16.2	\$2715	\$53	\$37
	20"W x 24"D x 54"H	HLSLW045LF	169	17.8	\$2652	\$53	\$37
	24"W x 24"D x 54"H	HLSLW445LF	202	21.1	\$2867	\$58	\$37
	Storage Towers, Left Hand Drawers, Right Hand Doors, Footed						
	20"W x 18"D x 54"H	HLSLW085RF	141	13.7	\$2393	\$48	\$37
	24"W x 18"D x 54"H	HLSLW485RF	169	16.2	\$2715	\$53	\$37
	20"W x 24"D x 54"H	HLSLW045RF	169	17.8	\$2652	\$53	\$37
	24"W x 24"D x 54"H	HLSLW445RF	202	21.1	\$2867	\$58	\$37
	Storage Towers, One Door, Footed						
	18"W x 20"D x 46"H — Left Hand Door	HLSLW084LF	105	11.3	\$1712	\$37	\$27
	18"W x 20"D x 46"H — Right Hand Door	HLSLW084RF	105	11.3	\$1712	\$37	\$27
	Storage Towers, One Door, Non-Footed						
	18"W x 20"D x 42"H — Left Hand Door	HLSLW084L	102	11.3	\$1644	\$37	\$27
	18"W x 20"D x 42"H — Right Hand Door	HLSLW084R	102	11.3	\$1644	\$37	\$27

NOTES:

- Use the worksurface to tower bracket kit to attach worksurfaces to Storage Towers models shown above.
- Chassis and drawer fronts woodgrains and solid laminates are specified separately (see SIF options below).
- File drawers accept hanging folders in letter or legal size.
- Wardrobe, middle box drawer and file drawer are locking.
- Standard box drawers operate on ball-bearing suspension with full extension. File, lateral, and wide box drawers operate on ball-bearing suspension with full extension.
- Ships with one handle per drawer on all units.
- Adjustable hex leveling glides allow floor-standing furniture to be easily leveled without lifting the unit; glides have 1/4" adjustable range.
- Wardrobe/storage cabinet includes coat rod.
- Wardrobes contain easy access side storage shelves.

! Locking units equipped with HON "One Key" interchangeable core removable locks. Keyed alike core must be ordered separately.

HOW TO SPECIFY

Select Model Number	Select Chassis Laminate	Select Drawer Front Laminate	Select Pull Color	Select Foot Color
See page 173	See page 173	See page 173	See page 173	See page 173
H L S L W 0 8 5 L F	C	C	T 1	T 1

VOI® Laminate Storage



DESCRIPTION	MODEL	SHIP WEIGHT	CUBE	L1 LIST	L2 UPCHARGES	
					CHASSIS	FRONTS
Box/File Pedestal, Footed 16"W x 20"D x 24½"H	HLSL2016FP2	65	5.8	\$1137	\$21	\$11

NOTES:

- Ships with one handle per drawer on all units.
- All models shown below are locking.
- Chassis and drawer fronts woodgrains and solid laminates are specified separately (see SIF options below).
- File drawers accept hanging folders in letter or legal size.
- Multiple handle locations possible per customer preference.
- Adjustable hex leveling glides allow floor-standing furniture to be easily leveled without lifting the unit; glides have 1/4" adjustable range.

⚠ Locking units equipped with HON "One Key" interchangeable core removable locks. Keyed alike core must be ordered separately.

HOW TO SPECIFY

<p>Select Model Number</p> <p>HL S L 2 0 1 6 F P 2</p>	<p>Select Chassis Laminate</p> <p>See page 173</p> <p>C</p>	<p>Select Drawer Front Laminate</p> <p>See page 173</p> <p>C</p>	<p>Select Pull Color</p> <p>See page 173</p> <p>T 1</p>	<p>Select Foot Color</p> <p>See page 173</p> <p>T 1</p>
---	--	---	--	--

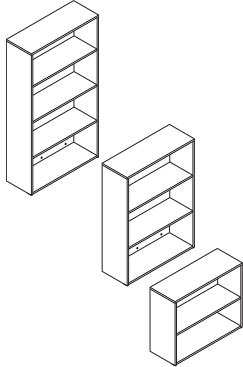

DESCRIPTION

Bookcase
 36"W x 13"D x 29½"H, 2-Shelf
 36"W x 13"D x 50"H, 3-Shelf
 36"W x 13"D x 65"H, 4-Shelf

MODEL	SHIP WEIGHT	CUBE	LIST PRICE BY LAMINATE GRADE	
			L1	L2
HLSL1336B2	90	10.7	\$749	\$765
HLSL1336B3	122	17.3	\$965	\$986
HLSL1336B4	156	22.2	\$1135	\$1162

NOTES: Bookcases available in 2, 3 and 4 shelf models. Adjustable glides allow bookcases to be easily leveled. Glides have 1/4" of adjustability.

HOW TO SPECIFY

Select Model Number

H L S L 1 3 3 6 B 2 .

Select Laminate

See page 173

N

NOTES

WORKWALL

Want to see more? Scan here
to check out hon.com.



Workwall featuring Voi® Storage and Desks
and Ignition® 2.0 and Mav™ Seating.

WORKWALL

You need a solution that does it all: Encourages creative collaboration, organizes everything from photos to files, delivers exceptional functionality, and celebrates what makes your brand and the members of your team so unique. Look no further than Workwall — a brilliant tile system that mixes and matches fabric, metal, glass, and laminate materials with accessories, making it a powerhouse performer and an exemplary partner to a variety of HON products in any private office, teaming station, or meeting area. Make your space work with Workwall.



FEATURES

- High-quality materials add a remarkable aesthetic and dynamic functionality to the evolving workplace, making any private office, teaming station, or open collaboration area pop with personality and productivity.
- Tiles are offered in a variety of heights, widths, and materials, including laminate, laminate media, painted metal, slotted tool, fabric, and glass markerboard.
- Make your space an organizational oasis with Workwall's additional hanging additions — floating shelves, metal single tool rails, and a variety of painted metal accessories to keep you focused and efficient.
- Workwall can be universally paired with laminate casegoods — including HON's 10500 Series™, Concinnity™, and Voi® — or retrofitted to add on to existing workstations throughout the workspace.
- Mix-and-match tiles are designed with flexibility and adaptability in mind — create the space you want for the work environment you need.

WORKWALL ORDERING INFORMATION

LAMINATE TILES, LAMINATE MEDIA TILES, SHELVES

L1 LAMINATES/EDGE CODES

Woodgrain

- ◆ Bourbon Cherry/
Bourbon Cherry **HH**
- ◆ Cognac/Cognac ... **COGNCOGN**
- ◆ Field Elm/Field Elm **LWFEFE**
- ◆ Florence Walnut/
Florence Walnut **LFW1FW**
- ◆ Harvest/Harvest **CC**
- ◆ Kingswood Walnut/
Kingswood Walnut **LK11KI**
- ◆ Mahogany/Mahogany **NN**
- ◆ Mocha/Mocha **MOCHMOCH**
- ◆ Natural Maple/
Natural Maple **DD**
- ◆ Pinnacle/Pinnacle **PINCPINC**
- ◆ Shaker Cherry/
Shaker Cherry **FF**
- ◆ Sterling Ash/
Sterling Ash **LSA1SA**

Solid

- ◆ Black/Black **PP**
- ◆ Designer White/
Designer White **LDW1DW**
- ◆ Loft/Loft **LOFTLOFT**

Patterned

- ◆ Silver Mesh/Loft **B9LOFT**

L2 LAMINATES/EDGE CODES

Woodgrain

- ◆ Beigewood **LWBEDE**
- ◆ Fawn Cypress **LFC1FC**
- ◆ Lowell Ash/Lowell Ash . **LLA1DL**
- ◆ Natural Recon/
Natural Recon **LNR1NR**
- ◆ Phantom Ecrú/
Phantom Ecrú **LPE1PE**
- ◆ Portico Teak/
Portico Teak **LPT1DP**
- ◆ Skyline Walnut/
Skyline Walnut **LSW1SW**

PAINTED METAL TILES, SLOTTED TOOL TILES, SINGLE TOOL RAILS, ACCESSORIES

PAINTS CODES

P1

- ◆ Black **P**
- ◆ Brownstone **P7D**
- ◆ Charcoal **S**
- ◆ Cove **P096**
- ◆ Designer White **PJW**
- ◆ Dune **P094**
- ◆ Fossil **P28**
- ◆ Greige **T5**
- ◆ Harbor **P097**
- ◆ Light Gray **Q**
- ◆ Loft **LOFT**
- ◆ Muslin **T3**
- ◆ Putty **L**
- ◆ Sage **P095**
- ◆ Titanium **P8T**

P2

- ◆ Champagne Metallic **T4**
- ◆ Platinum Metallic **T1**
- ◆ Silver **PR6**
- ◆ Solar Black **P8X**

P3

- ◆ Amethyst * **P091**
- ◆ Atom **P8S**
- ◆ Blossom **P8K**
- ◆ Bullseye **PJF**
- ◆ Cobalt Mica * **P090**
- ◆ Ember **P8P**
- ◆ Ion **P8N**
- ◆ Iris **P8J**
- ◆ Krypton **P8F**
- ◆ Ochre **P093**
- ◆ Regatta **P8M**
- ◆ Sienna **P092**
- ◆ Succulent **P8A**

GLASS MARKERBOARD TILES

GLASS CODES

- ◆ Beige **GBG2**
- ◆ Charcoal **GCH2**
- ◆ Cream **GCR2**
- ◆ Ice White **GWH2**
- ◆ Pebble **GPB2**

TILE MOUNTING HARDWARE PAINT

PAINTS CODES

- ◆ Black **P**
- ◆ Charcoal **S**
- ◆ Designer White **PJW**

NOTE: For available fabrics see pages 25-26.

◆◆◆ For lead time information see page 21.

* De-emphasized

TILES

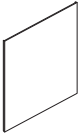

FABRIC TILE

Heights: 7½", 15", 22½", 30", 37½", 45"
Widths: 18", 24", 30", 36", 42", 48", 54", 60"

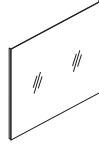

GLASS MARKERBOARD TILE

Heights: 15", 22½", 30", 37½", 45"
Widths: 30", 36", 42", 48", 54", 60"

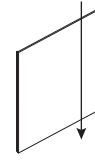

LAMINATE TILE

Grain direction shown
Heights: 7½", 15", 22½", 30", 37½", 45"
Widths: 18", 24", 30", 36"

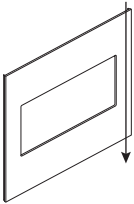

LAMINATE MEDIA TILE

Grain direction shown
Heights: 30", 37½", 45"
Widths: 36", 42", 48", 54"

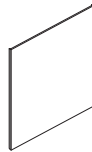

PAINTED METAL TILE

Heights: 7½", 15", 22½", 30"
Widths: 18", 24", 30", 36"

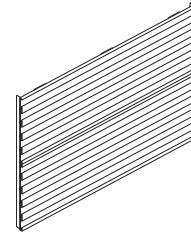

SLOTTED TOOL TILE

Heights: 7½", 15"
Widths: 24", 30", 36", 42", 48", 54", 60"

ACCESSORIES

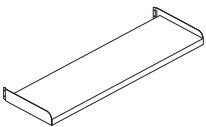

FLOATING SHELF

Widths: 18", 24", 30", 36"

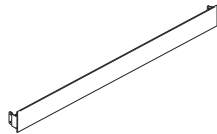

SINGLE TOOL RAIL

Widths: 18", 24", 30", 36", 42", 48", 54", 60"

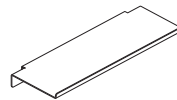

SMALL SHELF

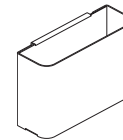

SMALL BIN

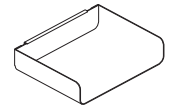

SMALL TRAY

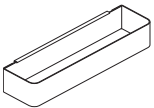

HANGING FILE FOLDER

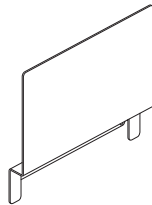

MAGNETIC PICTURE HOLDER

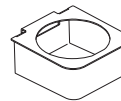

CUP

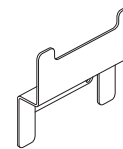

HOOK

WORKWALL SPECIFYING/DESIGN GUIDE

This Specification Guide is designed to walk you through the steps when choosing Workwall elements that will meet your particular workplace needs. The step-by-step instructions make it easy to specify elements that personalize workspaces and achieve the right mix of functionality and style.

Desking With Tower Storage (Example Shown Below)

Recommended to align Workwall tiles with tower height and work your way down the wall.

Desking Without Tower Storage

Recommended to mount Workwall tiles above worksurface and work your way up the wall.

Without Desking or Storage

Floating application can be utilized in open wall environments such as conference rooms or collaboration spaces. Any size of tiles can be used to fit your space.

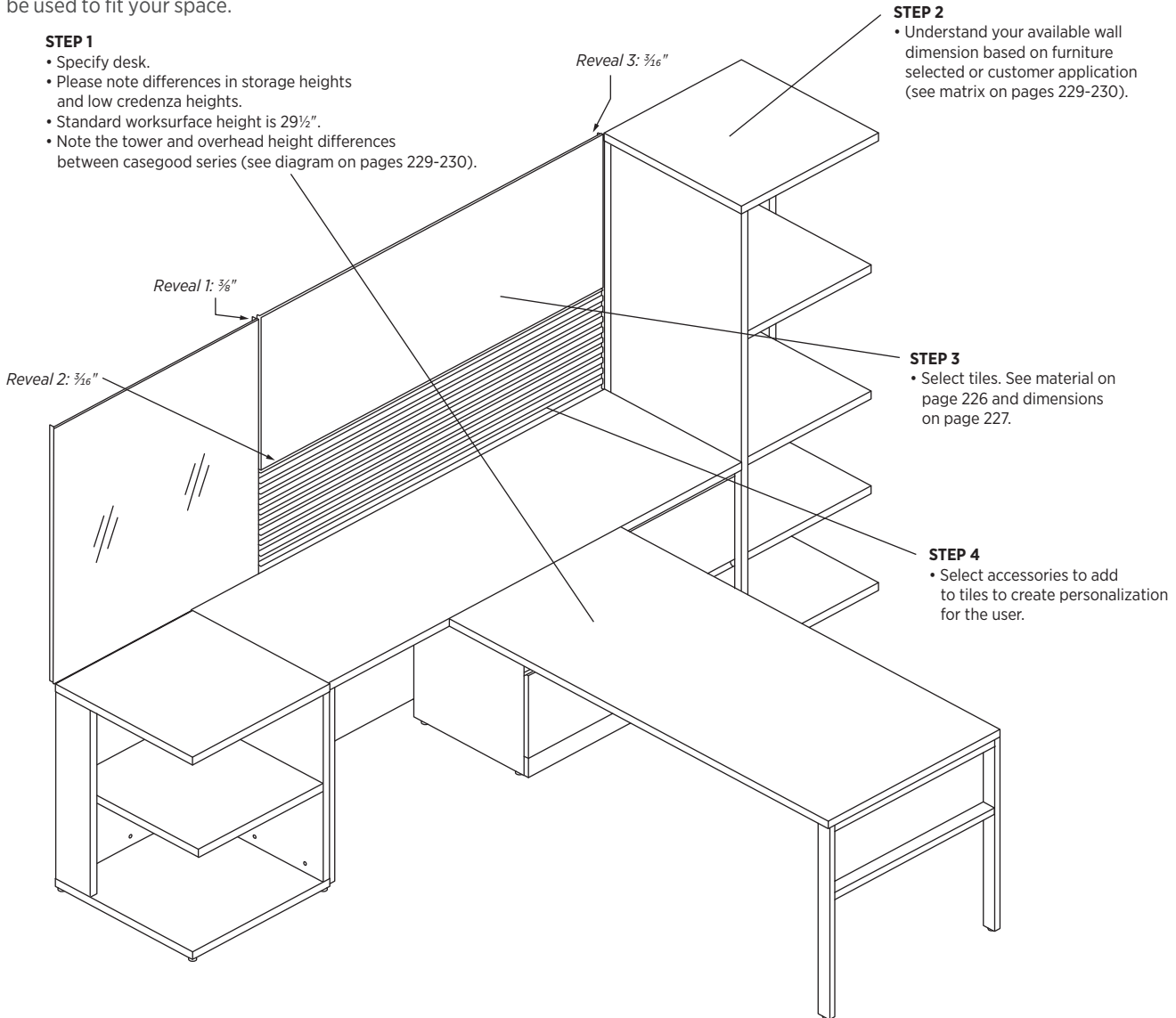

NOTES:

- There is a 3/16” vertical reveal (Reveal 1) and a 3/16” horizontal reveal between tiles (Reveal 2). There is a 3/16” vertical reveal between towers and tiles (Reveal 3).
- Wall attachment method is Z-brackets (2 per tile).
 - Thickness is 7/8” from wall to front of tile (includes tile and hardware).
 - Accessory Single Tool Rail + Accessories (7) + Floating Shelf add to depth dimension.
 - Vertical mounting brackets come pre-installed on tile and hang on Z-brackets. Z-brackets are in two parts. The second part of the Z-bracket is attached to the wall in the field.
 - Wall attachment not included due to different wall types and materials. Attachments must be provided by the installers.
- Wire management or television mounting brackets not included with tiles.

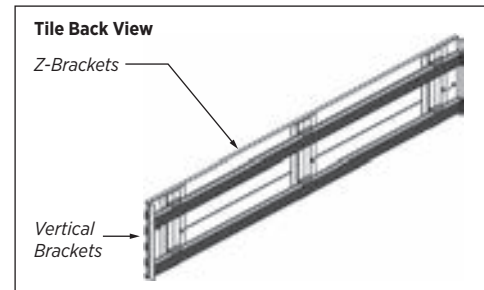

WORKWALL SPECIFYING/DESIGN GUIDE

Below are wall dimensions for Concinnity™ and 10500 Series™. These diagrams should be used to understand sizing between storage and usable wall space.

CONCINNITY™ EXAMPLE

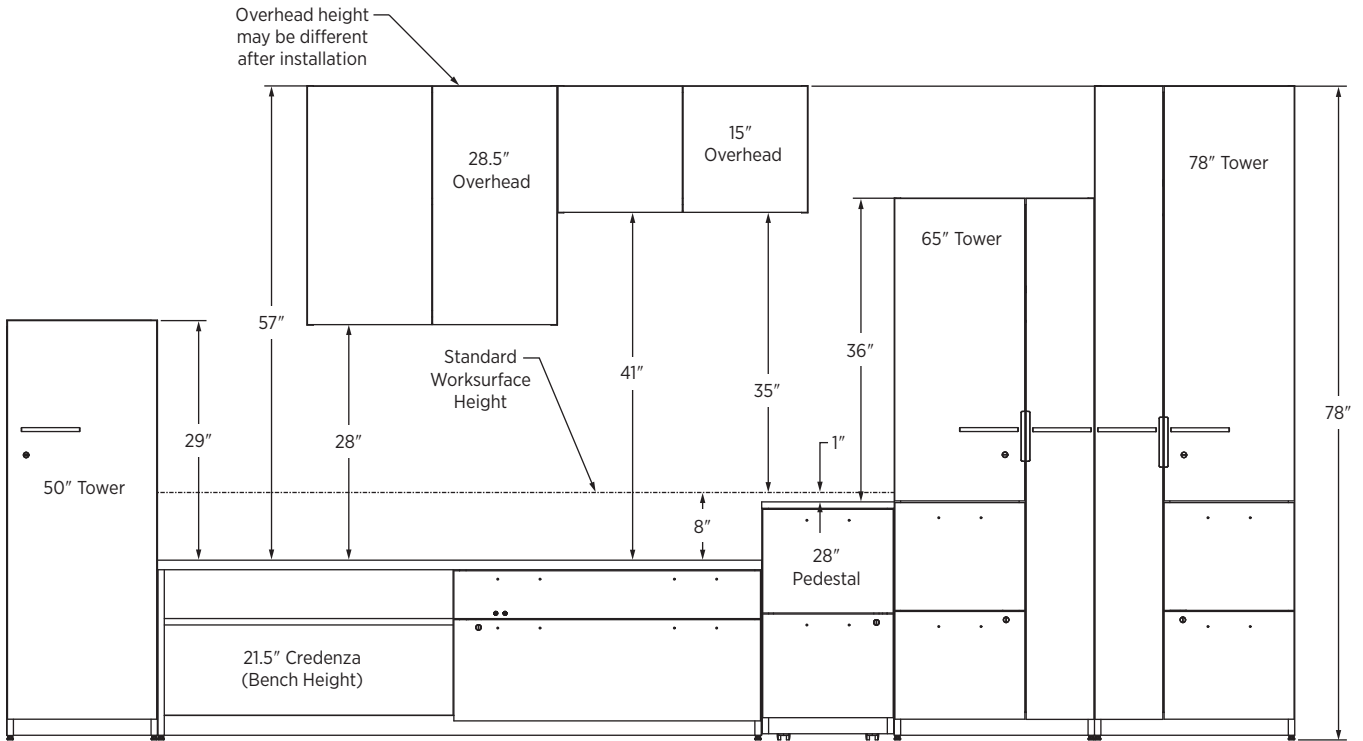

10500 SERIES™ EXAMPLE

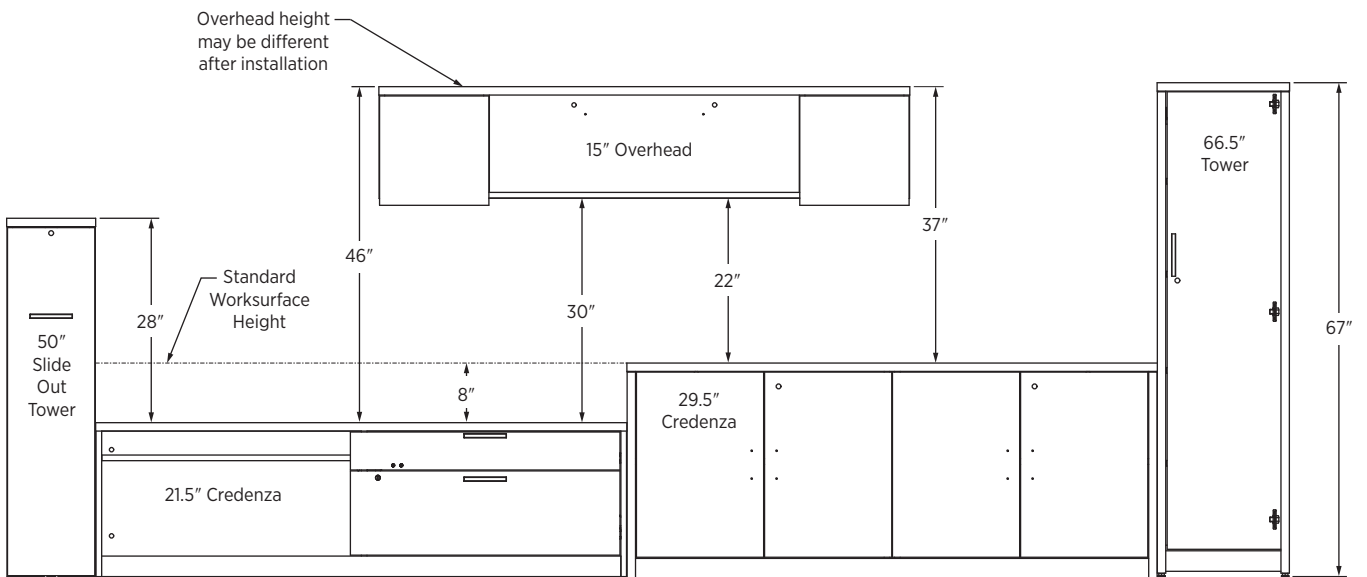

NOTES:

- Overheads can be mounted above or next to Workwall but do not mount to Workwall. Elevation shown above is typical overhead height and may vary in installation.

WORKWALL SPECIFYING/DESIGN GUIDE

Below are wall dimensions for Voi®. This diagram should be used to understand sizing between storage and usable wall space.

VOI® EXAMPLE

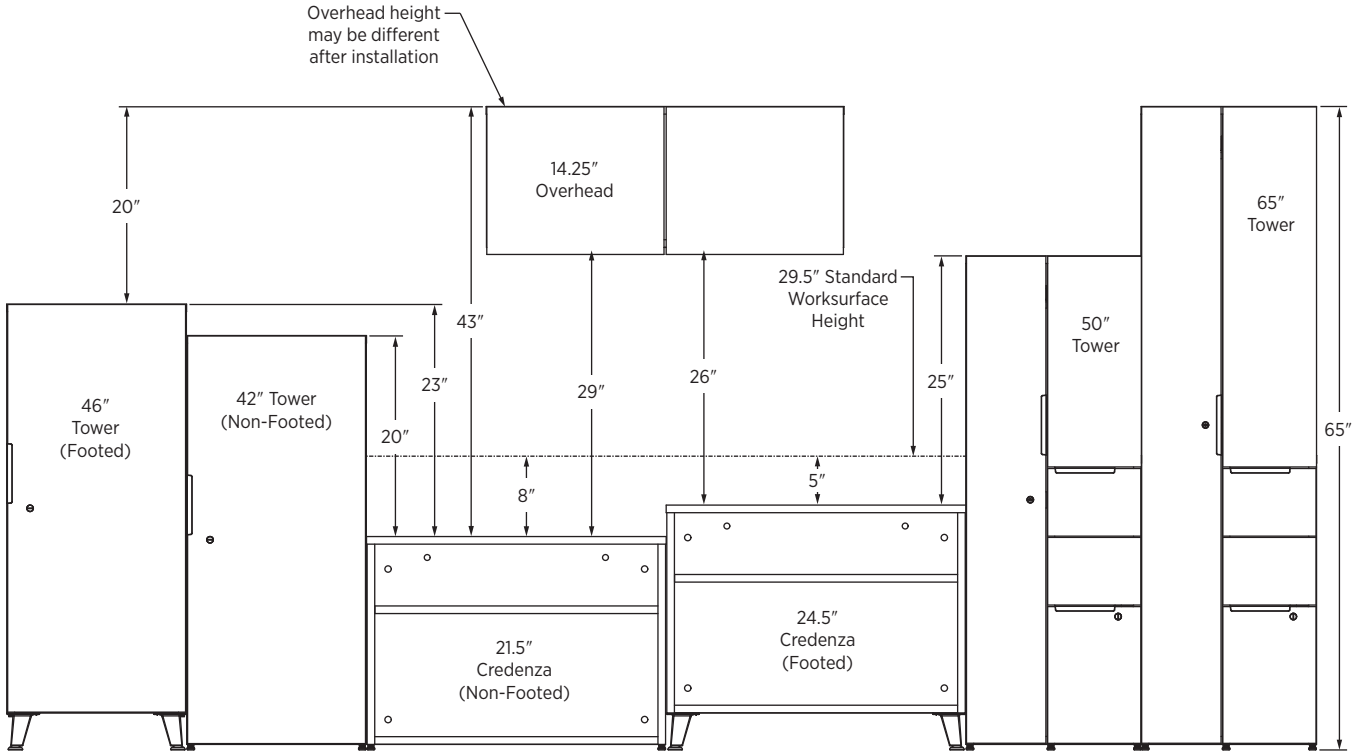

NOTES:

- ❶ Overheads can be mounted above or next to Workwall but do not mount to Workwall. Elevation shown above is typical overhead height and may vary in installation.

TILE CROSS-SECTION

Side view



Z-Bracket

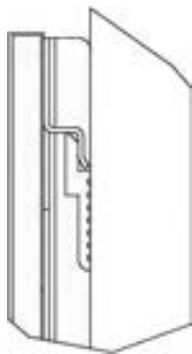

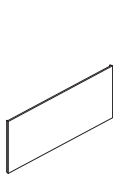

Fabric Tile

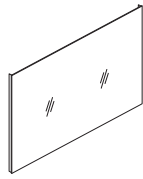

Glass Markerboard Tile

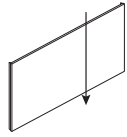

Laminate Tile

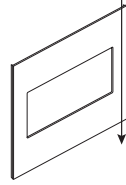

Laminate Media Tile

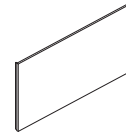

Painted Metal Tile

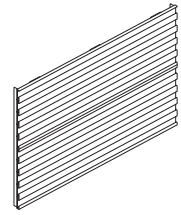

Slotted Tool Tile

Fabric Tiles

	18"W	24"W	30"W	36"W	42"W	48"W	54"W	60"W
7 1/2"H								
15"H								
22 1/2"H								
30"H								
37 1/2"H								
45"H								

Glass Markerboard Tiles

	30"W	36"W	42"W	48"W	54"W	60"W
15"H						
22 1/2"H						
30"H						
37 1/2"H						
45"H						

WORKWALL SPECIFYING/DESIGN GUIDE

Laminate Tiles

	18"W	24"W	30"W	36"W
7 1/2"H				
15"H				
22 1/2"H				
30"H				
37 1/2"H				
45"H				

Laminate Media Tiles

	36"W	42"W	48"W	54"W
30"H				
37 1/2"H				
45"H				

Painted Metal Tiles

	18"W	24"W	30"W	36"W
7 1/2"H				
15"H				
22 1/2"H				
30"H				

Slotted Tool Tiles

	24"W	30"W	36"W	42"W	48"W	54"W	60"W
7 1/2"H							
15"H							

WORKWALL Typicals

QTY	DESCRIPTION	MODEL	LIST PRICE	PRICE EXTENSION	
1	Lateral File Pedestal 36"W x 20"D x 28"H	H10503	\$1,286	\$1,286	
1	Credenza Shell 72"W x 24"D x 29½"H	H10541	\$859	\$859	
1	Square End Cap Bookshelf Left 24"W x 24"D x 29"H	H105526L	\$739	\$739	
1	Square End Cap Bookshelf Right 24"W x 24"D x 66"H	H105527R	\$1,184	\$1,184	
1	H-Leg Support 30"W x 28⅜"H	H105HLEG3028	\$436	\$436	
1	Rectangular Worksurface 66"W x 30"D	H105R3066	\$463	\$463	
1	External Stiffener 60"W	HLSLZ5SC72	\$152	\$152	
1	Fabric Tile 22½"H x 60"W	HWWT2260F	\$640	\$640	
1	Slotted Tool Tile 15"H x 60"W	HWWT1560T	\$811	\$811	Workwall
1	Glass Markerboard Tile 37½"H x 36"W	HWWT3736M	\$1,396	\$1,396	
TOTAL:				\$7,966	

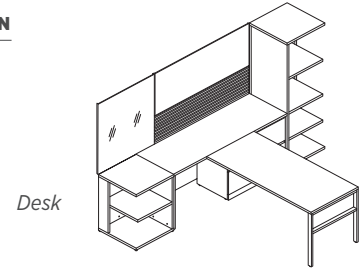

**10500 SERIES™
PRIVATE OFFICE**
118"W x 66½"H x 90"D

QTY	DESCRIPTION	MODEL	LIST PRICE	PRICE EXTENSION	
1	HAT Modular Credenza Top, Left 72"W x 24"D	H105CTHAT7224L	\$991	\$991	
1	HAT Modular Credenza Top, Right 72"W x 24"D	H105CTHAT7224R	\$991	\$991	
2	2-Drawer Credenza, No Top 36"W x 24"D x 21½"H	H105LC3624BF	\$649	\$1,298	
2	HAT Open Storage Cabinet Back 36"W x 21½"H	H105LCHAT3620B	\$274	\$548	
1	HAT Open Credenza, No Top 36"W x 24"D x 21½"H	H105LCHAT3624S	\$298	\$298	
1	Open Wardrobe Tower, B/F Left 18"W x 24"D x 50"H	H105LT182450BFL	\$2,343	\$2,343	Desk
1	Open Wardrobe Tower, B/F Right 18"W x 24"D x 50"H	H105LT182450BFR	\$2,343	\$2,343	
2	Rectangular Worksurface 72"W x 30"D	H105R3072	\$498	\$996	
2	Shroud for Height Adjustable Base 6½"W x 26"D x 23⅝"H	HNL30SHR	\$1,100	\$2,200	
2	Height Adjustable Base 3-Stage, 2-Leg, Rectangle T Foot	HHATB3S2LT	\$1,167	\$2,334	
2	External Stiffener 66"W	HLSLZ5SC78	\$152	\$304	
2	Fabric Tile 45"H x 36"W	HWWT4536F	\$621	\$1,242	
2	Laminate Tile 37½"H x 35"W	HWWT3736L	\$550	\$1,100	
1	Laminate Tile 15"H x 36"W	HWWT1536L	\$388	\$388	Workwall
2	Slotted Tool Tile 7½"H x 36"W	HWWT736T	\$516	\$1,032	
2	Floating Shelf 36"W	HWWASHELF36	\$328	\$656	
TOTAL:				\$19,064	

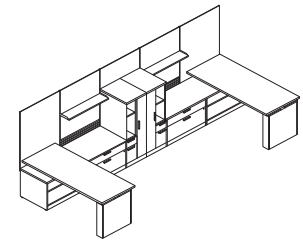

**10500 SERIES™
TEAMING STATION**
180"W x 64"H x 73"D

NOTES: To enhance Workwall, use accessories, single tool rail, or floating shelf. See pages 243-244.

WORKWALL Typicals

QTY	DESCRIPTION	MODEL	LIST PRICE	PRICE EXTENSION
3	Lateral File Pedestal 36"W x 20"D x 28"H	H10503	\$1,286	\$3,858
2	Storage Cabinet/Lateral File 36"W x 20"D x 66 ⁵ / ₈ "H	H105293	\$2,809	\$5,618
1	Rectangle Worksurface 36"W x 24"D	H105R2436	\$258	\$258
1	Rectangle Worksurface 72"W x 24"D	H105R2472	\$424	\$424
10	Field Installed Pull Kit Linear Matte Chrome, 2-Pack	HLINEARC2	\$79	\$790
2	Fabric Tile 7 ¹ / ₂ "H x 36"W	HWWT736F	\$400	\$800
2	Slotted Tool Tile 15"H x 36"W	HWWT1536T	\$572	\$1,144
2	Fabric Tile 15"H x 36"W	HWWT1536F	\$422	\$844
1	Glass Markerboard Tile 37 ¹ / ₂ "H x 36"W	HWWT3736M	\$1,396	\$1,396
TOTAL:			\$15,132	

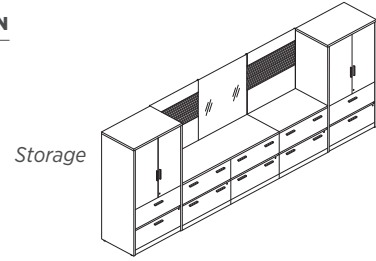

Storage

**10500 SERIES™
STORAGE WALL**
180"W x 66"H x 24"D

Workwall

QTY	DESCRIPTION	MODEL	LIST PRICE	PRICE EXTENSION
1	2-Drawer Lateral File 36"W x 24"D	HNL2436LD2	\$1,529	\$1,529
1	Pedestal Credenza, Right 72"W x 24"D	HNL2472RP	\$1,898	\$1,898
1	Bridge with Full Modesty 48"W x 24"D	HNL2448BF	\$589	\$589
1	Breakfront Rectangle Desk w/Frosted Modesty 72"W x 36"D	HNL3672LPRBF	\$3,120	\$3,120
1	Laminate Tile 45"H x 36"W	HWWT4536L	\$610	\$610
1	Glass Markerboard Tile 45"H x 48"W	HWWT4548M	\$1,764	\$1,764
1	Fabric Tile 45"H x 24"W	HWWT4524F	\$528	\$528
2	Floating Shelf 36"W	HWWASHELF36	\$328	\$656
TOTAL:			\$10,694	

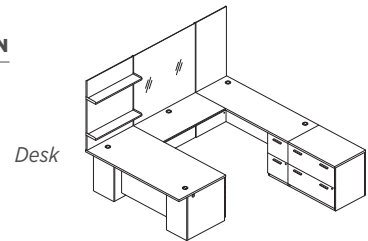

Desk

**CONCINNITY™
PRIVATE OFFICE**
108"W x 74"H x 108"D

Workwall

QTY	DESCRIPTION	MODEL	LIST PRICE	PRICE EXTENSION
1	O-Leg Support 30"D x 28"H	HLSL3028O	\$474	\$474
1	Bookcase End Support 12"W x 30"D x 28 ¹ / ₂ "H	HNL123028BKE	\$666	\$666
2	Low Credenza, 2 Box/2 File 60"W x 20"D x 21 ¹ / ₂ "H	HNL206021D4	\$1,986	\$3,972
1	Storage Cabinet/Lateral File 36"W x 24"D x 64 ³ / ₄ "H	HNL243665SLL	\$3,054	\$3,054
1	Rectangle Worksurface 72"W x 30"D	HNLRC3072	\$564	\$564
2	Fabric Tile 37 ¹ / ₂ "H x 60"W	HWWT3760F	\$793	\$1,586
1	Laminate Tile 37 ¹ / ₂ "H x 30"W	HWWT3730L	\$519	\$519
2	Floating Shelf 30"W	HWWASHELF30	\$312	\$624
TOTAL:			\$11,459	

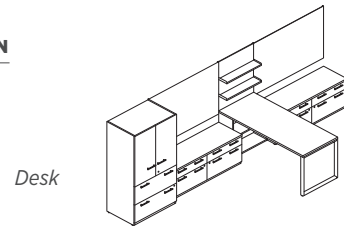

Desk

**CONCINNITY™ LARGE
PRIVATE OFFICE**
186"W x 64"H x 73"D

Workwall

NOTES: To enhance Workwall, use accessories, single tool rail, or floating shelf. See pages 243-244.

WORKWALL Typicals

QTY	DESCRIPTION	MODEL	LIST PRICE	PRICE EXTENSION
1	Low Credenza, 2 File Drawers and Open Top 72"W x 20"D x 21½"H	HLSL2072LD2	\$2,020	\$2,020
2	Support Pedestal 41"H	HLSL2441S	\$1,983	\$3,966
2	Angled Steel Leg 2-Pack	HLSL28AM2	\$427	\$854
1	Rectangle Worksurface 72"W x 24"D	HLSLR2472	\$531	\$531
1	Rectangle Worksurface 72"W x 30"D	HLSLR3072	\$633	\$633
1	External Stiffener 60"W	HLSLZ55C72	\$152	\$152
1	Low Credenza, 4 Storage Doors 72"W x 20"D x 21½"H	HLSL2072S4	\$2,145	\$2,145
2	Laminate Tile 45"H x 36"W	HWWT4536L	\$610	\$1,220
2	Painted Metal Tile 22½"H x 36"W	HWWT2236P	\$352	\$704
1	Fabric Tile 45"H x 36"W	HWWT4536F	\$621	\$621
1	Glass Markerboard Tile 45"H x 36"W	HWWT4536M	\$1,527	\$1,527
TOTAL:			\$14,373	

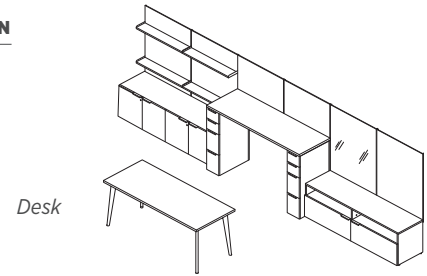

**VOI®
PRIVATE OFFICE**
216"W x 64"H x 107"D*

Desk

Workwall

*Depth is dependent on how far the table desk is away from Workwall.

QTY	DESCRIPTION	MODEL	LIST PRICE	PRICE EXTENSION
1	Seated Height Mobile Collaborative Table 72"W x 42"D	HTMC304272	\$2,390	\$2,390
1	Fabric Tile 45"H x 24"W	HWWT4524F	\$528	\$528
1	Laminate Tile 45"H x 24"W	HWWT4524L	\$538	\$538
1	Glass Markerboard Tile 45"H x 60"W	HWWT4560M	\$2,185	\$2,185
1	Floating Shelf 24"W	HWWASHELF24	\$297	\$297
TOTAL:			\$5,938	

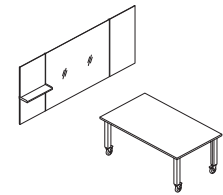

**OPEN COLLABORATIVE
WALL SPACE**
108"W x 45"H

Table

Workwall

QTY	DESCRIPTION	MODEL	LIST PRICE	PRICE EXTENSION
4	Lateral File Pedestal 30"W x 23⅞"D x 28½"H	HNL233028PLF	\$1,262	\$5,048
2	Modesty Back Panel, Full Length 60"W x 27⅞"H	HNLMP6028	\$321	\$642
2	Rectangle Worksurface 60"W x 24"D	HNLRC2460	\$430	\$860
1	Rectangle Table Top 96"W x 48"D	HTLC4896	\$1,064	\$1,064
1	Angled Metal Legs for 96"W Tops 29½"H	HT29AL96	\$1,876	\$1,876
2	Laminate Tile 37½"H x 36"W	HWWT3736L	\$550	\$1,100
1	Laminate Media Tile 37½"H x 48"W	HWWT3748V	\$683	\$683
1	Floating Shelf 36"W	HWWASHELF36	\$328	\$328
1	Single Tool Rail 36"W	HWWARAIL36	\$263	\$263
TOTAL:			\$11,864	

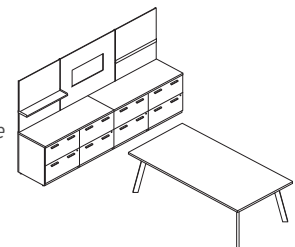

**STORAGE WALL IN
OPEN COLLABORATIVE SPACE**
120"W x 66"H x 30"D

Storage

Table

Workwall

NOTES: To enhance Workwall, use accessories, single tool rail, or floating shelf. See pages 243-244.

WORKWALL Fabric Tiles

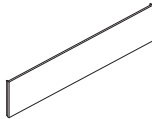
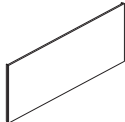
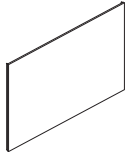
	DESCRIPTION	MODEL	SHIP		LIST PRICE BY FABRIC GRADE								
			WEIGHT	CUBE	AA	A	B	C	D	E	F	G	
	7 1/2" H Fabric Tiles												
	7 1/2" H x 18" W	HWWT718F	4	0.7	\$344	\$349	\$352	\$354	\$360	\$365	\$371	\$374	
	7 1/2" H x 24" W	HWWT724F	4	0.8	\$362	\$367	\$370	\$372	\$378	\$383	\$389	\$392	
	7 1/2" H x 30" W	HWWT730F	4	1.0	\$384	\$389	\$392	\$396	\$402	\$410	\$413	\$416	
	7 1/2" H x 36" W	HWWT736F	4	1.3	\$400	\$405	\$408	\$412	\$418	\$426	\$429	\$432	
	7 1/2" H x 42" W	HWWT742F	4	1.5	\$502	\$508	\$512	\$516	\$527	\$530	\$534	\$538	
	7 1/2" H x 48" W	HWWT748F	4	1.5	\$532	\$538	\$542	\$546	\$557	\$560	\$564	\$568	
	7 1/2" H x 54" W	HWWT754F	5	1.7	\$540	\$561	\$566	\$571	\$583	\$588	\$591	\$594	
7 1/2" H x 60" W	HWWT760F	5	1.8	\$556	\$577	\$582	\$587	\$599	\$604	\$607	\$610		
	15" H Fabric Tiles												
	15" H x 18" W	HWWT1518F	4	1.0	\$360	\$370	\$378	\$387	\$403	\$422	\$439	\$447	
	15" H x 24" W	HWWT1524F	4	1.0	\$383	\$393	\$401	\$410	\$426	\$445	\$462	\$470	
	15" H x 30" W	HWWT1530F	4	1.2	\$403	\$415	\$425	\$436	\$459	\$481	\$492	\$503	
	15" H x 36" W	HWWT1536F	4	1.4	\$422	\$434	\$444	\$455	\$478	\$500	\$511	\$522	
	15" H x 42" W	HWWT1542F	4	1.6	\$528	\$542	\$555	\$570	\$605	\$616	\$627	\$638	
	15" H x 48" W	HWWT1548F	4	1.7	\$554	\$568	\$581	\$596	\$631	\$642	\$653	\$664	
	15" H x 54" W	HWWT1554F	5	2.1	\$572	\$586	\$599	\$614	\$649	\$660	\$671	\$682	
15" H x 60" W	HWWT1560F	5	2.1	\$588	\$602	\$615	\$630	\$665	\$676	\$687	\$698		
	22 1/2" H Fabric Tiles												
	22 1/2" H x 18" W	HWWT2218F	5	1.0	\$382	\$393	\$402	\$413	\$433	\$456	\$470	\$480	
	22 1/2" H x 24" W	HWWT2224F	5	1.3	\$405	\$416	\$425	\$436	\$456	\$479	\$493	\$503	
	22 1/2" H x 30" W	HWWT2230F	5	1.3	\$427	\$440	\$452	\$465	\$489	\$518	\$547	\$557	
	22 1/2" H x 36" W	HWWT2236F	5	1.7	\$455	\$471	\$485	\$496	\$535	\$566	\$578	\$588	
	22 1/2" H x 42" W	HWWT2242F	5	1.7	\$567	\$583	\$597	\$611	\$656	\$681	\$693	\$704	
	22 1/2" H x 48" W	HWWT2248F	5	2.1	\$592	\$608	\$622	\$636	\$681	\$706	\$718	\$729	
	22 1/2" H x 54" W	HWWT2254F	6	2.1	\$626	\$642	\$656	\$670	\$715	\$740	\$752	\$763	
22 1/2" H x 60" W	HWWT2260F	6	2.3	\$640	\$656	\$670	\$684	\$729	\$754	\$766	\$777		



NOTES:

- Accepts single tool rail, accessories, and floating shelf on select sizes (see pages 243-244 for accessory sizes).
- Fabric tiles are tackable.

ⓘ Tiles with accessories or shelves could conflict with the movement of height adjustable table.

HOW TO SPECIFY

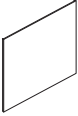
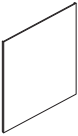
<p>Select Model Number</p> <p>HWWT 2 2 3 6 F</p>	<p>Select Fabric Color</p> <p>See pages 25-26</p> <p>A P N 1 5</p>	<p>Select Mounting Hardware Paint</p> <p>P Black P JW Designer White S Charcoal</p> <p>P</p>
---	---	---

	DESCRIPTION	MODEL	SHIP WEIGHT	CUBE	LIST PRICE BY FABRIC GRADE							
					AA	A	B	C	D	E	F	G
	30”H Fabric Tiles											
	30”H x 18”W	HWWT3018F	5	1.2	\$401	\$413	\$423	\$435	\$458	\$486	\$498	\$508
	30”H x 24”W	HWWT3024F	5	1.7	\$430	\$442	\$452	\$464	\$487	\$515	\$527	\$537
	30”H x 30”W	HWWT3030F	5	2.1	\$463	\$477	\$490	\$505	\$531	\$567	\$613	\$623
	30”H x 36”W	HWWT3036F	5	2.5	\$492	\$511	\$528	\$541	\$596	\$636	\$647	\$658
	30”H x 42”W	HWWT3042F	6	2.9	\$619	\$636	\$652	\$664	\$721	\$760	\$772	\$783
	30”H x 48”W	HWWT3048F	6	3.3	\$641	\$658	\$674	\$686	\$743	\$782	\$794	\$805
	30”H x 54”W	HWWT3054F	7	4.1	\$670	\$687	\$703	\$715	\$772	\$811	\$823	\$834
	30”H x 60”W	HWWT3060F	7	4.1	\$696	\$713	\$729	\$741	\$798	\$837	\$849	\$860
	37½”H Fabric Tiles											
	37½”H x 18”W	HWWT3718F	6	1.6	\$433	\$450	\$466	\$485	\$540	\$574	\$586	\$597
	37½”H x 24”W	HWWT3724F	6	2.1	\$479	\$496	\$512	\$531	\$586	\$620	\$632	\$643
	37½”H x 30”W	HWWT3730F	7	2.6	\$513	\$530	\$546	\$565	\$620	\$654	\$666	\$677
	37½”H x 36”W	HWWT3736F	8	2.5	\$545	\$565	\$585	\$607	\$674	\$723	\$735	\$746
	37½”H x 42”W	HWWT3742F	8	3.6	\$685	\$707	\$728	\$753	\$838	\$888	\$899	\$910
	37½”H x 48”W	HWWT3748F	9	4.1	\$722	\$744	\$767	\$791	\$878	\$929	\$942	\$953
	37½”H x 54”W	HWWT3754F	10	3.2	\$751	\$779	\$806	\$838	\$924	\$987	\$998	\$1011
	37½”H x 60”W	HWWT3760F	11	5.2	\$793	\$821	\$848	\$880	\$966	\$1029	\$1040	\$1053
	45”H Fabric Tiles											
	45”H x 18”W	HWWT4518F	6	1.8	\$481	\$501	\$522	\$544	\$613	\$663	\$675	\$687
	45”H x 24”W	HWWT4524F	6	2.5	\$528	\$548	\$569	\$591	\$660	\$710	\$722	\$734
	45”H x 30”W	HWWT4530F	7	3.1	\$577	\$599	\$620	\$646	\$733	\$783	\$796	\$808
	45”H x 36”W	HWWT4536F	8	3.7	\$621	\$643	\$666	\$690	\$777	\$828	\$841	\$852
	45”H x 42”W	HWWT4542F	8	4.3	\$772	\$794	\$815	\$841	\$927	\$978	\$991	\$1003
	45”H x 48”W	HWWT4548F	9	5.0	\$821	\$843	\$873	\$890	\$977	\$1028	\$1041	\$1052
	45”H x 54”W	HWWT4554F	10	6.2	\$868	\$896	\$924	\$956	\$1041	\$1104	\$1116	\$1129
	45”H x 60”W	HWWT4560F	11	6.2	\$928	\$956	\$984	\$1016	\$1101	\$1164	\$1176	\$1189

NOTES:

- Accepts single tool rail, accessories, and floating shelf on select sizes (see pages 243-244 for accessory sizes).
- Fabric tiles are tackable.

⚠ Tiles with accessories or shelves could conflict with the movement of height adjustable table.

HOW TO SPECIFY

<p>Select Model Number</p> <p>HWWT3036F</p>	<p>Select Fabric Color</p> <p>See pages 25-26</p> <p>APN15</p>	<p>Select Mounting Hardware Paint</p> <p>P Black PJW Designer White S Charcoal</p> <p>P</p>
--	---	--

WORKWALL

Glass Markerboard Tiles

GSA SIN 33721

Icon Legend on page 19

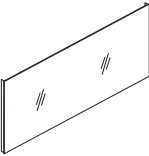
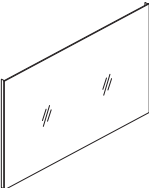
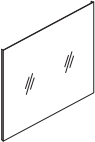
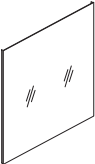
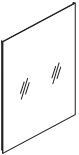
	DESCRIPTION	MODEL	SHIP WEIGHT	CUBE	LIST PRICE
	15"H Glass Markerboard Tiles				
	15"H x 30"W 15"H x 36"W	HWWT1530M HWWT1536M	16 18	2.2 2.6	\$712 \$791
	22½"H Glass Markerboard Tiles				
	22½"H x 30"W 22½"H x 36"W	HWWT2230M HWWT2236M	21 24	3.1 3.6	\$949 \$1054
	30"H Glass Markerboard Tiles				
	30"H x 30"W 30"H x 36"W	HWWT3030M HWWT3036M	25 29	4.0 4.7	\$1158 \$1238
	37½"H Glass Markerboard Tiles				
	37½"H x 30"W	HWWT3730M	30	4.8	\$1317
	37½"H x 36"W	HWWT3736M	35	5.7	\$1396
	37½"H x 42"W	HWWT3742M	40	6.5	\$1475
	37½"H x 48"W	HWWT3748M	44	7.4	\$1607
	37½"H x 54"W	HWWT3754M	48	8.3	\$1737
	45"H Glass Markerboard Tiles				
	45"H x 30"W	HWWT4530M	35	5.8	\$1422
	45"H x 36"W	HWWT4536M	41	6.8	\$1527
	45"H x 42"W	HWWT4542M	46	7.8	\$1633
	45"H x 48"W	HWWT4548M	52	8.8	\$1764
	45"H x 54"W	HWWT4554M	58	9.9	\$2027
	45"H x 60"W	HWWT4560M	63	10.9	\$2185



NOTES:

- Markerboard is magnetic. Recommend using rare earth magnets for best results.
- Material is back-painted glass with square edges, low iron clear (glossy) completely opaque finish and is tempered glass.

HOW TO SPECIFY

Select Model Number <div style="border: 1px solid black; padding: 2px; display: flex; gap: 5px;"> HWWT3036M </div>	Select Glass GBG2 Beige GCH2 Charcoal GCR2 Cream GWH2 Ice White GPB2 Pebble	Select Mounting Hardware Paint P Black PJW Designer White S Charcoal
---	--	---

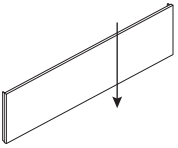
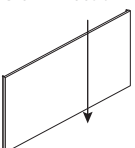
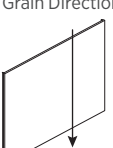
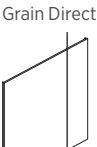
Icon Legend on page 19

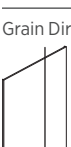
	DESCRIPTION	MODEL	SHIP WEIGHT	CUBE	LIST PRICE BY LAMINATE GRADE	
					L1	L2
Grain Direction 	7½"H Laminate Tiles					
	7½"H x 18"W	HWWT718L	5	0.7	\$335	\$341
	7½"H x 24"W	HWWT724L	5	0.8	\$343	\$354
	7½"H x 30"W	HWWT730L	6	1.0	\$350	\$361
	7½"H x 36"W	HWWT736L	6	1.2	\$356	\$367
Grain Direction 	15"H Laminate Tiles					
	15"H x 18"W	HWWT1518L	6	1.0	\$357	\$363
	15"H x 24"W	HWWT1524L	7	1.0	\$366	\$377
	15"H x 30"W	HWWT1530L	8	1.2	\$378	\$389
	15"H x 36"W	HWWT1536L	9	1.4	\$388	\$399
Grain Direction 	22½"H Laminate Tiles					
	22½"H x 18"W	HWWT2218L	10	1.0	\$383	\$394
	22½"H x 24"W	HWWT2224L	11	2.6	\$399	\$415
	22½"H x 30"W	HWWT2230L	13	2.6	\$415	\$431
	22½"H x 36"W	HWWT2236L	14	4.2	\$432	\$448
Grain Direction 	30"H Laminate Tiles					
	30"H x 18"W	HWWT3018L	11	1.2	\$406	\$417
	30"H x 24"W	HWWT3024L	13	1.5	\$430	\$446
	30"H x 30"W	HWWT3030L	15	1.8	\$451	\$467
	30"H x 36"W	HWWT3036L	17	2.1	\$471	\$487
Grain Direction 	37½"H Laminate Tiles					
	37½"H x 18"W	HWWT3718L	15	1.5	\$453	\$469
	37½"H x 24"W	HWWT3724L	17	1.8	\$485	\$506
	37½"H x 30"W	HWWT3730L	19	2.2	\$519	\$540
	37½"H x 36"W	HWWT3736L	22	2.5	\$550	\$571
Grain Direction 	45"H Laminate Tiles					
	45"H x 18"W	HWWT4518L	16	1.7	\$501	\$517
	45"H x 24"W	HWWT4524L	19	2.1	\$538	\$559
	45"H x 30"W	HWWT4530L	22	2.5	\$573	\$594
	45"H x 36"W	HWWT4536L	25	3.0	\$610	\$631

NOTES:

- Accepts single tool rail, accessories, and floating shelf on select sizes (see pages 243-244 for accessory sizes).

ⓘ Tiles with accessories or shelves could conflict with the movement of height adjustable table.

HOW TO SPECIFY

Select Model Number HWWT3036L	Select Laminate and Edge See page 226 LSA1SA	Select Mounting Hardware Paint P Black PJW Designer White S Charcoal P
---	---	---

WORKWALL Laminate Media Tiles

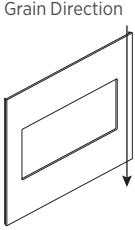
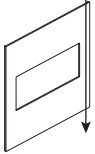
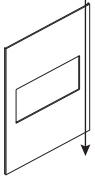
	DESCRIPTION	MODEL	SHIP WEIGHT	CUBE	LIST PRICE BY LAMINATE GRADE	
					L1	L2
 <p>Grain Direction</p>	30"H Laminate Media Tiles					
	30"H x 36"W	HWWT3036V	9	2.1	\$529	\$545
	30"H x 42"W	HWWT3042V	11	2.4	\$566	\$582
	30"H x 48"W	HWWT3048V	14	2.7	\$601	\$622
 <p>Grain Direction</p>	37½"H Laminate Media Tiles					
	37½"H x 36"W	HWWT3736V	14	2.5	\$611	\$632
	37½"H x 42"W	HWWT3742V	16	2.9	\$646	\$667
	37½"H x 48"W	HWWT3748V	19	3.2	\$683	\$710
	37½"H x 54"W	HWWT3754V	21	3.6	\$717	\$744
 <p>Grain Direction</p>	45"H Laminate Media Tiles					
	45"H x 36"W	HWWT4536V	17	3.0	\$669	\$690
	45"H x 42"W	HWWT4542V	20	3.4	\$704	\$731
	45"H x 48"W	HWWT4548V	23	3.8	\$740	\$767
	45"H x 54"W	HWWT4554V	26	4.2	\$776	\$808

NOTES:

- Media tile does not include wire management. Intended for power to be behind TV. Cords do not route behind tile.
- Tiles with accessories or shelves could conflict with the movement of height adjustable table.
- Wire management or television mounting brackets not included with tiles.

TV SCREEN DIMENSIONS			Workwall Tile	APPROXIMATE DIMENSIONS AROUND TV	
TV Size	Screen Height	Screen Width		Top & Bottom Border	Left & Right Border
32	15.7	27.9	HWWT3036M	7"	4"
			HWWT3736M	10.5"	
			HWWT4536M	14.5"	
40	19.6	34.9	HWWT3042M	5"	3.5"
			HWWT3742M	8.5"	
			HWWT4542V	12.5"	
43	21.1	37.5	HWWT3048V	4"	5"
			HWWT3748V	8"	
			HWWT4548V	11.5"	
50	24.5	43.6	HWWT3748V	6"	2"
			HWWT4548V	10"	
			HWWT3754V	6"	5"
			HWWT4554V	10"	

NOTES:

- TV true size height and width are for screen only, it does not take TV/monitor bevel into account. Please note chart is directional for TV sizes and actual dimensions should be confirmed with TV manufacturer.
- Borders show dimensions of visual laminate tile around the outside of the TV.
- TV Mount Opening is 12"H x 27"W and is centered on all Media Tiles.

HOW TO SPECIFY

<p>Select Model Number</p> <p>HWWT3036V</p>	<p>Select Laminate and Edge</p> <p>See page 226</p> <p>LSA1SA</p>	<p>Select Mounting Hardware Paint</p> <p>P Black P JW Designer White S Charcoal</p> <p>P</p>
--	--	---

WORKWALL Painted Metal Tiles

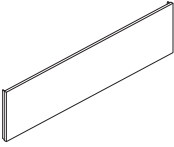
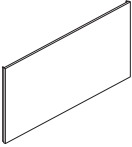
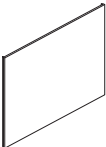
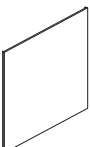
	DESCRIPTION	MODEL	SHIP WEIGHT	CUBE	LIST PRICE BY PAINT GRADE		
					P1	P2	P3
	7 1/2" H Painted Metal Tiles						
	7 1/2" H x 18" W	HWWT718P	4	0.7	\$257	\$273	\$280
	7 1/2" H x 24" W	HWWT724P	4	0.8	\$281	\$297	\$306
	7 1/2" H x 30" W	HWWT730P	6	1.0	\$305	\$321	\$331
	7 1/2" H x 36" W	HWWT736P	6	1.2	\$328	\$344	\$356
	15" H Painted Metal Tiles						
	15" H x 18" W	HWWT1518P	6	1.0	\$269	\$291	\$300
	15" H x 24" W	HWWT1524P	6	1.0	\$293	\$315	\$325
	15" H x 30" W	HWWT1530P	7	1.2	\$315	\$337	\$348
	15" H x 36" W	HWWT1536P	7	1.4	\$339	\$361	\$374
	22 1/2" H Painted Metal Tiles						
	22 1/2" H x 18" W	HWWT2218P	8	1.0	\$281	\$310	\$318
	22 1/2" H x 24" W	HWWT2224P	8	1.3	\$305	\$334	\$343
	22 1/2" H x 30" W	HWWT2230P	9	1.3	\$328	\$357	\$367
	22 1/2" H x 36" W	HWWT2236P	9	1.7	\$352	\$381	\$393
	30" H Painted Metal Tiles						
	30" H x 18" W	HWWT3018P	9	1.2	\$293	\$328	\$337
	30" H x 24" W	HWWT3024P	9	1.7	\$315	\$350	\$361
	30" H x 30" W	HWWT3030P	10	2.1	\$339	\$374	\$389
	30" H x 36" W	HWWT3036P	11	2.5	\$363	\$398	\$417

NOTES:

- Accepts single tool rail, accessories, and floating shelf on select sizes (see pages 243-244 for accessory sizes).
- Metal tiles are magnetic.

 Tiles with accessories or shelves could conflict with the movement of height adjustable table.

HOW TO SPECIFY

<p>Select Model Number</p> <p>HWWT3036P</p>	<p>Select Tile Paint Color</p> <p>See page 226</p> <p>PJW</p>	<p>Select Mounting Hardware Paint</p> <p>P Black PJW Designer White S Charcoal</p> <p>P</p>
--	--	--

WORKWALL

Slotted Tool Tiles

GSA SIN 33721

Icon Legend on page 19

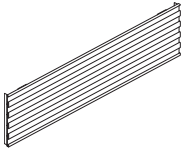
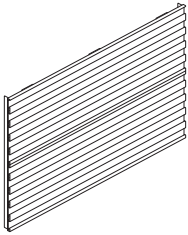
	DESCRIPTION	MODEL	SHIP WEIGHT	CUBE	LIST PRICE BY PAINT GRADE		
					P1	P2	P3
	7 1/2" H Slotted Tool Tiles						
	7 1/2" H x 24" W	HWWT724T	6	0.8	\$411	\$427	\$451
	7 1/2" H x 30" W	HWWT730T	7	1.0	\$466	\$482	\$510
	7 1/2" H x 36" W	HWWT736T	8	1.2	\$516	\$532	\$565
	7 1/2" H x 42" W	HWWT742T	9	1.3	\$570	\$586	\$623
	7 1/2" H x 48" W	HWWT748T	11	1.5	\$623	\$639	\$679
	7 1/2" H x 54" W	HWWT754T	12	1.7	\$689	\$705	\$747
	7 1/2" H x 60" W	HWWT760T	13	1.8	\$755	\$771	\$815
	15" H Slotted Tool Tiles						
	15" H x 24" W	HWWT1524T	11	1.0	\$469	\$500	\$524
	15" H x 30" W	HWWT1530T	13	1.2	\$521	\$552	\$580
	15" H x 36" W	HWWT1536T	15	1.4	\$572	\$603	\$635
	15" H x 42" W	HWWT1542T	17	1.6	\$625	\$656	\$692
	15" H x 48" W	HWWT1548T	20	1.7	\$679	\$710	\$750
	15" H x 54" W	HWWT1554T	22	2.1	\$746	\$777	\$819
	15" H x 60" W	HWWT1560T	24	2.1	\$811	\$842	\$886

NOTES:

- ❗ Slotted Tool Tile tested to 80 lbs. per tile (including accessories and what is stored in them) and must not exceed.
- ❗ Tiles with accessories or shelves could conflict with the movement of height adjustable table.

HOW TO SPECIFY

Select
Model Number

HWWT1536T

Select
Tile Paint Color

See page 226

PJW

Select
Mounting Hardware Paint

P Black
PJW Designer White
S Charcoal

P

Icon Legend on page 19

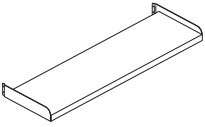
	DESCRIPTION	MODEL	SHIP WEIGHT	CUBE	LIST PRICE	UPCHARGE BY LAMINATE/PAINT GRADE		
						L2	P2	P3
	Floating Shelves							
	18"W	HWWASHELF18	9	0.4	\$282	\$6	\$7	\$12
	24"W	HWWASHELF24	10	0.5	\$297	\$11	\$7	\$12
	30"W	HWWASHELF30	11	0.6	\$312	\$11	\$7	\$12
	36"W	HWWASHELF36	12	0.7	\$328	\$11	\$7	\$12

NOTES:

- Shelves can be mounted on laminate, fabric, and metal tiles.
 - Can be mounted up to 2 on a single tile.
 - Shelves tested to 50 lbs. per floating shelf.
 - Shelves can be mounted at predetermined locations, pilot holes included.
- ⚠ Tiles with accessories or shelves could conflict with the movement of height adjustable table.

HOW TO SPECIFY

Select Model Number H W W A S H E L F 3 6 .	Select Laminate and Edge See page 226 L S A 1 S A .	Select Floating Shelf Bracket Paint See page 226 P
---	--	---

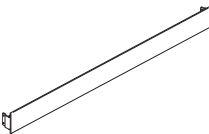
	DESCRIPTION	MODEL	SHIP WEIGHT	CUBE	LIST PRICE BY PAINT GRADE		
					P1	P2	P3
	Single Tool Rail Accessory						
	18"W	HWWARAIL18	2	0.4	\$231	\$238	\$243
	24"W	HWWARAIL24	2	0.4	\$239	\$246	\$251
	30"W	HWWARAIL30	2	0.5	\$255	\$262	\$267
	36"W	HWWARAIL36	3	0.6	\$263	\$270	\$275
	42"W	HWWARAIL42	3	0.6	\$277	\$284	\$289
	48"W	HWWARAIL48	4	0.7	\$288	\$295	\$300
	54"W	HWWARAIL54	4	0.7	\$311	\$318	\$323
	60"W	HWWARAIL60	4	0.8	\$328	\$335	\$340

NOTES:

- Accessory rails can be mounted on laminate, laminate media, fabric, and metal tiles.
 - Can be mounted up to 2 on a single tile.
 - Accessory rails can be mounted at predetermined locations, pilot holes included.
 - Brackets match paint selected for single tool rail.
- ⚠ 18-36"W Single Tool Rails are tested to a distributed 20 lbs. per single tool rail (including accessories and what is stored in them) and must not exceed.
- ⚠ 42-60"W Single Tool Rails are tested to a distributed 10 lbs. per single tool rail (including accessories and what is stored in them) and must not exceed.
- ⚠ Abound® accessories cannot be used on single rail but can be used on Slotted Tool Tiles.
- ⚠ Tiles with accessories or shelves could conflict with the movement of height adjustable table.

HOW TO SPECIFY

Select Model Number H W W A R A I L 3 6 .	Select Single Tool Rail and Bracket Paint See page 226 P
---	---

WORKWALL

Accessories

GSA SIN 33721

Icon Legend on page 19

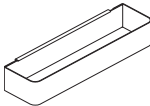
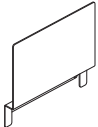
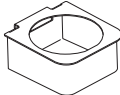
	DESCRIPTION	MODEL	SHIP WEIGHT	CUBE	LIST PRICE BY PAINT GRADE		
					P1	P2	P3
	Small Shelf 1"H x 10"W x 3/4"D	HWWATS	2	0.1	\$142	\$149	\$154
	Small Bin 4"H x 6"W x 2 1/4"D	HWWASB	3	0.1	\$142	\$149	\$154
	Small Tray 2"H x 9"W x 7/4"D	HWWAST	2	0.1	\$158	\$165	\$170
	Hanging File Folder 2"H x 12 1/4"W x 3 1/4"D	HWWAP	1	0.1	\$158	\$165	\$170
	Magnetic Picture Holder 5 1/4"H x 6"W x 3/4"D	HWWAPH	2	0.5	\$130	\$137	\$142
	Cup 2"H x 4 1/4"W x 4 1/2"D	HWWAC	1	0.1	\$130	\$137	\$142
	Hook 2 3/4"H x 3"W x 3/4"D	HWWAH	1	0.1	\$130	\$137	\$142

NOTES:

- Accessories work on single tool rail and Slotted Tool Tiles.

HOW TO SPECIFY

Select
Model Number

H W W A S T .

Select
Paint Color

See page 226

P

10500 SERIES™

Want to see more? Scan here
to check out hon.com.



10500 Series™ Desking
shown with Ignition® Seating.

10500 SERIES™

Endlessly adaptable and unexpectedly affordable, our 10500 Series offers truly lasting value. The versatile design and options give you an even wider range of layout possibilities and the flexibility to maximize footprints — even smaller ones. And with more ways to customize your personal storage, the 10500 Series simply gives you more for less.



FEATURES

- The 10500 Series' fresh aesthetic includes airy H- or O-legs and frosted modesty panels.
- Available in 23 durable mix-and-match laminates, including new textured styles.
- With so many convenient and compact storage options, even the smallest footprints feel big.
- The versatile 10500 Series™ offers a variety of components to accommodate any size workspace.
- Support today's healthy work styles by offering the choice of sitting or standing while working, with storage options that fit your needs.

10500 SERIES™ ORDERING INFORMATION

LAMINATE TOP, CHASSIS, AND WORKSURFACES

L1 LAMINATES CODES

Woodgrain

◆ Bourbon Cherry	H
◆ Cognac	COGN
◆ Field Elm	LWFE
◆ Florence Walnut	LFW1
◆ Harvest	C
◆ Kingswood Walnut	LKI1
◆ Mahogany	N
◆ Mocha	MOCH
◆ Natural Maple	D
◆ Pinnacle	PINC
◆ Shaker Cherry	F
◆ Sterling Ash	LSA1

Solid

◆ Black	P
◆ Charcoal	S
◆ Designer White	LDW1
◆ Loft	LOFT

Patterned Top

◆ Handspun Chestnut	LAHC
◆ Handspun Dove	LAHD
◆ Handspun Pearl	LAHP
◆ Handspun Slate	LAHS
◆ Silver Mesh	B9(*)

L2 LAMINATES CODES

Woodgrain

◆ Beigewood	LWBE
◆ Fawn Cypress	LFC1
◆ Lowell Ash	LLA1
◆ Natural Recon	LNRI
◆ Phantom Ecru	LPE1
◆ Portico Teak	LPT1
◆ Skyline Walnut	LSW1

EDGE BAND

EDGE BAND COLORS CODES

Woodgrain

◆ Beigewood	DE
◆ Bourbon Cherry	H
◆ Cognac	COGN
◆ Fawn Cypress	FC
◆ Field Elm	FE
◆ Florence Walnut	FW
◆ Harvest	C
◆ Kingswood Walnut	KI
◆ Lowell Ash	DL
◆ Mahogany	N
◆ Mocha	MOCH
◆ Natural Maple	D
◆ Natural Recon	NR
◆ Phantom Ecru	PE
◆ Pinnacle	PINC
◆ Portico Teak	DP
◆ Shaker Cherry	F
◆ Skyline Walnut	SW
◆ Sterling Ash	SA

Solid

◆ Black	P
◆ Brownstone	EY
◆ Charcoal	S
◆ Designer White	DW
◆ Fossil	EH
◆ Loft	LOFT

10500 SERIES™ MOBILE TABLES

PAINTS CODES

P1

◆ Black	P
◆ Brownstone	P7D
◆ Charcoal	S
◆ Designer White	PJW
◆ Fossil	P28
◆ Greige	T5
◆ Loft	LOFT
◆ Muslin	T3
◆ Titanium	P8T

P2

◆ Champagne Metallic	T4
◆ Gunmetal Metallic	PR3
◆ Platinum Metallic	T1
◆ Silver	PR6

H-LEGS, O-LEGS, POST LEGS, STORAGE CUBE

PAINTS CODES

P1

◆ Black	P
◆ Brownstone	P7D
◆ Charcoal	S
◆ Cove	P096
◆ Designer White	PJW
◆ Dune	P094
◆ Fossil	P28
◆ Greige	T5
◆ Harbor	P097
◆ Loft	LOFT
◆ Muslin	T3
◆ Sage	P095
◆ Titanium	P8T

P2

◆ Champagne Metallic	T4
◆ Gunmetal Metallic	PR3
◆ Platinum Metallic	T1
◆ Silver	PR6
◆ Solar Black	P8X

P3

◆ Amethyst*	P091
◆ Atom	P8S
◆ Blossom	P8K
◆ Bullseye	PJF
◆ Cobalt Mica*	P090
◆ Ember	P8P
◆ Ion	P8N
◆ Iris	P8J
◆ Krypton	P8F
◆ Ochre	P093
◆ Regatta	P8M
◆ Sienna	P092
◆ Succulent	P8A

◆◆◆ For lead time information see page 21.

Patterned Top

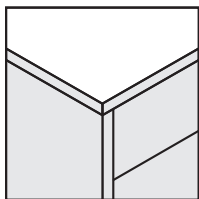

Edgeband Around Top / Laminate Chassis

- Edgebanding on patterned laminates matches the laminate chassis selected.
- Patterned top laminates are available with the following edgeband laminate selection: C, COGN, D, F, FW, H, KI, DW, MOCH, N, P, PINC, SA, and S.
- For 10500 Series™ worksurface models, the finish specification options include matching the top and edgeband colors or choosing a two-tone combination.

LAMINATE DESKS

SPECIFY: Model Number.
Laminate

EXAMPLE: H105413.NN

WORKSURFACES

SPECIFY: Model Number.
Top Laminate
Edgeband

- All specifications in this publication are based on the latest product information available at the time of print.

! Tops with a patterned color are not available with a matching edgeband.

* De-emphasized

10500 SERIES™ ORDERING INFORMATION

TWO-TONE LAMINATE TOP / CHASSIS

L1 LAMINATES	CODES
Two-Tone Top/Chassis	
◆ Black/Charcoal	PS
◆ Black/Designer White	PLDW1
◆ Black/Loft	PLOFT
◆ Bourbon Cherry/Black	HP
◆ Bourbon Cherry/Charcoal	HS
◆ Bourbon Cherry/Designer White	HLDW1
◆ Bourbon Cherry/Loft	HLOFT
◆ Charcoal/Black	SP
◆ Charcoal/Designer White	SLDW1
◆ Charcoal/Loft	SLOFT
◆ Cognac/Black	COGNP
◆ Cognac/Charcoal	COGNS
◆ Cognac/Designer White	COGNLDW1
◆ Cognac/Loft	COGNLOFT
◆ Designer White/Black	LDW1P
◆ Designer White/Bourbon Cherry	LDW1H
◆ Designer White/Charcoal	LDW1S
◆ Designer White/Cognac	LDW1COGN
◆ Designer White/Florence Walnut	LDW1LFW1
◆ Designer White/Harvest	LDW1C
◆ Designer White/Kingswood Walnut	LDW1LKI1
◆ Designer White/Loft	LDW1LOFT
◆ Designer White/Mahogany	LDW1N
◆ Designer White/Mocha	LDW1MOCH
◆ Designer White/Natural Maple	LDW1D
◆ Designer White/Pinnacle	LDW1PINC
◆ Designer White/Shaker Cherry	LDW1F
◆ Designer White/Sterling Ash	LDW1LSA1
◆ Field Elm/Black	LWFEP
◆ Field Elm/Charcoal	LWFES
◆ Field Elm/Designer White	LWFELDW1
◆ Field Elm/Loft	LWFELOFT
◆ Florence Walnut/Black	LFW1P
◆ Florence Walnut/Charcoal	LFW1S
◆ Florence Walnut/Designer White	LFW1LDW1
◆ Florence Walnut/Loft	LFW1LOFT

TWO-TONE LAMINATE TOP / CHASSIS *continued*

L1 LAMINATES	CODES
Two-Tone Top/Chassis	
◆ Handspun Chestnut/Black	LAHCP
◆ Handspun Chestnut/Charcoal	LAHCS
◆ Handspun Chestnut/Designer White	LAHCLDW1
◆ Handspun Chestnut/Loft	LAHCLOFT
◆ Handspun Dove/Black	LAHDP
◆ Handspun Dove/Charcoal	LAHDS
◆ Handspun Dove/Designer White	LAHDLDW1
◆ Handspun Dove/Loft	LAHDLOFT
◆ Handspun Pearl/Black	LAHPP
◆ Handspun Pearl/Charcoal	LAHPS
◆ Handspun Pearl/Designer White	LAHPLDW1
◆ Handspun Pearl/Loft	LAHPLOFT
◆ Handspun Slate/Black	LAHSP
◆ Handspun Slate/Charcoal	LAHSS
◆ Handspun Slate/Designer White	LAHSLDW1
◆ Handspun Slate/Loft	LAHSLLOFT
◆ Harvest/Black	CP
◆ Harvest/Charcoal	CS
◆ Harvest/Designer White	CLDW1
◆ Harvest/Loft	CLOFT
◆ Kingswood Walnut/Black	LKI1P
◆ Kingswood Walnut/Charcoal	LKI1S
◆ Kingswood Walnut/Designer White	LKI1LDW1
◆ Kingswood Walnut/Loft	LKI1LOFT
◆ Loft/Black	LOFTP
◆ Loft/Charcoal	LOFTS
◆ Loft/Designer White	LOFTLDW1
◆ Mahogany/Black	NP
◆ Mahogany/Charcoal	NS
◆ Mahogany/Designer White	NLDW1
◆ Mahogany/Loft	NLOFT

TWO-TONE LAMINATE TOP / CHASSIS *continued*

L1 LAMINATES	CODES
Two-Tone Top/Chassis	
◆ Mocha/Black	MOCHP
◆ Mocha/Charcoal	MOCHS
◆ Mocha/Designer White	MOCHLDW1
◆ Mocha/Loft	MOCHLOFT
◆ Natural Maple/Black	DP
◆ Natural Maple/Charcoal	DS
◆ Natural Maple/Designer White	DLDW1
◆ Natural Maple/Loft	DLOFT
◆ Pinnacle/Black	PINCP
◆ Pinnacle/Charcoal	PINCS
◆ Pinnacle/Designer White	PINCLDW1
◆ Pinnacle/Loft	PINCLLOFT
◆ Shaker Cherry/Black	FP
◆ Shaker Cherry/Charcoal	FS
◆ Shaker Cherry/Designer White	FLDW1
◆ Shaker Cherry/Loft	FLOFT
◆ Sterling Ash/Black	LSA1P
◆ Sterling Ash/Charcoal	LSA1S
◆ Sterling Ash/Designer White	LSA1LDW1
◆ Sterling Ash/Loft	LSA1LOFT
L2 LAMINATES	
Two-Tone Top/Chassis	
◆ Beigewood/Black	LWBEP
◆ Beigewood/Charcoal	LWBES
◆ Beigewood/Designer White	LWBELDW1
◆ Beigewood/Loft	LWBELLOFT
◆ Designer White/Lowell Ash	LDW1LLA1
◆ Designer White/Natural Recon	LDW1LNR1
◆ Designer White/Phantom Ecru	LDW1LPE1
◆ Designer White/Portico Teak	LDW1LPT1
◆ Designer White/Skyline Walnut	LDW1LSW1
◆ Fawn Cypress/Black	LFC1P
◆ Fawn Cypress/Charcoal	LFC1S
◆ Fawn Cypress/Designer White	LFC1LDW1
◆ Fawn Cypress/Loft	LFC1LOFT
◆ Lowell Ash/Black	LLA1P
◆ Lowell Ash/Charcoal	LLA1S
◆ Lowell Ash/Designer White	LLA1LDW1
◆ Lowell Ash/Loft	LLA1LOFT

TWO-TONE LAMINATE TOP / CHASSIS *continued*

L2 LAMINATES	CODES
Two-Tone Top/Chassis	
◆ Natural Recon/Black	LNR1P
◆ Natural Recon/Charcoal	LNR1S
◆ Natural Recon/Designer White	LNR1LDW1
◆ Natural Recon/Loft	LNR1LOFT
◆ Phantom Ecru/Black	LPE1P
◆ Phantom Ecru/Charcoal	LPE1S
◆ Phantom Ecru/Designer White	LPE1LDW1
◆ Phantom Ecru/Loft	LPE1LOFT
◆ Portico Teak/Black	LPT1P
◆ Portico Teak/Charcoal	LPT1S
◆ Portico Teak/Designer White	LPT1LDW1
◆ Portico Teak/Loft	LPT1LOFT
◆ Skyline Walnut/Black	LSW1P
◆ Skyline Walnut/Charcoal	LSW1S
◆ Skyline Walnut/Designer White	LSW1LDW1
◆ Skyline Walnut/Loft	LSW1LOFT

HLAM3772RD, HLAM3348RR

EDGE BAND COLORS

Woodgrain	CODES
◆ Beigewood	DE
◆ Bourbon Cherry	H
◆ Cognac	COGN
◆ Fawn Cypress	FC
◆ Field Elm	FE
◆ Florence Walnut	FW
◆ Harvest	C
◆ Kingswood Walnut	KI
◆ Lowell Ash	DL
◆ Mahogany	N
◆ Mocha	MOCH
◆ Natural Maple	D
◆ Natural Recon	NR
◆ Phantom Ecru	PE
◆ Pinnacle	PINC
◆ Portico Teak	DP
◆ Shaker Cherry	F
◆ Skyline Walnut	SW
◆ Sterling Ash	SA
Solid	
◆ Black	P
◆ Charcoal	S
◆ Designer White	DW
◆ Loft	LOFT

◆◆◆ For lead time information see page 21.

10500 SERIES™ ORDERING INFORMATION

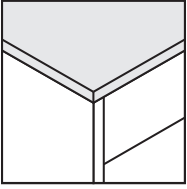

Laminate Chassis

Two-tone laminates: Top and edgebanding are the same, chassis is different laminate color.

The following 10500 Series™ products are not available as two-tone. They are one color and require only one color code:

- *Modular pedestals — box/file, box/box/file, file/file, lateral file, multi file, and cabinet (also applies to Valido/11500 Series).*
- *Access strip and end panel kits*
- *Back enclosures*
- *Wall mounted open shelf*
- *Reception stations for return*
- *T-shaped end panels*
- *L-shaped end panels*

Storage chassis that are specified in L2 laminates and are longer than 60"W will ship with back panels that are horizontal grain.

- *Edgebanding on two-tone laminates matches top, chassis is a different laminate color.*
- *A complete selection of Conference Room and Occasional Tables is shown in the Tables section of the 2023 Shared Spaces Pricer.*

LAMINATE DESKS

SPECIFY: Model Number.

Laminate

EXAMPLE: H10596.HP

- **All specifications in this publication are based on the latest product information available at the time of print.**

10500 Series™ Statement of Line

DESKS



Double Full Pedestal Desk, Bow Top

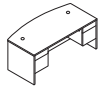

Double 3/4 Pedestal Desk, Bow Top

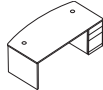

Single Full Pedestal Desk, Bow Top

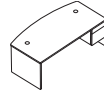

Single 3/4 Pedestal Desk, Bow Top

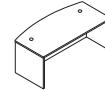

Desk Shell, Bow Top

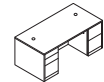

Double Full Pedestal Desk, Rectangle Top

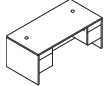

Double 3/4 Pedestal Desk, Rectangle Top

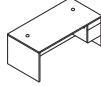

Single Full Pedestal Desk, Rectangle Top

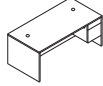

Single 3/4 Pedestal Desk, Rectangle Top

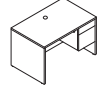

Small Office Desk

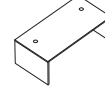

Desk Shell, Rectangle Top

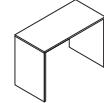

Desk Shell, Standing Height

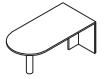

Peninsula w/End Panel

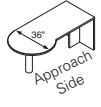

P-Shaped Peninsula w/End Panel

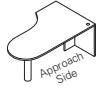

Jetty Peninsula w/End Panel



Boomerang Peninsula w/End Panel



Rudder Peninsula w/End Panel

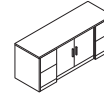

Credenza w/Doors, Full Pedestals

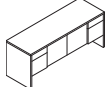

Credenza w/Doors, 3/4 Pedestals

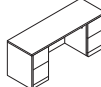

Credenza w/Kneespace, Full Pedestals

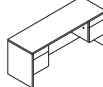

Credenza w/Kneespace, 3/4 Pedestals

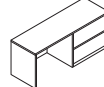

Credenza w/Lateral File

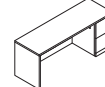

Single Full Pedestal Credenza

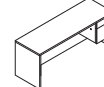

Single 3/4 Pedestal Credenza

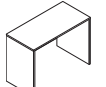

Credenza Shell w/Full or 60" Modesty Panel



Return w/Full Pedestal

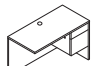

Return w/3/4 Pedestal

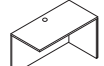

Return Shell w/Full or 60" Modesty Panel



Return Shell Standing Height

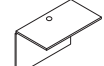

Bridge

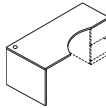

Extended Corner Unit

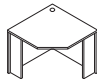

Corner Unit

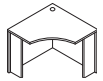

Curved Corner and Return Unit



Reception Desk and Return Shell

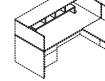

Reception Station for Desk and Return

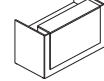

Reception Desk

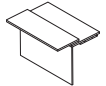

Reception Return with Transaction Counter

MODULAR AND MOBILE PEDESTALS



Box/Box/File Pedestal



File/File Pedestal

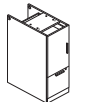

Box/Shelf/File Standing Height Pedestal

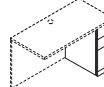

Narrow Box/Box/File Pedestal

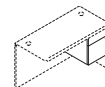

Box/File Pedestal

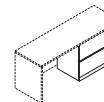

Lateral File Pedestal

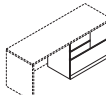

Multi-File Pedestal

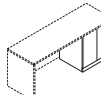

Cabinet Pedestal

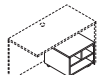

Mobile Printer/Fax Cart



Mobile Pedestal, Box/Box/File



Mobile Pedestal, File/File



Mobile Pedestal, Shelf/Box/File



Mobile Pedestal, Box/File

10500 Series™ Statement of Line

STORAGE

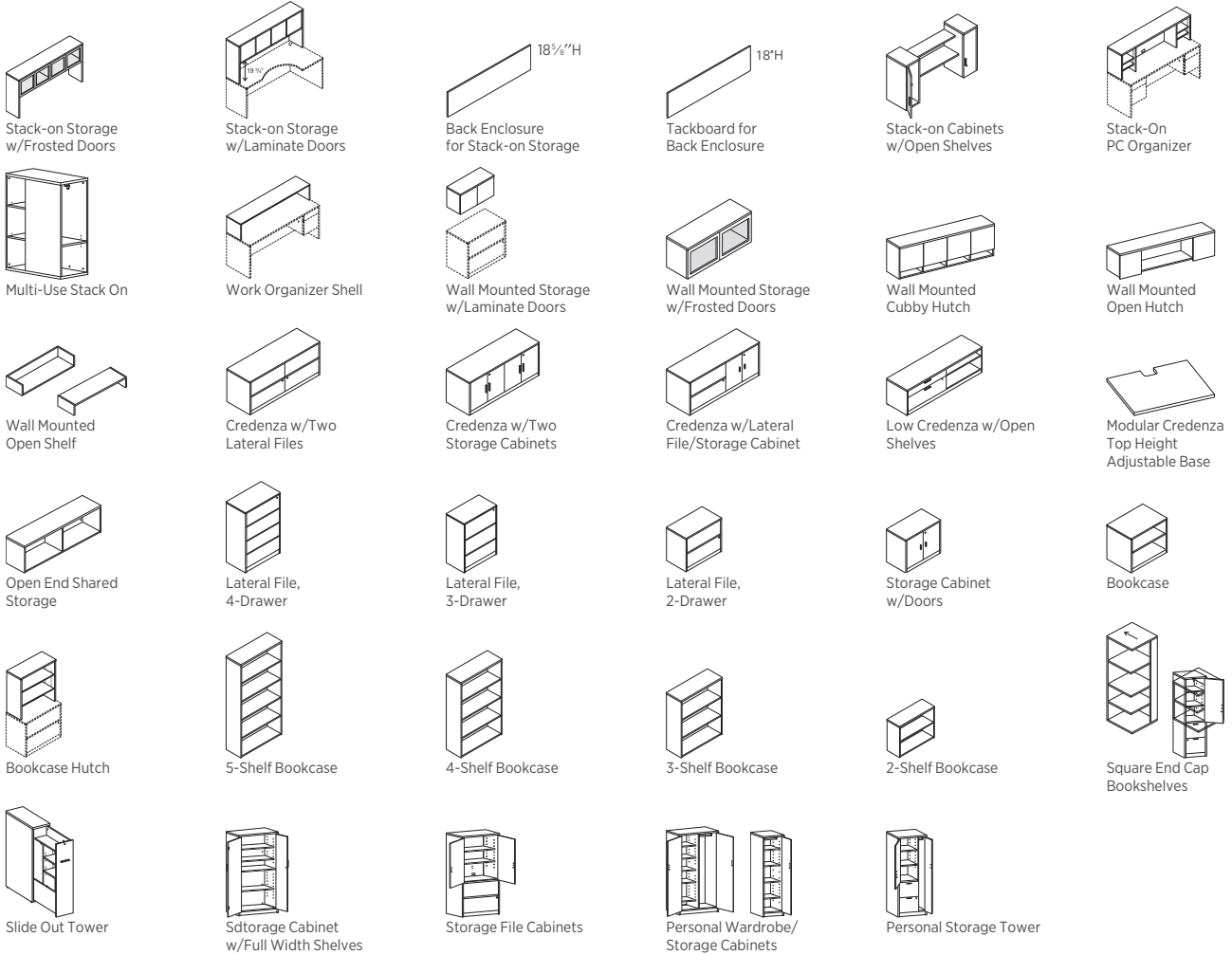

ADDITIONAL COMPONENTS

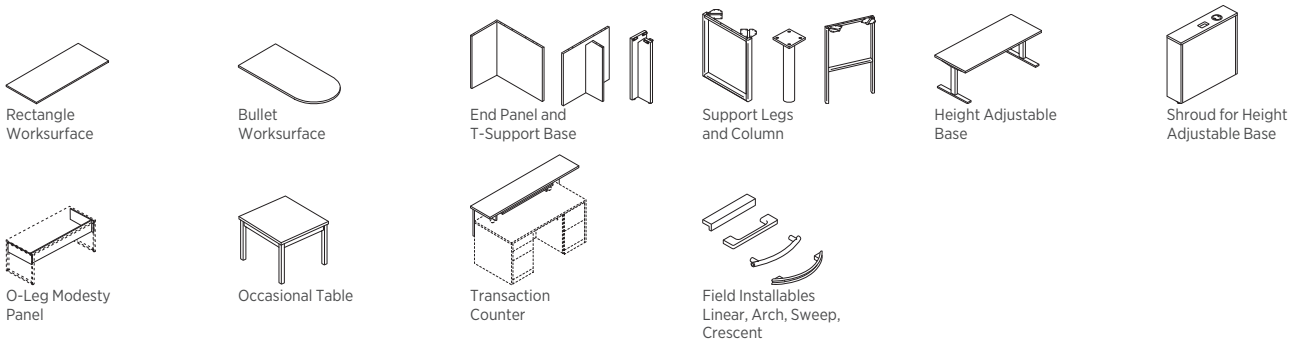

10500 SERIES™

Typicals



Icon Legend on page 19

Components used are listed on pages 256-302. Order components individually. Other configurations are possible, including various sizes of some components.

QTY	DESCRIPTION	MODEL	LIST PRICE	PRICE EXTENSION
1	Rectangle Worksurface 78"W x 30"D	H105R3078	\$530	\$530
1	O-Leg 30"D x 28½"H	HLSL30280	\$474	\$474
1	Low Credenza 72"W x 20"D x 21½"H, Drawers Right, Bookcase Left	H105975R	\$1,635	\$1,635
1	O-Leg Support over Low Credenza 30"D x 7"H	HLSL3070	\$366	\$366
1	Multi-Use Stack-On Storage 36"W x 18"D x 45½"H	H105310	\$1,307	\$1,307
TOTAL:			\$4,312	

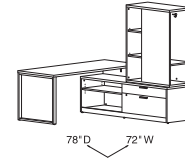

DESK L-WORKSTATION
72"W x 78"D

QTY	DESCRIPTION	MODEL	LIST PRICE	PRICE EXTENSION
1	Single Pedestal Desk, Left - B/F 66"W x 30"D x 29½"H	H10584L	\$1,283	\$1,283
1	Return, Right - B/F 42"W x 24"D x 29½"H	H10511R	\$1,012	\$1,012
1	Stack-on Storage 72"W x 14½"D x 37½"H	H10534	\$1,248	\$1,248
TOTAL:			\$3,543	

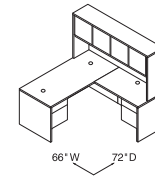

DESK "L" WORKSTATION - RIGHT
66"W x 72"D

QTY	DESCRIPTION	MODEL	LIST PRICE	PRICE EXTENSION
1	Double Full Pedestal Desk - 3/2 72"W x 36"D x 29½"H	H105890	\$2,101	\$2,101
1	Credenza with Kneespace - 2/0/2 72"W x 24"D x 29½"H	H105900	\$1,842	\$1,842
1	Stack-on Storage, Frosted Doors with Silver Frame 72"W x 14½"D x 37½"H	H10534G	\$2,048	\$2,048
TOTAL:			\$5,991	

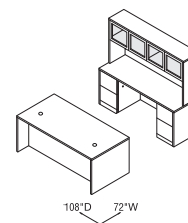

**DESK/CREDENZA/STACK-ON STORAGE
WITH FROSTED DOORS**
72"W x 108"D



Icon Legend on page 19

10500 SERIES™ Typicals

DESKS

Components used are listed on pages 256-302. Order components individually. Other configurations are possible, including various sizes of some components.

QTY	DESCRIPTION	MODEL	LIST PRICE	PRICE EXTENSION
1	Storage/File Cabinet 18"W x 24"D x 66 $\frac{5}{8}$ "H, Hinged Right	H105297R	\$2,087	\$2,087
1	Open Credenza 30"W x 24"D x 21 $\frac{1}{2}$ "H	H105LCHAT3024S	\$274	\$274
1	Open/Lateral Credenza 30"W x 24"D x 21 $\frac{1}{2}$ "H	H105LC3024SF	\$606	\$606
1	Modular Credenza Top 60"W x 24"D	H105CTHAT6024L	\$844	\$844
1	Wall Mounted Open Hutch, Cubby w/Glass Doors 60"W x 14 $\frac{5}{8}$ "D x 20"H	H105WMH60PCG	\$2,050	\$2,050
1	Height Adjustable Base	HHATB2S2LT	\$1,058	\$1,058
1	External Stiffener 60"W for 72" Worksurface	HLSLZ5SC66	\$141	\$141
1	Shroud for Height Adjustable Base 6 $\frac{1}{2}$ "W x 26"D x 23 $\frac{5}{8}$ "H	HNL30SHR	\$1,100	\$1,100
1	Rectangle Worksurface 66"W x 30"D	H105R3066	\$463	\$463
1	Acrylic Modesty Screen 36"W x 13"H	HUSAMOD1336	\$649	\$649
TOTAL:			\$9,272	

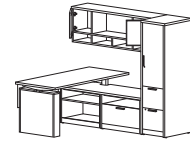

**HEIGHT ADJUSTABLE
"L" WORKSTATION
66"W x 78"D**

QTY	DESCRIPTION	MODEL	LIST PRICE	PRICE EXTENSION
1	H-Leg Support 30"W x 28 $\frac{3}{8}$ "H	H105HLEG3028	\$436	\$436
1	Rectangle Worksurface 66"W x 30"D	H105R3066	\$463	\$463
1	External Channel 54"W	HLSLZ5SC66	\$141	\$141
1	Flat Bracket 24"D	HHN831124	\$85	\$85
1	Return Shell w/Full Modesty Panel 72"W x 24"D x 29 $\frac{1}{2}$ "H	H105686	\$859	\$859
1	Multi File Pedestal, Floor-Standing 36"W x 20"D x 28"H	H10505	\$1,542	\$1,542
1	Personal Storage Tower, Hinged Right 24"W x 24"D x 66 $\frac{5}{8}$ "H	H105301R	\$2,639	\$2,639
1	Wall Mounted Open Hutch 72"W x 14 $\frac{5}{8}$ "D x 15"H	H105WMH72P	\$1,728	\$1,728
1	Laminate Modesty Screen 54"W x 13"H	HUSLMOD1354	\$753	\$753
TOTAL:			\$8,646	

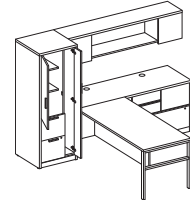

**EXTENDED STORAGE
"L" WORKSTATION
66"W x 96"D**

QTY	DESCRIPTION	MODEL	LIST PRICE	PRICE EXTENSION
1	Single Full Pedestal Desk, Right - B/B/F 72"W x 36"D x 29 $\frac{1}{2}$ "H	H105895R	\$1,680	\$1,680
1	Bridge 47"W x 24"D x 29 $\frac{1}{2}$ "H	H10570	\$451	\$451
1	Single Full Pedestal Credenza, Left - F/F 72"W x 24"D x 29 $\frac{1}{2}$ "H	H105904L	\$1,494	\$1,494
1	Stack-on Storage 72"W x 14 $\frac{5}{8}$ "D x 37 $\frac{1}{8}$ "H	H10534	\$1,248	\$1,248
TOTAL:			\$4,873	

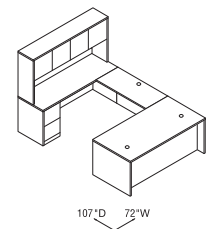

**"U" WORKSTATION
WITH FULL PEDESTALS
72"W x 107"D**

10500 SERIES™

Typicals



Icon Legend on page 19

Components used are listed on pages 256-302. Order components individually. Other configurations are possible, including various sizes of some components.

QTY	DESCRIPTION	MODEL	LIST PRICE	PRICE EXTENSION
1	Rudder Peninsula with End Panel, Right 72"W x 30/38"D x 29½"H	H105205RE	\$1,392	\$1,392
1	Return, Left - F/F 42"W x 24"D x 29½"H	H105908L	\$1,161	\$1,161
1	Stack-on Storage 72"W x 14⅝"D x 37⅞"H	H10534	\$1,248	\$1,248
TOTAL:			\$3,801	

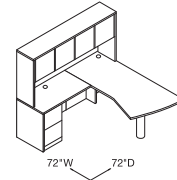

PENINSULA "L" WORKSTATION

72" W x 72" D

QTY	DESCRIPTION	MODEL	LIST PRICE	PRICE EXTENSION
1	Peninsula with End Panel 72"W x 36"D x 29½"H	H10521E	\$1,101	\$1,101
1	Bridge 42"W x 24"D x 29½"H	H10560	\$433	\$433
1	Extended Corner Unit, Left 72"W x 24"-36"D x 29½"H	H105816L	\$1,327	\$1,327
1	Mobile Pedestal - B/B/F 15¾"W x 22¾"D x 28"H	H105102	\$1,055	\$1,055
1	Stack-on Storage 72"W x 14⅝"D x 37⅞"H	H10534	\$1,248	\$1,248
1	Storage Cabinet/Lateral File 36"W x 24"D x 66⅝"H	H105293	\$2,809	\$2,809
TOTAL:			\$7,973	

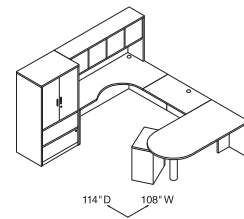

PENINSULA "U" WORKSTATION - LEFT

108" W x 114" D

QTY	DESCRIPTION	MODEL	LIST PRICE	PRICE EXTENSION
1	Slide Out Tower, Left Hinged 12"W x 24"D x 50"H	H105ST122450L	\$3,337	\$3,337
1	Open Credenza 30"W x 24"D x 21½"H	H105LCHAT3024S	\$274	\$274
1	Open/Lateral Credenza 30"W x 24"D x 21½"H	H105LC3024SF	\$606	\$606
1	Modular Credenza Top 60"W x 24"D	H105CTHAT6024R	\$844	\$844
1	Height Adjustable Base	HHATB2S2LT	\$1,058	\$1,058
1	External Stiffener	HLSLZ5SC66	\$141	\$141
1	Shroud for Height Adjustable Base 60"W for 72" Worksurface	HNL30SHR	\$1,100	\$1,100
1	Rectangle Worksurface 66"W x 30"D	H105R3066	\$463	\$463
1	Laminate Modesty Screen 30"W x 13"H	HUSLMOD1330	\$606	\$606
1	2-Drawer Credenza 30"W x 24"D x 21½"H	H105LC3024BF	\$688	\$688
1	Modular Credenza Top 30"W x 24"D	H105CT3024	\$490	\$490
1	Fabric Credenza Top 30"W x 24"D	HLAMSEAT3024	\$501	\$501
TOTAL:			\$10,108	

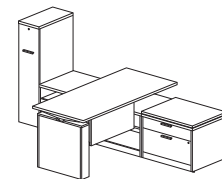

HEIGHT ADJUSTABLE "L" WORKSTATION WITH SLIDE OUT STORAGE

66" W x 102" D



Icon Legend on page 19

10500 SERIES™ Bundles Typicals

Mahogany
H105LL7284N

Harvest
H105LL7284C

QTY	DESCRIPTION	MODEL	LIST PRICE	PRICE EXTENSION
1	Left Pedestal Desk	H10586L	\$1,459	\$1,459
1	Right Return	H10515R	\$1,034	\$1,034
TOTAL:			\$2,493	

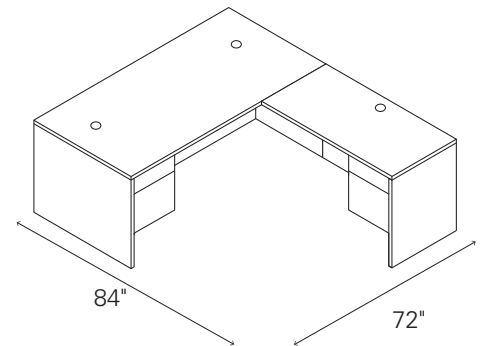

L-STATION (LEFT DESK/RIGHT RETURN)

Mahogany
H105LR7284N

Harvest
H105LR7284C

QTY	DESCRIPTION	MODEL	LIST PRICE	PRICE EXTENSION
1	Right Pedestal Desk	H10585R	\$1,459	\$1,459
1	Left Return	H10516L	\$1,034	\$1,034
TOTAL:			\$2,493	

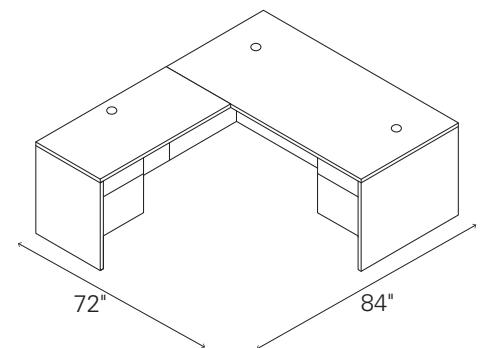

L-STATION (RIGHT DESK/LEFT RETURN)

Mahogany
H105LLH7284N

Harvest
H105LLH7284C

QTY	DESCRIPTION	MODEL	LIST PRICE	PRICE EXTENSION
1	Left Pedestal Desk	H10586L	\$1,459	\$1,459
1	Right Return	H10515R	\$1,034	\$1,034
1	Stack-on Storage	H105323	\$1,050	\$1,050
TOTAL:			\$3,543	

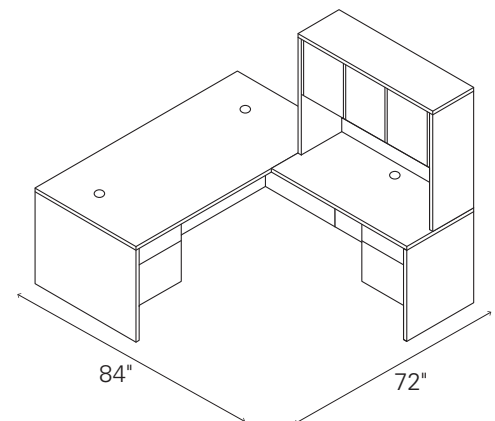

**L-STATION WITH STACK-ON STORAGE
(LEFT DESK/RIGHT RETURN)**

10500 SERIES™ Bundles Typicals



Icon Legend on page 19

Mahogany
H105LRH7284N

Harvest
H105LRH7284C

QTY	DESCRIPTION	MODEL	LIST PRICE	PRICE EXTENSION
1	Right Pedestal Desk	H10585R	\$1,459	\$1,459
1	Left Return	H10516L	\$1,034	\$1,034
1	Stack-on Storage	H105323	\$1,050	\$1,050
TOTAL:			\$3,543	

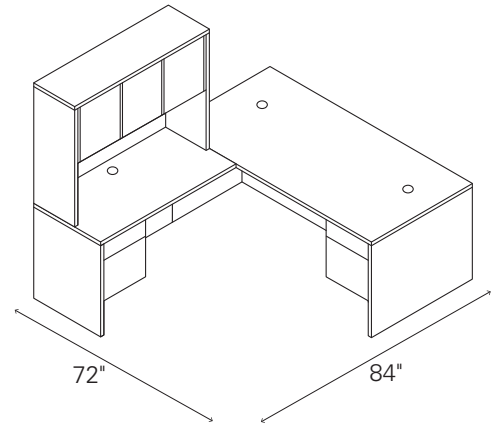

**L-STATION WITH STACK-ON STORAGE
(RIGHT DESK/LEFT RETURN)**

Mahogany
H105ULH72108N

Harvest
H105ULH72108C

QTY	DESCRIPTION	MODEL	LIST PRICE	PRICE EXTENSION
1	Left Pedestal Desk	H10586L	\$1,459	\$1,459
1	Right Pedestal Credenza	H10545R	\$1,264	\$1,264
1	Bridge	H10570	\$451	\$451
1	Stack-on Storage	H10534	\$1,248	\$1,248
TOTAL:			\$4,422	

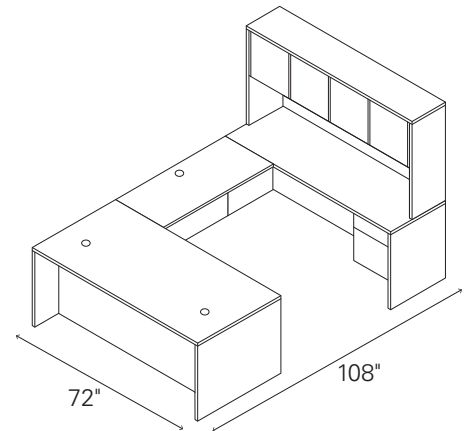

**U-STATION WITH STACK-ON STORAGE
(LEFT DESK/RIGHT CREDENZA)**

Mahogany
H105URH72108N

Harvest
H105URH72108C

QTY	DESCRIPTION	MODEL	LIST PRICE	PRICE EXTENSION
1	Right Pedestal Desk	H10585R	\$1,459	\$1,459
1	Left Pedestal Credenza	H10546L	\$1,264	\$1,264
1	Bridge	H10570	\$451	\$451
1	Stack-on Storage	H10534	\$1,248	\$1,248
TOTAL:			\$4,422	

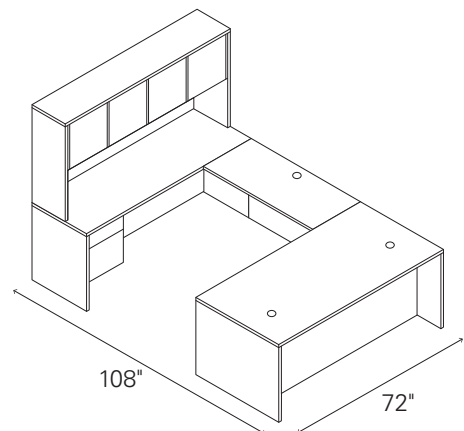

**U-STATION WITH STACK-ON STORAGE
(RIGHT DESK/LEFT CREDENZA)**



Icon Legend on page 19

10500 SERIES™ Bundles Typicals

DESKS

Mahogany
H105DLH7298N

Harvest
H105DLH7298C

QTY	DESCRIPTION	MODEL	LIST PRICE	PRICE EXTENSION
1	Double Pedestal Desk	H10593	\$1,716	\$1,716
2	Bookcase Hutch	H105292	\$706	\$1,412
1	2-Drawer Lateral File	H10563	\$1,202	\$1,202
1	Storage Cabinet with Doors	H105291	\$964	\$964
TOTAL:			\$5,294	

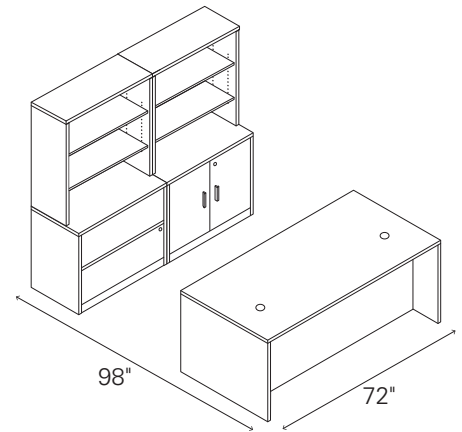

STORAGE WORKSTATION

Mahogany
H105DCH6098N

Harvest
H105DCH6098C

QTY	DESCRIPTION	MODEL	LIST PRICE	PRICE EXTENSION
1	Double Pedestal Desk	H10573	\$1,447	\$1,447
1	Double Pedestal Credenza	H10565	\$1,447	\$1,447
1	Stack-on Storage	H105324	\$1,164	\$1,164
TOTAL:			\$4,058	

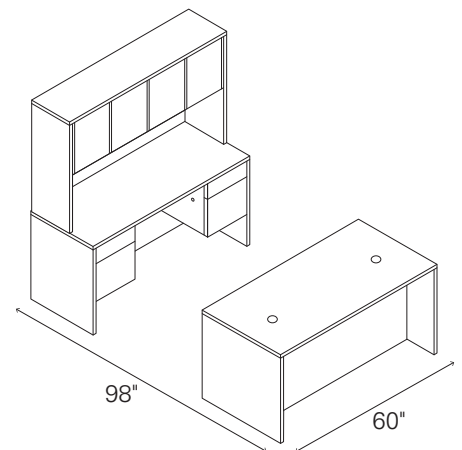

DESK CREDENZA STACK-ON #1

Mahogany
H105DCH7298N

Harvest
H105DCH7298C

QTY	DESCRIPTION	MODEL	LIST PRICE	PRICE EXTENSION
1	Double Pedestal Desk	H10593	\$1,716	\$1,716
1	Double Pedestal Credenza	H10543	\$1,531	\$1,531
1	Stack-on Storage	H10534	\$1,248	\$1,248
TOTAL:			\$4,495	

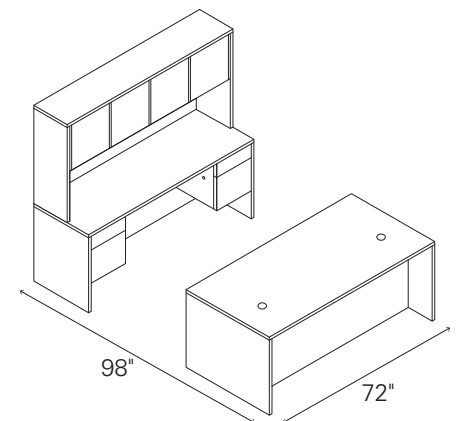

DESK CREDENZA STACK-ON #2

10500 SERIES™ Laminate Modular Components

GSA SIN 33721



Icon Legend on page 19

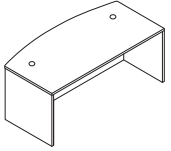

Model H10596 shown

DESCRIPTION	INSIDE DIMENSIONS	FULL WIDTH OVERHANG	MODEL	SHIP WEIGHT	CUBE	LIST PRICE BY LAMINATE GRADE	
						L1	L2
Desk Shell (with full modesty panel and 2 grommets)							
72"W x 36"D x 29½"H, Bow Top (end panels 30"D)	69½"W x 24⅝"D	10½"	H10596	192	6.9	\$1104	\$1157
72"W x 36"D x 29½"H, Rectangle Top	69½"W x 24⅝"D	10½"	H10594	209	6.9	\$997	\$1050
72"W x 30"D x 29½"H, Rectangle Top	69½"W x 24⅝"D	4½"	H10592	182	5.8	\$944	\$986
66"W x 30"D x 29½"H, Rectangle Top	63½"W x 24⅝"D	4½"	H10579	172	5.4	\$895	\$937
60"W x 30"D x 29½"H, Rectangle Top	57½"W x 24⅝"D	4½"	H10578	161	5.0	\$833	\$875
48"W x 30"D x 29½"H, Rectangle Top (1 grommet)	45½"W x 24⅝"D	4½"	H10598	141	5.0	\$774	\$806
NOTES: See pages 709-710 for optional center drawers.							
Desk Shell (with 10"H modesty panel and 2 grommets)							
72"W x 36"D x 29½"H, Bow Top (end panels 30"D)	69½"W x 24⅝"D	10½"	H10596X	155	6.1	\$1104	\$1157
72"W x 36"D x 29½"H, Rectangle Top	69½"W x 24⅝"D	10½"	H10594X	153	6.1	\$997	\$1050
72"W x 30"D x 29½"H, Rectangle Top	69½"W x 24⅝"D	4½"	H10592X	143	5.1	\$944	\$986
66"W x 30"D x 29½"H, Rectangle Top	63½"W x 24⅝"D	4½"	H10579X	134	4.7	\$895	\$937
60"W x 30"D x 29½"H, Rectangle Top	57½"W x 24⅝"D	4½"	H10578X	125	4.4	\$833	\$875
48"W x 30"D x 29½"H, Rectangle Top (1 grommet)	45½"W x 24⅝"D	4½"	H10598X	115	4.4	\$774	\$806
NOTES: Makes reaching wall electrical outlets quick and easy. Provides more than 18" of clearance. See pages 284-285 for optional stack-on storage and pages 709-710 for optional center drawers.							

NOTES:

- Non-handed desk, credenza, and return shells, combined with a variety of under-the-worksurface storage solutions, maximize office layout flexibility. Products can be reconfigured quickly and easily when user preferences or space needs change.
- For under-surface storage options, see pages 271-273.
- For additional components see pages 280-302.
- Tops and end panels are abrasion- and stain-resistant laminate over durable 1⅝" solid core high-performance particleboard; resists warping.
- Cord management grommets, for routing and hiding wires and cables, are located in the tops of desks and return shells.
- 3" round worksurface grommet can be replaced with optional Power Hub (model HGRMTAC) or Power/USB Hub (model HGRMTUSB2) to bring the ease of plug-and-play to the desktop. See page 723.
- Adjustable hex leveling glides allow floor-standing furniture to be easily leveled without lifting the unit; glides have ¾" adjustable range.
- For standing, 42"H shells, see page 259.

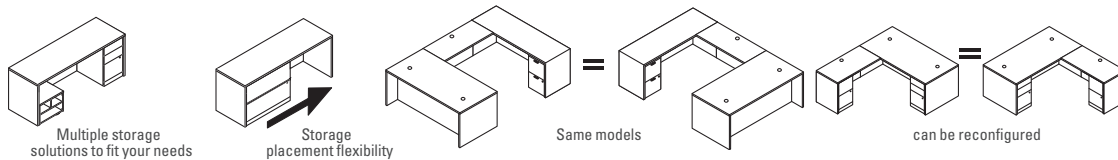

HOW TO SPECIFY

<p>Select Model Number</p> <p>H 1 0 5 9 6 .</p>	<p>Select Laminate Top and Chassis Color</p> <p>See pages 247-248</p> <p>N N</p>
--	---



10500 SERIES™

Laminate Modular Components

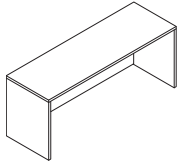

DESCRIPTION	INSIDE DIMENSIONS	MODEL	SHIP WEIGHT	CUBE	LIST PRICE BY LAMINATE GRADE	
					L1	L2
Credenza Shell (with full modesty panel)						
72"W x 24"D x 29½"H	69½"W x 22¾"D	H10541	153	5.6	\$859	\$901
66"W x 24"D x 29½"H	63½"W x 22¾"D	H10542	144	5.1	\$841	\$883
60"W x 24"D x 29½"H	57½"W x 22¾"D	H10564	135	4.7	\$787	\$824
48"W x 24"D x 29½"H	45½"W x 22¾"D	H105692	124	3.9	\$755	\$787
42¼"W x 24"D x 29½"H	39¾"W x 22¾"D	H105691	110	3.8	\$730	\$762
72"W x 20"D x 29½"H	69½"W x 18¾"D	H105581	138	5.6	\$812	\$849
66"W x 20"D x 29½"H	63½"W x 18¾"D	H105582	130	5.1	\$793	\$830
60"W x 20"D x 29½"H	57½"W x 18¾"D	H105583	122	4.7	\$751	\$783

NOTES: Cord pass-through in top center of modesty panel. See pages 284-285 for optional stack-on storage.

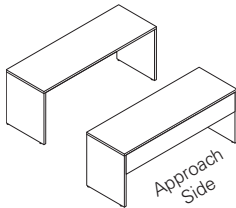

DESCRIPTION	INSIDE DIMENSIONS	MODEL	SHIP WEIGHT	CUBE	LIST PRICE BY LAMINATE GRADE	
					L1	L2
Credenza Shell (with 10" H modesty panel)						
72"W x 24"D x 29½"H	69½"W x 22¾"D	H10541X	114	4.8	\$859	\$901
66"W x 24"D x 29½"H	63½"W x 22¾"D	H10542X	107	4.4	\$841	\$883
60"W x 24"D x 29½"H	57½"W x 22¾"D	H10564X	105	4.0	\$787	\$824
48"W x 24"D x 29½"H	45½"W x 22¾"D	H105692X	95	3.8	\$755	\$787
42¼"W x 24"D x 29½"H	39¾"W x 22¾"D	H105691X	87	3.8	\$730	\$762
72"W x 20"D x 29½"H	69½"W x 18¾"D	H105581X	107	4.8	\$812	\$849
66"W x 20"D x 29½"H	63½"W x 18¾"D	H105582X	101	4.4	\$793	\$830
60"W x 20"D x 29½"H	57½"W x 18¾"D	H105583X	96	4.0	\$751	\$783

NOTES: Makes reaching wall electrical outlets quick and easy. Provides more than 18" of clearance. See pages 284-285 for optional stack-on storage.



Not available in two-tone laminate

DESCRIPTION	MODEL	SHIP WEIGHT	CUBE	L1	L2
				LIST PRICE	LIST PRICE
Kneespace Clearance End Panel Kits (field installable)					
1½"W x 11¼"D x 28½"H	H105098	13	0.9	\$261	\$272
For use at either end of 10500, 10700 or Valido Series® 24"D Credenza Shells (with full or 10" modesty panel) or non-pedestal end of single pedestal credenzas or credenzas with lateral files.					
1½"W x 17¼"D x 28½"H	H105099	11	0.8	\$274	\$285
For use at either end of 10500 or Valido Series® 30"D Desk Shells or non-pedestal end of 30"D single pedestal desks.					
Kits include: (1) support panel; European fastening hardware; flat connector bracket; joint connector bolts with sleeve nuts (for ganging credenza to adjacent worksurface); and adjustable leveling glides. Allows conversion of units currently in the field.					
NOTES: Can be used to connect up to three 24"D credenzas or 30"D desks in line (requires 4 kits).					
⚠ Not designed to be used freestanding. Not designed to be used with returns, 36"D desks or desk shells.					
SPECIFYING EXAMPLE: H105098.N					

NOTES:

- Non-handed desk, credenza, and return shells, combined with a variety of under-the-worksurface storage solutions, maximize office layout flexibility. Products can be reconfigured quickly and easily when user preferences or space needs change.
- For 78", 84", 90", and 96"W credenza shells, see page 258.
- For under-surface storage options, see pages 271-273.
- Tops and end panels are abrasion- and stain-resistant laminate over durable 1/8" solid core high-performance particleboard; resists warping.
- For additional components see pages 280-302.
- For work-in-process paper management tools, see pages 715-717.
- Cord management grommets, for routing and hiding wires and cables, are located in the tops of desks and return shells.
- Credenza shells have a cord pass-through grommet in the top center of the modesty panel.
- Kneespace Clearance End Panel Kit model H105098, can be used to create "L" configurations with leg clearance, by connecting credenzas to single pedestal desks or credenzas, desk or credenza shells, corners, extended corners or peninsulas.
- Adjustable hex leveling glides allow floor-standing furniture to be easily leveled without lifting the unit; glides have 3/4" adjustable range.

HOW TO SPECIFY

Select Model Number H 1 0 5 4 1 .	Select Laminate Top and Chassis Color See pages 247-248 N N
---	--

10500 SERIES™

Laminate Modular Components

GSA SIN 33721



Icon Legend on page 19

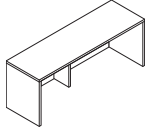

DESCRIPTION	INSIDE DIMENSIONS	MODEL	SHIP WEIGHT	CUBE	LIST PRICE BY LAMINATE GRADE	
					L1	L2
Credenza Shell (with full modesty panel)						
96"W x 24"D x 29½"H	93½"W x 22¾"D	H105413	215	7.0	\$1224	\$1282
90"W x 24"D x 29½"H	87½"W x 22¾"D	H105412	202	6.6	\$1191	\$1244
84"W x 24"D x 29½"H	81½"W x 22¾"D	H105411	189	6.2	\$1056	\$1109
78"W x 24"D x 29½"H	75½"W x 22¾"D	H105410	176	5.8	\$1028	\$1076

NOTES: Larger sizes can be used in conjunction with a 10500 Series rectangle- or bullet-shaped worksurface, supported by an end panel, column or leg, to achieve a space efficient work wall configuration. Shells wider than 72" include an internal, 10½"D vertical support leg. The internal leg can be removed if it is replaced with a 10500 Series 28"H modular pedestal that is adjusted to support the credenza shell top. Cord pass-through in top center of modesty panel. See pages 284-285 for optional stack-on storage and the stack-on storage end panel kit (model H105349).

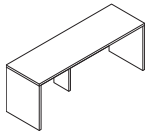

Credenza Shell (with 10"H modesty panel)						
96"W x 24"D x 29½"H	93½"W x 22¾"D	H105413X	163	6.1	\$1224	\$1282
90"W x 24"D x 29½"H	87½"W x 22¾"D	H105412X	152	5.7	\$1191	\$1244
84"W x 24"D x 29½"H	81½"W x 22¾"D	H105411X	141	5.4	\$1056	\$1109
78"W x 24"D x 29½"H	75½"W x 22¾"D	H105410X	130	5.0	\$1028	\$1076

NOTES: Makes reaching wall electrical outlets quick and easy. Provides more than 18" of clearance. Larger sizes can be used in conjunction with a 10500 Series rectangle- or bullet-shaped worksurface, supported by an end panel, column or leg, to achieve a space efficient work wall configuration. Shells wider than 72" include an internal, 10½"D vertical support leg. The internal leg can be removed if it is replaced with a 10500 Series 28"H modular pedestal that is adjusted to support the credenza shell top. See pages 284-285 for optional stack-on storage and the stack-on storage end panel kit (model H105349).

NOTES:

- Non-handed desk, credenza, and return shells, combined with a variety of under-the-worksurface storage solutions, maximize office layout flexibility. Products can be reconfigured quickly and easily when user preferences or space needs change.
- For under-surface storage options, see pages 271-273.
- For additional components see pages 280-302.
- Tops and end panels are abrasion- and stain-resistant laminate over durable 1½" solid core high-performance particleboard; resists warping.
- Credenza shells have a cord pass-through grommet in the top center of the modesty panel.
- Kneespace Clearance End Panel Kit model H105098, can be used to create "L" configurations with leg clearance, by connecting credenzas to single pedestal desks or credenzas, desk or credenza shells, corners, extended corners or peninsulas.
- Adjustable hex leveling glides allow floor-standing furniture to be easily leveled without lifting the unit; glides have ¾" adjustable range.

HOW TO SPECIFY

Select
Model Number

H 1 0 5 4 1 3 .

Select
Laminate Top and Chassis Color

See pages 247-248

N N

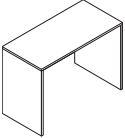
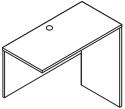

10500 SERIES™ Laminate Modular Components

	DESCRIPTION	INSIDE DIMENSIONS	MODEL	SHIP WEIGHT	CUBE	LIST PRICE BY LAMINATE GRADE	
						L1	L2
	Standing-Height Desk Shell						
	60"W x 30"D x 42"H	57½"W x 24½"D x 41⅝"H	H105397	185	6.2	\$1034	\$1076
	60"W x 24"D x 42"H	57½"W x 22¾"D x 41⅝"H	H105393	154	5.1	\$955	\$997
	48"W x 24"D x 42"H	45⅞"W x 22¾"D x 41⅝"H	H105392	143	4.2	\$892	\$929
	NOTES: Fixed height surface is 42"H. When combined with a stool-height task chair, provides users the benefit of alternating their work between a seated or standing position without the additional cost of an adjustable-height mechanism. Short, 22⅝" modesty panel provides over 18" of wall access; makes reaching wall electrical outlets quick and easy. Box/File Pedestal (H10501) attaches to the underside of the worksurface top to position supplies and files within easy reach.						
	Standing-Height Return Shell						
	48"W x 24"D x 42"H	47"W x 22¾"D x 41⅝"H	H105663	96	3.1	\$749	\$786
	NOTES: Non-handed design. Attaches to sit/stand desk shells to form an L-shaped workstation. Short, 22⅝" modesty panel makes reaching wall electrical outlets quick and easy. One cord management grommet in top for routing and hiding wires and cables. Grommet can be replaced with optional Power Hub (model HGRMTAC). Box/File Pedestal (H10501) attaches to the underside of the worksurface top to position supplies and files within easy reach.						

NOTES:

- 42"H shells help support a healthy work style by allowing users to switch between sitting and standing.
- Non-handed desk and return shells maximize office layout flexibility. Products can be reconfigured quickly and easily when user preferences or space needs change.
- Tops and end panels are abrasion- and stain-resistant laminate over durable 1⅝" solid core high-performance particleboard; resists warping.
- For additional components see pages 280-302.
- Mobile pedestals, shown on page 293, work well in a variety of applications and configurations.
- Adjustable hex leveling glides allow floor-standing furniture to be easily leveled without lifting the unit; glides have ¾" adjustable range.

HOW TO SPECIFY

Select Model Number

H 1 0 5 3 9 7 .

Select Laminate Top and Chassis Color

See pages 247-248

N N

10500 SERIES™

Laminate Modular Components

GSA SIN 33721



Icon Legend on page 19

Model H105686
shown

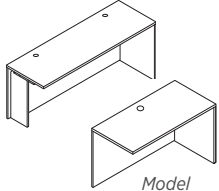

Model
H105686
shown

DESCRIPTION	INSIDE DIMENSIONS	MODEL	SHIP WEIGHT	CUBE	LIST PRICE BY LAMINATE GRADE	
					L1	L2
Return Shell (with full modesty panel)						
72"W x 24"D x 29½"H, (w/support; 2 grommets)	67"W x 22¾"D	H105686	145	5.4	\$859	\$901
60"W x 24"D x 29½"H, (w/support; 2 grommets)	55"W x 22¾"D	H105684	129	4.4	\$787	\$824
48"W x 24"D x 29½"H, (1 grommet)	47"W x 22¾"D	H10561	86	3.7	\$648	\$680
42"W x 24"D x 29½"H, (1 grommet)	41"W x 22¾"D	H105681	89	2.5	\$609	\$641
36"W x 24"D x 29½"H, (1 grommet)	34⅞"W x 22¾"D	H105680	83	3.2	\$609	\$636
30"W x 24"D x 29½"H, (1 grommet)	28⅞"W x 22¾"D	H10568	69	2.6	\$582	\$609

NOTES: Shells are non-handed. No pre-drilled grommet in modesty panel (field installable grommet included). Woodgrain direction on modesty/back panel runs vertical on 30"W-60"W sizes and horizontal on 72"W unit. 36"W return shell can be used to achieve a 6' x 6' L-shaped footprint when connected to either a 72"W x 36"D single pedestal desk, desk shell, or peninsula, or when two are connected to 36"W corner unit model H105811. 30"W return shell can be used to accomplish a 5' x 5' L-shaped footprint when connected to a 60"W x 30"D desk shell or peninsula. See pages 284-285 for optional stack-on storage.

ⓘ Not designed to attach to corner units manufactured prior to 5/24/99.

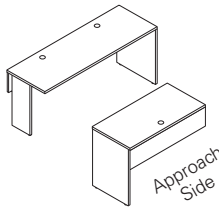

Return Shell (with 10"H modesty panel)						
72"W x 24"D x 29½"H, (w/support; 2 grommets)	67"W x 22¾"D	H105686X	106	4.6	\$859	\$901
60"W x 24"D x 29½"H, (w/support; 2 grommets)	55"W x 22¾"D	H105684X	93	3.9	\$787	\$824
48"W x 24"D x 29½"H, (1 grommet)	47"W x 22¾"D	H10561X	78	3.1	\$648	\$680
42"W x 24"D x 29½"H, (1 grommet)	41"W x 22¾"D	H105681X	69	3.8	\$609	\$641
36"W x 24"D x 29½"H, (1 grommet)	34⅞"W x 22¾"D	H105680X	67	3.8	\$609	\$636
30"W x 24"D x 29½"H, (1 grommet)	28⅞"W x 22¾"D	H10568X	56	2.6	\$582	\$609

NOTES: Makes reaching wall electrical outlets quick and easy. Provides more than 18" of clearance. See pages 284-285 for optional stack-on storage.

NOTES:

- Non-handed desk, credenza, and return shells, combined with a variety of under-the-worksurface storage solutions, maximize office layout flexibility. Products can be reconfigured quickly and easily when user preferences or space needs change.
- For additional components see pages 280-302.
- Tops and end panels are abrasion- and stain-resistant laminate over durable 1½" solid core high-performance particleboard; resists warping.
- Cord management grommets, for routing and hiding wires and cables, are located in the tops of desks and return shells.
- Adjustable hex leveling glides allow floor-standing furniture to be easily leveled without lifting the unit; glides have ¾" adjustable range.
- 36"W and 30"W return shells enable L-shaped layouts for smaller spaces.
- One cord management grommet in tops of Return Shell models, H10568 and H10568X, is used for routing and hiding wires and cables. The 3" round grommet can be replaced with optional Power Hub or Power/USB Hub — see page 723.

HOW TO SPECIFY

Select
Model Number

H 1 0 5 6 8 6 .

Select
Laminate Top and Chassis Color

See pages 247-248

N N



10500 SERIES™ Worksurfaces

	DESCRIPTION	MODEL	SHIP WEIGHT	CUBE	LIST PRICE BY LAMINATE GRADE	
					L1	L2
	Rectangle Worksurface					
	84"W x 30"D	H105R3084	88	6.5	\$588	\$615
	78"W x 30"D	H105R3078	81	6.1	\$530	\$557
	72"W x 30"D	H105R3072	83	6.1	\$498	\$519
	66"W x 30"D	H105R3066	76	6.1	\$463	\$484
	60"W x 30"D	H105R3060	69	5.2	\$432	\$453
	48"W x 30"D	H105R3048	55	4.1	\$355	\$371
	84"W x 24"D	H105R2484	70	5.3	\$542	\$569
	78"W x 24"D	H105R2478	65	4.9	\$481	\$502
	72"W x 24"D	H105R2472	66	4.9	\$424	\$445
66"W x 24"D	H105R2466	61	4.9	\$409	\$430	
60"W x 24"D	H105R2460	55	4.2	\$385	\$406	
48"W x 24"D	H105R2448	44	3.4	\$328	\$344	
42"W x 24"D	H105R2442	39	3.0	\$297	\$313	
36"W x 24"D	H105R2436	30	2.4	\$258	\$274	
30"W x 24"D	H105R2430	25	2.0	\$258	\$274	
NOTES: Underside of rectangle worksurfaces includes pilot mounting holes for end panels, support columns, post legs, H-legs, and O-legs, and height adjustable base. Applications for 24"D worksurfaces include desks, credenzas, returns, and bridges.						
	Bullet Worksurface					
	72"W x 30"D	H105B3072	79	6.1	\$517	\$538
	66"W x 30"D	H105B3066	73	6.1	\$489	\$510
	60"W x 30"D	H105B3060	66	5.2	\$466	\$487
60"W x 24"D	H105B2460	45	4.2	\$400	\$416	
NOTES: Applications include use as a peninsula in a U- or L-shaped workstation or as an island extension. One flat bracket (mounting plate) ships with each worksurface for applications requiring connection to an adjoining worksurface. Underside includes pilot mounting holes for T- and L-shaped end panels, H-leg, O-leg, support column, post leg, or flat bracket. Grain direction runs horizontal.						
! When specifying 60"W Floating Modesty Panel, it is not necessary to specify an external channel.						

	DESCRIPTION	MODEL	SHIP WEIGHT	CUBE	LIST PRICE
	External Support Channel				
	42"W for a 54" Worksurface	HLSLZ5SC54	5	0.5	\$129
	48"W for a 60" Worksurface	HLSLZ5SC60	6	0.5	\$135
	54"W for a 66" Worksurface	HLSLZ5SC66	7	0.5	\$141
	60"W for a 72" Worksurface	HLSLZ5SC72	7	0.5	\$152
72"W for an 84" Worksurface	HLSLZ5SC84	12	0.7	\$152	
! Available in Graphite paint only.					
! When specifying panel-hung worksurfaces, specify external channel as if supported by two H-legs or O-legs via selection chart.					
! When specifying a 54"W or 60"W Floating Modesty Panel, it is not necessary to specify an external channel.					

NOTES:

- Easy-care, scratch-, spill- and stain-resistant laminate over 1/8" solid core high-performance particleboard.
- Grain direction on all worksurfaces runs horizontal.
- One flat bracket (mounting plate) ships with each worksurface for applications requiring connection to an adjoining worksurface.
- For standing-height requirements, use worksurface with 41"H laminate L-shaped end panel or metal O-leg.
- For 30", 36", 42" and 48"W x 24"D mobile desks and tables, use post leg with casters model HMBPOST.C.
- For end panels, legs, columns and bases, see the Worksurface Supports listing on pages 262-263.
- When using a floating modesty panel or an external channel under the worksurface, the depth clearance for keyboard trays and center drawers decreases by 8". See accessory matrix in accessory section of the pricer.

EXTERNAL SUPPORT CHANNEL (Model HLSLZ5SCxx) — RECOMMENDED USE							
	Support Combination		Rectangle Worksurface Width				
	Support 1	Support 2	60"	66"	72"	78"	84"
O-Leg	O-Leg	O-Leg	66	72	78	84	NA
	O-Leg	4 1/2" Dia. Support Column	NR	60	66	72	78
	O-Leg	2" Square Post Leg	NR	60	66	72	78
L-Shaped End Panel	L End Panel	L End Panel	NR	60	66	72	78
	L End Panel	O-Leg	60	66	72	78	84
	L End Panel	4 1/2" Dia. Support Column	NR	60	66	72	78
	L End Panel	2" Square Post Leg	NR	60	66	72	78
T-Shaped End Panel	T End Panel	O-Leg	60	66	72	78	84
	T End Panel	4 1/2" Dia. Support Column	NR	60	66	72	78
	T End Panel	2" Square Post Leg	NR	60	66	72	78
Return Config	None	O-Leg	66	72	78	84	NA
	None	L End Panel	60	66	72	78	84

- ! 84"W worksurfaces are for 29 1/2"H applications only (not 42"H) and require a T-support brace or other weight-bearing floor support to be positioned between the O-legs or L-shaped end panels.
- ! Worksurfaces are subject to slight bowing. The magnitude of the deflection is dependent upon the weight, placement, and duration of the load.
- ! When using a worksurface as a bridge, no additional supports are needed. One support is required for returns, two supports are required for desks and credenzas.
- ! External channel support is recommended for extended unsupported spans or heavily loaded worksurfaces. See above for details.

HOW TO SPECIFY

Select Model Number	Select Worksurface Laminate and Edge Color
See pages 247-248	
H 1 0 5 R 3 0 7 2	N N

10500 SERIES™ Worksurface Supports

GSA SIN 33721



Icon Legend on page 19

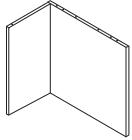

Not available in two-tone laminate

DESCRIPTION	MODEL	SHIP WEIGHT	CUBE	LIST PRICE BY LAMINATE GRADE	
				L1	L2
L-shaped End Panel					
15¾"W x 29⅞"D x 28½"H	H10530LEP	49	4.1	\$357	\$370
15¾"W x 23⅞"D x 28½"H	H10524LEP	43	3.7	\$335	\$348
15¾"W x 29⅞"D x 41"H	H1053041LEP	68	4.2	\$451	\$472
15¾"W x 23⅞"D x 41"H	H1052441LEP	60	3.4	\$407	\$428

NOTES: Non-handed. 29⅞"D for use with 48"-78"W x 30"D worksurfaces; 23⅞"D for use with 30"-78"W x 24"D worksurfaces. Not for use with 84"W unless additional floor supports are placed between the end panels. Design facilitates easy, open access to wall electrical outlets. Adjustable hex glides allow floor-standing units to be easily leveled without lifting to compensate for uneven floors. Glides have ¾" adjustable range. Two pieces; 1⅞" end panel and ¾" back panel. 10500 Series™ modular and mobile pedestals fit flush to the end panel. Simple assembly.

⚠ Not designed to be used freestanding.

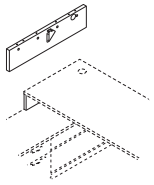

HNLEP307L shown

Laminate End Panel — 7"H Support for Worksurfaces					
1⅞"W x 30"D x 7"H, Right	HNLEP307R	7	0.7	\$177	\$11
1⅞"W x 30"D x 7"H, Left	HNLEP307L	7	0.7	\$177	\$11
1⅞"W x 24"D x 7"H, Right	HNLEP247R	6	0.7	\$177	\$11
1⅞"W x 24"D x 7"H, Left	HNLEP247L	6	0.7	\$177	\$11

NOTES: Specifically for layered surface applications; used to support a 29½"H component worksurface over a 21½"H low credenza unit. 1⅞" thick. Handed design (left and right models). Includes cord routing notch. Bottom of end panel is edgedbanded for added strength and to seal out moisture. Attaches to underside of worksurface via cam fasteners and L-bracket; attaches to top of low credenza with double-sided tape. Can be specified in a woodgrain or solid laminate color only. For 7"H metal O-leg support see page 100.

SPECIFYING EXAMPLE: HNLEP307R.H

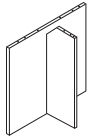

Not available in two-tone laminate

T-shaped End Panel					
11⅝"W x 29⅞"D x 28½"H	H10530TEP	45	3.7	\$329	\$342
11⅝"W x 23⅞"D x 28½"H	H10524TEP	38	3.2	\$308	\$321

NOTES: Non-handed. For use with 30"D and 24"D 10500 Series worksurfaces. Two 1⅞" thick pieces; one end and one brace panel. Cord routing notch in brace panel. Simple assembly.

⚠ Not designed to be used freestanding.

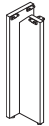

Not available in two-tone laminate

T-Support Brace					
8"W x 8"D x 28½"H	H10524TSUPP	14	0.8	\$278	\$294

NOTES: Intermediate support option for 29½"H workstations. Designed for 24"D and 30"D worksurfaces without a modesty or back panel, with an unsupported span greater than 48"W. Can be used to support the junction of two 24"D adjoining linear worksurfaces. Adjustable hex glides allow floor-standing units to be easily leveled without lifting to compensate for uneven floors; glides have ¾" adjustable range. Simple assembly.

NOTES:

- Adjustable hex leveling glides allow floor-standing furniture to be easily leveled without lifting the unit; glides have ¾" adjustable range.
- ⚠ Laminate L- and T-shaped end panels can be specified as one color only; not available in two-tone laminate combination or in a pattern laminate.

HOW TO SPECIFY

Select Model Number	Select Laminate
H 1 0 5 3 0 T E P .	See pages 247-248
N	



10500 SERIES™ Worksurface Supports



DESCRIPTION

Support Column for 10500 Series Rectangle and Bullet Worksurfaces

3" Diameter
For **Black**, specify HPC190X.P.
For **Silver**, specify HPC191X.X.

MODEL SHIP WEIGHT CUBE LIST PRICE

HPC190X	12 Ⓞ	1.0	\$219
HPC191X	12 Ⓞ	1.0	\$219

NOTES: Can only be used as the outbound support in a peninsula or island extension worksurface application. Glides have 3/4" adjustable range.

! Support column must be specified for worksurfaces used as peninsulas or as an island extension.

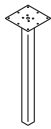

DESCRIPTION

Post Leg Base
28 1/2" H x 2" square

MODEL SHIP WEIGHT CUBE LIST PRICE BY PAINT GRADE

HLSL28P	15	1.0	\$385	\$390	\$406
----------------	----	-----	--------------	--------------	--------------

NOTES: Can only be used as the outbound support in a peninsula or island extension worksurface application. Glides have 2" of adjustability. Ship 1/pack.

! Post leg can only be used to support peninsula, not as primary supports for a top.

SPECIFYING EXAMPLE: HLSL28P.T1

24" D Rectangle Worksurface Support Options				
Product Application	Support Combination		Support Model Numbers for 72" W, 66" W, or 60" W Worksurfaces	Support Model Numbers for 48" W or 42" W Worksurfaces
	Support 1	Support 2		
Desk or Credenza	O-Leg	O-Leg	HLSL24280 (2)	HLSL24280 (2)
	O-Leg	L-Shaped End Panel	HLSL24280 / H10524LEP	HLSL24280 / H10524LEP
	L-Shaped End Panel	L-Shaped End Panel	H10524LEP (2)	H10524LEP (2)
	T-Shaped End Panel	O-Leg	H10524TEP / HLSL24280	H10524TEP / HLSL24280
	T-Shaped End Panel	L-Shaped End Panel	H10524TEP / H10524LEP	H10524TEP / H10524LEP
Peninsula for U- or L-Configuration; Not Freestanding	O-Leg	3" Diameter Support Column	HLSL24280 / HPC190X-191X	NA
	O-Leg	2" Square Post Leg	HLSL24280 / HLSL28P	NA
	L-Shaped End Panel	3" Diameter Support Column	H10524LEP / HPC190X-191X	NA
	L-Shaped End Panel	2" Square Post Leg	H10524LEP / HLSL28P	NA
	T-Shaped End Panel	3" Diameter Support Column	H10524TEP / HPC190X-191X	NA
Desk, Credenza, or Freestanding Return or Bridge	Adjustable Height Base - Electric		HHATB3S2LT/C	HHATB3S2LT/C (48" W min.)
Return (requires one support)	O-Leg	—	HLSL24280	HLSL24280
	L-Shaped End Panel	—	H10524LEP	H10524LEP
	T-Shaped End Panel	—	H10524TEP	H10524TEP
	3" Diameter Support Column	—	HPC190X or HPC191X	HPC190X or HPC191X
	2" Square Post Leg	—	HLSL28P	HLSL28P
Island Extension (requires one support)	O-Leg	—	HLSL24280	HLSL24280
	3" Diameter Support Column	—	HPC190X or HPC191X	HPC190X or HPC191X
	2" Square Post Leg	—	HLSL28P	HLSL28P

72" W, 66" W, or 60" W x 30" D Bullet Worksurface Support Options			
Product Application	Support Combination		Support Model Numbers
	Support 1	Support 2	
Peninsula for U- or L-Configuration; Not Freestanding	O-Leg	3" Diameter Support Column	HLSL30280 / HPC190X or HPC191X
	O-Leg	2" Square Post Leg	HLSL30280 / HLSL28P
	L-Shaped End Panel	3" Diameter Support Column	H10530LEP / HPC190X or HPC191X
	L-Shaped End Panel	2" Square Post Leg	H10530LEP / HLSL28P
	T-Shaped End Panel	3" Diameter Support Column	H10530TEP / HPC190X or HPC191X
	T-Shaped End Panel	2" Square Post Leg	H10530TEP / HLSL28P
Island Extension	3" Diameter Support Column	—	HPC190X or HPC191X
	2" Square Post Leg	—	HLSL28P

HOW TO SPECIFY

<p>Select Model Number</p> <p>H P C 1 9 0 X .</p>	<p>Select Paint Color</p> <p>See page 173</p> <p>T 1</p>
--	---

10500 SERIES™ Worksurface Supports

OPEN MARKET



Icon Legend on page 19

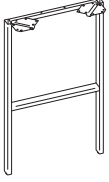

DESCRIPTION	MODEL	SHIP WEIGHT	CUBE	LIST PRICE BY PAINT GRADE		
				P1	P2	P3
H-Leg Support for Worksurfaces 30"W x 28 ³ / ₈ "H 24"W x 28 ³ / ₈ "H	H105HLEG3028	13.6	5.1	\$436	\$441	\$457
	H105HLEG2428	12.5	3.7	\$391	\$396	\$412
Standing-Height H-Leg Support for Worksurfaces 30"W x 41"H 24"W x 41"H	H105HLEG3041	16.5	6.5	\$587	\$596	\$608
	H105HLEG2441	15.4	5.3	\$525	\$534	\$546

NOTES:

- Legs ship fully assembled with mounting hardware, 1 per pack. Non-handed. H-leg glides have 2" adjustability. Will have 6" overhang when using 30"D H-legs with a 36"D worksurface.

! The H-leg attachment bracket interferes with placement of 10500 Series™ modular pedestals and 28³/₈"H mobile pedestals, preventing them from being positioned directly next to (flush with) the H-leg. Box/File mobile pedestal model H105106 and mobile printer/fax cart model H105679 can be positioned along side the H-leg.

! O- and H-legs may only be attached to worksurfaces, not storage units.

HOW TO SPECIFY

Select
Model Number

H 1 0 5 H L E G 2 4 4 1 .

Select
Paint Color









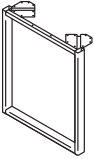

See page 173

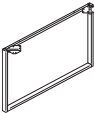
T 1

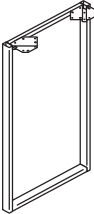

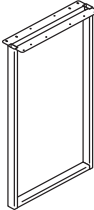
Icon Legend on page 19

10500 SERIES™ Worksurface Supports

	DESCRIPTION	MODEL	SHIP WEIGHT	CUBE	LIST PRICE BY PAINT GRADE		
					P1	P2	P3
  	O-Leg 30"D x 28½"H 24"D x 28½"H	HLSL30280 ☹️ HLSL24280	19.0 17.0	5.4 3.7	\$474 \$428	\$479 \$433	\$495 \$449
	NOTES: Ship fully assembled with mounting hardware, 1/pack. Non-handed. O-leg glides have 2" adjustability. Shared O-legs create a cleaner aesthetic in all applications where two legs are used side-by-side. Will have 6" overhang when using 30"D O-legs with a 36"D worksurface. IMPORTANT: The O-leg attachment bracket interferes with placement of 10500 Series modular pedestals and 28¾"H mobile pedestals, preventing them from being positioned directly next to (flush with) the O-leg. Box/file mobile pedestal (model H105106) and mobile printer/fax cart model (H105679) can be positioned along side the O-leg. ⓘ O-legs may only be attached to worksurfaces, not storage units. SPECIFYING EXAMPLE: HLSL24280.T1						
  	Double-Depth O-Leg Support for Worksurfaces 60"D x 28½"H 48"D x 28½"H	HLSL60280 HLSL48280	19.0 18.0	8.7 7.0	\$893 \$803	\$902 \$812	\$914 \$824
	NOTES: Ship fully assembled with mounting hardware, 1/package. Non-handed. 48"D and 60"D sizes span back-to-back 24"D and 30"D worksurfaces, respectively. O-leg glides have 2" adjustability. Shared O-legs create a cleaner aesthetic in all applications where two legs are used side-by-side. Will have 6" overhang when using 30"D O-legs with a 36"D worksurface. ⓘ O-legs may only be attached to worksurfaces, not storage units.						
  	Standing-Height O-Leg Support for Worksurfaces 30"D x 41"H 24"D x 41"H	HLSL30410 HLSL24410	17.0 16.0	6.5 5.3	\$639 \$571	\$646 \$578	\$660 \$592
	NOTES: Ship fully assembled with mounting hardware, 1/package. Non-handed. O-leg glides have 2" adjustability. O-leg installation requires 6" of clearance from the worksurface end. Shared O-legs create a cleaner aesthetic in all applications where two legs are used side-by-side. Will have 6" overhang when using 30"D O-legs with a 36"D worksurface. Coordinate™ Power Modules will work with standing-height applications for 10500™ and Voi® desks. ⓘ O-legs may only be attached to worksurfaces, not storage units.						
  	Standing-Height O-Leg Shared Support for Worksurfaces 30"D x 41"H 24"D x 41"H	HLSL3041SL HLSL2441SL	17.0 16.0	6.5 5.3	\$711 \$644	\$718 \$651	\$732 \$665
	NOTES: Ship fully assembled with mounting hardware, 1/package. Non-handed. For use with two 24"D or 30"D worksurfaces positioned side-by-side along the depth dimension. O-leg glides have 2" adjustability. O-leg installation requires 6" of clearance from the worksurface end. Shared O-legs create a cleaner aesthetic in all applications where two legs are used side-by-side. Will have 6" overhang when using 30"D O-legs with a 36"D worksurface. Coordinate™ Power Modules will work with standing-height applications for 10500™ and Voi® desks. Please see Coordinate™ Accessories Stand-Alone Pricer pages for more information. ⓘ O-legs may only be attached to worksurfaces, not storage units.						
 OPEN MARKET	O-Leg Cord Clips Clips for 28½" Worksurface O-Legs — 8-Pack	HWMCLIPLG	0.8 ☹️	0.1	\$133	N/A	N/A
	NOTES: Wire clips work with 7" Low Credenza O-leg and 29"H Support O-leg. Wire clips also work with the 50" and 65" Hutch O-legs. ⓘ Available in frosted plastic material only.						

NOTES:

ⓘ For shared components such as modesty panels, see page 200.

HOW TO SPECIFY

Select Model Number H L S L 3 0 2 8 0	Select Paint Color See page 173 T 1
---	--

10500 SERIES™ Worksurface Supports

GSA SIN 33721 EXCEPT AS NOTED



Icon Legend on page 19

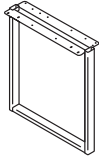

DESCRIPTION

O-Leg Shared Support for Worksurfaces

30"D x 28½"H
24"D x 28½"H

MODEL

HLSL3028SL ⓘ
HLSL2428SL

SHIP WEIGHT

19
17

CUBE

5.4
3.7

LIST PRICE BY PAINT GRADE

P1	P2	P3
\$589	\$594	\$610
\$531	\$536	\$552

NOTES: Ship fully assembled, 1/pack. Non-handed.

ⓘ Specify paint only.

SPECIFYING EXAMPLE: HLSL2028SL.T1

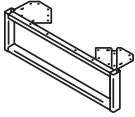

O-Leg Support for Low Credenzas

30"D x 7"H
24"D x 7"H

HLSL3070 ⓘ
HLSL2470

7
6

1.0
1.0

P1	P2	P3
\$366	\$371	\$387
\$288	\$293	\$309

NOTES: Ship fully assembled, 1/pack. Non-handed. For 7"H laminate support see page 98.

ⓘ Specify paint only.

SPECIFYING EXAMPLE: HLSL2070.T1

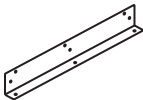

HVPWLBK24 shown

DESCRIPTION

Worksurface Wall Mount Bracket

For 30"
For 24"

MODEL

HVPWLBK30
HVPWLBK24

SHIP WEIGHT

2
2

CUBE

0.3
0.3

LIST PRICE

\$127
\$114

NOTES: Can be used in place of an end panel or O-leg to support a worksurface. Cannot be used as a support when placing a stack-on storage unit on worksurface over bracket; must have two full-sized floor supports when using stack-on storage. Finish option not required.

SPECIFYING EXAMPLE: HVPWLBK30

OPEN MARKET



DESCRIPTION

Worksurface to Tower Bracket Kit

18½" long bracket for attaching 24"D worksurface directly to storage tower, wardrobe/bookcase, wardrobe/storage cabinet, storage cabinet/lateral file, storage cabinet, or lateral file.

MODEL

HSTB2W1

SHIP WEIGHT

4

CUBE

0.6

LIST PRICE BY PAINT GRADE

P1	P2	P3
\$112	\$126	\$128

NOTES: Can be used in place of end panel or O-leg to support worksurfaces.

ⓘ Bracket not designed for use as a support if placing Stack-on Storage on worksurface over/above bracket. Two full-sized supports required when using Stack-on Storage.

NOTES:

- O-leg glides have 2" adjustability.
- For shared components such as modesty panels, see page 200.
- O-leg ships fully assembled with mounting hardware.
- For standing-height O-leg sizes, see page 265.
- Shared O-legs create a cleaner aesthetic in all applications where two legs are used side-by-side.
- Will have 6" overhang when using 30"D O-legs with a 36"D worksurface.

ⓘ O-legs may only be attached to worksurfaces, not storage units.

ⓘ O-leg installation requires 6" of clearance from the worksurface end.

HOW TO SPECIFY

<p>Select Model Number</p> <p>HVPWLBK30 . T1</p>	<p>Select Paint Color</p> <p>See page 173</p>
--	---

10500 SERIES™

Components — Supports

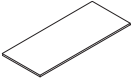
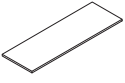
	DESCRIPTION	MODEL	SHIP WEIGHT	CUBE	LIST PRICE BY LAMINATE GRADE	
					L1	L2
	Rectangle Worksurface					
	72"W x 30"D	H105R3072	83	6.1	\$498	\$519
	66"W x 30"D	H105R3066	76	6.1	\$463	\$484
	60"W x 30"D	H105R3060	69	5.2	\$432	\$453
	48"W x 30"D	H105R3048	55	4.1	\$355	\$371
	72"W x 24"D	H105R2472	66	4.9	\$424	\$445
	66"W x 24"D	H105R2466	61	4.9	\$409	\$430
	60"W x 24"D	H105R2460	55	4.2	\$385	\$406
	48"W x 24"D	H105R2448	44	3.4	\$328	\$344
	42"W x 24"D	H105R2442	39	3.0	\$297	\$313

NOTES: Underside of rectangle worksurfaces includes pilot mounting holes for end panels, support columns, post and O-legs, and height adjustable base. Applications for 24"D worksurfaces include desks, credenzas, returns, and bridges. The 42"W x 24"D size is not compatible with Height Adjustable Base model HHATB3S2LT/C; it can however, be used in combination with the 72"W x 30"D worksurface on 3-Leg Height Adjustable Base model HHATB3S3LT.

NOTES:

- ❗ If using worksurfaces with Coordinate™ Height Adjustable Bases, an External Stiffener must be specified separately.
- ❗ Worksurfaces used with Coordinate™ Height Adjustable Bases should have 1" perimeter gap on each side to provide clearance between other furniture. Failure to do so risks injury or product damage (not covered by warranty).

HOW TO SPECIFY

Select Model Number	Select Laminate
	See pages 247-248
H 1 0 5 R 3 0 7 2	N N

10500 SERIES™

Height Adjustable Bases

GSA SIN 33721



Icon Legend on page 19

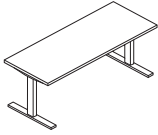

Base shown with worksurface attached.

DESCRIPTION	MODEL	SHIP WEIGHT	CUBE	LIST PRICE
Coordinate™ Height Adjustable Base – 2-Stage 2-Leg Rectangle T Foot	HHATB2S2LT	66	2.4	\$1058

NOTES:

- For use in combination applications where one end will be installed into a HAT shroud base and the other end will have an exposed T Foot.
- Model includes quantity 2 feet. The unused foot will need to be discarded at time of install.
- Dual motor two-leg design. Legs raise from 25 $\frac{5}{8}$ " to 45 $\frac{1}{4}$ ".
- Base accommodates any rectangular worksurface between 23"D x 40"W and 30"D x 72"W.
- Weight capacity of 250 lbs. (including the weight of the worksurface) distributed evenly.
- Control Box: 120V, 4A, 60Hz, 400W.
- 9' grounded power cord.
- 1 $\frac{1}{2}$ " / second travel speed.
- <50 dB noise rating.
- **HON 10-Year Warranty.**

! Only 2-Stage Coordinate™ bases will work with HAT shrouds and HAT low credenzas. 3-Stage Coordinate™ bases should not be used due to their lower height range.

! Requires the use of an external stiffener (purchased separately) for worksurfaces over 58"W or wider when not used with a Coordinate™ worksurface.

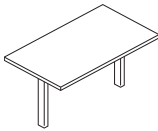

2-Leg Height Adjustable Base — 2-Stage	HNLAB2SIL	66	3.5	\$977
---	------------------	----	-----	--------------

NOTES: Base's design is without feet, which allows the leg to be directly installed into a shroud or low credenza.

! Base cannot be used as a stand-alone model. Base must be directly installed into a shroud or low credenza. Base ships without feet.

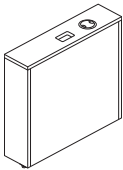

DESCRIPTION	MODEL	SHIP WEIGHT	CUBE	L1 LIST PRICE	L2 UPCHARGE
Shroud for Height Adjustable Base 36"D	HNL36SHR	48	4.7	\$1122	\$32
30"D	HNL30SHR	40	3.9	\$1100	\$27
24"D	HNL24SHR	33	3.1	\$1078	\$27

NOTES: Depths designed to match worksurface depths. Right- or left-handed determines which side the grommet is on.

NOTES:

- HAT base is bolted directly into unit for a solid connection without the need for the HAT base freestanding on feet.
- In combination applications with one HAT leg integrated and one HAT leg with an exposed T Foot use footed Coordinate™ base model HHATB2S2LT and discard the unused foot at time of install.
- In applications with both ends integrated into a shroud use the non-footed Coordinate™ base HNLAB2SIL.
- When specifying a grommet application, the grommet is near the front leg for cord management and has a grommet on the backside for cord management to wall power.

! Only 2-Stage Coordinate™ bases will work with HAT shrouds. 3-Stage Coordinate™ bases should not be used due to their lower height range.

HOW TO SPECIFY

Select Model Number HHATB2S2LT	Select Paint Color See page 114 PR6	Select Foot X Standard Foot S Slide Glide X	Select Keypad UD Basic Up/Down MEM Memory Preset PDL Paddle MEM
Select Model Number HNL30SHR	Select Grommet and Color (Leg Cut-Out Standard) See page 29 X No Grommet R Right Hand L Left Hand R	Select Laminate Color See page 29 H	

10500 SERIES™

Shared Components

GSA SIN 33721



Icon Legend on page 19

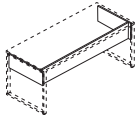

Not available in
two-tone laminate

DESCRIPTION	MODEL	SHIP WEIGHT	CUBE	LIST PRICE
Modesty Panels for Desks with O-Legs 68 ³ / ₈ "W x 3/4"D x 10"H — For 72" x 30" Desks	HLAMMP7230	26	2.1	\$358
56 ³ / ₈ "W x 3/4"D x 10"H — For 60" x 30" Desks	HLAMMP6030	23	1.8	\$328

NOTES: For use with 60"W or 72"W worksurfaces supported by O-legs. Comprised of three panels: one approach side and one for each end. Length below bottom of worksurface is 10". Steel external support channel (ordered separately) is recommended for unsupported spans greater than 54"W (i.e.: a distance in which there is not a vertical support between the underside of the worksurface and floor). Grain direction is vertical on approach and side panels for 56³/₈"W (all laminate colors) and 68³/₈"W (L1 laminate except Florence Walnut and Kingswood Walnut). Vertical on 27⁵/₈" end panels (all laminate colors). Horizontal on all panels for L2 laminates as well as Florence Walnut and Kingswood Walnut.

Specify: Model.Laminate

SPECIFYING EXAMPLE: HLAMMP7230.N

! \$16 upcharge for L2 laminates. See pages 247-248 for laminate options.

HOW TO SPECIFY

Select
Model Number

H L A M M P 7 2 3 0 .

Select
Laminate Chassis Color

See pages 247-248

N

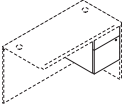
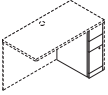
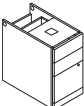
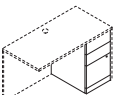
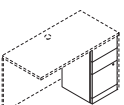

10500 SERIES™ Laminate Modular Components

	DESCRIPTION	MODEL	SHIP WEIGHT	CUBE	LIST PRICE BY LAMINATE GRADE	
					L1	L2
 Not available in two-tone laminate	Box/File Pedestal (with core removable lock) 15 $\frac{5}{8}$ "W x 22 $\frac{3}{4}$ "D x 17 $\frac{3}{4}$ "H — for use under 24"D, 30"D and 36"D desk, credenza and return shells NOTES: Attaches to underside of worksurface top. Both top box and file drawer lock. Top edges of file drawer include integrated rails for letter- or legal-sized filing. Not for use under 20"D shells. ⓘ Not designed to be used freestanding. Unfinished top and back.	H10501	57	5.5	\$647	\$668
 Not available in two-tone laminate	Narrow Box/Box/File Pedestal (with core removable lock) — floor-standing 9 $\frac{1}{2}$ "W x 22 $\frac{3}{4}$ "D x 28"H — for use under 24"D, 30"D and 36"D desk, credenza and return shells NOTES: Space-saving design supports smaller footprints. Middle box drawer and file drawer lock; top box drawer does not lock. Top edges of file drawer include integrated rails for letter- or legal-sized filing. Not for use under 20"D shells. ⓘ Not designed to be used freestanding. Unfinished top and back.	H105093	61	5.6	\$835	\$862
 Not available in two-tone laminate	Box/Box/File Pedestal — floor-standing 15 $\frac{5}{8}$ "W x 28 $\frac{3}{4}$ "D x 28"H — for use under 10500 Series 30"D worksurfaces supported by 29 $\frac{7}{8}$ "D L-shaped end panel model H10530LEP NOTES: Top box drawer does not lock. Top edges of file drawer include integrated rails for letter- or legal-sized filing. Not for use under shells, per "Inside Dimensions" listings. ⓘ Not designed to be used freestanding. Unfinished top and back.	H105062	105	10.5	\$918	\$950
 Not available in two-tone laminate	Box/Box/File Pedestal (with core removable lock) — floor-standing 15 $\frac{5}{8}$ "W x 22 $\frac{3}{4}$ "D x 28"H — for use under 24"D, 30"D and 36"D desk, credenza and return shells or worksurface supported by 23 $\frac{7}{8}$ "D L-shaped end panel(s) NOTES: Top box drawer does not lock. Top edges of file drawer include integrated rails for letter- or legal-sized filing. Not for use under 20"D shells. ⓘ Not designed to be used freestanding. Unfinished top and back.	H10502	90	8.4	\$848	\$875
 Not available in two-tone laminate	Box/Box/File Pedestal (with core removable lock) — floor-standing 15 $\frac{5}{8}$ "W x 18 $\frac{3}{4}$ "D x 28"H — for use under 20"D, 24"D, 30"D and 36"D desk, credenza and return shells NOTES: Top box drawer does not lock. Top edges of file drawer include integrated rails for letter- or legal-sized filing. ⓘ Not designed to be used freestanding. Unfinished top and back.	H105012	73	7.3	\$799	\$820

NOTES:

- Pedestals can be reconfigured quickly and easily when user preferences or space needs change.
- Locking units equipped with interchangeable core removable locks.
- Pedestal models ship assembled unless designated .
- Mobile pedestals shown on page 293, work well in a variety of configurations.
- Narrow Pedestal features a compact design that is ideal for use in U- and L-shaped layouts for smaller spaces such as a 5' x 8' U-shaped workstation or a 5' x 5' L-shaped workstation.
- 10500 Series™ modular pedestals are for use with desk, credenza and return shells (see pages 256-260), as well as L-shaped end panels (page 262).
- ⓘ Keyed alike cores must be ordered separately — see model HF23B on page 699 — makes re-keying quick and easy.
- ⓘ Access strip (filler) required when box/box file, file/file, and or narrow box/box/file pedestals are configured side-by-side to allow access for opening the drawers.
- ⓘ Modular pedestals can be specified as one color only; not available in two-tone laminate combination or in a pattern laminate.

HOW TO SPECIFY

Select Model Number H 1 0 5 0 9 3	Select Laminate Chassis Color See pages 247-248 N
---	--

10500 SERIES™

Laminate Modular Components

GSA SIN 33721



Icon Legend on page 19

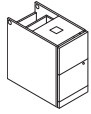

Not available in
two-tone laminate

DESCRIPTION**File/File Pedestal — floor-standing**

15 $\frac{5}{8}$ "W x 28 $\frac{3}{4}$ "D x 28"H — for use under 10500 Series 30"D worksurfaces supported by 29 $\frac{7}{8}$ "D L-shaped end panel model H10530LEP

NOTES: Top edges of file drawer include integrated rails for letter- or legal-sized filing. Not for use under shells, per "Inside Dimensions" listings.

⚠ Not designed to be used freestanding. Unfinished top and back.

MODEL**SHIP WEIGHT****CUBE****LIST PRICE BY LAMINATE GRADE****L1****L2****H105064**

104

10.5

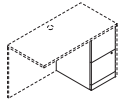
\$918**\$950**

Not available in
two-tone laminate

File/File Pedestal (with core removable lock) — floor-standing

15 $\frac{5}{8}$ "W x 22 $\frac{3}{4}$ "D x 28"H — for use under 24"D, 30"D and 36"D desk, credenza and return shells or worksurface supported by 23 $\frac{7}{8}$ "D L-shaped end panel(s)

NOTES: Top edges of file drawer include integrated rails for letter- or legal-sized filing. Not for use under 20"D shells.

⚠ Not designed to be used freestanding. Unfinished top and back.

H10504

85

8.2

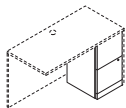
\$848**\$875**

Not available in
two-tone laminate

File/File Pedestal (with core removable lock) — floor-standing

15 $\frac{5}{8}$ "W x 18 $\frac{3}{4}$ "D x 28"H — for use under 20"D, 24"D, 30"D and 36"D desk, credenza and return shells

NOTES: Top edges of file drawer include integrated rails for letter- or legal-sized filing.

⚠ Not designed to be used freestanding. Unfinished top and back.

H105014

72

7.3

\$799**\$820**

Not available in
two-tone laminate

Access Strip (Filler)

1 $\frac{1}{8}$ "W x 20 $\frac{1}{2}$ "D x 28"H

H10524

21

0.9

\$219**\$230**

NOTES: For use under 24"D, 30"D and 36"D desk, credenza or return shells when B/B/F, F/F, and or narrow B/B/F pedestals are configured side-by-side. Not required when pedestals are used in conjunction with lateral file pedestals, multi file pedestals or cabinet pedestal. Not sized for use with 20"D modular shells.

NOTE: See pages 256-260 for desk, credenza and return shells.

NOTES:

- Pedestals can be reconfigured quickly and easily when user preferences or space needs change.
- Locking units equipped with interchangeable core removable locks.
- Pedestal models ship assembled unless designated
- Mobile pedestals shown on page 293, work well in a variety of configurations.
- Narrow Pedestal features a compact design that is ideal for use in U- and L-shaped layouts for smaller spaces such as a 5' x 8' U-shaped workstation or a 5' x 5' L-shaped workstation.
- 10500 Series™ modular pedestals are for use with desk, credenza and return shells (see pages 256-260), as well as L-shaped end panels (page 262).
- ⚠ Keyed alike cores must be ordered separately — see model HF23B on page 699 — makes re-keying quick and easy.
- ⚠ Access strip (filler) required when box/box file, file/file, and or narrow box/box/file pedestals are configured side-by-side to allow access for opening the drawers.
- ⚠ Modular pedestals can be specified as one color only; not available in two-tone laminate combination or in a pattern laminate.

HOW TO SPECIFY**Select Model Number**

H 1 0 5 0 4 .

Select Laminate Chassis Color

See pages 247-248

N



10500 SERIES™

Laminate Modular Components

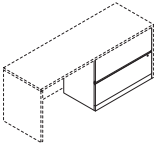
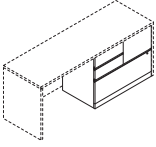
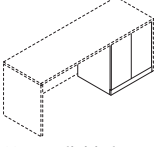
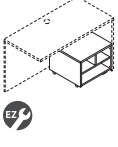
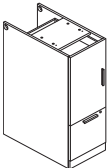
	DESCRIPTION	MODEL	SHIP WEIGHT	CUBE	LIST PRICE BY LAMINATE GRADE	
					L1	L2
 <p>Not available in two-tone laminate</p>	Lateral File Pedestal (with core removable lock) — Floor-standing 36"W x 20"D x 28"H — For use under 24"D, 30"D and 36"D desk, credenza and return shells NOTES: Top edges of file drawer include integrated rails for letter- or legal-sized filing. Mechanical interlock inhibits extension of more than one drawer at a time. Not for use under 20"D shells.	H10503	127	15.6	\$1286	\$1328
 <p>Not available in two-tone laminate</p>	Multi File Pedestal (with core removable lock) — Floor-standing 36"W x 20"D x 28"H — For use under 24"D, 30"D and 36"D desk, credenza and return shells NOTES: Versatile four drawer unit features a lateral file, vertical file, and two box drawers. Box drawers do not lock. Top edges of file drawer include integrated rails for letter- or legal-sized filing. Mechanical interlock in lateral drawer inhibits extension of more than one drawer at a time. Not for use under 20"D shells.	H10505	155	15.6	\$1542	\$1584
 <p>Not available in two-tone laminate</p>	Cabinet Pedestal — Floor-standing 26"W x 21¼"D x 28"H — For use under 24"D, 30"D and 36"D desk, credenza and return shells NOTES: One adjustable shelf at 2½" increments. Doors are non-locking. Not for use under 20"D shells.	H10508	78	12.2	\$960	\$1002
 <p>Not available in two-tone laminate</p>	Mobile Printer/Fax Cart 20"W x 19⅞"D x 14⅞"H — For use under 24"D, 30"D and 36"D desk, credenza and return shells NOTES: Holds laser printers, inkjet printers or fax machines. Ideal for limited space. Low profile cart stores conveniently and easily under desks and workstations. Interior compartment shelving is Black. Four casters. Specify laminate top and chassis color. Not for use under 20"D shells.	H105679	52	2.9	\$526	\$547
	SPECIFYING EXAMPLE: H105679.NN					
 <p>Not available in two-tone laminate</p>	Box/Shelf/File Pedestal 15⅝"W x 28¾"D x 41"H — For 30"D worksurfaces 15⅝"W x 22¾"D x 41"H — For 24"D or 30"D worksurfaces NOTES: For 42"H standing-height desks. Designed to be used under a component worksurface supported on the pedestal end(s) by 41"H L-shaped end panel(s). For single pedestal workstations, the non-pedestal end can be supported by a 41"H L-shaped end panel, H-leg, or O-leg. Adjustable hex glides allow floor-standing units to be easily leveled without lifting to compensate for uneven floors; glides have ¾" adjustable range. Cabinet includes one box (supply) drawer and two shelves (one fixed, one adjustable); shelf adjusts in 1¼" increments with a range of 5". Not to be used freestanding, top and back are not enclosed. Pedestal depth is less than the depth of the respective component top to accommodate L-shaped end panel. Top edges of file drawer include integrated rails for letter- or legal-sized filing. Standard with linear handles in black finish.	H105077 H105076	104 89	14.7 11.9	\$1770 \$1709	\$1828 \$1762

NOTES:

- Pedestals can be reconfigured quickly and easily when user preferences or space needs change.
- File drawers accept hanging folders in letter or legal size.
- Mobile pedestals shown on page 293, work well in a variety of configurations.
- Locking units equipped with interchangeable core removable locks.
- Pedestal models ship assembled unless designated .
- See pages 256-260 for desk, credenza and return shells.

 Keyed alike cores must be ordered separately — see model HF23B on page 699 — makes re-keying quick and easy.

 Access strip (filler) required when box/box file, file/file, and or narrow box/box/file pedestals are configured side-by-side to allow access for opening the drawers.

HOW TO SPECIFY

Select Model Number H 1 0 5 0 3 . N	Select Laminate Chassis Color See pages 247-248
---	---

10500 SERIES™

Laminate Wood Desks — Full Pedestals

GSA SIN 33721



Icon Legend on page 19

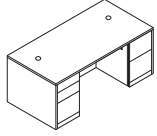

DESCRIPTION	FULL WIDTH OVERHANG	MODEL	SHIP WEIGHT	CUBE	LIST PRICE BY LAMINATE GRADE	
					L1	L2
Double Pedestal Desk						
72"W x 36"D x 29½"H, Bow Top, 3/2	10½"	H105899	315	50.9	\$2304	\$2388
72"W x 36"D x 29½"H, Rectangle Top, 3/2	10½"	H105890	340	50.9	\$2101	\$2180
66"W x 30"D x 29½"H, Rectangle Top, 3/2	4½"	H105891	290	39.4	\$1958	\$2026
60"W x 30"D x 29½"H, Rectangle Top, 3/2	4½"	H105892	278	35.9	\$1840	\$1903

NOTES: All drawers lock. Two cord grommets in top for routing and hiding wires and cables. Bow top models measure 36"D at crest and 30"D along the end panels. See pages 709-710 for optional center drawers.

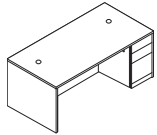

Single Pedestal Desk						
72"W x 36"D x 29½"H, Bow Top, Right	10½"	H105893R	292	50.9	\$1888	\$1962
72"W x 36"D x 29½"H, Rectangle Top, Right	10½"	H105895R Ⓢ	278	50.9	\$1680	\$1754
66"W x 30"D x 29½"H, Rectangle Top, Right	4½"	H105897R	226	39.4	\$1517	\$1575
72"W x 36"D x 29½"H, Bow Top, Left	10½"	H105894L	292	50.9	\$1888	\$1962
72"W x 36"D x 29½"H, Rectangle Top, Left	10½"	H105896L Ⓢ	278	50.9	\$1680	\$1754
66"W x 30"D x 29½"H, Rectangle Top, Left	4½"	H105898L	226	39.4	\$1517	\$1575

NOTES: Box/box/file drawers. Drawers lock. Two cord grommets in top for routing and hiding wires and cables. Bow top models measure 36"D at crest and 30"D along the end panels. See pages 709-710 for optional center drawers.

NOTES:

- Factory-configured desks, credenzas and returns ship fully assembled for ease and speed of installation.
- Full-to-floor pedestals maximize storage space.
- Smooth, flat edges provide a clean look.
- Tops are easy-care, scratch-, spill- and stain-resistant laminate over 1⅛" solid core high-performance particleboard.
- 3" round cord management grommets, for routing and hiding wires and cables, are located in the tops of desks, returns, bridges, and corner units. Grommet cutout accepts optional Power Hub (model HGRMTAC) or Power/USB Hub (model HGRMTUSB2) — see page 723.
- For work-in-process paper management tools, see pages 715-717.
- Drawers operate on full extension, ball-bearing suspensions to ensure smooth, quiet, long-lasting operation.
- File drawer design includes integrated hangrails for side-to-side letter or legal filing; and front-to-back for letter filing.
- For field installable decorative handle options, see page 302.
- All drawers are five-sided construction for added strength and easy alignment or replacement of drawer fronts.
- Center drawers conveniently store writing instruments, paper and other miscellaneous items. Includes pencil tray. See page 710.

HOW TO SPECIFY

Select
Model Number

H 1 0 5 8 9 9 .

Select
Laminate Top and Chassis Color

See pages 247-248

N N

10500 SERIES™ Laminate Wood Desks — Full Pedestals

	DESCRIPTION	FULL WIDTH OVERHANG	MODEL	SHIP WEIGHT	CUBE	LIST PRICE BY LAMINATE GRADE	
						L1	L2
	Return, file/file						
	48"W x 24"D x 29½"H, Right		H105905R	167	24.2	\$1188	\$1230
	42"W x 24"D x 29½"H, Right		H105907R	147	21.4	\$1161	\$1203
	48"W x 24"D x 29½"H, Left		H105906L	167	24.2	\$1188	\$1230
	42"W x 24"D x 29½"H, Left		H105908L	147	21.4	\$1161	\$1203
NOTES: Return is for use with single pedestal desks, desk shells, peninsulas or corner units. One worksurface grommet and one cord pass-through grommet in top center of modesty panel to reach wall electrical outlets. Drawers lock. Not to be used freestanding. Will not attach to Corner Units manufactured prior to 5/24/99. See pages 284-285 for optional Stack-on Storage.							
	Credenza with Doors						
	72"W x 24"D x 29½"H	3½"	H105909	323	34.8	\$2174	\$2242
NOTES: All drawers lock. Doors are non-locking. Includes a fixed shelf located at the bottom of the center storage area. No intermittent shelf. See pages 284-285 for optional Stack-on Storage.							
	Credenza with Kneespace, file/file						
	72"W x 24"D x 29½"H	3½"	H105900	274	34.8	\$1842	\$1905
	66"W x 24"D x 29½"H	3½"	H105901	262	32.0	\$1824	\$1887
	60"W x 24"D x 29½"H	3½"	H105902	248	29.2	\$1757	\$1815
NOTES: All drawers lock. One cord pass-through grommet in top center of modesty panel to reach wall electrical outlets. Not designed for use with 22¾"D modular or mobile pedestals. Modesty/back panel is inset 3½". See pages 284-285 for optional Stack-on Storage.							
	Single Pedestal Credenza, file/file						
	72"W x 24"D x 29½"H, Right (shown)	3½"	H105903R	226	34.8	\$1494	\$1552
	72"W x 24"D x 29½"H, Left	3½"	H105904L	226	34.8	\$1494	\$1552
NOTES: Drawers lock. One cord pass-through grommet in top center of modesty panel to reach wall electrical outlets. Not designed for use with 22¾"D modular or mobile pedestals. Modesty/back panel is inset 3½". See pages 284-285 for optional Stack-on Storage.							
	Low Credenza						
	72"W x 20"D x 21½"H, Drawers Right, Bookcase Left		H105975R	219	23.5	\$1635	\$1698
	72"W x 20"D x 21½"H, Drawers Left, Bookcase Right		H105976L	219	23.5	\$1635	\$1698
	60"W x 20"D x 21½"H, Drawers Right, Bookcase Left		H105973R	187	19.7	\$1506	\$1564
	60"W x 20"D x 21½"H, Drawers Left, Bookcase Right		H105974L	187	19.7	\$1506	\$1564
NOTES: Combines with overlapping, 29½"H worksurfaces to create a multi-level workstation for a modern aesthetic. For use in open plan spaces or private offices. Two locking drawers (1 box and 1 file) and open shelving. File drawers include integrated handrails for letter- or legal-sized folders. Bookcase has one adjustable shelf; adjusts in 1¼" increments with a range of 6". Overlapping surfaces can be supported by a 28½"H H-leg or O-leg, or 7"H O-leg, or by 7"H laminate end panel. On 60"W models, grain on back panel runs vertical for all woodgrain laminates. On 72", grain on back panel runs vertical for L1 woodgrains except for Florence and Kingswood Walnuts and horizontal on L2 laminates and Florence and Kingswood Walnuts. Optional seat cushions HLSL2036CH2 for 72"W and HLSL2030CH2 for 60"W.							

NOTES:

- Factory-configured desks, credenzas and returns ship fully assembled for ease and speed of installation.
 - Formal, full-length modesty panels.
 - Tops are easy-care, scratch-, spill- and stain-resistant laminate over 1/8" solid core high-performance particleboard.
 - 3" round cord management grommets, for routing and hiding wires and cables, are located in the tops of desks, returns, bridges, and corner units. Grommet cutout accepts optional Power Hub (model HGRMTAC) or Power/USB Hub (model HGRMTUSB2) — see page 723.
 - Drawers operate on full extension, ball-bearing suspensions to ensure smooth, quiet, long-lasting operation.
 - All drawers are five-sided construction for added strength and easy alignment or replacement of drawer fronts.
 - Top edges of file drawer include integrated rails for letter- or legal-sized filing.
 - For field installable decorative handle options, see page 302.
 - 10500 Series™ 18¾"D modular and mobile pedestals can be positioned under credenza with kneespace and single pedestal credenza models.
- Keyed alike cores must be ordered separately — see model HF23B on page 699 — makes re-keying quick and easy.

HOW TO SPECIFY

Select Model Number	Select Laminate Top and Chassis Color See pages 247-248 Kickplates will match chassis color
<div style="border: 1px solid black; padding: 2px; display: flex; gap: 5px;"> H105905R </div>	<div style="border: 1px solid black; padding: 2px; display: flex; gap: 5px;"> NN </div>

10500 SERIES™

Laminate Wood Desks — Full Pedestals

GSA SIN 33721



Icon Legend on page 19

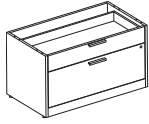

DESCRIPTION	MODEL	SHIP WEIGHT	CUBE	L1 LIST	L2 UPCHARGES	
					CHASSIS	FRONTS
2-Drawer Credenza, No Top						
36"W x 24"D x 19 ⁷ / ₈ "H	H105LC3624BF	105.5	13.9	\$649	\$37	\$21
36"W x 20"D x 19 ⁷ / ₈ "H	H105LC3620BF	97.9	11.7	\$649	\$32	\$21
30"W x 24"D x 19 ⁷ / ₈ "H	H105LC3024BF	92.3	11.7	\$688	\$32	\$16
30"W x 20"D x 19 ⁷ / ₈ "H	H105LC3020BF	85.4	9.9	\$624	\$27	\$16

NOTES: Use in conjunction with Modular Credenza tops on page 277.

① Keyed alike cores must be ordered separately — see model HF23B on page 699 — makes re-keying quick and easy.

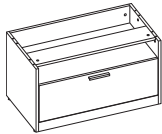

DESCRIPTION	MODEL	SHIP WEIGHT	CUBE	L1 LIST	L2 UPCHARGES	
					CHASSIS	FRONTS
Open/Lateral Credenza, No Top						
36"W x 24"D x 19 ⁷ / ₈ "H	H105LC3624SF	117.2	13.9	\$624	\$37	\$21
36"W x 20"D x 19 ⁷ / ₈ "H	H105LC3620SF	106.1	11.7	\$624	\$32	\$21
30"W x 24"D x 19 ⁷ / ₈ "H	H105LC3024SF	101.7	11.7	\$606	\$32	\$16
30"W x 20"D x 19 ⁷ / ₈ "H	H105LC3020SF	91.8	9.9	\$606	\$27	\$16

NOTES: Use in conjunction with Modular Credenza tops on page 277. Drawer is non-locking.



DESCRIPTION	MODEL	SHIP WEIGHT	CUBE	LIST PRICE BY LAMINATE GRADE	
				L1	L2
Open HAT Credenza, No Top					
36"W x 24"D x 21 ¹ / ₂ "H	H105LCHAT3624S	82.3	13.9	\$298	\$335
36"W x 20"D x 21 ¹ / ₂ "H	H105LCHAT3620S	71.2	11.7	\$298	\$330
30"W x 24"D x 21 ¹ / ₂ "H	H105LCHAT3024S	72.2	11.7	\$274	\$306
30"W x 20"D x 21 ¹ / ₂ "H	H105LCHAT3020S	62.3	9.9	\$274	\$301

NOTES: False back allows HAT base leg to be concealed. Use in conjunction with Modular Credenza tops with HAT cutout on page 277.

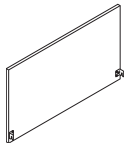

DESCRIPTION	MODEL	SHIP WEIGHT	CUBE	L1 LIST	L2 LIST
				Back for Open Storage Cabinet	
36"W x 19 ⁷ / ₈ "H	H105LCHAT3620B	25.0	2.1	\$274	\$290
30"W x 19 ⁷ / ₈ "H	H105LCHAT3020B	25.0	1.8	\$248	\$264

NOTES: Optional model to conceal HAT base leg when used in open office settings. Use with Open HAT Credenzas, No Top when the back of the unit will be visible in an open plan office.

NOTES:

- Units can be combined to create 60"W, 66"W, and 72"W low credenzas utilizing Modular Credenzas.
- Units have unfinished tops.
- File drawers include integrated hangrails for letter- or legal-sized folders.
- Open Credenzas have one adjustable shelf; adjusts 1¹/₄" increments with a range of 6".
- Overlapping surfaces can be supported by a 28¹/₂"H or 7"H O-leg or by 7"H laminate end panel.

HOW TO SPECIFY

Select Model Number H 1 0 5 L C 3 6 2 0 B F .	Select Chassis Laminate See page 247 Kickplates will match chassis color L F W 1 .	Select Door Front Laminate See page 247 L F W 1 .	Select Pull and Color L Linear P Black L P .	Select Lock Option Only available on 2-Drawer Credenzas L Lock L .
Select Model Number H 1 0 5 L C H A T 3 6 2 0 B .	Select Chassis Laminate See page 247 Kickplates will match chassis color L F W 1 .			

	DESCRIPTION	MODEL	SHIP WEIGHT	CUBE	LIST PRICE BY LAMINATE GRADE	
					L1	L2
	Modular Credenza Tops, Height Adjustable Base					
	30"W x 24"D, Non-handed	H105CTHAT3024	23.5	2.3	\$490	\$506
	30"W x 20"D, Non-handed	H105CTHAT3020	19.6	1.9	\$490	\$506
	72"W x 24"D, Right	H105CTHAT7224R	72.3	5.0	\$991	\$1012
	72"W x 20"D, Right	H105CTHAT7220R	72.3	4.2	\$991	\$1012
	66"W x 24"D, Right	H105CTHAT6624R	66.3	4.6	\$919	\$940
	66"W x 20"D, Right	H105CTHAT6620R	60.3	3.9	\$919	\$940
	60"W x 24"D, Right	H105CTHAT6024R	60.3	4.2	\$844	\$865
	60"W x 20"D, Right	H105CTHAT6020R	66.3	3.6	\$844	\$865
	36"W x 24"D, Right	H105CTHAT3624R	36.1	2.6	\$613	\$629
	36"W x 20"D, Right	H105CTHAT3620R	36.1	2.3	\$613	\$629
	72"W x 24"D, Left	H105CTHAT7224L	72.3	5.0	\$991	\$1012
	72"W x 20"D, Left	H105CTHAT7220L	72.3	4.2	\$991	\$1012
	66"W x 24"D, Left	H105CTHAT6624L	66.3	4.6	\$919	\$940
	66"W x 20"D, Left	H105CTHAT6620L	66.3	3.9	\$919	\$940
	60"W x 24"D, Left	H105CTHAT6024L	60.3	4.2	\$844	\$865
	60"W x 20"D, Left	H105CTHAT6020L	60.3	3.6	\$844	\$865
	36"W x 24"D, Left	H105CTHAT3624L	36.1	2.6	\$613	\$629
	36"W x 20"D, Left	H105CTHAT3620L	36.1	2.3	\$613	\$629
	Modular Credenza Tops					
	30"W x 20"D	H105CT3020	19.6	1.9	\$490	\$506
	36"W x 20"D	H105CT3620	36.1	2.3	\$613	\$629
	30"W x 24"D	H105CT3024	23.5	2.3	\$490	\$506
	36"W x 24"D	H105CT3624	36.1	2.6	\$613	\$629

NOTES:

- Easy care, scratch-, spill- and stain-resistant laminate over 1/8" solid core high-performance particleboard.
- Grain direction on all worksurfaces runs horizontal.
- Tops are intended to be used with modular low credenzas on page 276.
- Tops come with hardware to attach to low credenzas.
- Tops have a right or left notch to accommodate HON's Height Adjustable Base legs.

	DESCRIPTION	MODEL	SHIP WEIGHT	CUBE	LIST PRICE BY FABRIC GRADE					
					1	2	3	4	5	6
	Fabric Credenza Tops									
	36"W x 24"D x 1"H for 36"W Credenzas	H1AMSEAT3624	12	2.6	\$540	\$580	\$620	\$660	\$699	\$739
	30"W x 24"D x 1"H for 36"W Credenzas	H1AMSEAT3024	10	2.3	\$501	\$539	\$577	\$614	\$652	\$690
	36"W x 20"D x 1"H for 72"W Credenzas	H1SL2036CH2	11	2.2	\$541	\$581	\$621	\$662	\$713	\$765
	36"W x 20"D x 1"H for 60"W Credenzas	H1SL2030CH2	9	1.9	\$501	\$539	\$577	\$614	\$662	\$712
	NOTES: See pages 22-24 for available fabrics.									
	COM: .75									
	SPECIFYING EXAMPLE: H1AMSEAT3624.AP23									

HOW TO SPECIFY

Select Model Number

H 1 0 5 C T H A T 3 6 2 0 .

Select Laminate and Edge Color

See page 247

L F W 1 F W

10500 SERIES™

Laminate Wood Desks — 3/4 Pedestals

GSA SIN 33721

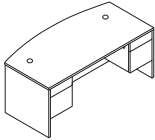
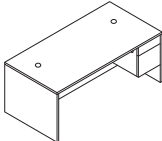
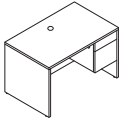
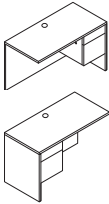

Icon Legend on page 19

	DESCRIPTION	FULL WIDTH OVERHANG	MODEL	SHIP WEIGHT	CUBE	LIST PRICE BY LAMINATE GRADE	
						L1	L2
	Double Pedestal Desk						
	72"W x 36"D x 29½"H, Bow Top, 2-2	10½"	H10595	300	52.9	\$1925	\$2009
	72"W x 36"D x 29½"H, Rectangle Top, 2-2	10½"	H10593 Ⓞ	320	52.9	\$1716	\$1795
	66"W x 30"D x 29½"H, Rectangle Top, 2-2	4½"	H10571	286	40.9	\$1571	\$1639
	60"W x 30"D x 29½"H, Rectangle Top, 2-2	4½"	H10573 Ⓞ	271	37.4	\$1447	\$1510
	NOTES: All drawers lock. Two cord grommets in top for routing and hiding wires and cables. Bow top models measure 36"D at crest and 30"D along the end panels. See pages 709-710 for optional center drawers.						
	Single Pedestal Desk						
	72"W x 36"D x 29½"H, Bow Top, Right	10½"	H10587R	238	52.9	\$1662	\$1736
	72"W x 36"D x 29½"H, Rectangle Top, Right	10½"	H10585R	279	52.9	\$1459	\$1527
	66"W x 30"D x 29½"H, Rectangle Top, Right	4½"	H10583R Ⓞ	229	41.0	\$1283	\$1341
	72"W x 36"D x 29½"H, Bow Top, Left	10½"	H10588L	238	52.9	\$1662	\$1736
	72"W x 36"D x 29½"H, Rectangle Top, Left	10½"	H10586L	279	52.9	\$1459	\$1527
	66"W x 30"D x 29½"H, Rectangle Top, Left	4½"	H10584L Ⓞ	229	41.0	\$1283	\$1341
	NOTES: Box/file drawers. Drawers lock. Two cord grommets in top for routing and hiding wires and cables. Bow top models measure 36"D at crest and 30"D along the end panels. See pages 709-710 for optional center drawers.						
	Small Office Desk						
	48"W x 30"D x 29½"H, 3/4 Pedestal, Right box/file	4½"	H105885R	168	30.5	\$1140	\$1182
	NOTES: Small footprint makes this desk ideal for limited space. Drawers lock. One cord grommet in top for routing and hiding wires and cables. 3/4 height modesty panel facilitates reaching wall electrical outlets. Optional stack-on storage model H105323 maximizes storage space; see page 284.						
	Return, box/file						
	48"W x 24"D x 29½"H, Right		H10515R Ⓞ	147	25.6	\$1034	\$1076
	42"W x 24"D x 29½"H, Right		H10511R	138	20.5	\$1012	\$1054
	48"W x 24"D x 29½"H, Left		H10516L Ⓞ	147	25.6	\$1034	\$1076
	42"W x 24"D x 29½"H, Left		H10512L	138	20.5	\$1012	\$1054
	NOTES: Return is for use with single pedestal desks, desk shells, peninsulas or corner units. One worksurface grommet and one cord pass-through grommet in top center of modesty panel to reach wall electrical outlets. Drawers lock. See pages 284-285 for optional stack-on storage.						
	⚠ Not designed to be used freestanding. Will not attach to Corner Units manufactured prior to 5/24/99.						

NOTES:

- For components that can be shared with 10500 Series™, see pages 280-302.
- Tops and end panels are abrasion- and stain-resistant laminate over durable 1½" solid core high-performance particleboard; resists warping.
- Formal, full height modesty panels.
- 3/4 pedestal design increases budget flexibility.
- 3" round cord management grommets, for routing and hiding wires and cables, are located in the tops of desks, returns, bridges, and corner units. Grommet cutout accepts optional Power Hub (model HGRMTAC) or Power/USB Hub (model HGRMTUSB2) — see page 723.
- All drawers are 5-sided construction, which allows easy drawer alignment or replacement of drawer fronts.
- Drawers operate on full extension, ball-bearing suspensions to ensure smooth, quiet, long-lasting operation.
- File drawer design includes integrated hangrails for side-to-side letter or legal filing; and front-to-back for letter filing.
- For field installable decorative handle options, see page 302.
- Desk, credenza, and return models ship assembled.
- See stack-on storage and stack-on PC organizer options on pages 283-285.
- Use with Above Worksurface Privacy Screens. See page 270.

HOW TO SPECIFY

Select Model Number	Select Laminate Top and Chassis Color
	See pages 247-248
H 1 0 5 9 5 .	N N



10500 SERIES™

Laminate Wood Desks — 3/4 Pedestals

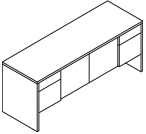
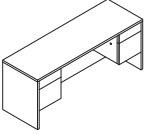
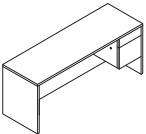
	DESCRIPTION	FULL WIDTH OVERHANG	MODEL	SHIP WEIGHT	CUBE	LIST PRICE BY LAMINATE GRADE	
						L1	L2
	Credenza with Doors 72"W x 24"D x 29½"H NOTES: All drawers lock. Doors are non-locking. Includes a fixed shelf located at the bottom of the center storage area. No intermittent shelf. See pages 284-285 for optional stack-on storage.	3½"	H10544	278	36.0	\$1866	\$1934
	Credenza with Kneespace — box/file 72"W x 24"D x 29½"H 66"W x 24"D x 29½"H 60"W x 24"D x 29½"H NOTES: All drawers lock. One cord pass-through grommet in top center of modesty panel to reach wall electrical outlets. ⓘ Not designed to be used with 22¾"D modular or mobile pedestals. Modesty/back panel is inset 3½".	3½" 3½" 3½"	H10543 ⓘ H10566 H10565 ⓘ	243 234 229	36.3 33.4 28.8	\$1531 \$1516 \$1447	\$1594 \$1579 \$1505
	Single Pedestal Credenza — box/file 72"W x 24"D x 29½"H, Right (shown) 72"W x 24"D x 29½"H, Left NOTES: Drawers lock. One cord pass-through grommet in top center of modesty panel to reach wall electrical outlets. See page 284 for optional stack-on storage. ⓘ Not designed to be used with 22¾"D modular or mobile pedestals. Modesty/back panel is inset 3½".	3½" 3½"	H10545R H10546L	212 212	36.0 36.0	\$1264 \$1264	\$1322 \$1322

NOTES:

- For components that can be shared with 10500 Series™, see pages 280-302.
- Tops and end panels are abrasion- and stain-resistant laminate over durable 1½" solid core high-performance particleboard; resists warping.
- Formal, full height modesty panels.
- 3/4 pedestal design increases budget flexibility.
- 3" round cord management grommets, for routing and hiding wires and cables, are located in the tops of desks, returns, bridges, and corner units. Accepts optional Power Hub Grommet model HGRMTAC — page 723.
- All drawers are 5-sided construction, which allows easy drawer alignment or replacement of drawer fronts.
- Drawers operate on full extension, ball-bearing suspensions to ensure smooth, quiet, long-lasting operation.
- File drawer design includes integrated hangrails for side-to-side letter or legal filing; and front-to-back for letter filing.
- For field installable decorative handle options, see page 302.
- Desk, credenza, and return models ship assembled.
- See stack-on storage and stack-on PC organizer options on pages 283-285.
- Use with Above Worksurface Privacy Screens. See page 270.

HOW TO SPECIFY

Select Model Number H 1 0 5 4 4 .	Select Laminate Top and Chassis Color See pages 247-248 N N
---	--

10500 SERIES™

Shared Components & Accessories

GSA SIN 33721

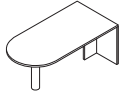

Icon Legend on page 19

**DESCRIPTION****Peninsula w/End Panel**

72"W x 36"D x 29½"H
 72"W x 30"D x 29½"H
 66"W x 30"D x 29½"H
 60"W x 30"D x 29½"H

MODEL**SHIP WEIGHT****CUBE****LIST PRICE BY LAMINATE GRADE****L1****L2**

H10521E
H105209E
H10522E
H10523E

146
 126
 121
 96

8.1
 7.0
 6.6
 6.6

\$1101
\$1030
\$1016
\$953

\$1149
\$1078
\$1064
\$1001

NOTES: Use for "U" or "L" configuration. 60"W size ideal for smaller spaces. Cord routing notch in brace panel. Accepts field installable modesty panel model H10528. Accepts center drawer model H1522. Model H1522 can be used in conjunction with the laminate modesty panel model H10528. Round support column is black.

ⓘ Not designed to be used freestanding.

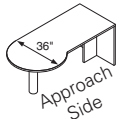

72"W x 30/36"D x 29½"H, P-shaped Right
 72"W x 36/30"D x 29½"H, P-shaped Left

H10525RE
H10526LE

138
 138

8.1
 8.1

\$1284
\$1284

\$1332
\$1332

NOTES: Use for "U" or "L" configuration. Cord routing notch in brace panel. Accept field installable modesty panel model H10528 (see page 281). See pages 709-710 for optional center drawers. Round support column is black.

ⓘ Not designed to be used freestanding.

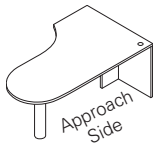

Right-hand model
 H105201RE shown

Jetty Peninsula w/End Panel

72"W x 30/42"D x 29½"H, Right
 72"W x 42/30"D x 29½"H, Left

H105201RE
H105202LE

152
 152

9.4
 9.4

\$1423
\$1423

\$1481
\$1481

NOTES: For use in "U" or "L" configuration. Designed and sized to efficiently serve as both a computing and conferencing space. One cord management grommet in the top; cord routing notch in brace panel. Round support column is black.

ⓘ Not designed to be used freestanding. Jetty units manufactured on or after 10/24/2005 accept field installable modesty panel H10528 (see page 281).

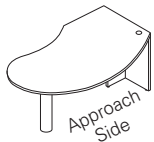
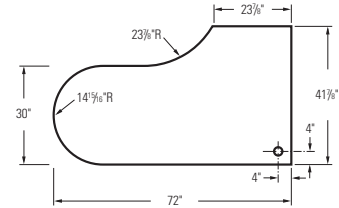

Right-hand model
 H105203RE shown

Boomerang Peninsula w/End Panel

72"W x 30/42"D x 29½"H, Right
 72"W x 42/30"D x 29½"H, Left

H105203RE
H105204LE

150
 150

7.0
 7.0

\$1423
\$1423

\$1481
\$1481

NOTES: For use in "U" or "L" configuration. Designed and sized to efficiently serve as both a computing and conferencing space. One cord management grommet in the top; cord routing notch in brace panel. Round support column is black.

ⓘ Not designed to be used freestanding. Accept field installable modesty panel H10528 (see page 281).

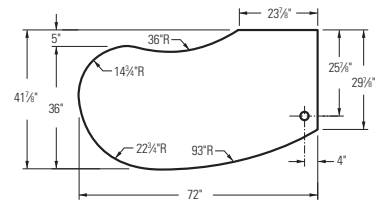
**NOTES:**

- Shared components shown on this page can be used with modular components shown on pages 256-273, full pedestal models shown on pages 274-275 and 3/4 pedestal models shown on pages 278-279.
- Jetty, boomerang, and rudder peninsulas are designed and sized to efficiently serve as both a computing and conferencing space.
- Peninsulas ship complete with end panel and black 3" diameter support column. For a silver support column option, please see model HPC191X on page 263 (ordered separately).
- Mobile pedestals shown on page 293 work well in a variety of configurations.
- Adjustable hex leveling glides allow floor-standing furniture to be easily leveled without lifting the unit; glides have 3/4" adjustable range.
- See pages 280-302 for shared components.

HOW TO SPECIFY**Select Model Number**

H 1 0 5 2 1 E .

Select Laminate Top and Chassis Color

See pages 247-248

N N .

Select Paint Color

P Black

P



10500 SERIES™

Shared Components & Accessories

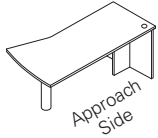

Approach Side

Model H105205RE shown



DESCRIPTION	MODEL	SHIP WEIGHT	CUBE	LIST PRICE BY LAMINATE GRADE	
				L1	L2
Rudder Peninsula with End Panel					
72"W x 30/38"D x 29½"H, Right	H105205RE	140	8.1	\$1392	\$1440
72"W x 30/38"D x 29½"H, Left	H105206LE	140	8.1	\$1392	\$1440

NOTES: Use for "U" or "L" configuration. One cord management grommet in top; cord routing notch in brace panel. 30"D along end panel. Round support column is black.

⚠ Not designed to be used freestanding.



Field Installable Laminate Modesty Panel for Peninsulas

50¼"W x ¾"Thick x 18"H

MODEL	SHIP WEIGHT	CUBE	L1	L2
H10528	25	1.3	\$238	\$249

NOTES: Center drawer model H1522 can be used in conjunction with the laminate modesty panel. Laminate modesty panel has a cord pass-through notch in top corner.

⚠ Not compatible with Peninsula models H10525R, H10526L, H10621 manufactured prior to 12/1/2001 or jetty models H105201R and H105202L manufactured prior to 10/24/2005.

SPECIFYING EXAMPLE: H10528.N



DESCRIPTION

Field Installable Modesty Panel, Frosted with Silver Frame

50¼"W x ¾"Thick x 18"H — for use on 72"W peninsulas

MODEL	SHIP WEIGHT	CUBE	LIST PRICE
HPC180G	33 Ⓞ	1.5	\$941

⚠ Center drawers not designed to be used with the frosted/silver modesty panel. Cord pass-through notch is not available on the Frosted/Silver model HPC180G. Notch is on laminate model H10528 only.

NOTES:

Panels

- Shared components shown on this page can be used with modular components shown on pages 256-273, full pedestal models shown on pages 274-275 and 3/4 pedestal models shown on pages 278-279.
- Jetty, boomerang and rudder peninsulas are designed and sized to efficiently serve as both a computing and conferencing space.
- Peninsulas ship complete with end panel and black 3" diameter support column. For a silver support column option, please see model HPC191X on page 263 (ordered separately).
- Mobile pedestals shown on page 293 work well in a variety of configurations.
- Adjustable hex leveling glides allow floor-standing furniture to be easily leveled without lifting the unit; glides have ¾" adjustable range.
- See pages 280-302 for shared components.

HOW TO SPECIFY

Select Model Number

H 1 0 5 2 0 5 R E

Select Laminate Top and Chassis Color

See pages 247-248

N N

Select Paint Color

P Black

P

10500 SERIES™

Shared Components & Accessories

GSA SIN 33721



Icon Legend on page 19



DESCRIPTION	MODEL	SHIP WEIGHT	CUBE	LIST PRICE BY LAMINATE GRADE	
				L1	L2
Bridge (Single Ped. Desk, Desk Shell, or Peninsula, to Corner Unit, Single Ped. Credenza or Credenza Shell)					
47"W x 24"D x 29½"H (Clear inside depth = 21⅞"D)	H10570	76	2.8	\$451	\$483
42"W x 24"D x 29½"H (Clear inside depth = 21⅞"D)	H10560	72	2.6	\$433	\$465
Bridge (for use with Corner or Extended Corner Units or Jetty or Boomerang Peninsulas)					
36"W x 24"D x 29½"H (Clear inside depth = 21⅞"D)	H105599	61	2.6	\$433	\$465
Bridge (for use with Corner or Extended Corner Units)					
30"W x 24"D x 29½"H (Clear inside depth = 21⅞"D)	H105598	50	1.9	\$433	\$465
NOTES: One cord grommet in top; one pass-through grommet in top center of modesty panel. Grommet can be replaced with optional Power Hub or Power/USB Hub for easy plug-and-play (see page 723). Kneespace of desk limited to 24¾"W if bridge is used with 66"W single pedestal desk.					
! Not designed to attach to corner units manufactured prior to 5/24/99.					
Bridge (Single Ped. Desk, Desk Shell, or Peninsula to Single Ped. Credenza or Credenza Shell)					
47"W x 20"D x 29½"H (Clear inside depth = 17⅞"D)	H105699	61	2.8	\$433	\$465
42"W x 20"D x 29½"H (Clear inside depth = 17⅞"D)	H105698	54	2.6	\$403	\$435
NOTES: One cord grommet in top; one pass-through grommet in top center of modesty panel.					
! Models H105699 and H105698 cannot be connected to corner or extended corner units or to the jetty or boomerang peninsulas, due to the 20"D "hook-up".					

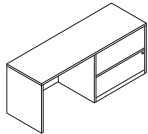

Credenza with 36" Lateral (with core removable lock)					
72"W x 24"D x 29½"H, Right (shown)	H10547R	248	35.6	\$1728	\$1791
72"W x 24"D x 29½"H, Left	H10548L	248	35.6	\$1728	\$1791
NOTES: One cord pass-through grommet in top center of modesty panel. Includes hangrails. Mechanical interlock inhibits the extension of more than one drawer at a time. Accepts optional stack-on storage model H10534 (page 284) or PC Organizer model H105388 (page 283).					
! Not designed to be used with 10500 Series™ 22¾"D modular or mobile pedestals. Modesty/back panel is inset 3½".					

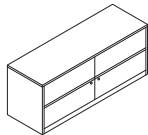

Credenza with two Lateral Files (4 locking drawers. Each core removable lock secures 2 drawers)					
72"W x 24"D x 29½"H	H105491	314	34.7	\$2494	\$2573
NOTES: Includes hangrails; mechanical interlock inhibits the extension of more than one drawer at a time. If side-by-side drawers are opened or closed simultaneously, one drawer may interfere with the other. Two locks (keyed alike). Accepts optional stack-on storage model H10534 (page 284) or PC Organizer model H105388 (page 283).					

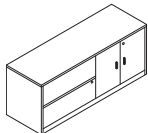

Credenza with Lateral File, left and Storage Cabinet, right (with core removable locks)					
72"W x 24"D x 29½"H	H105492	307	34.7	\$2181	\$2260
NOTES: Includes hangrails; mechanical interlock inhibits the extension of more than one drawer at a time. Storage cabinet locks and includes one adjustable interior shelf. Shelf adjusts in ¼" increments with a total range of 5"H. Two locks (keyed alike). Accepts optional stack-on storage model H10534 (page 284) or PC Organizer model H105388 (page 283).					

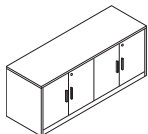

Credenza with Two Storage Cabinets (with core removable locks)					
72"W x 24"D x 29½"H	H105493	302	34.8	\$2033	\$2112
NOTES: Each storage cabinet has one interior shelf which adjusts in ¼" increments over a total range of 5". Each cabinet locks independently; locks are keyed alike. Accepts optional stack-on storage model H10534 (page 284) or PC Organizer model H105388 (page 283).					

NOTES:

- Shared components shown on this page can be used with modular components shown on pages 256-273, full pedestal models shown on pages 274-275, and 3/4 pedestal models shown on pages 278-279.
- Locking units equipped with interchangeable core removable locks.
- File drawers accept hanging folders in letter or legal size.
- Mobile pedestals shown on page 293 work well in a variety of configurations.
- Work Organizer models accept 3-ring binders and organizer model HTC052. See page 299.
- See stack-on storage and organizer options for desks, credenzas and returns, pages 283-285.
- See pages 280-302 for shared components.

! Keyed alike cores must be ordered separately — see model HF23B on page 699.

HOW TO SPECIFY

Select Model Number <input type="text" value="H10570"/>	Select Laminate Top and Chassis Color See pages 247-248 <input type="text" value="NN"/>
---	--



Icon Legend on page 19

10500 SERIES™

Shared Components & Accessories

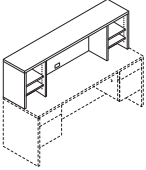
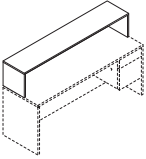
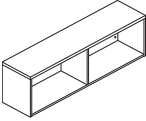
	DESCRIPTION	MODEL	SHIP WEIGHT	CUBE	LIST PRICE BY LAMINATE GRADE	
					L1	L2
	Stack-on PC Organizer 72"W x 14 ⁵ / ₈ "D x 22"H (for 72"W desks, credenzas and shells)	H105388	124	5.0	\$1006	\$1043
	NOTES: Features two adjustable paper management shelves both left and right; shelves are adjustable in 1/4" increments. Shelves keep papers, files, and books within easy reach from a seated position. One cord management grommet located in the bottom center of the back panel. Design allows 20 ³ / ₄ " of vertical clearance for computer equipment.					
	Work Organizer (shell only) 72"W x 14 ⁵ / ₈ "D x 14 ¹ / ₈ "H (for 72"W unit) 66"W x 14 ⁵ / ₈ "D x 14 ¹ / ₈ "H (for 66"W unit)	H10537 H10536	73 68	2.9 2.7	\$522 \$495	\$554 \$527
	NOTES: Space below counter accepts 3-ring binders and organizer model HTC0L52. See page 299.					
	Open Shared Storage 60"W x 14 ⁵ / ₈ "D x 16 ⁷ / ₈ "H 48"W x 14 ⁵ / ₈ "D x 16 ⁷ / ₈ "H	H105368 H105367	81 68	14.2 11.5	\$951 \$925	\$983 \$952
	NOTES: Attaches to laminate end panels with horizontally mounted interlocking brackets. Mounting applications include: 60"W — two 30"D desks/desk shells, 60"W — two 48"W (minimum) x 30"D rectangle worksurfaces supported by 28 ¹ / ₂ "H L-shaped end panels, 48"W — two 24"D credenzas/credenza shells, 48"W — two 24"D returns/return shells, 48"W — two 60"W (minimum) x 24"D rectangle worksurfaces supported by 28 ¹ / ₂ "H L-shaped end panels. Can also be positioned on the worksurface; double-sided tape included. Grain direction is vertical on top, back, end panels, and shelf. Ships fully assembled. Not designed for attachment to a worksurface supported by H-legs or O-legs. Inside dimensions for 60"W: each compartment 28 ³ / ₄ "W x 13 ¹ / ₂ "D x 15 ¹ / ₂ "H. Inside dimensions for 48"W: each compartment 22 ³ / ₄ "W x 13 ¹ / ₂ "D x 15 ¹ / ₂ "H.					

NOTES:

- Shared components shown on this page can be used with modular components shown on pages 256-273, full pedestal models shown on pages 274-275, and 3/4 pedestal models shown on pages 278-279.
 - Mobile pedestals shown on page 293 work well in a variety of configurations.
 - See stack-on storage and organizer options for desks, credenzas and returns, pages 283-285.
 - See pages 280-302 for shared components.
 - Locking units equipped with interchangeable core removable locks.
- ① Keyed alike cores must be ordered separately — see model HF23B on page 699.

HOW TO SPECIFY

Select Model Number	Select Laminate Top and Chassis Color See pages 247-248
<input type="text" value="H105388"/>	<input type="text" value="NN"/>

10500 SERIES™

Shared Components & Accessories

GSA SIN 33721



Icon Legend on page 19

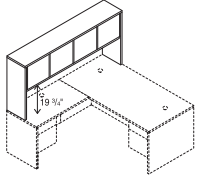

DESCRIPTION	MODEL	SHIP WEIGHT	CUBE	LIST PRICE BY LAMINATE GRADE	
				L1	L2
Stack-on Storage for an "L" Workstation 78"W x 14 ⁵ / ₈ "D x 37 ¹ / ₈ "H	H105327	198	17.6	\$1412	\$1480
Stack-on Storage for an "L" Workstation, Locking	H105327K	198	17.6	\$1516	\$1584

NOTES: Spans the total depth dimension of configurations comprised of: 48"W return or return shell attached to a 30"D single pedestal desk, desk shell or peninsula (78"D); 42"W return or return shell attached to a 36"D single pedestal desk or desk shell with a rectangle top, or to a peninsula (78"D). 42"W return or return shell attached to a 36" corner unit (78"D); or 42"W curved return attached to 36" curved corner unit (78"D). Use back enclosure model H105857 and tackboard model H90057. Use task light models HH870960 or HH870960CH (see page 714). For vertical paper manager model HLVPM1, see page 715.

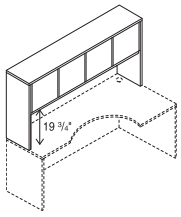

Stack-on Storage 72"W x 14 ⁵ / ₈ "D x 37 ¹ / ₈ "H, 4 doors (Use Task Light HH870960, see page 291)	H10534	185	17.1	\$1248	\$1290
66"W x 14 ⁵ / ₈ "D x 37 ¹ / ₈ "H, 4 doors (Use Task Light HH870960, see page 291)	H10533	175	15.3	\$1213	\$1271
60"W x 14 ⁵ / ₈ "D x 37 ¹ / ₈ "H, 4 doors (Use Task Light HH870960, see page 291)	H105324	164	14.0	\$1164	\$1222
48"W x 14 ⁵ / ₈ "D x 37 ¹ / ₈ "H, 3 doors (Use Task Light HH870942, see page 291)	H105323	141	11.3	\$1050	\$1098
42"W x 14 ⁵ / ₈ "D x 37 ¹ / ₈ "H, 2 doors (Use Task Light HH870942, see page 291)	H105322	135	4.0	\$859	\$907
36"W x 14 ⁵ / ₈ "D x 37 ¹ / ₈ "H, 2 doors (Use Task Light HH870930, see page 291)	H105321	102	3.5	\$812	\$844
Stack-on Storage, Locking					
72"W x 14 ⁵ / ₈ "D x 37 ¹ / ₈ "H, 4 doors (Use Task Light HH870960, see page 291)	H10534K	185	17.1	\$1352	\$1410
66"W x 14 ⁵ / ₈ "D x 37 ¹ / ₈ "H, 4 doors (Use Task Light HH870960, see page 291)	H10533K	175	15.3	\$1318	\$1376
60"W x 14 ⁵ / ₈ "D x 37 ¹ / ₈ "H, 4 doors (Use Task Light HH870960, see page 291)	H105324K	164	14.0	\$1268	\$1326
48"W x 14 ⁵ / ₈ "D x 37 ¹ / ₈ "H, 3 doors (Use Task Light HH870942, see page 291)	H105323K	141	11.3	\$1127	\$1175
42"W x 14 ⁵ / ₈ "D x 37 ¹ / ₈ "H, 2 doors (Use Task Light HH870942, see page 291)	H105322K	135	4.0	\$912	\$960
36"W x 14 ⁵ / ₈ "D x 37 ¹ / ₈ "H, 2 doors (Use Task Light HH870930, see page 291)	H105321K	102	3.5	\$864	\$906

NOTES: For use on respective desk, credenza or return widths. Model H10534 can be used for "L" configuration comprised of 30"D desk, desk shell or peninsula and 42"W return or return shell; or a 36"D desk, desk shell, peninsula, or corner unit and 36"W return shell. Model H105323K has one lock which secures two of the three doors. See vertical paper manager model HLVPM1 on page 715.

NOTES:

- Shared components shown on this page can be used with modular components shown on pages 256-273, full pedestal models shown on pages 274-275, and 3/4 pedestal models shown on pages 278-279.
- Rich woodgrain laminate and frosted doors with silver frames adds a contemporary mixed materials option to the 10500 Series™.
- Stack-on storage models are equipped with self-closing, adjustable hinged doors and valance to hide task light.
- See page 287 for stack-on storage back enclosures and tackboards, and page 291 for task lights.
- For work-in-process paper management tools, see pages 715-717.
- See pages 280-302 for shared components.
- **Removable lock core kit for locking stack-on storage is model HF27B. See page 699.**

HOW TO SPECIFYSelect
Model Number

H 1 0 5 3 2 7

Select
Laminate Top and Chassis Color

See pages 247-248

N N



10500 SERIES™

Shared Components & Accessories

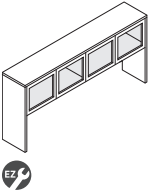
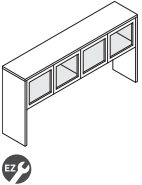
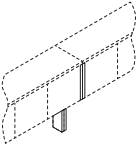
	DESCRIPTION	MODEL	SHIP WEIGHT	CUBE	LIST PRICE BY LAMINATE GRADE	
					L1	L2
	Stack-on Storage for an "L" Workstation, Frosted Doors with Silver Frame 78"W x 14 ⁵ / ₈ "D x 37 ¹ / ₈ "H	H105327G	198	17.3	\$2216	\$2269
	NOTES: Spans the total depth dimension of configurations comprised of: 48"W return or return shell attached to a 30"D single pedestal desk, desk shell or peninsula (78"D); 42"W return or return shell attached to a 36"D single pedestal desk or desk shell with a rectangle top, or to a peninsula (78"D); 42"W return or return shell attached to a 36" corner unit (78"D); 42"W curved return attached to 36" curved corner unit (78"D); or 36"W return shell attached to a jetty peninsula (78"D). Use back enclosure model H105857 and tackboard model H90057. Use task light models HH870960 or HH870960CH. For vertical paper manager model HLVP1, see page 715.					
	Stack-on Storage, Frosted Doors with Silver Frame 72"W x 14 ⁵ / ₈ "D x 37 ¹ / ₈ "H, 4 doors (Use Task Light HH870960, see page 291)	H10534G	185	15.9	\$2048	\$2090
	66"W x 14 ⁵ / ₈ "D x 37 ¹ / ₈ "H, 4 doors (Use Task Light HH870960, see page 291)	H10533G	175	14.6	\$2011	\$2053
	60"W x 14 ⁵ / ₈ "D x 37 ¹ / ₈ "H, 4 doors (Use Task Light HH870960, see page 291)	H105324G	164	13.3	\$1961	\$2003
	48"W x 14 ⁵ / ₈ "D x 37 ¹ / ₈ "H, 3 doors (Use Task Light HH870942, see page 291)	H105323G	141	10.8	\$1653	\$1685
	42"W x 14 ⁵ / ₈ "D x 37 ¹ / ₈ "H, 2 doors (Use Task Light HH870942, see page 291)	H105322G	135	3.6	\$1267	\$1299
	36"W x 14 ⁵ / ₈ "D x 37 ¹ / ₈ "H, 2 doors (Use Task Light HH870930, see page 291)	H105321G	102	3.1	\$1217	\$1244
	NOTES: For respective desk, credenza or return widths. Model 10534 can be used for "L" configuration comprised of a 42"W return or return shell attached to a 30"D single pedestal desk, desk shell or peninsula (72"); 36"W return shell attached to a 36"D single pedestal desk, desk shell or peninsula (72"); or 30"W return shell attached to a jetty peninsula (72"). Back enclosures, tackboards for use with back enclosures and task lights are available as options. See vertical paper manager model HLVP1 on page 715.					
	Stack-on Storage Clearance End Panel Kit 1 ¹ / ₈ "W x 4 ⁵ / ₈ -14 ⁵ / ₈ "D x 36"H	H105349	29	3.4	\$446	\$462
	Two field installable end panels (1-right; 1-left) for use in ganging two 10500 or Valido® Series stack-on storage units. Narrow design replaces the full 14 ⁵ / ₈ "D end panels to expand worksurface space. The narrow right end panel replaces the standard 14 ⁵ / ₈ "D right end panel on one stack-on storage unit, the narrow left end panel replaces the standard 14 ⁵ / ₈ "D left end panel on a separate, adjacent stack-on storage unit that is in linear alignment with the first unit. Kit includes: (2) narrow end panel supports; European-style fasteners; dowels; joint connector bolts with sleeve nuts (for ganging stack-on storage units).					
	NOTES: Can be used to connect up to two stack-on storage units in a line (requires 1 kit). Not available in two-tone laminate. SPECIFYING EXAMPLE: H105349.N					

NOTES:

- Shared components shown on this page can be used with modular components shown on pages 256-273, full pedestal models shown on pages 274-275, and 3/4 pedestal models shown on pages 278-279.
- Rich woodgrain laminate and frosted doors with silver frames adds a contemporary mixed materials option to the 10500 Series™.
- Stack-on storage models are equipped with self-closing, adjustable hinged doors and valance to hide task light.
- See page 287 for stack-on storage back enclosures and tackboards, and page 291 for task lights.
- For work-in-process paper management tools, see pages 715-717.
- See pages 280-302 for shared components.
- Removable lock core kit for locking stack-on storage is model HF27B. See page 699.**

HOW TO SPECIFY

Select Model Number H 1 0 5 3 2 7 G .	Select Laminate Top and Chassis Color See pages 247-248 N N
---	--

10500 SERIES™

Shared Components & Accessories

GSA SIN 33721

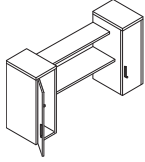

Icon Legend on page 19

**DESCRIPTION****Stack-on Cabinets with Open Shelves, Center**Overall measures: 72"W x 20"D x 37¹/₈"HCabinet measures: 13¹/₂"W x 19⁷/₈"D x 37¹/₈"H

NOTES: Contemporary, light scale design blends open and closed storage. Features two locking cabinets bridged by two open shelves. The clearance between the worksurface and underside of the lower shelf is 18³/₈". Top shelf is 45"W x 11"D, bottom shelf is 45"W x 14"D; space between the shelves is 12¹/₄". Some assembly required; cabinets are fully assembled; simple shelf attachment. For two-tone color combinations, the first color designator defines the top of the storage cabinet(s), the second designator defines the color of the cabinet vertical panels and the open (exterior) shelves.

MODEL	SHIP WEIGHT	CUBE	L1 LIST	L2 UPCHARGES	
				CHASSIS	SHELF
H105319	218	20.3	\$2175	\$63	\$21

NOTES:

- Stack-on Cabinets with Open Shelves, Center is sized to fit on 72" desk, credenza, return, or desk with return worksurfaces.
- Easy-care, scratch-, spill- and stain-resistant laminate over 1/8" solid core high-performance particleboard.
- Cabinets have three shelves, two are adjustable.
- Removable lock core kit for the cabinet models above is HF23B. See page 699.
- Back of cabinet door has a convenient double coat hook; the lower peg is for jackets and lighter items, the upper peg for heavier coats and bags.
- Open shelves display books, photos, and mementos, shelves are fixed height; top shelf is 3/4" thick, lower shelf is 1/8".
- Task light can be attached to underside of the bottom shelf.

HOW TO SPECIFY

Select
Model Number

H 1 0 5 3 1 9 .

Select
Cabinet Top and Chassis Color

See pages 247-248

H H .

Select
Open Shelf Laminate

See pages 247-248

H



10500 SERIES™

Shared Components & Accessories

DESCRIPTION	MODEL	SHIP WEIGHT	CUBE	LIST PRICE BY LAMINATE GRADE	
				L1	L2
 <p>18 5/8"H</p> <p>Not available in two-tone laminate</p> <p>Back Enclosure for Stack-on Storage</p> <p>75 3/4"W - for 78"W model #H105327/H105327K/H105327G</p> <p>69 3/4"W - for 72"W model #H10534/H10534K/H10534G</p> <p>63 3/4"W - for 66"W model #H10533/H10533K/H10533G</p> <p>57 3/4"W - for 60"W model #H105324/H105324K/H105324G</p> <p>45 3/4"W - for 48"W model #H105323/H105323K/H105323G</p> <p>39 3/4"W - for 42"W model #H105322/H105322K/H105322G</p> <p>33 3/4"W - for 36"W model #H105321/H105321K/H105321G</p>	H105857	39	1.4	\$321	\$332
	H105856 ⓘ	33	1.3	\$295	\$306
	H105855	31	1.3	\$275	\$286
	H105854	29	1.3	\$262	\$273
	H105853	23	0.9	\$262	\$273
	H105852	21	0.9	\$250	\$261
	H105851	18	0.9	\$237	\$248

NOTES: Non-tackable.

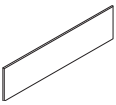
DESCRIPTION	MODEL	COM	SHIP WEIGHT	CUBE	LIST PRICE
 <p>18"H</p> <p>Tackboards for use with Stack-on Back Enclosures (Back Enclosures must be ordered separately.)</p> <p>75"W - for 78"W model #H105327 Hutch with #H105857 Enclosure</p> <p>68 3/4"W - for 72"W model #H10534 Hutch with #H105856 Enclosure</p> <p>62 3/4"W - for 66"W model #H10533 Hutch with #H105855 Enclosure</p> <p>56 3/4"W - for 60"W model #H105324 Hutch with #H105854 Enclosure</p> <p>44 3/4"W - for 48"W model #H105323 Hutch with #H105853 Enclosure</p> <p>39"W - for 42"W model #H105322 Hutch with #H105852 Enclosure</p> <p>33"W - for 36"W model #H105321 Hutch with #H105851 Enclosure</p> <p>26 3/4"W</p>	H90057	3.0	13	3.2	\$427
	H90056	2.0	12	2.7	\$405
	H90055	2.0	11	2.5	\$385
	H90054	2.0	10	2.2	\$339
	H90053	2.0	8	1.8	\$325
	H90052	2.0	7	1.6	\$300
	H90051	1.0	6	1.4	\$264
	H90050	1.0	5	1.2	\$264

NOTES: Specify fabric, see pages 25-26. Upcharges may apply to premium fabric grades.

ⓘ Disperse (DISP) fabric not available on sizes wider than 60". Analog (ANLG) and Exchange (EXG) not available on sizes wider than 60".

SPECIFYING EXAMPLE: H90057.APN15

NOTES:

- When connected to the stack-on storage unit, back enclosure features full-width 1 1/8" slot at the bottom to facilitate routing cords and reaching wall electrical outlets.
- Tackboard is sized 3/4" narrower than stack-on storage back enclosure, allowing 3/8" on each side to route task light cord.
- Tackboard includes adhesive tape to secure to back enclosure and hardware for wall attachment.
- See pages 280-302 for shared components.

HOW TO SPECIFY

Select Model Number <input type="text" value="H105857"/>	Select Laminate See pages 247-248 <input type="text" value="N"/>
--	---

10500 SERIES™

Shared Components & Accessories

GSA SIN 33721



Icon Legend on page 19

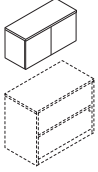

DESCRIPTION	MODEL	SHIP		LIST PRICE BY LAMINATE GRADE	
		WEIGHT	CUBE	L1	L2
Wall Mounted Storage Cabinet 48"W x 14 ⁵ / ₈ "D x 17 ¹ / ₂ "H, 3 doors (Use task light model HH870942, see page 291)	H105383	114	13.2	\$1084	\$1121
42"W x 14 ⁵ / ₈ "D x 17 ¹ / ₂ "H, 2 doors (Use task light model HH870942, see page 291)	H105382	97	11.7	\$1014	\$1051
36"W x 14 ⁵ / ₈ "D x 17 ¹ / ₂ "H, 2 doors (Use task light model HH870930, see page 291)	H105381	87	10.2	\$924	\$961
30"W x 14 ⁵ / ₈ "D x 17 ¹ / ₂ "H, 2 doors (Use task light model HH870930, see page 291)	H105380	73	8.7	\$862	\$899
Wall Mounted Storage Cabinet, Locking 48"W x 14 ⁵ / ₈ "D x 17 ¹ / ₂ "H, 3 doors (Use task light model HH870942, see page 291)	H105383K	114	13.2	\$1161	\$1198
42"W x 14 ⁵ / ₈ "D x 17 ¹ / ₂ "H, 2 doors (Use task light model HH870942, see page 291)	H105382K	97	11.7	\$1065	\$1102
36"W x 14 ⁵ / ₈ "D x 17 ¹ / ₂ "H, 2 doors (Use task light model HH870930, see page 291)	H105381K	87	10.2	\$977	\$1014
30"W x 14 ⁵ / ₈ "D x 17 ¹ / ₂ "H, 2 doors (Use task light model HH870930, see page 291)	H105380K	73	8.7	\$913	\$950

NOTES: Horizontal interlocking rails are included; due to varying types of walls, installers are responsible for selecting and supplying the appropriate fasteners. Tackboard widths differ slightly from wall mounted storage cabinet widths. For applications where multiple wall mounted storage cabinets are placed side-by-side, the preferred tackboard solution may be to utilize a larger tackboard size. For wall mounted storage cabinets with frosted doors, see page 291.

SPECIFYING EXAMPLE: H105380.NN
If Specifying with Lock Option: H105380K.NN

NOTES:

- Tackboard is sized ³/₄" narrower than stack-on storage back enclosure, allowing ³/₈" on each side to route task light cord.
- Wall attachment methodology: horizontally mounted, interlocking brackets.
- Wall mounted storage cabinet door design overlaps end panels so that when multiple units are placed side-by-side they appear as one continuous unit.
- Wall mounted storage cabinets available with laminate doors, locking laminate doors or frosted doors.
- Removable lock core kit for locking stack-on and wall mounted storage is model HF27B. See page 699.
- See pages 280-302 for shared components.

- ! Wall mounted storage cabinet attachment requires individual cabinets be secured by a minimum of two wall mounting locations/studs.
- ! Wall mounted storage cabinets are designed for interior and perimeter walls that are constructed with wood or metal studs.
- ! The HON Company is not responsible for any liabilities resulting from wall mounted storage cabinets that are not properly installed.

HOW TO SPECIFYSelect
Model NumberSelect
Laminate Top and Chassis Color

See pages 247-248

H 1 0 5 3 8 0 K . N N



10500 SERIES™

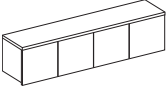
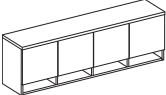
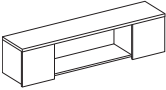
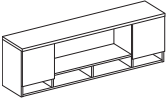

Shared Components & Accessories

	DESCRIPTION	MODEL	SHIP WEIGHT	CUBE	L1 LIST	L2 UPCHARGES	
						CHASSIS	FRONTS
	Wall Mounted Hutch						
	66"W x 14 ⁵ / ₈ "D x 15"H, 4 doors	H105WMH66	120	16.1	\$1583	\$32	\$32
	48"W x 14 ⁵ / ₈ "D x 15"H, 3 doors	H105WMH48	97	12.6	\$1134	\$27	\$32
	42"W x 14 ⁵ / ₈ "D x 15"H, 2 doors	H105WMH42	77	10.7	\$1063	\$27	\$21
	36"W x 14 ⁵ / ₈ "D x 15"H, 2 doors	H105WMH36	67	9.8	\$974	\$27	\$21
	30"W x 14 ⁵ / ₈ "D x 15"H, 2 doors	H105WMH30	57	8.3	\$911	\$27	\$21
	Wall Mounted Cubby Hutch						
	66"W x 14 ⁵ / ₈ "D x 20"H, 4 doors	H105WMH66C	155	19.6	\$1583	\$32	\$32
	48"W x 14 ⁵ / ₈ "D x 20"H, 3 doors	H105WMH48C	128	15.2	\$1134	\$27	\$32
	42"W x 14 ⁵ / ₈ "D x 20"H, 2 doors	H105WMH42C	114	13.0	\$1063	\$27	\$21
	36"W x 14 ⁵ / ₈ "D x 20"H, 2 doors	H105WMH36C	89	11.8	\$974	\$27	\$21
	30"W x 14 ⁵ / ₈ "D x 20"H, 2 doors	H105WMH30C	76	10.0	\$911	\$27	\$21
	Wall Mounted Open Hutch						
	72"W x 14 ⁵ / ₈ "D x 15"H, 2 Doors	H105WMH72P	119	17.5	\$1728	\$37	\$37
	66"W x 14 ⁵ / ₈ "D x 15"H, 2 Doors	H105WMH66P	111	16.1	\$1583	\$32	\$32
	60"W x 14 ⁵ / ₈ "D x 15"H, 2 Doors	H105WMH60P	104	14.7	\$1434	\$32	\$32
	48"W x 14 ⁵ / ₈ "D x 15"H, 2 Doors	H105WMH48P	89	12.6	\$1284	\$27	\$32
	Wall Mounted Open Hutch with Cubby						
	72"W x 14 ⁵ / ₈ "D x 20"H, 2 Doors	H105WMH72PC	162	21.3	\$1728	\$37	\$37
	66"W x 14 ⁵ / ₈ "D x 20"H, 2 Doors	H105WMH66PC	151	19.6	\$1583	\$32	\$32
	60"W x 14 ⁵ / ₈ "D x 20"H, 2 Doors	H105WMH60PC	140	14.7	\$1434	\$32	\$32
	48"W x 14 ⁵ / ₈ "D x 20"H, 2 Doors	H105WMH48PC	117	12.6	\$1284	\$27	\$32

NOTES:

- Wall attachment methodology: horizontally mounted, interlocking brackets.
 - Wall mounted storage cabinet door design overlaps end panels so that when multiple units are placed side-by-side they appear as one continuous unit.
 - Laminate doors are non-locking.
 - Horizontal interlocking rails are included; due to varying types of walls, installers are responsible for selecting and supplying the appropriate fasteners. Tackboard widths differ slightly from wall mounted storage cabinet widths. For applications where multiple wall mounted storage cabinets are placed side-by-side, the preferred tackboard solution may be to utilize a larger tackboard size.
- ⓘ Wall mounted storage cabinet attachment requires individual cabinets be secured by a minimum of two wall mounting locations/studs.
- ⓘ Wall mounted storage cabinets are designed for interior and perimeter walls that are constructed with wood or metal studs.
- ⓘ The HON Company is not responsible for any liabilities resulting from wall mounted storage cabinets that are not properly installed.

HOW TO SPECIFY

Select Model Number 	Select Laminate Top and Chassis Color See page 247 	Select Door Front Laminate See page 247 
---	---	--

10500 SERIES™

Shared Components & Accessories

GSA SIN 33721

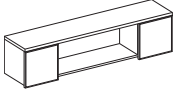
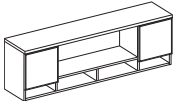

Icon Legend on page 19

	DESCRIPTION	MODEL	SHIP		LIST PRICE BY LAMINATE GRADE	
			WEIGHT	CUBE	L1	L2
	Wall Mounted Open Hutch, Glass Doors					
	72"W x 14 ⁵ / ₈ "D x 15"H, 2 Doors	H105WMH72PG	162	17.5	\$2343	\$2380
	66"W x 14 ⁵ / ₈ "D x 15"H, 2 Doors	H105WMH66PG	115	16.1	\$2198	\$2230
	60"W x 14 ⁵ / ₈ "D x 15"H, 2 Doors	H105WMH60PG	108	14.7	\$2050	\$2082
	48"W x 14 ⁵ / ₈ "D x 15"H, 2 Doors	H105WMH48PG	93	12.6	\$1901	\$1933
	Wall Mounted Open Hutch with Cubby, Glass Doors					
	72"W x 14 ⁵ / ₈ "D x 20"H, 2 Doors	H105WMH72PCG	166	21.3	\$2343	\$2380
	66"W x 14 ⁵ / ₈ "D x 20"H, 2 Doors	H105WMH66PCG	155	19.6	\$2198	\$2230
	60"W x 14 ⁵ / ₈ "D x 20"H, 2 Doors	H105WMH60PCG	144	17.9	\$2050	\$2082
	48"W x 14 ⁵ / ₈ "D x 20"H, 2 Doors	H105WMH48PCG	121	15.2	\$1901	\$1933

NOTES:

- Wall attachment methodology: horizontally mounted, interlocking brackets.
 - Wall mounted storage cabinet door design overlaps end panels so that when multiple units are placed side-by-side they appear as one continuous unit.
 - Rich woodgrain laminate and frosted doors with silver frames adds a contemporary mixed materials option to the 10500 Series™.
 - Horizontal interlocking rails are included; due to varying types of walls, installers are responsible for selecting and supplying the appropriate fasteners. Tackboard widths differ slightly from wall mounted storage cabinet widths. For applications where multiple wall mounted storage cabinets are placed side-by-side, the preferred tackboard solution may be to utilize a larger tackboard size.
- ⚠ Wall mounted storage cabinet attachment requires individual cabinets be secured by a minimum of two wall mounting locations/studs.
 - ⚠ Wall mounted storage cabinets are designed for interior and perimeter walls that are constructed with wood or metal studs.
 - ⚠ The HON Company is not responsible for any liabilities resulting from wall mounted storage cabinets that are not properly installed.

HOW TO SPECIFY

Select
Model Number

H 1 0 5 W M H 6 6 P G .

Select
Laminate Top and Chassis Color

See page 247

N N



Icon Legend on page 19

10500 SERIES™ Storage

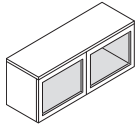

DESCRIPTION	MODEL	SHIP WEIGHT	CUBE	LIST PRICE BY LAMINATE GRADE	
				L1	L2
Wall Mounted Storage Cabinet, Frosted Doors with Silver Frame					
48"W x 14 ⁵ / ₈ "D x 17 ¹ / ₂ "H	H105383G	114.0	13.9	\$1689	\$1716
42"W x 14 ⁵ / ₈ "D x 17 ¹ / ₂ "H	H105382G	97.0	12.3	\$1425	\$1452
36"W x 14 ⁵ / ₈ "D x 17 ¹ / ₂ "H	H105381G	87.0	10.7	\$1332	\$1359
30"W x 14 ⁵ / ₈ "D x 17 ¹ / ₂ "H	H105380G	73.0	9.1	\$1268	\$1295

NOTES: Door design overlaps end panels so that when multiple units are placed side-by-side they appear as one continuous unit. Product placement can be aligned to match the height of storage cabinets, wardrobes and towers. Equipped with self-closing, adjustable side-hinged doors. The 30", 36", and 42"W units have two doors; the 48"W has three doors. Frosted door units do not have a lock option. Wall attachment methodology: horizontally mounted, interlocking brackets.

Tackboard widths differ slightly from wall mounted storage cabinet widths. For applications where multiple wall mounted storage cabinets are placed side-by-side, the preferred tackboard width may be to utilize a larger tackboard size.

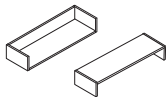

Not available in two-tone laminate



DESCRIPTION	MODEL	SHIP WEIGHT	CUBE	LIST PRICE BY LAMINATE GRADE	
				L1	L2
Wall Mounted Open Shelf					
48"W x 9 ⁷ / ₈ "D x 4 ³ / ₄ "H	H105363	18.0	1.2	\$383	\$404
42"W x 9 ⁷ / ₈ "D x 4 ³ / ₄ "H	H105362	16.0	0.8	\$347	\$368
36"W x 9 ⁷ / ₈ "D x 4 ³ / ₄ "H	H105361	14.0	0.8	\$315	\$331
30"W x 9 ⁷ / ₈ "D x 4 ³ / ₄ "H	H105360	12.0	0.8	\$299	\$315

NOTES: Ideal for books, photographs, and mementos up to 9"D. Two attachment orientation options, open ended shelf or shelf with book ends. Available in woodgrain or solid color laminates only. No patterns. No two-tone combinations. Simple assembly.

SPECIFYING EXAMPLE: H105363.N

NOTES:

- Easy-care, scratch-, spill- and stain-resistant laminate over solid core high-performance particleboard.
- Stacked paper management (model HLVPM2), which is 32¹/₂"W, is compatible with the 30"W and 36"W wall mounted storage cabinets.
- ! Wall mounted storage cabinet attachment requires individual cabinets be secured by a minimum of two wall mounting locations/studs.
- ! Wall mounted storage cabinets are designed for interior and perimeter walls that are constructed with wood or metal studs.
- ! The HON Company is not responsible for any liabilities resulting from wall mounted storage cabinets that are not properly installed.



OPEN MARKET

DESCRIPTION	MODEL	SHIP WEIGHT	CUBE	LIST PRICE
LED Task Lights				
31" LED Light with Power Supply (Single)	HLED31AS	1.5 Ⓞ	0.09	\$723
17" LED Light with Power Supply (Single)	HLED17AS	1.2 Ⓞ	0.05	\$540
31" LED Light with Power Supply for Daisy-chain (Starter)	HLED31A	1.4 Ⓞ	0.09	\$793
17" LED Light with Power Supply for Daisy-chain (Starter)	HLED17A	1.0 Ⓞ	0.05	\$591
31" LED Light with 8" Jumper Cord for Daisy-chain (Follower)	HLED31AUO	1.0 Ⓞ	0.05	\$646
17" LED Light with 8" Jumper Cord for Daisy-chain (Follower)	HLED17AUO	1.0 Ⓞ	0.03	\$484
Undercabinet Occupancy Sensor with 1" End to End Connector	HLEDOSA	0.2 Ⓞ	0.01	\$118

NOTES: To use the daisy chain application, must start with model HLED17A or HLED31A. No finish specification required. Attaches magnetically to underside of overhead storage, or attaches with provided screws or double-sided tape. Occupancy sensor attaches to a single or starter LED light and will automatically turn the light off after no motion is detected for 30 minutes. Just like all the LED light models, the occupancy sensor features a soft-touch on/off switch. LED task lights have a lifetime of 50,000 hours and have a dimmer feature that allows the user to adjust the amount of light output.

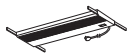

OPEN MARKET

Recessed Task Light , 46 ¹ / ₂ "W x 3 ¹ / ₈ "D, for Models H105327, H10534, H10533 and H105324	HH870960	12.0 Ⓞ	1.1	\$348
Recessed Task Light , 34 ⁵ / ₈ "W x 3 ¹ / ₈ "D, for Models H105323, H105322, H105382 and H105383	HH870942 Ⓞ	10.0 Ⓞ	0.9	\$321
Recessed Task Light , 22 ⁷ / ₈ "W x 3 ¹ / ₈ "D, for Models H105321, H105380 and H105381	HH870930 Ⓞ	7.0 Ⓞ	0.6	\$297

NOTES: For additional information see page 714.

HOW TO SPECIFY

<p>Select Model Number</p> <p>H 1 0 5 3 8 3 G .</p>	<p>Select Laminate Top and Chassis Color</p> <p>See pages 247-248</p> <p>H H</p>
---	--

10500 SERIES™ Shared Components & Accessories

GSA SIN 33721



Icon Legend on page 19

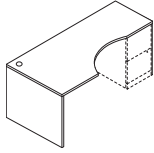

Right-hand model
H105815R shown



DESCRIPTION

Extended Corner Unit

24" W x 36" D x 72" W x 24" D x 29½" H, Right (shown)
24" D x 72" W x 36" D x 24" W x 29½" H, Left

MODEL

H105815R
H105816L

SHIP WEIGHT CUBE

184 7.0
184 7.0

LIST PRICE BY LAMINATE GRADE

L1 L2

\$1327 \$1375
\$1327 \$1375

NOTES: Intended for use with returns or bridges. Can be used freestanding. The 17" user side dimension is designed to accommodate 10500 Series™ modular or mobile pedestals up to 15¾"W. One grommet in top and one cord pass-through grommet in modesty panel. See pages 283-287 for optional stack-ons and tackboards. Extended corner units (H105815R and H105816L) can be used with 36"W return shell (H105680) to achieve a 6' x 6' layout.

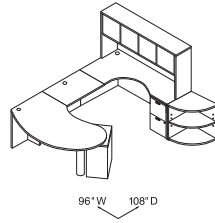
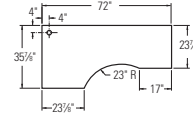

H105204L
H105102
H105598
H105815R
H105104
H10534
H105520

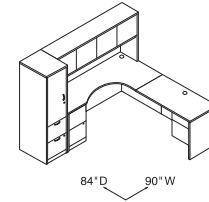

H105298L
H105816L
H10504
H10534
H10515R

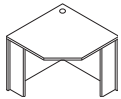

Corner Unit

24" x 36" x 36" x 24" x 29½"H

H105811

130 3.1

\$956 \$993

NOTES: Intended for use with 24"D x 29½"H returns or bridges. Can be used freestanding. 36" corner unit (H105811) can be used with two 36"W return shells (H105680) to achieve a 6' x 6' layout.

⚠ Not designed to attach to returns or bridges manufactured prior to 5/24/99.

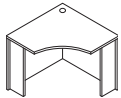
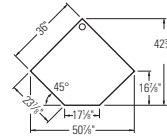

Curved Corner Unit

18" x 36" x 36" x 18" x 29½"H

H105810

128 5.4

\$956 \$993

NOTES: Can be used freestanding.

⚠ Designed to be used with curved returns only.

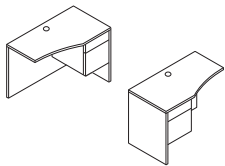

Curved Return — box/file

42" W x 18-24" D x 29½" H, Right
42" W x 24-18" D x 29½" H, Left

H105817R
H105818L

134 20.5
134 20.5

\$1034 \$1076
\$1034 \$1076

NOTES: Pedestal locks. One cord grommet in top; one pass-through grommet in top center of modesty panel. H105327 stack-on storage (78"W) can be used to span corner unit and return. H105322 stack-on storage (42"W) can be used on return. See page 284.

⚠ Designed to be used with curved corner unit only.
⚠ Not designed to be used freestanding.

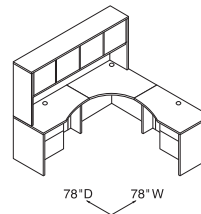

H105818L
H105810
H105327
H105817R

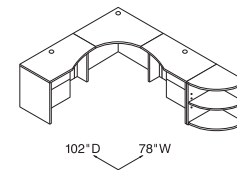

H105818
H105810
H105817R
H105520

NOTES:

- Shared components shown on this page can be used with modular components shown on pages 256-273, full pedestal models shown on pages 274-275, and 3/4 pedestal models shown on pages 278-279.
- Mobile pedestals, shown on page 293, work well in a variety of configurations.
- End cap bookshelf units are ideal for books and personal items — see page 298.
- For work-in-process paper management tools, see pages 715-717.
- For 10500 Series™ matching occasional tables, use the H80191, H80192, and H80193 on page 301.
- For conference table options, see the Preside® table tops and bases in the Tables section in the 2023 Shared Spaces Pricer.
- See pages 280-302 for shared components.

HOW TO SPECIFY

<p>Select Model Number</p> <p>H 1 0 5 8 1 5 R .</p>	<p>Select Laminate Top and Chassis Color</p> <p>See pages 247-248</p> <p>N N</p>
---	--



10500 SERIES™

Shared Components & Accessories

	DESCRIPTION	MODEL	SHIP WEIGHT	CUBE	LIST PRICE BY LAMINATE GRADE	
					L1	L2
	Box/Box/File Mobile Pedestal (with core removable lock) 15 ³ / ₄ "W x 22 ³ / ₄ "D x 28 ³ / ₈ "H — use freestanding or under 24"D, 30"D and 36"D modular shells NOTES: Top box drawer does not lock. File drawer includes hangrails.	H105102	121	8.5	\$1055	\$1097
	File/File Mobile Pedestal (with core removable lock) 15 ³ / ₄ "W x 22 ³ / ₄ "D x 28 ³ / ₈ "H — use freestanding or under 24"D, 30"D and 36"D modular shells NOTES: File drawers include hangrails.	H105104	121	8.4	\$1055	\$1097
	Box/File Mobile Pedestal (with core removable lock) 15 ³ / ₄ "W x 18 ⁷ / ₈ "D x 21 ⁷ / ₈ "H — use freestanding or under 20"D, 24"D, 30"D and 36"D modular shells	H105106	65	5.8	\$882	\$914
	Shelf/Box/File Mobile Pedestal (with core removable lock) 15 ³ / ₄ "W x 18 ⁷ / ₈ "D x 28 ³ / ₈ "H — use freestanding or under 20"D, 24"D, 30"D and 36"D modular shells NOTES: Interior dimensions of the open storage area of the Shelf/Box/File model are 14 ¹ / ₈ "W x 16 ³ / ₄ "D x 6 ⁵ / ₈ "H.	H105109	73	7.3	\$972	\$1014
	Lateral File (with core removable lock) 36"W x 20"D x 59 ¹ / ₈ "H — four drawer 36"W x 20"D x 45 ¹ / ₂ "H — three drawer 36"W x 24"D x 29 ¹ / ₂ "H — two drawer 36"W x 20"D x 29 ¹ / ₂ "H — two drawer NOTES: Includes hangrails, mechanical interlock and in H10563 and H105690, a counterweight. Stack-on storage (H105321) and bookcase hutch (H105292) can be used with H10563 and H105690. Interlock inhibits the extension of more than one drawer from opening at a time. Model H105690 aligns with 24"D credenzas and returns.	H10516 ☉ H10517 H105690 H10563 ☉	305 240 191 170	31.0 23.2 17.6 15.6	\$2598 \$1972 \$1264 \$1202	\$2672 \$2040 \$1322 \$1255

NOTES:

- For additional components that can be shared with 10500 Series™, see pages 280-302.
- Mobile pedestals feature clean styling with hidden casters. Versatile designs roll easily and work well in a variety of configurations. Can be used freestanding, under modular shells, or with 10500 Series™ component worksurfaces and supports.
- 24"D lateral file, storage cabinet, and bookcase models align evenly with credenzas and returns to provide linear layout continuity.
- At 45¹/₂"H, the three-drawer lateral file can be used as a standing-height worksurface or to support office equipment.
- Drawers operate on full extension, ball-bearing suspensions to ensure smooth, quiet, long-lasting operation.
- File drawer design includes integrated hangrails for side-to-side letter or legal filing; and front-to-back for letter filing.
- Mobile printer/fax cart shown on page 273 is ideal for limited space.

HOW TO SPECIFY

Select Model Number <input type="text" value="H105102"/>	Select Laminate Top and Chassis Color See pages 247-248 <input type="text" value="NN"/>
--	--



10500 SERIES™

Shared Components & Accessories

GSA SIN 33721

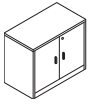
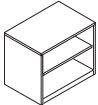
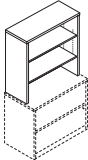

Icon Legend on page 19

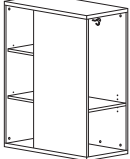
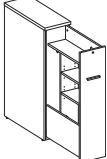
	DESCRIPTION	MODEL	SHIP WEIGHT	CUBE	LIST PRICE BY LAMINATE GRADE	
					L1	L2
	Storage Cabinet with Doors (with core removable lock)					
	36"W x 24"D x 29½"H 36"W x 20"D x 29½"H	H105290 H105291	168 147	17.6 15.0	\$1145 \$964	\$1203 \$1017
	NOTES: Includes one adjustable shelf. Shelf adjusts in ¼" increments with a total range of 5". Stack-on storage (H105321), and bookcase hutch (H105292) can be used with H105291 or H105290. Model H105290 aligns with 24"D credenzas and returns.					
	Bookcase					
	36"W x 24"D x 29½"H, 2-Shelf, 1-Adjustable	H105531	102	18.4	\$936	\$952
	NOTES: Adjustable shelf is 22"D and adjusts in ¼" increments, with a total range of 5". 24" depth aligns evenly with 24"D credenzas, credenza shells, returns, return shells, and wardrobe/storage cabinets to provide linear layout continuity. Adjustable leveling glides. Accommodates the 36"W stack-on storage or bookcase hutch. Ships fully assembled.					
	Bookcase Hutch (for use with lateral file models H10563/H105690, storage cabinet models H105291/H105290, and bookcase model H105531)					
	36"W x 14⅝"D x 37⅞"H	H105292	103	3.6	\$706	\$722
	NOTES: Cord pass-through gap behind shelves and a 1⅝"H full-width cord management slot at the bottom of the back panel. Two shelves are adjustable in ¼" increments with a total range of 17½".					
 	Multi-Use Stack-On Storage					
	36"W x 18"D x 45⅝"H	H105310	142	21.9	\$1307	\$1344
	NOTES: Non-handed. Design features user's side bookcase and end access mixed storage compartment. Three fixed bookcase compartments, each 12"W x 13¾"H. Versatile mixed storage area includes two coat hooks and two shelves; one adjustable in ¼"H increments with a total range of 5" (shelf count includes bottom of the unit). For use on worksurfaces 36" or wider and 18" or deeper. Total height, in combination with low credenza, is 66⅝". Accepts markerboard models HLSL1536SOMB or HLSL1530SOMB (sold separately). Ships fully assembled.					
	DESCRIPTION	MODEL	SHIP WEIGHT	CUBE	L1 LIST	L2 UPCHARGES CHASSIS FRONTS
	Slide Out Tower					
	12"W x 30"D x 50"H, Right	H105ST123050R	215	13.8	\$3700	\$63 \$21
	12"W x 30"D x 50"H, Left	H105ST123050L	215	13.8	\$3700	\$63 \$21
	12"W x 24"D x 50"H, Right	H105ST122450R	182	11.4	\$3337	\$53 \$21
	12"W x 24"D x 50"H, Left	H105ST122450L	182	11.4	\$3337	\$53 \$21
	NOTES: Wardrobe space contains one coat hook. Storage space includes three shelves; two are adjustable in 2½" increments. Door access left or right models available. Equipped with HON "One Key" interchangeable core removable locks. Standard with Black linear pull.					

NOTES:

- For additional components that can be shared with 10500 Series™, see pages 280-302.
- Versatile mobile pedestals roll easily and work well in a variety of configurations. Can be used freestanding, under modular shells, or with 10500 Series™ component worksurfaces and supports.
- 24"D lateral file, storage cabinet, and bookcase models align evenly with credenzas and returns to provide linear layout continuity.
- Mobile printer/fax cart shown on page 273 is ideal for limited space.

HOW TO SPECIFY

Select Model Number H 1 0 5 2 9 1 .	Select Laminate Top and Chassis Color See pages 247-248 N N			
Select Model Number H 1 0 5 S T 1 2 3 0 5 0 R .	Select Laminate Top and Chassis Color See page 247 N N .	Select Door Front Laminate See page 247 N .	Select Pull and Color L Linear P Black L P .	Select Lock Option Not available on Open Credenzas L Lock L



10500 SERIES™

Shared Components & Accessories

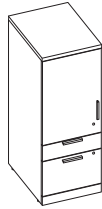
**DESCRIPTION****Storage Wardrobe**

24"W x 24"D x 50"H, Right
 24"W x 24"D x 50"H, Left
 24"W x 20"D x 50"H, Right
 24"W x 20"D x 50"H, Left
 18"W x 24"D x 50"H, Right
 18"W x 24"D x 50"H, Left
 18"W x 20"D x 50"H, Right
 18"W x 20"D x 50"H, Left

MODEL

H105LT242450CBFR
H105LT242450CBFL
H105LT242050CBFR
H105LT242050CBFL
H105LT182450CBFR
H105LT182450CBFL
H105LT182050CBFR
H105LT182050CBFL

SHIP WEIGHT

202
 202
 178
 178
 168
 168
 147
 147

CUBE

21.3
 21.3
 17.9
 17.9
 16.2
 16.2
 13.7
 13.7

L1 LIST

\$2529
\$2529
\$2467
\$2467
\$2406
\$2406
\$2132
\$2132

L2 UPCHARGES

\$63
\$63
\$53
\$53
\$53
\$53
\$48
\$48

\$37
\$37
\$37
\$37
\$32
\$32
\$32
\$32

NOTES: Spacious design includes a wardrobe closet, storage cabinet, one box drawer, and one file drawer in one compact unit. Wardrobe closet contains a coat hook. Storage cabinet includes two shelves, one is adjustable in 2½" increments. Door hinged left or right models available. Box and file drawers operate on ball-bearing suspensions with full extension. File drawers have high sides to accept hanging folders in letter or legal size. Drawers standard with hangrails. Equipped with HON "One Key" interchangeable core removable locks. Upper lock secures storage cabinet and wardrobe closet doors; lower lock secures file drawers.

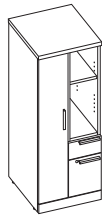
**Open Wardrobe**

24"W x 24"D x 50"H, Right
 24"W x 24"D x 50"H, Left
 24"W x 20"D x 50"H, Right
 24"W x 20"D x 50"H, Left
 18"W x 24"D x 50"H, Right
 18"W x 24"D x 50"H, Left
 18"W x 20"D x 50"H, Right
 18"W x 20"D x 50"H, Left

H105LT242450BFR
H105LT242450BFL
H105LT242050BFR
H105LT242050BFL
H105LT182450BFR
H105LT182450BFL
H105LT182050BFR
H105LT182050BFL

190
 190
 167
 167
 161
 161
 141
 141

21.3
 21.3
 17.9
 17.9
 16.2
 16.2
 13.7
 13.7

\$2467
\$2467
\$2221
\$2221
\$2343
\$2343
\$2071
\$2071

\$63
\$63
\$53
\$53
\$53
\$53
\$48
\$48

\$37
\$37
\$37
\$37
\$32
\$32
\$32
\$32

NOTES: Spacious design includes a wardrobe closet, open storage, one box drawer, and one file drawer in one compact unit. Wardrobe closet contains a coat hook. Storage cabinet includes two shelves, one is adjustable in 2½" increments. Door hinged left or right models available. Box and file drawers operate on ball-bearing suspensions with full extension. File drawers have high sides to accept hanging folders in letter or legal size. Drawers standard with hangrails. Equipped with HON "One Key" interchangeable core removable locks. Lock secures box and file drawers; wardrobe is non-locking.

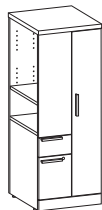
**Side Access Wardrobe**

24"W x 24"D x 50"H, Right
 24"W x 24"D x 50"H, Left
 24"W x 20"D x 50"H, Right
 24"W x 20"D x 50"H, Left
 18"W x 24"D x 50"H, Right
 18"W x 24"D x 50"H, Left
 18"W x 20"D x 50"H, Right
 18"W x 20"D x 50"H, Left

H105LT242450SBFR
H105LT242450SBFL
H105LT242050SBFR
H105LT242050SBFL
H105LT182450SBFR
H105LT182450SBFL
H105LT182050SBFR
H105LT182050SBFL

187
 187
 166
 166
 153
 153
 135
 135

21.3
 21.3
 17.9
 17.9
 16.2
 16.2
 13.7
 13.7

\$2564
\$2564
\$2343
\$2343
\$2425
\$2425
\$2132
\$2132

\$63
\$63
\$53
\$53
\$53
\$53
\$48
\$48

\$37
\$37
\$37
\$37
\$32
\$32
\$32
\$32

NOTES: Spacious design includes a wardrobe closet, open side access storage, one box drawer, and one file drawer in one compact unit. Wardrobe closet contains a coat hook. Storage cabinet includes two shelves, one is adjustable in 2½" increments. Door hinged left or right models available. Box and file drawers operate on ball-bearing suspensions with full extension. File drawers have high sides to accept hanging folders in letter or legal size. Drawers standard with hangrails. Equipped with HON "One Key" interchangeable core removable locks. Lock secures box and file drawers; wardrobe is non-locking.

NOTES:

- Broad family of storage components beyond the confines of a desk drawer.
- Locking units equipped with interchangeable core removable locks.
- Adjustable hex leveling glides allow floor-standing furniture to be easily leveled without lifting the unit; glides have ¾" adjustable range.

HOW TO SPECIFY

Select Model Number	Select Laminate Top and Chassis Color	Select Door Front Laminate	Select Pull and Color	Select Lock Option
See page 247	See page 247	See page 247	See page 247	See page 247
Kickplates will match chassis color				
L Linear P Black	L Lock			
H105LT182450BFR	NN	N	LP	L

10500 SERIES™

Shared Components & Accessories

GSA SIN 33721



Icon Legend on page 19

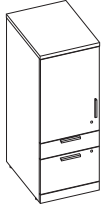

DESCRIPTION	MODEL	SHIP WEIGHT	CUBE	L1 LIST	L2 UPCHARGES	
					CHASSIS	FRONTS
Storage Cabinet 18"W x 24"D x 50"H, Right	H105LT182450SCBFR	158	16.2	\$1944	\$53	\$32
18"W x 24"D x 50"H, Left	H105LT182450SCBFL	158	16.2	\$1944	\$53	\$32

NOTES:

- Versatile unit features a storage cabinet, one box drawer, and one file drawer.
- Storage cabinet includes two shelves, one is adjustable in 2½" increments.
- Door hinged left or right models available.
- File drawers operate on ball-bearing suspensions with full extension.
- File drawers have high sides to accept hanging folders in letter or legal size.
- Drawers standard with hangrails.
- Both the storage cabinet and the file drawers are equipped with a HON "One Key" interchangeable core removable lock.
- Upper lock secures storage cabinet; lower lock secures box and file drawers.
- Broad family of storage components beyond the confines of a desk drawer.
- Locking units equipped with interchangeable core removable locks.
- Adjustable hex leveling glides allow floor-standing furniture to be easily leveled without lifting the unit; glides have ¾" adjustable range.

HOW TO SPECIFY

Select
Model Number

H 1 0 5 L T 1 8 2 4 5 0 S C B F R .

Select
Laminate Top and
Chassis Color

See page 247
Kickplates will match
chassis color

N N .

Select
Door Front
Laminate

See page 247

N .

Select
Pull and Color

L Linear
P Black

L P .

Select
Lock Option



L Lock

L

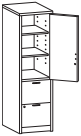

10500 SERIES™

Shared Components & Accessories

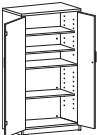
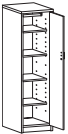
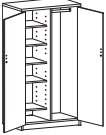
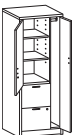
	DESCRIPTION	MODEL	SHIP WEIGHT	CUBE	LIST PRICE BY LAMINATE GRADE	
					L1	L2
 Right-hand model H105297R shown	Storage/File Cabinet (with core removable locks)					
	18"W x 24"D x 66 $\frac{5}{8}$ "H, Hinged Right (shown)	H105297R	258	22.7	\$2087	\$2166
	18"W x 24"D x 66 $\frac{5}{8}$ "H, Hinged Left	H105298L	258	22.7	\$2087	\$2166
	NOTES: Versatile unit features a storage cabinet and two file drawers. Storage cabinet includes three shelves, two are adjustable in 2 $\frac{1}{2}$ " increments. Door hinged left or right models available. File drawers operate on ball-bearing suspensions with full extension. File drawers have high sides to accept hanging folders in letter or legal size. Drawers standard with hangrails. Both the storage cabinet and the file drawers are equipped with a HON "One Key" interchangeable core removable lock. Unit height is designed to match credenza or return plus stack-on storage height.					
 Doors open 110 degrees from closed position.	Storage Cabinet/Lateral File (with core removable lock)					
	36"W x 24"D x 66 $\frac{5}{8}$ "H	H105293	365	41.0	\$2809	\$2914
	NOTES: Storage cabinet is standard with one fixed and two full-width adjustable shelves in top compartment; adjustable shelves can be removed. Overall storage compartment measures 31 $\frac{1}{4}$ "W x 22"D x 36 $\frac{1}{8}$ "H and will accommodate supplies, books and binders, as well as business machines and electronic equipment. Cord pass-through gap behind shelves and grommet in back of the cabinet to facilitate routing cords and reaching wall electrical outlets. Two drawer lateral file on bottom. Lateral file comes with mechanical interlock and hangrails. Cabinet and lateral file lock independently. Unit height is designed to match credenza or return plus stack-on storage height.					
 Doors open 110 degrees from closed position.	Storage Cabinet with Full-width Shelves (with core removable lock)					
	36"W x 24"D x 66 $\frac{5}{8}$ "H	H105299	341	39.6	\$2623	\$2728
	NOTES: Large storage area includes five, full-width (side-to-side) shelves; three are adjustable in 2 $\frac{1}{2}$ " increments. Unit height matches credenza or return plus stack-on storage height.					
 Right-hand model H105295R shown	Personal Wardrobe/Storage Cabinet (with core removable lock)					
	18"W x 24"D x 66 $\frac{5}{8}$ "H, Hinged Right (shown)	H105295R	223	22.9	\$1891	\$1970
	18"W x 24"D x 66 $\frac{5}{8}$ "H, Hinged Left	H105296L	223	22.9	\$1891	\$1970
	NOTES: Unit is standard with four adjustable shelves, coat rod, and core removable lock. Shelves adjust in 2 $\frac{1}{2}$ " increments. Cabinet can be used as a wardrobe by removing four adjustable shelves. Coat rod can be removed from cabinet for storage only applications. Unit height is designed to match credenza or return plus stack-on storage height.					
 Doors open 110 degrees from closed position.	Personal Wardrobe/Storage Cabinet (with core removable lock)					
	36"W x 24"D x 66 $\frac{5}{8}$ "H	H10530	341	41.0	\$2809	\$2822
	NOTES: Spacious design is standard with four adjustable shelves (one shelf is fixed), coat rod and core removable lock which locks both doors. Shelves adjust in 2 $\frac{1}{2}$ " increments. Unit height is designed to match credenza or return plus stack-on storage height.					
 Right-hand model H105301R shown	Personal Storage Tower (with core removable locks)					
	24"W x 24"D x 66 $\frac{5}{8}$ "H, wardrobe Hinged Right, storage cabinet Hinged Left (shown)	H105301R	299	27.9	\$2639	\$2739
	24"W x 24"D x 66 $\frac{5}{8}$ "H, wardrobe Hinged Left, storage cabinet Hinged Right	H105302L	299	27.9	\$2639	\$2739
	NOTES: Spacious design includes a wardrobe closet, storage cabinet, and two file drawers in one compact unit. Wardrobe closet contains a coat rod. Storage cabinet includes three shelves, two are adjustable in 2 $\frac{1}{2}$ " increments. Door hinged left or right models available. File drawers operate on ball-bearing suspensions with full extension. File drawers have high sides to accept hanging folders in letter or legal size. Drawers standard with hangrails. Equipped with HON "One Key" interchangeable core removable locks. Upper lock secures storage cabinet and wardrobe closet doors; lower lock secures file drawers. Unit height is designed to match credenza or return plus stack-on storage height.					

NOTES:

- Broad family of storage components takes organization way beyond the confines of a desk drawer.
- Locking units equipped with interchangeable core removable locks.
- Adjustable hex leveling glides allow floor-standing furniture to be easily leveled without lifting the unit; glides have $\frac{3}{4}$ " adjustable range.
- See pages 280-302 for shared components.

🔑 Keyed alike cores must be ordered separately — see model HF23B on page 699 — makes re-keying quick and easy.

HOW TO SPECIFY

Select Model Number	Select Laminate Top and Chassis Color
	See pages 247-248
H 1 0 5 2 9 7 R .	N N

10500 SERIES™

Shared Components & Accessories

GSA SIN 33721



Icon Legend on page 19



H105532 shown



DESCRIPTION	MODEL	SHIP WEIGHT	CUBE	LIST PRICE BY LAMINATE GRADE	
				L1	L2
Bookcase					
5 Shelf, 36"W x 13 ¹ / ₈ "D x 71"H	H105535	187	25.1	\$1018	\$1050
4 Shelf, 36"W x 13 ¹ / ₈ "D x 57 ¹ / ₈ "H	H105534	156	20.2	\$877	\$904
3 Shelf, 36"W x 13 ¹ / ₈ "D x 43 ³ / ₈ "H	H105533	122	15.6	\$745	\$766
2 Shelf, 36"W x 13 ¹ / ₈ "D x 29 ⁵ / ₈ "H	H105532	90	11.0	\$587	\$603

NOTES: Fixed shelves. Inside shelf dimensions on all units is 33³/₄"W x 12"D x 13"H. No assembly required.

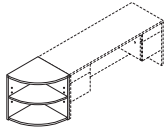

End Cap Bookshelf (2 shelves, 1 fixed, 1 adjustable)					
24"W x 24"D x 29 ¹ / ₂ "H	H105520	84	2.6	\$746	\$762

NOTES: Unit is freestanding. Designed to be positioned at the end of 24"D credenzas and returns. Ideal for books, photos, plants and mementos. Adjusts in 2¹/₂" increments with a total range of 10"H.

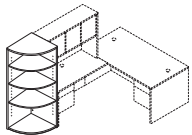

End Cap Bookshelf					
24"W x 24"D x 66 ⁵ / ₈ "H	H105524	164	4.8	\$1242	\$1269

NOTES: Designed to be positioned at the end of 24"D credenzas with stack-on storage, 24"D returns with stack-on storage, 24"D storage/file cabinet, 24"D storage cabinet/lateral file, 24"D wardrobe/storage cabinets, or the 24"D personal storage tower. Unit has four shelves, three are adjustable in 2¹/₂" increments, with a total range of 45"H; bottom shelf is fixed.

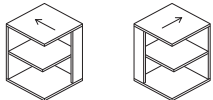

Model H105525R Model H105526L

Square End Cap Bookshelf — 2-Fixed Shelves					
24"W x 24"D x 29 ¹ / ₂ "H, Right	H105525R	92	3.6	\$739	\$755
24"W x 24"D x 29 ¹ / ₂ "H, Left	H105526L	92	3.6	\$739	\$755

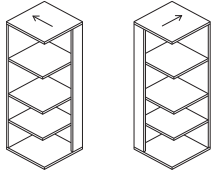

Model H105527R Model H105528L

Square End Cap Bookshelf — 4-Fixed Shelves					
24"W x 24"D x 66 ⁵ / ₈ "H, Right	H105527R	172	5.9	\$1184	\$1211
24"W x 24"D x 66 ⁵ / ₈ "H, Left	H105528L	172	5.9	\$1184	\$1211

NOTES: Units are freestanding. Designed to be positioned next to 24"D models or as a corner bookcase.

End cap, left: grain direction on top aligns with grain direction on tops of left pedestal returns and left credenza models or when positioned to the left side of credenzas with doors or kneespace models.

End cap, right: grain direction on top aligns with grain direction on tops of right pedestal returns and right credenza models or when positioned to the right side of credenzas with doors or kneespace models.

NOTES:

- For 36"W x 24"D x 29¹/₂"H two-shelf bookcase, to align evenly with credenzas and returns, see page 294.

HOW TO SPECIFY

Select Model Number	Select Laminate Top and Chassis Color
	See pages 247-248
H 1 0 5 5 3 2 .	N N

10500 SERIES™

Shared Components & Accessories

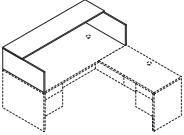
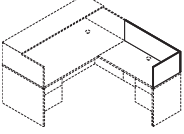
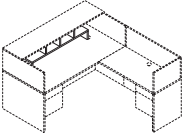
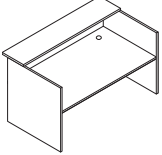
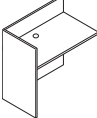
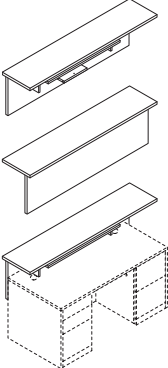
	DESCRIPTION	MODEL	SHIP WEIGHT	CUBE	LIST PRICE BY LAMINATE GRADE	
					L1	L2
	Reception Station with Transaction Counter, for 72"W x 36"D Desk, or Desk Shell, with rectangle top 72"W x 36"D x 14¼"H	H105720	92	3.0	\$623	\$660
	NOTES: For desk tops without grommets, see field installable grommet kit, model HFLDGRMT on page 723. Transaction counter organizer (HTCOL52) fits under/inside of transaction counter (see below).					
	Reception Station for 42"W x 24"D Return or Return Shell 42"W x 24"D x 13"H	H105722	2	1.0	\$314	\$335
	Reception Station for 48"W x 24"D Return or Return Shell 48"W x 24"D x 13"H	H105721	25	3.6	\$357	\$378
	NOTES: For return tops without grommets, see field installable grommet kit, model HFLDGRMT on page 723. Not available in two-tone laminate. Designed specifically for use with Reception Station with Transaction Counter, model H105720.					
	SPECIFYING EXAMPLE: H105722.N					
	DESCRIPTION	MODEL	SHIP WEIGHT	CUBE	LIST PRICE	
	Transaction Counter Organizer 48¾"W x 11⅞"D x 13"H	HTCOL52	24	1.1	\$351	
	NOTES: Fits under reception station with transaction counter model H105720 reception desk shell (H105724), and work organizer models H10537 and H10536.					
	Black only.					
	SPECIFYING EXAMPLE: HTCOL52.P					
	DESCRIPTION	MODEL	SHIP WEIGHT	CUBE	LIST PRICE BY LAMINATE GRADE	
	Reception Desk Shell, with rectangle top 72"W x 39⅞"D x 44⅞"H	H105724	294	17.0	\$1330	\$1388
	NOTES: Non-handed design. Integrated 18⅝"D transaction counter with a 4" full-width overhang. Two cord management grommets in top for routing and hiding wires and cables. Transaction counter organizer model TCOL52 fits under/inside transaction counter. When a two-tone color combination is specified, the first designator defines the transaction countertop and the desk worksurface.					
	An external support channel must be specified separately, see page 261 for details.					
	Reception Station Return Shell 42"W x 24⅜"D x 42⅝"H	H105726	131	17.0	\$926	\$963
	NOTES: Non-handed design for use with reception desk shell. One cord management grommet in top for routing and hiding wires and cables. Woodgrain on approach side is vertical to match grain direction on end panels of reception station desk. Designed specifically for use with Reception Desk Shell, model H105724.					
	Transaction Counter for Reception Desk 66"W x 14⅝"D x 14¼"H	H105729	100	4.2	\$774	\$801
	NOTES: Off-the-worksurface solution designed for use with 72"W or 66"W desks or desk shells with a 1⅞" thick rectangle top and a full-width conference (approach-side) overhang of 4½"D minimum. Choose from two height options at time of installation; 13⅞"H (upper position) or 5½"H (lower position) above the desktop. Attaches easily and securely without any drilling or double-sided tape on the worksurface. Grain direction: side-to-side on countertop; horizontal on approach and users side vertical panel.					

NOTES:

- Three welcoming reception station designs to choose from — stack-on enclosure, full-to-floor shell, or front-suspended counter.
- For 10500 Series™ matching reception area furniture, see Occasional Tables on page 301.
- See pages 280-302 for shared components.

HOW TO SPECIFY

Select Model Number	Select Laminate Top and Chassis Color
	See pages 247-248
H 1 0 5 7 2 0 .	N N

10500 SERIES™

Shared Components & Accessories

GSA SIN 33721



Icon Legend on page 19

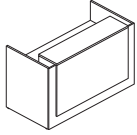

DESCRIPTION	MODEL	SHIP WEIGHT	CUBE	L1 LIST	L2 UPCHARGES		ACCENT PANEL
					WORKSURFACE	CHASSIS	

Reception Desk with Transaction Counter72"W x 36³/₄"D x 44"H**HLAM3772RD**

324

13.5

\$1821**\$37****\$74****\$27**

NOTES: Non-handed. Counter measures 60"W x 15¹/₄"D. Flat edge (G) matches 10500 Series™. For beaded (B) and tri-oval (V) edge shapes, the transaction counter is profiled on the approach and user sides, and the desk worksurface is profiled on the user's side. Beaded (B) and tri-oval (V) edges are available in L1 woodgrains colors only. Smooth and flat (G) edge available in all woodgrains and solid colors. Vertical grain on approach side and front accent panel for L1 laminates except Kingswood Walnut and Florence Walnut. Horizontal grain on L2 laminates and Kingswood and Florence Walnut. Vertical grain on end panels and horizontal grain on worksurface and transaction counter. Two worksurface cord management grommets for routing and hiding wires and cables; can be specified in Black (P) or Platinum (TI) finish.

! An external support channel must be specified separately, see page 261 for details.

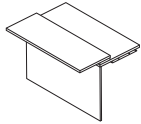
**Reception Return with 32"H Transaction Counter**48¹/₄"W x 32⁷/₈"D x 32"H**HLAM3348RR**

145

3.7

\$1025**\$37****\$37****N/A**

NOTES: Non-handed. For use with HLAM3772RD and Reception Desk Shell (H105724). Counter facilitates accessibility; measures 48"W x 12"D x 32"H. Flat edge (G) matches 10500 Series™. For beaded (B) and tri-oval (V) edge shapes, the transaction counter is profiled on the approach side, and the return worksurface is profiled on the user's side. All other edges are flat banded. Beaded (B) and tri-oval (V) available in L1 woodgrain colors only. Flat edge (G) available in all woodgrains and solid colors. Pattern laminates do not have matching edge color; patterns can be specified with woodgrain or solid edge. Vertical grain on approach side, end panel, worksurface, and transaction counter. Assembly required. Cam covers used to allow for non-handed design.

Specify: Model.Edge Profile & EdgeColor.Worksurface & Counter Color.Chassis Color

SPECIFYING EXAMPLE: HLAM3348RR.GN.N.N

HOW TO SPECIFY

Select Model Number	Select Edge Profile and Edge Color	Select Grommet Color	Select Worksurface Laminate	Select Chassis Laminate	Select Accent Panel Laminate
	See page 248	P Black TI Platinum Not specified for model HLAM3348RR	See page 247	See page 247	See page 247 Not specified for model HLAM3348RR
HLAM3772RD	GN	P	N	N	LDW1



10500 Series™ Laminate Occasional Tables

	DESCRIPTION	MODEL	SHIP WEIGHT	CUBE	LIST PRICE
	Coffee Table 48"W x 20"D x 16"H	H80191	48	3.4	\$684
	Corner Table 24"W x 24"D x 20"H	H80192	35	2.1	\$590
	End Table 24"W x 20"D x 20"H	H80193	29	1.8	\$563

Laminate Occasional Tables (H80191, H80192 and H80193)

Woodgrain	Solid	Patterned	Two-Tone	
Bourbon Cherry (HH) Cognac (COGNCOGN) Florence Walnut (LFWILFW1) Harvest (CC) Kingswood Walnut (LKIILKI1) Mahogany (NN) Mocha (MOCHMOCH) Natural Maple (DD) Pinnacle (PINCPINC) Shaker Cherry (FF) Sterling Ash (LSA1LSA1)	Black (PP) Charcoal (SS) Designer White (LDWILDW1) Loft (LOFTLOFT)	Silver Mesh (B9) *Select edge/apron/leg color Black (P) Bourbon Cherry (H) Charcoal (S) Cognac (COGN) Designer White (LDW1) Florence Walnut (LFW1) Harvest (C) Kingswood Walnut (LK1I) Mahogany (N) Mocha (MOCH) Natural Maple (D) Pinnacle (PINC) Shaker Cherry (F) Sterling Ash (LSA1)	Black/Charcoal (PS) Black/Designer White (PLDW1) Bourbon Cherry/Black (HP) Bourbon Cherry/Charcoal (HS) Bourbon Cherry/Designer White (HLDW1) Charcoal/Black (SP) Charcoal/Designer White (SLDW1) Cognac/Black (COGNP) Cognac/Charcoal (COGNS) Cognac/Designer White (COGNLDW1) Designer White/Black (LDW1P) Designer White/Bourbon Cherry (LDWIH) Designer White/Charcoal (LDW1S) Designer White/Cognac (LDWICOGN) Designer White/Florence Walnut (LDWILFW1) Designer White/Harvest (LDW1C) Designer White/Kingswood Walnut (LDWILKI1) Designer White/Mahogany (LDWIN) Designer White/Mocha (LDW1MOCH) Designer White/Natural Maple (LDW1D) Designer White/Pinnacle (LDW1PINC) Designer White/Sterling Ash (LDW1LSA1)	Designer White/Shaker Cherry (LDW1F) Florence Walnut/Black (LFW1P) Florence Walnut/Charcoal (LFW1S) Florence Walnut/Designer White (LFWILDW1) Florence Walnut/Loft (LFW1LOFT) Harvest/Black (CP) Harvest/Charcoal (CS) Harvest/Designer White (CLDW1) Kingswood Walnut/Black (LKIIP) Kingswood Walnut/Charcoal (LKIIS) Kingswood Walnut/Designer White (LKIILDW1) Kingswood Walnut/Loft (LKI1LOFT) Mahogany/Black (NP) Mahogany/Charcoal (NS) Mahogany/Designer White (NLDW1) Mocha/Black (MOCHP) Mocha/Charcoal (MOCHS) Mocha/Designer White (MOCHLDW1) Natural Maple/Black (DP) Natural Maple/Charcoal (DS) Natural Maple/Designer White (DLDW1) Pinnacle/Black (PINCP) Pinnacle/Charcoal (PINCS) Pinnacle/Designer White (PINCLDW1) Shaker Cherry/Black (FP) Shaker Cherry/Charcoal (FS) Shaker Cherry/Designer White (FLDW1) Sterling Ash/Black (LSA1P) Sterling Ash/Charcoal (LSA1S) Sterling Ash/Designer White (LSA1LDW1)

NOTES:

- Durable material and construction make laminate occasional tables ideal for high traffic areas such as lobbies, reception rooms and lounges. Versatile design is also well suited to private offices.
- Tables accommodate lamps, magazines, telephones, plants, laptops and more.
- Coffee, Corner and End Tables feature top-over-apron styling with square corner detail, which complements many interiors and furniture designs.
- Tops are abrasion- and stain-resistant laminate over 1/8" thick solid core high-performance particleboard.
- See pages 280-302 for shared components.

HOW TO SPECIFY

<p>Select Model Number</p> <p>H 8 0 1 9 1 .</p> <p>H 8 0 1 9 1 .</p>	<p>Select Laminate</p> <p>See above</p> <p>NN</p> <p>L 6 N</p>
---	---

10500 Series™

Shared Components & Accessories

GSA SIN 33721

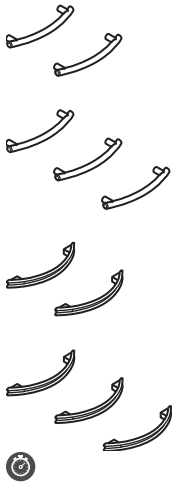

DESCRIPTION	MODEL	SHIP WEIGHT	CUBE	LIST PRICE
Field Installable Drawer/Door Handle Kits				
Sweep Black, 2-pack	HSWEEPA2	0.4	0.3	\$61
Sweep Satin Nickel, 2-pack	HSWEEPC2	0.4	0.3	\$61
Sweep Black, 3-pack	HSWEEPA3	0.5	0.3	\$79
Sweep Satin Nickel, 3-pack	HSWEEPC3	0.5	0.3	\$79
Crescent Black, 2-pack	HCRESCENTA2	0.4	0.3	\$61
Crescent Satin Nickel, 2-pack	HCRESCENTC2	0.4	0.3	\$61
Crescent Black, 3-pack	HCRESCENTA3	0.5	0.3	\$79
Crescent Satin Nickel, 3-pack	HCRESCENTC3	0.5	0.3	\$79

NOTES: Handles are for purchase and field installation on 10500 Series™ desks, credenzas, returns, and lateral files, as well as for the modular pedestals used with 10500.

Applications include:

- box/file and file/file pedestals = one 2-pack per pedestal
- box/box/file and pencil/media/file pedestals = one 3-pack per pedestal
- two drawer lateral file = two 2-packs per unit
- four drawer lateral file = four 2-packs per unit

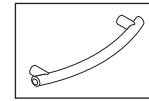

Sweep Handle

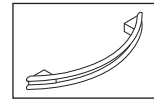

Crescent Handle

The hole spacing for the Sweep and Crescent handles is 96mm (approx. 3¾"). Important note: effective January 1, 2007, the holes used for the black drawer/door handle that comes standard on several HON 10500 Series™ products, including mobile pedestals, storage cabinet with doors, storage/file cabinet, storage cabinet/lateral file, personal wardrobe/storage cabinets, and personal storage towers, will accept the Sweep and Crescent handles. Units manufactured prior to January 1, 2007, have 64mm (approx. 2½") hole spacing and will not accept the Sweep and Crescent handles. Instructions include mounting hardware and paper template.

! Must be ordered with a configurable end product. If ordered separately, not on GSA contract.

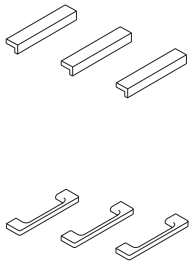

Field Installable Drawer/Door Handle Kits				
Linear, Black, 2-pack	HLINEARA2	0.4	0.3	\$79
Linear, Matte Chrome, 2-pack	HLINEARC2	0.4	0.3	\$79
Linear, Black, 3-pack	HLINEARA3	0.5	0.3	\$88
Linear, Matte Chrome, 3-pack	HLINEARC3	0.5	0.3	\$88
Arch, Black, 2-pack	HARCHA2	0.4	0.3	\$79
Arch, Matte Chrome, 2-pack	HARCHC2	0.4	0.3	\$79
Arch, Black, 3-pack	HARCHA3	0.5	0.3	\$88
Arch, Matte Chrome, 3-pack	HARCHC3	0.5	0.3	\$88

Specify Linear handles in black to coordinate with 10500 Series™ models that ship standard with a decorative handle, such as mobile pedestals, storage cabinets and wardrobes.

NOTES: Handles are for purchase and field installation on 10500 Series™ desks, credenzas, returns, lateral files and modular pedestals.

Instructions include mounting hardware and paper template for drilling holes.

Applications include:

- box/file and file/file pedestals = one 2-pack per pedestal
- box/box/file and pencil/media/file pedestals = one 3-pack per pedestal
- two drawer lateral file = two 2-packs per unit
- four drawer lateral file = four 2-packs per unit

The Linear and Arch handles can be attached using 96mm (approx. 3¾") or 128mm (approx. 5") hole spacing. Important note: effective January 1, 2007, the holes used for the black drawer/door handle that comes standard on several HON 10500 Series™ products, including mobile pedestals, storage cabinet with doors, storage/file cabinet, storage cabinet/lateral file, personal wardrobe/storage cabinets, and personal storage towers, will accept the Linear and Arch handles. Units manufactured prior to January 1, 2007, have 64mm (approx. 2½") hole spacing and will not accept the Linear and Arch handles.

! Must be ordered with a configurable end product. If ordered separately, not on GSA contract.

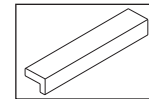

Linear Handle

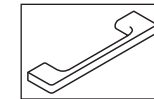

Arch Handle

NOTES:

- Field Installable Drawer/Door Handle Kits for use on 10500 Series™ desks, credenzas, returns and lateral files.
- A metal template is available to facilitate field installation of the Linear, Arch, Sweep and Crescent decorative handles on 10500 Series™ drawer fronts; order model SPLH-SYST-DRKNB.M263164. (\$50)
- See pages 280-302 for shared components.

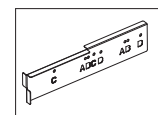

Metal Template

HOW TO SPECIFY

Select
Model Number

H S W E E P A 2

NOTES

NOTES

NOTES

NOTES

NOTES

NOTES

NOTES

NOTES

NOTES

NOTES

NOTES

NOTES

NOTES

94000 SERIES™

Want to see more? Scan here
to check out hon.com.



94000 Series™ shown with 6550 Series Seating.

94000 SERIES™

Confident. Accomplished. Your office speaks volumes about you, and the 94000 Series says all the right things. Exceptionally crafted and solidly engineered, it's finished with warm, durable mahogany laminate — a timeless example of classic beauty and executive elegance.



FEATURES

- Traditional furniture design features solid wood trim and plinth style bases.
- From gleaming brass fixtures to raised accent moldings, details make this desk a standout.
- Our comprehensive selection makes it easy to create a complete executive look.
- It's all about the amenities — like pull out writing surfaces for extra room when you need it and central locking center drawers on all desks.

94000 SERIES™

Typicals



Icon Legend on page 19

Components used are listed on pages 332-337. Order components individually. Other configurations are possible, including various sizes of some components.

QTY	DESCRIPTION	MODEL	LIST PRICE	PRICE EXTENSION
1	Double Pedestal Desk 72"W x 36"D x 29½"H	H94271 *	\$3,619	\$3,619
1	Credenza with Kneespace 72"W x 24"D x 29½"H	H94243 *	\$3,023	\$3,023
1	Stack-on Storage 70"W x 16⅞"D x 37"H	H94234 *	\$2,180	\$2,180
TOTAL:			\$8,822	

* De-emphasized.

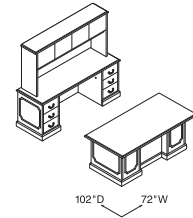

DESK WORKSTATION
72"W x 102"D

QTY	DESCRIPTION	MODEL	LIST PRICE	PRICE EXTENSION
1	Single Pedestal Desk, Left 66"W x 30"D x 29½"H	H94284L *	\$2,977	\$2,977
1	Right Return - box/file 48"W x 24"D x 29½"H	H94215R *	\$2,033	\$2,033
TOTAL:			\$5,010	

* De-emphasized.

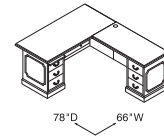

DESK "L" WORKSTATION - RIGHT
66"W x 78"D



Icon Legend on page 19

94000 SERIES™ Typicals

Components used are listed on pages 332-337. Order components individually. Other configurations are possible, including various sizes of some components.

QTY	DESCRIPTION	MODEL	LIST PRICE	PRICE EXTENSION
1	Single Pedestal Desk, Right 66"W x 30"D x 29½"H	H94283R *	\$2,977	\$2,977
1	Left Return - box/file 48"W x 24"D x 29½"H	H94216L *	\$2,033	\$2,033
1	Stack-on-Storage 76"W x 16⅞"D x 37"H	H94237 *	\$2,269	\$2,269
TOTAL:			\$7,279	

* De-emphasized.

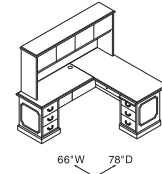

DESK "L" WORKSTATION - LEFT

66"W x 78"D

QTY	DESCRIPTION	MODEL	LIST PRICE	PRICE EXTENSION
1	Single Pedestal Desk, Left 72"W x 36"D x 29½"H	H94286L *	\$3,167	\$3,167
1	Bridge 48"W x 24"D x 29½"H	H94270 *	\$1,196	\$1,196
1	Single Pedestal Credenza, Right 72"W x 24"D x 29½"H	H94245R *	\$2,613	\$2,613
1	Stack-on Storage 70"W x 16⅞"D x 37"H	H94234 *	\$2,180	\$2,180
TOTAL:			\$9,156	

* De-emphasized.

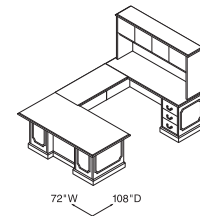

DESK "U" WORKSTATION - RIGHT

72"W x 108"D

94000 SERIES™ Laminate Wood Desks

GSA SIN 33721



Icon Legend on page 19

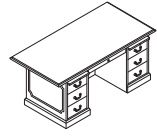

DESCRIPTION

**FULL WIDTH
OVERHANG**

MODEL

**SHIP
WEIGHT**

CUBE

**LIST
PRICE**

Double Pedestal Desk 2-2 — Box/File
72"W x 36"D x 29½"H

7"

H94271 *

307

52.9

\$3619

NOTES: 7" conference overhang on approach side (provides kneespace for visitors), and a 6¾" conference overhang on each end. Convenient pull out writing shelf above pedestal provides added workspace. Center drawer features central locking (locks all drawers).

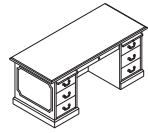

Double Pedestal Desk 2-2 — Box/File
66"W x 30"D x 29½"H
60"W x 30"D x 29½"H

1"

H94276 *

340

42.8

\$3528

1"

H94251 *

284

39.0

\$3406

NOTES: Convenient pull out writing shelf above pedestal provides added workspace. Center drawer features central locking (locks all drawers).

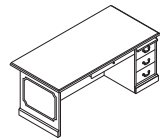

Single Pedestal Desk — Box/File
72"W x 36"D x 29½"H, Right
66"W x 30"D x 29½"H, Right
72"W x 36"D x 29½"H, Left
66"W x 30"D x 29½"H, Left

7"

H94285R *

275

54.0

\$3167

1"

H94283R *

233

42.8

\$2977

7"

H94286L *

275

54.0

\$3167

1"

H94284L *

233

42.8

\$2977

NOTES: Convenient pull out writing shelf above pedestal provides added workspace. Center drawer features central locking (locks all drawers).

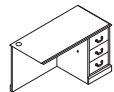

Model H94215R shown

Return — Box/File
48"W x 24"D x 29½"H, Right
42"W x 24"D x 29½"H, Right
48"W x 24"D x 29½"H, Left
42"W x 24"D x 29½"H, Left

H94215R *

154

24.9

\$2033

H94211R *

146

22.1

\$1884

H94216L *

154

24.9

\$2033

H94212L *

146

22.1

\$1884

NOTES: Drawers lock. One round cord grommet in the top. One cord pass-through grommet in the modesty panel to facilitate reaching wall electrical outlets.

! Not designed to be used freestanding.

NOTES:

- 18th century elegance, 21st century engineering.
- Traditional furniture applications include state and local government, military bases, banks, and attorney offices.
- Tops are premium abrasion- and stain-resistant high pressure, high-gloss laminate over durable 1¼" solid core high-performance particleboard.
- Solid wood edge profile.
- Antique brass drawer pulls; hand-applied raised decorative molding, and plinth style base.
- Pullout reference/writing shelf is standard on all desk pedestals.
- Desk, credenza, and return drawers are 5-sided construction, which allows easy drawer alignment or replacement of drawer fronts.
- Center drawer on desks equipped with built-in pencil tray and central locking (locks all drawers).
- Drawers operate on full extension, ball-bearing suspensions to ensure smooth, quiet, long-lasting operation.
- File drawer design includes integrated hangrails for side-to-side letter or legal filing; and front-to-back for letter filing.
- Locking units equipped with interchangeable core removable locks.
- Adjustable hex leveling glides allow floor-standing furniture to be easily leveled without lifting the unit; glides have ¾" adjustable range.

! Keyed alike cores must be ordered separately — see model HF23B on page 699 — makes re-keying quick and easy.



* De-emphasized.

HOW TO SPECIFY

Select Model Number	Select Laminate
H 9 4 2 7 1	NN Mahogany
	N N

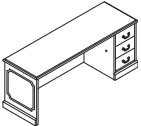
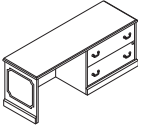
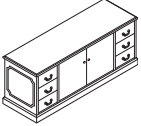
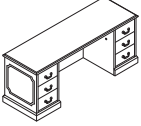

94000 SERIES™ Laminate Wood Desks

	DESCRIPTION	MODEL	SHIP WEIGHT	CUBE	LIST PRICE
 	Bridge (single ped. desk to single ped. credenza or credenza with lateral)				
	48"W x 24"D x 29½"H, (clear inside depth is 22½"D)	H94270 *	85	4.3	\$1196
	42"W x 24"D x 29½"H, (clear inside depth is 22½"D)	H94260 *	76	4.3	\$1108
	NOTES: One cord pass-through grommet in top center of modesty panel to facilitate reaching wall electrical outlets. Kneespace of desk is limited to 24¾"W if bridge is used with 66"W single pedestal desk.				
 Model H94245R shown	Credenza, Single Pedestal — Box/File				
	72"W x 24"D x 29½"H, Right	H94245R *	230	36.0	\$2613
	72"W x 24"D x 29½"H, Left	H94246L *	230	36.0	\$2613
	NOTES: Drawers lock. One cord pass-through grommet in top center of modesty panel to facilitate reaching wall electrical outlets. See pages 334-335 for optional Overhead Hutch and Stack-on Storage.				
 Model H94247R shown	Credenza with 36" Lateral				
	72"W x 24"D x 29½"H, Right	H94247R *	239	36.0	\$2968
	72"W x 24"D x 29½"H, Left	H94248L *	239	36.0	\$2968
	NOTES: Lateral file drawers lock. See pages 334-335 for optional Overhead Hutch and Stack-on Storage.				
 Model H94244 shown	Credenza with Doors — Box/File				
	72"W x 24"D x 29½"H	H94244 *	313	36.0	\$3490
	NOTES: All drawers lock. Doors are non-locking. One removable shelf (38¾"W x 13¾"D). Shelf is not adjustable. See pages 334-335 for optional Overhead Hutch and Stack-on Storage.				
 Model H94243 shown	Credenza with Kneespace — Box/File				
	72"W x 24"D x 29½"H	H94243 *	253	36.0	\$3023
	NOTES: All drawers lock. One cord pass-through grommet in top center of modesty panel to facilitate reaching wall electrical outlets. See pages 334-335 for optional Overhead Hutch and Stack-on Storage.				

NOTES:

- 18th century elegance, 21st century engineering.
- Tops are premium abrasion- and stain-resistant high pressure, high-gloss laminate over durable 1½" solid core high-performance particleboard.
- Solid wood edge profile.
- Antique brass drawer pulls; hand-applied raised decorative molding, and plinth style base.
- Pullout reference/writing shelf is standard on all desk pedestals.
- Desk, credenza, and return drawers are 5-sided construction, which allows easy drawer alignment or replacement of drawer fronts.
- Center drawer on desks equipped with built-in pencil tray and central locking (locks all drawers).
- Drawers operate on full extension, ball-bearing suspensions to ensure smooth, quiet, long-lasting operation.
- File drawer design includes integrated hangrails for side-to-side letter or legal filing; and front-to-back for letter filing.
- Locking units equipped with interchangeable core removable locks.
- 94000 Series™ products produced after 10/26/98 have been improved with a thicker top. Joining with older products before that date may cause misalignment.
- Adjustable hex leveling glides allow floor-standing furniture to be easily leveled without lifting the unit; glides have ¾" adjustable range.

! Keyed alike cores must be ordered separately — see model HF23B on page 699 — makes re-keying quick and easy.

* De-emphasized.

HOW TO SPECIFY

Select Model Number H 9 4 2 4 5 R .	Select Laminate NN Mahogany NN
---	---

94000 SERIES™

Laminate Wood Desks

GSA SIN 33721

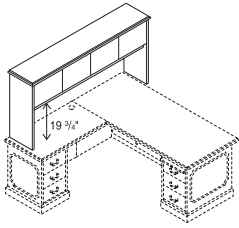

Icon Legend on page 19

**DESCRIPTION****MODEL****SHIP WEIGHT****CUBE****LIST PRICE****Stack-on Storage for 78" D "L" Shaped Workstation**

76"W x 16 1/4"D x 37"H (Accepts Fabric Tackboard H90035 and Task Light HH870960.)

H94237 *

198

18.4

\$2269**Stack-on Storage for 78" D "L" Shaped Workstation, Locking**

76"W x 16 1/4"D x 37"H (Accepts Fabric Tackboard H90035 and Task Light HH870960.)

H94237K *

198

18.4

\$2403

NOTES: Spans the total dimension of "L" shaped layouts comprised of a 48"W return attached to a 30"D single pedestal desk (78"D); or a 42"W return attached to 36"D single pedestal desk (78"D). For vertical paper manager model HLVPMI, see page 337.

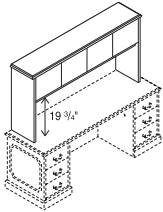
**Stack-on Storage**

70"W x 16 1/4"D x 37"H (Accepts Fabric Tackboard H90034 and Task Light HH870960.)

H94234 *

175

18.0

\$2180**Stack-on Storage, Locking**

70"W x 16 1/4"D x 37"H (Accepts Fabric Tackboard H90034 and Task Light HH870960.)

H94234K *

175

18.0

\$2296

NOTES: For use on 72"W credenza models or on 72"D "L" shaped workstations comprised of a 30"D single pedestal desk and a 42"W return. Inside storage contains two compartments each sized: 31 3/4"W x 12 1/4"D x 12"H. Vertical paper manager, model HLVPMI, fits under stack-on storage. See page 337.

NOTES:

- Stack-on storage equipped with self-closing, adjustable hinged doors.
- Stack-on storage design includes valance to hide task light.
- Vertical paper manager keeps papers, files and books organized and within easy reach from a seated position. Fits under stack-on storage models. See page 337.
- Stacked paper management segments and organizes stack-on storage compartments and bookcase shelves. Unit can be used in models H94327, H94234 and H94236. In some cases, installation may require removing the stack-on storage doors. See page 716.
- For a variety of work-in-process paper management tools, see pages 715-717.
- Overhead Hutch features one cord pass-through grommet located in bottom center of back panel.
- Overhead Hutch is not designed to accept task light.
- Removable lock core kit for locking stack-on storage is model HF27B. See page 699.
- De-emphasized.

HOW TO SPECIFY**Select Model Number**

H 9 4 2 3 7 .

Select Laminate

NN Mahogany

N N



Icon Legend on page 19

94000 SERIES™ Laminate Wood Desks

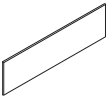
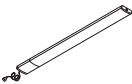
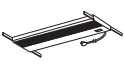
	DESCRIPTION	MODEL	COM	SHIP WEIGHT	CUBE	LIST PRICE
 18"H	Tackboards for use with Stack-on Storage Back Enclosures (Back Enclosures must be ordered separately.)					
	71½"W for 76"W model #H94237 Stack-on	H90035	2.0	13.0	2.80	\$447
	65½"W for 70"W model #H94234 or H94236 Stack-on	H90034	2.0	11.0	2.00	\$427
	NOTES: Specify fabric selection from pages 25-26. Upcharges may apply to premium fabric grades. Tackboards are sized ¾" narrower than respective stack-on storage back enclosure, allowing ⅜" each side to route task light cords. Attached to back enclosure using latch & hook tape provided.					
	ⓘ Disperse (DISP) fabric not available on sizes wider than 60". SPECIFYING EXAMPLE: H930035.APN15					
 OPEN MARKET	LED Task Lights — For Stack-on and Wall Mounted Storage Cabinets					
	17" LED Light with Power Supply (Single)	HLED17AS		1.2 ⓘ	0.05	\$540
	31" LED Light with Power Supply (Single)	HLED31AS		1.5 ⓘ	0.09	\$723
	NOTES: No finish specification required. Attaches magnetically to underside of overhead storage, or attaches with provided screws or double-sided tape. Occupancy sensor attaches to a single or starter LED light and will automatically turn the light off after no motion is detected for 30 minutes. Just like all the LED light models, the occupancy sensor features a soft-touch on/off switch. LED task lights have a lifetime of 50,000 hours and have a dimmer feature that allows the user to adjust the amount of light output.					
 OPEN MARKET	Recessed Task Light					
	46½"W x 3½"D for Models H94234, H94234K, H94236, H94237 and H94237K.	HH870960		12.0 ⓘ	1.10	\$348
	Chicago code version (with fused plug)	HH870960CH		12.0 ⓘ	1.10	\$433
	NOTES: For additional information see page 714.					

NOTES:

- Stack-on storage equipped with self-closing, adjustable hinged doors.
- Stack-on storage design includes valance to hide task light.
- ⓘ Removable lock core kit for locking stack-on storage is model HF27B. See page 699.

HOW TO SPECIFY

Select Model Number H 1 0 7 3 5 8 .	Select Laminate N Mahogany
---	--------------------------------------



94000 SERIES™

Laminate Wood Desks

GSA SIN 33721

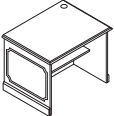
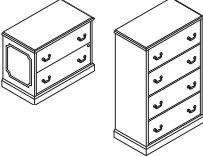
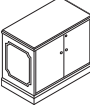
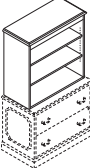
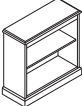
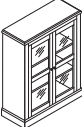

Icon Legend on page 19

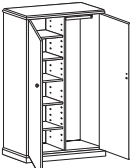
	DESCRIPTION	MODEL	SHIP WEIGHT	CUBE	LIST PRICE
	Computer Work Table with cord grommet 36"W x 30"D x 29½"H NOTES: One removable shelf (32⅓⅙"W x 12⅝"D).	H94226 *	130	23.8	\$1652
	Lateral Files (with core removable lock) 37½"W x 20½"D x 29½"H — two drawer 37½"W x 20½"D x 59⅙"H — four drawer NOTES: High capacity file storage. Includes hangrails; mechanical interlock inhibits the extension of more than one drawer at a time. Two drawer design is equipped with a counterweight.	H94223 * H94229 *	172 300	17.7 34.0	\$2086 \$3579
	Storage Cabinet (with core removable lock) 37½"W x 20½"D x 29½"H NOTES: Bookcase hutch H94210 can be used with H94291. One adjustable shelf, adjusts in 1¼" increments.	H94291 *	165	16.7	\$1872
	Bookcase Hutch 35¾"W x 14⅝"D x 37"H, (3 shelves; 2 adjustable, includes bottom of unit) Designed to be used on model H94223 lateral file or model H94291 storage cabinet. NOTES: One cord pass-through grommet located at bottom center of back panel. Two adjustable shelves, adjust in 1¼" increments.	H94210 *	95	14.0	\$1400
	Bookcase 35¾"W x 14⅝"D x 35½"H, 2-Shelf 35¾"W x 14⅝"D x 49⅝"H, 3-Shelf 35¾"W x 14⅝"D x 64"H, 4-Shelf 35¾"W x 14⅝"D x 78¼"H, 5-Shelf NOTES: Fixed shelves.	H94221 * H94222 * H94224 * H94225 *	100 130 160 200	14.8 20.6 26.3 32.3	\$1307 \$1463 \$1659 \$1820
	Bookcase with Glass Doors 35¾"W x 14⅝"D x 49⅝"H NOTES: Upscale design brings order, utility and a touch of elegance to the traditional office. Wood-framed, clear glass doors with hinges provide easy access to interior. Three fixed shelves provide spacious storage. Shelf measures 32¾"W x 11¾"D. Bookcase with glass doors brings order, utility and a touch of elegance to the traditional office. ! Doors are not designed to lock.	H94220 *	155	20.6	\$2332
	Storage Cabinet/Lateral File (with core removable lock) 37½"W x 24"D x 66½"H NOTES: Standard with one fixed and two full-width adjustable shelves in top compartment; adjustable shelves can be removed. Overall storage compartment measures 33¾"W x 22"D x 36⅙"H and will accommodate supplies, books and binders, as well as business machines and electronic equipment. Cord pass-through gap behind shelves and grommet in back of the cabinet to facilitate routing cords and reaching wall electrical outlets. Two drawer lateral file on bottom. Lateral file comes with mechanical interlock and hangrails. Cabinet and lateral file lock independently. Unit height is designed to match credenza or return plus stack-on storage height or the two drawer lateral file or storage cabinet plus the bookcase hutch height (66½"H).	H94435 *	355	44.4	\$3814
<i>Doors open 110 degrees from closed position.</i>					
	Personal Wardrobe/Storage Cabinet (with core removable lock) 37½"W x 24"D x 66½"H NOTES: Spacious design is standard with four adjustable shelves (one shelf is fixed) plus a generous wardrobe section with a coat rod. Shelves adjust in 2½" increments. One lock secures both doors. Unit height is designed to match credenza plus stack-on storage height or the two drawer lateral file or storage cabinet plus the bookcase hutch height (66½"H). Personal wardrobe/storage cabinet is standard with four adjustable shelves (one shelf is fixed) plus a generous wardrobe section with a coat rod.	H94430 *	351	44.4	\$3748

NOTES:

- File drawers accommodate letter and legal width side-to-side filing, and letter-width front-to-back filing; use hanging folders with a maximum overall height of 9⅝".
- Adjustable hex leveling glides allow floor-standing furniture to be easily leveled without lifting the unit; glides have ¾" adjustable range.
- For conference table options, see the Preside® table tops and bases in the Tables section in the 2023 Shared Spaces Pricer. Order edge option "T" for 94000 Desks edge compatibility.
- Removable lock core kit - HF23B - allows multiple units to be keyed alike. See page 699.

* De-emphasized.

HOW TO SPECIFY

Select Model Number

H 9 4 2 2 6 .



Select Laminate

NN Mahogany

N N

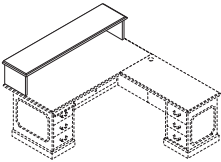
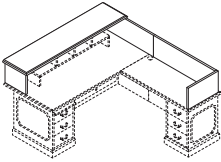
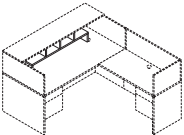
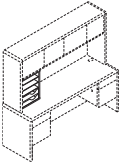

94000 SERIES™ Laminate Wood Desks

	DESCRIPTION	MODEL	SHIP WEIGHT	CUBE	LIST PRICE
	Reception Station/Transaction Counter 71 ³ / ₄ "W x 16 ¹ / ₈ "D x 14 ¹ / ₄ "H Designed for use with 72"W single pedestal desk models H94285R or H94286L. NOTES: Reception station/transaction counter has traditional-styled decorative molding on the approach side.	H94720 *	75	2.6	\$1361
	Reception Station for an "L" Workstation 71 ³ / ₄ "W x 82 ³ / ₄ "D x 14 ¹ / ₄ "H Designed for use with 72"W single pedestal desk H94286L and 48"W return H94215R (shown) Designed for use with 72"W single pedestal desk H94285R and 48"W return H94216L. NOTES: Reception station for "L" workstation includes components for both the reception/transaction counter for desk and the reception station for return.	H94721R * H94722L *	100	4.0	\$1650
<i>Model H94721R shown</i>					
	Transaction Counter Organizer 48 ³ / ₄ "W x 11 ¹ / ₈ "D x 13"H Fits under Transaction Counter on models H94720, H94721R and H94722L. NOTES: Transaction Counter Organizer model HTCOL52 fits under/inside of transaction counter.	HTCOL52	24	1.1	\$351
	Vertical Paper Manager 14 ⁷ / ₈ "W x 10 ⁷ / ₈ "D x 19 ¹¹ / ₁₆ "H NOTES: Keeps papers, files, and books neatly organized and within easy reach from a seated position. Designed for desk, credenza, and return tops. Fits under stack-on storage models. Two pullout drawers and three fixed shelves. NOTES: For additional information see page 715.	HLVPM1	27	2.8	\$445
<i>Not available in two-tone laminate</i>					
	Angled Wood Center Drawer 22" x 15 ³ / ₈ " NOTES: Specify laminate. For additional information see page 709.	H1522	11 Ⓞ	1.1	\$252
<i>Refer to page 112 for Center Drawer compatibility information</i>					

NOTES:

- For conference table options, see the Preside® table tops and bases in the Tables section in the 2023 Shared Spaces Pricer. Order edge option "T" for 94000 Desks edge compatibility.

* De-emphasized.

HOW TO SPECIFY

Select Model Number	Select Laminate
H 9 4 7 2 0 .	NN Mahogany

METRO CLASSIC

Want to see more? Scan here
to check out hon.com.



Metro Classic Desk shown with Ignition® Seating.

METRO CLASSIC

The Metro Classic is a forward-thinking flashback that marries '60s styling with today's technology. This handsomely built collection offers excellent performance for the price — with best-in-class construction, easy-care laminate tops, built-in wire management and more. If you're looking for iconic style that lasts, you'll find it in Metro Classic.



FEATURES

- Retro-styled, but with up-to-date amenities, this classic reflects the enduring Modernist office designs of the 1960s.
- With tubular steel legs painted to match the desk body, Metro Classic gives you a clean look from top to bottom.
- Pedestals feature Tru-Fit mitered drawer fronts for precision alignment when closed.
- Contract-grade, multi-ply laminate stands up to scratches, spills, stains and boiling liquids.
- Recessed plastic drawer handles are color-matched to HON core paint colors.
- All drawers lock by securing the center drawer; lock core can be changed as security needs require.

METRO CLASSIC ORDERING INFORMATION

FINISHES AVAILABILITY

L1 LAMINATES/EDGE BAND

COLOR CODES

Woodgrain

- ◆ Bourbon Cherry/
Bourbon Cherry **H**
- ◆ Cognac/Cognac **COGN**
- ◆ Field Elm/Field Elm **LWFE**
- ◆ Florence Walnut/
Florence Walnut **LFW1**
- ◆ Harvest/Harvest **C**
- ◆ Kingswood Walnut/
Kingswood Walnut **LK11**
- ◆ Mahogany/Mahogany **N**
- ◆ Mocha/Mocha **MOCH**
- ◆ Natural Maple/
Natural Maple **D**
- ◆ Pinnacle/Pinnacle **PINC**
- ◆ Shaker Cherry/
Shaker Cherry **F**
- ◆ Sterling Ash/
Sterling Ash **LSA1**

Solid

- ◆ Black/Black **P**
- ◆ Charcoal/Charcoal **S**
- ◆ Designer White/
Designer White **LDW1**
- ◆ Loft/Loft **LOFT**

Patterned

- ◆ Handspun Chestnut **LAHC**
- ◆ Handspun Dove **LAHD**
- ◆ Handspun Pearl **LAHP**
- ◆ Handspun Slate **LAHS**
- ◆ Silver Mesh/Loft **B9**
- ◆ Steel Mesh/Charcoal **A9**
- ◆ Gray/Matches Paint Color **G2**
- ◆ White/Matches Paint
Color **G1**

PAINTS CODES

P1

- ◆ Black **P**
- ◆ Brownstone **P7D**
- ◆ Charcoal **S**
- ◆ Fossil **P28**
- ◆ Greige **T5**
- ◆ Light Gray **Q**
- ◆ Loft **LOFT**
- ◆ Muslin **T3**
- ◆ Putty **L**
- ◆ Titanium **P8T**

• STEEL DESKS

*SPECIFY: Model Number.
Top Laminate.
Paint Color*
EXAMPLE: HP3276.N.S

◆◆◆ For lead time information see page 21.



METRO CLASSIC

Steel Desks

GSA SIN 33721

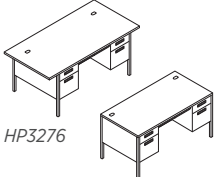

Icon Legend on page 19

	DESCRIPTION	MODEL	SHIP WEIGHT	CUBE	LIST PRICE
 <p>HP3276</p> <p>HP3262</p>	Double Pedestal — 2/2 (locking) 72"W x 36"D x 29½"H (6" overhang on 3 sides) NOTES: HP3276 requires Model H386560N 60"W Stack-on as top of desk extends over end panels. 60"W x 30"D x 29½"H (Non-Locking, 24"D chassis) (6" overhang on approach side only) 60"W x 30"D x 29½"H (locking)	HP3276 HP3261 HP3262	218 165 186	37.7 26.7 26.7	\$2407 \$1688 \$1968
	Single Pedestal (locking) 66"W x 30"D x 29½"H — 2R 66"W x 30"D x 29½"H — 2L 48"W x 30"D x 29½"H — 2R	HP3265R HP3266L HP3251R	167 167 142	29.2 29.2 21.6	\$1818 \$1818 \$1619
	Return, Right — box/file (non-locking) 42"W x 24"D x 29½"H	HP3235R	95	15.5	\$1272
	Return, Left — box/file (non-locking) 42"W x 24"D x 29½"H	HP3236L	95	15.5	\$1272

NOTES:

- Two wire grommets in desk, credenza, and return tops.
- 3/4 height modesty panels.
- Legs shipped unattached.
- Color of pulls and grommets match paint selection for core colors.
- "Tru-fit" mitered drawer fronts for better visual alignment.
- Color of legs match paint selection.
- Central locking center drawer standard, with HON "One Key" interchangeable lock cores.
- High-sided file drawers accept hanging files without hangrails.
- Full extension steel ball-bearing suspensions on file drawers for easy access to all contents.
- Box drawers equipped with 3/4 extension steel ball-bearing suspensions.
- Reinforced, double "O" frame inner structure keeps desk solid and sturdy for years of use.
- All interior drawer bodies are gray pre-painted steel.
- 38000 Series™ stack-on units can be used on Metro desks and credenzas.

! Keyed alike cores ordered separately — see page 699.

HOW TO SPECIFY







Select Model Number HP3276	Select Laminate See page 339 N	Select Paint Color See page 339 S
--------------------------------------	---	--

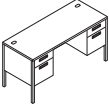

Icon Legend on page 19

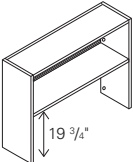
METRO CLASSIC

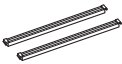
Steel Desks



	DESCRIPTION	MODEL	SHIP WEIGHT	CUBE	LIST PRICE
	Credenza w/Kneespace — 2/2 (non-locking) 60"W x 24"D x 29½"H Accommodates optional HD2 or HD8 center drawer. NOTES: Non-locking.	HP3231	165.0	21.8	\$1968
					
	Stack-on Full Clearance without Doors 66"W x 13½"D x 34¾"H 60"W x 13½"D x 34¾"H 48"W x 13½"D x 34¾"H NOTES: Interior is 12¾"H. Specify: Paint color. For additional 38000 Series™ Stack-on accessory items, see pages 354-356. HP3276 requires Model H386560N 60"W Stack-on as top of desk extends over end panels.	H386566N H386560N H386548N	68.0 64.0 53.0	6.3 5.7 4.7	\$1240 \$1147 \$1048
					
	Chrome Leg Packs — Field Installable 4 pk-29½"H	HC14	7.2	0.2	\$190
	Double-Rail Hanging File Racks — 2 Pack (for side-to-side)  Gray only	H519495	0.5	0.5	\$48

NOTES:

- Two wire grommets in desk, credenza, and return tops.
- 3/4 height modesty panels.
- Legs shipped unattached.
- Color of pulls and grommets match paint selection for core colors.
- "Tru-fit" mitered drawer fronts for better visual alignment.
- Color of legs match paint selection.
- Central locking center drawer standard, with HON "One Key" interchangeable lock cores.
- High-sided file drawers accept hanging files without hangrails.
- Full extension steel ball-bearing suspensions on file drawers for easy access to all contents.
- Box drawers equipped with 3/4 extension steel ball-bearing suspensions.
- Reinforced, double "O" frame inner structure keeps desk solid and sturdy for years of use.
- All interior drawer bodies are gray pre-painted steel.
- 38000 Series™ stack-on units can be used on Metro desks and credenzas.

 Keyed alike cores ordered separately — see page 699.

HOW TO SPECIFY

Select Model Number 	Select Laminate See page 339 Not specified for models H386566N, H386560N and H386548N 	Select Paint Color See page 339 
---	---	--

34000 SERIES

Want to see more? Scan here
to check out [hon.com](https://www.hon.com).



**34000 Series shown with 500 Series
Lateral and Volt® Seating.**

34000 SERIES

The 34000 Series gets high marks in the classroom — or any environment requiring a heavy-duty metal desk that knows how to look good. The square Chrome legs and brushed Aluminum handles look clean and uncomplicated. The Tru-Fit mitered drawer fronts line up perfectly every time. Desk models offer central locking, so all the drawers can be secured with the turn of a single key. And with HON's best-in-class construction, 34000 Series will stand up to years of use.



FEATURES

- Legs are Chrome for a contemporary accent.
- Pedestals feature Tru-Fit mitered drawer fronts that align precisely when closed.
- All drawers lock by securing the center drawer; lock core can be changed as security needs require.
- Contract-grade, multi-ply laminate worksurface stands up to scratches, spills, stains and boiling liquids.
- Brushed Aluminum drawer handles match HON vertical file handles.

34000 SERIES ORDERING INFORMATION

FINISHES AVAILABILITY

L1 LAMINATES/EDGE BAND

COLOR CODES

Woodgrain

- ◆ Bourbon Cherry/
Bourbon Cherry **H**
- ◆ Cognac/Cognac **COGN**
- ◆ Field Elm/Field Elm **LWFE**
- ◆ Florence Walnut/
Florence Walnut **LFW1**
- ◆ Harvest/Harvest **C**
- ◆ Kingswood Walnut/
Kingswood Walnut **LK11**
- ◆ Mahogany/Mahogany **N**
- ◆ Mocha/Mocha **MOCH**
- ◆ Natural Maple/
Natural Maple **D**
- ◆ Shaker Cherry/
Shaker Cherry **F**
- ◆ Sterling Ash/
Sterling Ash **LSA1**

Solid

- ◆ Black/Black **P**
- ◆ Charcoal/Charcoal **S**
- ◆ Designer White/
Designer White **LDW1**
- ◆ Loft/Loft **LOFT**

Patterned

- ◆ Handspun Chestnut **LAHC**
- ◆ Handspun Dove **LAHD**
- ◆ Handspun Pearl **LAHP**
- ◆ Handspun Slate **LAHS**
- ◆ Silver Mesh/Loft **B9**
- ◆ Steel Mesh/Charcoal **A9**
- ◆ Gray/Matches Paint Color **G2**
- ◇ White/Matches Paint
Color **G1**

PAINTS CODES

P1

- ◆ Black **P**
- ◆ Brownstone **P7D**
- ◆ Charcoal **S**
- ◆ Fossil **P28**
- ◆ Greige **T5**
- ◆ Light Gray **Q**
- ◆ Loft **LOFT**
- ◆ Muslin **T3**
- ◆ Putty **L**
- ◆ Titanium **P8T**

• STEEL DESKS

SPECIFY: Model Number.
Top Laminate.
Paint Color

EXAMPLE: H34962.N.S

◆◆◆ For lead time information see page 21.



34000 SERIES

Steel Desks

GSA SIN 33721

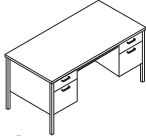
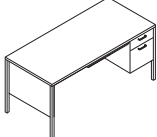
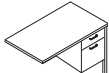

Icon Legend on page 19

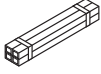
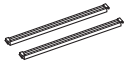
	DESCRIPTION	MODEL	SHIP WEIGHT	CUBE	LIST PRICE
	Double Pedestal — 2/2 (locking) 60"W x 30"D x 29½"H	H34962	162.0	26.7	\$1877
	Single Pedestal, box/file (locking) 66"W x 30"D x 29½"H, Right 66"W x 30"D x 29½"H, Left 48"W x 30"D x 29½"H, Right 45¼"W x 24"D x 29½"H, Right	H34973R H34974L H34251 H34002R	161.0 161.0 115.0 83.0	29.2 29.2 21.6 16.6	\$1621 \$1621 \$1431 \$1224
	Return, Box/File (non-locking) 42"W x 24"D x 29½"H, Right 42"W x 24"D x 29½"H, Left NOTES: Returns are for use with 66"W Single Pedestal Desks.	H34834R H34835L	89.0 89.0	15.5 15.5	\$1079 \$1079
	Credenza with Kneespace — 2/2 (non-locking) 60"W x 24"D x 29½"H ! Accommodates optional HD2 or HD8 center drawer.	H34480	160.0	21.8	\$1886
	Chrome Leg Packs — Field Installable 4 pk-29½"H	HC14	7.2 [Ⓢ]	0.2	\$190
	Double-Rail Hanging File Racks — 2 Pack (for side-to-side) ! Gray only	H519495	0.5	0.5	\$48

NOTES:

- "Tru-fit" mitered drawer fronts for better visual alignment.
- 3/4 height modesty panels.
- Chrome legs shipped unattached.
- Laminate tops.
- Central locking center drawer standard, with HON "One Key" interchangeable lock cores.
- Full extension steel ball-bearing suspensions on file drawers for easy access to all contents.

- High-sided file drawers accept hanging files without hangrails.
 - Box drawers equipped with 3/4 extension steel ball-bearing suspensions.
 - Reinforced, double "O" frame inner structure keeps desk solid and sturdy for years of use.
 - All interior drawer bodies are gray, pre-painted steel.
- ! Keyed alike cores ordered separately — see page 699.

HOW TO SPECIFY

Select Model Number	Select Laminate	Select Paint Color
See page 343	See page 343	See page 343
H 3 4 9 6 2	N	S

38000 SERIES™

Want to see more? Scan here
to check out hon.com.



38000 Series™ shown with Prominent™ Seating.

38000 SERIES™

The 38000 Series is America's best-selling steel desk — and with good reason. Rugged good looks. Precision engineering. Best-in-class construction. This modular collection blends designer touches like stylish, high-pressure laminate with useful details like cord-management. Which makes the 38000 Series the ideal desk solution for any organization seeking premium performance for a moderate price.



FEATURES

- Our steel construction is best in class — so it stands up to heavy use and frequent relocation.
- Integrated wire management and optional power hub accommodate today's electronic office.
- Pedestals feature Tru-Fit mitered drawer fronts for precision alignment when closed.
- Premium, multi-ply laminate worksurface stands up to scratches, spills and stains, and holds up under heavy use.
- Steel ball-bearing drawer suspensions operate easily and quietly.
- Cord management provides access to wall outlets, and allows cords to run through the or between components.

38000 SERIES™ ORDERING INFORMATION

FINISHES AVAILABILITY

L1 LAMINATES/EDGE BAND

COLOR CODES

Woodgrain

- ◆ Bourbon Cherry/
Bourbon Cherry **H**
- ◆ Cognac/Cognac **COGN**
- ◆ Field Elm/Field Elm **LWFE**
- ◆ Florence Walnut/
Florence Walnut **LFW1**
- ◆ Harvest/Harvest **C**
- ◆ Kingswood Walnut/
Kingswood Walnut **LK11**
- ◆ Mahogany/Mahogany **N**
- ◆ Mocha/Mocha **MOCH**
- ◆ Natural Maple/
Natural Maple **D**
- ◆ Pinnacle/Pinnacle **PINC**
- ◆ Shaker Cherry/
Shaker Cherry **F**
- ◆ Sterling Ash/
Sterling Ash **LSA1**

Solid

- ◆ Black/Black **P**
- ◆ Charcoal/Charcoal **S**
- ◆ Designer White/
Designer White **LDW1**
- ◆ Loft/Loft **LOFT**

Patterned

- ◆ Handspun Chestnut/Loft . **LAHC**
- ◆ Handspun Dove/Loft **LAHD**
- ◆ Handspun Pearl/Loft **LAHP**
- ◆ Handspun Slate/
Charcoal **LAHS**
- ◆ Silver Mesh/Loft **B9**
- ◆ Steel Mesh/Charcoal **A9**
- ◆ Gray/Matches Paint Color **G2**
- ◆ White/Matches Paint Color .. **G1**

FINISHES AVAILABILITY *continued*

PAINTS CODES

P1

- ◆ Black **P**
- ◆ Brownstone **P7D**
- ◆ Charcoal **S**
- ◆ Designer White **PJW**
- ◆ Fossil **P28**
- ◆ Greige **T5**
- ◆ Light Gray **Q**
- ◆ Loft **LOFT**
- ◆ Muslin **T3**
- ◆ Putty **L**
- ◆ Titanium **P8T**

P2

- ◆ Champagne Metallic **T4**
- ◆ Gunmetal Metallic **PR3**
- ◆ Platinum Metallic **T1**

NOTE: Where 38000 edgeband does not match laminate color, alternative color is on flat edges only (sides, sides and back edge on returns and bridges, flat sides of corner unit, and flat end of peninsulas).

• STEEL DESKS

*SPECIFY: Model Number.
Top Laminate.
Paint Color*

EXAMPLE: H38934.N.S

• 38000 TACKBOARDS

(Fabric listed on pages 25-26)

*SPECIFY: Model Number
Fabric Style.
Color Code
Paint Color*

EXAMPLE: HT72.CE18.P

◆◆◆ For lead time information see page 21.



Icon Legend on page 19

38000 SERIES™ Typicals — 3/4 Height Pedestals

QTY	DESCRIPTION	MODEL	LIST PRICE	PRICE EXTENSION
1	Double Pedestal Desk 72"W x 36"D x 29½"H	H38180	\$2,772	\$2,772
1	Credenza with Kneespace 72"W x 24"D x 29½"H	H38854	\$2,406	\$2,406
TOTAL:			\$5,178	

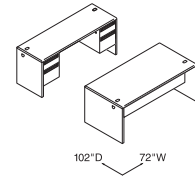

DESK WORKSTATION WITH CREDEZA
72"W x 102"D

QTY	DESCRIPTION	MODEL	LIST PRICE	PRICE EXTENSION
1	Single Pedestal Desk 72"W x 36"D x 29½"H	H38293R	\$2,471	\$2,471
1	Stack-on Storage w/o Doors 72½"W x 13½"D x 34¾"H	H386572N	\$1,306	\$1,306
1	Bridge 48"W x 24"D x 37⅞"H	H38210	\$835	\$835
1	Flipper Doors 2@36"W x 15"H	H387215	\$812	\$812
1	Single Pedestal Credenza 72"W x 24"D x 29½"H	H38855L	\$2,051	\$2,051
TOTAL:			\$7,475	

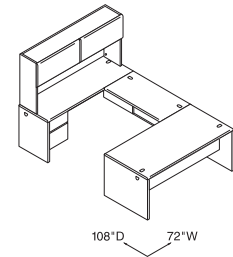

DESK "U" WORKSTATION
72"W x 108"D

QTY	DESCRIPTION	MODEL	LIST PRICE	PRICE EXTENSION
1	Single Pedestal Desk 72"W x 36"D x 29½"H	H38293R	\$2,471	\$2,471
1	Stack-on Storage w/o Doors 72½"W x 13½"D x 34¾"H	H386572N	\$1,306	\$1,306
1	Left, Return, box/file 60"W x 24"D x 29½"H	H38218L	\$1,642	\$1,642
1	Flipper Doors 2@36"W x 15"H	H387215	\$812	\$812
TOTAL:			\$6,231	

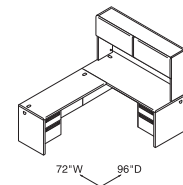

DESK "L" WORKSTATION
72"W x 96"D

QTY	DESCRIPTION	MODEL	LIST PRICE	PRICE EXTENSION
1	Peninsula with Full End Panel 70"W x 36"D x 29½"H	H38941E	\$1,932	\$1,932
1	Stack-on Storage w/o Doors 72½"W x 13½"D x 34¾"H	H386572N	\$1,306	\$1,306
1	Bridge 42"W x 24"D x 29½"H	H38220	\$794	\$794
1	Flipper Doors 2@36"W x 15"H	H387215	\$812	\$812
1	Single Pedestal Credenza, Left 72"W x 24"D x 29½"H	H38855L	\$2,051	\$2,051
TOTAL:			\$6,895	

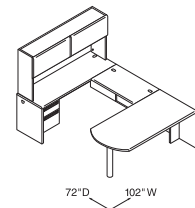

PENINSULA "U" WORKSTATION
72"W x 102"D

38000 SERIES™

Typicals — Modular



Icon Legend on page 19

QTY	DESCRIPTION	MODEL	LIST PRICE	PRICE EXTENSION
1	Shell Desk 72"W x 36"D x 29½"H	H38934	\$1,682	\$1,682
1	Flagship Mobile Pedestal – file/file 15"W x 22⅞"D x 28"H	H18823R	\$991	\$991
1	Return Shell, Left 48"W x 24"D x 29½"H	H38944L	\$1,172	\$1,172
1	Standard Height Mobile Pedestal – box/box/file 15"W x 16⅞"D x 28"H	H18717R	\$920	\$920
TOTAL:			\$4,765	

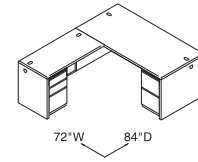

MODULAR DESK WORKSTATION
84" W x 72" D

QTY	DESCRIPTION	MODEL	LIST PRICE	PRICE EXTENSION
1	Shell Desk 72"W x 36"D x 29½"H	H38934	\$1,682	\$1,682
1	Flagship Mobile Pedestal – file/file 15"W x 22⅞"D x 28"H	H18823R	\$991	\$991
1	Bridge 48"W x 24"D x 29½"H	H38210	\$835	\$835
1	Shell Desk 72"W x 24"D x 29½"H	H38925	\$1,625	\$1,625
1	Flagship® Mobile Pedestal – box/box/file 15"W x 16⅞"D x 28"H	H18717R	\$920	\$920
1	Stack-on Storage w/o Doors 72⅝"W x 13½"D x 34¾"H	H386572N	\$1,306	\$1,306
TOTAL:			\$7,359	

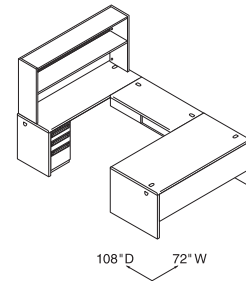

MODULAR DESK "U" WORKSTATION
72" W x 108" D

QTY	DESCRIPTION	MODEL	LIST PRICE	PRICE EXTENSION
1	Corner Unit	H38928	\$1,888	\$1,888
1	Peninsula with End Panel 70"W x 36"D x 29½"H	H38941E	\$1,932	\$1,932
1	Bridge 42"W x 24"D x 29½"H	H38220	\$794	\$794
1	Shell Return, Right 72"W x 24"D x 29½"H	H38947R	\$1,561	\$1,561
1	Flagship Lateral File 30"W x 18"D x 28"H	H9170R	\$1,299	\$1,299
1	Stack-on Storage w/o Doors 72⅝"W x 13½"D x 34¾"H	H386572N	\$1,306	\$1,306
1	Flipper Doors 2@36"W x 15"H	H387215	\$812	\$812
TOTAL:			\$9,592	

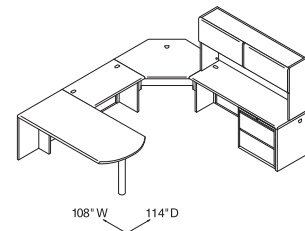

PENINSULA "U" WORKSTATION
108" W x 114" D

QTY	DESCRIPTION	MODEL	LIST PRICE	PRICE EXTENSION
1	Corner Unit	H38928	\$1,888	\$1,888
1	Shell Return, Left 72"W x 24"D x 29½"H	H38948L	\$1,561	\$1,561
1	Standard Height Mobile Pedestal – box/box/file 15"W x 16⅞"D x 28"H	H18717R	\$920	\$920
1	Stack-on Storage w/o Doors 72⅝"W x 13½"D x 34¾"H	H386572N	\$1,306	\$1,306
1	Flipper Doors 2@36"W x 15"H	H387215	\$812	\$812
1	Shell Return – Right 72"W x 24"D x 29½"H	H38947R	\$1,561	\$1,561
1	Flagship® Mobile Pedestal – file/file 15"W x 16⅞"D x 28"H	H18817R	\$920	\$920
TOTAL:			\$8,968	

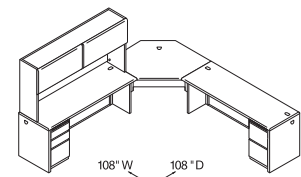

CORNER UNIT WITH RETURNS WORKSTATION
108" W x 108" D



Icon Legend on page 19

38000 SERIES™ Bundles Typicals

Mahogany/Charcoal
H38LL7284NS

Harvest/Putty
H38LL7284CL

QTY	DESCRIPTION	MODEL	LIST PRICE	PRICE EXTENSION
1	Left Pedestal Desk	H38294L	\$2,471	\$2,471
1	Right Return	H38215R	\$1,497	\$1,497
TOTAL:			\$3,968	

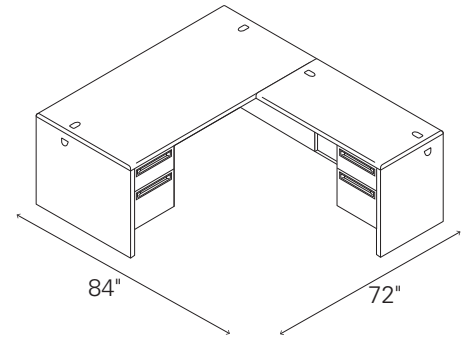

L-STATION (LEFT DESK/RIGHT RETURN)

Mahogany/Charcoal
H38LR7284NS

Harvest/Putty
H38LR7284CL

QTY	DESCRIPTION	MODEL	LIST PRICE	PRICE EXTENSION
1	Right Pedestal Desk	H38293R	\$2,471	\$2,471
1	Left Return	H38216L	\$1,497	\$1,497
TOTAL:			\$3,968	

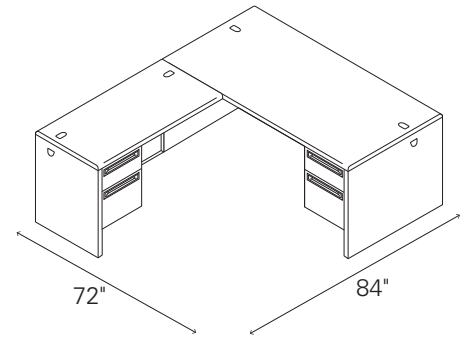

L-STATION (RIGHT DESK/LEFT RETURN)

Mahogany/Charcoal
H38URH72108NS2

Harvest/Putty
H38URH72108CL2

QTY	DESCRIPTION	MODEL	LIST PRICE	PRICE EXTENSION
1	Single Pedestal Desk, Right	H38293R	\$2,471	\$2,471
1	Single Pedestal Credenza, Left	H38855L	\$2,051	\$2,051
1	Hutch without Doors	H386572N	\$1,306	\$1,306
1	Flipper Doors, Pair	H387215	\$812	\$812
1	Bridge	H38210	\$835	\$835
TOTAL:			\$7,475	

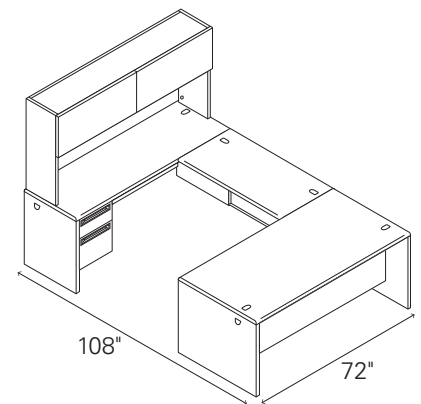

**U-STATION WITH HUTCH
(RIGHT DESK/LEFT CREDENZA)**

38000 SERIES™

Bundles Typical



Icon Legend on page 19

Mahogany/Charcoal
H38ULH72108NS2

Harvest/Putty
H38ULH72108CL2

QTY	DESCRIPTION	MODEL	LIST PRICE	PRICE EXTENSION
1	Single Pedestal Desk, Left	H38294L	\$2,471	\$2,471
1	Single Pedestal Credenza, Right	H38856R	\$2,051	\$2,051
1	Hutch without Doors	H386572N	\$1,306	\$1,306
1	Flipper Doors, Pair	H387215	\$812	\$812
1	Bridge	H38210	\$835	\$835
TOTAL:				\$7,475

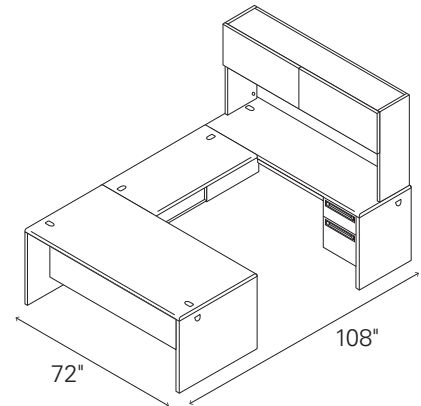

**U-STATION WITH HUTCH
(LEFT DESK/RIGHT CREDENZA)**

Mahogany/Charcoal
H38DCH6096NS2

Harvest/Putty
H38DCH6096CL2

QTY	DESCRIPTION	MODEL	LIST PRICE	PRICE EXTENSION
1	Double Pedestal Desk	H38155	\$2,371	\$2,371
1	Double Pedestal Credenza	H38852	\$2,314	\$2,314
1	Hutch without Doors	H386560N	\$1,147	\$1,147
1	Flipper Doors, Pair	H386015	\$764	\$764
TOTAL:				\$6,596

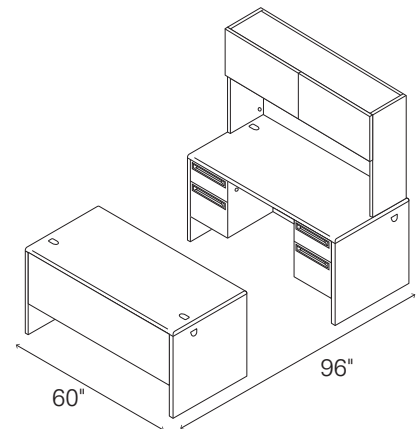

WORKSTATION



38000 SERIES™

Steel Desks — 3/4 Pedestals

	DESCRIPTION	FULL WIDTH OVERHANG	MODEL	SHIP WEIGHT	CUBE	LIST PRICE BY PAINT GRADE	
						P1	P2
	Double Pedestal — 2/2 w/Locks	6"					
	72"W x 36"D x 29½"H		H38180	256	51.7	\$2772	\$2850
	66"W x 30"D x 29½"H		H38170	224	40.1	\$2653	\$2731
	60"W x 30"D x 29½"H		H38155	217	36.6	\$2371	\$2449
	Single Pedestal w/Lock	6"					
	72"W x 36"D x 29½"H — 2R		H38293R	214	51.7	\$2471	\$2549
	66"W x 30"D x 29½"H — 2R		H38291R	181	40.1	\$2277	\$2355
	48"W x 30"D x 29½"H — 2R	H38251	155	29.6	\$2016	\$2094	
	72"W x 36"D x 29½"H — 2L	6"	H38294L	214	51.7	\$2471	\$2549
	66"W x 30"D x 29½"H — 2L	H38292L	181	40.1	\$2277	\$2355	
	48"W x 30"D x 29½"H — 2L	H38252L	155	29.6	\$2016	\$2094	
	Flush Return — box/file w/Lock						
	60"W x 24"D x 29½"H — 2R		H38217R	138	30.1	\$1642	\$1690
	48"W x 24"D x 29½"H — 2R		H38215R	124	24.1	\$1497	\$1545
	60"W x 24"D x 29½"H — 2L		H38218L	138	30.1	\$1642	\$1690
	48"W x 24"D x 29½"H — 2L		H38216L	124	24.1	\$1497	\$1545
NOTES: Returns have 2 grommets each in worksurface top and full height modesty panel.							
	Credenza w/Doors w/Locks						
	72"W x 24"D x 29½"H		H38853	230	35.6	\$2615	\$2693
NOTES: Pedestals lock.							
	Credenza w/Kneespace w/Locks						
	72"W x 24"D x 29½"H		H38854	172	35.6	\$2406	\$2484
	Kneespace: 39¾"W						
	66"W x 24"D x 29½"H		H38851	166	32.7	\$2356	\$2434
	Kneespace: 33¾"W						
60"W x 24"D x 29½"H		H38852	154	29.8	\$2314	\$2392	
Kneespace: 27¾"W							
NOTES: Pedestals lock.							
	Single Pedestal Credenza — 2R w/Lock						
	72"W x 24"D x 29½"H		H38856R	159	35.6	\$2051	\$2129
	66"W x 24"D x 29½"H		H38858R	153	32.7	\$1902	\$1980
NOTES: Pedestal locks.							
	Single Pedestal Credenza — 2L w/Lock						
	72"W x 24"D x 29½"H		H38855L	159	35.6	\$2051	\$2129
	66"W x 24"D x 29½"H		H38857L	153	32.7	\$1902	\$1980
NOTES: Pedestal locks.							

NOTES:

- 3/4 height modesty panels unless noted.
- Color of pulls and grommets match paint selection for core colors.
- One pencil tray standard per unit except returns.
- Wire grommets standard in all tops.
- Wire grommets in end panels allow cable connections between desks.
- "Tru-fit" mitered drawer fronts for better visual alignment.
- Optional center drawer features steel ball-bearing suspension.
- High-sided file drawers accept hanging files without hangrails.
- Three-part full extension steel ball-bearing suspension on all file drawers for full access to interior contents.
- Box drawers feature two-part, ¾" extension steel ball-bearing suspension.
- Baked enamel finish over rust-inhibiting phosphate pre-treatment.
- Optional follower block accessory available to organize drawer storage.

HOW TO SPECIFY

Select Model Number 	Select Laminate See page 346 	Select Paint Color See page 346
--------------------------------	--	---

38000 SERIES™ Modular Desks

GSA SIN 33721



Icon Legend on page 19

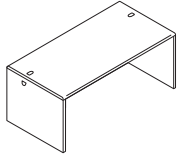

DESCRIPTION	INSIDE SHELL DIMENSIONS	FULL WIDTH OVERHANG	MODEL	SHIP WEIGHT	CUBE	LIST PRICE BY PAINT GRADE	
						P1	P2
Desk Shell							
72"W x 36"D x 29½"H	69½"W x 29½"D	6"	H38934	134	7.1	\$1682	\$1760
72"W x 30"D x 29½"H	69½"W x 29½"D		H38935	118	6.0	\$1638	\$1716
66"W x 30"D x 29½"H	63½"W x 29½"D		H38933	108	6.0	\$1614	\$1692
60"W x 30"D x 29½"H	57½"W x 29½"D		H38932	103	5.1	\$1535	\$1613
48"W x 30"D x 29½"H	45½"W x 29½"D		H38931	89	5.1	\$1419	\$1497
72"W x 24"D x 29½"H	69½"W x 23½"D		H38925	99	5.0	\$1625	\$1703
66"W x 24"D x 29½"H	63½"W x 23½"D		H38923	95	5.0	\$1559	\$1637
60"W x 24"D x 29½"H	57½"W x 23½"D		H38922	89	4.2	\$1482	\$1560
48"W x 24"D x 29½"H	45½"W x 23½"D		H38921	83	4.2	\$1388	\$1466

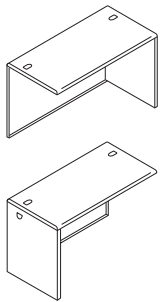

Return Shell								
72"W x 24"D x 29½"H, Right	69½"W x 23½"D (2 grommets)	H38947R	87	6.0	\$1561	\$1609		
60"W x 24"D x 29½"H, Right	57½"W x 23½"D (2 grommets)	H38945R	80	5.1	\$1399	\$1447		
48"W x 24"D x 29½"H, Right	45½"W x 23½"D (2 grommets)	H38943R	71	4.2	\$1172	\$1220		
42"W x 24"D x 29½"H, Right	39½"W x 23½"D (2 grommets)	H38949R	65	4.2	\$1093	\$1141		
72"W x 24"D x 29½"H, Left	69½"W x 23½"D (2 grommets)	H38948L	87	6.0	\$1561	\$1609		
60"W x 24"D x 29½"H, Left	57½"W x 23½"D (2 grommets)	H38946L	80	5.1	\$1399	\$1447		
48"W x 24"D x 29½"H, Left	45½"W x 23½"D (2 grommets)	H38944L	71	4.2	\$1172	\$1220		
42"W x 24"D x 29½"H, Left	39½"W x 23½"D (2 grommets)	H38950L	65	4.2	\$1093	\$1141		

NOTES: Modular returns feature full height modesty panels.

⚠ Not designed to be used freestanding.

NOTES:

- Color of pulls and grommets match paint selection for core colors. If Titanium paint is selected then Loft is provided.
- Wire grommets standard in all tops, except peninsulas.
- Wire grommets in end panels allow cable connections between desks.
- Optional center drawer features steel ball-bearing suspension.
- 3/4 height modesty panels unless noted.
- Ability to use all HON laterals and pedestals.

Recommended Pedestal Options:

38000 Series™	36" Deep Desk			30" Deep Desk			24" Deep Desk		
Contain®, Flagship® or Brigade® Pedestals	Ability to Attach	Ability to Use Wire Port	Ability to Attach Hutch	Ability to Attach	Ability to Use Wire Port	Ability to Attach Hutch	Ability to Attach	Ability to Use Wire Port	Ability to Attach Hutch
16¾"D Hanging Pedestal	•	•	•	•	•	•	•	•	•
22⅞"D Hanging Pedestal	•	•	•	•	•	•	•	•	•
16¾"D Freestanding or Mobile	•	•	•	•	•	•	•	•	•
22⅞"D Freestanding or Mobile	•	•	•	•	•	•	•	•	•
28⅞"D Freestanding or Mobile	•	•	•	•	•	•	•	•	•

Use of a pedestal spacer or 28"H standard height pedestals will block wire access from the grommet to the kneespace area.

NOTES: Stack-on units can be attached regardless of pedestal configuration.

Personalize Your Storage Needs

With These Possible Solutions:

Use coordinating HON components such as Flagship® pedestals (shown on page 627) and Lateral Files (shown on pages 629-630).

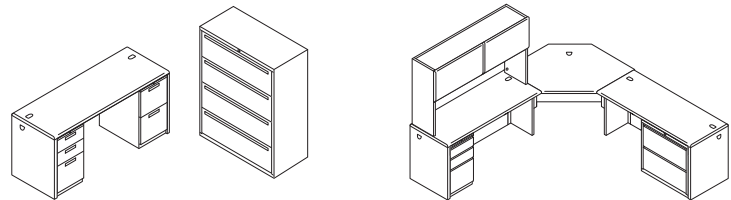



HOW TO SPECIFY

<p>Select Model Number</p> <p>H 3 8 9 3 4 .</p>	<p>Select Laminate</p> <p>See page 346</p> <p>N .</p>	<p>Select Paint Color</p> <p>See page 346</p> <p>S .</p>
--	--	---

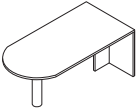

38000 SERIES™ Components

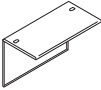
	DESCRIPTION	MODEL	SHIP WEIGHT	CUBE	LIST PRICE BY PAINT GRADE	
					P1	P2
	Peninsula with Support Column and End Panel					
	70"W x 36"D x 29½"H	H38941E	132	8.1	\$1932	\$1980
	70"W x 30"D x 29½"H	H38942E	126	7.0	\$1835	\$1883
	66"W x 30"D x 29½"H	H38966E	113	8.1	\$1785	\$1833
	NOTES: Use to create "L" configuration with a Return or "U" configuration with a Bridge and Credenza, Desk or Corner Unit.					
	! Not designed to be used freestanding.					
	Corner Unit					
	24" x 36" x 36" x 24" x 29½"H Leading edge is 17"W; leading edge to rear edge is 36"D.	H38928	85	7.4	\$1888	\$1966
	! Designed to be used with Returns or Bridges.					
	Bridge					
	48"W x 24"D x 29½"H 42"W x 24"D x 29½"H	H38210 H38220	54 Ⓢ 50 Ⓢ	4.2 4.2	\$835 \$794	\$854 \$813
	NOTES: Full height modesty panel.					

NOTES:

- 3/4 height modesty panels unless noted.
- All worksurfaces shown are particleboard.
- Color of grommets match paint selection for core colors.

HOW TO SPECIFY

<p>Select Model Number</p> <p>H 3 8 9 4 1 E .</p>	<p>Select Laminate</p> <p>See page 346</p> <p>N .</p>	<p>Select Paint Color</p> <p>See page 346</p> <p>S .</p>	<p>Select Support Column Paint</p> <p><i>Specify for peninsula models only</i></p> <p>P Black</p> <p>P</p>
--	--	---	---

38000 SERIES™

Steel Stack-on Units

GSA SIN 33721

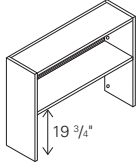

Icon Legend on page 19

**DESCRIPTION****Stack-on Full Clearance without Doors**

72"W x 13½"D x 34¾"H

66"W x 13½"D x 34¾"H

60"W x 13½"D x 34¾"H

48"W x 13½"D x 34¾"H

NOTES: Interior is 12¾"H.

Specify: Paint color.

MODEL**SHIP WEIGHT****CUBE****LIST PRICE BY PAINT GRADE****P1****P2**

H386572N	72	6.8	\$1306	\$1360
H386566N	68	6.3	\$1240	\$1294
H386560N	64	5.7	\$1147	\$1201
H386548N	53	4.7	\$1048	\$1102

HOW TO SPECIFY**Select Model Number****Select Paint Color**

See page 346

H 3 8 6 5 7 2 N .

P

DESCRIPTION**Front Flipper Doors**

2 @ 36"W x 15"H, Flipper Doors for 72"W Stack-on

2 @ 33"W x 15"H, Flipper Doors for 66"W Stack-on

2 @ 30"W x 15"H, Flipper Doors for 60"W Stack-on

1 @ 48"W x 15"H, Flipper Door for 48"W Stack-on

MODEL**SHIP WEIGHT****CUBE****LIST PRICE BY PAINT GRADE****P1****P2**

H387215	19	0.9	\$812	\$831
H386615	17	0.9	\$795	\$814
H386015	16	0.9	\$764	\$783
H384815	12	0.5	\$467	\$486

NOTES:

- Flipper doors are standard with a core removable lock located on the underside of stack-on shelf.
- Equipped with HON "One Key" interchangeable core removable locks.
- Stack-on units attach to worksurface with double stick tape or with screws provided.
- Stack-ons also compatible with Abode™ and Metro Classic.
- Cabinet/door combination kits available for field installation.
- Two dividers standard with every stack-on.
- Color of grommets match paint selection for core colors.

ⓘ Keyed alike cores must be ordered separately — see page 699.

ⓘ Stack-on Units not designed to be used on Corner Units.

HOW TO SPECIFY**Select Model Number****Select Lock Option**

- L Lock
 X Omit Lock
 (deduct \$20)

See page 699 for omit lock ordering instructions

Select Paint Color

See page 346

H 3 8 7 2 1 5 .

L .

P



Icon Legend on page 19

38000 SERIES™ Steel Stack-on Units

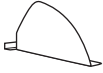

DESCRIPTION	MODEL	SHIP WEIGHT	CUBE	LIST PRICE BY PAINT GRADE	
				P1	P2
Shelf Dividers — package of 6 Specify: Paint color. Shelf dividers can only be used on stack-ons manufactured after 7/3/2000.	H38SHFDV	3	0.2	\$212	\$224

HOW TO SPECIFY

<p>Select Model Number</p> <p>H 3 8 S H F D V .</p>	<p>Select Paint Color</p> <p>See page 346</p> <p>P</p>
--	---

38000 SERIES™

Accessories

GSA SIN 33721



Icon Legend on page 19

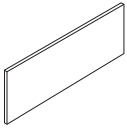

DESCRIPTION

Tackboard for Stack-on — 20"H

72"W

66"W

60"W

48"W

Specify: Model.Fabric.Paint. Upcharges may apply to premium fabric grades.

! Disperse (DISP) fabric not available on sizes wider than 60".

MODEL

SHIP WEIGHT

CUBE

LIST PRICE

HT72ND

26.0

2.3

\$730**HT66ND**

24.0

2.1

\$702**HT60ND**

22.0

1.9

\$679**HT48ND**

18.0

1.5

\$607

NOTES:

- Tackboards feature painted steel backs and can be installed in the field.

HOW TO SPECIFY

Select
Model Number

H T 7 2 N D .

Select
Fabric Color

See pages 25-26

A P N 1 5 .

Select
Paint Color

See page 346

P



Abode™ shown with Contain®
Storage and Endorse® Seating.

ABODE™

The Abode systems desk gives you a consistent look throughout your space and can help you respond easily to future layout changes. It integrates seamlessly with Abound® and Accelerate®, and can be configured to create freestanding or height adjustable workstations. For greater flexibility and durability in the workspace, look no further than Abode.



FEATURES

- Create a freestanding metal desk that accommodates storage above and below the worksurface.
- Full compatibility with Abound and Accelerate workstations elevates the functionality of Abode.
- Incorporating Coordinate™ makes it easy for workers to adjust their desk height throughout the day, keeping them active, healthy and focused.

ABODE™ ORDERING INFORMATION

COMPONENTS

PAINT CODES

P1

- ◆ Black P
- ◆ Brownstone P7D
- ◆ Charcoal S
- ◆ Cove P096
- ◆ Designer White PJW
- ◆ Dune P094
- ◆ Fossil P28
- ◆ Greige T5
- ◆ Harbor P097
- ◆ Light Gray Q
- ◆ Loft LOFT
- ◆ Muslin T3
- ◆ Putty L
- ◆ Sage P095
- ◆ Titanium P8T

P2

- ◆ Champagne Metallic T4
- ◆ Platinum Metallic T1
- ◆ Silver PR6

◆◆◆ For lead time information see page 21.

WORKING WITH ABODE™ COMPONENTS

Configurations

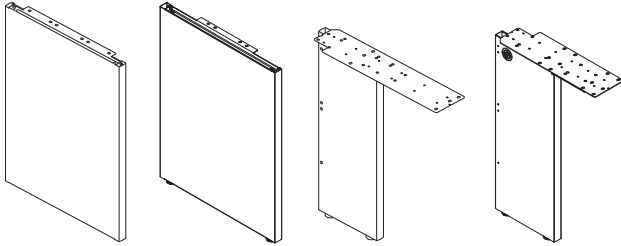

End Panels and Support Legs

Each are available in two options: freestanding or panel mount. The only difference between the two options are the panel-mount models come with a left- or right-handed bracket to attach the support to a panel in a systems application.

The 11"D end panel is used to support peninsulas.

Corner Desk Legs

Corner desk legs have a 90-degree bend and welded construction. The strong construction allows gussets or half-height modesty panels to be used with corner legs.

Bridge Kits

Bridge kits include: two flat brackets, two modesty panel-to-end panel attachment brackets, and two tie straps. This kit is used when attaching a bridge unit between two rectangular worksurfaces.

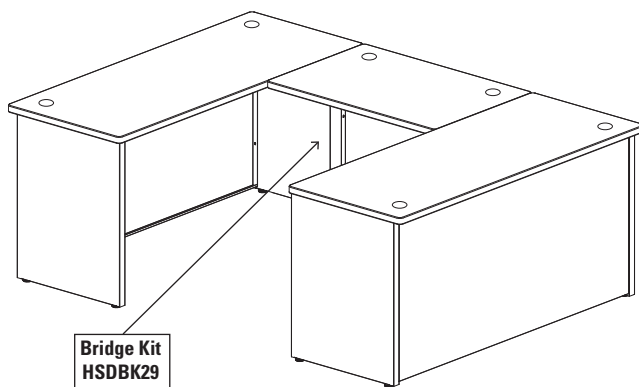

There are some bridge instances where only half of a bridge kit is needed (e.g., using a bridge between a rectangular worksurface and a corner or peninsula). A return kit may be ordered for these instances.

Support Column

Support columns are used to support one end of curvilinear worksurfaces. Includes column, worksurface bracket kit HWSA2, attaching hardware, and adjustable glides.

Return Kits

Return kits include: one flat bracket, one modesty panel-to-end panel attachment bracket, and one tie strap. These are used when attaching a return to a primary desk. Return kits can also be used in some bridge applications — one example is shown below when using a peninsula.

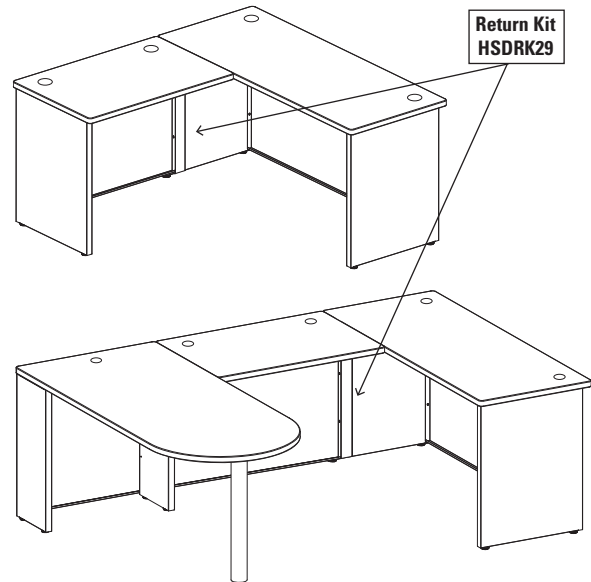

Desk-to-Panel Attachment Kits

Desk-to-panel attachment kits are used to connect a worksurface and modesty panel perpendicular to a panel of corresponding width. Opposing end of worksurface must be attached with an end panel, support leg, or corner leg mounted directly under this worksurface.

When using a corner or corner cove worksurface with the rear corner attached to a panel, and opposing end of worksurface is attached to a freestanding desk, use corner w/desk attachment kit. Hand of unit is determined from the user's side of the desk (right-hand unit attaches to right side of modesty).

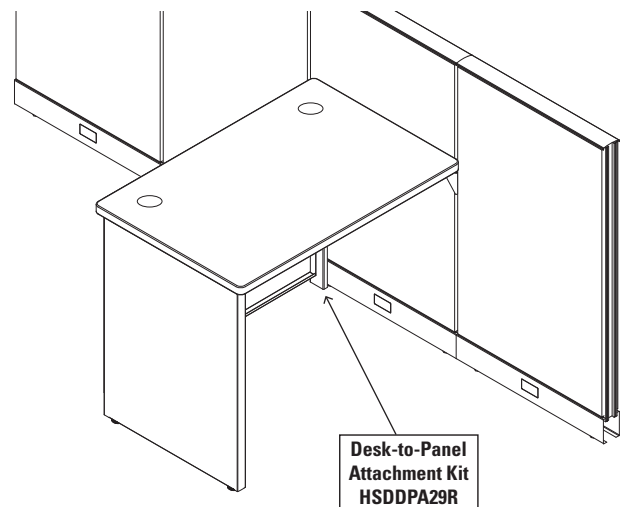

Corner w/Desk Panel Attachment Kit

Corner w/desk panel attachment kit connects the rear corner of a corner or corner cove worksurface and modesty panel to a panel when the opposing end of the worksurface shares a support leg with an adjacent freestanding desk and the support leg is mounted under the freestanding desk. Hand of unit is determined from the user's side of the desk (left-hand unit attaches to left side of modesty).

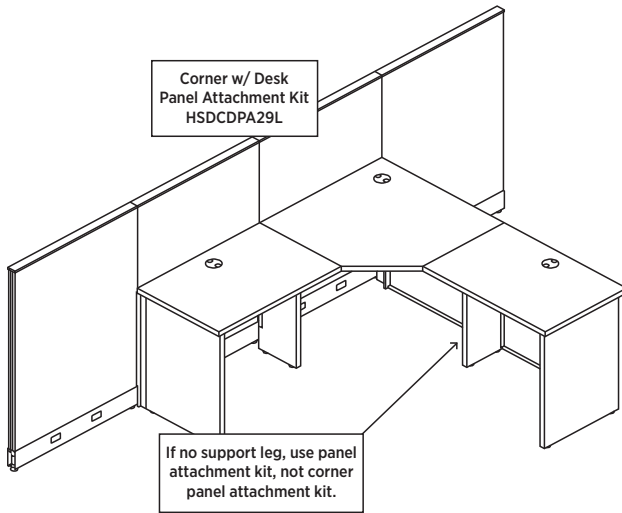

Corner Worksurfaces

Corner worksurfaces accommodate 90-degree corner desk legs.

In-Line Connections of Desks

Shared leg can be used at in-line connections to support adjacent rectangular desks.

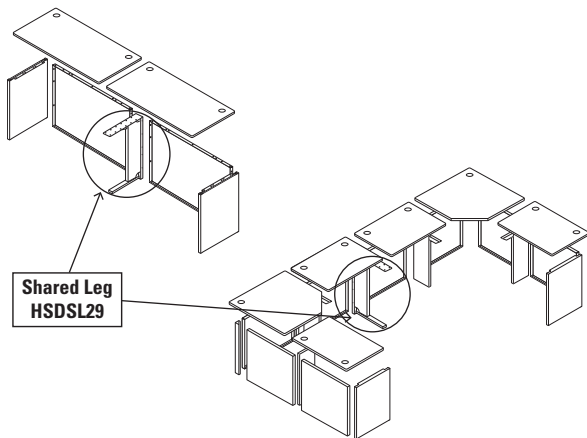

Pedestals and Storage

Pedestals must be ordered smaller than the depth of the worksurface. For example, 18"D peds should be used with 24"D worksurfaces. 18"D or 23"D pedestals can be used with 30"D worksurfaces. Using 18"D laterals or personal files provide additional storage options under 24"D worksurfaces.

Modesty Panels

The following are some general guidelines for Abode™ modesty panels:

- **Desk:** Modesty panel width is the same width as the worksurface
- **Return:** Modesty panel width is 6" greater than the width of the worksurface
- **Bridge connecting two rectangular worksurfaces:** Modesty panel width is 12" greater than the width of the bridge worksurface
- **Bridge connecting a rectangular worksurface and corner or peninsula:** Modesty panel width is 6" greater than the width of the worksurface
- **Corner connecting to an adjacent worksurface:** Modesty panel width is the same width as the worksurface.

Stand-Alone Corner Modesty Panels

Stand-alone corner modesty panels are used only when one or both sides of a corner or corner cove worksurface are freestanding and NOT attached to another worksurface. Specify the width the same as the width of the worksurface.

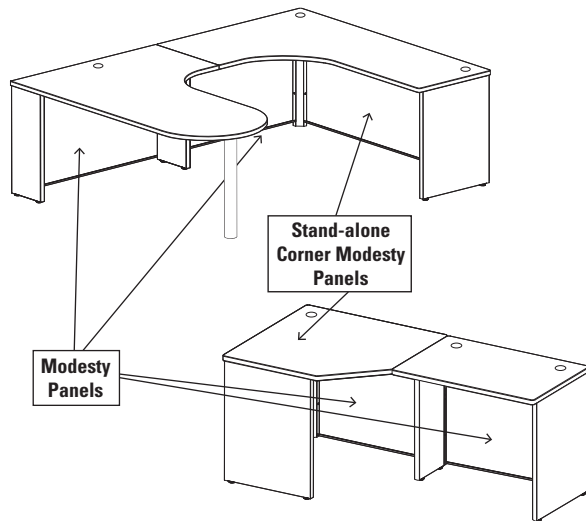

Gussets "G"

Gussets can be used in place of a modesty panel with desks 36"W to 60"W. Gussets can also be used with corner desk legs.

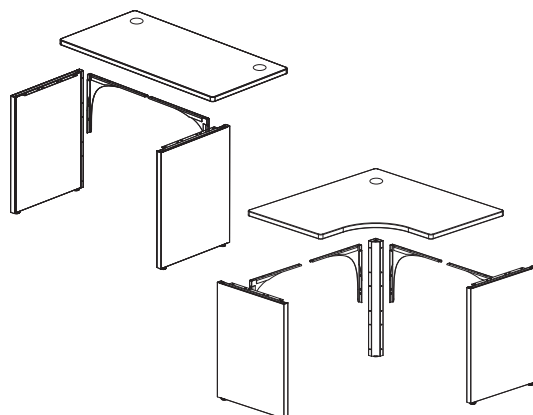



Icon Legend on page 19

ABODE™ Typicals

QTY	DESCRIPTION	MODEL	LIST PRICE	PRICE EXTENSION
1	Rectangle Worksurface 24"D x 36"W	HWR2436P	\$446	\$446
2	Freestanding End Panel Support 24"D x 29½"H	HSDEP2429F	\$258	\$516
1	Full-Height Modesty Panel 36"W x 29½"H	HSDMP369	\$263	\$263
TOTAL:			\$1,225	

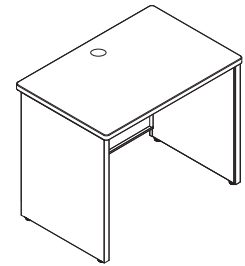

FREESTANDING DESK

QTY	DESCRIPTION	MODEL	LIST PRICE	PRICE EXTENSION
1	Rectangle Worksurface 24"D x 36"W	HWR2436P	\$446	\$446
1	Freestanding End Panel Support 24"D x 29½"H	HSDEP2429F	\$258	\$258
1	Full-Height Modesty Panel 36"W x 29½"H	HSDMP369	\$263	\$263
1	Desk-to-Panel Attachment Kit - Right-Handed 29½"H	HSDDPA29R	\$132	\$132
TOTAL:			\$1,099	

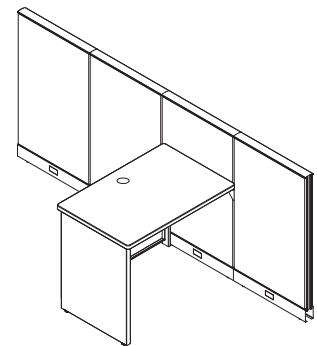

PANEL-ATTACHED DESK

QTY	DESCRIPTION	MODEL	LIST PRICE	PRICE EXTENSION
1	Rectangle Worksurface 24"D x 36"W	HWR2436P	\$446	\$446
1	Rectangle Worksurface 24"D x 60"W	HWR2460P	\$614	\$614
1	Full-Height Modesty Panel 42"W x 29½"H	HSDMP429	\$269	\$269
3	Freestanding End Panel Support 24"D x 29½"H	HSDEP2429F	\$258	\$774
1	Return Kit 29½"H	HSDRK29	\$135	\$135
1	Full-Height Modesty Panel 60"W x 29½"H	HSDMP609	\$285	\$285
TOTAL:			\$2,523	

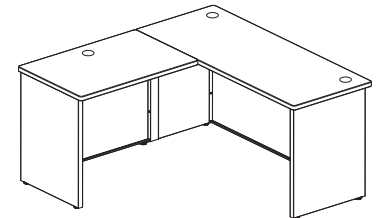

RETURN DESK

Attached to a primary or return desk

QTY	DESCRIPTION	MODEL	LIST PRICE	PRICE EXTENSION
1	Rectangle Worksurface 24"D x 48"W	HWR2448P	\$520	\$520
1	Full-Height Modesty Panel 54"W x 29½"H	HSDMP549	\$283	\$283
1	Freestanding End Panel Support 24"D x 29½"H	HSDEP2429F	\$258	\$258
1	Return Kit 29½"H	HSDRK29	\$135	\$135
1	End Panel Support - Right 24"D x 29½"H	HRVEP2429R	\$287	\$287
1	End Panel Support - Left 24"D x 29½"H	HRVEP2429L	\$287	\$287
1	Rectangle Worksurface 24"D x 60"W	HWR2460P	\$614	\$614
TOTAL:			\$2,384	

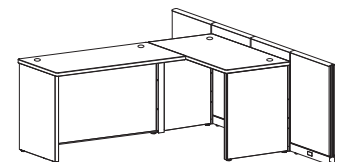

RETURN DESK

Attached to a panel-hung work surface



QTY	DESCRIPTION	MODEL	LIST PRICE	PRICE EXTENSION
1	Rectangle Worksurface 24"D x 42"W	HWR2442P	\$490	\$490
2	Rectangle Worksurface 24"D x 72"W	HWR2472P	\$679	\$1,358
1	Full-Height Modesty Panel 54"W x 29½"H	HSDMP549	\$283	\$283
1	Bridge Kit	HSDBK29	\$257	\$257
2	Full-Height Modesty Panel 72"W x 29½"H	HSDMP729	\$297	\$594
4	Freestanding End Panel Support 24"D x 29½"H	HSDEP2429F	\$258	\$1,032
TOTAL:				\$4,014

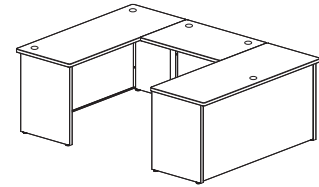

BRIDGE DESK

Attached between two primary desks

QTY	DESCRIPTION	MODEL	LIST PRICE	PRICE EXTENSION
1	Rectangle Worksurface 24"D x 36"W	HWR2436P	\$446	\$446
1	Rectangle Worksurface 24"D x 60"W	HWR2460P	\$614	\$614
1	Peninsula Worksurface 30"D x 60"W	HWP3060P	\$808	\$808
1	Full-Height Modesty Panel 42"W x 29½"H	HSDMP429	\$269	\$269
1	Full-Height Modesty Panel 30"W x 29½"H	HSDMP309	\$260	\$260
2	Freestanding End Panel Support 24"D x 29½"H	HSDEP2429F	\$258	\$516
1	Full-Height Modesty Panel 60"W x 29½"H	HSDMP609	\$285	\$285
1	Freestanding End Panel Support 11"D x 29½"H	HSDEP1129F	\$242	\$242
1	Freestanding Support Leg 24"D x 29½"H	HSDSL2429F	\$271	\$271
1	Support Column for Peninsula	HCNLEG29	\$281	\$281
1	Return Kit 29½"H	HSDRK29	\$135	\$135
TOTAL:				\$4,127

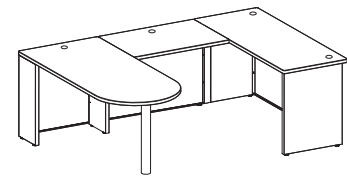

BRIDGE DESK AND PENINSULA

Attached to a primary desk

QTY	DESCRIPTION	MODEL	LIST PRICE	PRICE EXTENSION
1	Corner Worksurface 24"D x 36"W	HWCS3624P	\$608	\$608
2	Stand-Alone Corner Modesty Panel 36"W x 29½"H	HSDCMP3629	\$263	\$526
2	Freestanding End Panel Support 24"D x 29½"H	HSDEP2429F	\$258	\$516
1	Corner Desk Leg 29½"H	HSDDL29	\$219	\$219
TOTAL:				\$1,869

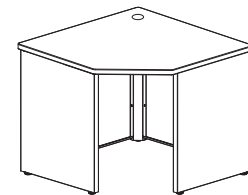

CORNER DESK

Stand-alone

QTY	DESCRIPTION	MODEL	LIST PRICE	PRICE EXTENSION
1	Corner Worksurface 24"D x 36"W	HWCS3624P	\$608	\$608
1	Rectangle Worksurface 24"D x 36"W	HWR2436P	\$446	\$446
1	Stand-Alone Corner Modesty Panel 36"W x 29½"H	HSDCMP3629	\$263	\$263
2	Full-Height Modesty Panel 36"W x 29½"H	HSDMP369	\$263	\$526
2	Freestanding End Panel Support 24"D x 29½"H	HSDEP2429F	\$258	\$516
1	Freestanding Support Leg 24"D x 29½"H	HSDSL2429F	\$271	\$271
1	Corner Desk Leg 29½"H	HSDDL29	\$219	\$219
TOTAL:				\$2,849

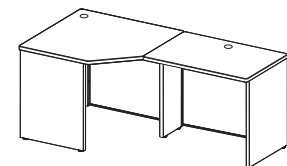

CORNER DESK

With adjacent desk attached at one side



Icon Legend on page 19

ABODE™ Typicals

WORKSTATIONS

QTY	DESCRIPTION	MODEL	LIST PRICE	PRICE EXTENSION
2	Rectangle Worksurface 24"D x 36"W	HWR2436P	\$446	\$892
1	Rectangle Worksurface 24"D x 72"W	HWR2472P	\$679	\$679
1	Corner Worksurface 24"D x 36"W	HWCS3624P	\$608	\$608
1	Full-Height Modesty Panel 42"W x 29½"H	HSDMP429	\$269	\$269
1	Return Kit 29½"H	HSDRK29	\$135	\$135
2	Freestanding Support Leg 24"D x 29½"H	HSDSL2429F	\$271	\$542
3	Freestanding End Panel Support 24"D x 29½"H	HSDEP2429F	\$258	\$774
1	Full-Height Modesty Panel 72"W x 29½"H	HSDMP729	\$297	\$297
3	Full-Height Modesty Panel 36"W x 29½"H	HSDMP369	\$263	\$789
1	Corner Desk Leg 29½"H	HSDDL29	\$219	\$219
TOTAL:			\$5,204	

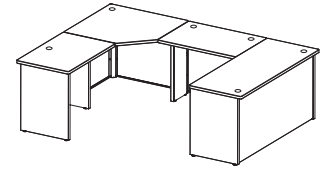

BRIDGE DESK

Attached between corner and primary desk

QTY	DESCRIPTION	MODEL	LIST PRICE	PRICE EXTENSION
1	Jetty - Right-Handed 48"D x 72"W x 24" x 30"	HWJ59ABRP	\$1,082	\$1,082
1	Corner Cove - Right-Handed 72" x 48" x 24" x 24"	HWV95AARP	\$1,008	\$1,008
2	Full-Height Modesty Panel 48"W x 29½"H	HSDMP489	\$280	\$560
1	Stand-Alone Corner Modesty Panel 72"W x 29½"H	HSDCMP7229	\$297	\$297
1	Freestanding End Panel Support 11"D x 29½"H	HSDEP1129F	\$242	\$242
1	Freestanding Support Leg 24"D x 29½"H	HSDSL2429F	\$271	\$271
1	Freestanding End Panel Support 24"D x 29½"H	HSDEP2429F	\$258	\$258
1	Corner Desk Leg 29½"H	HSDDL29	\$219	\$219
1	Support Column	HCNLEG29	\$281	\$281
TOTAL:			\$4,218	

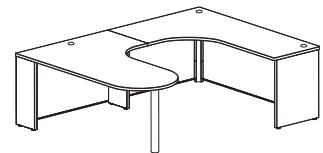

"U" WITH JETTY AND CORNER COVE

QTY	DESCRIPTION	MODEL	LIST PRICE	PRICE EXTENSION
4	Rectangular Worksurface 24"D x 72"W	HWR2472P	\$679	\$2,716
2	Abound® Panel Frame 35"H x 24"W	HRVF3524P	\$310	\$620
2	Abound® Panel Frame 35"H x 48"W	HRVF3548P	\$358	\$716
4	Abound® Fabric Tile 30"H x 24"W	HRVT3024T	\$132	\$528
4	Abound® Fabric Tile 30"H x 48"W	HRVT3048T	\$178	\$712
2	Abound® Frameless Glass 7½"H x 72"W	HRVT072F	\$1,112	\$2,224
2	Abound® Finished End Trim 30"H	HRVC30PF	\$105	\$210
2	Abode™ Desk-to-Panel Attachment Kits - Left 29½"H	HSDDPA29L	\$132	\$264
2	Abode™ Desk-to-Panel Attachment Kits - Right 29½"H	HSDDPA29R	\$132	\$264
4	Abode™ Full-Height Modesty Panel 72"W	HSDMP729	\$297	\$1,188
4	Abode™ Freestanding End Panel 24"D	HSDEP2429F	\$258	\$1,032
2	Contain® Low Credenza, Box/Lateral - Right 48"W	HSCP224818LBFOM	\$2,145	\$4,290
2	Contain® Low Credenza, Box/Lateral - Left 48"W	HSCP224818RBFOM	\$2,145	\$4,290
4	Flagship® Freestanding Support Ped B/B/F	H19717A	\$908	\$3,632
4	Glass Side Mount Screen 60"W x 13"H	HUSGFSM1360	\$1,116	\$4,464
4	Credenza Storage-to-Panel Bracket	HSCAPB	\$264	\$1,056
TOTAL:			\$28,206	

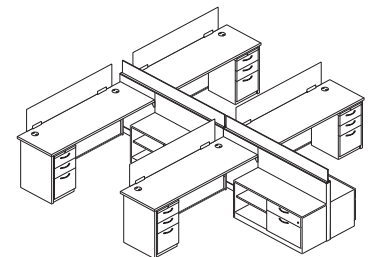

ABODE™ WITH ABOUND®

ABODE™ Typicals



Icon Legend on page 19

WORKSTATIONS

QTY	DESCRIPTION	MODEL	LIST PRICE	PRICE EXTENSION
2	Rectangular Worksurface 24"D x 36"W	HWR2436P	\$446	\$892
1	Corner Worksurface 24"D x 36"W	HWCS3624P	\$608	\$608
2	Abode™ Freestanding End Panel 24"D	HSDEP2429F	\$258	\$516
2	Abode™ Freestanding Support Leg 24"D	HSDSL2429F	\$271	\$542
1	Abode™ Corner Desk Leg 29½"H	HSDDL29	\$219	\$219
4	Abode™ Full-Height Modesty Panel 36"W	HSDMP369	\$263	\$1,052
2	Flagship® Freestanding Support Ped B/B/F	H19717A	\$908	\$1,816
TOTAL:				\$5,645

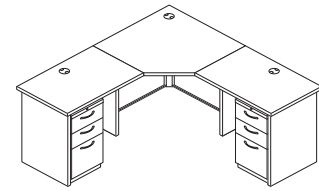

CORNER WITH RETURN

QTY	DESCRIPTION	MODEL	LIST PRICE	PRICE EXTENSION
8	Accelerate® Tackable Panel 65"H x 24"W	HETP6524FP	\$476	\$3,808
2	Accelerate® Tackable Panel 65"H x 48"W	HETP6548FP	\$611	\$1,222
6	Accelerate® Top Cap 24"W	HETC24	\$51	\$306
2	Accelerate® Top Cap 72"W	HETC72	\$134	\$268
4	Rectangular Worksurface 24"D x 72"W	HWR2472P	\$679	\$2,716
4	Rectangular Worksurface 24"D x 48"W	HWR2448P	\$520	\$2,080
2	Accelerate® "T" Connector 65"H	HEC65PTN	\$182	\$364
1	Accelerate® "X" Connector 65"H	HEC65PXN	\$175	\$175
6	Accelerate® Panel Finished End Covers 65"H	HEFEC65P	\$86	\$516
8	Accelerate® Worksurface Bracket Kit	HWSB2	\$62	\$496
4	Flat Bracket 24"D	HHN831124	\$85	\$340
4	Flagship® Freestanding Support Ped B/B/F	H19717A	\$908	\$3,632
2	Abode™ Desk-to-Panel Attachment Kits - Left 29½"H	HSDDPA29L	\$132	\$264
2	Abode™ Desk-to-Panel Attachment Kits - Right 29½"H	HSDDPA29R	\$132	\$264
4	Abode™ Freestanding End Panel 24"D	HSDEP2429F	\$258	\$1,032
4	Abode™ Full-Height Modesty Panel 72"W	HSDMP729	\$297	\$1,188
4	Systems Overhead Storage Flipper Door 48"W	HRVOH48FM	\$835	\$3,340
4	Systems Overhead Storage Shelf 24"W	HRVSH24	\$309	\$1,236
4	Glass Side Mount Screen 42"W x 13"H	HUSGF5M1342	\$1,001	\$4,004
2	"T" Connector	HECST	\$30	\$60
1	"X" Connector	HECSX	\$35	\$35
TOTAL:				\$27,346

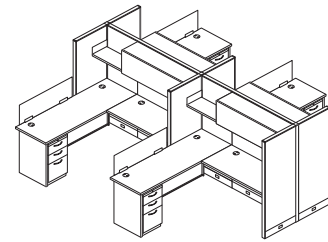

ABODE™ WITH ACCELERATE®

QTY	DESCRIPTION	MODEL	LIST PRICE	PRICE EXTENSION
1	Rectangular Worksurface 24"D x 72"W	HWR2472P	\$679	\$679
1	Rectangular Worksurface 24"D x 48"W	HWR2448P	\$520	\$520
1	Peninsula Worksurface 30"D x 72"W	HWP3072P	\$975	\$975
1	Stack-on Full Clearance w/o Doors 13"D x 72"W x 34¾"H	H386572N	\$1,306	\$1,306
1	Flipper Doors w/ Lock 36"W x 16"H	H387215	\$812	\$812
1	Tackboard for 72"W Hutch 72"	HT72ND	\$730	\$730
1	Support Column for Peninsula 29"H	HCNLEG29	\$281	\$281
2	Abode™ Freestanding End Panel 24"D	HSDEP2429F	\$258	\$516
1	Abode™ Freestanding End Panel 11"D	HSDEP1129F	\$242	\$242
1	Abode™ Freestanding Support Leg 24"D	HSDSL2429F	\$271	\$271
1	Abode™ Return Kit	HSDRK29	\$135	\$135
1	Abode™ Full-Height Modesty Panel 72"W	HSDMP729	\$297	\$297
1	Abode™ Full-Height Modesty Panel 54"W	HSDMP549	\$283	\$283
1	Abode™ Full-Height Modesty Panel 30"W	HSDMP309	\$260	\$260
1	Flagship® 2 Drawer "A" Pull Lateral 30"W	H9170A	\$1,299	\$1,299
TOTAL:				\$8,606

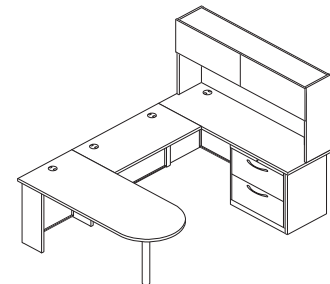

PENINSULA U



Icon Legend on page 19

ABODE™ Typicals

WORKSTATIONS

QTY	DESCRIPTION	MODEL	LIST PRICE	PRICE EXTENSION
2	Rectangular Worksurface 24"D x 72"W	HWR2472P	\$679	\$1,358
1	Height Adjustable Worksurface 24"D x 48"W	HHATW2448CT	\$497	\$497
1	Stack-on Full Clearance w/o Doors 13"D x 72"W x 34¾"H	H386572N	\$1,306	\$1,306
1	Flipper Doors w/ Lock 36"W x 16"H	H387215	\$812	\$812
1	Tackboard for 72"W Hutch 72"	HT72ND	\$730	\$730
2	Abode™ Full-Height Modesty Panel 72"W	HSDMP729	\$297	\$594
4	Abode™ Freestanding End Panel 24"D	HSDEP2429F	\$258	\$1,032
1	Coordinate™ Height Adjustable Base, Rectangle T-Foot	HHATB3S2LT	\$1,167	\$1,167
2	Flagship® 2 Drawer "A" Pull Lateral 30"W	H9170A	\$1,299	\$2,598
TOTAL:				\$10,094

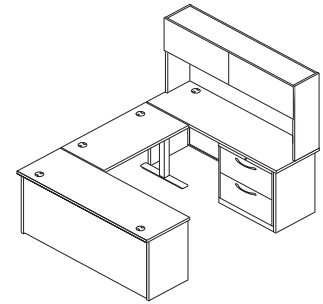

WORKSTATION U

ABODE™ Components

GSA SIN 33721



Icon Legend on page 19

WORKSTATIONS

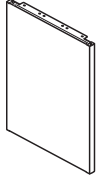

DESCRIPTION	MODEL	SHIP WEIGHT	CUBE	LIST PRICE BY PAINT GRADE	
				P1	P2
Freestanding End Panel Supports					
11"D	HSDEP1129F	15	1.1	\$242	\$271
24"D	HSDEP2429F	25	1.1	\$258	\$287
30"D	HSDEP3029F	30	1.1	\$285	\$314

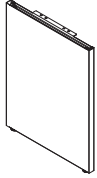

Panel Mounted Full End Panel Supports*					
29½"H x 11"D — Right — Panel Mount	HRVEP1129R	16	1.4	\$266	\$297
29½"H x 11"D — Left — Panel Mount	HRVEP1129L	16	1.4	\$266	\$297
29½"H x 24"D — Right — Panel Mount	HRVEP2429R	21	1.4	\$287	\$318
29½"H x 24"D — Left — Panel Mount	HRVEP2429L	21	1.4	\$287	\$318
29½"H x 30"D — Right — Panel Mount	HRVEP3029R	23	1.4	\$313	\$344
29½"H x 30"D — Left — Panel Mount	HRVEP3029L	23	1.4	\$313	\$344

*Must be connected into panel slots. When an installation of worksurfaces is 8 feet or greater, a full end panel or universal support leg must be used at 90 degree panel junctions or in a shared position to support adjoining worksurfaces.

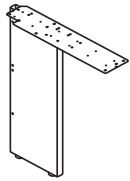

Freestanding Support Leg					
24"D	HSDSL2429F	25	1.1	\$271	\$300
30"D	HSDSL3029F	25	1.1	\$303	\$332

NOTES: To be used when connecting a non-rectangular worksurface to a rectangular worksurface.

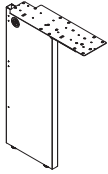

Panel Mounted Support Leg*					
29½"H to support 24"D	HRVCLG24	16	1.4	\$255	\$286
29½"H to support 30"D	HRVCLG30	17	1.4	\$278	\$309

*Must be connected into panel slots. When an installation of worksurfaces is 8 feet or greater, a full end panel or universal support leg must be used at 90 degree panel junctions or in a shared position to support adjoining worksurfaces.





NOTES:

All Abode™ Components are compatible with Abound® and Accelerate® panel systems and Systems Worksurfaces.

HOW TO SPECIFY

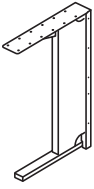
<p>Select Model Number</p> <p>HSDEP1129F . T1</p>	<p>Select Paint Color</p> <p>See page 358</p>
---	---

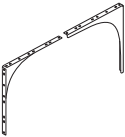

	DESCRIPTION	MODEL	SHIP WEIGHT	CUBE	LIST PRICE BY PAINT GRADE	
					P1	P2
	Abode™ Shared Leg NOTES: To be used when joining two rectangular surfaces. Can be used as a stand-alone support in panel systems. 1/2" radius opening for cord management.	HSDSL29	18	1.5	\$491	\$520
	Corner Desk Leg 29 1/2"H NOTES: Corner desk legs have 90° bend and welded construction.	HSDDL29	7	0.4	\$219	\$248
	Gussets (1 pair) NOTES: Gussets may be used instead of a modesty panel to create freestanding desks 36"W to 60"W.	HSDG	7	0.5	\$152	\$170
	Flat Bracket 24"D 30"D ⓘ Charcoal only.	HHN831124 ⓘ HHN831130	3 3	0.3 0.4	\$85 \$85	N/A N/A

NOTES:

ⓘ All Abode™ Components are compatible with Abound® and Accelerate® panel systems and Systems Worksurfaces.

HOW TO SPECIFY

Select Model Number H S D S L 2 9 .	Select Paint Color See page 358 T 1
---	--

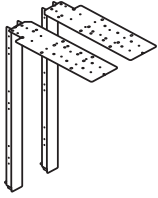

DESCRIPTION

MODEL

SHIP WEIGHT

CUBE

LIST PRICE BY PAINT GRADE

P1

P2

Bridge Kit

29½”H

HSDBK29

10

0.4

\$257

\$286

NOTES: Add 12” to your modesty width when using a Bridge Kit. Bridge Kits include two flat brackets, two modesty panel-to-end panel attachment brackets, and two tie straps.

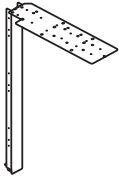

Return Kit

29½”H

HSDRK29

6

0.4

\$135

\$164

NOTES: Add 6” to your modesty width when using a Return Kit. Return Kits include one flat bracket, one modesty panel-to-end panel attachment bracket, and one tie strap.



Desk-to-Panel Attachment Kit

29½”H

HSDDPA29L

5

0.3

\$132

\$143

29½”H

HSDDPA29R

5

0.3

\$132

\$143



Corner with Desk-to-Panel Attachment Kit

29½”H

HSDCPA29L

5

0.3

\$132

\$143

29½”H

HSDCPA29R

5

0.3

\$132

\$143

NOTES: This Attachment Kit utilizes the same modesty panel specification rules as the Freestanding Corner Leg.

HOW TO SPECIFY

Select Model Number

Select Paint Color

See page 358

H S D B K 2 9 .

T 1



	DESCRIPTION	MODEL	SHIP WEIGHT	CUBE	LIST PRICE BY PAINT GRADE	
					P1	P2
	Full-Height Modesty Panel					
	29½" H x 24" W	HSDMP249	5.0 Ⓢ	0.6	\$252	\$270
	29½" H x 30" W	HSDMP309	7.0 Ⓢ	0.6	\$260	\$278
	29½" H x 36" W	HSDMP369	8.0	0.8	\$263	\$281
	29½" H x 42" W	HSDMP429	9.0	0.9	\$269	\$287
	29½" H x 48" W	HSDMP489	11.0	1.0	\$280	\$298
	29½" H x 54" W	HSDMP549	12.0	2.2	\$283	\$301
	29½" H x 60" W	HSDMP609	13.0	2.2	\$285	\$303
	29½" H x 66" W	HSDMP669	15.0	2.6	\$293	\$311
	29½" H x 72" W	HSDMP729	16.0	3.0	\$297	\$315

! To be used in all applications except when connecting a Corner Leg to an End Panel or a Corner Leg to a Shared Leg.

	Full-Height Stand-Alone Corner Modesty Panel					
	29½" H x 36" W	HSDCMP3629	7.0	1.9	\$263	\$281
	29½" H x 42" W	HSDCMP4229	9.0	1.9	\$269	\$287
	29½" H x 48" W	HSDCMP4829	10.0	2.3	\$280	\$298
	29½" H x 60" W	HSDCMP6029	14.0	4.7	\$285	\$303
	29½" H x 72" W	HSDCMP7229	16.0	5.4	\$297	\$315

NOTES: To be used when connecting a Corner Leg to an End Panel or Shared Leg.

	Half-Height Modesty Panel					
	14" H x 24" W	HSDMP244	5.1 Ⓢ	0.4	\$236	\$254
	14" H x 30" W	HSDMP304	6.6 Ⓢ	0.4	\$241	\$259
	14" H x 36" W	HSDMP364	8.1 Ⓢ	0.5	\$245	\$263
	14" H x 42" W	HSDMP424	9.6 Ⓢ	0.6	\$259	\$277
	14" H x 48" W	HSDMP484	11.0 Ⓢ	0.6	\$263	\$281
	14" H x 54" W	HSDMP544	13.0 Ⓢ	0.8	\$266	\$284
	14" H x 60" W	HSDMP604	14.0 Ⓢ	0.8	\$272	\$290
	14" H x 66" W	HSDMP664	16.0 Ⓢ	1.0	\$280	\$298
	14" H x 72" W	HSDMP724	17.0 Ⓢ	1.0	\$283	\$301

	Half-Height Stand-Alone Corner Modesty Panel					
	14" H x 36" W	HSDCMP3614	4.0 Ⓢ	0.5	\$245	\$263
	14" H x 42" W	HSDCMP4214	4.0 Ⓢ	0.6	\$259	\$277
	14" H x 48" W	HSDCMP4814	5.0 Ⓢ	0.6	\$263	\$281
	14" H x 60" W	HSDCMP6014	6.0 Ⓢ	0.8	\$272	\$290
	14" H x 72" W	HSDCMP7214	7.0 Ⓢ	1.0	\$283	\$301

NOTES:

- Desk: Modesty panel width is the same width as the worksurface.
- Return: Modesty panel width is 6" greater than the width of the return worksurface.
- Bridge connecting two rectangular worksurfaces: Modesty panel width is 12" greater than the width of the bridge worksurface.
- Bridge connecting a rectangular worksurface and corner or peninsula: Modesty panel width is 6" greater than the width of the worksurface.
- Corner connecting to an adjacent worksurface: Modesty panel width is the same width as the worksurface.

HOW TO SPECIFY

<p>Select Model Number</p> <p>HSDMP249</p>	<p>Select Paint Color</p> <p>See page 358</p> <p>T1</p>
--	---

ABOUND®

Want to see more? Scan here
to check out hon.com.



WORKSTATIONS



Abound® shown with Mav™ and Ignition® Seating and Preside® Tables.

ABOUND®

Why settle for a one-dimensional, uninspired cubicle when you can choose a workstation with dynamic flexibility, powerful performance, and stunning architectural aesthetics? Abound raises the bar on cohesive solutions that keep us connected, engaged, and productive. With numerous tile styles to choose from — fabric, glass, gallery panels, and more. You can customize Abound to suit any space, from collaborative meeting spaces to private offices and everything in between.



FEATURES

- With multiple tile options, materials and fabrics, Abound supports a variety of work styles and office budgets.
- Top channel lay-in or beltline capabilities expand your cabling capacity.
- Straight lines, crisp edges and rectilinear worksurfaces fit precisely together to create a tailored, architectural presence.
- With a variety of layout options and compatibility with HON storage, height adjustable bases and freestanding desks, the options with Abound are endless.

ABOUT® ORDERING INFORMATION

WORKSURFACES, COUNTERTOPS, CORNER SHELVES W/EDGE BAND, HARD-SURFACE TILES, OVERHEAD STORAGE DOORS*

L1 LAMINATES CODES

Woodgrain

- ◆ Bourbon Cherry H
- ◆ Cognac COGN
- ◆ Field Elm LWFE
- ◆ Florence Walnut LFW1
- ◆ Harvest C
- ◆ Kingswood Walnut LK1I
- ◆ Mahogany N
- ◆ Mocha MOCH
- ◆ Natural Maple D
- ◆ Pinnacle PINC
- ◆ Shaker Cherry F
- ◆ Sterling Ash LSA1

Solid

- ◆ Black P
- ◆ Charcoal S
- ◆ Designer White LDW1
- ◆ Loft LOFT

Patterned

- ◆ Handspun Chestnut LAHC
- ◆ Handspun Dove LAHD
- ◆ Handspun Pearl LAHP
- ◆ Handspun Slate LAHS
- ◆ Silver Mesh B9
- ◆ Steel Mesh A9
- ◆ Gray G2
- ◆ White G1

WORKSURFACES, COUNTERTOPS, CORNER SHELVES W/EDGE BAND, HARD-SURFACE TILES, OVERHEAD STORAGE DOORS* *continued*

L2 LAMINATES CODES

Woodgrain

- ◆ Beigewood LWBE
 - ◆ Fawn Cypress LFC1
 - ◆ Lowell Ash LLA1
 - ◆ Natural Recon LNR1
 - ◆ Phantom Ecru LPE1
 - ◆ Portico Teak LPT1
 - ◆ Skyline Walnut LSW1
- (Door panels not available in L2)*

WORKSURFACE EDGE BAND

- ◆ Beigewood DE
- ◆ Black P
- ◆ Bourbon Cherry H
- ◆ Brownstone EY
- ◆ Charcoal S
- ◆ Cognac COGN
- ◆ Designer White DW
- ◆ Fawn Cypress FC
- ◆ Field Elm FE
- ◆ Florence Walnut FW
- ◆ Fossil EH
- ◆ Greige R
- ◆ Harvest C
- ◆ Kingswood Walnut KI
- ◆ Light Gray Q
- ◆ Loft LOFT
- ◆ Lowell Ash DL
- ◆ Mahogany N
- ◆ Mocha MOCH
- ◆ Muslin T
- ◆ Natural Maple D
- ◆ Natural Recon NR
- ◆ Phantom Ecru PE
- ◆ Pinnacle PINC
- ◆ Platinum K
- ◆ Portico Teak DP
- ◆ Shaker Cherry F
- ◆ Skyline Walnut SW
- ◆ Sterling Ash SA

WORKSURFACE GROMMET

PLASTIC CODES

- ◆ Black P
- ◆ Brownstone EY
- ◆ Charcoal S
- ◆ Fossil EH
- ◆ Greige T5
- ◆ Light Gray Q
- ◆ Loft LOFT
- ◆ Muslin T3
- ◆ Titanium T1
- ◆ Designer White DW
- ◆ Champagne Metallic T4
- ◆ Platinum Metallic T1

FRAMES, TRIM, METAL TILES, CUSTOM BRACKET KIT, WORKSURFACE SUPPORTS

PAINT CODES

- P1**
- ◆ Black P
- ◆ Brownstone P7D
- ◆ Charcoal S
- ◆ Cove P096
- ◆ Designer White PJW
- ◆ Dune P094
- ◆ Fossil P28
- ◆ Greige T5
- ◆ Harbor P097
- ◆ Light Gray Q
- ◆ Loft LOFT
- ◆ Muslin T3
- ◆ Putty L
- ◆ Sage P095
- ◆ Titanium P8T
- P2**
- ◆ Champagne Metallic T4
- ◆ Gunmetal Metallic PR3
- ◆ Platinum Metallic T1
- ◆ Silver PR6
- ◆ Solar Black PBX

DUPLEX/PORTED TILE

PLASTIC CODES

- ◆ Black P
- ◆ Charcoal S
- ◆ Designer White DW
- ◆ Loft LOFT
- ◆ Muslin T3
- ◆ Titanium T1

Recommendations

Paint	Duplex-Data Code
Black P	Black P
Brownstone P7D	Brownstone EY
Charcoal S	Charcoal S
Designer White PJW	Designer White DW
Fossil P28	Charcoal S
Greige T5	Muslin T3
Light Gray Q	Loft LOFT
Loft LOFT	Loft LOFT
Muslin T3	Muslin T3
Putty L	Black P
Silver PR6	Titanium T1
Titanium P8T	Titanium T1
Champagne Metallic T4	Muslin T3
Platinum Metallic T1	Titanium T1

► LAMINATE TOPS

SPECIFY: Model Number.
Laminate
Edge Color
Grommet Color
EXAMPLE: HWR2424P.K8.R.T5

► PANEL FRAMES

SPECIFY: Model Number.
Paint
EXAMPLE: HRVF3524P.T3

Suffix "A"



Satin Chrome
Arch Pull

* Laminate Front Overheads only available in L1 Woodgrain Laminates.

◆◆◆ For lead time information see page 21.

Edge Treatments



"P" Edgeband
(Color must be selected.)

► HOW TO ORDER

- 1) Select desired model numbers.
- 2) Order worksurfaces to correspond to width of panel behind them.
- 3) Add appropriate prefix and suffix if Tee-Span worksurfaces are needed.

ABOUND[®] FABRIC PATTERNS & CODES

PRICE CODE AA

FACTOR	FACT
◇ Bark *	FACT20
◇ Barley *	FACT15
◇ Cascade *	FACT25
◇ Feather *	FACT30

PRICE CODE A

APPOINT	APN
◇ Artichoke	APN11
◇ Blackberry	APN32
◇ Bronze	APN22
◇ Carbon	APN28
◇ Chai	APN12
◇ Cherry	APN30
◇ Dark Pewter	APN17
◇ Dune	APN15
◇ Espresso	APN23
◇ Framboise	APN31
◇ Frost	APN34
◇ Jet	APN27
◇ Lawn	APN25
◇ Mandarin	APN29
◇ Morel	APN09
◇ Nimbus	APN16
◇ Platinum	APN24
◇ Turquoise	APN26

CENTURION CU

Not available on heights over 54"H

◇ Apricot	CU47
◇ Bark	CU25
◇ Black	CU10
◇ Espresso	CU49
◇ Fog	CU03
◇ Frost	CU22
◇ Goldenrod	CU27
◇ Indigo	CU06
◇ Iris	CU50
◇ Iron Ore	CU19
◇ Jade	CU83
◇ Marsala	CU63
◇ Morel	CU24
◇ Navy	CU98
◇ Peacock	CU97
◇ Pear	CU84
◇ Ruby	CU67
◇ Sapphire	CU09

PRICE CODE A *continued*

ETCH*	ECH
◇ Axis	ECH13
◇ Blend	ECH14
◇ Cast	ECH12
◇ Highlight	ECH10
◇ Midtone	ECH11
◇ Outline	ECH08
◇ Shade	ECH09
◇ Tonal	ECH16
◇ Vanish	ECH15

LANDSCAPE* LN

◇ Azure	LN55
◇ Cornsilk	LN15
◇ Drift	LN05
◇ Khaki	LN20
◇ Sheen	LN10
◇ Slate	LN35
◇ Umber	LN25
◇ Urban	LN30

LUCY* LC

◇ Aspen	LC32
◇ Cornsilk	LC30
◇ Dusk	LC22
◇ Fawn	LC33
◇ Graphite	LC34
◇ Mist	LC20
◇ Neutra	LC24
◇ Pewter	LC35
◇ Snowdrop	LC28

PRICE CODE A *continued*

NOBLE	NBLE
◇ Aegean	NBLE18
◇ Amethyst	NBLE19
◇ Aspen	NBLE14
◇ Aster	NBLE20
◇ Blossom	NBLE21
◇ Bluebell	NBLE22
◇ Bordeaux	NBLE01
◇ Brick	NBLE02
◇ Chambray	NBLE10
◇ Chamomile	NBLE23
◇ Clementine	NBLE04
◇ Conifer	NBLE24
◇ Cottage	NBLE25
◇ Darkness	NBLE26
◇ Dawn	NBLE13
◇ Denim	NBLE09
◇ Desert Sand	NBLE27
◇ Dewfall	NBLE28
◇ Dusted Sage	NBLE29
◇ Flax	NBLE30
◇ Grass	NBLE07
◇ Gunmetal	NBLE15
◇ Harmony	NBLE31
◇ Harvest	NBLE12
◇ Ice Caves	NBLE32
◇ Icicle	NBLE33
◇ Inky	NBLE34
◇ Iris	NBLE35
◇ Jade	NBLE06
◇ Knight	NBLE17
◇ Mesa	NBLE03
◇ Monarch	NBLE36
◇ Pacific	NBLE08
◇ Pitch	NBLE37
◇ Queen Bee	NBLE38
◇ Rainforest	NBLE05
◇ Regal	NBLE11
◇ Sandcastle	NBLE39
◇ Sedona	NBLE40
◇ Stormy	NBLE16
◇ Sunbeam	NBLE41
◇ Voyager	NBLE42
◇ Windy Day	NBLE43

NOTES: Analog and Disperse panel fabrics will be applied pattern cut. Disperse will not be available on 72"W panels. Analog is not available on sizes wider than 60".

◆◆◆ For lead time information see page 21.

* Directional fabrics

* Fabric is de-emphasized.

ABOUND® FABRIC PATTERNS & CODES

PRICE CODE A *continued*

REFLECTIONS*	REF
◆ Galvanized	REF29
◆ Ice	REF20
◆ Loggia	REF21
◆ Mistral	REF28
◆ Moonstone	REF23
◆ Pewter	REF22
◆ Stainless	REF24
◆ Vanilla	REF25
◆ Winter	REF27

REFUGE*	RFG
◆ Artesian	RFG96
◆ Dune	RFG92
◆ Eclipse	RFG90
◆ Frost	RFG93
◆ Glacier	RFG91
◆ Mineral	RFG98
◆ Tidal	RFG94

TEMPEST*	TP
◆ Dragonfly	TP30
◆ Frost	TP15
◆ Full Stream	TP80
◆ Gold Rush	TP10
◆ Slate	TP45
◆ Tumbleweed	TP70
◆ Wind Chill	TP40
◆ Zebra	TP35

VAST	VST
◆ Atmosphere	VST06
◆ Bay	VST04
◆ Beach	VST11
◆ Country Side	VST13
◆ Desert	VST12
◆ Garden	VST02
◆ Grasslands	VST03
◆ Highway	VST09
◆ Mountain Range	VST08
◆ Ocean	VST07
◆ Open Air	VST05
◆ Tundra	VST10
◆ Vineyard	VST01

PRICE CODE B

ANALOG*	ANLG
◆ Album*	ANLG06
◆ Cartridge*	ANLG04
◆ Cassette*	ANLG09
◆ Dial*	ANLG02
◆ Media*	ANLG08
◆ Reel*	ANLG07
◆ Signal*	ANLG03
◆ Stereo*	ANLG01
◆ Track*	ANLG05

COAST*	COA
◆ Channel	COA14
◆ Dune	COA03
◆ Headlands	COA10
◆ Marsh	COA02
◆ Pebble	COA12
◆ Pier	COA13
◆ Shoal	COA01
◆ Silt	COA06
◆ Tide	COA08

DISPERSE*	DISP
◆ Autumn	DISP03
◆ Branch	DISP10
◆ Coffee Bean	DISP13
◆ Dusk	DISP09
◆ Emerald City	DISP08
◆ Gold Rush	DISP02
◆ Igloo	DISP11
◆ Ink	DISP06
◆ Mist	DISP12
◆ Oatmeal	DISP15
◆ Prince	DISP07
◆ Reservoir	DISP01
◆ Rose	DISP04
◆ Spring	DISP05
◆ Steel	DISP16
◆ Taupe	DISP14

PRICE CODE B *continued*

MICA*	MCA
◆ Anthracite	MCA11
◆ Breeze	MCA18
◆ Bronze	MCA13
◆ Buff	MCA14
◆ Cremini	MCA17
◆ Crystal	MCAWIT
◆ Dew	MCA20
◆ Dove	MCA12
◆ Fresh	MCA16
◆ Mineral	MCA15
◆ Nectar	MCA19
◆ Shale	MCA10

SPIN*	SPIN
◆ Alabaster	SPIN02
◆ Cavern	SPIN03
◆ Cobblestone	SPIN04
◆ Ember	SPIN06
◆ Flame	SPIN07
◆ Heron	SPIN13
◆ Oat	SPIN01
◆ Ocean	SPIN12
◆ Plum	SPIN15
◆ Pool	SPIN11
◆ Raven	SPIN10
◆ Rhubarb	SPIN14
◆ Tropic	SPIN08
◆ Willow	SPIN05

PRICE CODE B *continued*

TERRAIN*	TRRN
◆ Bay	TRRN05
◆ Bayou	TRRN35
◆ Canyon	TRRN30
◆ Cliff	TRRN45
◆ Crest	TRRN25
◆ Delta	TRRN10
◆ Plateau	TRRN15
◆ Ridge	TRRN20
◆ Valley	TRRN40

NOTES: Disperse panel fabric is applied pattern cut and is not available on 72"W Accelerate® panels or on 66"W tackboards, Voi® screens, and Empower®.

Analog panel fabric is applied pattern cut and is not available on 60"W or wider tackboards, Voi® screens, and Empower®.

◆◆◆ For lead time information see page 21.

* Directional fabrics

* Fabric is de-emphasized.

ABOUND[®] Typicals



Icon Legend on page 19

WORKSTATIONS

QTY	DESCRIPTION	MODEL	LIST PRICE	PRICE EXTENSION
1	Flagship Series Pedestal "R" Pull Freestanding B/B/F	H19723R	\$975	\$975
1	Flagship 30"W 2-Drw "R" Pull Lateral 30"W x 28"H x 18"D	H9170R	\$1,299	\$1,299
2	Electrical Power Harness 3-1 & 2-2 Systems 36"W	HH871236	\$271	\$542
1	Circuit 1	HH873501	\$58	\$58
1	Circuit 4	HH873504	\$58	\$58
1	Base In-Feed Cable Base 3-1 & 2-2 Systems	HH879072	\$303	\$303
2	Abound Finished End Painted 65"	HRVC65PF	\$133	\$266
3	Abound L Connector Painted 65"	HRVC65PL	\$217	\$651
6	Abound Panel Frame 65"H x 36"W	HRVF6536P	\$382	\$2,292
6	Abound Top Cap Trim 36"W	HRVTC36	\$80	\$480
1	Cantilever One Pair 24"D	HCTL242	\$110	\$110
24	Abound Segment Bar 36"W	HRVFSB36	\$32	\$768
1	Abound Overhead Metal Flipper Door 36"	HRVOH36FM	\$761	\$761
24	Abound Fabric Tile 15"H x 36"W	HRVT1536T	\$99	\$2,376
12	Abound Fabric Tile 30"H x 36"W	HRVT3036T	\$134	\$1,608
1	Systems Rectangular Worksurface Edgeband 24"D x 36"W	HWR2436P	\$446	\$446
1	Systems Left Corner Cove Worksurface Edgeband 72" x 36" x 24" x 24"	HWV93AALP	\$795	\$795
TOTAL:				\$13,788

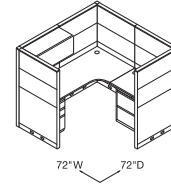

L-SHAPE WORKSTATION
72"W x 72"D

QTY	DESCRIPTION	MODEL	LIST PRICE	PRICE EXTENSION
1	Electrical Power Harness 3-1 & 2-2 Systems 48"W	HH871248	\$286	\$286
1	Circuit 1	HH873501	\$58	\$58
1	Circuit 4	HH873504	\$58	\$58
1	Base In-Feed Cable Base 3-1 & 2-2 Systems	HH879072	\$303	\$303
1	Overhead Cabinet w/Sliding Door 48"W x 14 1/4"D x 14"H	HLSL1448S	\$1,446	\$1,446
1	Mobile Ped 20" x 15 1/8" x 21 1/2"	HLSL2016MP2	\$1,070	\$1,070
1	Ped Cushion (Fabric Grade 2) 20" x 15 1/8" x 1"	HLSL2016PH2	\$442	\$442
1	Stack-on Storage Panel Mounted Bracket	HLSLPMB	\$175	\$175
2	Rectangle Worksurface 24"D x 48" W	HLSLR2448	\$405	\$810
1	Personal Storage Tower (RH) 24"D x 24"W x 65"H	HLSLW446RP	\$3,493	\$3,493
1	Abound Variable Height Finished End Painted 15"	HRVC15PFV	\$87	\$87
1	Abound Finished End Painted 50"	HRVC50PF	\$126	\$126
1	Abound L Connector Painted 50"	HRVC50PL	\$204	\$204
1	Abound Finished End Painted 65"	HRVC65PF	\$133	\$133
2	Abound L Connector Painted 65"	HRVC65PL	\$217	\$434
1	Abound Panel Frame 50"H x 24"W	HRVF5024P	\$340	\$340
1	Abound Panel Frame 50"H x 48"W	HRVF5048P	\$388	\$388
3	Abound Panel Frame 65"H x 24"W	HRVF6524P	\$369	\$1,107
1	Abound Panel Frame 65"H x 48"W	HRVF6548P	\$422	\$422
4	Abound Top Cap Trim 24"W	HRVTC24	\$49	\$196
2	Abound Top Cap Trim 48"W	HRVTC48	\$91	\$182
1	Flat Bracket 24"D	HHN831124	\$85	\$85
2	Abound Segment Bar 24"W	HRVFSB24	\$31	\$62
2	Abound Segment Bar 48"W	HRVFSB48	\$34	\$68
1	Abound 15" High Clear Glass Tile 15"H x 24"W	HRVT1524G	\$617	\$617
1	Abound 15" High Clear Glass Tile 15"H x 48"W	HRVT1548G	\$792	\$792
2	Abound Fabric Tile 30"H x 24"W	HRVT3024T	\$120	\$240
2	Abound Fabric Tile 30"H x 48"W	HRVT3048T	\$161	\$322
6	Abound Fabric Tile 60"H x 24"W	HRVT6024T	\$177	\$1,062
2	Abound Fabric Tile 60"H x 48"W	HRVT6048T	\$285	\$570
1	Bracket to Attach Towers to Worksurfaces	HSTB2W1	\$112	\$112
2	Worksurface Bracket Kit	HWSB2	\$62	\$124
TOTAL:				\$15,814

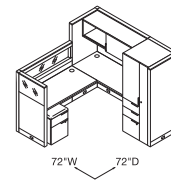

L-SHAPE WORKSTATION WITH STORAGE TOWER
72"W x 72"D



Icon Legend on page 19

ABOUND® Typicals

WORKSTATIONS

QTY	DESCRIPTION	MODEL	LIST PRICE	PRICE EXTENSION
2	Electrical Pass-Thru Cable 3-1 & 2-2 Systems 60"W	HH871160	\$181	\$362
1	Electrical Power Harness 3-1 & 2-2 Systems 24"W	HH871224	\$271	\$271
1	Circuit 1	HH873501	\$58	\$58
1	Circuit 2	HH873502	\$58	\$58
1	Circuit 3	HH873503	\$58	\$58
1	Circuit 4	HH873504	\$58	\$58
1	Base In-Feed Cable Base 3-1 & 2-2 Systems	HH879072	\$303	\$303
6	Abound Finished End Painted 50"	HRVC50PF	\$126	\$756
2	Abound T Connector Painted 50"	HRVC50PT	\$204	\$408
1	Abound X Connector Painted 50"	HRVC50PX	\$198	\$198
6	Abound Panel Frame 50"H x 24"W	HRVF5024P	\$340	\$2,040
2	Abound Panel Frame 50"H x 60"W	HRVF5060P	\$427	\$854
6	Abound Top Cap Trim 24"W	HRVTC24	\$49	\$294
2	Abound Top Cap Trim 60"W	HRVTC60	\$111	\$222
8	Worksurface Bracket Kit	HWSB2	\$62	\$496
12	Abound Segment Bar 24"W	HRVFSB24	\$31	\$372
4	Abound Segment Bar 60"W	HRVFSB60	\$35	\$140
4	Abound Open Shelf 60"	HRVSH60	\$473	\$1,892
12	Abound Fabric Tile 15"H x 24"W	HRVT1524T	\$88	\$1,056
4	Abound Fabric Tile 15"H x 60"W	HRVT1560T	\$126	\$504
12	Abound Fabric Tile 30"H x 24"W	HRVT3024T	\$120	\$1,440
4	Abound Fabric Tile 30"H x 60"W	HRVT3060T	\$182	\$728
4	Systems Rectangular Worksurface Edgeband 24"D x 60"W	HWR2460P	\$614	\$2,456
TOTAL:			\$15,024	

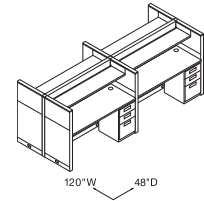

TOUCH-DOWN STATION
120"W x 48"D

QTY	DESCRIPTION	MODEL	LIST PRICE	PRICE EXTENSION
2	External Stiffener 72"W	HLSLZ5SC72	\$152	\$304
2	Abound Panel Frame 35"H x 30"W	HRVF3530P	\$319	\$638
4	Abound Fabric Tile 30"H x 30"W	HRVT3030T	\$125	\$500
4	Abound Panel Frame 35"H x 36"W	HRVF3536P	\$325	\$1,300
8	Abound Fabric Tile 30"H x 36"W	HRVT3036T	\$134	\$1,072
2	Abound Panel Frame 35"H x 42"W	HRVF3542P	\$337	\$674
4	Abound Fabric Tile 30"H x 42"W	HRVT3042T	\$152	\$608
2	Abound Finished End Painted 35"	HRVC35PF	\$105	\$210
2	Abound L Connector Painted 35"	HRVC35PL	\$182	\$364
4	Frameless Frosted Glass 15"H x 72"W	HRVT1572F	\$1,246	\$4,984
2	Contain® 35 LB Credenza Counterweight Kit	HSCACW35	\$265	\$530
2	Contain® Credenza Cushion (Fabric Grade 2) 36"W x 18"D	HSCAUC1836	\$416	\$832
2	Worksurface O-Leg 6½"H x 30"W	HSCAWS6530	\$306	\$612
1	Contain® Footed Metal Credenza with Laminate Front, Left 22" x 72" x 18"	HSCF227218RBFOL	\$3,068	\$3,068
1	Contain® Footed Metal Credenza with Laminate Front, Right 22" x 72" x 18"	HSCF227218LBFOL	\$3,068	\$3,068
2	Systems Rectangular Worksurface Edgeband 30"D x 72"W	HWR3072P	\$761	\$1,522
2	Worksurface Bracket Kit	HWSB2	\$62	\$124
TOTAL:			\$20,410	

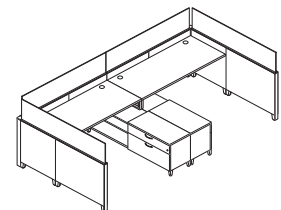

U-SHAPE TEAMING STATION
144"W x 72"D

ABOUND® Open Base Typicals



Icon Legend on page 19

WORKSTATIONS

QTY	DESCRIPTION	MODEL	LIST PRICE	PRICE EXTENSION
1	Abound Panel Frame 50"H x 24"W	HRVF5024P	\$340	\$340
2	Abound Fabric Tile 30"H x 24"W	HRVT3024T	\$120	\$240
1	Abound 15" High Clear Glass Tile 12"H x 24"W	HRVT1524G	\$617	\$617
2	Abound 24"W Segment Bar	HRVFSB24	\$31	\$62
1	Abound Panel Frame 50"H x 48"W	HRVF5048P	\$388	\$388
2	Abound Fabric Tile 30"H x 48"W	HRVT3048T	\$161	\$322
1	Abound 15" High Clear Glass Tile 15"H x 48"W	HRVT1548G	\$792	\$792
2	Abound 48"W Segment Bar	HRVFSB48	\$34	\$68
3	Abound Panel Frame 65"H x 24"W	HRVF6524P	\$369	\$1,107
6	Abound Fabric Tile 60"H x 24"W	HRVT6024T	\$177	\$1,062
1	Abound Panel Frame 65"H x 48"W	HRVF6548P	\$422	\$422
2	Abound Fabric Tile 60"H x 48"W	HRVT6048T	\$285	\$570
1	Overhead Cabinet with Sliding Door 48"W x 14¼"D x 14"H	HLSL1448S	\$1,446	\$1,446
1	Mobile Ped 20" x 15½" x 21½"	HLSL2016MP2	\$1,070	\$1,070
1	Ped Cushion 20" x 15½" x 1"	HLSL2016PH2	\$442	\$442
1	Stack-on Storage Panel Mounted Bracket	HLSLPMB	\$175	\$175
1	Personal Storage Tower (RH) 24"D x 24"W x 65"H	HLSLW446RP	\$3,493	\$3,493
1	Abound Variable Height Finished End Painted 15"	HRVC15PFV	\$87	\$87
1	Abound Finished End Painted 50"	HRVC50PF	\$126	\$126
1	Abound L Connector Painted 50"	HRVC50PL	\$204	\$204
1	Abound Finished End Painted 65"	HRVC65PF	\$133	\$133
2	Abound L Connector Painted 65"	HRVC65PL	\$217	\$434
1	Bracket to Attach Towers to Worksurfaces	HSTB2W1	\$112	\$112
2	Systems Rectangular Worksurface Edgeband 24"D x 48"W	HWR2448P	\$520	\$1,040
2	Worksurface Bracket Kit	HWSB2	\$62	\$124
1	Abound Top Cap Trim 24"W	HRVTC24	\$49	\$49
1	Abound Top Cap Trim 48"W	HRVTC48	\$91	\$91
1	Abound Top Cap Trim 72"W	HRVTC72	\$136	\$136
1	Flat Bracket 24"D	HHN831124	\$85	\$85
TOTAL:			\$15,237	

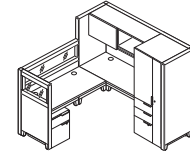

**L-SHAPE WORKSTATION
WITH STORAGE TOWER**

72"W x 72"D

ABOUT® FRAMES OVERVIEW

PANEL FRAME

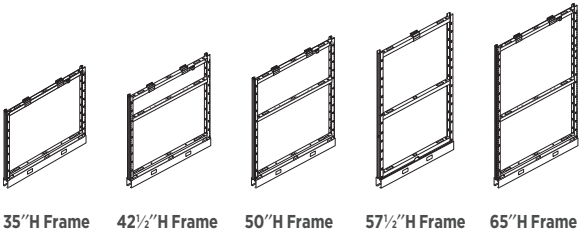

35" H Frame 42½" H Frame 50" H Frame 57½" H Frame 65" H Frame

OPEN BASE PANEL FRAME

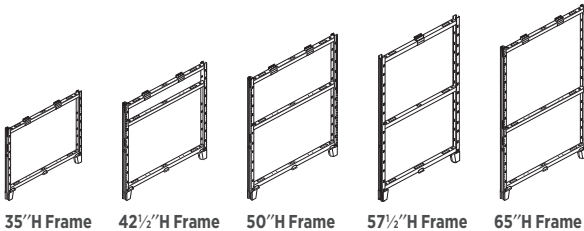

35" H Frame 42½" H Frame 50" H Frame 57½" H Frame 65" H Frame

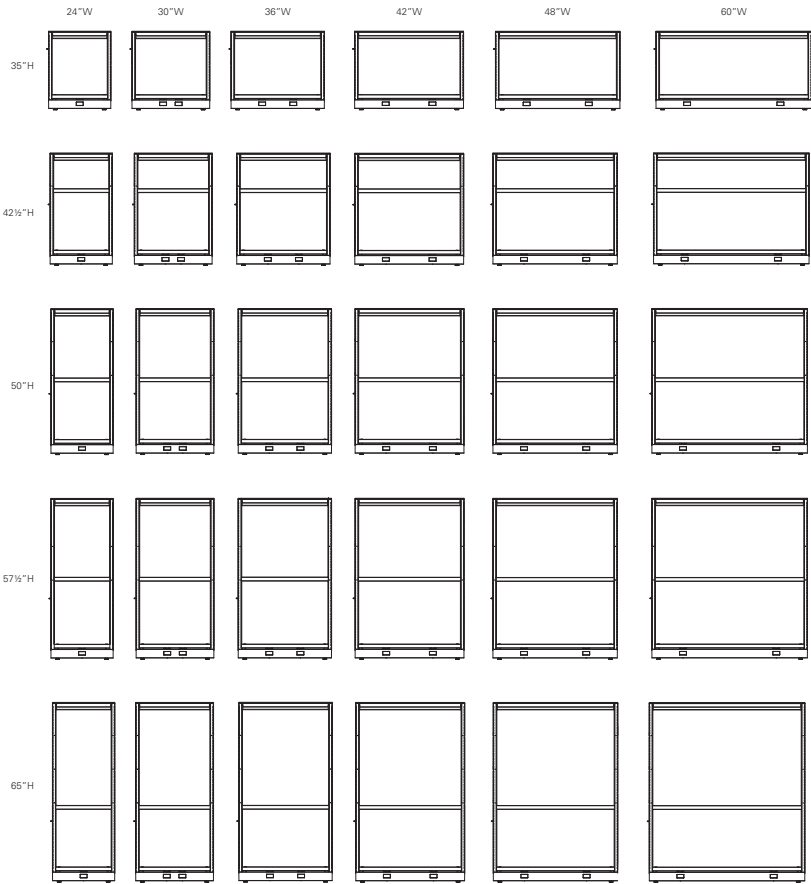

STACKING FRAMES

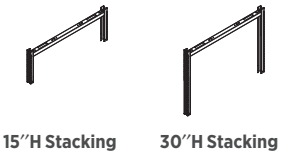

15" H Stacking 30" H Stacking

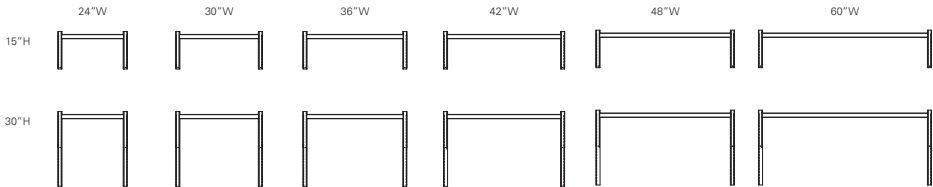

Reminder: Panel frame top caps must be ordered separately. Please refer to page 387. Do not specify top caps when putting frameless glass on top of the panel frame or when using a countertop worksurface.

ABOUND[®] FRAMES OVERVIEW

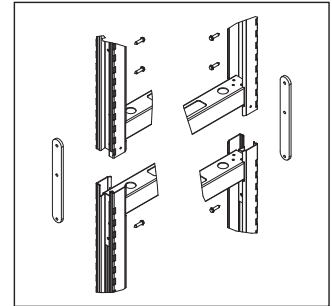
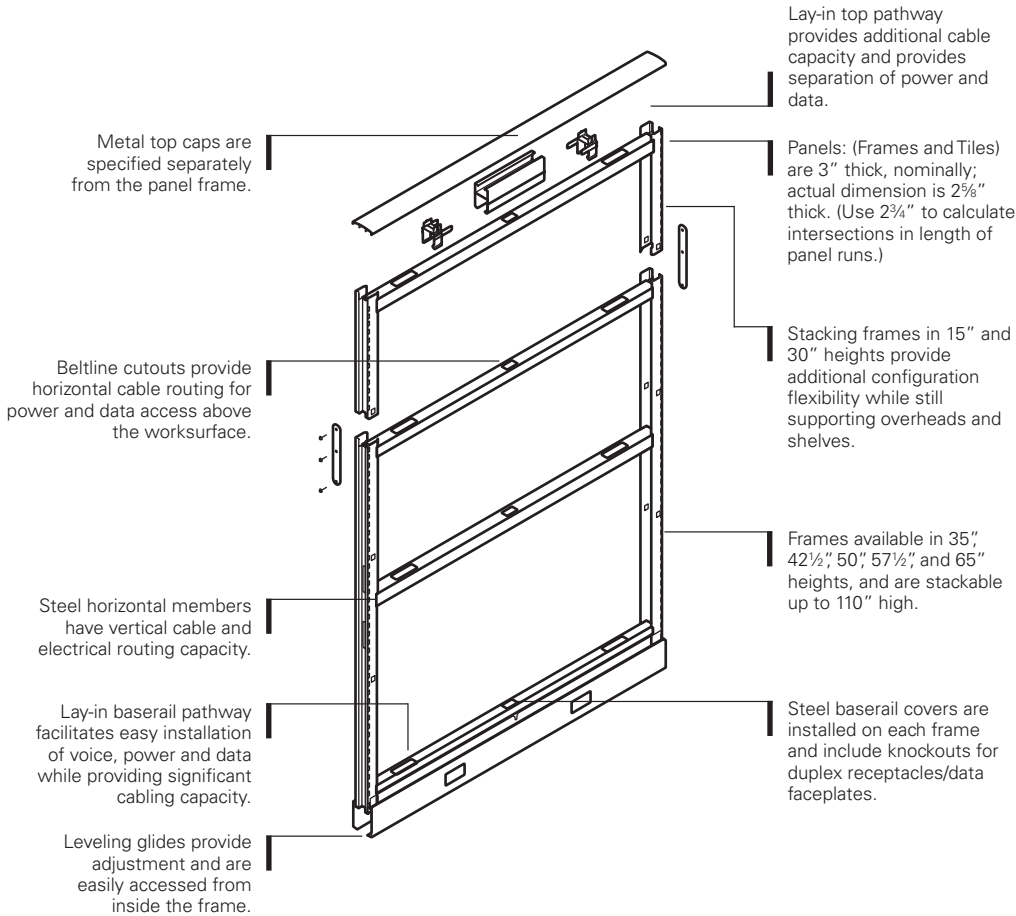

Stacking connection provides a solid metal-to-metal connection, allowing the stacking frame to accept hang-on components, per configuration guidelines.

Construction and Features

Specifications—formed, steel vertical members, with tubular steel horizontal members are welded into a sturdy, structural panel frame. Panel frames are shipped with base pathway covers installed.

Tiles, Panel Top Caps, and Segment Bars are ordered separately.

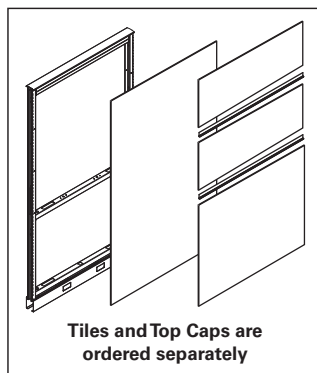

Additional design and specification information available at hon.com.

ABOUT® FRAMES OVERVIEW

FRAME DIMENSIONS (ACTUAL)

Depth: 2⁵/₈" (use 2³/₄" to calculate intersections in length of panel run)

Widths: 24", 30", 36", 42", 48", 60"

Heights*: Painted trim: 34¹/₂", 42", 49¹/₂", 57"H, 64¹/₂"

Stacking Frames: 15"H, 30"H

*with levelers fully retracted

Stacking frames can be added to the top of any 35"H, 50"H or 65"H frame. Adding stacking frames to 42¹/₂"H and 57¹/₂"H frames is not recommended due to inconsistencies in segmentation. 15"H and 30"H stacking frames can be used to add up to 45" of additional height to a standard frame. Do not combine differing frame widths in a single stack.

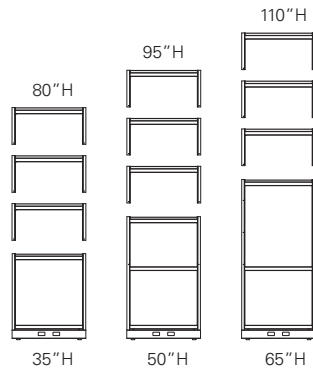

NOTE: When stacking on 42¹/₂"H or 57¹/₂"H frames, panel slots will be off by ¹/₂" compared to any other height panel. When stacking on 42¹/₂"H and 57¹/₂"H frames, hanging accessories will be ¹/₂" off in height compared to accessories hanging on panels at any height other than 42¹/₂"H and 57¹/₂"H.

BUILDING HORIZONTALLY WITH ABOUT FRAMES

Important planning guidelines: For adequate stability, one of two methods of stabilization must be adhered to:

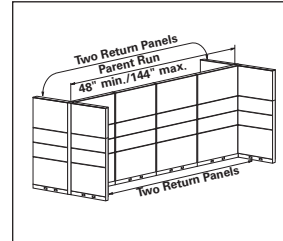

Method 1—Opposing returns:

A parent run must be a minimum of 48" and a maximum of 144" between return panels. The parent run must have a minimum of two return panels running in opposing directions on each end of run.

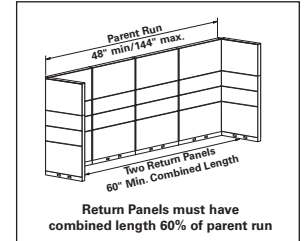

Method 2—Single-sided

Spine Length:	90 degree connector	120 degree connector
48"-108"	72" total	84" total
110"-132"	84" total	96" total
134"-144"	96" total	108" total

ABOUND[®] FRAMES OVERVIEW

INTERSECTING CONNECTIONS

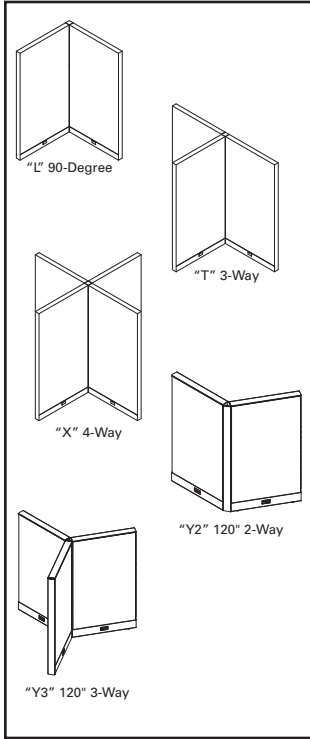

“L”, “T”, “X”, “Y2” and “Y3” connector kits are used when connecting frames at intersecting runs. For “L”, “T” and “X” connector kits, add $2\frac{3}{4}$ ” to the total length of the panel run for each intersection, whether located in the middle or at the end of the run.

Wall starter kits provide a means to affix a panel run to a permanent building wall. Kit adds $1\frac{1}{2}$ ” to length of panel run.

Segment bars — horizontal cross members required between tile segments. Must be specified on each side of frame. One Segment Bar is needed for each reveal between tiles.

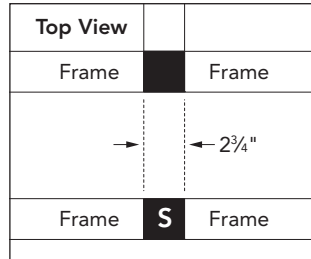
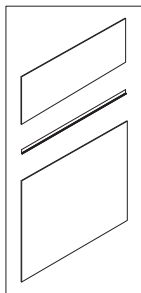

Extended straight connector kit “S” can be used to keep continuous runs dimensionally consistent with opposing panel runs which incorporate “T” or “X” intersections. (Add $2\frac{3}{4}$ ” to the length of the run for every extended straight connector used.)

IN-LINE CONNECTIONS

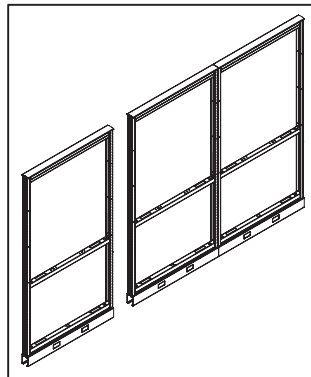

Direct connections between same height frames in a continuous run are accomplished with provided hardware. There is no incremental increase in dimension along the run.

END OF RUN

Finished end trim must be specified for the unconnected sides of panel frames. The Abound end trim adds $\frac{3}{8}$ ” to the length of the panel run. When adding a stacking frame, order finished end trim in the height that matches the stacking frame height. Move the end cap from the standard frame end trim to the stacking frame end trim.

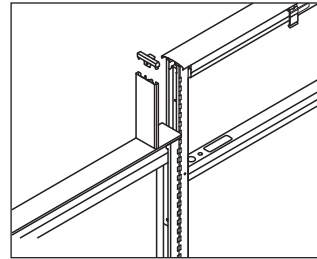

IN-LINE VARIABLE HEIGHT TRIM

In-line connections between different height panels require trim to cover the exposed frame of the taller panel. The bottom of the trim is contoured to match the profile of the frame top cap.

Multiple-height connections are accomplished by combining standard height panel connectors (35”H, 42 $\frac{1}{2}$ ”H, 50”H, 57 $\frac{1}{2}$ ”H, and 65”H) with shorter connectors (7”H, 15”H, 22”H, and 30”H). Start from the bottom-up — select the standard connector that corresponds to the height and connection type of the tallest panel, then use the shorter connectors for variable height and connector top cap trim. (See examples.)

Example 1
1 ea. 50”H T-Connector
1 ea. 15”H S-Connector

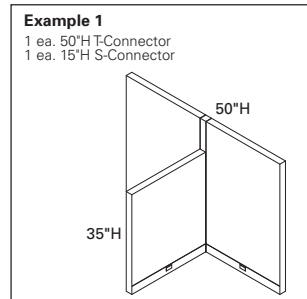

In variable height “T” connections — as shown above — you would use the connectors as indicated.

Example 2
Connectors required:
1-35”H “X”
1-7”H “T”
1-7”H “L”
1-15”H “FT”

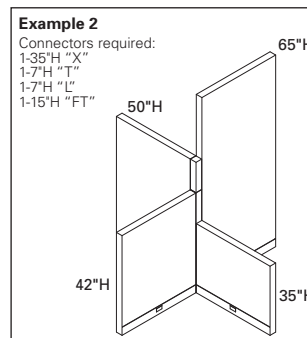

Example 3
Connectors required:
1-50”H “L”
1-15”H Variable Height Trim over Connector

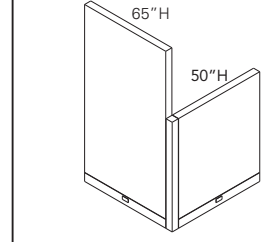

Example above represents Abound variable height “L” for 65” to 50” connection over connector.

VARIABLE HEIGHT CONNECTION TRIM

L, X and T connections between different height panels require trim to cover the exposed frame of the taller panel. The bottom of the trim is flat to match the profile of the Universal Connector top cap. Models are designated as “Variable Height Finished End over Connector Trim”. For variable height connections in a Y configuration, contact the HON Product Solutions group.

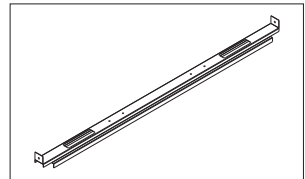

OPTIONAL STIFFENER SUPPORT

Stiffener supports can be used to provide additional rigidity to a panel when fabric tiles are on both sides of the frame. May also be used for routing power/data at non-standard heights.

ABOUT® CONNECTOR OVERVIEW

CONNECTOR KITS — ABOUT

- “L” 90° Connector Kit
- “T” 3-way Connector Kit
- “X” 4-way Connector Kit
- “S” “S” Extended Straight Connector Kit
- “Y2” 2-way 120° Connector Kit
- “Y3” 3-way 120° Connector Kit
- “W” Wall Starter Kit
- “F” End Trim Kit
- “V” Variable Height Finished End
- “FT” Variable Height Finished End over Connector

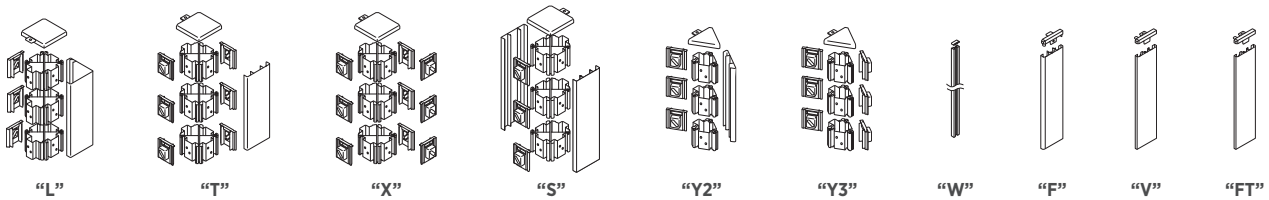

- About Connector Kits include universal connector block(s), bracket clips and painted metal trim.
- The universal connector block can be used for an L, T, X, or Extended Straight connections, simplifying staging and installation at the project site as well as future reconfigurations.
- Bracket clips are attached to the connector blocks as needed based upon connection type.
- While the connectors themselves are universal, About connector kits must be specified by connection type (X, L, T, S, 120 degree) in order to receive the correct type of trim.

CHAMFERED TRIM*

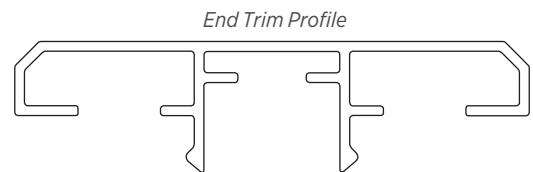
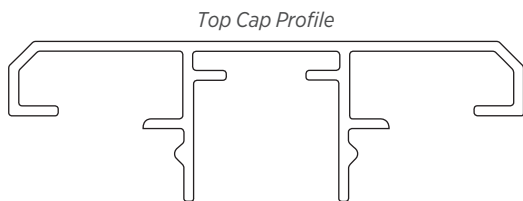

FLAT TRIM

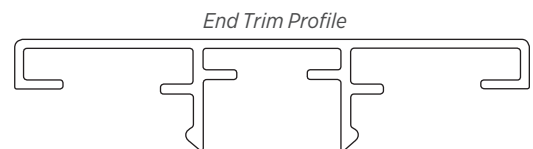
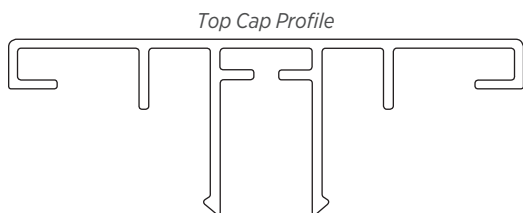

*Used on all products produced prior to July 2021.

ABOUND[®] TILE OVERVIEW

About tiles come in a variety of styles.

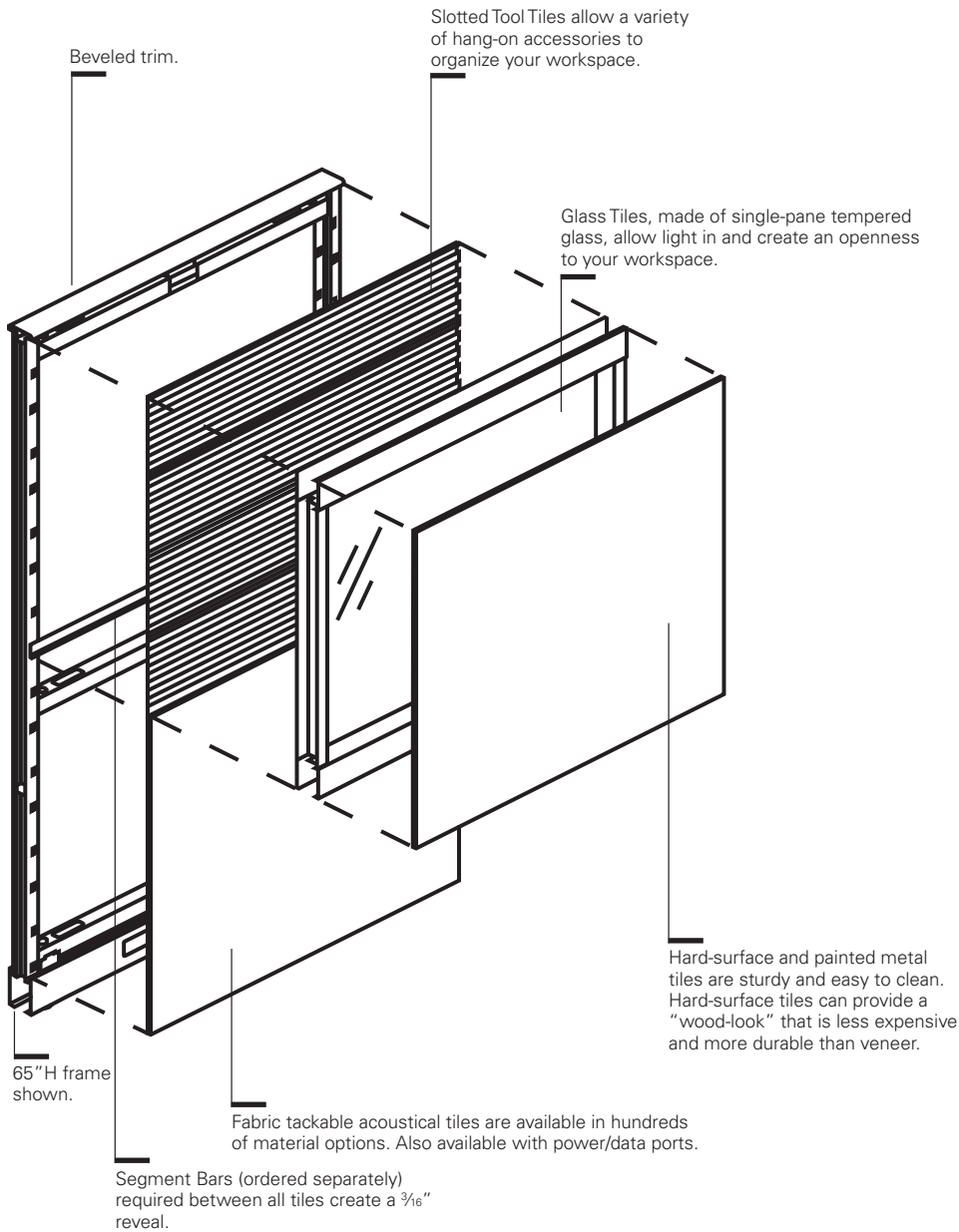

*Aesthetics of opposing tile surface and/or frame interior should be considered when selecting light-colored sheer materials.

ABOUT® SPECIFYING/DESIGN GUIDE

Tile Heights

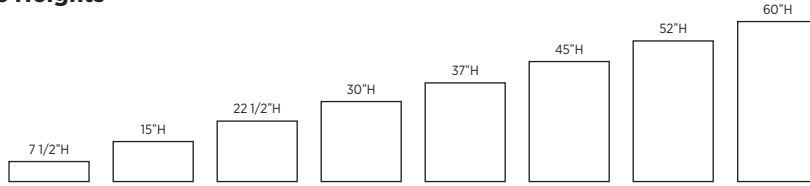

Monolithic tiles are 5" shorter than frame heights to account for top trim and base raceway.

Typical Tile Height Configurations

Segment bars are required between any two tiles — order separately based on tile configuration on each side of frame. Note: Most CAD specification programs will calculate quantity of segment bars required.

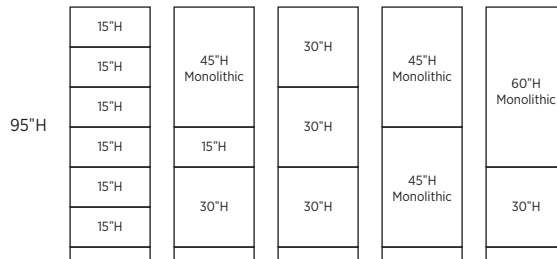
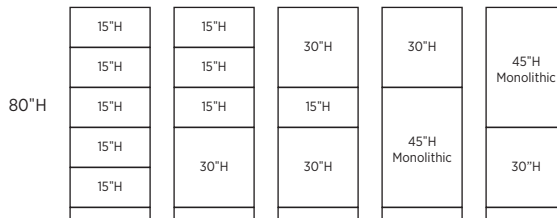
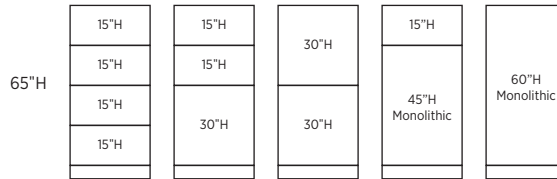
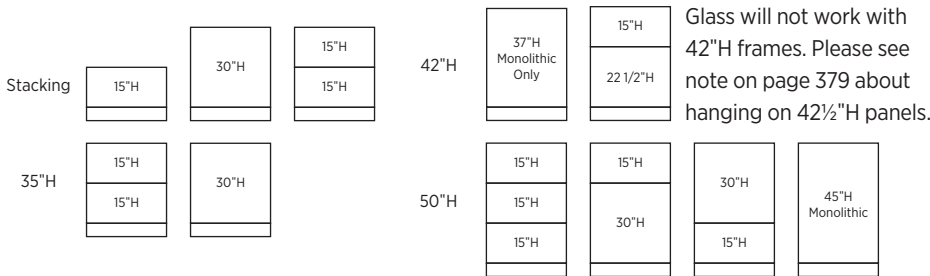

*Additional tile combinations to those shown above are possible; heights above 65" require stacking frames - maximum height is 110".

To calculate the total height of tiles(s) required, deduct 5" (height of base/top trim) from the total nominal panel height.

EXAMPLE: 65" H Frame takes 2 30" H tiles. $65 - 5 = 2 \times 30$ or $45 + 15$

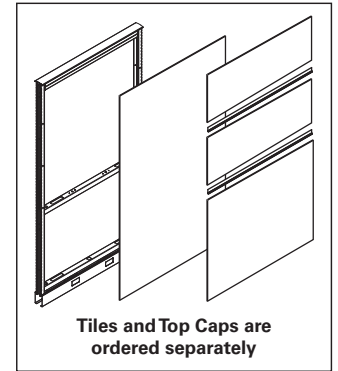

Tiles can be ordered in the size that matches the frame height plus the stacker height.

EXAMPLE: If you are using a 35" H frame plus a 30" H stacker, you can order 2 - 30" H tiles or 1 - 60" H tile.

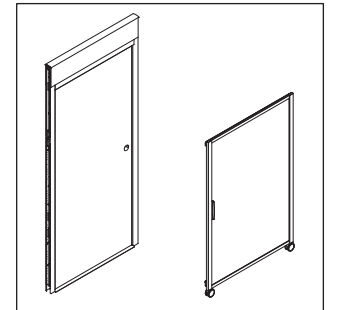

Door panels include frame, 42" W door, hinges and attaching hardware. Two 7½" H fabric tiles for the top of the door frame are required and ordered separately (HRVDO742T).

Sliding doors are available in 50", 65", and 80" H models and can mount to 30", 36", 42", and 48" W panels. The doors provide a 36" W opening and are 42" W, nominally. The doors ship non-handed. A Mounting Bracket Kit must be ordered for each door corresponding to the mounting panel's width (30", 36", 42", or 48" W).

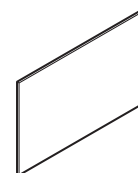

Hard-surface Tiles include tile and Custom Bracket Kit.

ABOUND[®] SPECIFYING/DESIGN GUIDE

WORKSTATIONS

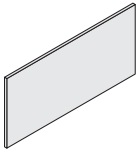

Fabric Tackable Acoustical Tile

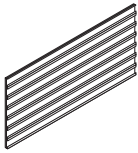

Slotted Tool Tile

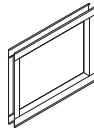

Glass Tile

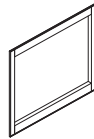

Pass-thru Tile

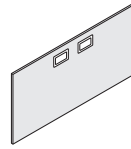

Fabric Tackable Acoustical Ported Tile

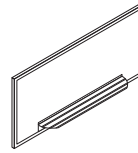

Markerboard Tile
*Markerboard tray ordered separately

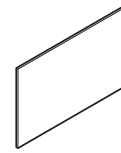

Hard-surface Tiles

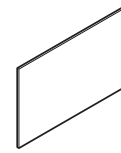

Painted Metal Tile

Tiles — Tackable Acoustical, Tackable Acoustical/Ported

	24"W	30"W	36"W	42"W	48"W	60"W
7 1/2"H						
15"H						
22 1/2"H						
30"H						
37"H						
45"H						
52"H						
60"H						

Glass Tile Kits, Markerboard, Painted Metal Tiles

	24"W	30"W	36"W	42"W	48"W	60"W
15"H						
30"H						

Pass-thru Tiles

	24"W	30"W	36"W	42"W	48"W	60"W
30"H						

Slotted Tool Tile

	24"W	30"W	36"W	42"W	48"W	60"W
15"H						

Hard-surface Tiles

	24"W	30"W	36"W	42"W	48"W	60"W
15"H						
30"H						
37"H						

TILES

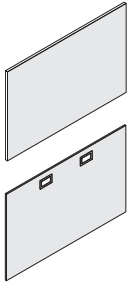

Tackable Acoustical Fabric Tiles

- Tiles do not include segment bars — order separately.

Port Tiles

- Receptacle openings with blank covers (1 in 24"W tiles; 2 in wider tiles). Located 30" above bottom of base raceway and 10½" from the edge of the frame.
- Tiles do not include segment bars — order separately.
- 30"H ported tiles on 35"H frame will need additional stiffener support.
- Ported tiles should only be used to accommodate beltline height. If a port is needed at an alternate height, please submit a special request.
- Tiles cannot be flipped to move data ports.
- Duplex brackets must be specified for ported tiles.

Painted Metal

- Tiles do not include segment bars — order separately.
- Painted steel construction.
- 15"H and 30"H tiles are non-dedicated and can be used in any tile position.
- Tiles can accept magnets.

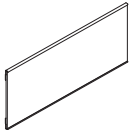

Tool Tiles

- Tiles do not include segment bars — order separately.
- Sturdy aluminum extrusion with steel support construction.
- Powder coated for durable finish.
- Work tools available.
- Use in place of standard 15"H tiles.
- Cannot be used in the bottom location of a panel frame or on wall track.
- Each tool tile has a suggested weight capacity of 80 lbs. of paper management accessories.

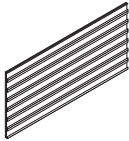

Pass-Thru Tiles

- Pass-thru opening is 22½"H.
- Used as 30"H tile.
- Must order quantity of one 7½"H tile if finishing one side and quantity of two 7½"H tiles if finishing both sides.
- Built into trim pieces.
- Half segment bar (wall hanger segment bar) is needed for bottom of tile, and full segment bar is needed above the pass-thru tile below the 7½"H tile.

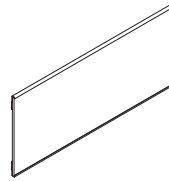
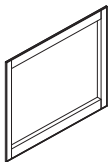

Hard Surface

- High Pressure Laminate — available in standard laminate colors.
- Tiles do not ship with segment bars — order separately.
- Tiles come completely assembled and attach with custom tile bracket kit. Specify paint color.
- 15"H, 30"H, and 37"H tiles are non-dedicated and can be used in any tile position.
- Vertical grain on all tile sizes.

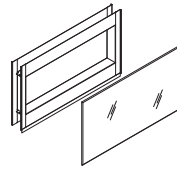

Glass Tiles

- Clear and frosted glass.
- Clear glass is writable with dry erase marker — frosted glass is not.
- Tempered safety glass encased within a frame.
- Single-pane construction, glass is flush on one side.
- Glass opening is 4" less than nominal heights and widths.
- Cannot be used in top tile position of a 42½"H panel frame or any frame with integrated power pole.
- Cannot be used at the bottom or beltline location of panel frame.
- 30"H glass tiles can only be placed in top position of 65"H frames or only in 30"H stacking frame. Segment bar needs to be ordered.

Marker Board Tiles

- White marker board tile; painted steel surface.
- Accepts magnetic accessories.
- 15"W magnetically attachable tray is natural aluminum color — order separately.
- 15"H and 30"H tiles are non-dedicated and can be used in any tile position.

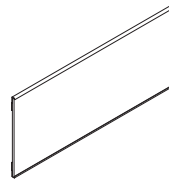

Gallery Panels

- 1½" thick laminate panels used as wing or end of run panels only.
- Available in 35"H, 42½"H, and 50"H options.
- Options available to include frameless glass.
- Gallery Panel connectors purchased separately.

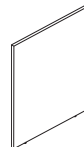

Custom Material Bracket Kit

- Do not ship with segment bars — order separately.
- Used with Customer's Own Material — thickness is ¼".
- Contact HON for insert dimensions.

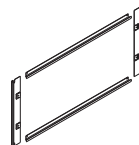

ABOUND® SYSTEMS

Electrical and Data

About String-in Capacity

Openings in frame sides permit electrical data and communication cables to be run between frames in Abound. Using tackable acoustical tiles, the beltline pathway accommodates up to 62 cables (.25" dia) or 46 cables with electrical components installed.

DO NOT run electrical equipment or extension cords through cable openings in frame sides. Use beltline or base-mounted electrical system for all electrical supply.

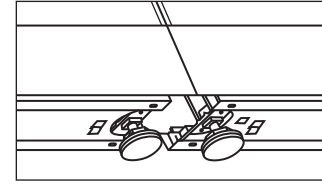
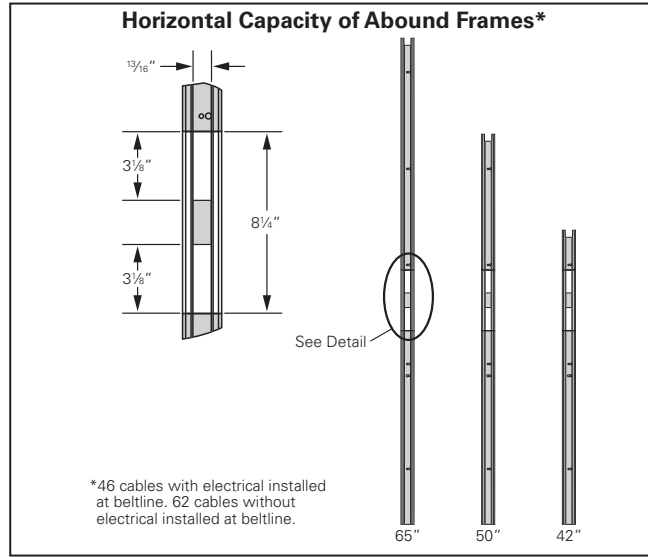

Cables can enter/exit panel through underside of base pathway at juncture between frames. Openings are sized as follows (in sq. in.):

Straight connection	6.0
"S" Extended Straight Connection	10.0
"L" 90° Connection	8.9
"T" Connection	15.9
"X" Connection	17.9
"Y" Connection	—

Vertical Capacity

Vertical Capacity Through Panel Frames

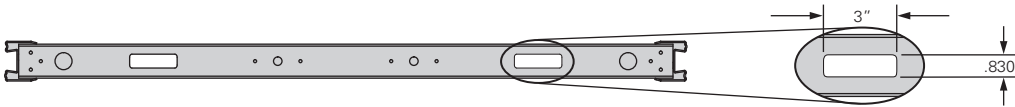

	Panel Width	Qty of .25" Cables at 45% Fill Ratio	Qty of .25" Cables at 60% Fill Ratio	Total Space (sq. in.)
Abound	24" - 60"W	48	64	5.26

When leveling glides are fully retracted, panel-to-floor clearance is 7/16". This may affect the volume of cabling that can be fed into the frame from the bottom of the pathway.

- A 60% fill ratio is achievable; however, when electrical components are installed in the beltline area, cabling capacity through the beltline area will be limited to approximately 45% fill ratio.

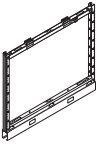
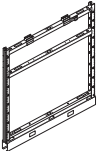
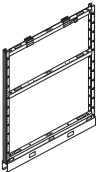
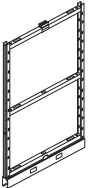
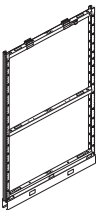

ABOUND® Panel Frames

	DESCRIPTION	MODEL	SHIP WEIGHT	CUBE	LIST PRICE BY PAINT GRADE	
					P1	P2
	35" H Panel Frame					
	35" H x 24" W	HRVF3524P	8	1.7	\$310	\$348
	35" H x 30" W	HRVF3530P	11	2.1	\$319	\$357
	35" H x 36" W	HRVF3536P	13	2.4	\$325	\$363
	35" H x 42" W	HRVF3542P	16	2.8	\$337	\$375
	35" H x 48" W	HRVF3548P	18	3.2	\$358	\$396
	35" H x 60" W	HRVF3560P	23	4.0	\$397	\$435
	42" H Panel Frame					
	42" H x 24" W	HRVF4224P	11	2.0	\$319	\$357
	42" H x 30" W	HRVF4230P	14	2.4	\$332	\$370
	42" H x 36" W	HRVF4236P	17	2.9	\$337	\$375
	42" H x 42" W	HRVF4242P	19	3.4	\$359	\$397
	42" H x 48" W	HRVF4248P	22	3.8	\$376	\$414
	42" H x 60" W	HRVF4260P	28	4.7	\$420	\$458
	<p>ⓘ When stacking on 42½" H frames, panel slots will be off by ½" compared to any other height panel.</p> <p>ⓘ When stacking on 42½" H frames, hanging accessories will be ½" off in height compared to accessories hanging on panels at any height other than 42½" H.</p>					
	50" H Panel Frame					
	50" H x 24" W	HRVF5024P	14	2.3	\$340	\$378
	50" H x 30" W	HRVF5030P	17	2.9	\$358	\$396
	50" H x 36" W	HRVF5036P	20	3.4	\$358	\$396
	50" H x 42" W	HRVF5042P	24	4.0	\$380	\$418
	50" H x 48" W	HRVF5048P	27	4.5	\$388	\$426
	50" H x 60" W	HRVF5060P	34	5.6	\$427	\$465
	57½" H Panel Frame					
	57½" H x 24" W	HRVF5724P	17	2.7	\$356	\$394
	57½" H x 30" W	HRVF5730P	22	3.3	\$368	\$406
	57½" H x 36" W	HRVF5736P	25	4.0	\$371	\$409
	57½" H x 42" W	HRVF5742P	30	4.6	\$391	\$429
	57½" H x 48" W	HRVF5748P	35	5.2	\$407	\$445
	57½" H x 60" W	HRVF5760P	43	6.5	\$441	\$479
	65" H Panel Frame					
	65" H x 24" W	HRVF6524P	17	3.0	\$369	\$407
	65" H x 30" W	HRVF6530P	22	3.7	\$376	\$414
	65" H x 36" W	HRVF6536P	25	4.4	\$382	\$420
	65" H x 42" W	HRVF6542P	30	5.1	\$398	\$436
	65" H x 48" W	HRVF6548P	35	5.8	\$422	\$460
	65" H x 60" W	HRVF6560P	43	7.2	\$458	\$496

NOTES:

- Includes frame, baserail covers, and attaching hardware.
- Frames, top caps and tiles are ordered and shipped separately.
- Frames are 2½" thick with a 5" H baserail.
- Frames are standard with two adjustable leveling glides which can be adjusted from the bottom of the glide or from the interior of frame.
- Two wire and data management openings standard per raceway, 24" panel has one opening.
- Lay-in wire management available in base. Horizontal cable routing available at beltline.
- Lay-in top pathway provides additional data cabling capacity.
- For worksurfaces that can be used with both Abound® and Accelerate® systems, see pages 541-553.
- ⓘ Panels should not be used in unsupported applications or take the place of permanent walls. Panels are intended to be supported with floor supports and/or storage or tied in with worksurfaces. Refer to Specifying and Design Guide pages.

HOW TO SPECIFY

<p>Select Model Number</p> <p>HRVF3524P</p>	<p>Select Trim Color</p> <p>See page 371</p> <p>T4</p>
--	---

ABOUND® Panel Frames

GSA SIN 33721



Icon Legend on page 19

WORKSTATIONS



DESCRIPTION	FLAT MODEL	CHAMFERED MODEL	SHIP WEIGHT	CUBE	LIST PRICE BY PAINT GRADE	
					P1	P2
Panel Top Cap						
24"W	HRVTC24F	HRVTC24	1.6	0.3	\$49	\$70
30"W	HRVTC30F	HRVTC30	1.8	0.3	\$61	\$82
36"W	HRVTC36F	HRVTC36	2.0	0.3	\$80	\$101
42"W	HRVTC42F	HRVTC42	2.2	0.3	\$83	\$104
48"W	HRVTC48F	HRVTC48	3.4	0.4	\$91	\$112
54"W	HRVTC54F	HRVTC54	3.7	0.5	\$111	\$132
60"W	HRVTC60F	HRVTC60	3.9	0.6	\$111	\$132
66"W	HRVTC66F	HRVTC66	4.0	0.6	\$132	\$153
72"W	HRVTC72F	HRVTC72	5.3	0.8	\$136	\$157
78"W	HRVTC78F	HRVTC78	6.5	0.8	\$143	\$164
84"W	HRVTC84F	HRVTC84	6.7	0.9	\$155	\$176
90"W	HRVTC90F	HRVTC90	7.0	0.9	\$161	\$182
96"W	HRVTC96F	HRVTC96	7.2	0.9	\$169	\$190

NOTES: Top caps can span more than one panel in an in-line connection.

! Top cap models are to be used on Abound® frames only.

NOTES:

- Includes frame, baserail covers, attaching hardware and bottom segment bar.
 - Frames, top caps and tiles are ordered and shipped separately.
 - Frames are 2½" thick with a 5"H baserail.
 - Frames are standard with two adjustable leveling glides which can be adjusted from the bottom of the glide or from the interior of frame.
 - Two wire and data management openings standard per raceway, 24" panel has one opening.
 - Lay-in wire management available in base. Horizontal cable routing available at beltline.
 - Lay-in top pathway provides additional data cabling capacity.
 - For worksurfaces that can be used with both Abound® and Accelerate® systems, see pages 541-553.
- ! Panels should not be used in unsupported applications or take the place of permanent walls. Panels are intended to be supported with floor supports and/or storage or tied in with worksurfaces. Refer to Specifying and Design Guide pages.

HOW TO SPECIFY

Select Model Number HRVTC24	Select Trim Color See page 371 T4
---------------------------------------	--



ABOUND[®] Open Base Panel Frames

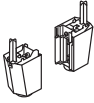

DESCRIPTION	MODEL	SHIP WEIGHT	CUBE	LIST PRICE BY PAINT GRADE	
				P1	P2
Raceway to Open Base Conversion Kit	HRVFFOOT	4	0.1	\$224	\$245

HOW TO SPECIFY

Select Model Number

HRVFFOOT

ABOUND[®] Stacking Panel Frames

GSA SIN 33721



Icon Legend on page 19

WORKSTATIONS



DESCRIPTION

15"H Stacking Panel Frame

15"H x 24"W
15"H x 30"W
15"H x 36"W
15"H x 42"W
15"H x 48"W
15"H x 60"W

MODEL

HRVF1524
HRVF1530
HRVF1536
HRVF1542
HRVF1548
HRVF1560

SHIP WEIGHT

8
10
12
14
16
20

CUBE

0.8
0.9
1.1
1.3
1.5
1.8

LIST PRICE

\$289
\$303
\$310
\$323
\$325
\$335

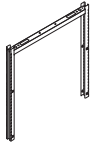

30"H Stacking Panel Frame

30"H x 24"W
30"H x 30"W
30"H x 36"W
30"H x 42"W
30"H x 48"W
30"H x 60"W

HRVF3024
HRVF3030
HRVF3036
HRVF3042
HRVF3048
HRVF3060

10
12
14
16
18
22

1.4
1.8
2.1
2.4
2.8
3.4

\$306
\$323
\$333
\$346
\$352
\$374



Full Segment Bars

24"W
30"W
36"W
42"W
48"W
60"W

HRVFSB24
HRVFSB30
HRVFSB36
HRVFSB42
HRVFSB48
HRVFSB60

2
2
3
3
3
4

0.4
0.4
0.5
0.5
0.6
0.7

\$31
\$31
\$32
\$33
\$34
\$35

! Must order one segment bar per panel reveal, per panel side.

NOTES:

- Frames, top caps and tiles are ordered and shipped separately.
- Includes attachment hardware.
- Stacking frames can be added to the top of any 35"H, 50" or 65"H frame.
- No paint selection necessary on stacking frames.
- Overhead storage units can be suspended from stacking frames. See pages 514-515.
- Segment Bars do not need to be specified for monolithic tiles, when only a single tile is attached to the frame.

- ! When stacking on 42½"H frames, panel slots will be off by ½" compared to any other height panel.
- ! When stacking on 42½"H frames, hanging accessories will be ½" off in height compared to accessories hanging on panels at any height other than 42½"H.
- ! Not designed to combine differing frame widths in a single stack.
- ! Stacking frames not designed to be used as a base frame.
- ! Segment bars available in Black only.
- ! Segment Bars are formed, steel cross members and are required between tiles and on each side of the frame.



HOW TO SPECIFY

Select
Model Number

HRVF1524

ABOUND®





Stiffener Supports

	DESCRIPTION	MODEL	SHIP WEIGHT	CUBE	LIST PRICE
  	Stiffener Support				
	24"W	HRVSS24	1	0.4	\$77
	30"W	HRVSS30	1	0.4	\$80
	36"W	HRVSS36	4	0.5	\$84
	42"W	HRVSS42	4	0.5	\$104
	48"W	HRVSS48	4	0.5	\$116
60"W	HRVSS60	4	0.7	\$126	
	! Black only. No need to specify paint.				

NOTES:

- Tile stiffener supports can be used to increase the stiffness of a panel and can also be used to mount power/data anywhere vertically on an Abound frame. Can only be used when there are fabric tiles on both sides of the frame.
- Self-drilling screws included.

! Black only. No need to specify paint.

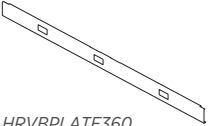
	DESCRIPTION	MODEL	SHIP WEIGHT	CUBE	LIST PRICE BY PAINT GRADE	
					P1	P2
 HRVBPLATE336	Abound® Base Pathway Cover w/Additional Knockout					
	36"W	HRVBPLATE336	7 	0.4	\$99	\$110
	42"W	HRVBPLATE342	8 	0.4	\$101	\$112
	48"W	HRVBPLATE348	9 	0.4	\$105	\$116
	60"W	HRVBPLATE360	11 	0.5	\$120	\$131
	NOTES: Specify paint, see page 371.					
	SPECIFYING EXAMPLE: HRVBPLATE336.T4					
 HRVBPLATE360						

NOTES:

- ! Specify Pathways to match trim color.
- ! Standard raceways with two knockouts are standard on panels. If additional three knockout kickplate is ordered, the two port version can be saved or discarded.

HOW TO SPECIFY

Select Model Number HRVBPLATE336	Select Paint Color See page 371 T4
--	---

ABOUND® Panel Door

GSA SIN 33721



Icon Legend on page 19

WORKSTATIONS



DESCRIPTION	MODEL	SHIP WEIGHT	CUBE	L1 LIST PRICE BY PAINT GRADE	
				P1	P2
Door Panel — Laminate 42"W x 95"H NOTES: Includes frame, 42"W door, hinges and attaching hardware. Lockset or Knob ordered separately. Best placement of a door is at an L, T, X connector or wall starter connector for rigidity. Use of spanning top caps at an in-line will also help add additional rigidity.	HRVD9542P	155	5.4	\$2965	\$3003
ⓘ Two HRVD0742T tiles for above the door must be ordered per each door ordered. See below. ⓘ Top Cap must be ordered separately. See page 388 for top cap specification.					



HOW TO SPECIFY

Select Model Number HRVD9542P	Select Trim Color See page 371 T4	Select Door Laminate L1 Woodgrain only See page 371 K2
---	--	--

DESCRIPTION	MODEL	SHIP WEIGHT	CUBE	LIST PRICE BY FABRIC GRADE						
				A	B	C	D	E	F	G
 Fabric Tiles for Door Panel 7½"H x 42"W ⓘ Must be ordered with the Door Panel model above. ⓘ Required for door installation. ⓘ Two tiles must be ordered for installation. Tiles ship 1/pkg.	HRVD0742T	3	1.2	\$113	\$117	\$121	\$132	\$135	\$139	\$143

HOW TO SPECIFY

Select Model Number HRVD0742T	Select Fabric Color See pages 372-373 APN15
---	--

	DESCRIPTION	MODEL	SHIP WEIGHT	CUBE	LIST PRICE
	Lockset (Door Knob) Polished Brass, keyed on one side	HN899900	2.0 ⓘ	0.1	\$152
	Door Lever Brushed Aluminum, keyed on one side	HN899910	2.0 ⓘ	0.1	\$416
	Carpet Grippers NOTES: Used with Glide Towers Shipped 12 per package No need to specify finish	HICG12	0.5 ⓘ	0.1	\$31

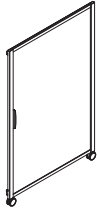

ABOUND[®] Sliding Door

**DESCRIPTION****Abound Sliding Door**

50"H x 42"W

65"H x 42"W

80"H x 42"W

MODEL**HH15042SD****HH16542SD****HH18042SD****SHIP
WEIGHT**

28

38

46

CUBE

5.5

7.1

8.6

LIST PRICE BY PAINT GRADE**P1****\$2711****\$3091****\$3780****P2****\$2749****\$3129****\$3818**

! Door is only available in Frosted Translucent Acrylic. Specify paint for frame.

! Can only install Sliding Door at the end of a run, not at a corner.

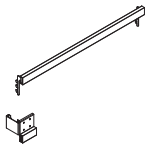
**Mounting Kit for Abound Sliding Door**

For 30"W Panel

For 36"W Panel

For 42"W Panel

For 48"W Panel

HHKDMK30**HHKDMK36****HHKDMK42****HHKDMK48**

4

5

6

7

0.4

0.5

0.5

0.5

\$236**\$247****\$254****\$267****\$249****\$260****\$267****\$280**

NOTES: Specify paint.

NOTES:

- The Sliding Doors are available in 50", 65", and 80"H models and can mount to 30", 36", 42", and 48"W panels.
- All doors are 42" wide, provide a 36"W opening, and are non-handed.
- ! A Mounting Bracket Kit must be ordered for each door corresponding to the mounting panels width (30", 36", 42", or 48"W).

HOW TO SPECIFY**Select
Model Number**

H H 1 5 0 4 2 S D

**Select
Paint Color**

See page 371

T 1

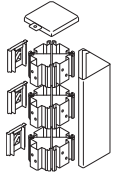

DESCRIPTION	FLAT MODEL	CHAMFERED MODEL	SHIP WEIGHT	CUBE	LIST PRICE BY PAINT GRADE	
					P1	P2
"L" 90° Painted Connector						
7"H Frame	HRVC7PLF	HRVC7PL	1	0.1	\$127	\$145
15"H Frame	HRVC15PLF	HRVC15PL	2	0.1	\$143	\$161
22"H Frame	HRVC22PLF	HRVC22PL	2	0.2	\$159	\$177
30"H Frame	HRVC30PLF	HRVC30PL	3	0.3	\$182	\$200
35"H Frame	HRVC35PLF	HRVC35PL	3	0.3	\$182	\$200
42"H Frame	HRVC42PLF	HRVC42PL	4	0.4	\$198	\$216
50"H Frame	HRVC50PLF	HRVC50PL	5	0.5	\$204	\$222
57½"H Frame	HRVC57PLF	HRVC57PL	5	0.5	\$211	\$229
65"H Frame	HRVC65PLF	HRVC65PL	6	0.6	\$217	\$235
80"H Frame	HRVC80PLF	HRVC80PL	6	0.8	\$224	\$242

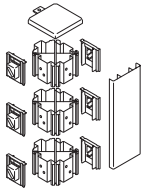

"T" 3-Way Painted Connector						
7"H Frame	HRVC7PTF	HRVC7PT	1	0.1	\$127	\$145
15"H Frame	HRVC15PTF	HRVC15PT	2	0.1	\$143	\$161
22"H Frame	HRVC22PTF	HRVC22PT	2	0.2	\$159	\$177
30"H Frame	HRVC30PTF	HRVC30PT	3	0.3	\$182	\$200
35"H Frame	HRVC35PTF	HRVC35PT	3	0.3	\$182	\$200
42"H Frame	HRVC42PTF	HRVC42PT	4	0.4	\$198	\$216
50"H Frame	HRVC50PTF	HRVC50PT	5	0.5	\$204	\$222
57½"H Frame	HRVC57PTF	HRVC57PT	5	0.5	\$211	\$229
65"H Frame	HRVC65PTF	HRVC65PT	6	0.6	\$217	\$235
80"H Frame	HRVC80PTF	HRVC80PT	6	0.8	\$224	\$242

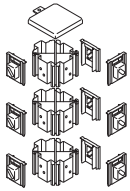

"X" 4-Way Painted Connector						
7"H Frame	HRVC7PXF	HRVC7PX	1	0.1	\$102	\$113
15"H Frame	HRVC15PXF	HRVC15PX	2	0.1	\$118	\$129
22"H Frame	HRVC22PXF	HRVC22PX	2	0.2	\$129	\$140
30"H Frame	HRVC30PXF	HRVC30PX	3	0.3	\$143	\$154
35"H Frame	HRVC35PXF	HRVC35PX	3	0.3	\$143	\$154
42"H Frame	HRVC42PXF	HRVC42PX	4	0.4	\$191	\$202
50"H Frame	HRVC50PXF	HRVC50PX	6	0.5	\$198	\$209
57½"H Frame	HRVC57PXF	HRVC57PX	5	0.5	\$200	\$211
65"H Frame	HRVC65PXF	HRVC65PX	7	0.6	\$204	\$215
80"H Frame	HRVC80PXF	HRVC80PX	6	0.8	\$217	\$228

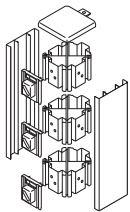

"S" Extended Straight Painted Connector						
7"H Frame	HRVC7PSF	HRVC7PS	1	0.1	\$156	\$174
15"H Frame	HRVC15PSF	HRVC15PS	2	0.1	\$169	\$187
22"H Frame	HRVC22PSF	HRVC22PS	2	0.2	\$183	\$201
30"H Frame	HRVC30PSF	HRVC30PS	3	0.3	\$198	\$216
35"H Frame	HRVC35PSF	HRVC35PS	3	0.3	\$198	\$216
42"H Frame	HRVC42PSF	HRVC42PS	4	0.4	\$226	\$244
50"H Frame	HRVC50PSF	HRVC50PS	6	0.5	\$237	\$255
57½"H Frame	HRVC57PSF	HRVC57PS	6	0.5	\$243	\$261
65"H Frame	HRVC65PSF	HRVC65PS	7	0.6	\$251	\$269
80"H Frame	HRVC80PSF	HRVC80PS	7	0.8	\$270	\$288

NOTES:

- All connectors include a light-gap strip.
- Abound connectors utilize a universal connector block designed to make one connection to the panel.
- Bracket clips come standard.
- 7"H connectors include one connector block; 15"H, 22"H, 30"H include two connector blocks; 50"H includes three connector blocks and 65"H includes four connector blocks.
- Connectors ship complete with trim.
- Outer trim snaps easily into place.
- Extended Straight Connectors are used to keep a frame run dimensionally consistent with opposing frame runs. Add 2¾" to the length of the run with each Extended Straight Connector used.

ⓘ Trim with Abound connectors can only be attached to connectors, not on panels.

HOW TO SPECIFY

<p>Select Model Number</p> <p>HRVC35PL. T4</p>	<p>Select Paint Color</p> <p>See page 371</p>
---	--

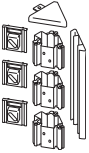
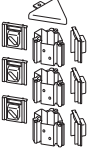

Icon Legend on page 19

	DESCRIPTION	FLAT MODEL	CHAMFERED MODEL	SHIP WEIGHT	CUBE	LIST PRICE BY PAINT GRADE	
						P1	P2
	"Y" 120° Degree, Two-Sided, Painted Connector						
	35"H Frame	HRVC35PY2F	HRVC35PY2	3	0.3	\$182	\$200
	42"H Frame	HRVC42PY2F	HRVC42PY2	4	0.4	\$198	\$216
	50"H Frame	HRVC50PY2F	HRVC50PY2	5	0.5	\$217	\$235
	57½"H Frame	HRVC57PY2F	HRVC57PY2	5	0.5	\$227	\$245
	65"H Frame	HRVC65PY2F	HRVC65PY2	6	0.6	\$237	\$255
	"Y" 120° Degree, Three-Sided, Painted Connector						
	35"H Frame	HRVC35PY3F	HRVC35PY3	3	0.3	\$159	\$177
	42"H Frame	HRVC42PY3F	HRVC42PY3	4	0.4	\$182	\$200
	50"H Frame	HRVC50PY3F	HRVC50PY3	5	0.5	\$198	\$216
	57½"H Frame	HRVC57PY3F	HRVC57PY3	5	0.5	\$206	\$224
	65"H Frame	HRVC65PY3F	HRVC65PY3	6	0.6	\$217	\$235

NOTES:

- 35"H-42"H connectors include two universal connector blocks, 50"H includes three brackets and 65"H includes four brackets.
- Use Y Connectors for 120° applications.
- Abound connectors utilize a universal connector block designed to make one connection to the panel.
- Connectors ship complete with trim.
- Bracket clips come standard.
- Outer trim snaps easily into place.

HOW TO SPECIFY

<p>Select Model Number</p> <p>HRVC35PY2</p>	<p>Select Paint Color</p> <p>See page 371</p> <p>T3</p>
--	--



Variable Height Finished End and Wall Starter Kits

WORKSTATIONS



DESCRIPTION	FLAT MODEL	CHAMFERED MODEL	SHIP WEIGHT	CUBE	LIST PRICE BY PAINT GRADE	
					P1	P2
Finished End						
15"H Finished End	HRVC15PFF	HRVC15PF	1 Ⓞ	0.1	\$87	\$105
30"H Finished End	HRVC30PFF	HRVC30PF	2 Ⓞ	0.3	\$105	\$123
35"H Finished End	HRVC35PFF	HRVC35PF	2 Ⓞ	0.3	\$105	\$123
42"H Finished End	HRVC42PFF	HRVC42PF	2 Ⓞ	0.4	\$118	\$136
50"H Finished End	HRVC50PFF	HRVC50PF	3 Ⓞ	0.5	\$126	\$144
57½"H Finished End	HRVC57PFF	HRVC57PF	3 Ⓞ	0.5	\$129	\$147
65"H Finished End	HRVC65PFF	HRVC65PF	4 Ⓞ	0.6	\$133	\$151
80"H Finished End	HRVC80PFF	HRVC80PF	4 Ⓞ	0.8	\$141	\$159



Variable Height Painted Finished End						
7" Variable Height Finished End	HRVC7PFVF	HRVC7PFV	1 Ⓞ	0.1	\$87	\$98
15" Variable Height Finished End	HRVC15PFVF	HRVC15PFV	1 Ⓞ	0.1	\$87	\$98
22" Variable Height Finished End	HRVC22PFVF	HRVC22PFV	2 Ⓞ	0.2	\$105	\$116
30" Variable Height Finished End	HRVC30PFVF	HRVC30PFV	2 Ⓞ	0.3	\$105	\$116



Variable Height Painted Finished End Over Connector						
7" Variable Height Finished End Over Connector	HRVC7PFT	HRVC7PFT	1 Ⓞ	0.1	\$87	\$98
15" Variable Height Finished End Over Connector	HRVC15PFT	HRVC15PFT	1 Ⓞ	0.1	\$87	\$98
22" Variable Height Finished End Over Connector	HRVC22PFT	HRVC22PFT	2 Ⓞ	0.2	\$105	\$116
30" Variable Height Finished End Over Connector	HRVC30PFT	HRVC30PFT	2 Ⓞ	0.3	\$105	\$116

NOTES: Flat Variable Height Finished End can be used for Variable Height Painted Finished End Over Connectors.



Frameless Glass Variable Height Trim						
7½"H	HRVC7FFVF	HRVC7FFV	1	0.1	\$80	\$90
15"H	HRVC15FFVF	HRVC15FFV	1	0.1	\$115	\$125

Specify paint only.

! Model only used with Frameless Glass on page 405.

SPECIFYING EXAMPLE: HRVC7FFV.T1



Wall Starter Kit						
65"H	HRVC65PWF	HRVC65PW	5 Ⓞ	0.6	\$237	\$255

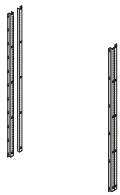

Permanent Wall Hanger Kit						
66"H LH/RH End Pair (2 Pieces)		HRVC35PCE Ⓞ	6 Ⓞ	0.7	\$293	\$314
66"H Shared Mid		HRVC35PCM	3 Ⓞ	0.7	\$155	\$166

NOTES: Permanent Wall Hanger Kit can be used with both Flat and Chamfered models.

! Anchor devices are not supplied with this model. Refer to Abound® Installation instructions for appropriate hardware. Attachment to masonry walls is not recommended.

Specify paint

NOTES:

- Snaps easily onto end of frame.
- 35"H end trim includes top cap and vertical trim.
- 15"H and 30"H Finished End Trims do not include a top cap. These are only used for stacking frames which utilize the top trim and cap from the base frame to which they are attached.
- 42", 50" and 65"H finished end trim includes painted top transition piece, vertical trim and carpet grippers for extra stability.

- End trim is full-length to floor; no baserail cap is necessary.
- Finished Ends include top cap trim. Adds 1½" to panel run.
- Wall Starter Kit allows panel to start from a wall. Specify trim color.
- Wall Starter adds 1½" to length of panel run.
- Anchor devices are not supplied with the wall starter kits.

! Variable height trim and finished ends can only be attached to panels, not attached to connectors.

HOW TO SPECIFY

<p>Select Model Number</p> <p>HRVC7PFT . T3</p>	<p>Select Paint Color</p> <p>See page 371</p>
---	---



WALL HANGER BARS AND OFF-MODULE BRACKET

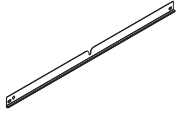

DESCRIPTION	MODEL	SHIP WEIGHT	CUBE	LIST PRICE BY PAINT GRADE	
				P1	P2
Wall Hanger Segment Bars					
24"W	HRVFSBW24	2	0.4	\$45	N/A
30"W	HRVFSBW30	2	0.4	\$45	N/A
36"W	HRVFSBW36	3	0.5	\$48	N/A
42"W	HRVFSBW42	3	0.5	\$54	N/A
48"W	HRVFSBW48	3	0.6	\$58	N/A
60"W	HRVFSBW60	4	0.7	\$62	N/A

ⓘ Includes two tile bars. Top bar may only be used in the top uppermost position on Wall Track. Bottom bar can be used in the bottom position at any point on the wall hangers. When segmenting tiles on Wall Hangers, standard Segment Bars (page 390) must be ordered for placement between each tile reveal or at the top position of a single tile that is not in the uppermost position.

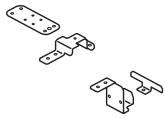

Off-Module Bracket Kit	HRVOMOD	2	0.1	\$118	\$129
-------------------------------	----------------	---	-----	--------------	--------------

- Includes top and bottom attachment brackets and top trim finished end.
- Installation requires defacing of the top tile.

ⓘ Cannot be mounted in locations where the bottom bracket covers electrical cutouts in the base pathway on parent run panels.

HOW TO SPECIFY

Select Model Number

HRVFSBW24

ABOUND[®] Tackable Acoustical Tiles

GSA SIN 33721



Icon Legend on page 19

WORKSTATIONS



DESCRIPTION	MODEL	SHIP WEIGHT	CUBE	LIST PRICE BY FABRIC GRADE							
				AA	A	B	C	D	E	F	G
7 1/2" H Tackable Acoustical Fabric Tiles											
7 1/2" H x 24" W	HRVT0724T	2	0.4	\$85	\$90	\$93	\$95	\$101	\$106	\$112	\$115
7 1/2" H x 30" W	HRVT0730T	2	0.5	\$100	\$105	\$108	\$112	\$118	\$126	\$129	\$132
7 1/2" H x 36" W	HRVT0736T	2	0.6	\$107	\$112	\$115	\$119	\$125	\$133	\$136	\$139
7 1/2" H x 42" W	HRVT0742T	2	0.7	\$118	\$124	\$128	\$132	\$143	\$146	\$150	\$154
7 1/2" H x 48" W	HRVT0748T	2	0.8	\$125	\$131	\$135	\$139	\$150	\$153	\$157	\$161
7 1/2" H x 60" W	HRVT0760T	3	1.0	\$149	\$170	\$175	\$180	\$192	\$197	\$200	\$203



15" H Tackable Acoustical Fabric Tiles											
15" H x 24" W	HRVT1524T	2	0.8	\$88	\$98	\$106	\$115	\$131	\$150	\$167	\$175
15" H x 30" W	HRVT1530T	2	0.9	\$90	\$102	\$112	\$123	\$146	\$168	\$179	\$190
15" H x 36" W	HRVT1536T	2	1.1	\$99	\$111	\$121	\$132	\$155	\$177	\$188	\$199
15" H x 42" W	HRVT1542T	2	1.3	\$101	\$115	\$128	\$143	\$178	\$189	\$200	\$211
15" H x 48" W	HRVT1548T	2	1.5	\$110	\$124	\$137	\$152	\$187	\$198	\$209	\$220
15" H x 60" W	HRVT1560T	3	1.8	\$126	\$140	\$153	\$168	\$203	\$214	\$225	\$236

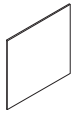

22 1/2" H Tackable Acoustical Tiles											
22 1/2" H x 24" W	HRVT2224T	2	1.1	\$101	\$112	\$121	\$132	\$152	\$175	\$189	\$199
22 1/2" H x 30" W	HRVT2230T	2	1.4	\$105	\$118	\$130	\$143	\$167	\$196	\$225	\$235
22 1/2" H x 36" W	HRVT2236T	2	1.6	\$115	\$131	\$145	\$156	\$195	\$226	\$238	\$248
22 1/2" H x 42" W	HRVT2242T	2	1.9	\$124	\$140	\$154	\$168	\$213	\$238	\$250	\$261
22 1/2" H x 48" W	HRVT2248T	2	2.2	\$132	\$148	\$162	\$176	\$221	\$246	\$258	\$269
22 1/2" H x 60" W	HRVT2260T	3	2.6	\$152	\$168	\$182	\$196	\$241	\$266	\$278	\$289

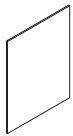

30" H Tackable Acoustical Tiles											
30" H x 24" W	HRVT3024T	2	1.4	\$120	\$132	\$142	\$154	\$177	\$205	\$217	\$227
30" H x 30" W	HRVT3030T	2	1.8	\$125	\$139	\$152	\$167	\$193	\$229	\$275	\$285
30" H x 36" W	HRVT3036T	2	2.1	\$134	\$153	\$170	\$183	\$238	\$278	\$289	\$300
30" H x 42" W	HRVT3042T	3	2.4	\$152	\$169	\$185	\$197	\$254	\$293	\$305	\$316
30" H x 48" W	HRVT3048T	3	2.8	\$161	\$178	\$194	\$206	\$263	\$302	\$314	\$325
30" H x 60" W	HRVT3060T	4	3.4	\$182	\$199	\$215	\$227	\$284	\$323	\$335	\$346

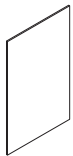

37" H Tackable Acoustical Tiles											
37" H x 24" W	HRVT3724T	2	2.0	\$136	\$153	\$169	\$188	\$243	\$277	\$289	\$300
37" H x 30" W	HRVT3730T	3	2.4	\$156	\$173	\$189	\$208	\$263	\$297	\$309	\$320
37" H x 36" W	HRVT3736T	4	2.9	\$177	\$197	\$217	\$239	\$306	\$355	\$367	\$378
37" H x 42" W	HRVT3742T	4	3.4	\$198	\$220	\$241	\$266	\$351	\$401	\$412	\$423
37" H x 48" W	HRVT3748T	5	3.8	\$207	\$229	\$252	\$276	\$363	\$414	\$427	\$438
37" H x 60" W	HRVT3760T	6	4.6	\$237	\$265	\$292	\$324	\$410	\$473	\$484	\$497

Segment bars ordered separately. See page 390.

NOTES:

- Tiles attach directly onto the panels. No additional hardware is needed.
- Tiles are non-dedicated.
- For monolithic applications, subtract 5" from the frame height to determine monolithic tile height.
- Fabric tiles have a Class A fire rating.
- Tiles do not include segment bars, must be ordered separately. See page 390. Not needed on monolithic tiles.
- One segment bar required per panel reveal, per panel side.

HOW TO SPECIFY

Select Model Number	Select Fabric Color
	See pages 372-373
HRVT1524T	APN11



ABOUND® Tackable Acoustical Tiles



DESCRIPTION	MODEL	SHIP WEIGHT	CUBE	LIST PRICE BY FABRIC GRADE								
				AA	A	B	C	D	E	F	G	
45”H Tackable Acoustical Tiles												
45”H x 24”W	HRVT4524T	2	2.3	\$151	\$171	\$192	\$214	\$283	\$333	\$345	\$357	
45”H x 30”W	HRVT4530T	3	2.9	\$170	\$192	\$213	\$239	\$326	\$376	\$389	\$401	
45”H x 36”W	HRVT4536T	5	3.4	\$202	\$224	\$247	\$271	\$358	\$409	\$422	\$433	
45”H x 42”W	HRVT4542T	5	4.0	\$237	\$259	\$280	\$306	\$392	\$443	\$456	\$468	
45”H x 48”W	HRVT4548T	6	4.5	\$267	\$289	\$319	\$336	\$423	\$474	\$487	\$498	
45”H x 60”W	HRVT4560T	7	5.6	\$290	\$318	\$346	\$378	\$463	\$526	\$538	\$551	



52½”H Tackable Acoustical Tiles												
52½”H x 24”W	HRVT5224T	2	2.6	\$167	\$197	\$228	\$261	\$346	\$402	\$414	\$450	
52½”H x 30”W	HRVT5230T	3	3.2	\$189	\$223	\$258	\$294	\$388	\$451	\$464	\$518	
52½”H x 36”W	HRVT5236T	4	3.8	\$223	\$257	\$292	\$326	\$421	\$485	\$498	\$552	
52½”H x 42”W	HRVT5242T	5	4.4	\$247	\$285	\$325	\$359	\$467	\$531	\$543	\$618	
52½”H x 48”W	HRVT5248T	6	4.9	\$277	\$315	\$357	\$389	\$497	\$595	\$609	\$683	
52½”H x 60”W	HRVT5260T	7	6.1	\$299	\$343	\$388	\$424	\$562	\$641	\$654	\$728	

Segment bars ordered separately. See page 390.



60”H Tackable Acoustical Tiles												
60”H x 24”W	HRVT6024T	3	3.0	\$177	\$210	\$244	\$280	\$372	\$428	\$442	\$485	
60”H x 30”W	HRVT6030T	4	3.7	\$200	\$238	\$278	\$316	\$413	\$481	\$494	\$561	
60”H x 36”W	HRVT6036T	6	4.4	\$232	\$270	\$310	\$346	\$444	\$512	\$526	\$593	
60”H x 42”W	HRVT6042T	6	5.1	\$251	\$294	\$340	\$378	\$492	\$560	\$573	\$668	
60”H x 48”W	HRVT6048T	7	5.8	\$285	\$328	\$374	\$412	\$526	\$640	\$654	\$748	
60”H x 60”W	HRVT6060T	9	7.2	\$303	\$353	\$403	\$440	\$595	\$681	\$693	\$788	

Segment bars ordered separately. See page 390.

NOTES:

- Tiles are non-dedicated.
- Tiles attach directly onto the panels. No additional hardware is needed.
- For monolithic applications, subtract 5” from the frame height to determine monolithic tile height.
- Fabric tiles have a Class A fire rating.
- Tiles do not include segment bars, must be ordered separately. See page 390. Not needed on monolithic tiles.
- One segment bar required per panel reveal, per panel side.

HOW TO SPECIFY

<p>Select Model Number</p> <div style="border: 1px solid black; display: flex; gap: 2px; padding: 2px;"> HRVT4524T </div>	<p>Select Fabric Color</p> <p>See pages 372-373</p> <div style="border: 1px solid black; display: flex; gap: 2px; padding: 2px;"> APN11 </div>
--	---

ABOUND® Power/Data Fabric Tiles

GSA SIN 33721



Icon Legend on page 19

WORKSTATIONS



DESCRIPTION	MODEL	SHIP WEIGHT	CUBE	LIST PRICE BY FABRIC GRADE									
				AA	A	B	C	D	E	F	G		
15" H Power/Data Fabric Tiles													
15" H x 24" W	HRVT1524E	2 Ⓢ	0.8	\$174	\$184	\$192	\$201	\$217	\$236	\$253	\$261		
15" H x 30" W	HRVT1530E	2 Ⓢ	0.9	\$175	\$187	\$197	\$208	\$231	\$253	\$264	\$275		
15" H x 36" W	HRVT1536E	2 Ⓢ	1.1	\$184	\$196	\$206	\$217	\$240	\$262	\$273	\$284		
15" H x 42" W	HRVT1542E	2 Ⓢ	1.3	\$187	\$201	\$214	\$229	\$264	\$275	\$286	\$297		
15" H x 48" W	HRVT1548E	2 Ⓢ	1.5	\$196	\$210	\$223	\$238	\$273	\$284	\$295	\$306		
15" H x 60" W	HRVT1560E	3 Ⓢ	1.8	\$211	\$225	\$238	\$253	\$288	\$299	\$310	\$321		

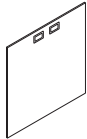

30" H Power/Data Fabric Tiles													
30" H x 24" W	HRVT3024E	2 Ⓢ	1.4	\$202	\$214	\$224	\$236	\$259	\$287	\$299	\$309		
30" H x 30" W	HRVT3030E	2 Ⓢ	1.8	\$208	\$222	\$235	\$250	\$276	\$312	\$358	\$368		
30" H x 36" W	HRVT3036E	2 Ⓢ	2.1	\$222	\$241	\$258	\$271	\$326	\$366	\$377	\$388		
30" H x 42" W	HRVT3042E	3 Ⓢ	2.4	\$242	\$259	\$275	\$287	\$344	\$383	\$395	\$406		
30" H x 48" W	HRVT3048E	3 Ⓢ	2.8	\$249	\$266	\$282	\$294	\$351	\$390	\$402	\$413		
30" H x 60" W	HRVT3060E	4	3.4	\$267	\$284	\$300	\$312	\$369	\$408	\$420	\$431		

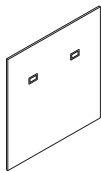

37" H Power/Data Fabric Tiles													
37" H x 24" W	HRVT3724E	2 Ⓢ	2.0	\$224	\$241	\$257	\$276	\$331	\$365	\$377	\$388		
37" H x 30" W	HRVT3730E	3 Ⓢ	2.4	\$245	\$262	\$278	\$297	\$352	\$386	\$398	\$409		
37" H x 36" W	HRVT3736E	4 Ⓢ	2.9	\$259	\$279	\$299	\$321	\$388	\$437	\$449	\$460		
37" H x 42" W	HRVT3742E	4	3.4	\$275	\$297	\$318	\$343	\$428	\$478	\$489	\$500		
37" H x 48" W	HRVT3748E	5	3.8	\$296	\$318	\$341	\$365	\$452	\$503	\$516	\$527		
37" H x 60" W	HRVT3760E	6	4.7	\$325	\$353	\$380	\$412	\$498	\$561	\$572	\$585		

! Segment bars ordered separately. See page 390.

NOTES:

- Power/Data tiles are tackable and acoustical.
- Tiles attach directly onto the panels. No additional hardware is needed.
- Tiles are non-dedicated.
- 24" W tiles have one port. Other widths have two.
- Power/Data grommet opening is 2 1/8" W x 1 3/8" H. With glides retracted grommets are 30" from the floor and 10 1/2" from the edge of the frame.
- Power/Data ports are factory installed.
- Ⓢ Fabric tiles have a Class A fire rating.
- ! Ports on all tile sizes are located above the worksurface. Tiles cannot be flipped to change port location.
- ! Tiles do not include segment bars, must be ordered separately. See page 390. Can be used in any combination.
- ! One segment bar required per panel reveal, per panel side.
- ! Electrical mounting brackets must be ordered separately. See page 540.

HOW TO SPECIFY

<p>Select Model Number</p> <p>HRVT1524E</p>	<p>Select Fabric Color</p> <p>See pages 372-373</p> <p>APN11</p>	<p>Select Electrical Power/Data Grommet Color</p> <p>See page 371</p> <p>T5</p>
---	--	---



ABOUND® Power/Data Fabric Tiles

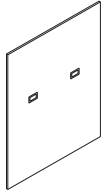

DESCRIPTION	MODEL	SHIP WEIGHT	CUBE	LIST PRICE BY FABRIC GRADE								
				AA	A	B	C	D	E	F	G	
45"H Power/Data Fabric Tiles												
45"H x 24"W	HRVT4524E	2	2.3	\$240	\$260	\$281	\$303	\$372	\$422	\$434	\$446	
45"H x 30"W	HRVT4530E	3	2.9	\$259	\$281	\$302	\$328	\$415	\$465	\$478	\$490	
45"H x 36"W	HRVT4536E	5	3.4	\$294	\$316	\$339	\$363	\$450	\$501	\$514	\$525	
45"H x 42"W	HRVT4542E	5	4.0	\$325	\$347	\$368	\$394	\$480	\$531	\$544	\$556	
45"H x 48"W	HRVT4548E	6	4.5	\$358	\$380	\$410	\$427	\$514	\$565	\$578	\$589	
45"H x 60"W	HRVT4560E	7	5.6	\$382	\$410	\$438	\$470	\$555	\$618	\$630	\$643	

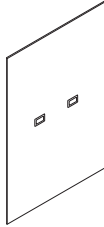

52½"H Power/Data Fabric Tiles												
52½"H x 24"W	HRVT5224E	2	2.8	\$255	\$287	\$318	\$350	\$436	\$485	\$504	\$540	
52½"H x 30"W	HRVT5230E	3	3.4	\$280	\$317	\$353	\$388	\$481	\$543	\$558	\$612	
52½"H x 36"W	HRVT5236E	4	4.0	\$311	\$347	\$383	\$416	\$511	\$575	\$588	\$642	
52½"H x 42"W	HRVT5242E	5	4.6	\$335	\$375	\$415	\$449	\$556	\$620	\$633	\$708	
52½"H x 48"W	HRVT5248E	6	5.1	\$369	\$409	\$451	\$483	\$591	\$689	\$703	\$776	
52½"H x 60"W	HRVT5260E	7	6.3	\$390	\$435	\$480	\$516	\$654	\$733	\$746	\$820	

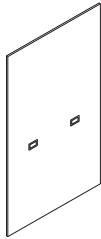

60"H Power/Data Fabric Tiles												
60"H x 24"W	HRVT6024E	3	3.0	\$263	\$296	\$330	\$366	\$458	\$514	\$528	\$571	
60"H x 30"W	HRVT6030E	4	3.7	\$290	\$328	\$368	\$406	\$503	\$571	\$584	\$651	
60"H x 36"W	HRVT6036E	6	4.4	\$322	\$360	\$400	\$436	\$534	\$602	\$616	\$683	
60"H x 42"W	HRVT6042E	6	5.1	\$343	\$386	\$432	\$470	\$584	\$652	\$665	\$760	
60"H x 48"W	HRVT6048E	7	5.8	\$375	\$418	\$464	\$502	\$616	\$730	\$744	\$838	
60"H x 60"W	HRVT6060E	9	7.2	\$394	\$444	\$494	\$531	\$686	\$772	\$784	\$879	

Segment bars ordered separately. See page 390.

NOTES:

- Tiles are non-dedicated.
- Tiles attach directly onto the panels. No additional hardware is needed.
- 24"W tiles have one port. Other widths have two.
- Power/Data grommet opening is 2 1/16"W x 1 1/8"H. With glides retracted grommet are 30" from the floor and 10 1/2" from the edge of the frame.
- Power/Data ports are factory installed.
- Fabric tiles have a Class A fire rating.
- Ports on all tile sizes are located above the worksurface. Tiles cannot be flipped to change port location.
- Tiles do not include segment bars, must be ordered separately. See page 390. Can be used in any combination.
- One segment bar required per panel reveal, per panel side.
- Electrical mounting brackets must be ordered separately. See page 540.

HOW TO SPECIFY

<p>Select Model Number</p> <p>HRVT4524E</p>	<p>Select Fabric Color</p> <p>See pages 372-373</p> <p>APN11</p>	<p>Select Electrical Power/Data Grommet Color</p> <p>See page 371</p> <p>T5</p>
---	--	---

ABOUND® Hard-surface Tiles

GSA SIN 33721



Icon Legend on page 19

WORKSTATIONS

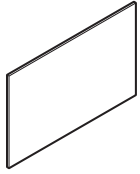

DESCRIPTION

MODEL

SHIP WEIGHT CUBE

LIST PRICE BY LAMINATE GRADE
L1 L2

15" Hard-surface Tile and Mounting Kit

15"H x 24"W
15"H x 30"W
15"H x 36"W
15"H x 42"W
15"H x 48"W
15"H x 60"W

HRVT1524HS3
HRVT1530HS3
HRVT1536HS3
HRVT1542HS3
HRVT1548HS3
HRVT1560HS3

5 2.1
6 2.6
7 3.0
9 3.5
10 4.0
12 5.0

\$287 \$302
\$301 \$316
\$323 \$339
\$343 \$360
\$358 \$376
\$406 \$426

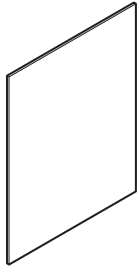

30" Hard-surface Tile and Mounting Kit

30"H x 24"W
30"H x 30"W
30"H x 36"W
30"H x 42"W
30"H x 48"W
30"H x 60"W

HRVT3024HS3
HRVT3030HS3
HRVT3036HS3
HRVT3042HS3
HRVT3048HS3
HRVT3060HS3

10 3.9
12 4.8
15 5.7
18 6.6
20 7.5
25 9.3

\$351 \$369
\$377 \$396
\$420 \$441
\$457 \$480
\$482 \$507
\$528 \$555

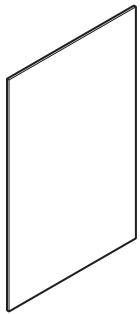

37" Hard-surface Tile and Mounting Kit

37"H x 24"W
37"H x 30"W
37"H x 36"W
37"H x 42"W
37"H x 48"W
37"H x 60"W

HRVT3724HS3
HRVT3730HS3
HRVT3736HS3
HRVT3742HS3
HRVT3748HS3
HRVT3760HS3

12 4.8
16 5.9
19 8.1
22 8.8
25 10.0
31 12.4

\$427 \$448
\$471 \$496
\$516 \$543
\$567 \$596
\$613 \$644
\$692 \$727

NOTES:

- Tiles are made from high-pressure laminate.
- Available in all standard HON laminates.
- On woodgrain laminates, grain direction is vertical.
- Specify paint color.
- 15"H and 30"H tiles are non-dedicated and can be used in any tile position (except on 42"H frames.)

- ❗ All tiles ship with Custom Bracket Kit installed on the tile.
- ❗ One segment bar is required per panel reveal, per panel side.
- ❗ Tiles do not ship with segment bars — must be ordered separately. See page 390. Segment bars are not needed for 42"H monolithic tiles.

HOW TO SPECIFY

<p>Select Model Number</p> <p>HRVT1524HS3</p>	<p>Select Laminate Color</p> <p>See page 371</p> <p>H</p>	<p>Select Edge</p> <p>See page 371</p> <p>P</p>
--	--	--

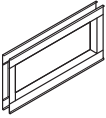
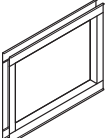

ABOUND® Clear Glass Tiles

	DESCRIPTION	MODEL	SHIP WEIGHT	CUBE	LIST PRICE BY PAINT GRADE	
					P1	P2
	15”H Clear Glass Tiles					
	15”H x 24”W	HRVT1524G	12	0.8	\$617	\$637
	15”H x 30”W	HRVT1530G	15	0.9	\$653	\$673
	15”H x 36”W	HRVT1536G	17	1.1	\$690	\$710
	15”H x 42”W	HRVT1542G	19	1.3	\$737	\$758
	15”H x 48”W	HRVT1548G	20	1.5	\$792	\$813
	15”H x 60”W	HRVT1560G	26	1.8	\$946	\$967
	30”H Clear Glass Tiles					
	30”H x 24”W	HRVT3024G	15	1.4	\$819	\$840
	30”H x 30”W	HRVT3030G	21	1.8	\$874	\$895
	30”H x 36”W	HRVT3036G	22	2.1	\$931	\$952
	30”H x 42”W	HRVT3042G	25	2.4	\$1006	\$1027
	30”H x 48”W	HRVT3048G	28	2.9	\$1082	\$1103
	30”H x 60”W	HRVT3060G	33	3.4	\$1268	\$1289

! Segment bars ordered separately. See page 390.

NOTES:

- Glass is off-set and may be placed on either side of the frame.
- Tile is a single-pane, tempered glass.
- For worksurfaces that can be used with both Abound® and Accelerate® systems, see pages 541-553.
- ! Glass tiles have a Class A fire rating.
- ! Tiles do not include segment bars, must be ordered separately. See page 390. Can be used in any combination.
- ! Glass tiles cannot be placed in the second tier (20”-35” range) due to interference with the horizontal support. Glass tiles cannot be placed in the bottom tier of a frame.
- ! Glass tiles will not work with 42”H frames — use stackers with glass on 42½”H panels.
- ! When stacking on 42½”H frames, panel slots will be off by ½” compared to any other height panel.

HOW TO SPECIFY

<p>Select Model Number</p> <p>HRVT1524G</p>	<p>Select Interior Shroud Paint Color</p> <p>See page 371. Available in all P1/P2 paint colors.</p> <p>T1</p>
--	--

ABOUND® Frosted Glass Tiles

GSA SIN 33721



Icon Legend on page 19

WORKSTATIONS

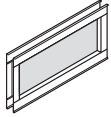

DESCRIPTION

15”H Frosted Glass Tiles

15”H x 24”W
15”H x 30”W
15”H x 36”W
15”H x 42”W
15”H x 48”W
15”H x 60”W

MODEL

SHIP WEIGHT

CUBE

LIST PRICE BY PAINT GRADE

P1

P2

HRVT1524R	12	0.8	\$759	\$779
HRVT1530R	15	0.9	\$815	\$835
HRVT1536R	17	1.1	\$869	\$889
HRVT1542R	19	1.3	\$931	\$952
HRVT1548R	20	1.5	\$1004	\$1025
HRVT1560R	26	1.8	\$1174	\$1195

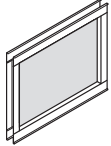

30”H Frosted Glass Tiles

30”H x 24”W
30”H x 30”W
30”H x 36”W
30”H x 42”W
30”H x 48”W
30”H x 60”W

HRVT3024R	15	1.4	\$1071	\$1092
HRVT3030R	21	1.8	\$1143	\$1164
HRVT3036R	22	2.1	\$1219	\$1240
HRVT3042R	25	2.4	\$1311	\$1332
HRVT3048R	28	2.9	\$1403	\$1424
HRVT3060R	33	3.4	\$1610	\$1631

! Segment bars ordered separately. See page 390.

NOTES:

- Glass is off-set and may be placed on either side of the frame.
- Tile is a single-pane, tempered glass.
- For worksurfaces that can be used with both Abound® and Accelerate® systems, see pages 541-553.
- ! Glass tiles have a Class A fire rating.
- ! Tiles do not include segment bars, must be ordered separately. See page 390. Can be used in any combination.
- ! Glass tiles cannot be placed in the second tier (20”-35” range) due to interference with the horizontal support. Glass tiles cannot be placed in the bottom tier of a frame.
- ! Glass tiles will not work with 42”H frames — use stackers with glass on 42½”H panels.
- ! When stacking on 42½”H frames, panel slots will be off by ½” compared to any other height panel.

HOW TO SPECIFY

Select
Model Number

Select
Interior Shroud Paint Color

See page 371. Available in all P1/P2 paint colors.

HRVT1524R . T1



Icon Legend on page 19

ABOUND® Frameless Glass

WORKSTATIONS

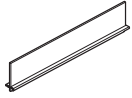

DESCRIPTION

7 1/2" H Frameless Glass

7 1/2" H x 24" W
7 1/2" H x 30" W
7 1/2" H x 36" W
7 1/2" H x 42" W
7 1/2" H x 48" W
7 1/2" H x 54" W (24" + 30")
7 1/2" H x 60" W
7 1/2" H x 66" W (30" + 36")
7 1/2" H x 72" W (36" + 36")
7 1/2" H x 78" W (48" + 30")
7 1/2" H x 84" W (36" + 48" or 42" + 42")
7 1/2" H x 90" W (42" + 48")
7 1/2" H x 96" W (48" + 48" or 36" + 60")

FLAT MODEL	CHAMFERED MODEL	SHIP WEIGHT	CUBE	CLEAR GLASS	FROSTED GLASS
HRVT0724FF	HRVT0724F	18	0.5	\$548	\$585
HRVT0730FF	HRVT0730F	18	0.5	\$587	\$626
HRVT0736FF	HRVT0736F	21	0.6	\$680	\$725
HRVT0742FF	HRVT0742F	25	0.7	\$716	\$765
HRVT0748FF	HRVT0748F	28	0.8	\$766	\$819
HRVT0754FF	HRVT0754F	28	0.8	\$852	\$909
HRVT0760FF	HRVT0760F	35	1.0	\$936	\$1000
HRVT0766FF	HRVT0766F	35	1.0	\$1026	\$1095
HRVT0772FF	HRVT0772F	42	1.9	\$1112	\$1188
HRVT0778FF	HRVT0778F	42	1.9	\$1195	\$1276
HRVT0784FF	HRVT0784F	50	2.1	\$1275	\$1362
HRVT0790FF	HRVT0790F	50	2.1	\$1364	\$1455
HRVT0796FF	HRVT0796F	57	2.4	\$1443	\$1540

NOTES: For models 54" W–96" W, glass can span multiple panel widths. See examples of panel sizes by glass width above.

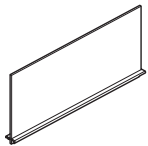

15" H Frameless Glass

15" H x 24" W
15" H x 30" W
15" H x 36" W
15" H x 42" W
15" H x 48" W
15" H x 54" W (24" + 30")
15" H x 60" W
15" H x 66" W (30" + 36")
15" H x 72" W (36" + 36")
15" H x 78" W (48" + 30")
15" H x 84" W (36" + 48" or 42" + 42")
15" H x 90" W (42" + 48")
15" H x 96" W (48" + 48" or 36" + 60")

HRVT1524FF	HRVT1524F	28	1.5	\$616	\$655
HRVT1530FF	HRVT1530F	28	1.5	\$654	\$697
HRVT1536FF	HRVT1536F	34	1.8	\$759	\$809
HRVT1542FF	HRVT1542F	39	2.0	\$808	\$861
HRVT1548FF	HRVT1548F	45	2.3	\$863	\$920
HRVT1554FF	HRVT1554F	51	2.6	\$956	\$1020
HRVT1560FF	HRVT1560F	57	2.8	\$1051	\$1120
HRVT1566FF	HRVT1566F	62	3.2	\$1150	\$1226
HRVT1572FF	HRVT1572F	67	3.5	\$1246	\$1328
HRVT1578FF	HRVT1578F	63	3.7	\$1419	\$1511
HRVT1584FF	HRVT1584F	78	3.9	\$1584	\$1688
HRVT1590FF	HRVT1590F	74	4.2	\$1632	\$1739
HRVT1596FF	HRVT1596F	89	4.4	\$1678	\$1789

NOTES: For models 54" W–96" W, glass can span multiple panel widths. See suggested panel sizes by glass width above.

NOTES:

- Tile is a single-pane, 3/8" laminated safety glass.
- Available in clear or frosted glass.
- New top cap ships with Frameless Glass which fits around the glass insert.
- Frameless Glass can span multiple panels with one piece of glass.
- Lamination is in the center of the glass, making both clear and frosted glass a writable surface with dry-erase markers.
- ⚠ Glass tiles have a Class A fire rating.
- ⚠ Frameless Glass can only be used on the top of panels. Glass integrates into top cap trim.
- ⚠ Power and data cords cannot lay in the top of panel frames when using frameless glass.
- ⚠ Variable height trim for Frameless Glass must be ordered when using panel heights one step up; see page 396.
- ⚠ Cannot hang or stack on top of Frameless Glass.
- ⚠ Abound® power pole cannot be used with Frameless Glass. Freestanding power pole HH870070 can be used at the end of run or one panel needs to be specified without Frameless Glass for ceiling in-feed to enter the panel.

HOW TO SPECIFY

<p>Select Model Number</p> <p>HRVT0724F</p>	<p>Select Glass Option</p> <p>G Clear R Frosted</p> <p>G</p>	<p>Select Paint Color</p> <p>See page 371 P1 Paint (no upcharge) P2 Paint (\$18 upcharge)</p> <p>T1</p>
--	---	--

ABOUND[®] Pass-thru Tiles

GSA SIN 33721



Icon Legend on page 19

WORKSTATIONS

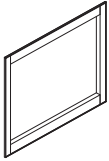

DESCRIPTION	MODEL	SHIP WEIGHT	CUBE	LIST PRICE BY PAINT GRADE	
				P1	P2
30" H Pass-Thru Tile Kit					
22½"H x 24"W	HRVT3024P	8	1.2	\$173	\$194
22½"H x 30"W	HRVT3030P	8	1.5	\$197	\$218
22½"H x 36"W	HRVT3036P	9	1.8	\$217	\$238
22½"H x 42"W	HRVT3042P	10	2.1	\$225	\$246
22½"H x 48"W	HRVT3048P	11	2.3	\$249	\$270
22½"H x 60"W	HRVT3060P	12	2.9	\$259	\$280

NOTES: Pass-thru opening is 22½"H. To be used with 30"H tiles. Order one 7½"H fabric tiles per pass-thru tile, if finishing only one side of panel.

- ⓘ Must order a quantity of two (2) 7½"H fabric tiles per pass-thru tile, if finishing both sides of panel.
- ⓘ Half segment bar (wall hanger segment bar) is needed for bottom of tile, and full segment bar is needed above the pass-thru tile below the 7½"H tile.

HOW TO SPECIFY

Select Model Number <div style="border: 1px solid black; padding: 2px; display: flex; gap: 2px;"> HRVT3024P </div>	Select Paint Color See page 371 <div style="border: 1px solid black; padding: 2px; display: flex; gap: 2px;"> T1 </div>
---	--

DESCRIPTION	MODEL	SHIP WEIGHT	CUBE	LIST PRICE BY FABRIC GRADE								
				AA	A	B	C	D	E	F	G	
7½" H Fabric Tackable Tile												
7½"H x 24"W	HRVT0724T	2 ⓘ	1.4	\$85	\$90	\$93	\$95	\$101	\$106	\$112	\$115	
7½"H x 30"W	HRVT0730T	2 ⓘ	1.8	\$100	\$105	\$108	\$112	\$118	\$126	\$129	\$132	
7½"H x 36"W	HRVT0736T	2 ⓘ	2.1	\$107	\$112	\$115	\$119	\$125	\$133	\$136	\$139	
7½"H x 42"W	HRVT0742T	2 ⓘ	2.4	\$118	\$124	\$128	\$132	\$143	\$146	\$150	\$154	
7½"H x 48"W	HRVT0748T	2 ⓘ	2.8	\$125	\$131	\$135	\$139	\$150	\$153	\$157	\$161	
7½"H x 60"W	HRVT0760T	3 ⓘ	3.4	\$149	\$170	\$175	\$180	\$192	\$197	\$200	\$203	

NOTES:

- Order one 7½"H fabric tiles per pass-thru tile, if finishing only one side of panel.
- ⓘ Must order a quantity of two (2) 7½"H fabric tiles per pass-thru tile, if finishing both sides of panel.

HOW TO SPECIFY

Select Model Number <div style="border: 1px solid black; padding: 2px; display: flex; gap: 2px;"> HRVT0724T </div>	Select Fabric Color See pages 372-373 <div style="border: 1px solid black; padding: 2px; display: flex; gap: 2px;"> APN15 </div>
---	--



ABOUND[®] Slotted Tool Tiles

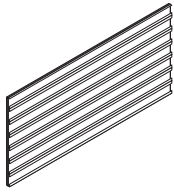

DESCRIPTION

15" H Slotted Tool Tiles
 15" H x 24" W
 15" H x 30" W
 15" H x 36" W
 15" H x 42" W
 15" H x 48" W
 15" H x 60" W

ⓘ Segment bars ordered separately. See page 390.

MODEL	SHIP WEIGHT	CUBE	LIST PRICE BY PAINT GRADE		
			P1	P2	P3
HRVT1524W	11	0.8	\$347	\$378	\$402
HRVT1530W	13	0.9	\$374	\$405	\$433
HRVT1536W	15	1.1	\$399	\$430	\$462
HRVT1542W	17	1.3	\$426	\$457	\$493
HRVT1548W	20	1.5	\$450	\$481	\$521
HRVT1560W	24	1.8	\$477	\$508	\$552

NOTES:

- Tiles made from sturdy aluminum extrusion and steel supports with a powder coat finish.
- ⓘ Tiles do not include segment bars, must be ordered separately. See page 390. Can be used in any combination.
- ⓘ Weight capacity of hang-on accessories should not exceed 80 pounds.

HOW TO SPECIFY

<p>Select Model Number</p> <p>HRVT1524W</p>	<p>Select Paint Color</p> <p>See page 371 P1 and P2 Paint Option</p> <p>P8S</p>
--	--



SYSTEMS PAPER MANAGEMENT SUPPORT BAR

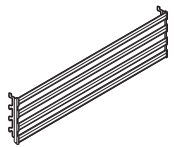

DESCRIPTION

Systems Paper Management Support Bars
 24" W x 5" H
 30" W x 5" H
 36" W x 5" H
 42" W x 5" H
 48" W x 5" H
 60" W x 5" H

ⓘ Recommended weight capacity not to exceed 80 pounds.

MODEL	SHIP WEIGHT	CUBE	LIST PRICE BY PAINT GRADE		
			P1	P2	P3
HNPMSW24	1.3	0.4	\$252	\$265	\$275
HNPMSW30	1.5	0.5	\$270	\$283	\$293
HNPMSW36	2.0	0.6	\$280	\$293	\$303
HNPMSW42	5.0	0.7	\$294	\$307	\$317
HNPMSW48	7.0	0.8	\$306	\$319	\$329
HNPMSW60	9.0	0.9	\$347	\$360	\$370

NOTES:

- Paper management bar attaches to Systems Panels to accommodate work flow accessories.

HOW TO SPECIFY

<p>Select Model Number</p> <p>HNPMSW24</p>	<p>Select Paint Color</p> <p>See page 371 P1 and P2 Paint Option</p> <p>P8S</p>
---	--

ABOUND[®] Markerboard Tiles

GSA SIN 33721



Icon Legend on page 19

WORKSTATIONS

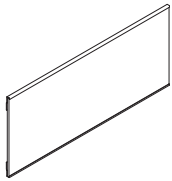

DESCRIPTION

15" H Markerboard Tiles

15" H x 24" W
15" H x 30" W
15" H x 36" W
15" H x 42" W
15" H x 48" W
15" H x 60" W

MODEL

SHIP WEIGHT

CUBE

LIST PRICE

HRVT1524M	4	1.2	\$315
HRVT1530M	4	1.8	\$337
HRVT1536M	5	2.5	\$355
HRVT1542M	5	3.4	\$376
HRVT1548M	6	4.3	\$386
HRVT1560M	7	6.7	\$401

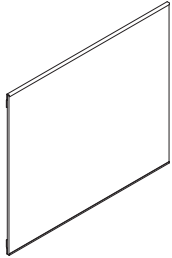

30" H Markerboard Tiles

30" H x 24" W
30" H x 30" W
30" H x 36" W
30" H x 42" W
30" H x 48" W
30" H x 60" W

HRVT3024M	6	1.2	\$346
HRVT3030M	7	1.8	\$371
HRVT3036M	8	2.5	\$408
HRVT3042M	10	3.4	\$434
HRVT3048M	11	4.3	\$477
HRVT3060M	13	6.7	\$527



Magnetic Markerboard Tray

15" Natural Aluminum

HRVTRAYM

4

0.4

\$82

! Natural Aluminum only, no need to specify paint.

NOTES:

- Markerboard tile has a painted, steel surface.
- Accepts magnetic accessories.
- Markerboard tray attaches to the tile magnetically. Order separately.
- ! Tiles do not include segment bars, must be ordered separately. See page 390. Can be used in any combination.
- ! Markerboard cleaning instructions: For everyday cleaning, use Chlorox[®] wipes. Use citrus cleaner if a permanent marker is used by accident. A citrus cleaner is not recommended for everyday use as it leaves residue.

HOW TO SPECIFY

Select
Model Number

H R V T 1 5 2 4 M

Select
Option

X

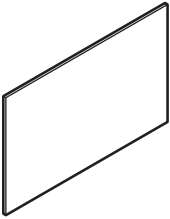
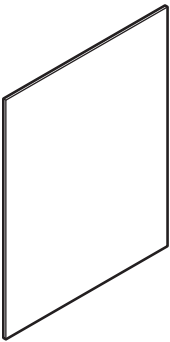

ABOUND[®] Painted Metal Tiles

	DESCRIPTION	MODEL	SHIP WEIGHT	CUBE	LIST PRICE BY PAINT GRADE	
					P1	P2
	15”H Painted Metal Tile					
	15”H x 24”W	HRVT1524PM	4	1.2	\$202	\$224
	15”H x 30”W	HRVT1530PM	4	1.8	\$217	\$239
	15”H x 36”W	HRVT1536PM	5	2.5	\$232	\$254
	15”H x 42”W	HRVT1542PM	5	3.4	\$251	\$273
	15”H x 48”W	HRVT1548PM	6	4.3	\$275	\$297
	15”H x 60”W	HRVT1560PM	7	6.7	\$305	\$327
	30”H Painted Metal Tile					
	30”H x 24”W	HRVT3024PM	6	1.2	\$295	\$330
	30”H x 30”W	HRVT3030PM	7	1.8	\$321	\$356
	30”H x 36”W	HRVT3036PM	8	2.5	\$360	\$395
	30”H x 42”W	HRVT3042PM	10	3.4	\$386	\$421
	30”H x 48”W	HRVT3048PM	11	4.3	\$431	\$466
	30”H x 60”W	HRVT3060PM	13	6.7	\$482	\$517

NOTES:

- Painted steel construction.

! Tiles do not include segment bars, must be ordered separately. See page 390. Can be used in any combination.

HOW TO SPECIFY

<p>Select Model Number</p> <p>HRVT1524PM . T3</p>	<p>Select Paint Color</p> <p>See page 371</p>
---	---

ABOUND® Custom Material Bracket Kit

GSA SIN 33721



Icon Legend on page 19

WORKSTATIONS

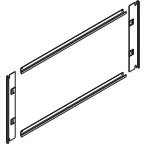

DESCRIPTION

Custom Material Mounting Bracket Kit

15"H x 24"W
15"H x 30"W
15"H x 36"W
15"H x 42"W
15"H x 48"W
15"H x 60"W

MODEL

HRVT1524CK
HRVT1530CK
HRVT1536CK
HRVT1542CK
HRVT1548CK
HRVT1560CK

SHIP WEIGHT

1 Ⓢ
1 Ⓢ
1 Ⓢ
1 Ⓢ
2 Ⓢ
2

CUBE

0.8
0.9
1.1
1.3
1.5
1.8

LIST PRICE

\$91
\$95
\$102
\$105
\$111
\$122

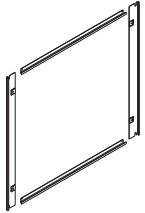

30"H x 24"W
30"H x 30"W
30"H x 36"W
30"H x 42"W
30"H x 48"W
30"H x 60"W

HRVT3024CK
HRVT3030CK
HRVT3036CK
HRVT3042CK
HRVT3048CK
HRVT3060CK

3 Ⓢ
3 Ⓢ
3 Ⓢ
4 Ⓢ
5 Ⓢ
5

1.4
1.8
2.1
2.4
2.8
3.4

\$91
\$95
\$102
\$105
\$111
\$122

NOTES: Custom Material Bracket Kits can be ordered to use with Customer's Own Material. Please contact HON Customer Support for exact dimensions if further information is needed.



Coat Hooks

Package of six

HHPMC6

1 Ⓢ

0.2

\$113

NOTES: Compatible with Accelerate® and Abound® panels. Coat hooks hang directly into slotted Abound panel frame.

ⓘ Available in Black (P).

SPECIFYING EXAMPLE: HHPMC6.P

HOW TO SPECIFY

Select Model Number

Select Paint Color

See page 371

HRVT1524CK

T1

DESCRIPTION

Abound® Anchor Bracket

Package of ten

MODEL

HRABAB

SHIP WEIGHT

5 Ⓢ

CUBE

0.08

LIST PRICE

\$112

NOTES: For use when panels need to be anchored to the floor such as high traffic areas or community spaces.

ⓘ Only available in Black (P).

ⓘ Only for use at the end of a wing panel.

SPECIFYING EXAMPLE: HRABAB.P

DESCRIPTION

Abound® Stability Foot

NOTES: Stabilizes bottom of panel from movement. Will not prohibit movement at top of panel.

ⓘ Only for use at the end of a wing panel.

MODEL

HRFTAB

SHIP WEIGHT

3

CUBE

0.1

LIST PRICE BY PAINT GRADE

P1

\$481

P2

\$492

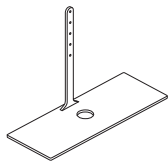

NOTES:

ⓘ The Anchor Bracket and Stability Foot are not intended to create a freestanding panel. Please follow Abound® stability standards.

ⓘ Attachment hardware for floor anchor not included.

HOW TO SPECIFY

Select Model Number

Select Paint Color

See page 371

HRFTAB

T1

ACCELERATE®

Want to see more? Scan here
to check out hon.com.



WORKSTATIONS



Accelerate® shown with Ignition® Seating.

ACCELERATE®

Today's office moves at the speed of light. And that means you need a sensible, streamlined workflow that can adapt to any employee, project, or space. Accelerate workstations are designed with meaningful connection, peak productivity, and seamless adaptability in mind. Whether it's operating as a stand-alone or in a large, open space, Accelerate optimizes any environment with easy-to-configure layout options, exceptional storage capabilities, and stunning customization choices.

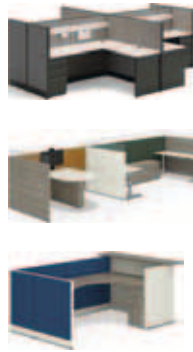

FEATURES

- Customize your spaces! Add fabric stackers for height and privacy, or glass stackers to let the light in.
- Accelerate's crisp details have been designed to meet today's contemporary aesthetic. Clean. Minimal. Beautiful.
- Accelerate panels are compatible with other HON products, like Abode™ desks, Contain® storage and more.
- The interchangeable components allow you to customize your space with a clean, contemporary look — and change your mind without changing your furniture.

ACCELERATE® ORDERING INFORMATION

WORKSURFACES, COUNTERTOPS, CORNER SHELVES W/EDGE BAND

L1 LAMINATES CODES

Woodgrain

◆ Bourbon Cherry	H
◆ Cognac	COGN
◆ Field Elm	LWFE
◆ Florence Walnut	LFW1
◆ Harvest	C
◆ Kingswood Walnut	LK11
◆ Mahogany	N
◆ Mocha	MOCH
◆ Natural Maple	D
◆ Pinnacle	PINC
◆ Shaker Cherry	F
◆ Sterling Ash	LSA1

Solid

◆ Black	P
◆ Charcoal	S
◆ Designer White	LDW1
◆ Loft	LOFT

Patterned

◆ Handspun Chestnut	LAHC
◆ Handspun Dove	LAHD
◆ Handspun Pearl	LAHP
◆ Handspun Slate	LAHS
◆ Silver Mesh	B9
◆ Steel Mesh	A9
◆ Gray	G2
◆ White	G1

L2 LAMINATES CODES

Woodgrain

◆ Beigewood	LWBE
◆ Fawn Cypress	LFC1
◆ Lowell Ash	LLA1
◆ Natural Recon	LNR1
◆ Phantom Ecru	LPE1
◆ Portico Teak	LPT1
◆ Skyline Walnut	LSW1

WORKSURFACE EDGE BAND

◆ Beigewood	DE
◆ Black	P
◆ Bourbon Cherry	H
◆ Brownstone	EY
◆ Charcoal	S
◆ Cognac	COGN
◆ Designer White	DW
◆ Fawn Cypress	FC
◆ Field Elm	FE
◆ Florence Walnut	FW
◆ Fossil	EH
◆ Greige	R
◆ Harvest	C
◆ Kingswood Walnut	KI
◆ Light Gray	Q
◆ Loft	LOFT
◆ Lowell Ash	DL
◆ Mahogany	N
◆ Mocha	MOCH
◆ Muslin	T
◆ Natural Maple	D
◆ Natural Recon	NR
◆ Phantom Ecru	PE
◆ Pinnacle	PINC
◆ Platinum	K
◆ Portico Teak	DP
◆ Shaker Cherry	F
◆ Skyline Walnut	SW
◆ Sterling Ash	SA

WORKSURFACE GROMMET

PLASTIC CODES	
◆ Black	P
◆ Brownstone	EY
◆ Charcoal	S
◆ Fossil	EH
◆ Greige	T5
◆ Light Gray	Q
◆ Loft	LOFT
◆ Muslin	T3
◆ Titanium	T1
◆ Designer White	DW
◆ Platinum Metallic	T1

FRAMES, TRIM, METAL TILES, CUSTOM BRACKET KIT, WORKSURFACE SUPPORTS

PAINT CODES

P1

◆ Black	P
◆ Brownstone	P7D
◆ Charcoal	S
◆ Cove	P096
◆ Designer White	PJW
◆ Dune	P094
◆ Fossil	P28
◆ Greige	T5
◆ Harbor	P097
◆ Light Gray	Q
◆ Loft	LOFT
◆ Muslin	T3
◆ Putty	L
◆ Sage	P095
◆ Titanium	P8T

P2

◆ Champagne Metallic	T4
◆ Gunmetal Metallic	PR3
◆ Platinum Metallic	T1
◆ Silver	PR6
◆ Solar Black	P8X

OVERHEADS AND SHELVES

PAINT CODES

P1

◆ Black	P
◆ Brownstone	P7D
◆ Charcoal	S
◆ Designer White	PJW
◆ Fossil	P28
◆ Greige	T5
◆ Light Gray	Q
◆ Loft	LOFT
◆ Muslin	T3
◆ Putty	L
◆ Titanium	P8T

P2

◆ Champagne Metallic	T4
◆ Gunmetal Metallic	PR3
◆ Platinum Metallic	T1

DUPLEX/PORTED TILE

PLASTIC CODES

◆ Black	P
◆ Brownstone	P7D
◆ Charcoal	S
◆ Designer White	DW
◆ Loft	LOFT
◆ Muslin	T3
◆ Titanium	T1

Recommendations

Paint	Duplex-Data Code
Black P	Black P
Brownstone P7D	Brownstone EY
Charcoal S	Charcoal S
Designer White PJW	Designer White DW
Fossil P28	Charcoal S
Greige T5	Muslin T3
Light Gray Q	Loft LOFT
Loft LOFT	Loft LOFT
Muslin T3	Muslin T3
Putty L	Black P
Silver PR6	Titanium T1
Titanium P8T	Titanium T1
Champagne Metallic T4	Muslin T3
Platinum Metallic T1	Titanium T1

► LAMINATE TOPS

SPECIFY: Model Number.
Laminate.
Edge Color.
Grommet Color

EXAMPLE: HWR2424P.K8.R.T5

► PANELS

SPECIFY: Model Number.
Fabric.
Paint

EXAMPLE: HETP3520FP.APN1.S

► CONNECTORS

SPECIFY: Model Number.
Paint

EXAMPLE: HEC35PSN.T3

◆◆◆ For lead time information see page 21.

Replacement Duplex Receptacle Covers are made from a polymer material and are available in the following colors only:

Black P
Muslin T3

ACCELERATE[®] FABRIC PATTERNS & CODES

PRICE CODE AA

FACTOR	FACT
◇ Bark *	FACT20
◇ Barley *	FACT15
◇ Cascade *	FACT25
◇ Feather *	FACT30

PRICE CODE A

APPOINT	APN
◇ Artichoke	APN11
◇ Blackberry	APN32
◇ Bronze	APN22
◇ Carbon	APN28
◇ Chai	APN12
◇ Cherry	APN30
◇ Dark Pewter	APN17
◇ Dune	APN15
◇ Espresso	APN23
◇ Framboise	APN31
◇ Frost	APN34
◇ Jet	APN27
◇ Lawn	APN25
◇ Mandarin	APN29
◇ Morel	APN09
◇ Nimbus	APN16
◇ Platinum	APN24
◇ Turquoise	APN26

CENTURION CU

◇ Apricot	CU47
◇ Bark	CU25
◇ Black	CU10
◇ Espresso	CU49
◇ Fog	CU03
◇ Frost	CU22
◇ Goldenrod	CU27
◇ Indigo	CU06
◇ Iris	CU50
◇ Iron Ore	CU19
◇ Jade	CU83
◇ Marsala	CU63
◇ Morel	CU24
◇ Navy	CU98
◇ Peacock	CU97
◇ Pear	CU84
◇ Ruby	CU67
◇ Sapphire	CU09

PRICE CODE A *continued*

ETCH*	ECH
◇ Axis	ECH13
◇ Blend	ECH14
◇ Cast	ECH12
◇ Highlight	ECH10
◇ Midtone	ECH11
◇ Outline	ECH08
◇ Shade	ECH09
◇ Tonal	ECH16
◇ Vanish	ECH15

LANDSCAPE* LN

◇ Azure	LN55
◇ Cornsilk	LN15
◇ Drift	LN05
◇ Khaki	LN20
◇ Sheen	LN10
◇ Slate	LN35
◇ Umber	LN25
◇ Urban	LN30

LUCY* LC

◇ Aspen	LC32
◇ Cornsilk	LC30
◇ Dusk	LC22
◇ Fawn	LC33
◇ Graphite	LC34
◇ Mist	LC20
◇ Neutra	LC24
◇ Pewter	LC35
◇ Snowdrop	LC28

PRICE CODE A *continued*

NOBLE	NBLE
◇ Aegean	NBLE18
◇ Amethyst	NBLE19
◇ Aspen	NBLE14
◇ Aster	NBLE20
◇ Blossom	NBLE21
◇ Bluebell	NBLE22
◇ Bordeaux	NBLE01
◇ Brick	NBLE02
◇ Chambray	NBLE10
◇ Chamomile	NBLE23
◇ Clementine	NBLE04
◇ Conifer	NBLE24
◇ Cottage	NBLE25
◇ Darkness	NBLE26
◇ Dawn	NBLE13
◇ Denim	NBLE09
◇ Desert Sand	NBLE27
◇ Dewfall	NBLE28
◇ Dusted Sage	NBLE29
◇ Flax	NBLE30
◇ Grass	NBLE07
◇ Gunmetal	NBLE15
◇ Harmony	NBLE31
◇ Harvest	NBLE12
◇ Ice Caves	NBLE32
◇ Icicle	NBLE33
◇ Inky	NBLE34
◇ Iris	NBLE35
◇ Jade	NBLE06
◇ Knight	NBLE17
◇ Mesa	NBLE03
◇ Monarch	NBLE36
◇ Pacific	NBLE08
◇ Pitch	NBLE37
◇ Queen Bee	NBLE38
◇ Rainforest	NBLE05
◇ Regal	NBLE11
◇ Sandcastle	NBLE39
◇ Sedona	NBLE40
◇ Stormy	NBLE16
◇ Sunbeam	NBLE41
◇ Voyager	NBLE42
◇ Windy Day	NBLE43

NOTES: Centurion fabric not available on panels that exceed a width and height of 54".
Disperse panel fabric will be applied pattern cut. Disperse will not be available on 72"W panels.

◆◆◆ For lead time information see page 21.

* Directional fabrics

* Fabric is de-emphasized.

ACCELERATE® FABRIC PATTERNS & CODES

PRICE CODE A *continued*

REFLECTIONS*	REF
◆ Galvanized	REF29
◆ Ice	REF20
◆ Loggia	REF21
◆ Mistral	REF28
◆ Moonstone	REF23
◆ Pewter	REF22
◆ Stainless	REF24
◆ Vanilla	REF25
◆ Winter	REF27

REFUGE*	RFG
◆ Artesian	RFG96
◆ Dune	RFG92
◆ Eclipse	RFG90
◆ Frost	RFG93
◆ Glacier	RFG91
◆ Mineral	RFG98
◆ Tidal	RFG94

TEMPEST*	TP
◆ Dragonfly	TP30
◆ Frost	TP15
◆ Full Stream	TP80
◆ Gold Rush	TP10
◆ Slate	TP45
◆ Tumbleweed	TP70
◆ Wind Chill	TP40
◆ Zebra	TP35

VAST	VST
◆ Atmosphere	VST06
◆ Bay	VST04
◆ Beach	VST11
◆ Country Side	VST13
◆ Desert	VST12
◆ Garden	VST02
◆ Grasslands	VST03
◆ Highway	VST09
◆ Mountain Range	VST08
◆ Ocean	VST07
◆ Open Air	VST05
◆ Tundra	VST10
◆ Vineyard	VST01

PRICE CODE B

DISPERSE*	DISP
◆ Autumn	DISP03
◆ Branch	DISP10
◆ Coffee Bean	DISP13
◆ Dusk	DISP09
◆ Emerald City	DISP08
◆ Gold Rush	DISP02
◆ Igloo	DISP11
◆ Ink	DISP06
◆ Mist	DISP12
◆ Oatmeal	DISP15
◆ Prince	DISP07
◆ Reservoir	DISP01
◆ Rose	DISP04
◆ Spring	DISP05
◆ Steel	DISP16
◆ Taupe	DISP14

MICA*	MCA
◆ Anthracite	MCA11
◆ Breeze	MCA18
◆ Bronze	MCA13
◆ Buff	MCA14
◆ Cremini	MCA17
◆ Crystal	MCAWIT
◆ Dew	MCA20
◆ Dove	MCA12
◆ Fresh	MCA16
◆ Mineral	MCA15
◆ Nectar	MCA19
◆ Shale	MCA10

PRICE CODE B *continued*

SPIN*	SPIN
◆ Alabaster	SPIN02
◆ Cavern	SPIN03
◆ Cobblestone	SPIN04
◆ Ember	SPIN06
◆ Flame	SPIN07
◆ Heron	SPIN13
◆ Oat	SPIN01
◆ Ocean	SPIN12
◆ Plum	SPIN15
◆ Pool	SPIN11
◆ Raven	SPIN10
◆ Rhubarb	SPIN14
◆ Tropic	SPIN08
◆ Willow	SPIN05

PRICE CODE B *continued*

TERRAIN*	TRRN
◆ Bay	TRRN05
◆ Bayou	TRRN35
◆ Canyon	TRRN30
◆ Cliff	TRRN45
◆ Crest	TRRN25
◆ Delta	TRRN10
◆ Plateau	TRRN15
◆ Ridge	TRRN20
◆ Valley	TRRN40

NOTES: Disperse panel fabric will be applied pattern cut. Disperse will not be available on 72"W panels.

◆◆◆ For lead time information see page 21.

* Directional fabrics

ACCELERATE® Typicals



Icon Legend on page 19

WORKSTATIONS

QTY	DESCRIPTION	MODEL	FABRIC GRADE	LIST PRICE	PRICE EXTENSION
2	Accelerate® Top Cap 72"W	HETC72		\$134	\$268
2	Tackable Panel 50"H x 72"W	HETP5072FP		\$749	\$1,498
1	"L" Connector 50"H	HEC50PLN		\$169	\$169
1	"L" Connector Strap	HECSL		\$21	\$21
2	Panel Finished End Covers 50"H	HEFEC50P		\$78	\$156
2	Electrical Power Harness Panels w/Duplex Capacity	HH871272		\$286	\$572
1	Duplex Receptacle Circuit 1 3-1 & 2-2	HH871501		\$58	\$58
1	Duplex Receptacle Circuit 4 3-1 & 2-2	HH871504		\$58	\$58
1	Base In-Feed Cable Base 3-1 & 2-2	HH879072		\$303	\$303
1	Rectangular Worksurface 24"D x 48"W	HWR2448P		\$520	\$520
1	Rectangular Worksurface 24"D x 72"W	HWR2472P		\$679	\$679
1	24"D Cantilever - One Pair	HCTL242		\$110	\$110
1	Flat Bracket 24"D	HHN831124		\$85	\$85
1	External Stiffener 48"W	HLSLZ5SC60		\$135	\$135
1	Flagship® Series Freestanding Pedestal "A" Pull B/B 15"W x 22 1/8"D x 28"H	H19723A		\$975	\$975
1	Flagship® Series Freestanding Pedestal "A" Pull F/F 15"W x 22 1/8"D x 28"H	H19823A		\$975	\$975
1	Pedestal-to-Panel Bracket, Left	HPD2PNBRK2L		\$148	\$148
1	Pedestal-to-Panel Bracket, Right	HPD2PNBRK2R		\$148	\$148
1	Lota® Mid-Back Chair	H2281	1	\$1,124	\$1,124

TOTAL: \$8,002

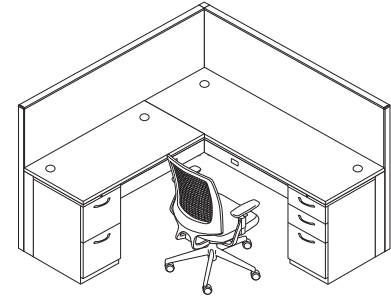

QTY	DESCRIPTION	MODEL	FABRIC GRADE	LIST PRICE	PRICE EXTENSION
2	Tackable Top-Tier Glass Panel 50"H x 20"W	HETP5020DP		\$654	\$1,308
2	Tackable Top-Tier Glass Panel 50"H x 42"W	HETP5042DP		\$775	\$1,550
5	Tackable Panel 65"H x 24"W	HETP6524FP		\$460	\$2,300
2	Tackable Panel 65"H x 48"W	HETP6548FP		\$590	\$1,180
2	Accelerate® Top Cap 72"W	HETC72		\$134	\$268
3	Accelerate® Top Cap 24"W	HETC24		\$51	\$153
2	Accelerate® Top Cap 20"W	HETC20		\$51	\$102
2	Accelerate® Top Cap 42"W	HETC42		\$81	\$162
4	Worksurface Bracket Kits	HWSB2		\$62	\$248
2	Flat Bracket 24"D	HHN831124		\$85	\$170
2	Straight Connector Kits	HSCKTPS		\$28	\$56
2	"L" Connector 50"H	HEC50PLN		\$169	\$338
2	"L" Connector 65"H	HEC65PLN		\$189	\$378
1	"T" Connector 65"H	HEC65PTN		\$182	\$182
4	"L" Connector Strap	HECSL		\$21	\$84
1	"T" Connector Strap	HECST		\$30	\$30
2	Panel Finished End Covers 50"H	HEFEC50P		\$78	\$156
1	Panel Finished End Covers 65"H	HEFEC65P		\$86	\$86
2	In-line Variable Height Finishing Kit 15"W	HEVHF15P		\$77	\$154
2	Electrical Power Harness 3-1 & 2-2 48"W	HH871248		\$286	\$572
1	Electrical Pass-Thru w/o Power Block 3-1 & 2-2 48"W	HH871048		\$164	\$164
1	Base In-Feed Cable Base 3-1 & 2-2	HH879072		\$303	\$303
1	Duplex Receptacle Circuit 1 3-1 & 2-2	HH871501		\$58	\$58
1	Duplex Receptacle Circuit 2 3-1 & 2-2	HH871502		\$58	\$58
1	Duplex Receptacle Circuit 4 3-1 & 2-2	HH871504		\$58	\$58
1	Duplex Receptacle Circuit 1 3-1 & 2-2	HH871506		\$58	\$58
2	Rectangular Worksurface 18"D x 42"W	HWR1842P		\$427	\$854
2	Rectangular Worksurface 24"D x 48"W	HWR2448P		\$520	\$1,040
2	Worksurface to Tower Bracket Kits	HSTB2W1		\$112	\$224
2	Stack-on Storage w/Sliding Doors 14 1/4"D x 48"W x 13"H	HLSL1448S		\$1,446	\$2,892
2	Voi® for Systems Stack-on Storage Panel Mounted Bracket	HLSLPMB		\$175	\$350
2	Voi® Mobile Pedestal 15 3/4"W x 21 1/8"D x 21 1/8"H	HLSL2016MP2	1	\$1,070	\$2,140
2	Voi® Pedestal Cushion	HLSL2016PH2	2	\$442	\$884
1	Voi® Personal Storage Tower (LH) 24"D x 24"W x 65"H	HLSLW446LP		\$3,493	\$3,493
1	Voi® Personal Storage Tower (RH) 24"D x 24"W x 65"H	HLSLW446RP		\$3,493	\$3,493
2	Nucleus® 4-Way Stretch Back Task Chair	HNR1	1	\$818	\$1,636

TOTAL: \$27,182

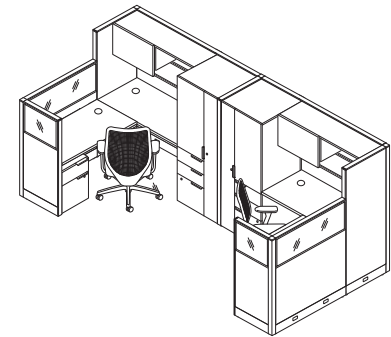



Icon Legend on page 19

ACCELERATE® Typicals

WORKSTATIONS

QTY	DESCRIPTION	MODEL	FABRIC GRADE	LIST PRICE	PRICE EXTENSION
1	In-Line Connector	HCKTTPS		\$28	\$28
2	Tackable Panel 42½"H x 24"W	HETP4224FP		\$381	\$762
2	Tackable Panel 42½"H x 60"W	HETP4260FP		\$532	\$1,064
2	Accelerate® Top Cap 60"W	HETC60		\$111	\$222
2	Accelerate® Top Cap 24"W	HETC24		\$51	\$102
4	Accelerate® Countertop Kit	HECB42		\$71	\$284
2	Worksurface Bracket Kit	HWSB2		\$62	\$124
1	Universal Support Leg 24"D	HRVCLG24		\$255	\$255
2	"L" Connector 42½"H	HEC42PLN		\$148	\$296
2	"L" Connector Strap	HECSL		\$21	\$42
1	"T" Connector Strap	HECST		\$30	\$30
2	Panel Finished End Covers 42½"H	HEFEC42P		\$72	\$144
1	Base In-Feed Cable Base 3-1 & 2-2	HH879072		\$303	\$303
1	Electrical Pass-Thru Cable w/Duplex For 24"W Panel	HH871124		\$172	\$172
2	Electrical Power Harness 3-1 & 2-2 60"W	HH871260		\$286	\$572
2	Duplex Receptacle Circuit 4 3-1 & 2-2	HH871504		\$58	\$116
2	Rectangular Worksurface 24"D x 60"W	HWR2460P		\$614	\$1,228
2	Straight Countertop 60"W x 15"D	HBCSR1560P		\$487	\$974
2	Flagship® Mobile Series Pedestal "A" Pull B/B/F 15"W x 22⅞"D x 28"H	H18723A		\$991	\$1,982
2	Ignition® Mid-Back Work Chair	HIWM3	1	\$1,047	\$2,094
				TOTAL:	\$10,794



ACCELERATE® PANELS OVERVIEW

INTERSECTING CONNECTIONS

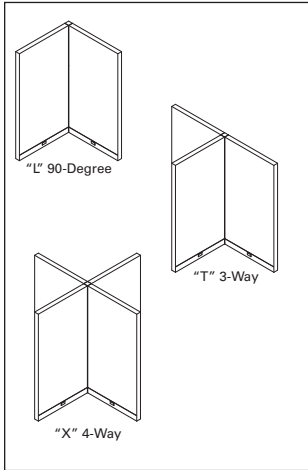

“L”, “T” and “X” connector kits are used when connecting frames at intersecting runs. For “L”, “T” and “X” connector kits, add 2¼” to the total length of the panel run for each intersection, whether located in the middle or at the end of the run.

Wall starter kits provide a means to affix a panel run to a permanent building wall. Kit adds ⅞” to length of panel run.

STACKING PANELS

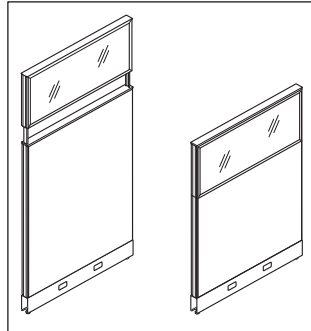

Stackers add 15” to the height of the base panel and can be ordered separately or as part of the panel model, see pages 423 and 426.

When adding stackers to an existing panel, a new connector must be ordered, to the tallest panel height.

Please note that Stacking Panels are not to be used freestanding and must match the panel width of the panel it is stacking on.

Cannot use a stacking panel on a Top Tier Glass Panel model.

Stackers ship with pins to connect stacker to post connector for added rigidity.

Stackers can be stacked up to 80”H on a base panel. Overheads can be placed on the first stacker only, up to 65”H. Voi overheads are not to be placed on stackers.

Top View			
Panel		Panel	
	→	← 2¼"	
Panel	S	Panel	

Extended straight connector kit “S” can be used to keep continuous runs dimensionally consistent with opposing panel runs which incorporate “T” or “X” intersections. (Add 2¼” to the length of the run for every extended straight connector used.)

IN-LINE CONNECTIONS

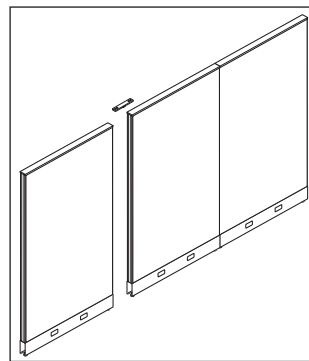

There is no incremental increase in dimension along the panel run when using an in-line connector kit.

END OF RUN

Finished end trim must be specified for the unconnected sides of panel. When adding a stacking panel, order finished end trim in the height that matches the total stacked height. Move the end cap from the standard frame end trim to the stacking frame end trim.

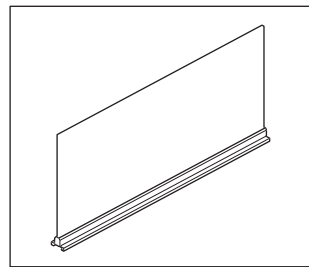

Accelerate® frameless glass is single pane, ⅜” thick laminate safety glass, available in clear or frosted glass.

Frameless glass is not allowed on top of glass stackers or glass header panels and hanging or stacking on frameless glass is not permitted.

Frameless glass can span multiple panels with one piece of glass, creating a clean, seamless look.

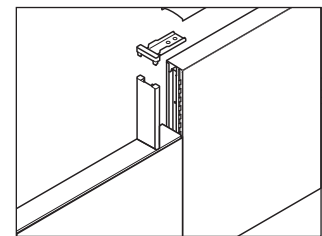

IN-LINE VARIABLE HEIGHT TRIM
In-line connections between different height panels require trim to cover the exposed frame of the taller panel.

VARIABLE HEIGHT CONNECTOR TRIM

L, X and T connections between different height panels require trim to cover the exposed connector. The bottom of the trim is flat to match the profile of the top cap. Models are designated as “Variable Height Connector Trim”. For variable height connections in a Y configuration, contact the Accelerate Specials Department.

Multiple-height connections are accomplished by combining standard height panel connectors (35”H, 42”H, 50”H and 65”H) with shorter trim kits (7”H, 15”H, 22”H and 30”H). Start from the top-down — select the standard connector that corresponds to the height and connection type of the tallest panel. (See examples.)

ACCELERATE® PANELS OVERVIEW

Example 1

Connectors required:
1-50"H "T" Connector
2-15"H Connector VH Kit
2-35"H End Trim
1-65"H End Trim

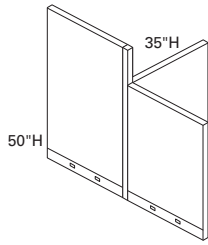

In variable height "T" connections — as shown above — you would use the connectors as indicated.

Example 2

Connectors required:
1-50"H "X" Connector
2-7½"H Connector VH Kit
2-50"H End Trim
2-42"H End Trim

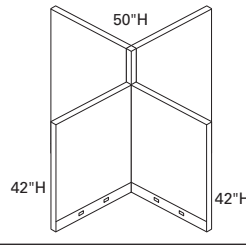

Example 3

Connectors required:
1-65"H "T" Connector
1-15"H Connector VH Kit
1-22½"H Connector VH Kit
1-65"H End Trim
1-50"H End Trim
1-42"H End Trim

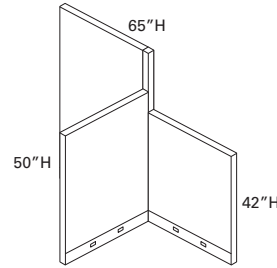

Example above represents Accelerate variable height "L" for 65" to 50".

TOP CAPS

Top caps must be specified as a separate model from the panel. Top caps can span more than one panel when panels are connected in an in-line.

ACCELERATE® WORKING WITH PANELS

PANELS

- Accelerate® Panels are 2½" thick and available in 4 heights / 8 widths.

NOTE: Actual panel height varies depending on position of levelers.

NOMINAL PANEL HEIGHT	PANEL WIDTHS							
	20"	24"	30"	36"	42"	48"	60"	72"
35"	20"	24"	30"	36"	42"	48"	60"	72"
42½"	20"	24"	30"	36"	42"	48"	60"	72"
50"	20"	24"	30"	36"	42"	48"	60"	72"
65"	20"	24"	30"	36"	42"	48"	60"	72"

Maximum Receptacle Capacity in Panel Base Pathways

Widths	20	24	30	36	42	48	60	72
Maximum of 1 duplex per panel side	N/A	X						
Maximum of 2 duplexes per panel side	N/A		X	X	X	X	X	X

The center of the duplex is always 12" from the end of the panel on all Accelerate® panels.

Design:

- Slots allow hanging worksurfaces and hang-on units, in 1" increments.
- Panels standard with two adjustable leveling glides.
- No panel creep.
- Meets or exceeds ANSI/BIFMA Standards.

Top Tier and Stacking Panels

- Available in tackable fabric as well as clear and frosted glass.
- Select from a full height panel/top tier panels or stackers.
- Stackers can be stacked up to 80"H on a base panel.
- Overheads can be placed on the first stacker only, up to 65"H. Voi overheads are not to be placed on stackers.

PANEL SPECIFICATION AND INSTALLATION NOTES

Definitions:

Parent Panel Run – Panels (or a single panel) configured in a straight line intended to divide space. It is usually longer than the panels used to stabilize it.

Return Panels – Panels attached to a parent run for the purpose of stabilizing it. Return panels may also have the effect of dividing space.

Note: Return panels must be no more than 30" lower than the maximum height of the parent panel run. When stacking, the maximum height allowed is 80". This includes frameless glass. If attaching overhead storage, return panels must be the same height as parent run.

Method 1: Opposing Returns

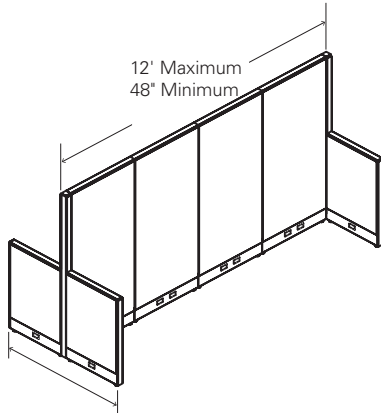

Method 2: Single-Sided

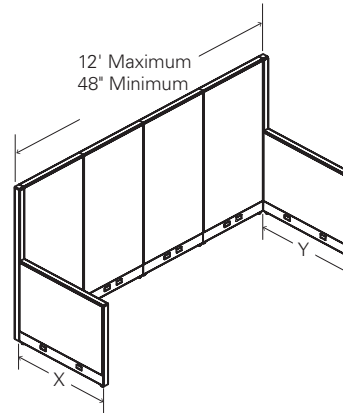

A parent panel run must be a minimum of 4 feet and a maximum of 12 feet, and must have a minimum of two return panels extended in opposing directions on each side of the parent run.

Panel Run Length	Minimum Return Panels	Minimum Return Panels with Stack-ons
48"	20"	20"
54"	20"	20"
60"	20"	20"
66"	20"	20"
72"	20"	20"
78"	20"	20"
84"	20"	20"
90"	20"	20"
96"	20"	20"
102"	20"	20"
108"	24"	24"
114"	24"	24"
120"	24"	24"
144"	24"	24"

A parent panel run must be a minimum of 4 feet and a maximum of 12 feet, and must have a minimum of two return panels (X+Y) extended in one direction (one at the beginning and at the end of the parent run) as defined below.

Panel Run Length	Minimum Return Panels Total (X+Y)	Minimum Return Panels Total (X+Y) with Stack-ons
48"	84"	84"
54"	84"	84"
60"	84"	84"
66"	84"	84"
72"	84"	84"
78"	84"	84"
84"	84"	84"
90"	84"	84"
96"	84"	84"
102"	84"	84"
108"	84"	96"
114"	84"	96"
120"	84"	96"
144"	84"	96"

ACCELERATE® CONNECTOR OVERVIEW

CONNECTOR KITS — ACCELERATE®

- TPS** In-line Connector
- PSN** Extended Straight Connector
- PLN** “L” Connector
- PTN** “T” Connector
- PXN** “X” Connector
- P2N** 120° 2-way Connector
- P3N** 120° 3-way Connector
- CV** Connector Variable Height Finishing Kit
- VH** In-line Variable Height Finishing Kit

ADDITIONAL MODELS FOR USE WITH CONNECTOR KITS

- FE** Finished End Covers
- WS** Wall Starter Kit
- WT** Wall Track

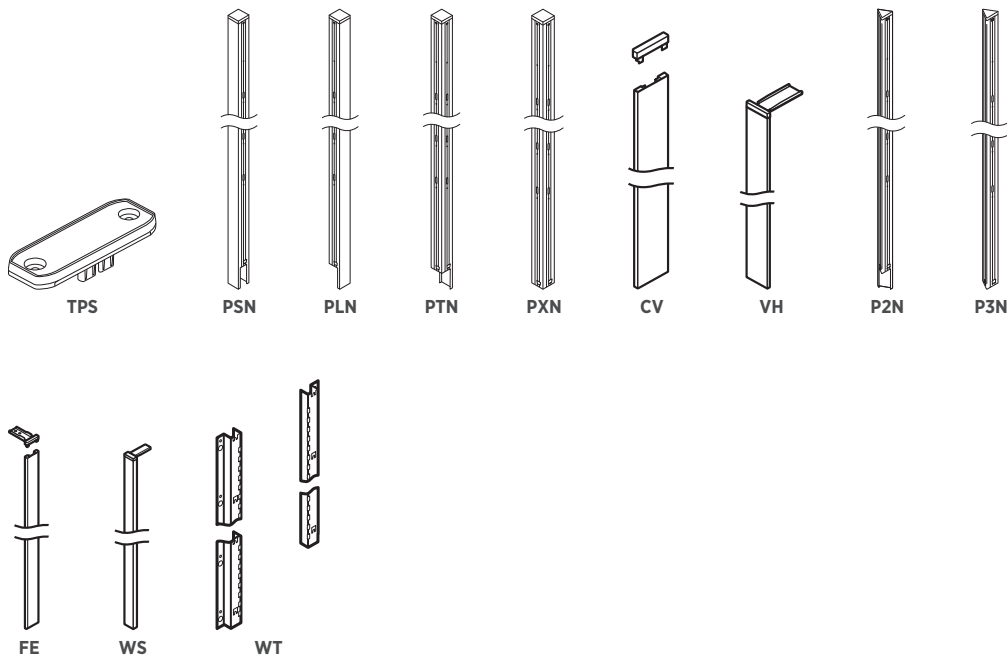

Panel-to-Panel Connector

- Attaches same height, panel-to-panel in a straight run with screws.
- Ensures alignment on panels in a straight run.

Wall Starter Kit (see page 431)

- Anchor devices are not supplied with the wall starter kit. Refer to Accelerate® Installation Instructions for appropriate hardware.
- Adds 7/8" to length of run.

ACCELERATE® Tackable Raceway Panels

GSA SIN 33721



Icon Legend on page 19

WORKSTATIONS

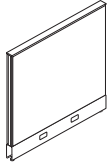

DESCRIPTION

MODEL

SHIP WEIGHT CUBE

CORE LIST PRICE BY CODE

35" H Tackable Acoustical Panels

DESCRIPTION	MODEL	SHIP WEIGHT	CUBE	AA	A	B
35"H x 20"W	HETP3520FP	13 Ⓢ	1.0	\$346	\$358	\$378
35"H x 24"W	HETP3524FP	14 Ⓢ	1.2	\$360	\$372	\$416
35"H x 30"W	HETP3530FP	16 Ⓢ	1.5	\$376	\$390	\$437
35"H x 36"W	HETP3536FP	18 Ⓢ	1.8	\$403	\$418	\$467
35"H x 42"W	HETP3542FP	20 Ⓢ	2.1	\$408	\$424	\$480
35"H x 48"W	HETP3548FP	23 Ⓢ	2.4	\$429	\$446	\$504
35"H x 60"W	HETP3560FP	27	3.0	\$467	\$486	\$554
35"H x 72"W*	HETP3572FP	33	3.6	\$653	\$673	\$750

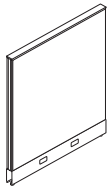

42 1/2" H Tackable Acoustical Panels

DESCRIPTION	MODEL	SHIP WEIGHT	CUBE	AA	A	B
42 1/2"H x 20"W	HETP4220FP	14 Ⓢ	1.2	\$364	\$378	\$412
42 1/2"H x 24"W	HETP4224FP Ⓢ	16 Ⓢ	1.5	\$381	\$395	\$429
42 1/2"H x 30"W	HETP4230FP Ⓢ	18 Ⓢ	1.8	\$403	\$416	\$457
42 1/2"H x 36"W	HETP4236FP Ⓢ	20 Ⓢ	2.2	\$424	\$439	\$483
42 1/2"H x 42"W	HETP4242FP	23 Ⓢ	2.6	\$460	\$477	\$528
42 1/2"H x 48"W	HETP4248FP Ⓢ	25 Ⓢ	3.0	\$478	\$497	\$559
42 1/2"H x 60"W	HETP4260FP Ⓢ	30	3.7	\$532	\$552	\$624
42 1/2"H x 72"W*	HETP4272FP	36	4.4	\$687	\$710	\$793

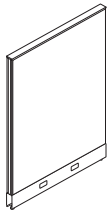

50" H Tackable Acoustical Panels

DESCRIPTION	MODEL	SHIP WEIGHT	CUBE	AA	A	B
50"H x 20"W	HETP5020FP	16 Ⓢ	1.4	\$418	\$434	\$500
50"H x 24"W	HETP5024FP Ⓢ	17 Ⓢ	1.7	\$433	\$449	\$515
50"H x 30"W	HETP5030FP Ⓢ	20 Ⓢ	2.2	\$446	\$463	\$509
50"H x 36"W	HETP5036FP Ⓢ	22 Ⓢ	2.6	\$459	\$476	\$528
50"H x 42"W	HETP5042FP	25 Ⓢ	3.0	\$515	\$534	\$595
50"H x 48"W	HETP5048FP Ⓢ	28 Ⓢ	3.5	\$545	\$566	\$634
50"H x 60"W	HETP5060FP Ⓢ	32	4.3	\$594	\$616	\$694
50"H x 72"W*	HETP5072FP	38	5.2	\$749	\$774	\$863

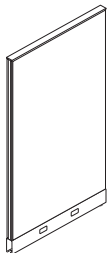

65" H Tackable Acoustical Panels

DESCRIPTION	MODEL	SHIP WEIGHT	CUBE	AA	A	B
65"H x 20"W	HETP6520FP	19 Ⓢ	1.9	\$445	\$461	\$511
65"H x 24"W	HETP6524FP Ⓢ	20 Ⓢ	2.3	\$460	\$476	\$526
65"H x 30"W	HETP6530FP Ⓢ	23 Ⓢ	2.8	\$485	\$502	\$556
65"H x 36"W	HETP6536FP Ⓢ	26 Ⓢ	3.4	\$520	\$539	\$600
65"H x 42"W	HETP6542FP	29 Ⓢ	3.9	\$566	\$586	\$654
65"H x 48"W	HETP6548FP Ⓢ	32 Ⓢ	4.5	\$590	\$611	\$688
65"H x 60"W	HETP6560FP Ⓢ	37	5.6	\$630	\$651	\$737
65"H x 72"W*	HETP6572FP	43	6.8	\$852	\$877	\$973

NOTES:

- Panels are 2 1/8" thick.
- Baserails ship standard with panels.
- Top caps ordered separately; see page 425.
- Packaging: stretch wrapped with edge protection.
- Base rail matches trim color.
- For worksurfaces that can be used with Abound® and Accelerate® systems, see pages 541-553.
- Panel end trim ordered separately; see page 431.
- Panels may be connected end to end, with wall starter kit, or with panel connectors; see pages 429-431.
- Order Accelerate® connectors separately; see page 429.
- Panels have a class A fire rating.
- Bulk packing is available in quantities of 3 or 9.
- Fabrics and finishes available on pages 413-415.

- ⓘ Raceway panels option only.
- ⓘ Do not remove electrical knockouts unless duplex is needed. For replacement covers, see page 537.
- ⓘ Accepts electrical power kits, except for 20"W. See page 535 for electrical.
- ⓘ Stack on panels add 15" of height and can be added to any monolithic panel. See stackers on pages 426-427.
- ⓘ Disperse and Analog fabrics are not available on 72"W panels.
- ⓘ If adding to existing panels produced prior to 04/13/16, please contact Customer Support for compatibility.
- ⓘ If a third cutout for data is desired, order the separate kickplate model HEBPLATE.
- ⓘ Panels should not be used in unsupported applications or take the place of permanent walls. Panels are intended to be supported with floor supports and/or storage or tied in with worksurfaces. Refer to Specifying and Design Guide pages.

HOW TO SPECIFY

Select Model Number

HETP3520FP.

Select Fabric

See pages 414-415

APN11.

Select Trim Color

See page 413

P1 Paint (no upcharge)
P2 Paint (\$32 upcharge)

S



Icon Legend on page 19

ACCELERATE® Top-Tier Glass Panels

WORKSTATIONS

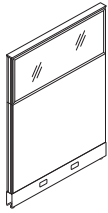

DESCRIPTION

50" H Tackable Panels — Top-Tier Glass

- 50" H x 20" W
- 50" H x 24" W
- 50" H x 30" W
- 50" H x 36" W
- 50" H x 42" W
- 50" H x 48" W
- 50" H x 60" W
- 50" H x 72" W*

MODEL	SHIP WEIGHT	CUBE	CORE LIST PRICE BY CODE		
			AA	A	B
HETP5020DP	21 Ⓢ	1.4	\$654	\$675	\$741
HETP5024DP	23 Ⓢ	1.7	\$683	\$704	\$770
HETP5030DP	27 Ⓢ	2.2	\$694	\$717	\$763
HETP5036DP	31 Ⓢ	2.6	\$709	\$732	\$785
HETP5042DP	34 Ⓢ	3.0	\$775	\$801	\$861
HETP5048DP	39 Ⓢ	3.5	\$809	\$838	\$906
HETP5060DP	46	4.3	\$871	\$903	\$981
HETP5072DP	55	5.2	\$1160	\$1195	\$1284

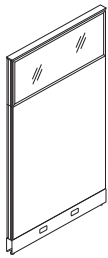

65" H Tackable Panels — Top-Tier Glass

- 65" H x 20" W
- 65" H x 24" W
- 65" H x 30" W
- 65" H x 36" W
- 65" H x 42" W
- 65" H x 48" W
- 65" H x 60" W
- 65" H x 72" W*

HETP6520DP	24 Ⓢ	1.9	\$686	\$708	\$759
HETP6524DP	27 Ⓢ	2.3	\$706	\$728	\$779
HETP6530DP	30 Ⓢ	2.8	\$730	\$753	\$807
HETP6536DP	34 Ⓢ	3.4	\$770	\$796	\$856
HETP6542DP	39 Ⓢ	3.9	\$827	\$855	\$923
HETP6548DP	43 Ⓢ	4.5	\$854	\$883	\$959
HETP6560DP	51	5.6	\$891	\$923	\$1011
HETP6572DP	60	6.8	\$1267	\$1302	\$1398

NOTES:

- On top-tier panel models, the glass tier is 15" H.
- Glass is clear or frosted, tempered safety glass.
- Panels are 2 1/8" thick.
- Panels have steel baserails.
- Packaging: stretch wrapped with edge protection.
- Base rail matches trim color.
- Top caps ordered separately; see page 425.
- For worksurfaces that can be used with Abound® and Accelerate® systems, see pages 541-553.
- Panel end trim ordered separately; see page 431.
- Panels may be connected end to end, with wall starter kit, or with panel connectors; see pages 429-431.
- Order Accelerate® connectors separately; see page 429.
- Panels have a class A fire rating.
- Bulk packing is available in quantities of 3 or 9.
- Fabrics and finishes available on pages 413-415.
- ⓘ Raceway panels option only.
- ⓘ Do not remove electrical knockouts unless duplex is needed. For replacement covers, see page 537.
- ⓘ Accepts electrical power kits, except for 20" W. See page 535 for electrical.
- ⓘ Cannot stack stacker on top-tier glass panels.
- ⓘ Disperse and Analog fabrics are not available on 72" W panels.
- ⓘ If adding to existing panels produced prior to 04/13/16, please contact Customer Support for compatibility.
- ⓘ If a third cutout for data is desired, order the separate kickplate model HEBPLATE.
- ⓘ Panels should not be used in unsupported applications or take the place of permanent walls. Panels are intended to be supported with floor supports and/or storage or tied in with worksurfaces. Refer to Specifying and Design Guide pages.

HOW TO SPECIFY

<p>Select Model Number</p> <div style="border: 1px solid black; height: 40px; margin-top: 5px;"></div>	<p>Select Fabric</p> <p>See pages 414-415</p>	<p>Select Trim Color</p> <p>See page 413</p> <p>P1 Paint (no upcharge)</p> <p>P2 Paint (\$32 upcharge)</p>	<p>Select Glass</p> <p>Q Clear Glass</p> <p>R Frosted Glass (\$32 upcharge)</p>
<div style="display: flex; justify-content: space-around; font-family: monospace; font-size: 1.2em;"> HETP5020DP </div>	<div style="display: flex; justify-content: space-around; font-family: monospace; font-size: 1.2em;"> APN11 </div>	<div style="display: flex; justify-content: space-around; font-family: monospace; font-size: 1.2em;"> S </div>	<div style="display: flex; justify-content: space-around; font-family: monospace; font-size: 1.2em;"> Q </div>

ACCELERATE® Panel Door

GSA SIN 33721



Icon Legend on page 19

WORKSTATIONS

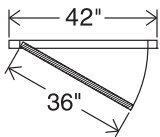
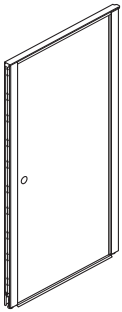

DESCRIPTION	MODEL	SHIP WEIGHT	CUBE	LIST PRICE BY PAINT GRADE	
				P1	P2

Door Panel — Laminate 42"W x 80"H	HEPDMK42P	155.0	7.3	\$2470	\$2505
---	------------------	-------	-----	---------------	---------------

NOTES: Ships with door, frame, hinges and hardware. Best placement of a door is at an L, T, X connector or wall starter connector for rigidity. Use of spanning top caps at an in-line will also help add additional rigidity.

❗ Must be used with a base panel and stacker equaling 80"H.

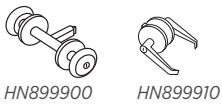

HN899900 HN899910

Standard Lock Set

Door knob (polished brass)
Door lever (brushed aluminum)

HN899900	2.0 ☹	0.1	\$152
HN899910	2.0 ☹	0.1	\$416

NOTES: Door knob and lever are both keyed on one side.



Abound® and Accelerate® Sliding Door

50"H x 42"W
65"H x 42"W
80"H x 42"W

HH15042SD	28.0	5.5	\$2711	\$2749
HH16542SD	38.0	7.1	\$3091	\$3129
HH18042SD	46.0	8.6	\$3780	\$3818

❗ Door is only available in Frosted Translucent Acrylic. Specify paint for frame.

❗ Can only install Sliding Door at the end of a run, not at a corner.

❗ A Mounting Bracket Kit must be ordered for each sliding door corresponding to the mounting panels width (30", 36", 42", or 48"W).

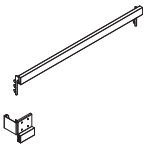

Accelerate® Mounting Kit for Sliding Door

For 30"W Panel
For 36"W Panel
For 42"W Panel
For 48"W Panel

HESDMK30	4.0	0.4	\$222	\$235
HESDMK36	5.0	0.5	\$232	\$245
HESDMK42	6.0	0.5	\$242	\$255
HESDMK48	7.0	0.5	\$254	\$267

NOTES: Specify paint.



Carpet Grippers

NOTES: Used with Glide Towers
Shipped 12 per package
No need to specify paint

HICG12	0.5 ☹	0.1	\$31
---------------	-------	-----	-------------



Coat Hooks

Package of six

HHPMC6	1.0 ☹	0.2	\$113
---------------	-------	-----	--------------

NOTES: Compatible with Accelerate® and Abound® panels.

❗ Black only.

NOTES:

- Order handle separately. See handle model options above.
- Specify top caps separately when ordering the laminate panel door; see page 425.
- Order Accelerate® connectors separately; see page 429.
- Fabrics and finishes available on pages 413-415.
- The Sliding Doors are available in 50", 65", and 80"H models and can mount to 30", 36", 42", and 48"W panels.
- All doors are 42" wide, provide a 36"W opening, and are non-handed.

HOW TO SPECIFY

Select Model Number H E P D M K 4 2 P .	Select Trim Color See page 413 T 4 .	Select Door Laminate L2 Laminate Upcharge \$63 See page 413 H
---	---	---



ACCELERATE® Top Caps

DESCRIPTION	MODEL	SHIP WEIGHT	CUBE	LIST PRICE BY PAINT GRADE	
				P1	P2
Panel Top Cap					
20"W	HETC20	1.5	0.3	\$51	\$72
24"W	HETC24	1.6	0.3	\$51	\$72
30"W	HETC30	1.8	0.3	\$61	\$82
36"W	HETC36	2.0	0.3	\$78	\$99
42"W	HETC42	2.2	0.3	\$81	\$102
48"W	HETC48	3.4	0.4	\$89	\$110
60"W	HETC60	3.9	0.6	\$111	\$132
66"W	HETC66	4.0	0.6	\$130	\$151
72"W	HETC72	5.3	0.8	\$134	\$155
78"W	HETC78	6.5	0.8	\$139	\$160
84"W	HETC84	6.7	0.9	\$153	\$174
90"W	HETC90	7.0	0.9	\$159	\$180
96"W	HETC96	7.2	0.9	\$168	\$189

NOTES:

- Models above are specified for panel models on pages 422-423.
 - Top caps ship separately from panels.
 - Top caps are able to span multiple panels for a clean aesthetic.
 - Top caps are bulk packed for ease at installation sites.
- ! If adding to existing panels produced prior to 04/13/16, please contact Customer Support for compatibility.

HOW TO SPECIFY

Select Model Number	Select Paint Color
HE T C 2 0 .	T 3

DESCRIPTION	MODEL	SHIP WEIGHT	CUBE	LIST PRICE BY PAINT GRADE	
				P1	P2
Accelerate® Base Pathway Cover w/Additional Knockout					
36"W	HEBPLATE336	7	0.4	\$97	\$108
42"W	HEBPLATE342	8	0.4	\$100	\$111
48"W	HEBPLATE348	9	0.4	\$104	\$115
60"W	HEBPLATE360	11	0.5	\$118	\$129
72"W	HEBPLATE372	14	0.6	\$131	\$142

NOTES: Specify paint, see page 413.
SPECIFYING EXAMPLE: HEBPLATE336.T4

NOTES:

- ! Specify Pathways to match trim color.
- ! Standard raceways with two knockouts are standard on panels. If additional three knockout kickplate is ordered, the two port version can be saved or discarded.

HOW TO SPECIFY

Select Model Number	Select Paint Color
HE B P L A T E 3 3 6 .	T 4

ACCELERATE® Stacking Panels

GSA SIN 33721



Icon Legend on page 19

WORKSTATIONS



DESCRIPTION	MODEL	SHIP WEIGHT	CUBE	CORE LIST PRICE BY CODE		
				AA	A	B
15”H Stacking Panels — Fabric						
15”H x 20”W	HES1520F	6	0.5	\$238	\$260	\$311
15”H x 24”W	HES1524F	7	0.6	\$262	\$284	\$335
15”H x 30”W	HES1530F	8	0.8	\$283	\$306	\$360
15”H x 36”W	HES1536F	9	0.9	\$303	\$329	\$389
15”H x 42”W	HES1542F	11	1.1	\$328	\$356	\$424
15”H x 48”W	HES1548F	12	1.2	\$348	\$377	\$453
15”H x 60”W	HES1560F	14	1.5	\$393	\$425	\$513
15”H x 72”W	HES1572F	17	1.8	\$745	\$780	\$876

NOTES:

- Stacking panels ship without top caps.
- Stackers add 15” or 30” to the height of the base panel.
- Stacker ships with pins to connect stacker to post connector for added rigidity.
- Select complete panels with top-tier glass, or add glass/fabric stackers separately to existing panels. See page 423 for complete panels information.
- Not to be used freestanding.
- Stackers can be stacked up to 80”H on a base panel or 30” of stacker height total, whichever comes first.
- The first stacker on a base panel is weight bearing and can accommodate overhead storage up to 65”H.
- Stacking model must match the width of the panel it is stacking on.
- Total panel height cannot exceed 80” high. Glass stacker must be the top tier. A stacking panel cannot be placed above a glass panel or glass stacker. Frameless Glass can be installed on a fabric stacker.
- Voi overheads not to be placed on stackers.
- If adding to existing panels produced prior to 04/13/16, please contact Customer Support for compatibility.

HOW TO SPECIFY

Select Model Number	Select Fabric Color
	See pages 414-415
HES1520F.	APN11

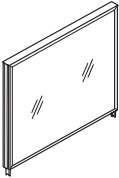
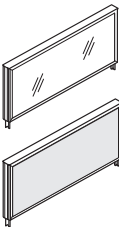

ACCELERATE® Stacking Panels

DESCRIPTION	MODEL	SHIP WEIGHT	CUBE	CLEAR GLASS	FROSTED GLASS
 <p>30”H Stacking Panels — Glass 30”H x 20”W 30”H x 24”W 30”H x 30”W 30”H x 36”W 30”H x 42”W 30”H x 48”W 30”H x 60”W</p>	HES3020G	14 Ⓔ	1.0	\$770	\$802
	HES3024G	17 Ⓔ	1.2	\$810	\$842
	HES3030G	20 Ⓔ	1.5	\$918	\$950
	HES3036G	23 Ⓔ	1.8	\$949	\$981
	HES3042G	26 Ⓔ	2.1	\$1050	\$1082
	HES3048G	29 Ⓔ	2.4	\$1130	\$1162
	HES3060G	36	3.0	\$1295	\$1327
NOTES: 30”H stacker ships with pins to connect stacker to post connector for added rigidity.					
 <p>15”H Stacking Panels — Glass 15”H x 20”W 15”H x 24”W 15”H x 30”W 15”H x 36”W 15”H x 42”W 15”H x 48”W 15”H x 60”W 15”H x 72”W</p>	HES1520G	8 Ⓔ	0.5	\$515	\$547
	HES1524G Ⓢ	9 Ⓔ	0.6	\$545	\$577
	HES1530G Ⓢ	11 Ⓔ	0.8	\$614	\$646
	HES1536G Ⓢ	12 Ⓔ	0.9	\$636	\$668
	HES1542G	14 Ⓔ	1.1	\$702	\$734
	HES1548G Ⓢ	16 Ⓔ	1.2	\$756	\$788
	HES1560G Ⓢ	19 Ⓔ	1.5	\$864	\$896
	HES1572G	22	1.8	\$1052	\$1084

NOTES:

- Stacking panels ship without top caps.
- Stackers add 15” or 30” to the height of the base panel.
- Stacker ships with pins to connect stacker to post connector for added rigidity.
- Select complete panels with top-tier glass, or add glass/fabric stackers separately to existing panels. See page 423 for complete panels information.
- Ⓢ** Not to be used freestanding.
- Ⓢ** Stackers can be stacked up to 80”H on a base panel or 30” of stacker height total, whichever comes first.
- Ⓢ** The first stacker on a base panel is weight bearing and can accommodate overhead storage up to 65”H.
- Ⓢ** Stacking model must match the width of the panel it is stacking on.
- Ⓢ** Total panel height cannot exceed 80” high. Glass stacker must be the top tier. A stacking panel cannot be placed above a glass panel or glass stacker. Frameless Glass can be installed on a fabric stacker.
- Ⓢ** If adding to existing panels produced prior to 04/13/16, please contact Customer Support for compatibility.

HOW TO SPECIFY

<p>Select Model Number</p> <p>HES3020G</p>	<p>Select Paint Color</p> <p>See page 413 P1 Paint (no upcharge) P2 Paint (\$32 upcharge)</p> <p>T1</p>	<p>Select Glass</p> <p>Q Clear Glass R Frosted Glass</p> <p>Q</p>
---	--	---

ACCELERATE® Frameless Glass

GSA SIN 33721



Icon Legend on page 19

WORKSTATIONS

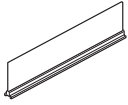

DESCRIPTION	MODEL	SHIP WEIGHT	CUBE	CLEAR GLASS	FROSTED GLASS
Frameless Glass Stacker					
7½"H x 20"W	HEFGS0720	17	0.7	\$405	\$437
7½"H x 24"W	HEFGS0724	18	0.8	\$478	\$517
7½"H x 30"W	HEFGS0730	18	1.0	\$515	\$558
7½"H x 36"W	HEFGS0736	21	1.2	\$591	\$641
7½"H x 42"W	HEFGS0742	25	1.5	\$631	\$684
7½"H x 48"W	HEFGS0748	28	1.5	\$678	\$735
7½"H x 54"W	HEFGS0754	28	1.7	\$764	\$828
7½"H x 60"W	HEFGS0760	35	1.8	\$830	\$899
7½"H x 66"W	HEFGS0766	35	2.0	\$924	\$1000
7½"H x 72"W	HEFGS0772	42	2.2	\$981	\$1063

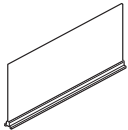

Frameless Glass Stacker					
15"H x 20"W	HEFGS1520	27	1.2	\$501	\$533
15"H x 24"W	HEFGS1524	28	1.4	\$544	\$583
15"H x 30"W	HEFGS1530	28	1.7	\$580	\$623
15"H x 36"W	HEFGS1536	34	2.0	\$666	\$716
15"H x 42"W	HEFGS1542	39	2.3	\$714	\$767
15"H x 48"W	HEFGS1548	45	2.6	\$770	\$827
15"H x 54"W	HEFGS1554	51	2.7	\$842	\$906
15"H x 60"W	HEFGS1560	57	3.0	\$939	\$1008
15"H x 66"W	HEFGS1566	62	3.3	\$1026	\$1102
15"H x 72"W	HEFGS1572	67	3.6	\$1106	\$1188



DESCRIPTION	MODEL	SHIP WEIGHT	CUBE	LIST PRICE BY PAINT GRADE	
				P1	P2
Frameless Glass Finishing Kit					
7½"H	HEVHG07P	2	0.2	\$71	\$81
15"H	HEVHG15P	2	0.4	\$77	\$87
22½"H	HEVHG22P	3	0.4	\$83	\$93
30"H	HEVHG30P	3	0.4	\$99	\$109

NOTES: Specify paint, see page 413.
SPECIFYING EXAMPLE: HEVHG15P.PJW

NOTES:

- Glass is a single-pane, 3/8" laminated safety glass.
- Available in clear or frosted glass.
- Frameless Glass can span multiple panels with one piece of glass.
- Lamination is in the center of the glass, making both clear and frosted glass a writable surface with dry-erase markers.
- ⚠ Glass tiles have a Class A fire rating.
- ❗ Frameless Glass cannot be used on top of glass stackers or headers.
- ❗ Frameless Glass can only be used on the top of panels. Glass integrates into top cap trim. Do not order a separate top cap model for your frame when using Frameless Glass.
- ❗ Cannot hang or stack on top of Frameless Glass.
- ❗ If adding to existing panels produced prior to July 2021, please contact Customer Support for compatibility.

HOW TO SPECIFY

Select Model Number H E F G S 1 5 2 0 .	Select Paint Color See page 413 P1 Paint (no upcharge) P2 Paint (\$18 upcharge) T 1 .	Select Glass Option Q Clear Glass R Frosted Glass Q
---	--	---



Icon Legend on page 19

ACCELERATE® Strengthened Connection Posts

WORKSTATIONS

	DESCRIPTION	MODEL	SHIP		LIST PRICE BY PAINT GRADE		
			WEIGHT	CUBE	P1	P2	P3
	120° 2-Way Connector Posts						
	For 35"H Panels	HEC35P2N	6	0.5	\$116	\$126	\$144
	For 42½"H Panels	HEC42P2N	6	0.5	\$139	\$149	\$167
	For 50"H Panels	HEC50P2N	7	0.6	\$161	\$171	\$189
	For 57½"H Panels	HEC57P2N	8	0.8	\$174	\$184	\$202
	For 65"H Panels	HEC65P2N	8	0.8	\$182	\$192	\$210
	For 72½"H Panels	HEC72P2N	9	0.9	\$192	\$202	\$220
	For 80"H Panels	HEC80P2N	9	0.9	\$201	\$211	\$229
	120° 3-Way Connector Posts						
	For 35"H Panels	HEC35P3N	6	0.5	\$111	\$121	\$139
	For 42½"H Panels	HEC42P3N	6	0.5	\$132	\$142	\$160
	For 50"H Panels	HEC50P3N	7	0.6	\$156	\$166	\$184
	For 57½"H Panels	HEC57P3N	8	0.8	\$166	\$176	\$194
	For 65"H Panels	HEC65P3N	8	0.8	\$175	\$185	\$203
	For 72½"H Panels	HEC72P3N	9	0.9	\$185	\$195	\$213
	For 80"H Panels	HEC80P3N	9	0.9	\$194	\$204	\$222
	Extended Straight Connector Posts						
	For 35"H Panels	HEC35PSN	6	0.5	\$116	\$126	\$144
	For 42½"H Panels	HEC42PSN	6	0.5	\$139	\$149	\$167
	For 50"H Panels	HEC50PSN	7	0.6	\$161	\$171	\$189
	For 57½"H Panels	HEC57PSN	8	0.8	\$174	\$184	\$202
	For 65"H Panels	HEC65PSN	8	0.8	\$182	\$192	\$210
	For 72½"H Panels	HEC72PSN	9	0.9	\$194	\$204	\$222
	For 80"H Panels	HEC80PSN	9	0.9	\$201	\$211	\$229
	"L" Connector Posts						
	For 35"H Panels	HEC35PLN	6	0.5	\$122	\$132	\$150
	For 42½"H Panels	HEC42PLN ☉	6	0.5	\$148	\$158	\$176
	For 50"H Panels	HEC50PLN ☉	7	0.6	\$169	\$179	\$197
	For 57½"H Panels	HEC57PLN ☉	8	0.8	\$181	\$191	\$209
	For 65"H Panels	HEC65PLN ☉	8	0.8	\$189	\$199	\$217
	For 72½"H Panels	HEC72PLN	9	0.9	\$198	\$208	\$226
	For 80"H Panels	HEC80PLN ☉	9	0.9	\$208	\$218	\$236
	"T" Connector Posts						
	For 35"H Panels	HEC35PTN	6	0.5	\$116	\$126	\$144
	For 42½"H Panels	HEC42PTN ☉	6	0.5	\$139	\$149	\$167
	For 50"H Panels	HEC50PTN ☉	7	0.6	\$161	\$171	\$189
	For 57½"H Panels	HEC57PTN ☉	8	0.8	\$174	\$184	\$202
	For 65"H Panels	HEC65PTN ☉	8	0.8	\$182	\$192	\$210
	For 72½"H Panels	HEC72PTN	9	0.9	\$192	\$202	\$220
	For 80"H Panels	HEC80PTN ☉	9	0.9	\$201	\$211	\$229
	"X" Connector Posts						
	For 35"H Panels	HEC35PXN	6	0.5	\$111	\$121	\$139
	For 42½"H Panels	HEC42PXN ☉	6	0.5	\$132	\$142	\$160
	For 50"H Panels	HEC50PXN ☉	7	0.6	\$156	\$166	\$184
	For 57½"H Panels	HEC57PXN ☉	8	0.8	\$166	\$176	\$194
	For 65"H Panels	HEC65PXN ☉	8	0.8	\$175	\$185	\$203
	For 72½"H Panels	HEC72PXN	9	0.9	\$185	\$195	\$213
	For 80"H Panels	HEC80PXN ☉	9	0.9	\$194	\$204	\$222

NOTES:

- Specify connectors based on number and placement of panels.
- Connector posts are specified separately from connector straps — specify post to tallest panel and straps based on connection (see variable height example on straps page).
- Specify connector to fit height of tallest panel.
- Connectors are made of extruded aluminum.
- Straight Connector model HSCKTPS ships standard in bulk pack.
- Connector posts where power pole will enter need to be specified with single connector straps, model HECS1.

☉ In-line connector must be specified for all in-line connections.

☉ If adding to existing panels produced prior to 04/13/2016, please contact Customer Support for compatibility.

HOW TO SPECIFY

<p>Select Model Number</p> <p>HEC35P2N</p>	<p>Select Paint Color</p> <p>See page 413</p> <p>T3</p>
--	---

	DESCRIPTION	MODEL	SHIP WEIGHT	CUBE	LIST PRICE
	120° 2-Way Connector Strap	HECSV	1.4	0.2	\$30
	120° 3-Way Connector Strap	HECSY	2.2	0.2	\$35
	Extended Straight Connector Strap	HECSS	1.6	0.2	\$30
	"L" Connector Strap	HECSL	1.5	0.2	\$21
	"T" Connector Strap	HECST	2.3	0.2	\$30
	"X" Connector Strap	HECSX	3.0	0.2	\$35
	Single Connector Strap NOTES: Use this connector bracket when installing a power pole to a connector.	HECSI	1.9	0.2	\$21
	In-line Connector NOTES: No need to specify finish. SPECIFYING EXAMPLE: HSCKTPS.X	HSCKTPS	0.5	0.1	\$28

NOTES:

- Strengthened Connection Straps provide more rigidity to panel connections, especially when not tied into a station with a worksurface or storage, i.e., when Coordinate™ Height Adjustable bases are used or when using panels strictly to divide space without tying in other components.
- Connector strap type should be specified based on the tallest panel connection type. Connector straps and posts are specified separately.
- Lower height panels will connect with variable height trim.
- See examples below.
- Connector straps can be retrofitted on any existing Accelerate® stations that were produced from April 2016 to present.
- Will fit on existing connector posts — only straps would need to be specified.
- Single Straps (HECSI) are used when power poles enter at the connector post and in variable height applications where the tallest panel is a single and one or more panels is lower.

Connector Post



New Connector Straps

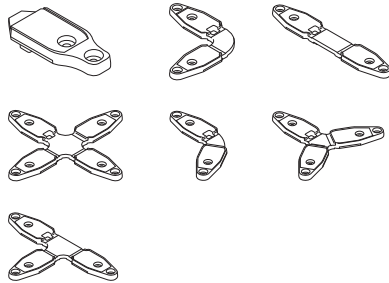

"T" 2 High, "L" 1 Low

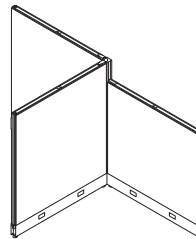

- 1 — "T" Connector Post
- 1 — VH Post Trim
- 3 — Top Caps
- 3 — End Caps
- 1 — "L" Connector Strap

"T" 1 High, "L" 2 Low

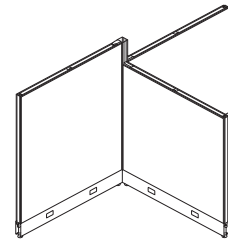

- 1 — "T" Connector Post
- 2 — VH Post Trim
- 3 — Top Caps
- 3 — End Caps
- 1 — Single Connector Strap

HOW TO SPECIFY

Select Model Number



Variable Height Finished End and Wall Starter Kits



DESCRIPTION	MODEL	SHIP WEIGHT	CUBE	LIST PRICE BY PAINT GRADE	
				P1	P2
Finished End Covers					
35"H	HEFEC35P	3	0.4	\$67	\$77
42½"H	HEFEC42P	3	0.5	\$72	\$82
50"H	HEFEC50P	4	0.6	\$78	\$88
57½"H	HEFEC57P	5	0.6	\$81	\$91
65"H	HEFEC65P	5	0.7	\$86	\$96
72½"H	HEFEC72P	6	0.8	\$92	\$102
80"H	HEFEC80P	6	0.9	\$96	\$106

NOTES: Finished End Covers include top bracket, end trim clips and end trim.



DESCRIPTION	MODEL	SHIP WEIGHT	CUBE	LIST PRICE BY PAINT GRADE	
				P1	P2
In-line Variable Height Finishing Kit					
7½"H	HEVHF07P	2	0.2	\$71	\$81
15"H	HEVHF15P	2	0.4	\$77	\$87
22½"H	HEVHF22P	3	0.4	\$88	\$98
30"H	HEVHF30P	3	0.4	\$104	\$114

NOTES: In-line Variable Height Finishing Kits include top and bottom bracket, end trim clips and end trim. In-line Variable Height Finishing Kit is used to connect a finished in-line panel connection.



DESCRIPTION	MODEL	SHIP WEIGHT	CUBE	LIST PRICE BY PAINT GRADE	
				P1	P2
Connector Variable Height Finishing Kit					
7½"H	HECVH07P	2	0.2	\$71	\$81
15"H	HECVH15P	2	0.4	\$77	\$87
22½"H	HECVH22P	3	0.4	\$88	\$98
30"H	HECVH30P	3	0.4	\$104	\$114

NOTES: Connector Variable Height Finishing Kits include top and bottom bracket, end trim and end trim connection piece.



DESCRIPTION	MODEL	SHIP WEIGHT	CUBE	LIST PRICE BY PAINT GRADE	
				P1	P2
Wall Starter Kit					
35"H	HEWS35P	4	0.4	\$113	\$123
42½"H	HEWS42P	4	0.5	\$119	\$129
50"H	HEWS50P	5	0.6	\$124	\$134
57½"H	HEWS57P	6	0.6	\$131	\$141
65"H	HEWS65P	6	0.7	\$139	\$149
72½"H	HEWS72P	7	0.8	\$150	\$160
80"H	HEWS80P	7	0.9	\$156	\$166

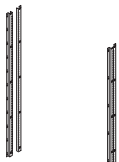

DESCRIPTION	MODEL	SHIP WEIGHT	CUBE	LIST PRICE BY PAINT GRADE	
				P1	P2
Permanent Wall Hanger Kit					
66"H LH/RH End Pair (2 Pieces)	HRVC35PCE	6	0.7	\$293	\$314
66"H Shared Mid	HRVC35PCM	3	0.7	\$155	\$166

Anchor devices are not supplied with this model. Refer to Abound® Installation instructions for appropriate hardware. Attachment to masonry walls is not recommended.

Specify paint

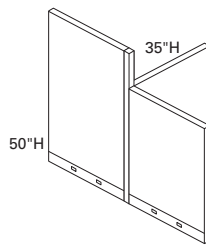

T-Connection Connector, Variable Height Finishing Kit

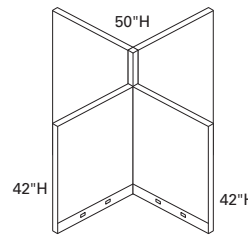

X-Connection Connector, Variable Height Finishing Kit

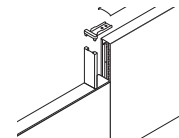

In-line Variable Height Trim Kit

NOTES:

- In-line Variable Height Finishing Kit is used to connect a finished in-line panel connection.
- Connector variable height finishing kit is used at a drop in height at an L, T, X, or S connection.
- All kits come with all hardware needed to install the kit.
- Variable height kit needs to be specified any time a change of panel height occurs.
- Finished end covers must be specified at all end of panel runs.
- If adding to existing panels produced prior to 04/13/16, please contact Customer Support for compatibility.

HOW TO SPECIFY

<p>Select Model Number</p> <p>HEFEC35P</p>	<p>Select Paint Color</p> <p>See page 413</p> <p>T3</p>
--	---

ACCELERATE® Bracket Kits and Stability Feet

GSA SIN 33721



Icon Legend on page 19

WORKSTATIONS



DESCRIPTION

Accelerate® Anchor Bracket
Package of ten

NOTES: For use when panels need to be anchored to the floor such as high traffic areas or community spaces.

⚠ Only available in Black (P).

SPECIFYING EXAMPLE: HEABAC.P

MODEL SHIP WEIGHT CUBE LIST PRICE

HEABAC 5 0.08 \$112

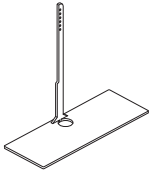

DESCRIPTION

Accelerate® Stability Foot

NOTES: Stabilizes bottom of panel from movement. Will not prohibit movement at top of panel.

MODEL SHIP WEIGHT CUBE LIST PRICE BY PAINT GRADE
P1 P2

HEFTAC 3 0.1 \$481 \$492

NOTES:

- ⚠ The Anchor Bracket and Stability Foot are not intended to create a freestanding panel. Please follow Accelerate® stability standards.
- ⚠ Attachment hardware for floor anchor not included.

HOW TO SPECIFY

<p>Select Model Number</p> <p>HEFTAC .</p>	<p>Select Paint Color</p> <p>See page 413</p> <p>T1</p>
---	--



Empower® shown with
Nucleus® Seating.

EMPOWER®

Need a simple way to get up and running fast? No problem. Looking to expand and customize workstations for a growing business? Empower does that, too. With Empower benching, you've got the power to do more. Offer more personal space. Enjoy more adaptability. Route power more efficiently. It's simple to order, easy to install and quick to reconfigure. When you Empower your people, you keep pace with the changing demands of today's workplace.



FEATURES

- With numerous laminate selections to choose from, it's easy to get the exact look you want.
- Integrated height adjustability supports the work style of any user.
- Frosted glass. Colorful fabrics. Magnetic metal. Empower® Universal Screens add style, privacy, and functionality.
- Choose from multiple paint finishes to blend in or stand out.
- As the main electrical artery, power and data cables are laid into the trough.
- Plug power modules into the duplex in the trough and attach them to the worksurface for easy access to electrical and USB ports.
- Power entry can be accommodated through the ceiling, floor, or wall.
- Keep cords collected and controlled from floor to wire trough with vertebra.
- Support any work style by adding HON pedestals, credenzas and storage towers to Empower benching.

EMPOWER® FINISH OPTIONS

STATIC LEGS AND TROUGHS

PAINTS	CODES
P1	
◆ Black	P
◆ Brownstone	P7D
◆ Charcoal	S
◆ Cove	P096
◆ Designer White	PJW
◆ Dune	P094
◆ Fossil	P28
◆ Greige	T5
◆ Harbor	P097
◆ Light Gray	Q
◆ Loft	LOFT
◆ Muslin	T3
◆ Putty	L
◆ Sage	P095
◆ Titanium	P8T
P2	
◆ Champagne Metallic	T4
◆ Gunmetal Metallic	PR3
◆ Platinum Metallic	T1
◆ Silver	PR6
◆ Solar Black	P8X
P3	
◆ Atom	P8S
◆ Bullseye	PJF
◆ Ember	P8P
◆ Ion	P8N
◆ Iris	P8J
◆ Krypton	P8F
◆ Regatta	P8M

HEIGHT ADJUSTABLE LEGS

PAINTS	CODES
P1	
◆ Black	P71
◆ Charcoal	S
◆ Designer White	PJW
◆ Loft	LOFT
◆ Silver	PR6

WORKSURFACES

L1 LAMINATES CODES

Woodgrain	
◆ Bourbon Cherry	H
◆ Cognac	COGN
◆ Field Elm	LWFE
◆ Florence Walnut	LFW1
◆ Harvest	C
◆ Kingswood Walnut	LK11
◆ Mahogany	N
◆ Mocha	MOCH
◆ Natural Maple	D
◆ Pinnacle	PINC
◆ Shaker Cherry	F
◆ Sterling Ash	LSA1

Solid	
◆ Black	P
◆ Charcoal	S
◆ Designer White	LDW1
◆ Loft	LOFT

Patterned	
◆ Handspun Chestnut	LAHC
◆ Handspun Dove	LAHD
◆ Handspun Pearl	LAHP
◆ Handspun Slate	LAHS
◆ Silver Mesh	B9
◆ Steel Mesh	A9
◆ Gray	G2
◆ White	G1

◆◆◆ For lead time information see page 21.

WORKSURFACES *continued*

L2 LAMINATES CODES

Woodgrain	
◆ Beigewood	LWBE
◆ Fawn Cypress	LFC1
◆ Lowell Ash	LLA1
◆ Natural Recon	LNRI
◆ Phantom Ecru	LPE1
◆ Portico Teak	LPT1
◆ Skyline Walnut	LSW1

WORKSURFACE EDGE BAND

Woodgrain	
◆ Beigewood	DE
◆ Bourbon Cherry	H
◆ Cognac	COGN
◆ Fawn Cypress	FC
◆ Field Elm	FE
◆ Florence Walnut	FW
◆ Harvest	C
◆ Kingswood Walnut	KI
◆ Lowell Ash	DL
◆ Mahogany	N
◆ Mocha	MOCH
◆ Natural Maple	D
◆ Natural Recon	NR
◆ Phantom Ecru	PE
◆ Pinnacle	PINC
◆ Portico Teak	DP
◆ Shaker Cherry	F
◆ Skyline Walnut	SW
◆ Sterling Ash	SA

Solid	
◆ Black	P
◆ Brownstone	EY
◆ Charcoal	S
◆ Designer White	DW
◆ Fossil	EH
◆ Greige	R
◆ Loft	LOFT
◆ Muslin	T
◆ Platinum	K

END OF RUN SCREENS

L1 LAMINATES CODES

Woodgrain	
◆ Bourbon Cherry	H
◆ Cognac	COGN
◆ Field Elm	LWFE
◆ Florence Walnut	LFW1
◆ Harvest	C
◆ Kingswood Walnut	LK11
◆ Mahogany	N
◆ Mocha	MOCH
◆ Natural Maple	D
◆ Pinnacle	PINC
◆ Shaker Cherry	F
◆ Sterling Ash	LSA1

Solid	
◆ Black	P
◆ Charcoal	S
◆ Designer White	LDW1
◆ Loft	LOFT

Patterned	
◆ Silver Mesh	B9

L2 LAMINATES CODES

Woodgrain	
◆ Beigewood	LWBE
◆ Fawn Cypress	LFC1
◆ Lowell Ash	LLA1
◆ Natural Recon	LNRI
◆ Phantom Ecru	LPE1
◆ Portico Teak	LPT1
◆ Skyline Walnut	LSW1

POWER POLE

PAINTS CODES

P1	
◆ Black	P
◆ Charcoal	S
◆ Cove	P096
◆ Designer White	PJW
◆ Dune	P094
◆ Greige	T5
◆ Harbor	P097
◆ Light Gray	Q
◆ Loft	LOFT
◆ Muslin	T3
◆ Sage	P095

PAINTED METAL SCREENS AND SCREEN BRACKETS

PAINTS CODES

P1	
◆ Black	P
◆ Brownstone	P7D
◆ Charcoal	S
◆ Cove	P096
◆ Designer White	PJW
◆ Dune	P094
◆ Fossil	P28
◆ Greige	T5
◆ Harbor	P097
◆ Light Gray	Q
◆ Loft	LOFT
◆ Muslin	T3
◆ Putty	L
◆ Sage	P095
◆ Titanium	P8T

P2	
◆ Champagne Metallic	T4
◆ Gunmetal Metallic	PR3
◆ Platinum Metallic	T1
◆ Silver	PR6
◆ Solar Black	P8X
◆ White Markerboard	MKB

P3	
◆ Atom	P8S
◆ Bullseye	PJF
◆ Ember	P8P
◆ Ion	P8N
◆ Iris	P8J
◆ Krypton	P8F
◆ Regatta	P8M

Recommended Color to use with Duplex and Data Electric Kits

Paint	Duplex-Data Code
Black P	Black P
Brownstone P7D	Brownstone EY
Charcoal S	Charcoal S
Designer White PJW	Designer White DW
Fossil P28	Charcoal S
Greige T5	Muslin T3
Light Gray Q	Loft LOFT
Loft LOFT	Loft LOFT
Muslin T3	Muslin T3
Putty L	Black P
Silver PR6	Titanium T1
Titanium P8T	Titanium T1
Champagne Metallic T4	Muslin T3
Platinum Metallic T1	Titanium T1

WORKSURFACE LAMINATES	CODES	EDGE BAND OPTIONS										
		Matching Edge	Designer White (DW)	Loft (LOFT)	Muslin (T)	Black (P)	Brownstone (EY)	Charcoal (S)	Fossil (EH)	Greige (R)	Light Gray (Q)	Platinum (K)
Beigewood	LWBE	*	*	*	*	*	*	*	*	*	*	*
Black	P	*				*						
Bourbon Cherry	H	*	*	*	*	*	*	*	*	*	*	*
Charcoal	S	*	*	*	*	*	*	*	*	*	*	*
Cognac	COGN	*	*	*	*	*	*	*	*	*	*	*
Designer White	LDW1	*	*	*	*	*	*	*	*	*	*	*
Fawn Cypress	LFC1	*	*	*	*	*	*	*	*	*	*	*
Field Elm	LWFE	*	*	*	*	*	*	*	*	*	*	*
Handspun Chestnut	LAHC	*	*	*	*	*	*	*	*	*	*	*
Handspun Dove	LAHD	*	*	*	*	*	*	*	*	*	*	*
Handspun Pearl	LAHP	*	*	*	*	*	*	*	*	*	*	*
Handspun Slate	LAHS	*	*	*	*	*	*	*	*	*	*	*
Harvest	C	*	*	*	*	*	*	*	*	*	*	*
Loft	LOFT	*	*	*	*	*	*	*	*	*	*	*
Lowell Ash	LLA1	*	*	*	*	*	*	*	*	*	*	*
Mahogany	N	*	*	*	*	*	*	*	*	*	*	*
Mocha	MOCH	*	*	*	*	*	*	*	*	*	*	*
Natural Maple	D	*	*	*	*	*	*	*	*	*	*	*
Natural Recon	LNRI	*	*	*	*	*	*	*	*	*	*	*
Phantom Ecru	LPE1	*	*	*	*	*	*	*	*	*	*	*
Pinnacle	PINC	*	*	*	*	*	*	*	*	*	*	*
Portico Teak	LPT1	*	*	*	*	*	*	*	*	*	*	*
Shaker Cherry	F	*	*	*	*	*	*	*	*	*	*	*
Silver Mesh	B9	*	*	*	*	*	*	*	*	*	*	*
Skyline Walnut	LSW1	*	*	*	*	*	*	*	*	*	*	*
Sterling Ash	LSA1	*	*	*	*	*	*	*	*	*	*	*

EMPOWER[®] FABRIC SCREENS — ALL PANEL MODELS

PRICE CODE AA

FACTOR	FACT
◇ Bark *	FACT20
◇ Barley *	FACT15
◇ Cascade *	FACT25
◇ Feather *	FACT30

PRICE CODE A

APPOINT	APN
◇ Artichoke	APN11
◇ Blackberry	APN32
◇ Bronze	APN22
◇ Carbon	APN28
◇ Chai	APN12
◇ Cherry	APN30
◇ Dark Pewter	APN17
◇ Dune	APN15
◇ Espresso	APN23
◇ Framboise	APN31
◇ Frost	APN34
◇ Jet	APN27
◇ Lawn	APN25
◇ Mandarin	APN29
◇ Morel	APN09
◇ Nimbus	APN16
◇ Platinum	APN24
◇ Turquoise	APN26

CENTURION CU

◇ Apricot	CU47
◇ Bark	CU25
◇ Black	CU10
◇ Espresso	CU49
◇ Fog	CU03
◇ Frost	CU22
◇ Goldenrod	CU27
◇ Indigo	CU06
◇ Iris	CU50
◇ Iron Ore	CU19
◇ Jade	CU83
◇ Marsala	CU63
◇ Morel	CU24
◇ Navy	CU98
◇ Peacock	CU97
◇ Pear	CU84
◇ Ruby	CU67
◇ Sapphire	CU09

ETCH* ECH

◇ Axis	ECH13
◇ Blend	ECH14
◇ Cast	ECH12
◇ Highlight	ECH10
◇ Midtone	ECH11
◇ Outline	ECH08
◇ Shade	ECH09
◇ Tonal	ECH16
◇ Vanish	ECH15

PRICE CODE A *continued*

LANDSCAPE*	LN
◇ Azure	LN55
◇ Cornsilk	LN15
◇ Drift	LN05
◇ Khaki	LN20
◇ Sheen	LN10
◇ Slate	LN35
◇ Umber	LN25
◇ Urban	LN30

LUCY* LC

◇ Aspen	LC32
◇ Cornsilk	LC30
◇ Dusk	LC22
◇ Fawn	LC33
◇ Graphite	LC34
◇ Mist	LC20
◇ Neutra	LC24
◇ Pewter	LC35
◇ Snowdrop	LC28

PRICE CODE A *continued*

NOBLE	NBLE
◇ Aegean	NBLE18
◇ Amethyst	NBLE19
◇ Aspen	NBLE14
◇ Aster	NBLE20
◇ Blossom	NBLE21
◇ Bluebell	NBLE22
◇ Bordeaux	NBLE01
◇ Brick	NBLE02
◇ Chambray	NBLE10
◇ Chamomile	NBLE23
◇ Clementine	NBLE04
◇ Conifer	NBLE24
◇ Cottage	NBLE25
◇ Darkness	NBLE26
◇ Dawn	NBLE13
◇ Denim	NBLE09
◇ Desert Sand	NBLE27
◇ Dewfall	NBLE28
◇ Dusted Sage	NBLE29
◇ Flax	NBLE30
◇ Grass	NBLE07
◇ Gunmetal	NBLE15
◇ Harmony	NBLE31
◇ Harvest	NBLE12
◇ Ice Caves	NBLE32
◇ Icicle	NBLE33
◇ Inky	NBLE34
◇ Iris	NBLE35
◇ Jade	NBLE06
◇ Knight	NBLE17
◇ Mesa	NBLE03
◇ Monarch	NBLE36
◇ Pacific	NBLE08
◇ Pitch	NBLE37
◇ Queen Bee	NBLE38
◇ Rainforest	NBLE05
◇ Regal	NBLE11
◇ Sandcastle	NBLE39
◇ Sedona	NBLE40
◇ Stormy	NBLE16
◇ Sunbeam	NBLE41
◇ Voyager	NBLE42
◇ Windy Day	NBLE43

REFLECTIONS* REF

◇ Galvanized	REF29
◇ Ice	REF20
◇ Loggia	REF21
◇ Mistral	REF28
◇ Moonstone	REF23
◇ Pewter	REF22
◇ Stainless	REF24
◇ Vanilla	REF25
◇ Winter	REF27

NOTES: Analog and Disperse panel fabrics will be applied pattern cut. Disperse will not be available on 72"W panels. Analog is not available on sizes wider than 60".

◆◆◆ For lead time information see page 21.

* Directional fabrics

* Fabric is de-emphasized.

EMPOWER® FABRIC SCREENS — ALL PANEL MODELS

PRICE CODE A *continued*

REFUGE*	RFG
◆ Artesian	RFG96
◆ Dune	RFG92
◆ Eclipse	RFG90
◆ Frost	RFG93
◆ Glacier	RFG91
◆ Mineral	RFG98
◆ Tidal	RFG94

TEMPEST* **TP**

◆ Dragonfly	TP30
◆ Frost	TP15
◆ Full Stream	TP80
◆ Gold Rush	TP10
◆ Slate	TP45
◆ Tumbleweed	TP70
◆ Wind Chill	TP40
◆ Zebra	TP35

PRICE CODE B

ANALOG*	ANLG
◆ Album*	ANLG06
◆ Cartridge*	ANLG04
◆ Cassette*	ANLG09
◆ Dial*	ANLG02
◆ Media*	ANLG08
◆ Reel*	ANLG07
◆ Signal*	ANLG03
◆ Stereo*	ANLG01
◆ Track*	ANLG05

COAST* **COA**

◆ Channel	COA14
◆ Dune	COA03
◆ Headlands	COA10
◆ Marsh	COA02
◆ Pebble	COA12
◆ Pier	COA13
◆ Shoal	COA01
◆ Silt	COA06
◆ Tide	COA08

PRICE CODE B *continued*

DISPERSE*	DISP
◆ Autumn	DISP03
◆ Branch	DISP10
◆ Coffee Bean	DISP13
◆ Dusk	DISP09
◆ Emerald City	DISP08
◆ Gold Rush	DISP02
◆ Igloo	DISP11
◆ Ink	DISP06
◆ Mist	DISP12
◆ Oatmeal	DISP15
◆ Prince	DISP07
◆ Reservoir	DISP01
◆ Rose	DISP04
◆ Spring	DISP05
◆ Steel	DISP16
◆ Taupe	DISP14

MICA* **MCA**

◆ Anthracite	MCA11
◆ Breeze	MCA18
◆ Bronze	MCA13
◆ Buff	MCA14
◆ Cremini	MCA17
◆ Crystal	MCAWIT
◆ Dew	MCA20
◆ Dove	MCA12
◆ Fresh	MCA16
◆ Mineral	MCA15
◆ Nectar	MCA19
◆ Shale	MCA10

PRICE CODE B *continued*

SPIN*	SPIN
◆ Alabaster	SPIN02
◆ Cavern	SPIN03
◆ Cobblestone	SPIN04
◆ Ember	SPIN06
◆ Flame	SPIN07
◆ Heron	SPIN13
◆ Oat	SPIN01
◆ Ocean	SPIN12
◆ Plum	SPIN15
◆ Pool	SPIN11
◆ Raven	SPIN10
◆ Rhubarb	SPIN14
◆ Tropic	SPIN08
◆ Willow	SPIN05

TERRAIN* **TRRN**

◆ Bay	TRRN05
◆ Bayou	TRRN35
◆ Canyon	TRRN30
◆ Cliff	TRRN45
◆ Crest	TRRN25
◆ Delta	TRRN10
◆ Plateau	TRRN15
◆ Ridge	TRRN20
◆ Valley	TRRN40

NOTES: Analog and Disperse panel fabrics will be applied pattern cut. Disperse will not be available on 72"W panels. Analog is not available on sizes wider than 60".

◆◆◆ For lead time information see page 21.

* Directional fabrics

* Fabric is de-emphasized.

EMPOWER[®]

Step-by-Step Guide

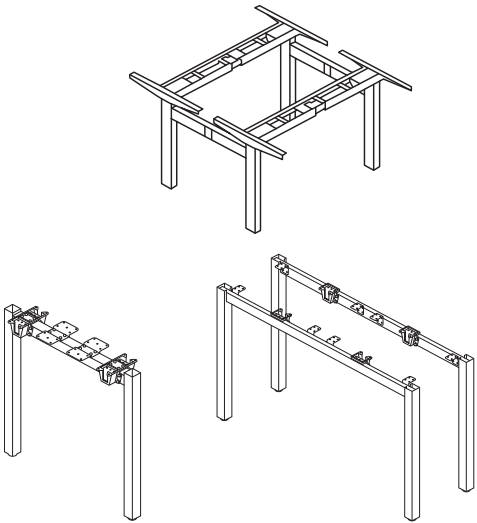

STEP 1: LEGS

All necessary brackets ship attached to the legs.

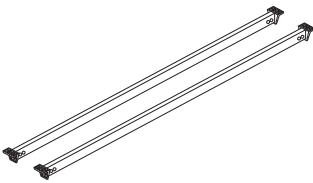

STEP 2: SUPPORT BEAMS (STATIC ONLY)

All necessary brackets ship attached to the beam. Simply fasten to the legs with the provided screws.

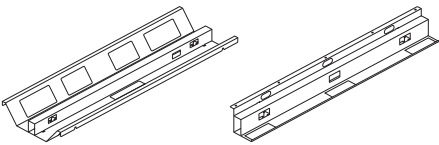

STEP 3: TROUGHS

Slide the trough over the support beams for double-sided. Screw the trough into the surface for single-sided.

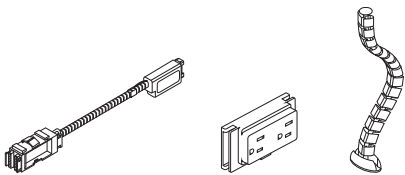

STEP 4: ELECTRICAL

Slide 8-wire harnesses/duplexes into pre-installed clips on the trough. Lay in data if necessary and cover.

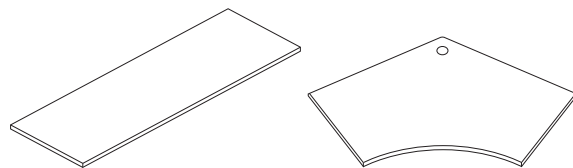
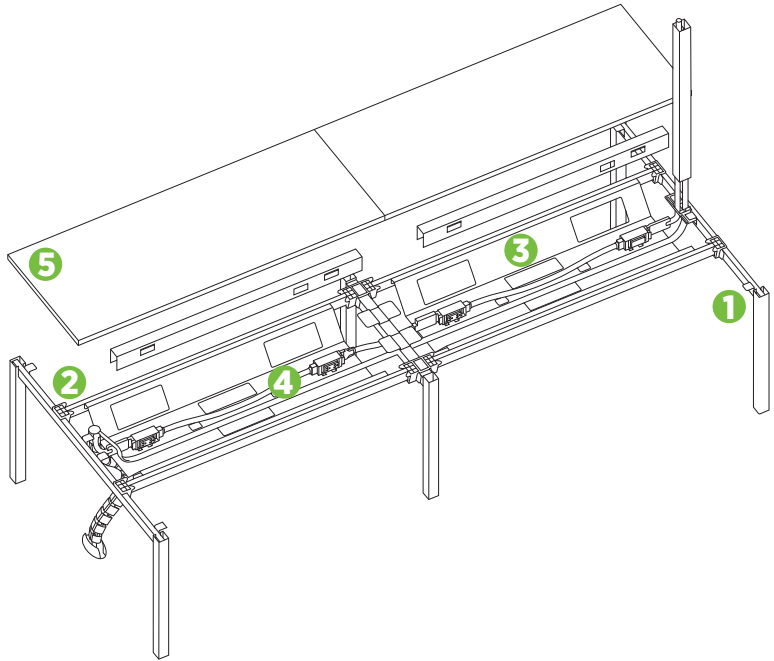

STEP 5: WORKSURFACES

All necessary brackets ship attached to the beam. Simply fasten to the legs with the provided screws.

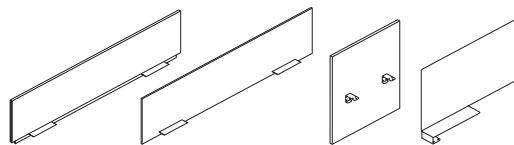

STEP 6: SCREENS

Drop shared screens into installed brackets, slide side screens into place or attach end of run screens at end of worksurfaces.

UNIVERSAL SCREENS SPECIFICATION GUIDE

SCREEN MOUNTING TECH AND SPEC INFORMATION

Movable Above/Below

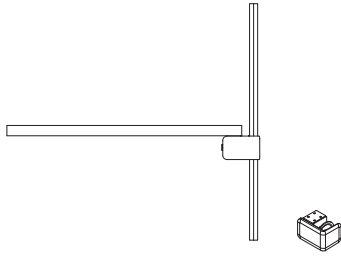

- Available in fabric only.
- Screen is offset from edge of worksurface by 1" for cord management and to allow the use of worksurface mounted accessories.
- Mounting brackets attach to the underside of the worksurface.
- Screen is secured to the brackets with thumb screws. Allowing user to adjust height up/down.
- Minimum height above or below worksurface is 6".
- Brackets are secured on the outside edge of the screen.
- Brackets ship uninstalled.

Sit-on-Surface Screen

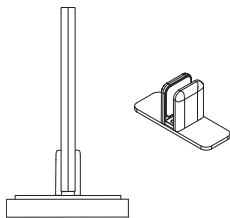

- Available in fabric or acrylic.
- Screen is slightly offset from the top of the worksurface.
- Brackets come with anti-slip neoprene foam pads.
- Brackets are designed to be rotated 90 degrees when needed.
- Screen is secured to the brackets by tightening two set screws in bracket against screen material.
- Brackets ship uninstalled.

Fixed Above/Below

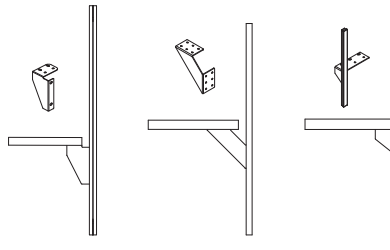

- Available in fabric, acrylic, or laminate.
- Screen is offset from the edge of the worksurface by 1" for cord management and to allow the use of worksurface mounted accessories.
- Mounting brackets attach to the underside of the worksurface.
- Fabric screens are secured to the brackets via metal fasteners to threaded inserts embedded in screen. Brackets are inset 10" (30-40"W) or 12" (42"W+) from edge of screen depending on size. Brackets ship installed.
- Acrylic screens are secured to the brackets via a metal fastener. Brackets are located on edge of screen. Brackets ship uninstalled.
- Laminate screens are secured to the brackets via wood screws. Brackets are inset 10" (30-42"W) or 12" (48"W+). Brackets ship uninstalled.

Top Mount Screen

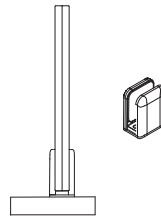

- Available in fabric or acrylic.
- Screen is slightly offset from the top of the worksurface.
- Mounting brackets attach to the top of the worksurface with either double sided tape or wood screws.
- Screen is secured to the brackets by tightening two set screws in bracket against screen material.
- Bracket location is flexible and can be adjusted as needed.
- Recommended inset location is -6-12" from edge of screen.
- Brackets ship uninstalled.

Side Mount Screen

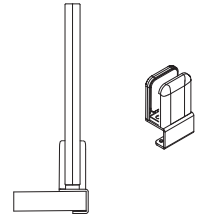

- Available in fabric or acrylic.
- Screen is slightly offset from the top of the worksurface.
- Mounting brackets wrap around the edge of the worksurface.
- Screen is secured to the brackets by tightening two set screws in bracket against screen material.
- Bracket location is flexible and can be adjusted as needed.
- Recommended inset location is -6-12" from edge of screen.
- Can only be used with flat edged worksurfaces/tables.
- Brackets ship uninstalled.

Modesty Panel

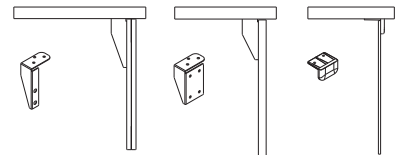

- Available in fabric, acrylic, or laminate.
- Mounting brackets attach to the underside of the worksurface.
- Fabric modesty is secured to brackets via metal fasteners to threaded inserts embedded in screen. Brackets are inset 10" (30-40"W) or 12" (42"W+) from edge of screen depending on size. Brackets ship installed.
- Acrylic modesty is secured to brackets via metal fasteners through predrilled holes in the modesty panel. Brackets are inset 10" (36"W) or 12" (42"W+) from edge of screen depending on size. Brackets ship uninstalled.
- Laminate modesty is secured to brackets via wood screws. Brackets are inset 10" (30-42"W) or 12" (48"W+). Brackets ship uninstalled.

UNIVERSAL SCREENS SPECIFICATION GUIDE

SCREEN MOUNTING TECH AND SPEC INFORMATION

Up Mount Screen

- Available in fabric, acrylic, or glass.
- Screen is offset from top of worksurface by 1" for cord management and to allow the use of worksurface mounted accessories.
- Mounting brackets attach to the underside of the worksurface.
- Screen is secured to the brackets by tightening two set screws in bracket against screen material.
- Bracket location is flexible and can be adjusted as needed. Recommended inset location is -6-12" from edge of screen.
- Can only be used with flat edged worksurfaces/tables.
- Brackets ship uninstalled.

Empower® Shared Screens

- Available in fabric, glass, acrylic, or PET.
- Mounting brackets clamp in gap between fixed height worksurfaces.
- Screens will provide 1"+ of access between screen and rear edge of worksurface for the power trough.
- Screen is secured to the brackets by tightening two set screws in bracket against screen material.
- Bracket location is flexible and can be adjusted as needed. Recommended inset location is -6-12" from edge of screen.
- Screen only mounts to dual sided fixed height applications. For height adjustable or single sided applications, select a desktop mounted screen.
- Brackets ship uninstalled.
- Shared screens are for fixed height Empower® only. Use desk mounted screens for height adjustable Empower® workstations.

Lateral Desktop Organizer

- Available in metal only.
- Screens sit flush on top of worksurface.
- Screen wraps around the front or rear edge of the worksurface.
- Can only be used with flat edged worksurfaces/tables.
- Mounting bracket is integral to screen.

EMPOWER[®] ELECTRICAL SPECIFYING INFORMATION

To Order:

- Determine which electrical system you will use after consulting your electrician and computer support personnel:
 - The Four-circuit system (4-Hot/2-Neutral/2-Ground)**
 - 3 + 1 option
 - 2 + 2 option
 - The Three-circuit system (3-Hot/3-Neutral/2-Ground)**
 - Determine location, quantity and circuit of duplexes.
 - Determine the appropriate choice and use of Isolated, Isolated/Dedicated and Separate Neutral circuits.
 - Specify appropriate Power Harnesses* and Pass-Thru Cables.*
 - Determine the location, quantity and type of Power In-feed needed.
- * Select Power Harness models (HH8712XX) and Pass-Thru Cables (HH8711XX) with the last two digits being the same as the associated worksurface width.

Electrical System Options

The four-circuit, eight-wire electrical system is widely specified and trusted by hundreds of thousands of end-users. This proven system delivers four circuits for every power in-feed in either a 3 + 1 or 2 + 2 configuration. The isolated/dedicated circuits are ideal for sensitive computing equipment, while the common circuits are suitable for faxes, copiers, task lights and other peripherals.

Both the 3 + 1 and 2 + 2 systems use the same pre-wired components, making it easy to adjust as electrical needs change.

You can also choose a three-circuit, eight-wire system that has a dedicated neutral for every hot circuit. The three-circuit components have model numbers with an "A" suffix and appear in a gray box in this pricer.

Four-circuit, 3 + 1 Receptacle Option

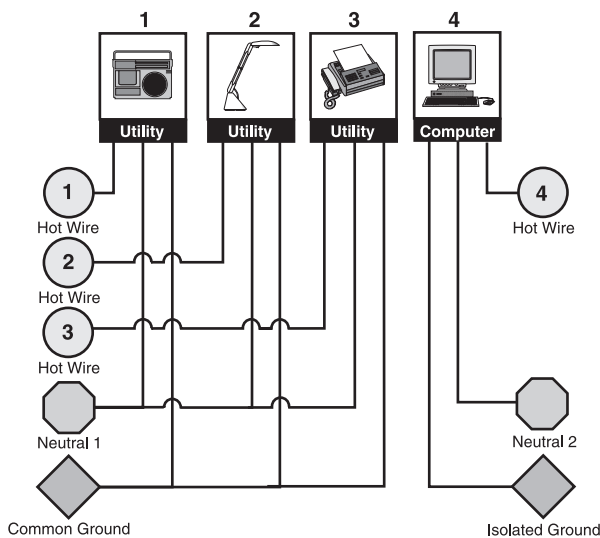

The 3 + 1 option is the electrical standard used by The HON Company for many years in most of their systems products. This wiring option provides three utility circuits plus an isolated/dedicated circuit for more sensitive equipment.

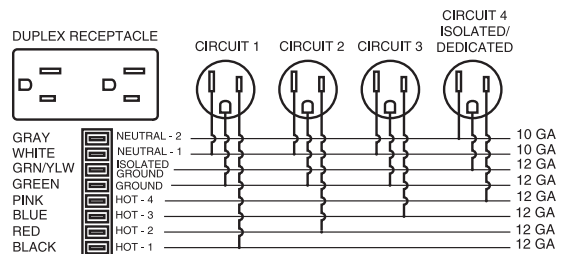

Four-circuit, 2 + 2 Receptacle Option

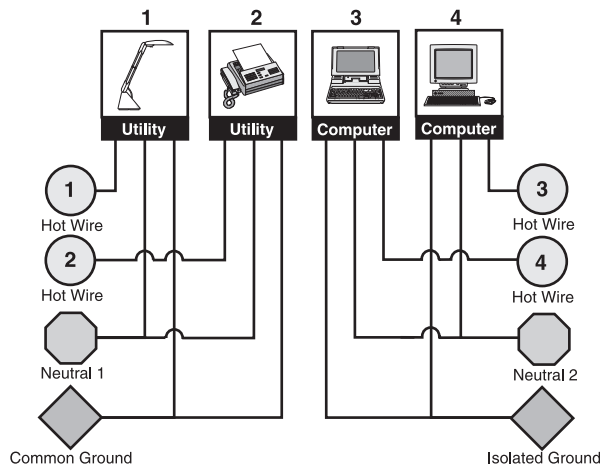

The 2 + 2 option is a wiring option that provides two utility circuits and two isolated circuits for more extensive computer usage applications.

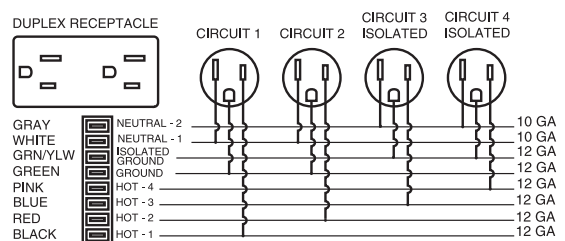

EMPOWER[®] ELECTRICAL SPECIFYING INFORMATION

Three-circuit, separate neutrals

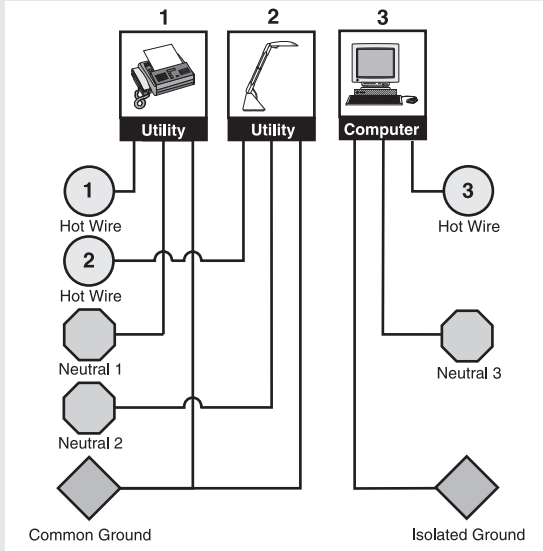

The Three-circuit, separate neutrals configuration is a wiring option that provides separate neutrals for each of the three circuits. Two circuits share a common ground, and one circuit is isolated/dedicated. The three-circuit components have model numbers with an "A" suffix and appear in a gray box in this pricer.

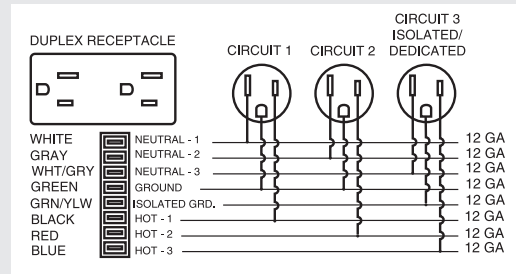

Two 8-wire, 20 AMP (15 AMP Canadian) electrical systems are offered					
Electrical System	Circuitry	Receptacle Capacity			
Four-circuit 4-Hot/2-Neutral/2-Ground	3 + 1	Common Circuit-1 HH873501	Common Circuit-2 (1) HH873502	Common Circuit-3 HH873503	Iso/Dedicated Circuit-4 HH873504
	(10 gauge neutral wires)	2 + 2	Common Circuit-1 HH873501	Common Circuit-2 HH873502	Isolated Circuit-3 HH873506
Three-circuit 3-Hot/3-Neutral/2-Ground	w/separate neutrals	Common Circuit-1 HH873501A	Common Circuit-2 HH873502A	Iso/Dedicated Circuit-3 HH873503A	N/A
(12 gauge neutral wires)					

(1) Circuit-2 (one of the 3 common circuits sharing a neutral wire) cannot be used with a single-phase building electrical supply.

Notes:

- Four-circuit components and three-circuit components (with suffix "A") cannot be used together.
- Components of the two systems are keyed differently to prevent components of one system from being connected to components of another system.
- HON Cat. Nos. are printed on the UL labels, and components are color-coded to provide visual identification of the different components.
- Four-circuit components have black plastic parts.
- Three-circuit components have rust-colored terminal ends and receptacle backs are rust colored.

Typical power usage by the most commonly specified office equipment.

Source: Industry Analysis, Inc., Rochester, NY

EQUIPMENT	AMPS	EQUIPMENT	AMPS	EQUIPMENT	AMPS
Computers		Copiers		FAX Machines	
Personal Computer	3	Desktop Copier	15	InkJet FAX	less than 1
Notebook Computer	3	Console Copier	20	Thermal FAX	less than 1
		Copier/Duplicator	30	Plain paper FAX	8
Monitors		Printers		Task Lights	
13" Color Monitor	2	Dot Matrix	less than 1	36" T8 Fluorescent	0.2/bulb
17" Color Monitor	3	InkJet	less than 1	48" T8 Fluorescent	0.3/bulb
21" Color Monitor	4	Personal Laser or LED	8		
		Workgroup Laser or LED	15		

Duplex Receptacles



15 AMP Receptacle

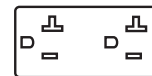

20 AMP Receptacle
(Required by some large copiers.)

EMPOWER[®] ELECTRICAL SPECIFYING INFORMATION

- Electrical components are UL Listed and CSA Certified.
- It is the customer's responsibility to ensure that use of the pre-wired electrical system, the number of receptacles used on a given circuit, and connection to a building power source, be in compliance with all local and national electrical codes.
- Contact Customer Service for additional information.
- Four-circuit components and Three-circuit components (with suffix "A") cannot be used together. See pages 439-440.
- ! A licensed electrician must make connections to a building electrical supply.

Definition of components:

Electrical Power Harness



- Used to distribute power in workstations.
- Power distribution in either direction.
- Specify Power Harness to match workstation width.
- Double-sided: receptacles can be inserted into both sides of Power Blocks.

Electrical Pass-Thru Cables

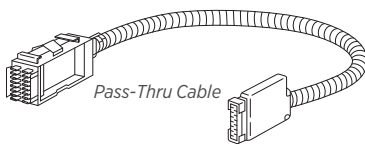

Pass-Thru Cable With Duplex Capacity:

- Use in workstations where multiple receptacles are not required.
- Added feature: has capacity for one receptacle on each side of a workstation. Feature offers future expansion and is an alternative to Power Harnesses.

Duplex Receptacles

- 15 amp outlet configuration.
- Models HH871601 and HH871601A have a 20 amp outlet configuration.
- Fit back-to-back into the Power Block(s) of Power and Pass-Thru Harnesses.
- Labeled with the provided circuit. Circuits connected to the Isolated Ground are identified with an orange triangle; circuits that do not share a neutral or ground have an orange circuit number.

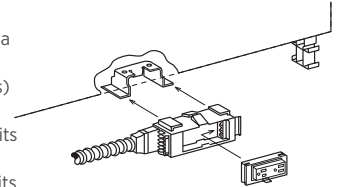

Power In-Feed Model (Floor or Ceiling) HMP144

- Used to connect the workstation electrical system to the building electrical supply.
- ! A licensed electrician must make connections to a building electrical supply.
- ! Conduit is UL listed Black Liquid-tight conduit (outside diameter is 7/8").

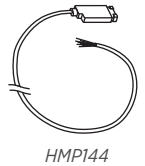

Note: In-feed cables listed above may be field-cut to desired length.

3-Pack 120 Degree Electric Specification Guide

	A	B
36" 120 surface	HH871124	HH871148
42" 120 surface	HH871124	HH871160
48" 120 surface	HH871124	HH871172

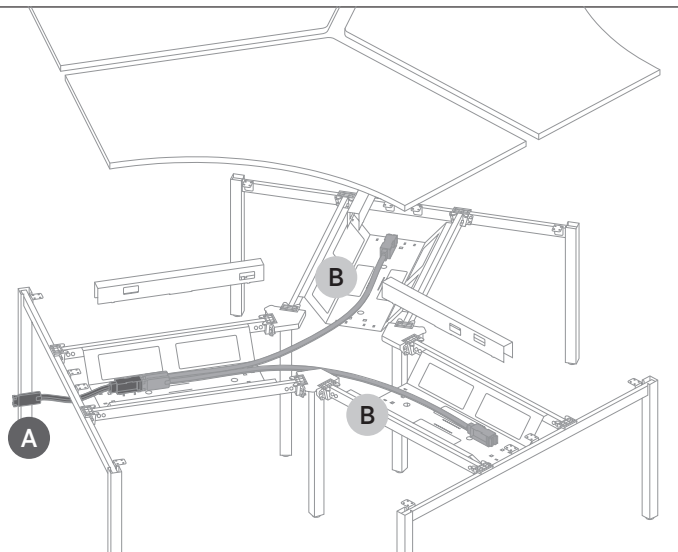

EMPOWER[®] ELECTRICAL SPECIFYING INFORMATION

- Electrical components are UL Listed and CSA Certified.
- It is the customer's responsibility to ensure that use of the pre-wired electrical system, the number of receptacles used on a given circuit, and connection to a building power source, be in compliance with all local and national electrical codes.
- ! A licensed electrician must make connections to a building electrical supply.

Vertebrae:
17 Cables, 0.250 Diameter (CAT-6)

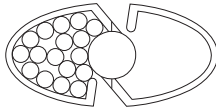

Single-Depth Cable Trough Cover Capacity:
13 Cables, 0.250 Diameter (CAT-6)

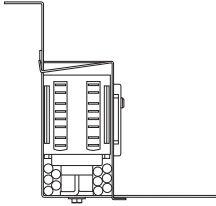

Double-Depth Cable Trough Cover Capacity:
14 Cables, 0.250 Diameter (CAT-6)

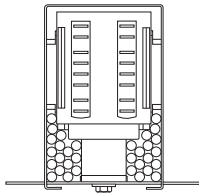

Data Cable Packing in Power Pole:
33 Cables, 0.250 Diameter (CAT-6)

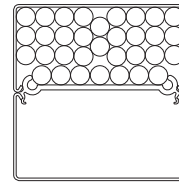

Data Cable Packing in Wire Trough Cover:
14 Cables, 0.250 Diameter (CAT-6)

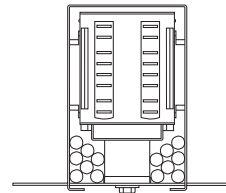



Icon Legend on page 19

60"W Typicals with 24"D Worksurfaces

QTY	DESCRIPTION	MODEL	LIST PRICE	PRICE EXTENSION
4	Worksurface, Edgeband, No Grommets 24" x 60"	HWR2460PN	\$614	\$2,456
1	Double Depth U-Leg (Box of 2)	HMPEL4828	\$1,511	\$1,511
1	Double Depth Shared U-Leg (Singles)	HMPSL4828	\$623	\$623
2	Support Beams (Box of 2) 60"W	HMPUB260	\$846	\$1,692
2	Shared Trough 60"W	HMPTROUGH60	\$582	\$1,164
1	Power Harness 60"W	HH871260	\$286	\$286
1	End of Run Electrical Kit 60"W	HMPEEK60	\$298	\$298
2	Duplex 1	HH871501	\$58	\$116
2	Duplex 2	HH871502	\$58	\$116
2	Duplex 3	HH871503	\$58	\$116
2	Duplex 4	HH871504	\$58	\$116
TOTAL:				\$8,494

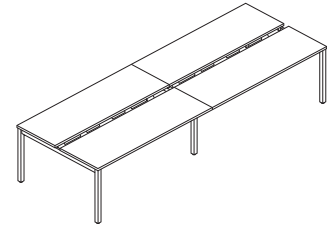

4-PACK — 60"
144" W x 51" D

QTY	DESCRIPTION	MODEL	LIST PRICE	PRICE EXTENSION
6	Worksurface, Edgeband, No Grommets 24" x 60"	HWR2460PN	\$614	\$3,684
1	Double Depth U-Leg (Box of 2)	HMPEL4828	\$1,511	\$1,511
2	Double Depth Shared U-Leg (Singles)	HMPSL4828	\$623	\$1,246
3	Support Beams (Box of 2) 60"W	HMPUB260	\$846	\$2,538
3	Shared Trough 60"W	HMPTROUGH60	\$582	\$1,746
2	Power Harness 60"W	HH871260	\$286	\$572
1	End of Run Electrical Kit 60"W	HMPEEK60	\$298	\$298
3	Duplex 1	HH871501	\$58	\$174
3	Duplex 2	HH871502	\$58	\$174
3	Duplex 3	HH871503	\$58	\$174
3	Duplex 4	HH871504	\$58	\$174
TOTAL:				\$12,291

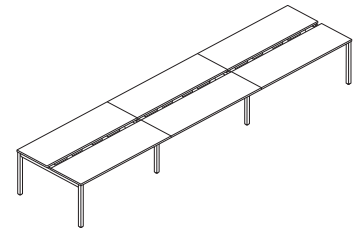

6-PACK — 60"
180" W x 51" D

NOTES: Typicals DO NOT include power in-feeds, screens, storage, or seating.

SEE PAGE 446 FOR ADDITIONAL BUNDLES AND SKU INFORMATION

EMPOWER[®] 120° Workstation Typical



Icon Legend on page 19

WORKSTATIONS

QTY	DESCRIPTION	MODEL	LIST PRICE	PRICE EXTENSION
3	120 Degree Corner Worksurfaces with Curved User Edge, No Grommets 48"W x 30"D	HBWCT4830PN	\$1,493	\$4,479
3	Double Depth U-Leg (Single Leg)	HMP120EL4828	\$758	\$2,274
3	Single Post Leg 28½"H	HMP120POST	\$397	\$1,191
3	Support Beams (Box of 2) 48"W	HMP120UB248	\$760	\$2,280
3	Double-Sided Trough 48"W	HMP120TROUGH48	\$528	\$1,584
TOTAL:				\$11,808

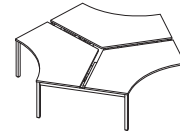

3-PACK – 120°

QTY	DESCRIPTION	MODEL	LIST PRICE	PRICE EXTENSION
6	120 Degree Corner Worksurfaces with Curved User Edge, No Grommets 48"W x 30"D	HBWCT4830PN	\$1,493	\$8,958
4	Double Depth U-Leg (Single Leg)	HMP120EL6028	\$832	\$3,328
6	Single Post Leg 28½"H	HMP120POST	\$397	\$2,382
6	Support Beams (Box of 2) 48"W	HMP120UB248	\$760	\$4,560
6	Double-Sided Trough 48"W	HMP120TROUGH48	\$528	\$3,168
2	Double Depth Shared U-Leg (Singles)	HMPSL6028	\$685	\$1,370
2	Worksurface with Edgeband 48"W x 30"D	HWR3048PN	\$562	\$1,124
1	Support Beams (Box of 2) 48"W	HMPUB248	\$760	\$760
1	Double-Sided Trough 48"W	HMP120TROUGH48	\$528	\$528
TOTAL:				\$26,178

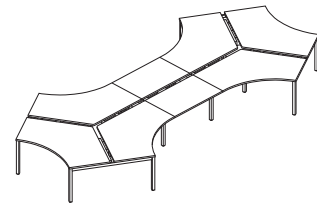

DOG BONE – 120°

QTY	DESCRIPTION	MODEL	LIST PRICE	PRICE EXTENSION
9	120 Degree Corner Worksurfaces with Curved User Edge, No Grommets 48"W x 30"D	HBWCT4830PN	\$1,493	\$13,437
5	Double Depth U-Leg (Single Leg)	HMP120EL4828	\$758	\$3,790
9	Single Post Leg 28½"H	HMP120POST	\$397	\$3,573
9	Support Beams (Box of 2) 48"W	HMP120UB248	\$760	\$6,840
9	Double-Sided Trough 48"W	HMP120TROUGH48	\$528	\$4,752
2	Double Depth Shared U-Leg (Singles)	HMPSL4828	\$623	\$1,246
TOTAL:				\$33,638

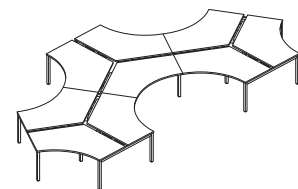

MULTIPLE PODS – 120°

NOTES: Typicals DO NOT include power in-feeds, screens, storage, or seating.



Icon Legend on page 19

QTY	DESCRIPTION	MODEL	LIST PRICE	PRICE EXTENSION
4	Worksurface, Edgeband, No Grommets 23" x 58"	HHATW2358EM	\$587	\$2,348
2	Height Adjustable Base	HMPHA2S4C	\$3,042	\$6,084
2	Height Adjustable Shared Trough 60"W	HMPHATROUGH60	\$582	\$1,164
4	Single-Sided Trough Lid	HMPHASLID60	\$187	\$748
1	Power Harness 60"W	HH871260	\$286	\$286
1	End of Run Electrical Kit 60"W	HMPEEK60	\$298	\$298
2	Duplex 1	HH871501	\$58	\$116
2	Duplex 2	HH871502	\$58	\$116
2	Duplex 3	HH871503	\$58	\$116
2	Duplex 4	HH871504	\$58	\$116
TOTAL:			\$11,392	

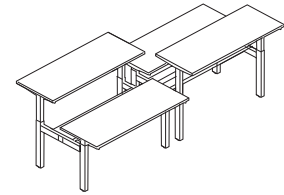
**4-PACK – 60"
120"W x 51"D**

QTY	DESCRIPTION	MODEL	LIST PRICE	PRICE EXTENSION
6	Worksurface, Edgeband, No Grommets 23" x 58"	HHATW2358EM	\$587	\$3,522
3	Height Adjustable Base	HMPHA2S4C	\$3,042	\$9,126
3	Height Adjustable Shared Trough 60"W	HMPHATROUGH60	\$582	\$1,746
6	Single-Sided Trough Lid	HMPHASLID60	\$187	\$1,122
2	Power Harness 60"W	HH871260	\$286	\$572
1	End of Run Electrical Kit 60"W	HMPEEK60	\$298	\$298
3	Duplex 1	HH871501	\$58	\$174
3	Duplex 2	HH871502	\$58	\$174
3	Duplex 3	HH871503	\$58	\$174
3	Duplex 4	HH871504	\$58	\$174
TOTAL:			\$17,082	

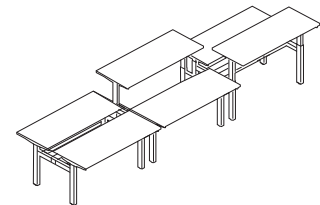
**6-PACK – 60"
180"W x 51"D**

NOTES: Typicals DO NOT include power in-feeds, screens, storage, or seating.

SEE PAGE 447 FOR ADDITIONAL BUNDLES AND SKU INFORMATION

EMPOWER® Bundles

GSA SIN 33721



Icon Legend on page 19

WORKSTATIONS

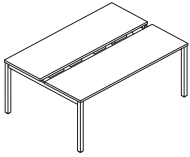
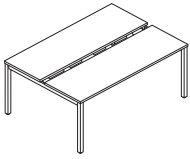
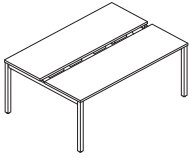
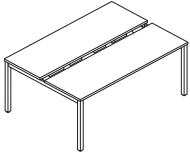
	DESCRIPTION	MODEL	SHIP WEIGHT	CUBE	LIST PRICE BY LAMINATE GRADE	
					L1	L2
	Bundles — 72" W with 24" D Worksurfaces					
	2-Pack	HMP2472PK2	238.9	35.3	\$5260	\$5302
	4-Pack	HMP2472PK4	465.8	59.4	\$9048	\$9132
	6-Pack	HMP2472PK6	692.7	83.9	\$13122	\$13248
	8-Pack	HMP2472PK8	919.6	108.5	\$17196	\$17364
	Bundles — 60" W with 24" D Worksurfaces					
	2-Pack	HMP2460PK2	198.9	35.3	\$5281	\$5323
	4-Pack	HMP2460PK4	385.8	59.4	\$8494	\$8578
	6-Pack	HMP2460PK6	572.7	83.9	\$12291	\$12417
	8-Pack	HMP2460PK8	759.6	108.5	\$16088	\$16256
	Bundles — 72" W with 30" D Worksurfaces					
	2-Pack	HMP3072PK2	238.9	35.3	\$5574	\$5616
	4-Pack	HMP3072PK4	465.8	59.4	\$9588	\$9672
	6-Pack	HMP3072PK6	692.7	83.9	\$13888	\$14014
	8-Pack	HMP3072PK8	919.6	108.5	\$18188	\$18356
	Bundles — 60" W with 30" D Worksurfaces					
	2-Pack	HMP3060PK2	198.9	35.3	\$5241	\$5283
	4-Pack	HMP3060PK4	385.8	59.4	\$8922	\$9006
	6-Pack	HMP3060PK6	572.7	83.9	\$12889	\$13015
	8-Pack	HMP3060PK8	759.6	108.5	\$16856	\$17024

SPECIFYING EXAMPLE: Model.Laminate.Edgeband.Paint2.DuplexColor (S only)

NOTES:

- Bundles include worksurfaces, support legs, support bars, wire management troughs, harnesses, and duplexes.
- Please specify in-feed, screens, storage, and seating separately.

ⓘ Stack-on storage cannot be used on Empower benching.

HOW TO SPECIFY

<p>Select Model Number</p> <p>HMP2472PK2</p>	<p>Select Laminate Color</p> <p>See page 435</p> <p>LDW1</p>	<p>Select Edgeband Color</p> <p>See page 435</p> <p>LDW1</p>	<p>Select Paint Color</p> <p>See page 435</p> <p>\$5 upcharge for P2 Paints</p> <p>T1</p>	<p>Select Duplex Color</p> <p>See page 435</p> <p>S</p>
---	---	---	--	--



	DESCRIPTION	MODEL	SHIP WEIGHT	CUBE	LIST PRICE BY LAMINATE GRADE	
					L1	L2
	Bundles — 72" W with 24" D Worksurfaces					
	2-Pack	HMPHA2472PK2	331	19.1	\$6202	\$6244
	4-Pack	HMPHA2472PK4	662	37.6	\$11820	\$11904
	6-Pack	HMPHA2472PK6	993	56.2	\$17724	\$17850
	8-Pack	HMPHA2472PK8	1324	74.7	\$23628	\$23796
	Bundles — 60" W with 24" D Worksurfaces					
	2-Pack	HMPHA2460PK2	291	16.9	\$5988	\$6030
	4-Pack	HMPHA2460PK4	581	33.1	\$11392	\$11476
	6-Pack	HMPHA2460PK6	872	49.4	\$17082	\$17208
	8-Pack	HMPHA2460PK8	1162	65.7	\$22772	\$22940
	Bundles — 72" W with 30" D Worksurfaces					
	2-Pack	HMPHA3072PK2	363	21.3	\$6360	\$6402
	4-Pack	HMPHA3072PK4	726	41.9	\$12136	\$12220
	6-Pack	HMPHA3072PK6	1089	62.6	\$18198	\$18324
	8-Pack	HMPHA3072PK8	1452	83.3	\$24260	\$24428
	Bundles — 60" W with 30" D Worksurfaces					
	2-Pack	HMPHA3060PK2	353	18.7	\$6092	\$6134
	4-Pack	HMPHA3060PK4	705	36.7	\$11600	\$11684
	6-Pack	HMPHA3060PK6	1058	54.8	\$17394	\$17520
	8-Pack	HMPHA3060PK8	1410	72.9	\$23188	\$23356

SPECIFYING EXAMPLE: Model.Laminate.Edgeband.BasePaint.TroughPaint.DuplexColor

NOTES:

- Bundles include worksurfaces, wire management troughs, trough covers, harnesses, duplexes, and bases.
- Please specify in-feed, screens, storage, and seating separately.

- ! Stack-on storage cannot be used on Empower benching.
- ! HBSMAUSB and HBDMAUSB cannot be used in Empower® height adjustable applications.

HOW TO SPECIFY

Select Model Number	Select Laminate Color	Select Edgeband Color	Select Base Paint Color	Select Trough Paint Color	Select Duplex Color
	See page 435	See page 435	See page 435	See page 435	See page 435
H M P H A 2 4 7 2 P K 2 .	L D W 1 .	L D W 1 .	P R 6 .	S .	S .

EMPOWER® Legs for Linear Applications

GSA SIN 33721



Icon Legend on page 19

WORKSTATIONS

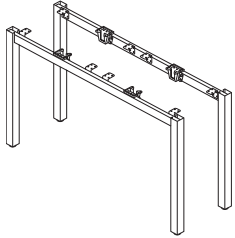

DESCRIPTION

Double Depth U-Leg (Box of 2)
50½"D for use with 24"D Worksurfaces
62½"D for use with 30"D Worksurfaces
NOTES: Ships as a box of 2 legs.

MODEL	SHIP WEIGHT	CUBE	LIST PRICE BY PAINT GRADE		
			P1	P2	P3
HMPPEL4828	32.4	14.9	\$1511	\$1516	\$1547
HMPPEL6028	34.8	18.5	\$1661	\$1666	\$1700

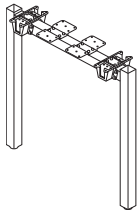

Double Depth Shared U-Leg (Singles)
30"D for use with 24"D Worksurfaces
42"D for use with 30"D Worksurfaces

HMPPSL4828	21.1	4.9	\$623	\$628	\$638
HMPPSL6028	22.5	6.4	\$685	\$690	\$701

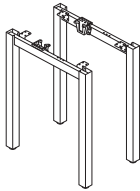

Single Depth U-Leg (Box of 2)
24"D for use with 24"D Worksurfaces
30"D for use with 30"D Worksurfaces

HMPPEL2428	23.7	7.6	\$755	\$760	\$785
HMPPEL3028	24.9	9.4	\$832	\$837	\$865

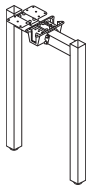

Single Depth Shared U-Leg (Singles)
18"D for use with 24"D Worksurfaces
24"D for use with 30"D Worksurfaces

HMPPSL2428	14.8	3.2	\$461	\$466	\$479
HMPPSL3028	15.6	4.0	\$506	\$511	\$526

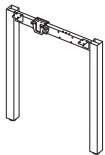

Single Depth Return U-Leg (Singles)
Left
Right
NOTES: Return U-Legs ship with two flat brackets.

HMPRELEL2428	23.7	4.0	\$461	\$466	\$479
HMPPRELR2428	23.7	4.0	\$461	\$466	\$479

HOW TO SPECIFY

Select Model Number

Select Paint Color

See page 435

H M P E L 4 8 2 8 . T 1



EMPOWER® Legs for 120° Applications

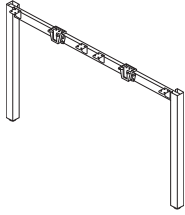

DESCRIPTION	MODEL	SHIP WEIGHT	CUBE	LIST PRICE BY PAINT GRADE		
				P1	P2	P3
Double Depth U-Leg (Single Leg for 120° Applications)						
50½"D for use with 24"D Worksurfaces	HMP120EL4828	19	7.9	\$758	\$763	\$788
60½"D for use with 30"D Worksurfaces	HMP120EL6028	20	9.6	\$832	\$837	\$865

NOTES: Ships as single leg for 120 degree applications.

⚠ 120 degree surfaces must be used in back-to-back applications — cannot be used freestanding.



Post Leg for 120° Applications (Singles)						
28½"H	HMP120POST	10	1.4	\$397	\$402	\$413

NOTES: One post leg needed per 120 degree worksurface. Post leg ships with attachment brackets needed to connect support beams and worksurfaces.

⚠ 120 degree surfaces must be used in back-to-back applications — cannot be used freestanding.

HOW TO SPECIFY

<p>Select Model Number</p> <p>H M P 1 2 0 E L 4 8 2 8 . T 1</p>	<p>Select Paint Color</p> <p>See page 435</p>
--	--

EMPOWER[®] Support Beams

GSA SIN 33721



Icon Legend on page 19

WORKSTATIONS

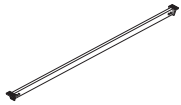
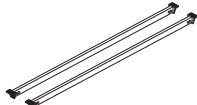
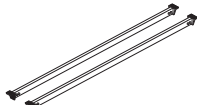
	DESCRIPTION	MODEL	SHIP WEIGHT	CUBE	LIST PRICE
	Support Beams (Box of 1)				
	48"W	HMPUB148	7.0	0.5	\$381
	60"W	HMPUB160	8.3	0.7	\$426
	72"W	HMPUB172	9.6	0.9	\$472
	NOTES: One support beam per worksurface is needed. ⓘ Available in graphite finish only. No specification needed.				
	Support Beams (Box of 2)				
	48"W	HMPUB248	13.3	0.5	\$760
	60"W	HMPUB260	15.8	0.7	\$846
	72"W	HMPUB272	18.2	0.9	\$937
	NOTES: For use with double-sided stations. One support beam per worksurface is needed. ⓘ Available in graphite finish only. No specification needed.				
	Support Beams for 120° Applications (Box of 2)				
	36"W	HMP120UB236	7.8	0.9	\$603
	42"W	HMP120UB242	9.5	0.9	\$678
	48"W	HMP120UB248	11.0	0.9	\$760
	NOTES: Two support beams per 120 degree worksurface are needed. ⓘ Available in graphite finish only. No specification needed.				

NOTES:

- For use with stationary, single-sided stations. 36"W returns will use the 48"W Support Beam and 48"W returns will use the 60"W Support Beam.



HOW TO SPECIFY

Select Model Number

H M P 1 2 0 U B 2 3 6

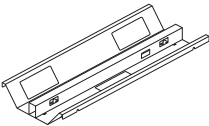
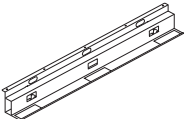
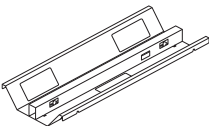

EMPOWER[®] Wire Troughs

	DESCRIPTION	MODEL	SHIP WEIGHT	CUBE	LIST PRICE
	Trough — Double-Sided				
	48"W	HMPTROUGH48	3.3	5.3	\$528
	60"W	HMPTROUGH60	4.3	6.8	\$582
	72"W	HMPTROUGH72	5.3	8.3	\$638
Available in graphite finish only. No specification needed.					
	Trough — Single-Sided				
	48"W	HMPSTROUGH48	3.0	5.3	\$396
	60"W	HMPSTROUGH60	4.0	6.8	\$537
	72"W	HMPSTROUGH72	5.0	8.3	\$678
Available in graphite finish only. No specification needed.					
 	Trough — Double-Sided for 120° Applications				
	36"W	HMP120TROUGH36	6.9	3.8	\$431
	42"W	HMP120TROUGH42	8.4	3.8	\$477
	48"W	HMP120TROUGH48	9.9	5.3	\$528
Available in graphite finish only. No specification needed.					

NOTES:

- Slots available in trough to zip tie data cables to the trough.
 - Double-sided wire trough rests on top of support bars. No fasteners needed.
 - Single-sided trough is used for single-sided applications only. Screws into bottom side of worksurface for attachment.
- For use with fixed height Empower[®] only.

HOW TO SPECIFY

Select Model Number

H M P T R O U G H 4 8

EMPOWER® Return Components

GSA SIN 33721



Icon Legend on page 19

WORKSTATIONS

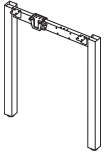

DESCRIPTION

Single Depth Return Leg (Singles)

Left
Right

MODEL	SHIP WEIGHT	CUBE	LIST PRICE BY PAINT GRADE		
			P1	P2	P3
HMPRELEL2428	23.7	4.0	\$461	\$466	\$479
HMPRREL2428	23.7	4.0	\$461	\$466	\$479

NOTES: Return legs ship with two flat brackets.

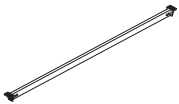

DESCRIPTION

Support Beams (Box of 1)

48"W
60"W

MODEL	SHIP WEIGHT	CUBE	LIST PRICE
HMPUB148	7.0	0.5	\$381
HMPUB160	8.3	0.7	\$426

NOTES: For use with single-sided stations. 36"W returns will use the 48"W Support Beam and 48"W returns will use the 60"W Support Beam.

ⓘ Available in graphite finish only. No specification needed.

NOTES:

- Return legs ship with two flat brackets. 36"W returns will use the 48"W Support Beam and 48"W returns will use the 60"W Support Beam.

ⓘ Stack-on storage cannot be used on Empower® benching.

ⓘ For use with static linear applications only.

HOW TO SPECIFY

<p>Select Model Number</p> <p>H M P R L E L 2 4 2 8 .</p>	<p>Select Paint Color</p> <p>See page 435</p> <p>T 1</p>
---	--



EMPOWER® Systems Worksurfaces

	DESCRIPTION	MODEL	SHIP WEIGHT	CUBE	LIST PRICE BY LAMINATE GRADE	
					L1	L2
	24"D Worksurface with Edgeband 36"W x 24"D	HWR2436PN	46	2.5	\$446	\$462
	NOTES: For use as a return surface only.					
	48"W x 24"D	HWR2448PN	58	3.3	\$520	\$536
	NOTES: Can be used as a primary surface or a return surface.					
	60"W x 24"D	HWR2460PN	70	4.0	\$614	\$635
	72"W x 24"D	HWR2472PN	89	4.8	\$679	\$700
	NOTES: For use as a primary surface.					
	30"D Worksurface with Edgeband 48"W x 30"D	HWR3048PN	58	3.3	\$562	\$578
	60"W x 30"D	HWR3060PN	70	4.0	\$668	\$689
	72"W x 30"D	HWR3072PN	89	4.8	\$761	\$782

NOTES:

- Worksurfaces are constructed of laminate on 1 1/8" solid core high-performance particleboard.
- ❗ All worksurfaces load tested to BIFMA standards.
- ❗ Stack-on storage cannot be used on Empower® benching.

Worksurface Width	Electrical Model	Quantity
36"	HH871124	1
36"	HH871148	2
42"	HH871124	1
42"	HH871160	2
48"	HH871124	1
48"	HH871172	2

HOW TO SPECIFY

<p>Select Model Number</p> <p>HWR2448PN</p>	<p>Select Laminate Color</p> <p>See page 435</p> <p>LDW1</p>	<p>Select Edgeband Color</p> <p>See page 435</p> <p>LDW1</p>
--	---	---

SYSTEMS WORKSURFACES

120 Degree Corner

GSA SIN 33721



Icon Legend on page 19

WORKSTATIONS

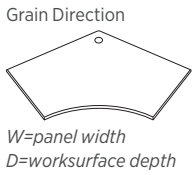

DESCRIPTION

Abound® and Accelerate® 120 Degree Corner Worksurfaces with Curved User Edge

MODEL	SHIP WEIGHT	CUBE	L1 LIST PRICE	L2 LIST PRICE
36"W x 24"D HBWCT3624P	75	7.7	\$935	\$951
42"W x 24"D HBWCT4224P	96	9.2	\$1005	\$1083
48"W x 24"D HBWCT4824P	107	9.2	\$1176	\$1192
42"W x 30"D HBWCT4230P	102	11.4	\$1341	\$1357
48"W x 30"D HBWCT4830P	112	11.4	\$1431	\$1447

- HBWCT3624P will not accept the H4022, HE4022, H4028, or H4029 keyboard platforms.
- One small worksurface bracket standard with each worksurface.

❗ Corner worksurfaces must match exactly the panel behind them, i.e.: a 36" panel must be used on the back two sides of model HBWCT3624P.

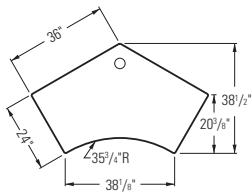

HBWCT3624P

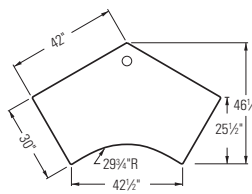

HBWCT4230P

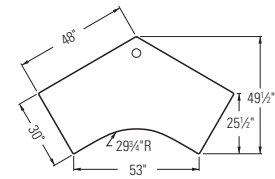

HBWCT4830P

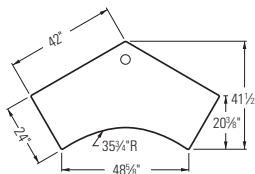

HBWCT4224P

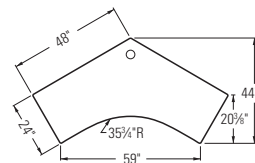

HBWCT4824P

NOTES:

- Worksurfaces are constructed of laminate on 1/8" solid core high-performance particleboard.
- Add suffix "N" to Model Number for worksurfaces with no grommets. No upcharge.
- Refer to Worksurface Supports, pages 554-558.
- If used at an end of run, full end panel needs to be ordered — see page 554.

❗ Cannot use keyboard tray or full height pedestal under 120 degree corner worksurface.

❗ For use with linear applications only.

❗ Recommend mounting monitor arms on back of worksurface with 120 configurations. Mounting through the grommet may lead to interference with 120 post leg and limit usable grommet space for cord passage.

HOW TO SPECIFY

<p>Select Model Number</p> <p>No Grommet option: Add "N" suffix (no upcharge)</p> <p>HBWCT3624P .</p> <p>HBWCT3624PN .</p>	<p>Select Laminate</p> <p>See page 413</p> <p>AS .</p> <p>AS .</p>	<p>Select Edge Color</p> <p>See page 413</p> <p>K .</p> <p>K</p>	<p>Select Grommet Color</p> <p>See page 413</p> <p>T1</p>
---	---	---	--

EMPOWER® Height Adjustable Bases

Icon Legend on page 19

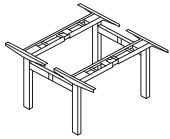

OPEN MARKET



DESCRIPTION

Height Adjustable Base
Back-to-Back Workstation

MODEL

HMPHA2S4C

SHIP WEIGHT

130

CUBE

5.3

LIST PRICE

\$3042

NOTES:

• Bases are steel construction with telescoping horizontal frame that adjusts from 41"-71"W to accommodate 42"-72"W worksurfaces. Memory controller features four memory presets, programmable upper and lower limit, and keypad lock to prevent unintentional movement. Dour motor with 250 lbs. load capacity per surface. Travel range of 19⁵/₈" adjustment from 25⁵/₈" to 45¹/₄" (excluding worksurface dimension).

! Height adjustable benching cannot be single-sided; must always be used in back to back layouts.

! HBSMAUSB and HBDMAUSB cannot be used in Empower® height adjustable applications.

DESCRIPTION

Trough for Height Adjustable Base — Double-Sided
48"W
60"W
72"W

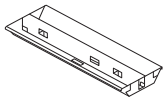

MODEL

HMPHATROUGH48
HMPHATROUGH60
HMPHATROUGH72

SHIP WEIGHT

5.0
6.5
7.0

CUBE

1.7
2.2
2.7

LIST PRICE

\$528
\$582
\$638

Single-Sided Trough Lid — Single Pack

For 48"W Trough
For 60"W Trough
For 72"W Trough
For Height Adjustable Base 20"W End of Run Trough

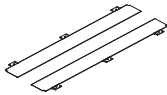

HMPHASLID48
HMPHASLID60
HMPHASLID72
HMPHASLID20

3.0
4.0
5.0
2.0

0.4
0.5
0.6
0.4

\$171
\$187
\$204
\$137

NOTES:

- Slots available in trough to zip tie data cables to the trough.
- Trough attaches to crossbeam connected to the height adjustable columns.
- 2 trough lids needed per double-sided trough.
- 1 trough lid needed for end of run trough.
- \$5 upcharge for P2 Paints.
- \$21 upcharge for P3 Paints on Trough Covers and End of Run Trough.
- \$21 upcharge for P3 Paints on Troughs.

HOW TO SPECIFY

<p>Select Model Number</p> <p>H M P H A 2 S 4 C</p>	<p>Select Paint Color</p> <p>See page 435</p> <p>P 8 L</p>
---	--

<p>Select Model Number</p> <p>H M P H A T R O U G H 4 8</p>	<p>Select Paint Color</p> <p>See page 435</p> <p>P 8 S</p>
---	--

EMPOWER[®] Height Adjustable Worksurfaces

GSA SIN 33721



Icon Legend on page 19

WORKSTATIONS

	DESCRIPTION	MODEL	SHIP WEIGHT	CUBE	LIST PRICE BY LAMINATE GRADE	
					L1	L2
	23"D Worksurface with Edgeband					
	46"W x 23"D	HHATW2346EM	58	3.1	\$497	\$513
	58"W x 23"D	HHATW2358EM	70	3.9	\$587	\$608
	70"W x 23"D	HHATW2370EM	89	4.6	\$649	\$670
	29"D Worksurface with Edgeband					
	46"W x 29"D	HHATW2946EM	68	3.9	\$537	\$553
	58"W x 29"D	HHATW2958EM	101	4.8	\$639	\$660
	70"W x 29"D	HHATW2970EM	105	5.7	\$728	\$749

NOTES:

- Worksurfaces are constructed of laminate on 1 1/8" solid core high-performance particleboard.
- ❗ All worksurfaces load tested to BIFMA standards.
- ❗ Stack-on storage cannot be used on Empower[®] benching.
- ❗ Height adjustable worksurfaces are reduced 2" in width and 0.75" in depth to prevent pinch points.

HOW TO SPECIFY

<p>Select Model Number</p> <p>HHATW2346EM.</p>	<p>Select Laminate Color</p> <p>See page 435</p> <p>WHIT.</p>	<p>Select Edgeband Color</p> <p>See page 435</p> <p>WHIT</p>
---	--	---



LATERAL ORGANIZER SCREENS

Fabric & Metal Screens

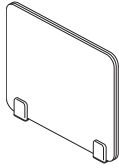

DESCRIPTION	MODEL	SHIP WEIGHT	CUBE	LIST PRICE	UPCHARGE BY FABRIC GRADE					
					B	C	D	E	F	G
Fabric Top Mount Screens										
13"H x 20"W	HUSFTPM1320	6.7	0.8	\$761	\$32	\$63	\$96	\$137	\$180	\$222
13"H x 22"W	HUSFTPM1322	6.8	0.8	\$773	\$33	\$65	\$98	\$142	\$184	\$228
13"H x 24"W	HUSFTPM1324	7.0	0.8	\$786	\$34	\$67	\$101	\$145	\$190	\$235
13"H x 28"W	HUSFTPM1328	7.4	1.0	\$798	\$35	\$68	\$103	\$149	\$194	\$240
13"H x 30"W	HUSFTPM1330	7.5	1.0	\$811	\$35	\$71	\$105	\$152	\$199	\$246
13"H x 36"W	HUSFTPM1336	7.9	1.0	\$865	\$39	\$78	\$116	\$169	\$220	\$271
20"H x 20"W	HUSFTPM2020	7.7	2.4	\$859	\$39	\$77	\$115	\$167	\$217	\$268
20"H x 22"W	HUSFTPM2022	7.9	1.2	\$874	\$39	\$79	\$118	\$171	\$223	\$275
20"H x 24"W	HUSFTPM2024	8.2	1.3	\$888	\$40	\$81	\$121	\$175	\$228	\$283
20"H x 28"W	HUSFTPM2028	8.7	1.5	\$904	\$41	\$83	\$124	\$179	\$235	\$290
20"H x 30"W	HUSFTPM2030	9.0	1.6	\$934	\$43	\$87	\$130	\$189	\$246	\$304
20"H x 36"W	HUSFTPM2036	9.5	1.9	\$1000	\$49	\$96	\$144	\$207	\$271	\$335

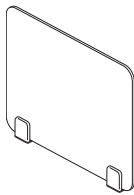

DESCRIPTION	MODEL	SHIP WEIGHT	CUBE	LIST PRICE BY PAINT GRADE		
				P1	P2	P3
Acrylic Top Mount Screens						
13"H x 20"W	HUSATPM1320	8.6	1.9	\$624	\$639	\$655
13"H x 22"W	HUSATPM1322	9.0	1.9	\$676	\$691	\$707
13"H x 24"W	HUSATPM1324	9.3	2.0	\$686	\$701	\$717
13"H x 28"W	HUSATPM1328	10.0	2.2	\$728	\$743	\$759
13"H x 30"W	HUSATPM1330	10.4	2.5	\$785	\$800	\$816
13"H x 36"W	HUSATPM1336	11.5	2.9	\$798	\$813	\$829
20"H x 20"W	HUSATPM2020	10.7	2.7	\$744	\$759	\$775
20"H x 22"W	HUSATPM2022	11.3	2.7	\$807	\$822	\$838
20"H x 24"W	HUSATPM2024	11.8	2.9	\$885	\$900	\$916
20"H x 28"W	HUSATPM2028	13.0	3.3	\$958	\$973	\$989
20"H x 30"W	HUSATPM2030	13.6	3.6	\$968	\$983	\$999
20"H x 36"W	HUSATPM2036	15.3	4.2	\$1170	\$1185	\$1201

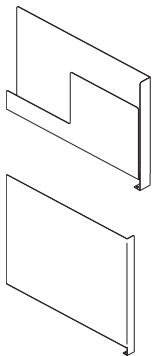

Metal Lateral Organizer Screens						
13"H x 20"W, Left Handed	HUSMSOS1320L	7.0	1.2	\$521	\$536	\$551
13"H x 20"W, Right Handed	HUSMSOS1320R	7.0	1.2	\$521	\$536	\$551
13"H x 26"W, Left Handed	HUSMSOS1326L	10.0	1.5	\$567	\$582	\$597
13"H x 26"W, Right Handed	HUSMSOS1326R	10.0	1.5	\$567	\$582	\$597
20"H x 20"W, Left Handed	HUSMSOS2020L	10.0	1.0	\$573	\$588	\$603
20"H x 20"W, Right Handed	HUSMSOS2020R	10.0	1.0	\$573	\$588	\$603
20"H x 26"W, Left Handed	HUSMSOS2026L	13.0	1.2	\$624	\$639	\$654
20"H x 26"W, Right Handed	HUSMSOS2026R	13.0	1.2	\$624	\$639	\$654

NOTES:

- Clamps to back edge of worksurface at 13"H and 20"H.
- Screen is designed to sit back from front edge of worksurface.
- Space for folders is 1½" and holds approximately 340 sheets of paper.
- Folder storage is one-sided — LH and RH options available.

HOW TO SPECIFY

<p>Select Model Number</p> <p>H U S F S O S 1 3 2 2 .</p>	<p>Select Fabric (if applicable)</p> <p>See page 683</p> <p>N B L E 1 8 .</p>	<p>Select Bracket Paint</p> <p>See page 683</p> <p>P 7 1 .</p>	<p>Select Paint Color (if applicable)</p> <p>See page 683</p> <p>P 7 1</p>
---	---	--	--

NOTES



EMPOWER® Shared Screens

DESCRIPTION	MODEL	SHIP WEIGHT	CUBE	LIST PRICE BY FABRIC GRADE		
				AA	A	B
Fabric Empower® Shared Screens						
13"H x 42"W	HUSFEMP1342	8.5	1.4	\$867	\$867	\$908
13"H x 48"W	HUSFEMP1348	9.0	1.6	\$926	\$926	\$971
13"H x 54"W	HUSFEMP1354	9.5	1.8	\$992	\$992	\$1042
13"H x 60"W	HUSFEMP1360	10.0	2.0	\$1049	\$1049	\$1103
13"H x 66"W	HUSFEMP1366	10.5	2.2	\$1111	\$1111	\$1169
13"H x 72"W	HUSFEMP1372	11.0	2.4	\$1178	\$1178	\$1241
Fabric Empower® Shared Screens						
20"H x 42"W	HUSFEMP2042	10.6	2.2	\$1003	\$1003	\$1054
20"H x 48"W	HUSFEMP2048	11.4	2.5	\$1076	\$1076	\$1132
20"H x 54"W	HUSFEMP2054	12.2	2.8	\$1157	\$1157	\$1218
20"H x 60"W	HUSFEMP2060	13.0	3.0	\$1176	\$1176	\$1238
20"H x 66"W	HUSFEMP2066	13.8	3.3	\$1267	\$1267	\$1336
20"H x 72"W	HUSFEMP2072	14.6	3.6	\$1367	\$1367	\$1443

HOW TO SPECIFY

Select Model Number

H U S F E M P 1 3 4 2 .

Select Fabric

See pages 436-437

N B L E 1 8 .

Select Bracket Paint

See page 435

P R 6

DESCRIPTION	MODEL	SHIP WEIGHT	CUBE	CLEAR GLASS	FROSTED GLASS
Glass Empower® Shared Screens					
13"H x 42"W	HUSGEMP1342	22.1	2.0	\$944	\$1015
13"H x 48"W	HUSGEMP1348	24.6	2.2	\$978	\$1052
13"H x 54"W	HUSGEMP1354	27.0	2.5	\$1015	\$1093
13"H x 60"W	HUSGEMP1360	29.5	2.7	\$1054	\$1136
13"H x 66"W	HUSGEMP1366	31.9	3.0	\$1098	\$1184
13"H x 72"W	HUSGEMP1372	34.4	3.2	\$1135	\$1225
Glass Empower® Shared Screens					
20"H x 42"W	HUSGEMP2042	32.1	2.8	\$1090	\$1176
20"H x 48"W	HUSGEMP2048	36.0	3.2	\$1124	\$1213
20"H x 54"W	HUSGEMP2054	39.9	3.6	\$1178	\$1273
20"H x 60"W	HUSGEMP2060	43.8	3.9	\$1223	\$1323
20"H x 66"W	HUSGEMP2066	47.6	4.3	\$1290	\$1397
20"H x 72"W	HUSGEMP2072	51.5	4.7	\$1344	\$1456

HOW TO SPECIFY

Select Model Number

H U S G E M P 1 3 4 2 .

Select Glass

Q Clear Glass
R Frosted Glass

Q .

Select Bracket Paint

See page 435

P R 6

EMPOWER® Shared Screens

OPEN MARKET



Icon Legend on page 19

WORKSTATIONS

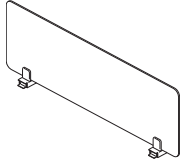

DESCRIPTION	MODEL	SHIP WEIGHT	CUBE	LIST PRICE BY PAINT GRADE		
				P1	P2	P3
Acrylic Empower® Shared Screens						
13"H x 42"W	HUSAEMP1342	12.6	3.3	\$932	\$948	\$978
13"H x 48"W	HUSAEMP1348	13.6	3.8	\$953	\$969	\$999
13"H x 54"W	HUSAEMP1354	14.7	4.2	\$1088	\$1104	\$1134
13"H x 60"W	HUSAEMP1360	15.8	4.6	\$1099	\$1115	\$1145
13"H x 66"W	HUSAEMP1366	16.9	5.1	\$1234	\$1250	\$1280
13"H x 72"W	HUSAEMP1372	18.0	5.5	\$1244	\$1260	\$1290
20" H x 42" W						
20"H x 42"W	HUSAEMP2042	17.0	4.9	\$1410	\$1426	\$1456
20"H x 48"W	HUSAEMP2048	18.7	5.5	\$1421	\$1437	\$1467
20"H x 54"W	HUSAEMP2054	20.4	6.2	\$1683	\$1699	\$1729
20"H x 60"W	HUSAEMP2060	22.1	6.8	\$1704	\$1720	\$1750
20"H x 66"W	HUSAEMP2066	23.8	7.5	\$1956	\$1972	\$2002
20"H x 72"W	HUSAEMP2072	25.5	8.1	\$1966	\$1982	\$2012

HOW TO SPECIFY

Select Model Number

H U S A E M P 1 3 4 2 .

Select Bracket Paint

See page 435

P R 6

DESCRIPTION	MODEL	SHIP WEIGHT	CUBE	LIST PRICE
PET Empower® Shared Screens				
13"H x 42"W	HUSPEMP1342	18.5	1.9	\$566
13"H x 48"W	HUSPEMP1348	18.5	2.0	\$591
13"H x 54"W	HUSPEMP1354	21.8	2.2	\$700
13"H x 60"W	HUSPEMP1360	21.8	2.4	\$781
13"H x 66"W	HUSPEMP1366	25.0	2.6	\$839
13"H x 72"W	HUSPEMP1372	25.0	2.8	\$885
20" H x 42" W				
20"H x 42"W	HUSPEMP2042	26.5	1.9	\$895
20"H x 48"W	HUSPEMP2048	26.5	2.8	\$904
20"H x 54"W	HUSPEMP2054	32.0	3.0	\$932
20"H x 60"W	HUSPEMP2060	32.0	3.3	\$1007
20"H x 66"W	HUSPEMP2066	37.3	3.6	\$1080
20"H x 72"W	HUSPEMP2072	37.3	2.5	\$1110

HOW TO SPECIFY

Select Model Number

H U S P E M P 1 3 4 2 .

Select PET Color

DDB1 Dark Blue
DGN1 Green
DGY4 Dark Gray
DGY3 Medium Gray

D G Y 3 .

Select Bracket Paint

See page 435

P R 6

EMPOWER® Modesty Panels/End of Run Screens

GSA SIN 33721



Icon Legend on page 19

WORKSTATIONS

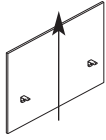

DESCRIPTION

MODEL

SHIP WEIGHT CUBE

LIST PRICE BY LAMINATE GRADE

Single-Side Laminate End of Run Screens

Single — 24"W x 26"H
 Single — 24"W x 34"H
 Single — 30"W x 26"H
 Single — 30"W x 34"H

HMPLM2426
HMPLM2434
HMPLM3026
HMPLM3034

16.9 2.2
 20.9 2.8
 20.5 2.7
 25.5 3.4

\$249 **\$260**
\$273 **\$284**
\$283 **\$294**
\$312 **\$323**

NOTES: 24"W and 48"W models used on 24"D Worksurfaces and 30"W and 60"W models are used on 30"D Worksurfaces. Vertical grain.

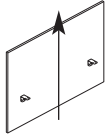

Double-Side Laminate End of Run Screens

Double — 48"W x 26"H
 Double — 48"W x 34"H
 Double — 60"W x 26"H
 Double — 60"W x 34"H

HMPLM4826
HMPLM4834
HMPLM6026
HMPLM6034

30.9 4.1
 38.9 5.2
 38.1 5.1
 48.3 6.4

\$264 **\$375**
\$397 **\$408**
\$491 **\$502**
\$533 **\$544**

NOTES: 24"W and 48"W models used on 24"D Worksurfaces and 30"W and 60"W models are used on 30"D Worksurfaces. Vertical grain.

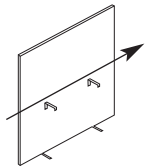

Double-Side Laminate Gallery Panel for Height Adjustable

48"W x 50"H
 60"W x 50"H

HMPLGP4850
HMPLGP6050

82.0 6.6
 100.0 9.2

\$822 **\$833**
\$909 **\$920**

NOTES: Horizontal grain.

NOTES:

- End of run screens sit -1" inset on each side of the depth of the run.
- Static end of run screens are 13" below the surface and either 13"H or 20"H above the surface.
- Height adjustable end of run screens extend to the floor and are 50"H.

HOW TO SPECIFY

Select Model Number

H M P L G P 4 8 5 0 .

Select Laminate Color

See page 435

P I N C P I N C .

Select Paint Color

Bracket paint must be specified

T 1

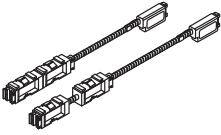
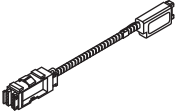
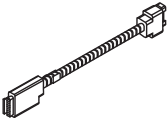
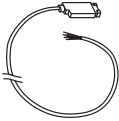
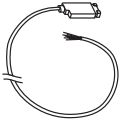
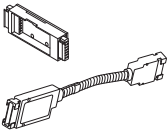
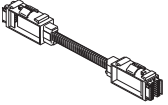

DESCRIPTION	MAX. RECEPT. CAP. PER PANEL SIDE	MODEL		SHIP WEIGHT	CUBE	LIST PRICE
		FOUR-CIRCUIT 3 + 1 2 + 2	THREE-CIRCUIT, SEPARATE NEUTRALS			
 <p>Electrical Power Harnesses, Frames — w/duplex capacity For 48"W 2 For 60"W 2 For 72"W 2</p>		HH871248 ☉	HH871248A	3.0 ☉	0.5	\$286
		HH871260 ☉	HH871260A	3.0 ☉	0.5	\$286
		HH871272	HH871272A	5.0 ☉	0.5	\$286
 <p>Electrical Pass-Thru Cables, Frames — w/duplex capacity For 48"W 1 For 60"W 1 For 72"W 1</p>		HH871148 ☉	HH871148A	2.5 ☉	0.5	\$181
		HH871160 ☉	HH871160A	3.0 ☉	0.5	\$181
		HH871172	HH871172A	5.0 ☉	0.5	\$181
 <p>Electrical Pass-Thru Harness without Power Block For 24"W Frames 0 For 48"W Frames 0 For 60"W Frames 0 For 72"W Frame Runs 0</p> <p>! 24" Pass-Thru Harness without Power Block is only used when specifying Power In-Feed with Sealtight as a floor in-feed. Harness is not needed for the standard in-feed.</p>		HH871024	HH871024A	2.0 ☉	0.5	\$159
		HH871048	HH871048A	3.0 ☉	0.5	\$164
		HH871060	HH871060A	3.0 ☉	0.5	\$164
		HH871072		4.0 ☉	0.5	\$227
 <p>Power In-Feed — Sealtight 144" long conduit, Sealtight Cable — 7/8" diameter</p> <p>NOTES: For use as ceiling, floor and wall in-feed. If three-circuit, separate neutral in-feed is required, please contact Tailored Solutions.</p>		HMP144		7.0	1.2	\$438
 <p>Metal Flexible Conduit 144" long conduit, Flex Cable — 7/8" dia.</p> <p>NOTES: Metal Flexible Conduit. Best option for use with power pole due to bend radius flexibility.</p>		HH871912 ☉		4.0 ☉	0.5	\$315
 <p>Power Jumper For End of Run</p>		HMPJUMP		2.0	0.3	\$226
 <p>End of Run Electrical Kit 48"W 60"W 72"W</p>		HMPEEK48		3.0	0.5	\$298
		HMPEEK60		3.0	0.5	\$298
		HMPEEK72		5.0	0.5	\$298

HOW TO SPECIFY

Select
Model Number

HH871248

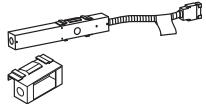

Use when local codes require

DESCRIPTION	MODEL		SHIP WEIGHT	CUBE	LIST PRICE
	FOUR-CIRCUIT 3 + 1 2 + 2	THREE-CIRCUIT, SEPARATE NEUTRALS			
Hardwire Applications Hardwire Power In-feed	HH871400 *	HH871400A *	4.0	0.3	\$296
! Customer to furnish all cabling and wiring from power entry to power source (approved for use by city of New York).					
Hardwire Junction Box (6-pack)	HH871500		4.5	0.1	\$629
! Hardwire Junction Boxes cannot be installed back-to-back in panel applications.					
! Contact Tailored Solutions for back-to-back Junction Box standard special number.					



Each marked with
Circuit Number

DESCRIPTION	MODEL	SHIP WEIGHT	CUBE	LIST PRICE
Duplex Receptacles Circuit 1	HH871501 ☉ HH871501A	1.0	0.5	\$58
Circuit 2	HH871502 ☉ HH871502A	1.0	0.5	\$58
Circuit 3 (except 2 + 2 — see below)	HH871503 ☉ HH871503A	1.0	0.5	\$58
Circuit 4 — isolated, dedicated circuit	HH871504 ☉	1.0	0.5	\$58
Circuit 1 (20 amp outlet configuration)	HH871601	1.0	0.5	\$58
Circuit 3 (2 + 2)	HH871506	1.0	0.5	\$58

Specify Paint. Charcoal (S) matches Empower trough.

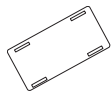

DESCRIPTION	MODEL	SHIP WEIGHT	CUBE	LIST PRICE
Receptacle Cover Replacements Quantity 25	HEREPCVVR	1.0	0.1	\$97
! Specify Color—Available in Black (P) and Muslin (T3) only.				

NOTES:

- ! Customer must furnish conduit, wiring and designer type receptacles. (Approved for use by city of Chicago.)
- ! Junction boxes cannot be used back-to-back.
- * De-emphasized.

Duplex Color Recommended to Coordinate with Paint Color			
Paint Color	Paint Code	Duplex Color	Duplex Code
Black	P	Black	P
Brownstone	P7D	Brownstone	EY
Charcoal	S	Charcoal	S
Designer White	PJW	Designer White	DW
Fossil	P28	Charcoal	S
Greige	T5	Muslin	T3
Light Gray	Q	Loft	LOFT
Loft	LOFT	Loft	LOFT
Muslin	T3	Muslin	T3
Putty	L	Black	P
Silver	PR6	Titanium	TI
Titanium	P8T	Titanium	TI
Champagne Metallic	T4	Muslin	T3
Platinum Metallic	T1	Titanium	Ti

HOW TO SPECIFY

<p>Select Model Number</p> <p>HH871400 . P</p>	<p>Select Paint Color</p> <p>See page 435</p>
--	---



EMPOWER® Electrical Accessories

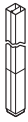

DESCRIPTION

Power Pole
10'5"

MODEL

HMPPP125

SHIP WEIGHT

14

CUBE

0.7

LIST PRICE

P1

\$613

NOTES: Power Pole ships with bracket to attach under stationary Empower® worksurfaces and feed directly into the Wire Management Trough. Power Pole will run to the floor on height adjustable Empower®.



DESCRIPTION

Vertebrae

MODEL

HMPVWM28

SHIP WEIGHT

3.0

CUBE

0.3

LIST PRICE

\$294

NOTES: 30"H x 3 3/8"W x 1 1/2"D. Ships unassembled. For additional information see page 727. For use with stationary Empower®.

! Clear finish. Specify "X" for finish option.

SPECIFYING EXAMPLE: HMPVWM28.X

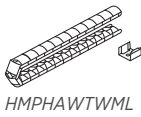

HMPHAWTWML



HMPHATFWML

Wire Managers for Height Adjustable

Workstation to Trough
Trough to Floor

HMPHAWTWML

3.0

0.1

\$354

HMPHATFWML

2.0

0.3

\$309

! Wire Manager Workstation to Trough only available in black.

! HMPHATFWML Trough to Floor cable manager is 3" x 1 1/2".

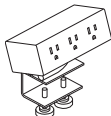

Model HPWRMOD3WC shown

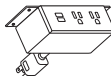

Model HPWRMOD2UWM shown

Power Modules

- 3 Receptacles with Worksurface Clamp
- 3 Receptacles with Under-Worksurface Mounting Bracket
- 2 Receptacles 2 USB with Worksurface Clamp
- 2 Receptacles 2 USB with Under-Worksurface Mounting Bracket
- 6' power cord with standard three-prong plug.
- Under-worksurface mounting bracket models work with any top that has a 5" x 5" square clearance.
- Worksurface clamp models work on any top with a 4" overhang.
- UL Listed.

HPWRMOD3WC

2.3 **Ⓢ**

0.2

\$409

HPWRMOD3UWM

2.3

0.2

\$409

HPWRMOD2WC **Ⓢ**

2.3

0.2

\$652

HPWRMOD2UWM

2.3

0.2

\$652

NOTES: For additional information see page 724.

! Color finish coordinates with HON's Charcoal or White. Specify STRM for Storm or SNW for Snow when ordering. Example: HPWRMOD3WC.STRM.

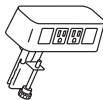

Power & Data Center

- 2 Receptacles 2 Data Accessory
- Standard with two receptacles and openings for two data ports.
- 6' power cord with standard three-prong plug.
- Fits on any worksurface with a 4" overhang.
- UL Listed.

HCOMDOME2

2.5 **Ⓢ**

0.2

\$391

NOTES: For additional information see page 724.

! Color finish coordinates with HON's Loft. Specify LOFT when ordering. Example: HCOMDOME2.LOFT

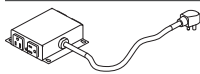

Under Worksurface Power Module — 4 Outlets, 10' Cord

HPWRMOD2

1.5 **Ⓢ**

0.2

\$528

- Includes 10' cord with three-prong plug.
- Fits in cable management troughs. See page 540.
- 4 outlets on side create easy access.

NOTES: Power Modules will also work with standing-height applications for 10500 Series™ and Voi® desks. Mounting Clearance: 5.025" x 4.875" x 1.375". For additional information see page 724.

! Black finish only, no specification needed.

HOW TO SPECIFY

Select Model Number

H M P P P 1 2 5 .

Select Finish Color

- STRM** Storm
- SNW** Snow
- LOFT** Loft

Specify Loft finish for HCOMDOME2 only

S T R M

GALLERY PANELS

Want to see more? Scan here
to check out hon.com.



WORKSTATIONS



Gallery Panels shown with Abound® Systems, Preside® Team Touchdown Table, and Flock® Seating.

GALLERY PANELS

Sometimes, simplicity is stellar. Gallery Panels offers streamlined cohesion for Abound® and Accelerate® products — their straightforward design allows you to customize and engineer your space to best support your productivity and privacy. And with a variety of sleek finishes to choose from, you'll keep things stylish too.



FEATURES

- Complete a cohesive workstation with Abound® and Accelerate® solutions.
- Get the right fit with true-to-size panel width.
- Customize your look with a variety of woodgrain and solid laminate finishes.
- Choose from matching or contrasting edge colors for a unique aesthetic.
- Accessories add extra organization and functionality to Gallery Panels.

GALLERY PANELS ORDERING INFORMATION

GALLERY PANELS

L1 LAMINATES CODES

Woodgrain

- ◆ Bourbon Cherry H
- ◆ Cognac COGN
- ◆ Field Elm LWFE
- ◆ Florence Walnut LFW1
- ◆ Harvest C
- ◆ Kingswood Walnut LK11
- ◆ Mahogany N
- ◆ Mocha MOCH
- ◆ Natural Maple D
- ◆ Pinnacle PINC
- ◆ Shaker Cherry F
- ◆ Sterling Ash LSA1

Solid

- ◆ Black P
- ◆ Charcoal S
- ◆ Designer White LDW1
- ◆ Loft LOFT

Patterned

- ◆ Handspun Chestnut LAHC
- ◆ Handspun Dove LAHD
- ◆ Handspun Pearl LAHP
- ◆ Handspun Slate LAHS
- ◆ Silver Mesh B9

L2 LAMINATES CODES

Woodgrain

- ◆ Beigewood LWBE
- ◆ Fawn Cypress LFC1
- ◆ Lowell Ash LLA1
- ◆ Natural Recon LNRI
- ◆ Phantom Ecru LPE1
- ◆ Portico Teak LPT1
- ◆ Skyline Walnut LSW1

CONNECTORS, ACCESSORIES, HAT TIE-IN BRACKETS

PAINT CODES

P1

- ◆ Black P
- ◆ Brownstone P7D
- ◆ Charcoal S
- ◆ Cove P096
- ◆ Designer White PJW
- ◆ Dune P094
- ◆ Fossil P28
- ◆ Greige T5
- ◆ Harbor P097
- ◆ Light Gray Q
- ◆ Loft LOFT
- ◆ Muslin T3
- ◆ Putty L
- ◆ Sage P095
- ◆ Titanium P8T

P2

- ◆ Champagne Metallic T4
- ◆ Gunmetal Metallic PR3
- ◆ Platinum Metallic T1
- ◆ Silver PR6
- ◆ Solar Black P8X

GALLERY PANEL FEET

PAINT CODES

P1

- ◆ Textured Brownstone P7J
- ◆ Textured Charcoal P7A
- ◆ Textured Designer White .. PJW
- ◆ Textured Loft P7L
- ◆ Textured Muslin P7M

P2

- ◆ Textured Silver PR8

◆◆◆ For lead time information see page 21.

GALLERY PANELS

Statement of Line

GALLERY PANELS

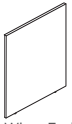

Wing; End of Run, Middle, Spanning End of Run

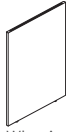

Wing Accepts Glass; End of Run, Middle, Spanning End of Run

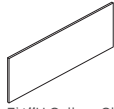

7/8" H Gallery Glass



Gallery-to-Gallery, L-Connection

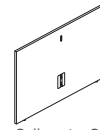

Gallery-to-Gallery, T-Connection

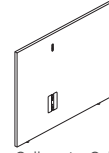

Gallery-to-Gallery, Non-Symmetrical Connection

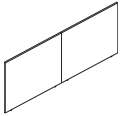

Split Gallery Panel — Abound*

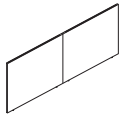

Split Gallery Panel, Accepts Glass — Abound*

CONNECTORS

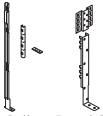

Gallery Panel Connectors — Abound*



Split Gallery Panel Connector — Abound*



Gallery Connector ("Block and Trim" Kit) — Abound*



Gallery Panel Mid Connector, Single-Sided — Accelerate*



Gallery Panel Mid Connector, Double-Sided — Accelerate*



Gallery Panel End Connector — Accelerate*



Spanning End of Run Connector with Glass — Accelerate*



Gallery to Metal/Laminate Kits

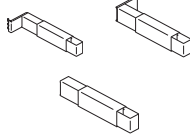

Height Adjustable Tie-In Brackets

ACCESSORIES



Accessory Rail



Hanging Markerboard



Rail Mounted Coat/Bag Hook

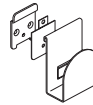

Face Mounted Coat/Bag Hook

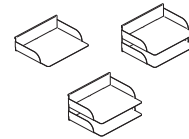

Rail Mounted Paper Shelf

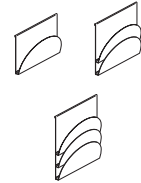

Rail Mounted Angle File

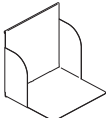

Rail Mounted Binder Shelf

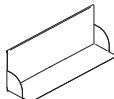

Rail Mounted Wide Personal Shelf

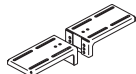

Gallery Countertop Kit

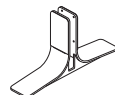

Gallery Panel Foot

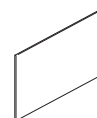

Markerboard

GALLERY PANELS

Overview

GALLERY PANELS

Gallery Panels are an affordable, sleek way to incorporate laminate wing and end of run panels where power is not needed. The simplistic design provides a great new way to add woodgrains or solid laminate finishes to your workstation allowing for greater customization and value engineering.

BASIC CHARACTERISTICS

- Available in L-, T-, and Mid-configurations.
- Made of 1½" board with high-pressure laminate.
- Use 1½" thickness for space planning.
- Can be specified with matching or contrasting edge colors.
- Available in woodgrain and solid laminates.
- Woodgrain laminates can be specified with vertical grain on panels from 24" to 60"W.
- Horizontal grain available on all panel sizes.
- Gallery Panels offer 2½" leveling capacity.
- Overall heights line up with adjacent panel.
- Available with and without integrated glass options (specified separately).
- Gallery Panels for use with glass have separate model numbers.
- All configurations are non-handed and secured using hidden fasteners.
- Standard Gallery Panels cannot connect to each other, you must use Gallery-to-Gallery Panels for connections.
- Additional support is required after every 60" in Gallery Panel width (i.e., storage or workstation tie-in).
- Gallery Panel widths are true to size.
- Please adhere to all standard systems specification guides.

GALLERY PANELS

Overview

GALLERY PANELS DIMENSIONS

Gallery Panel Widths

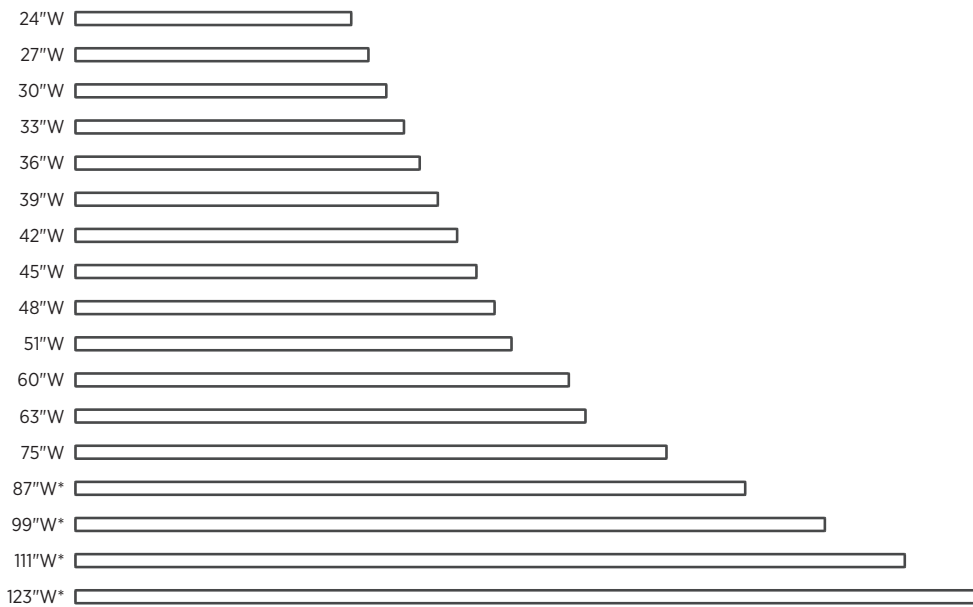

Gallery Panel Heights

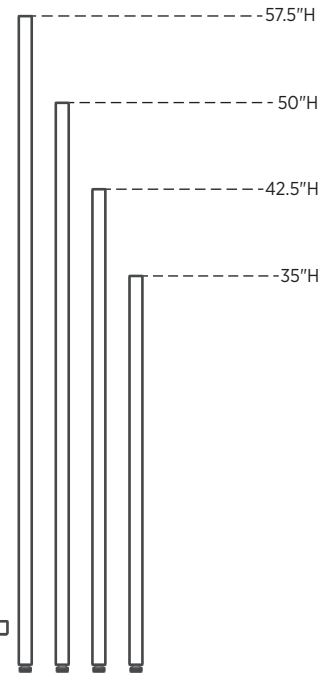

* Available on Abound® applications only.

WORKING WITH INTEGRATED GLASS

- Gallery Panels for use with glass offer a routed top edge.
- Glass mounts directly into the Gallery Panel route via a gasket.
- The routing is inset 1½" from each end of the panel on standard Gallery Panels.
- Total glass width will be 3" narrower than the Gallery Panel.
- Glass height is available in 7½"H.
- Glass is available on all Gallery Panel widths.
- Specify glass models separate from Gallery Panel models.
- Routing is inset ½" on L and T Gallery Panels.

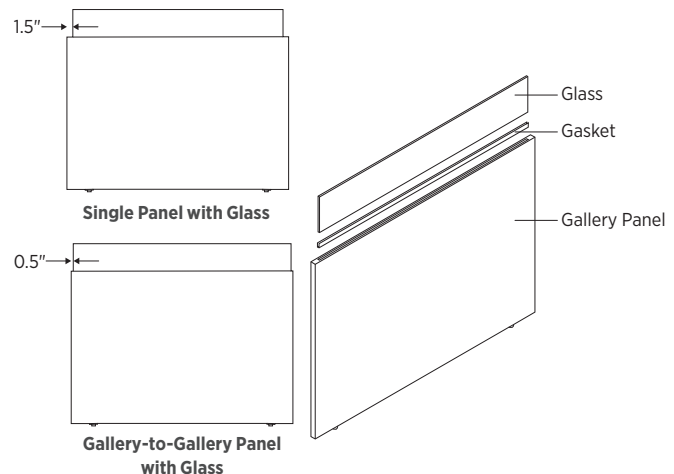

GALLERY PANEL STIFFENER

- Required for single-piece panels 75" used in wing or single-sided end condition and do not have horizontally-mounted credenza.
- Attaches directly to one side of the Gallery Panel with a painted metal cover.
- Placement on panel face must be at least 18" above the floor.
- Stiffener is 1½" x 1½".
- Available in HON standard paint options.

GALLERY PANELS

Working with Abound®

T-CONFIGURATION

- Provides privacy to one or both ends of the Abound® system in a dual-sided application.
- Single piece T-configurations connect using HRVCE connector kit. Split T-configurations connect using HRVCES connector kit.
- All T-configurations connect using HRVCE connector kit.
- When the system panel is higher than the Gallery Panel, a variable height system's trim must be specified to finish off the exposed frame.
- T-configuration can be used for off-modular planning. The HRVCE connector kit location must be field measured.
- Accommodate for 2⁵/₈" frame thickness when planning with Abound® panel system.

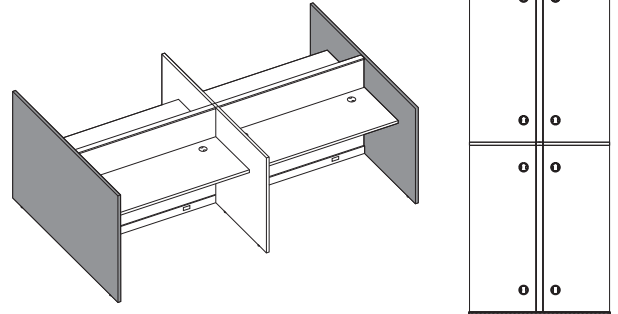

L-CONFIGURATION

- Provides privacy to one or both ends of the system in a single-sided application.
- L-configuration caps over the system panel.
- Due to the thickness of the Abound® panel L-configuration overhangs by approximately 3¹/₁₆" on both sides.
- Accommodate for 2⁵/₈" frame thickness planning with Abound® panel system.
- All L-configuration Gallery Panels require the connector kit HRVCE to attach to the parent run.
- When the system panel is higher than the Gallery Panel, the variable height system's trim must be specified to finish off exposed frame.

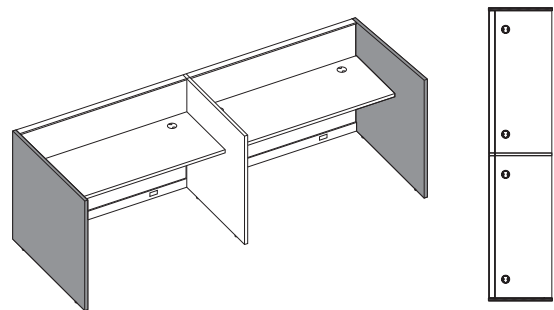

MID-CONFIGURATION (SINGLE-SIDED OR DUAL-SIDED)

- Mid-configuration panel does not overlap parent system panel.
- When specifying mid-configuration panels, one Gallery Panel "block and trim" kit (HRVCXXGP) is required to space the system panels out 1¹/₈". Kits include: Connector blocks, vertical trim, and a top cap.
- "Block and trim" models must match the height of the parent run.
- Specify one mid-connector kit (HRVCM) per Gallery Panel to attach to parent run. Gallery Panel and mid-connector kit attach over "block and trim" kit. Dual-sided application requires two connector kit models.
- When using a mid-configuration Gallery Panel, both panel frames in the spine must be of equal height.
- Mid-configuration Gallery Panel may exceed the height of the parent run by a maximum of 15".
- Trims can be painted to match the system panel trims.



GALLERY PANELS

Working with Accelerate®

T-CONFIGURATION

- Provides privacy to one or both ends of the Accelerate® system in a dual-sided application.
- Use HEGPE connector kit for T-configurations without glass; HEGSFGA for configurations with glass.
- End Gallery Panels cannot be shorter than the spine panel.
- T-configuration can be used for off-modular planning. The HRVCE connector kit location must be field measured.
- Accommodate for 2½" frame thickness when planning with Accelerate® panel system.

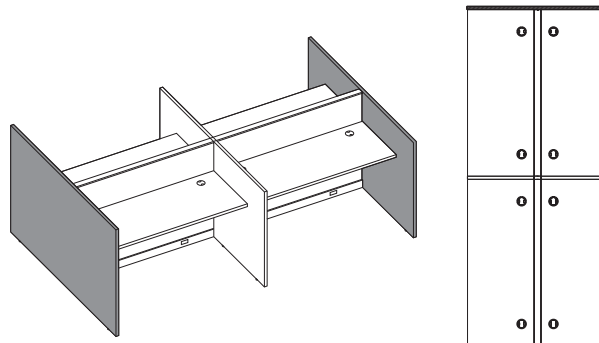

L-CONFIGURATION

- Provides privacy to one or both ends of the system in a single-sided application.
- L-configuration caps over the system panel.
- Due to the thickness of the Accelerate® panel L-configuration overhangs by approximately 7/8" on both sides.
- Accommodate for 2½" frame thickness planning with Accelerate® panel system.
- End Gallery Panels cannot be shorter than the spine panel.
- L-configurations both with and without glass connect with HEGPE connector kit.
- When using stackers on spine, fixed worksurfaces with cantilevers must be tied into Gallery Panels.

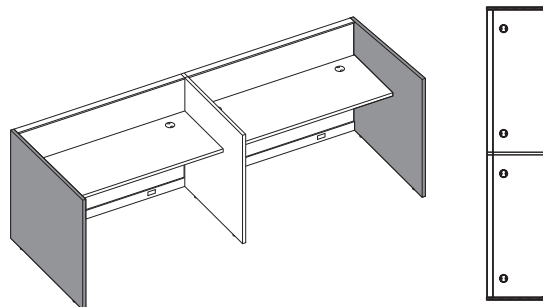

MID-CONFIGURATION (SINGLE-SIDED OR DUAL-SIDED)

- Mid-configuration panel does not overlap parent system panel.
- When specifying mid-configuration panels, one Gallery Panel Mid Connector HEGMCXXX is required to space the system panels out 1½".
- Mid connector models must match the height of the parent run.
- Mid Connectors are available for single- and double-sided applications.
- When using a mid-configuration Gallery Panel, both panel frames in the spine must be of equal height.
- Mid-configuration Gallery Panel may vary in height from the parent run by a maximum of 15".
- Trims can be painted to match the system panel trims.

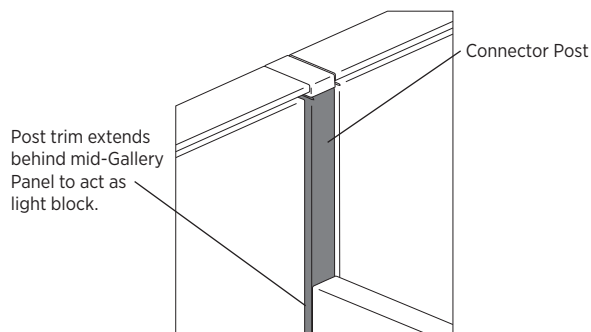

GALLERY PANELS Overview

STORAGE AND WORKSURFACE CONNECTORS

- Use HRVGLSK to connect to laminate storage or HRVGMSK for metal storage.
- To connect to worksurfaces use HSTB2W1 bracket when used in perpendicular to parent run or use standard systems cantilever brackets when used in parallel to parent run in panel systems.

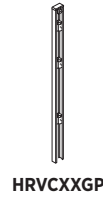
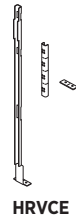

PANEL SYSTEMS

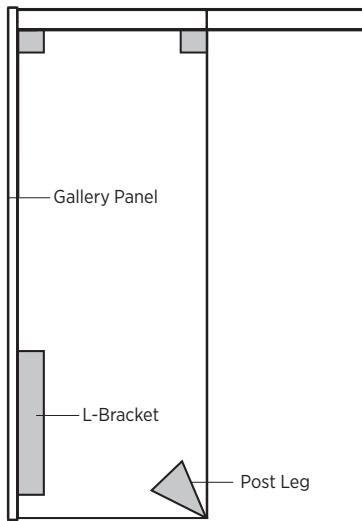

Perpendicular panel system with L-bracket (HSTB2W1) and post leg.

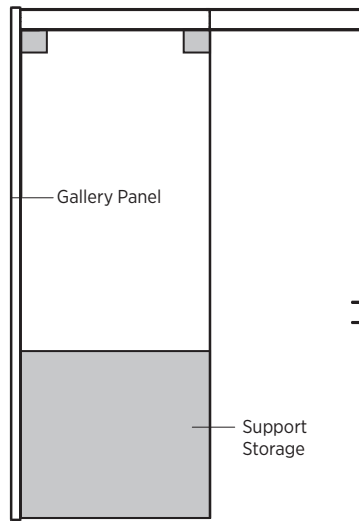

Perpendicular panel system with storage support.



Panel system with cantilever support.

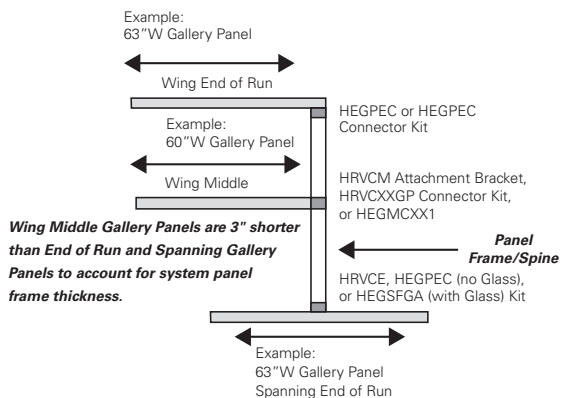

GALLERY PANELS

Overview

GALLERY-TO-GALLERY PANELS

- Gallery-to-Gallery Panels connect to other Gallery Panels and are available in L-, T-, and Non-symmetrical T-configurations.
- When specifying Gallery-to-Gallery Panels, the installation template HRVGTGG is required. The recommendation is one template for every 30 panels.
- Gallery-to-Gallery Panels must be of equal or lower height than the Standard Gallery Panel attached. The Gallery-to-Gallery Panel cannot be taller than the adjacent panel. If this is needed, please reach out to Tailored Solutions for a custom solution.
- Made of 1 $\frac{1}{8}$ " board with HPL laminate.
- Can be specified with matching or contrasting edge.
- Edgeband is 2mm ABS.
- Available in woodgrain and solid laminates.
- Woodgrain laminates can be specified with vertical grain up to 48"W.
- Gallery-to-Gallery Panel widths are available in 18", 24", 30", 36", 42", 48", 60"W, and 72" (T).
- Gallery Panels offer 2 $\frac{1}{2}$ " leveling capability.
- Overall heights line up with adjacent panel.
- Gallery-to-Gallery Panels cap over Standard Gallery Panels and are oversized by 1 $\frac{1}{8}$ " to maintain true interior dimensions.
- Available with or without the integrated glass option.
- Glass is specified separately. Use mid-connection glass.
- Gallery Panels for use with glass have separate model numbers.
- Gallery-to-Gallery Panels are secured with an inset flat bracket under a painted metal cover. Paint color is specifiable to blend in with laminate choice.
- L-panels are handed.
- Non-symmetrical T-panels vary in size on either side of the adjacent panel.
- Please adhere to all standard systems specification guidelines.
- Additional support is required after every 60" in Gallery Panel width (i.e., a storage or worksurface tie-in).

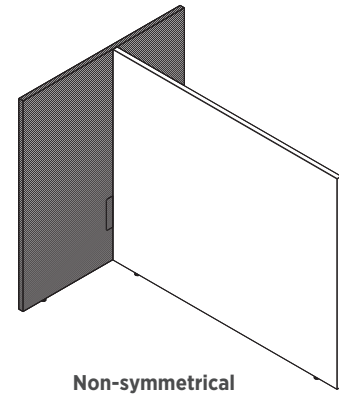
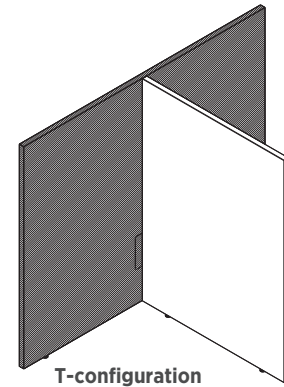
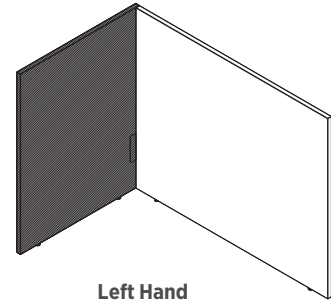

GALLERY PANELS

Overview

GALLERY-TO-GALLERY FREESTANDING SCREENS

Freestanding screens can be created using Standard Gallery Panels and Gallery-to-Gallery Panels. All Gallery Panel heights are allowed. Increase minimum return length by 3" (or next largest width) of panel for every 7½" variation in panel height.

Freestanding L-Screens

Parent	Minimum Return*
30"-36"	30"
>42"-60"	36"
60"-75"	42"

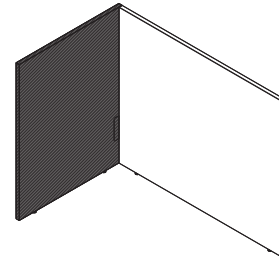
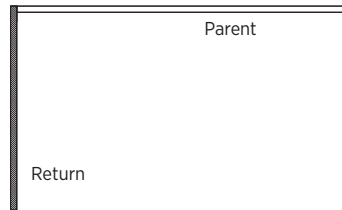

* 18"-24" not valid

Freestanding U-Screens

Parent	Minimum Return*
24"-48"	24"
60"-75"	30"

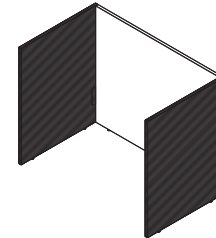
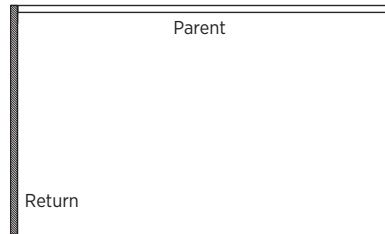

* 18"-24" not valid

Freestanding T-Screens

Parent	Minimum Return*
30"-75"	30"
36"-75"	36"
42"-72"	42"

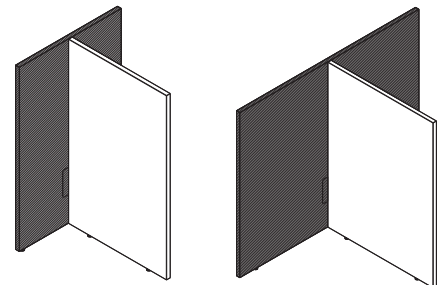

* 18"-24" not valid

Freestanding H-Screens

Freestanding T (Dual-Sided)	
Parent	Minimum Return
30"-60"	18"

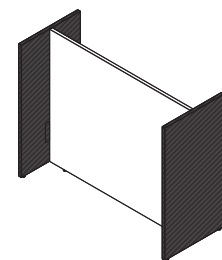
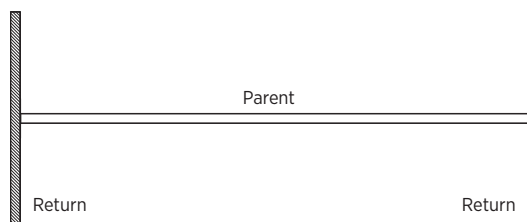

NOTES: Increase minimum return length by 3" or next largest width of panel for every 7½" variation in panel height.

GALLERY PANELS

Working with Accessories

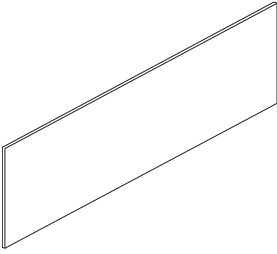

TACKBOARDS

- Provides tackable surface.
- Comes with steel-painted trim.
- Available in the following heights: 15", 22½".
- Available in the following widths: 24", 30", 36", 48", 60".
** Nominal widths, true width is undersized by ½".*
- Depth of ½".
- Mounts directly to Gallery Panel. Mounting hardware included. Installing will deface the panel.

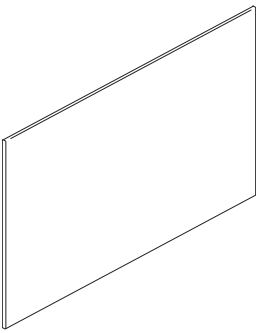

MAGNETIC SURFACE OR MARKERBOARDS

- Provides writable and magnetic surface when painted in markerboard paint. Provides magnetic, non-writable surface when painted in other HON paint colors.
- Available in the following sizes: 15"H x 24"W and 30"H, 22½"H x 36"W, 48"W, and 60"W.
** Nominal widths, true width is undersized by ½".*
- Depth of ½".
- Mounts directly to Gallery Panel. Mounting hardware included. Installing will deface the panel.

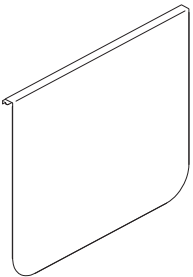

HANGING MAGNETIC SURFACE OR MARKERBOARD

- Hangs over Gallery Panel or sits on top of worksurface.
- Provides writable and magnetic surface when painted in markerboard paint. Provides magnetic, non-writable surface when painted in other HON paint colors.
- Cannot be installed back-to-back when hanging in the same location.
- Available in 30"W and in two heights: 20"H and 26"H.

GALLERY PANELS

Working with Accessories

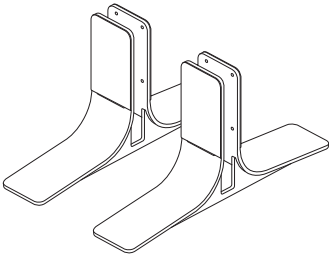

GALLERY PANEL FOOT

- Single foot provides rigidity to large wing panel.
- Using two feet on a single Gallery Panel allows for a freestanding application on panels greater than 24"W.
- Available in standard HON paints.
- Foot extends 9" from either side of the panel.

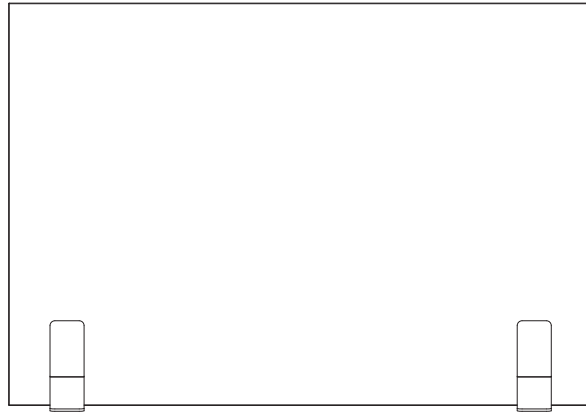
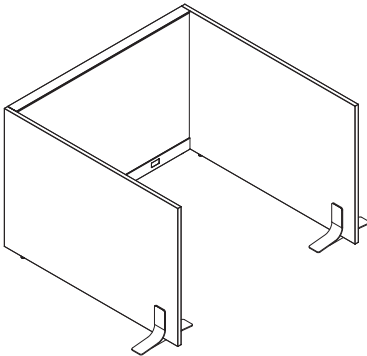

Up to 6"

Standard foot placement is over the leveling glide and limits leveling capabilities.

Feet may be installed anywhere from outer panel edge to 6" inset (to outside of foot) to avoid interference.

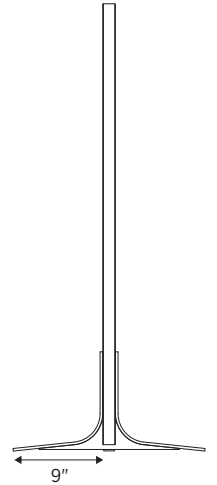

WALL START

- Wall Starts are 1/8" by 1/8" rectangular mounting posts that are meant to affix a Gallery Panel to a permanent building wall.
- Wall Starts add 1/8" to a panel run.
- Attachment hardware not included.
- Must be specified at the same height as the connecting panel.

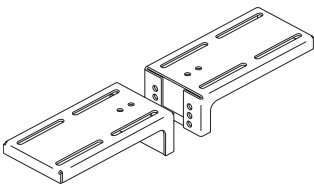

COUNTERTOP BRACKETS

- Includes attachment hardware.
- Countertops are flush with the top of the panel and can be flush with the ends of the panel or shorter than the panel width.
- For straight countertops, two countertop brackets must be ordered.
- For corner countertops, three countertop brackets must be ordered.
- Will deface the Gallery Panel.
- May be used in conjunction with Stride, Terrace, or Optimize panels. When transitioning from a Panel spine to a Gallery Panel wing with a corner countertop, use countertop model of the panel system.

GALLERY PANELS

Working with Accessories

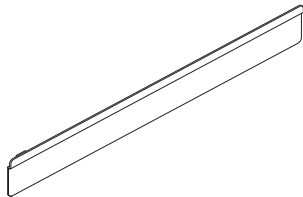

ACCESSORY RAIL AND PAPER MANAGEMENT

- Accessory Rail provides mounting for paper management accessories listed below.
- Rail is 2³/₈"H and is available in the following widths: 12", 18", 24", 30", and 36".
- Rails can be installed at any location on the Gallery Panel, as long as the rail does not extend beyond the top of the panel. Rails can be placed in-line to span panel length.
- Rails and accessories can be painted in any standard HON color.
- Mounts directly to the Gallery Panel, attachment hardware included. Installing will deface the panel.
- Fuse accessories are NOT compatible with the Accessory Rail.
- These accessories are compatible with panel system tool tiles.
- Includes a rail cover to hide hardware and provide magnetic surface.

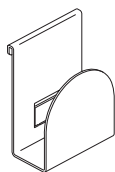

Coat Hook

- Rail-based, a mounted version also available to attach directly to the panel.
- Weight limit is 25 lbs.

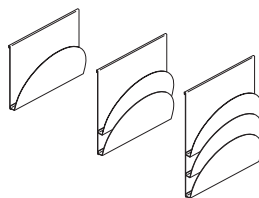

Angle File (Single, Dual, and Triple)

- Depth of 2"
- Heights:
Single = 9¹/₄"
Dual = 12¹/₄"
Triple = 15¹/₄"

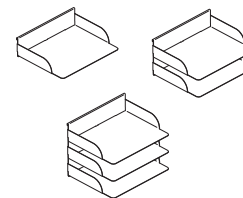

Paper Tray (Single, Dual, and Triple)

- Depth of 10"
- Heights:
Single = 3¹/₄"
Dual = 6¹/₄"
Triple = 9¹/₄"

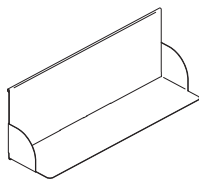

Personal Shelf

- 9¹/₄"H x 24"W x 6¹/₂"D
- Weight limit is 25 lbs.

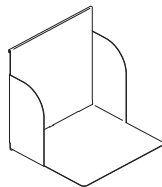

Binder Shelf

- 12¹/₄"H x 12"W x 11¹/₄"D
- Weight limit is 25 lbs.

NOTE: When accessory tools are attached to freestanding Gallery Panel screens, excess weight may affect overall panel stability.



GALLERY PANELS

Wing Panels

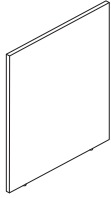

DESCRIPTION	MODEL	SHIP WEIGHT	CUBE	LIST PRICE BY LAMINATE GRADE	
				L1	L2
Gallery Panels					
35"H x 24"W	HRVG3524L	26.8	2.4	\$451	\$468
35"H x 27"W	HRVG3527L	30.1	2.5	\$475	\$493
35"H x 30"W	HRVG3530L	33.5	2.9	\$549	\$570
35"H x 33"W	HRVG3533L	36.8	3.0	\$577	\$599
35"H x 36"W	HRVG3536L	40.2	3.3	\$611	\$634
35"H x 39"W	HRVG3539L	43.6	3.6	\$653	\$679
35"H x 42"W	HRVG3542L	46.9	3.8	\$683	\$710
35"H x 45"W	HRVG3545L	50.3	4.1	\$724	\$753
35"H x 48"W	HRVG3548L	53.6	4.4	\$754	\$784
35"H x 51"W	HRVG3551L	57.0	4.6	\$781	\$812
35"H x 60"W	HRVG3560L	67.0	5.4	\$869	\$903
35"H x 63"W	HRVG3563L	70.4	5.7	\$888	\$923
35"H x 75"W	HRVG3575L	83.8	6.7	\$1078	\$1120
42"H x 24"W	HRVG4224L	38.5	2.6	\$487	\$506
42"H x 27"W	HRVG4227L	42.5	2.9	\$515	\$535
42"H x 30"W	HRVG4230L	46.0	3.3	\$594	\$617
42"H x 33"W	HRVG4233L	50.0	3.6	\$624	\$649
42"H x 36"W	HRVG4236L	54.0	3.9	\$663	\$690
42"H x 39"W	HRVG4239L	58.0	4.2	\$710	\$738
42"H x 42"W	HRVG4242L	62.0	4.5	\$739	\$768
42"H x 45"W	HRVG4245L	65.0	4.8	\$766	\$796
42"H x 48"W	HRVG4248L	69.5	5.1	\$797	\$829
42"H x 51"W	HRVG4251L	73.5	5.4	\$848	\$881
42"H x 60"W	HRVG4260L	85.0	6.3	\$928	\$964
42"H x 63"W	HRVG4263L	89.0	6.7	\$952	\$989
42"H x 75"W	HRVG4275L	104.5	7.9	\$1099	\$1142

NOTES:

- When specifying Wing End of Run panels, the Gallery Panels are 3" wider to allow for the panel to cover the width of the spine.
- Mid-configuration creates 1 1/8" space between the system panels. This gap matches the thickness of the Gallery Panel.
- Wing End of Run widths of 51", 63", and 75"W can be used as spanning end of run configurations.
- Gallery Panels come standard with two adjustable leveling glides.
- Gallery Panels require connectors to attach to the spine of the panel. See connectors on pages 495-496.
- Gallery Panels up to 60"W can specify vertical or horizontal woodgrain direction. Panels larger than 60"W will have horizontal woodgrain.
- ! Minimum panel length must be 50% of the Gallery Panel for stability.
- ! When system panel is higher than the Gallery Panel, system's variable height trim kit must be specified to finish off the exposed frame (Abound® only).
- ! Standard Gallery Panels can only connect to standard panel frames. Use Gallery-to-Gallery Panels to connect Standard Gallery Panels to other Gallery Panels.
- ! Gallery Panels longer than 60"W require a floor or storage support.
- ! 75"W Gallery Panels require use of Gallery Panel Stiffener model HRVGS7578.

HOW TO SPECIFY

<p>Select Model Number</p> <p>HRVG3527L</p>	<p>Select Laminate</p> <p>See page 467</p> <p>C</p>	<p>Select Edge</p> <p>See page 467</p> <p>C</p>	<p>Select Grain Direction</p> <p>VST</p> <p>VST Vertical Grain (not available on 63"W or wider) VLG Horizontal Grain and Solid Laminate only</p>	<p>Select Glide</p> <p>G</p> <p>G Glide</p>
--	--	--	---	--

GALLERY PANELS

Wing Panels

OPEN MARKET



Icon Legend on page 19

WORKSTATIONS

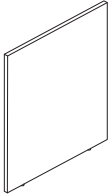

DESCRIPTION	MODEL	SHIP WEIGHT	CUBE	LIST PRICE BY LAMINATE GRADE	
				L1	L2
Gallery Panels					
50"H x 24"W	HRVG5024L	44.5	3.1	\$562	\$584
50"H x 27"W	HRVG5027L	49.0	3.5	\$592	\$615
50"H x 30"W	HRVG5030L	53.0	3.8	\$660	\$686
50"H x 33"W	HRVG5033L	58.0	4.2	\$692	\$720
50"H x 36"W	HRVG5036L	63.0	4.6	\$728	\$757
50"H x 39"W	HRVG5039L	67.5	4.9	\$772	\$803
50"H x 42"W	HRVG5042L	72.0	5.3	\$814	\$846
50"H x 45"W	HRVG5045L	77.0	5.6	\$873	\$907
50"H x 48"W	HRVG5048L	81.5	6.0	\$896	\$931
50"H x 51"W	HRVG5051L	86.0	6.4	\$918	\$954
50"H x 60"W	HRVG5060L	100.0	7.5	\$1011	\$1051
50"H x 63"W	HRVG5063L	104.5	7.8	\$1031	\$1071
50"H x 75"W	HRVG5075L	123.0	9.3	\$1195	\$1241
57½"H x 24"W	HRVG5724L	49.6	3.5	\$621	\$648
57½"H x 27"W	HRVG5727L	54.9	3.9	\$656	\$684
57½"H x 30"W	HRVG5730L	60.1	4.4	\$730	\$759
57½"H x 33"W	HRVG5733L	65.4	4.8	\$768	\$799
57½"H x 36"W	HRVG5736L	70.7	5.2	\$771	\$803
57½"H x 39"W	HRVG5739L	75.9	5.6	\$817	\$851
57½"H x 42"W	HRVG5742L	81.2	6.0	\$863	\$898
57½"H x 45"W	HRVG5745L	86.5	6.4	\$925	\$962
57½"H x 48"W	HRVG5748L	91.7	6.8	\$940	\$979
57½"H x 51"W	HRVG5751L	97.0	7.2	\$964	\$1004
57½"H x 60"W	HRVG5760L	112.8	8.5	\$1051	\$1094
57½"H x 63"W	HRVG5763L	118.1	8.9	\$1074	\$1118
57½"H x 75"W	HRVG5775L	139.1	10.6	\$1242	\$1293

NOTES:

- When specifying Wing End of Run panels, the Gallery Panels are 3" wider to allow for the panel to cover the width of the spine.
- Mid-configuration creates 1½" space between the system panels. This gap matches the thickness of the Gallery Panel.
- Wing End of Run widths of 51", 63", and 75"W can be used as spanning end of run configurations.
- Gallery Panels come standard with two adjustable leveling glides.
- Gallery Panels require connectors to attach to the spine of the panel. See connectors on pages 495-496.
- Gallery Panels up to 60"W can specify vertical or horizontal woodgrain direction. Panels larger than 60"W will have horizontal woodgrain.
- ! Minimum panel length must be 50% of the Gallery Panel for stability.
- ! When system panel is higher than the Gallery Panel, system's variable height trim kit must be specified to finish off the exposed frame (Abound® only).
- ! Standard Gallery Panels can only connect to standard panel frames. Use Gallery-to-Gallery Panels to connect Standard Gallery Panels to other Gallery Panels.
- ! Gallery Panels longer than 60"W require a floor or storage support.
- ! 75"W Gallery Panels require use of Gallery Panel Stiffener model HRVGS7578.

HOW TO SPECIFY

Select Model Number HRVG5024L	Select Laminate See page 467 C	Select Edge See page 467 C	Select Grain Direction VST Vertical Grain (not available on 63"W or wider) VLG Horizontal Grain and Solid Laminate only	Select Glide G Glide
---	---	---	--	--------------------------------



GALLERY PANELS

Split Panels

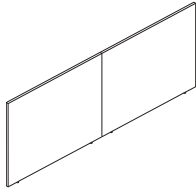

DESCRIPTION	MODEL	SHIP WEIGHT	CUBE	LIST PRICE BY LAMINATE GRADE	
				L1	L2
Split Gallery Panels, for Abound®					
35"H x 87"W	HRVG3587L	97.0	2.1	\$1131	\$1177
35"H x 99"W	HRVG3599L	110.6	14.0	\$1247	\$1298
35"H x 111"W	HRVG35111L	124.1	17.1	\$1369	\$1424
35"H x 123"W	HRVG35123L	137.5	17.1	\$1506	\$1565
42½"H x 87"W	HRVG4287L	120.0	13.7	\$1166	\$1214
42½"H x 99"W	HRVG4299L	135.6	13.7	\$1281	\$1333
42½"H x 111"W	HRVG42111L	151.1	13.7	\$1408	\$1464
42½"H x 123"W	HRVG42123L	166.6	13.7	\$1549	\$1609
50"H x 87"W	HRVG5087L	141.5	13.7	\$1256	\$1307
50"H x 99"W	HRVG5099L	160.0	13.7	\$1357	\$1412
50"H x 111"W	HRVG50111L	178.4	13.7	\$1465	\$1524
50"H x 123"W	HRVG50123L	196.9	13.7	\$1580	\$1643
57½"H x 87"W	HRVG5787L	160.2	15.8	\$1355	\$1407
57½"H x 99"W	HRVG5799L	181.3	15.8	\$1435	\$1491
57½"H x 111"W	HRVG57111L	202.4	15.8	\$1522	\$1582
57½"H x 123"W	HRVG57123L	223.4	19.0	\$1615	\$1679

NOTES:

- Gallery Panels come standard with two adjustable leveling glides.
- Gallery Panels require connectors to attach to the spine of the panel. See connectors on pages 495-496.
- Gallery Panels up to 60"W can specify vertical or horizontal woodgrain direction. Panels larger than 60"W will have horizontal woodgrain.
- ! Minimum panel length must be 50% of the Gallery Panel for stability.
- ! When system panel is higher than the Gallery Panel, system's variable height trim kit must be specified to finish off the exposed frame (Abound® only).
- ! Gallery Panels can only connect to standard panel frames; Gallery Panels cannot connect to each other.

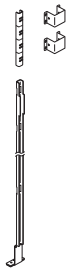

DESCRIPTION	MODEL	SHIP WEIGHT	CUBE	LIST PRICE BY PAINT GRADE		
				P1	P2	P3
Split Gallery Panel Connector For Abound® applications	HRVCES	2	0.1	\$99	\$107	\$119
NOTES: Specify paint, see page 467. SPECIFYING EXAMPLE: HRVCES.P						

HOW TO SPECIFY

<p>Select Model Number</p> <p>HRVG3599L</p>	<p>Select Laminate</p> <p>See page 467</p> <p>C</p>	<p>Select Edge</p> <p>See page 467</p> <p>C</p>	<p>Select Grain Direction</p> <p>VST Vertical Grain (not available on 63"W or wider) VLG Horizontal Grain and Solid Laminate only</p> <p>VST</p>	<p>Select Glide</p> <p>G Glide</p> <p>G</p>
--	--	--	---	--

GALLERY PANELS

Wing, Accepts Glass

OPEN MARKET



Icon Legend on page 19

WORKSTATIONS

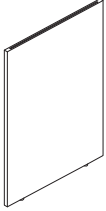

DESCRIPTION	MODEL	SHIP WEIGHT	CUBE	LIST PRICE BY LAMINATE GRADE	
				L1	L2
Gallery Panels, Accepts Glass					
35"H x 24"W	HRVG3524LG	26.8	2.4	\$619	\$644
35"H x 27"W	HRVG3527LG	30.1	2.5	\$644	\$670
35"H x 30"W	HRVG3530LG	33.5	2.9	\$718	\$746
35"H x 33"W	HRVG3533LG	36.8	3.0	\$747	\$776
35"H x 36"W	HRVG3536LG	40.2	3.3	\$782	\$813
35"H x 39"W	HRVG3539LG	43.6	3.6	\$824	\$856
35"H x 42"W	HRVG3542LG	46.9	3.8	\$853	\$886
35"H x 45"W	HRVG3545LG	50.3	4.1	\$894	\$929
35"H x 48"W	HRVG3548LG	53.6	4.4	\$923	\$959
35"H x 51"W	HRVG3551LG	57.0	4.6	\$947	\$984
35"H x 60"W	HRVG3560LG	67.0	5.4	\$1040	\$1080
35"H x 63"W	HRVG3563LG	70.4	5.7	\$1059	\$1100
35"H x 75"W	HRVG3575LG	83.8	6.7	\$1243	\$1292
42"H x 24"W	HRVG4224LG	38.5	2.6	\$657	\$683
42"H x 27"W	HRVG4227LG	42.5	2.9	\$684	\$711
42"H x 30"W	HRVG4230LG	46.0	3.3	\$763	\$793
42"H x 33"W	HRVG4233LG	50.0	3.6	\$794	\$825
42"H x 36"W	HRVG4236LG	54.0	3.9	\$831	\$864
42"H x 39"W	HRVG4239LG	58.0	4.2	\$877	\$912
42"H x 42"W	HRVG4242LG	62.0	4.5	\$909	\$945
42"H x 45"W	HRVG4245LG	66.0	4.8	\$935	\$972
42"H x 48"W	HRVG4248LG	69.5	5.1	\$965	\$1003
42"H x 51"W	HRVG4251LG	73.5	5.4	\$1015	\$1055
42"H x 60"W	HRVG4260LG	85.0	6.3	\$1096	\$1139
42"H x 63"W	HRVG4263LG	89.0	6.7	\$1121	\$1165
42"H x 75"W	HRVG4275LG	104.5	7.9	\$1265	\$1315

NOTES:

- When specifying Wing End of Run panels, the Gallery Panels are 3" wider to allow for the panel to cover the width of the spine.
- Mid-configuration creates 1/8" space between the system panels. This gap matches the thickness of the Gallery Panel.
- Wing End of Run widths of 51", 63", and 75"W can be used as spanning end of run configurations.
- Gallery Panels come standard with two adjustable leveling glides.
- Gallery Panels require connectors to attach to the spine of the panel. See connectors on pages 495-496.
- Gallery Panels up to 60"W can specify vertical or horizontal woodgrain direction. Panels larger than 60"W will have horizontal woodgrain.
- ! Minimum panel length must be 50% of the Gallery Panel for stability.
- ! When system panel is higher than the Gallery Panel, system's variable height trim kit must be specified to finish off the exposed frame (Abound® only).
- ! Standard Gallery Panels can only connect to standard panel frames. Use Gallery-to-Gallery Panels to connect Standard Gallery Panels to other Gallery Panels.
- ! Gallery Panels longer than 60"W require a floor or storage support.
- ! 75"W Gallery Panels require use of Gallery Panel Stiffener model HRVGS7578.

HOW TO SPECIFY

<p>Select Model Number</p> <p>HRVG3527LG</p>	<p>Select Laminate</p> <p>See page 467</p> <p>C</p>	<p>Select Edge</p> <p>See page 467</p> <p>C</p>	<p>Select Grain Direction</p> <p>VST Vertical Grain (not available on 63"W or wider) VLG Horizontal Grain and Solid Laminate only</p> <p>VST</p>	<p>Select Glide</p> <p>G Glide</p> <p>G</p>
---	--	--	---	--



GALLERY PANELS

Wing, Accepts Glass

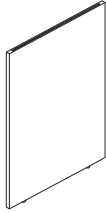

DESCRIPTION	MODEL	SHIP WEIGHT	CUBE	LIST PRICE BY LAMINATE GRADE	
				L1	L2
Gallery Panels					
50"H x 24"W	HRVG5024LG	44.5	3.1	\$729	\$758
50"H x 27"W	HRVG5027LG	49.0	3.5	\$760	\$790
50"H x 30"W	HRVG5030LG	54.0	3.8	\$828	\$861
50"H x 33"W	HRVG5033LG	58.0	4.2	\$862	\$896
50"H x 36"W	HRVG5036LG	63.0	4.6	\$897	\$932
50"H x 39"W	HRVG5039LG	67.5	4.9	\$940	\$977
50"H x 42"W	HRVG5042LG	72.0	5.3	\$983	\$1022
50"H x 45"W	HRVG5045LG	77.0	5.6	\$1041	\$1082
50"H x 48"W	HRVG5048LG	81.5	6.0	\$1041	\$1083
50"H x 51"W	HRVG5051LG	86.0	6.4	\$1086	\$1128
50"H x 60"W	HRVG5060LG	100.0	7.5	\$1179	\$1225
50"H x 63"W	HRVG5063LG	104.5	7.8	\$1200	\$1248
50"H x 75"W	HRVG5075LG	123.0	9.3	\$1364	\$1418
57½"H x 24"W	HRVG5724LG	49.6	3.5	\$759	\$791
57½"H x 27"W	HRVG5727LG	54.9	3.9	\$789	\$822
57½"H x 30"W	HRVG5730LG	60.1	4.4	\$865	\$901
57½"H x 33"W	HRVG5733LG	65.4	4.8	\$899	\$936
57½"H x 36"W	HRVG5736LG	70.7	5.2	\$933	\$971
57½"H x 39"W	HRVG5739LG	75.9	5.6	\$977	\$1017
57½"H x 42"W	HRVG5742LG	81.2	6.0	\$1026	\$1068
57½"H x 45"W	HRVG5745LG	86.5	6.4	\$1074	\$1118
57½"H x 48"W	HRVG5748LG	91.7	6.8	\$1083	\$1128
57½"H x 51"W	HRVG5751LG	97.0	7.2	\$1129	\$1175
57½"H x 60"W	HRVG5760LG	112.8	8.5	\$1222	\$1272
57½"H x 63"W	HRVG5763LG	118.1	8.9	\$1243	\$1294
57½"H x 75"W	HRVG5775LG	139.1	10.6	\$1414	\$1471

NOTES:

- When specifying Wing End of Run panels, the Gallery Panels are 3" wider to allow for the panel to cover the width of the spine.
- Mid-configuration creates 1½" space between the system panels. This gap matches the thickness of the Gallery Panel.
- Wing End of Run widths of 51", 63", and 75"W can be used as spanning end of run configurations.
- Gallery Panels come standard with two adjustable leveling glides.
- Gallery Panels require connectors to attach to the spine of the panel. See connectors on pages 495-496.
- Gallery Panels up to 60"W can specify vertical or horizontal woodgrain direction. Panels larger than 60"W will have horizontal woodgrain.
- ! Minimum panel length must be 50% of the Gallery Panel for stability.
- ! When system panel is higher than the Gallery Panel, system's variable height trim kit must be specified to finish off the exposed frame (Abound® only).
- ! Standard Gallery Panels can only connect to standard panel frames. Use Gallery-to-Gallery Panels to connect Standard Gallery Panels to other Gallery Panels.
- ! Gallery Panels longer than 60"W require a floor or storage support.
- ! 75"W Gallery Panels require use of Gallery Panel Stiffener model HRVGS7578.

HOW TO SPECIFY

<p>Select Model Number</p> <p>HRVG5024LG</p>	<p>Select Laminate</p> <p>See page 467</p> <p>C</p>	<p>Select Edge</p> <p>See page 467</p> <p>C</p>	<p>Select Grain Direction</p> <p>VST Vertical Grain (not available on 63"W or wider) VLG Horizontal Grain and Solid Laminate only</p> <p>VST</p>	<p>Select Glide</p> <p>G Glide</p> <p>G</p>
---	--	--	---	--

GALLERY PANELS

Split Panels, Accepts Glass

OPEN MARKET



Icon Legend on page 19

WORKSTATIONS

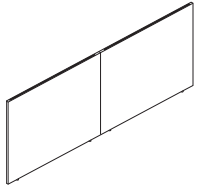

DESCRIPTION	MODEL	SHIP WEIGHT	CUBE	LIST PRICE BY LAMINATE GRADE	
				L1	L2
Split Gallery Panels, Accepts Glass, for Abound®					
35"H x 87"W	HRVG3587LG	97.2	2.1	\$1293	\$1348
35"H x 99"W	HRVG3599LG	110.6	14.0	\$1408	\$1469
35"H x 111"W	HRVG35111LG	124.1	17.1	\$1535	\$1602
35"H x 123"W	HRVG35123LG	137.5	17.1	\$1673	\$1747
42½"H x 87"W	HRVG4287LG	120.0	13.7	\$1318	\$1374
42½"H x 99"W	HRVG4299LG	135.6	13.7	\$1423	\$1485
42½"H x 111"W	HRVG42111LG	151.1	13.7	\$1566	\$1634
42½"H x 123"W	HRVG42123LG	166.6	13.7	\$1721	\$1796
50"H x 87"W	HRVG5087LG	141.5	13.7	\$1407	\$1467
50"H x 99"W	HRVG5099LG	160.0	13.7	\$1506	\$1572
50"H x 111"W	HRVG50111LG	178.4	13.7	\$1610	\$1683
50"H x 123"W	HRVG50123LG	196.9	13.7	\$1754	\$1833
57½"H x 87"W	HRVG5787LG	160.2	15.8	\$1501	\$1562
57½"H x 99"W	HRVG5799LG	181.3	15.8	\$1593	\$1660
57½"H x 111"W	HRVG57111LG	202.4	15.8	\$1656	\$1730
57½"H x 123"W	HRVG57123LG	223.4	19.0	\$1790	\$1870

NOTES:

- When specifying Wing End of Run panels, the Gallery Panels are 3" wider to allow for the panel to cover the width of the spine.
 - Mid-configuration creates 1/8" space between the system panels. This gap matches the thickness of the Gallery Panel.
 - Wing End of Run widths of 51", 63", and 75"W can be used as spanning end of run configurations.
 - Gallery Panels come standard with two adjustable leveling glides.
 - Gallery Panels require connectors to attach to the spine of the panel. See connectors on pages 495-496.
 - Gallery Panels up to 60"W can specify vertical or horizontal woodgrain direction. Panels larger than 60"W will have horizontal woodgrain.
- ❗ Minimum panel length must be 50% of the Gallery Panel for stability.
- ❗ When system panel is higher than the Gallery Panel, system's variable height trim kit must be specified to finish off the exposed frame (Abound® only).
- ❗ Standard Gallery Panels can only connect to standard panel frames. Use Gallery-to-Gallery Panels to connect Standard Gallery Panels to other Gallery Panels.
- ❗ Gallery Panels longer than 60"W require a floor or storage support.

DESCRIPTION	MODEL	SHIP WEIGHT	CUBE	LIST PRICE BY PAINT GRADE		
				P1	P2	P3
Split Gallery Panel Connector For Abound® applications	HRVCES	2	0.1	\$99	\$107	\$119
NOTES: Specify paint, see page 467. SPECIFYING EXAMPLE: HRVCES.P						

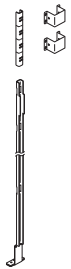

HOW TO SPECIFY

<p>Select Model Number</p> <p>HRVG3587LG</p>	<p>Select Laminate</p> <p>See page 467</p> <p>C</p>	<p>Select Edge</p> <p>See page 467</p> <p>C</p>	<p>Select Grain Direction</p> <p>VST Vertical Grain (not available on 63"W or wider) VLG Horizontal Grain and Solid Laminate only</p> <p>VST</p>	<p>Select Glide</p> <p>G Glide</p> <p>G</p>
---	--	--	---	--



GALLERY PANELS

Gallery-to-Gallery Connections

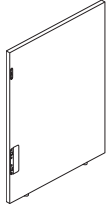

DESCRIPTION	MODEL	SHIP WEIGHT	CUBE	LIST PRICE BY LAMINATE GRADE	
				L1	L2
L-Connections, Right Hand					
35"H x 18"W	HRVG3518GGR	23.6	2.0	\$749	\$776
35"H x 24"W	HRVG3524GGR	30.5	2.6	\$807	\$836
35"H x 30"W	HRVG3530GGR	37.4	3.1	\$871	\$902
35"H x 36"W	HRVG3536GGR	44.3	3.6	\$934	\$967
35"H x 42"W	HRVG3542GGR	51.1	4.1	\$1002	\$1038
35"H x 48"W	HRVG3548GGR	58.0	4.7	\$1076	\$1115
35"H x 60"W	HRVG3560GGR	71.8	5.7	\$1155	\$1197
42"H x 18"W	HRVG4218GGR	28.5	2.4	\$778	\$806
42"H x 24"W	HRVG4224GGR	36.9	3.0	\$839	\$869
42"H x 30"W	HRVG4230GGR	45.3	3.7	\$904	\$936
42"H x 36"W	HRVG4236GGR	53.7	4.3	\$975	\$1010
42"H x 42"W	HRVG4242GGR	62.1	4.9	\$1055	\$1093
42"H x 48"W	HRVG4248GGR	70.5	5.6	\$1138	\$1179
42"H x 60"W	HRVG4260GGR	87.3	6.8	\$1223	\$1267
50"H x 18"W	HRVG5018GGR	33.4	2.8	\$839	\$869
50"H x 24"W	HRVG5024GGR	43.3	3.5	\$904	\$936
50"H x 30"W	HRVG5030GGR	53.2	4.3	\$975	\$1010
50"H x 36"W	HRVG5036GGR	63.1	5.0	\$1048	\$1086
50"H x 42"W	HRVG5042GGR	73.1	5.7	\$1123	\$1163
50"H x 48"W	HRVG5048GGR	83.0	6.5	\$1207	\$1251
50"H x 60"W	HRVG5060GGR	102.8	7.9	\$1297	\$1345
57½"H x 18"W	HRVG5718GGR	38.0	3.3	\$904	\$937
57½"H x 24"W	HRVG5724GGR	49.7	4.1	\$975	\$1010
57½"H x 30"W	HRVG5730GGR	61.1	5.0	\$1052	\$1090
57½"H x 36"W	HRVG5736GGR	72.6	5.8	\$1125	\$1167
57½"H x 42"W	HRVG5742GGR	84.0	6.6	\$1198	\$1242
57½"H x 48"W	HRVG5748GGR	95.5	7.4	\$1280	\$1329
57½"H x 60"W	HRVG5760GGR	118.4	9.1	\$1376	\$1428

NOTES:

- Gallery-to-Gallery Panels connect to other Gallery Panels and are available in L-, T-, and Non-symmetrical T-configurations.
- When specifying Gallery-to-Gallery Panels, the installation template (HRVGTGG) is required. The recommendation is one template for every 30 panels. Templates are reusable.
- Gallery-to-Gallery Panels must be of equal or lower height than the Standard Gallery Panel attached. The Gallery-to-Gallery Panel cannot be taller than the adjacent panel. If this is needed, please reach out to Tailored Solutions for a custom solution.
- Made of 1/8" board with HPL laminate.
- Woodgrain laminates can be specified with vertical grain up to 48"W. Horizontal grain is available on all sizes.
- Gallery Panels offer 2½" leveling capability.
- Overall heights line up with adjacent panel.
- Gallery-to-Gallery Panels cap over Standard Gallery Panels and are oversized by 1/8" to maintain true interior dimensions.
- Available with or without the integrated glass option.
- Glass specified separately, see 7½"H Gallery Glass on pages 493-494.
- Gallery Panels for use with glass have separate model numbers.
- Gallery-to-Gallery Panels are secured with an inset flat bracket under a painted metal cover.
- L-panels are handed.

HOW TO SPECIFY

<p>Select Model Number</p> <p>HRVG4236GGR</p>	<p>Select Laminate</p> <p>See page 467</p> <p>H</p>	<p>Select Edge</p> <p>See page 467</p> <p>H</p>	<p>Select Grain Direction</p> <p>VLG Horizontal Grain and Solid Laminate only VST Vertical Grain</p> <p>VLG</p>	<p>Select Paint Color</p> <p>See page 467</p> <p>P8T</p>	<p>Select Glide</p> <p>G Glide</p> <p>G</p>
--	--	--	--	---	--

GALLERY PANELS

Gallery-to-Gallery Connections

OPEN MARKET



Icon Legend on page 19

WORKSTATIONS

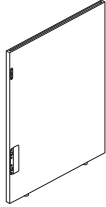

DESCRIPTION	MODEL	SHIP WEIGHT	CUBE	LIST PRICE BY LAMINATE GRADE	
				L1	L2
L-Connections, Right Hand, Accepts Glass					
35"H x 18"W	HRVG3518GGRG	23.6	2.0	\$864	\$895
35"H x 24"W	HRVG3524GGRG	30.5	2.6	\$933	\$966
35"H x 30"W	HRVG3530GGRG	37.4	3.1	\$1006	\$1042
35"H x 36"W	HRVG3536GGRG	44.3	3.6	\$1082	\$1121
35"H x 42"W	HRVG3542GGRG	51.1	4.1	\$1161	\$1203
35"H x 48"W	HRVG3548GGRG	58.0	4.7	\$1248	\$1293
35"H x 60"W	HRVG3560GGRG	71.8	5.7	\$1340	\$1389
42"H x 18"W	HRVG4218GGRG	28.4	2.4	\$884	\$916
42"H x 24"W	HRVG4224GGRG	36.9	3.0	\$955	\$989
42"H x 30"W	HRVG4230GGRG	45.3	3.7	\$1033	\$1070
42"H x 36"W	HRVG4236GGRG	53.7	4.3	\$1113	\$1153
42"H x 42"W	HRVG4242GGRG	62.1	4.9	\$1203	\$1246
42"H x 48"W	HRVG4248GGRG	70.5	5.6	\$1300	\$1348
42"H x 60"W	HRVG4260GGRG	87.3	6.8	\$1398	\$1450
50"H x 18"W	HRVG5018GGRG	33.4	2.8	\$933	\$966
50"H x 24"W	HRVG5024GGRG	43.3	3.5	\$1006	\$1042
50"H x 30"W	HRVG5030GGRG	53.2	4.3	\$1087	\$1126
50"H x 36"W	HRVG5036GGRG	63.1	5.0	\$1167	\$1209
50"H x 42"W	HRVG5042GGRG	73.1	5.7	\$1254	\$1299
50"H x 48"W	HRVG5048GGRG	83.0	6.5	\$1348	\$1398
50"H x 60"W	HRVG5060GGRG	102.8	7.9	\$1448	\$1501
57½"H x 18"W	HRVG5718GGRG	38.0	3.3	\$985	\$1020
57½"H x 24"W	HRVG5724GGRG	49.7	4.1	\$1061	\$1100
57½"H x 30"W	HRVG5730GGRG	61.1	5.0	\$1145	\$1187
57½"H x 36"W	HRVG5736GGRG	72.6	5.8	\$1223	\$1268
57½"H x 42"W	HRVG5742GGRG	84.0	6.6	\$1304	\$1353
57½"H x 48"W	HRVG5748GGRG	95.5	7.4	\$1397	\$1450
57½"H x 60"W	HRVG5760GGRG	118.4	9.1	\$1500	\$1556

NOTES:

- Gallery-to-Gallery Panels connect to other Gallery Panels and are available in L-, T-, and Non-symmetrical T-configurations.
- When specifying Gallery-to-Gallery Panels, the installation template (HRVGTGG) is required. The recommendation is one template for every 30 panels. Templates are reusable.
- Gallery-to-Gallery Panels must be of equal or lower height than the Standard Gallery Panel attached. The Gallery-to-Gallery Panel cannot be taller than the adjacent panel. If this is needed, please reach out to Tailored Solutions for a custom solution.
- Made of 1½" board with HPL laminate.
- Woodgrain laminates can be specified with vertical grain up to 48"W. Horizontal grain is available on all sizes.
- Gallery Panels offer 2½" leveling capability.
- Overall heights line up with adjacent panel.
- Gallery-to-Gallery Panels cap over Standard Gallery Panels and are oversized by 1/8" to maintain true interior dimensions.
- Available with or without the integrated glass option.
- Glass specified separately, see 7½"H Gallery Glass on pages 493-494.
- Gallery Panels for use with glass have separate model numbers.
- Gallery-to-Gallery Panels are secured with an inset flat bracket under a painted metal cover.
- L-panels are handed.

HOW TO SPECIFY

Select Model Number HRVG3518GGRG	Select Laminate See page 467 H	Select Edge See page 467 H	Select Grain Direction VLG Horizontal Grain and Solid Laminate only VST Vertical Grain VLG	Select Paint Color See page 467 P8T	Select Glide G Glide G
--	---	---	--	--	-------------------------------------



GALLERY PANELS

Gallery-to-Gallery Connections

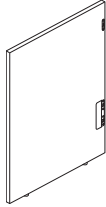

DESCRIPTION	MODEL	SHIP WEIGHT	CUBE	LIST PRICE BY LAMINATE GRADE	
				L1	L2
L-Connections, Left Hand					
35"H x 18"W	HRVG3518GGL	23.6	2.0	\$749	\$776
35"H x 24"W	HRVG3524GGL	30.5	2.6	\$807	\$836
35"H x 30"W	HRVG3530GGL	37.4	3.1	\$871	\$902
35"H x 36"W	HRVG3536GGL	44.3	3.6	\$934	\$967
35"H x 42"W	HRVG3542GGL	51.1	4.1	\$1002	\$1038
35"H x 48"W	HRVG3548GGL	58.0	4.7	\$1076	\$1115
35"H x 60"W	HRVG3560GGL	71.8	5.7	\$1155	\$1197
42"H x 18"W	HRVG4218GGL	28.5	2.4	\$778	\$806
42"H x 24"W	HRVG4224GGL	36.9	3.0	\$839	\$869
42"H x 30"W	HRVG4230GGL	45.3	3.7	\$904	\$936
42"H x 36"W	HRVG4236GGL	53.7	4.3	\$975	\$1010
42"H x 42"W	HRVG4242GGL	62.1	4.9	\$1055	\$1093
42"H x 48"W	HRVG4248GGL	70.5	5.6	\$1138	\$1179
42"H x 60"W	HRVG4260GGL	87.3	6.8	\$1223	\$1267
50"H x 18"W	HRVG5018GGL	33.4	2.8	\$839	\$869
50"H x 24"W	HRVG5024GGL	43.3	3.5	\$904	\$936
50"H x 30"W	HRVG5030GGL	53.2	4.3	\$975	\$1010
50"H x 36"W	HRVG5036GGL	63.1	5.0	\$1048	\$1086
50"H x 42"W	HRVG5042GGL	73.1	5.7	\$1123	\$1163
50"H x 48"W	HRVG5048GGL	83.0	6.5	\$1207	\$1251
50"H x 60"W	HRVG5060GGL	102.8	7.9	\$1297	\$1345
57½"H x 18"W	HRVG5718GGL	38.0	3.3	\$904	\$937
57½"H x 24"W	HRVG5724GGL	49.7	4.1	\$975	\$1010
57½"H x 30"W	HRVG5730GGL	61.1	5.0	\$1052	\$1090
57½"H x 36"W	HRVG5736GGL	72.6	5.8	\$1125	\$1167
57½"H x 42"W	HRVG5742GGL	84.0	6.6	\$1198	\$1242
57½"H x 48"W	HRVG5748GGL	95.5	7.4	\$1280	\$1329
57½"H x 60"W	HRVG5760GGL	118.4	9.1	\$1376	\$1428

NOTES:

- Gallery-to-Gallery Panels connect to other Gallery Panels and are available in L-, T-, and Non-symmetrical T-configurations.
- When specifying Gallery-to-Gallery Panels, the installation template (HRVGTGG) is required. The recommendation is one template for every 30 panels. Templates are reusable.
- Gallery-to-Gallery Panels must be of equal or lower height than the Standard Gallery Panel attached. The Gallery-to-Gallery Panel cannot be taller than the adjacent panel. If this is needed, please reach out to Tailored Solutions for a custom solution.
- Made of 1/8" board with HPL laminate.
- Woodgrain laminates can be specified with vertical grain up to 48"W. Horizontal grain is available on all sizes.
- Gallery Panels offer 2 1/2" leveling capability.
- Overall heights line up with adjacent panel.
- Gallery-to-Gallery Panels cap over Standard Gallery Panels and are oversized by 1/8" to maintain true interior dimensions.
- Available with or without the integrated glass option.
- Glass specified separately, see 7 1/2"H Gallery Glass on pages 493-494.
- Gallery Panels for use with glass have separate model numbers.
- Gallery-to-Gallery Panels are secured with an inset flat bracket under a painted metal cover.
- L-panels are handed.

HOW TO SPECIFY

<p>Select Model Number</p> <p>HRVG3518GGL</p>	<p>Select Laminate</p> <p>See page 467</p> <p>H</p>	<p>Select Edge</p> <p>See page 467</p> <p>H</p>	<p>Select Grain Direction</p> <p>VLG Horizontal Grain and Solid Laminate only VST Vertical Grain</p> <p>VLG</p>	<p>Select Paint Color</p> <p>See page 467</p> <p>P8T</p>	<p>Select Glide</p> <p>G Glide</p> <p>G</p>
--	--	--	--	---	--

GALLERY PANELS

Gallery-to-Gallery Connections

OPEN MARKET



Icon Legend on page 19

WORKSTATIONS

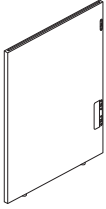

DESCRIPTION	MODEL	SHIP WEIGHT	CUBE	LIST PRICE BY LAMINATE GRADE	
				L1	L2
L-Connections, Left Hand, Accepts Glass					
35"H x 18"W	HRVG3518GGLG	23.6	2.0	\$864	\$895
35"H x 24"W	HRVG3524GGLG	30.5	2.6	\$933	\$966
35"H x 30"W	HRVG3530GGLG	37.4	3.1	\$1006	\$1042
35"H x 36"W	HRVG3536GGLG	44.3	3.6	\$1082	\$1121
35"H x 42"W	HRVG3542GGLG	51.1	4.1	\$1161	\$1203
35"H x 48"W	HRVG3548GGLG	58.0	4.7	\$1248	\$1293
35"H x 60"W	HRVG3560GGLG	71.8	5.7	\$1340	\$1389
42"H x 18"W	HRVG4218GGLG	28.4	2.4	\$884	\$916
42"H x 24"W	HRVG4224GGLG	36.9	3.0	\$955	\$989
42"H x 30"W	HRVG4230GGLG	45.3	3.7	\$1033	\$1070
42"H x 36"W	HRVG4236GGLG	53.7	4.3	\$1113	\$1153
42"H x 42"W	HRVG4242GGLG	62.1	4.9	\$1203	\$1246
42"H x 48"W	HRVG4248GGLG	70.5	5.6	\$1300	\$1348
42"H x 60"W	HRVG4260GGLG	87.3	6.8	\$1398	\$1450
50"H x 18"W	HRVG5018GGLG	33.4	2.8	\$933	\$966
50"H x 24"W	HRVG5024GGLG	43.3	3.5	\$1006	\$1042
50"H x 30"W	HRVG5030GGLG	53.2	4.3	\$1087	\$1126
50"H x 36"W	HRVG5036GGLG	63.1	5.0	\$1167	\$1209
50"H x 42"W	HRVG5042GGLG	73.1	5.7	\$1254	\$1299
50"H x 48"W	HRVG5048GGLG	83.0	6.5	\$1348	\$1398
50"H x 60"W	HRVG5060GGLG	102.8	7.9	\$1448	\$1501
57½"H x 18"W	HRVG5718GGLG	38.0	3.3	\$985	\$1020
57½"H x 24"W	HRVG5724GGLG	49.7	4.1	\$1061	\$1100
57½"H x 30"W	HRVG5730GGLG	61.1	5.0	\$1145	\$1187
57½"H x 36"W	HRVG5736GGLG	72.6	5.8	\$1223	\$1268
57½"H x 42"W	HRVG5742GGLG	84.0	6.6	\$1304	\$1353
57½"H x 48"W	HRVG5748GGLG	95.5	7.4	\$1397	\$1450
57½"H x 60"W	HRVG5760GGLG	118.4	9.1	\$1500	\$1556

NOTES:

- Gallery-to-Gallery Panels connect to other Gallery Panels and are available in L-, T-, and Non-symmetrical T-configurations.
- When specifying Gallery-to-Gallery Panels, the installation template (HRVGTGG) is required. The recommendation is one template for every 30 panels. Templates are reusable.
- Gallery-to-Gallery Panels must be of equal or lower height than the Standard Gallery Panel attached. The Gallery-to-Gallery Panel cannot be taller than the adjacent panel. If this is needed, please reach out to Tailored Solutions for a custom solution.
- Made of 1½" board with HPL laminate.
- Woodgrain laminates can be specified with vertical grain up to 48"W. Horizontal grain is available on all sizes.
- Gallery Panels offer 2½" leveling capability.
- Overall heights line up with adjacent panel.
- Gallery-to-Gallery Panels cap over Standard Gallery Panels and are oversized by 1/8" to maintain true interior dimensions.
- Available with or without the integrated glass option.
- Glass specified separately, see 7½"H Gallery Glass on pages 493-494.
- Gallery Panels for use with glass have separate model numbers.
- Gallery-to-Gallery Panels are secured with an inset flat bracket under a painted metal cover.
- L-panels are handed.

HOW TO SPECIFY

<p>Select Model Number</p> <p>HRVG3518GGLG</p>	<p>Select Laminate</p> <p>See page 467</p> <p>H</p>	<p>Select Edge</p> <p>See page 467</p> <p>H</p>	<p>Select Grain Direction</p> <p>VLG Horizontal Grain and Solid Laminate only VST Vertical Grain</p> <p>VLG</p>	<p>Select Paint Color</p> <p>See page 467</p> <p>P8T</p>	<p>Select Glide</p> <p>G Glide</p> <p>G</p>
---	--	--	--	---	--



GALLERY PANELS

Gallery-to-Gallery Connections

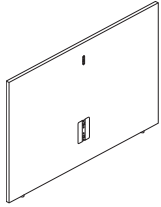

DESCRIPTION	MODEL	SHIP WEIGHT	CUBE	LIST PRICE BY LAMINATE GRADE	
				L1	L2
T-Connections					
35"H x 18"W	HRVG3518GGT	23.6	2.0	\$861	\$889
35"H x 36"W	HRVG3536GGT	44.3	3.6	\$1055	\$1090
35"H x 42"W	HRVG3542GGT	51.1	4.1	\$1127	\$1165
35"H x 48"W	HRVG3548GGT	58.0	4.7	\$1203	\$1244
35"H x 60"W	HRVG3560GGT	71.8	5.7	\$1286	\$1330
35"H x 72"W	HRVG3572GGT	85.5	6.8	\$1390	\$1438
42"H x 18"W	HRVG4218GGT	28.5	2.4	\$891	\$920
42"H x 36"W	HRVG4236GGT	53.7	4.3	\$1097	\$1134
42"H x 42"W	HRVG4242GGT	62.1	4.9	\$1179	\$1219
42"H x 48"W	HRVG4248GGT	70.5	5.6	\$1269	\$1312
42"H x 60"W	HRVG4260GGT	87.3	6.8	\$1357	\$1403
42"H x 72"W	HRVG4272GGT	104.1	8.1	\$1484	\$1536
50"H x 18"W	HRVG5018GGT	33.4	2.8	\$954	\$985
50"H x 36"W	HRVG5036GGT	63.1	5.0	\$1176	\$1216
50"H x 42"W	HRVG5042GGT	73.1	5.7	\$1265	\$1308
50"H x 48"W	HRVG5048GGT	83.0	6.5	\$1360	\$1406
50"H x 60"W	HRVG5060GGT	102.8	7.9	\$1466	\$1517
50"H x 72"W	HRVG5072GGT	122.7	9.4	\$1579	\$1634
57½"H x 18"W	HRVG5718GGT	38.3	3.3	\$1024	\$1058
57½"H x 36"W	HRVG5736GGT	72.6	5.8	\$1262	\$1306
57½"H x 42"W	HRVG5742GGT	84.0	6.6	\$1358	\$1406
57½"H x 48"W	HRVG5748GGT	95.5	7.4	\$1460	\$1511
57½"H x 60"W	HRVG5760GGT	118.4	9.1	\$1584	\$1640
57½"H x 72"W	HRVG5772GGT	38.0	10.8	\$1681	\$1740

NOTES:

- Gallery-to-Gallery Panels connect to other Gallery Panels and are available in L-, T-, and Non-symmetrical T-configurations.
- When specifying Gallery-to-Gallery Panels, the installation template (HRVGTGG) is required. The recommendation is one template for every 30 panels. Templates are reusable.
- Gallery-to-Gallery Panels must be of equal or lower height than the Standard Gallery Panel attached. The Gallery-to-Gallery Panel cannot be taller than the adjacent panel. If this is needed, please reach out to Tailored Solutions for a custom solution.
- Made of 1½" board with HPL laminate.
- Edgeband is 2mm ABS.
- Available in woodgrain and solid laminates.
- Non-symmetric T-panels vary in size on either side of the adjacent panel.
- Woodgrain laminates can be specified with vertical grain up to 48"W. Horizontal grain is available on all sizes.
- Gallery Panels offer 2½" leveling capability.
- Overall heights line up with adjacent panel.
- Gallery-to-Gallery Panels cap over Standard Gallery Panels and are oversized by 1/8" to maintain true interior dimensions.
- Available with or without the integrated glass option.
- Glass specified separately, see 7½"H Gallery Glass on pages 493-494.
- Gallery Panels for use with glass have separate model numbers.
- Gallery-to-Gallery Panels are secured with an inset flat bracket under a painted metal cover.

HOW TO SPECIFY

<p>Select Model Number</p> <p>HRVG4242GGT</p>	<p>Select Laminate</p> <p>See page 467</p> <p>H</p>	<p>Select Edge</p> <p>See page 467</p> <p>H</p>	<p>Select Grain Direction</p> <p>VLG Horizontal Grain and Solid Laminate only VST Vertical Grain</p> <p>VLG</p>	<p>Select Paint Color</p> <p>See page 467</p> <p>P8T</p>	<p>Select Glide</p> <p>G Glide</p> <p>G</p>
--	--	--	--	---	--

GALLERY PANELS

Gallery-to-Gallery Connections

OPEN MARKET



Icon Legend on page 19

WORKSTATIONS

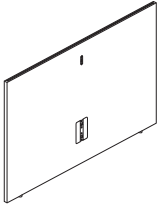

DESCRIPTION	MODEL	SHIP WEIGHT	CUBE	LIST PRICE BY LAMINATE GRADE	
				L1	L2
T-Connections, Accepts Glass					
35"H x 18"W	HRVG3518GGTG	23.6	2.0	\$982	\$1014
35"H x 36"W	HRVG3536GGTG	44.3	3.6	\$1208	\$1249
35"H x 42"W	HRVG3542GGTG	51.1	4.1	\$1292	\$1336
35"H x 48"W	HRVG3548GGTG	58.0	4.7	\$1382	\$1430
35"H x 60"W	HRVG3560GGTG	71.8	5.7	\$1482	\$1534
35"H x 72"W	HRVG3572GGTG	85.5	6.8	\$1587	\$1643
42"H x 18"W	HRVG4218GGTG	28.5	2.4	\$1004	\$1037
42"H x 36"W	HRVG4236GGTG	53.7	4.3	\$1242	\$1284
42"H x 42"W	HRVG4242GGTG	62.1	4.9	\$1336	\$1381
42"H x 48"W	HRVG4248GGTG	70.5	5.6	\$1441	\$1491
42"H x 60"W	HRVG4260GGTG	87.3	6.8	\$1544	\$1598
42"H x 72"W	HRVG4272GGTG	104.1	8.1	\$1670	\$1729
50"H x 18"W	HRVG5018GGTG	33.4	2.8	\$1052	\$1087
50"H x 36"W	HRVG5036GGTG	63.1	5.0	\$1308	\$1352
50"H x 42"W	HRVG5042GGTG	73.1	5.7	\$1409	\$1458
50"H x 48"W	HRVG5048GGTG	83.0	6.5	\$1517	\$1570
50"H x 60"W	HRVG5060GGTG	102.8	7.9	\$1633	\$1690
50"H x 72"W	HRVG5072GGTG	122.7	9.4	\$1764	\$1826
57½"H x 18"W	HRVG5718GGTG	49.7	3.3	\$1103	\$1141
57½"H x 36"W	HRVG5736GGTG	61.1	5.8	\$1378	\$1426
57½"H x 42"W	HRVG5742GGTG	72.6	6.6	\$1485	\$1538
57½"H x 48"W	HRVG5748GGTG	84.0	7.4	\$1599	\$1656
57½"H x 60"W	HRVG5760GGTG	95.5	9.1	\$1728	\$1789
57½"H x 72"W	HRVG5772GGTG	118.4	10.8	\$1863	\$1929

NOTES:

- Gallery-to-Gallery Panels connect to other Gallery Panels and are available in L-, T-, and Non-symmetrical T-configurations.
- When specifying Gallery-to-Gallery Panels, the installation template (HRVGTGG) is required. The recommendation is one template for every 30 panels. Templates are reusable.
- Gallery-to-Gallery Panels must be of equal or lower height than the Standard Gallery Panel attached. The Gallery-to-Gallery Panel cannot be taller than the adjacent panel. If this is needed, please reach out to Tailored Solutions for a custom solution.
- Made of 1½" board with HPL laminate.
- Non-symmetric T-panels vary in size on either side of the adjacent panel.
- Woodgrain laminates can be specified with vertical grain up to 48"W. Horizontal grain is available on all sizes.
- Gallery Panels offer 2½" leveling capability.
- Overall heights line up with adjacent panel.
- Gallery-to-Gallery Panels cap over Standard Gallery Panels and are oversized by 1/8" to maintain true interior dimensions.
- Available with or without the integrated glass option.
- Glass specified separately, see 7½"H Gallery Glass on pages 493-494.
- Gallery Panels for use with glass have separate model numbers.
- Gallery-to-Gallery Panels are secured with an inset flat bracket under a painted metal cover.

HOW TO SPECIFY

<p>Select Model Number</p> <p>HRVG3518GGTG</p>	<p>Select Laminate</p> <p>See page 467</p> <p>H</p>	<p>Select Edge</p> <p>See page 467</p> <p>H</p>	<p>Select Grain Direction</p> <p>VLG Horizontal Grain and Solid Laminate only VST Vertical Grain</p> <p>VLG</p>	<p>Select Paint Color</p> <p>See page 467</p> <p>P8T</p>	<p>Select Glide</p> <p>G Glide</p> <p>G</p>
---	--	--	--	---	--



GALLERY PANELS

Gallery-to-Gallery Connections

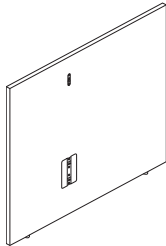

DESCRIPTION	MODEL	SHIP WEIGHT	CUBE	LIST PRICE BY LAMINATE GRADE	
				L1	L2
Non-Symmetrical Connections					
35"H x 18"W/24"W	HRVG351824GGNS	51.1	4.1	\$1127	\$1165
35"H x 24"W/18"W	HRVG352418GGNS	51.1	4.1	\$1127	\$1165
35"H x 18"W/30"W	HRVG351830GGNS	58.0	4.7	\$1203	\$1244
35"H x 30"W/18"W	HRVG353018GGNS	58.0	4.7	\$1203	\$1244
35"H x 24"W/30"W	HRVG352430GGNS	64.9	5.2	\$1246	\$1288
35"H x 30"W/24"W	HRVG353024GGNS	64.9	5.2	\$1246	\$1288
42"H x 18"W/24"W	HRVG421824GGNS	62.1	4.9	\$1179	\$1219
42"H x 24"W/18"W	HRVG422418GGNS	62.1	4.9	\$1179	\$1219
42"H x 18"W/30"W	HRVG421830GGNS	70.5	5.6	\$1269	\$1312
42"H x 30"W/18"W	HRVG423018GGNS	70.5	5.6	\$1269	\$1312
42"H x 24"W/30"W	HRVG422430GGNS	78.9	6.2	\$1312	\$1357
42"H x 30"W/24"W	HRVG423024GGNS	78.9	6.2	\$1312	\$1357
50"H x 18"W/24"W	HRVG501824GGNS	73.1	5.7	\$1265	\$1308
50"H x 24"W/18"W	HRVG502418GGNS	73.1	5.7	\$1265	\$1308
50"H x 18"W/30"W	HRVG501830GGNS	83.0	6.5	\$1360	\$1406
50"H x 30"W/18"W	HRVG503018GGNS	83.0	6.5	\$1360	\$1406
50"H x 24"W/30"W	HRVG502430GGNS	92.9	7.2	\$1414	\$1463
50"H x 30"W/24"W	HRVG503024GGNS	92.9	7.2	\$1414	\$1463
57½"H x 18"W/24"W	HRVG571824GGNS	84.0	6.6	\$1358	\$1406
57½"H x 24"W/18"W	HRVG572418GGNS	84.0	6.6	\$1358	\$1409
57½"H x 18"W/30"W	HRVG571830GGNS	95.5	7.4	\$1460	\$1508
57½"H x 30"W/18"W	HRVG573018GGNS	95.5	7.4	\$1460	\$1513
57½"H x 24"W/30"W	HRVG572430GGNS	107.0	8.3	\$1522	\$1573
57½"H x 30"W/24"W	HRVG573024GGNS	107.0	8.3	\$1522	\$1575

NOTES:

- Gallery-to-Gallery Panels connect to other Gallery Panels and are available in L-, T-, and Non-symmetrical T-configurations.
- When specifying Gallery-to-Gallery Panels, the installation template (HRVGTGG) is required. The recommendation is one template for every 30 panels. Templates are reusable.
- Gallery-to-Gallery Panels must be of equal or lower height than the Standard Gallery Panel attached. The Gallery-to-Gallery Panel cannot be taller than the adjacent panel. If this is needed, please reach out to Tailored Solutions for a custom solution.
- Made of 1½" board with HPL laminate.
- Non-symmetric T-panels vary in size on either side of the adjacent panel.
- Woodgrain laminates can be specified with vertical grain up to 48"W. Horizontal grain is available on all sizes.
- Gallery Panels offer 2½" leveling capability.
- Overall heights line up with adjacent panel.
- Gallery-to-Gallery Panels cap over Standard Gallery Panels and are oversized by 1/8" to maintain true interior dimensions.
- Available with or without the integrated glass option.
- Glass specified separately, see 7½"H Gallery Glass on pages 493-494.
- Gallery Panels for use with glass have separate model numbers.
- Gallery-to-Gallery Panels are secured with an inset flat bracket under a painted metal cover.

HOW TO SPECIFY

<p>Select Model Number</p> <p>HRVG421830GGNS</p>	<p>Select Laminate</p> <p>See page 467</p> <p>H</p>	<p>Select Edge</p> <p>See page 467</p> <p>H</p>	<p>Select Grain Direction</p> <p>VLG Horizontal Grain and Solid Laminate only VST Vertical Grain</p> <p>VLG</p>	<p>Select Paint Color</p> <p>See page 467</p> <p>P8T</p>	<p>Select Glide</p> <p>G Glide</p> <p>G</p>
---	--	--	--	---	--

GALLERY PANELS

Gallery-to-Gallery Connections

OPEN MARKET



Icon Legend on page 19

WORKSTATIONS

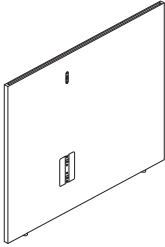

DESCRIPTION	MODEL	SHIP WEIGHT	CUBE	LIST PRICE BY LAMINATE GRADE	
				L1	L2
Non-Symmetrical Connections, Accepts Glass					
35"H x 18"W/24"W	HRVG351824GGNSG	51.1	4.1	\$1292	\$1336
35"H x 24"W/18"W	HRVG352418GGNSG	51.1	4.1	\$1292	\$1336
35"H x 18"W/30"W	HRVG351830GGNSG	58.0	4.7	\$1382	\$1430
35"H x 30"W/18"W	HRVG353018GGNSG	58.0	4.7	\$1382	\$1430
35"H x 24"W/30"W	HRVG352430GGNSG	64.9	5.2	\$1435	\$1485
35"H x 30"W/24"W	HRVG353024GGNSG	64.9	5.2	\$1435	\$1485
42"H x 18"W/24"W	HRVG421824GGNSG	62.1	4.9	\$1336	\$1381
42"H x 24"W/18"W	HRVG422418GGNSG	62.1	4.9	\$1336	\$1381
42"H x 18"W/30"W	HRVG421830GGNSG	70.5	5.6	\$1441	\$1491
42"H x 30"W/18"W	HRVG423018GGNSG	70.5	5.6	\$1441	\$1491
42"H x 24"W/30"W	HRVG422430GGNSG	78.9	6.2	\$1490	\$1542
42"H x 30"W/24"W	HRVG423024GGNSG	78.9	6.2	\$1490	\$1542
50"H x 18"W/24"W	HRVG501824GGNSG	73.1	5.7	\$1409	\$1458
50"H x 24"W/18"W	HRVG502418GGNSG	73.1	5.7	\$1409	\$1458
50"H x 18"W/30"W	HRVG501830GGNSG	83.0	6.5	\$1517	\$1570
50"H x 30"W/18"W	HRVG503018GGNSG	83.0	6.5	\$1517	\$1570
50"H x 24"W/30"W	HRVG502430GGNSG	92.9	7.2	\$1577	\$1632
50"H x 30"W/24"W	HRVG503024GGNSG	92.9	7.2	\$1577	\$1632
57½"H x 18"W/24"W	HRVG571824GGNSG	84.0	6.6	\$1485	\$1533
57½"H x 24"W/18"W	HRVG572418GGNSG	84.0	6.6	\$1485	\$1536
57½"H x 18"W/30"W	HRVG571830GGNSG	95.5	7.4	\$1599	\$1647
57½"H x 30"W/18"W	HRVG573018GGNSG	95.5	7.4	\$1599	\$1652
57½"H x 24"W/30"W	HRVG572430GGNSG	107.0	8.3	\$1670	\$1721
57½"H x 30"W/24"W	HRVG573024GGNSG	107.0	8.3	\$1670	\$1723

NOTES:

- Gallery-to-Gallery Panels connect to other Gallery Panels and are available in L-, T-, and Non-symmetrical T-configurations.
- When specifying Gallery-to-Gallery Panels, the installation template (HRVGTGG) is required. The recommendation is one template for every 30 panels. Templates are reusable.
- Gallery-to-Gallery Panels must be of equal or lower height than the Standard Gallery Panel attached. The Gallery-to-Gallery Panel cannot be taller than the adjacent panel. If this is needed, please reach out to Tailored Solutions for a custom solution.
- Made of 1½" board with HPL laminate.
- Non-symmetric T-panels vary in size on either side of the adjacent panel.
- Woodgrain laminates can be specified with vertical grain up to 48"W. Horizontal grain is available on all sizes.
- Gallery Panels offer 2½" leveling capability.
- Overall heights line up with adjacent panel.
- Gallery-to-Gallery Panels cap over Standard Gallery Panels and are oversized by 1/8" to maintain true interior dimensions.
- Available with or without the integrated glass option.
- Glass specified separately, see 7½"H Gallery Glass on pages 493-494.
- Gallery Panels for use with glass have separate model numbers.
- Gallery-to-Gallery Panels are secured with an inset flat bracket under a painted metal cover.

HOW TO SPECIFY

<p>Select Model Number</p> <p>HRVG351824GGNSG</p>	<p>Select Laminate</p> <p>See page 467</p> <p>H</p>	<p>Select Edge</p> <p>See page 467</p> <p>H</p>	<p>Select Grain Direction</p> <p>VLG Horizontal Grain and Solid Laminate only VST Vertical Grain</p> <p>VLG</p>	<p>Select Paint Color</p> <p>See page 467</p> <p>P8T</p>	<p>Select Glide</p> <p>G Glide</p> <p>G</p>
--	--	--	--	---	--



Icon Legend on page 19

GALLERY PANELS

Abound® Frameless Glass

WORKSTATIONS

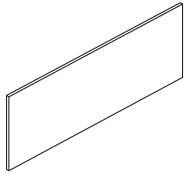

DESCRIPTION	MODEL	SHIP WEIGHT	CUBE	CLEAR GLASS	FROSTED GLASS
7½”H Gallery Glass, for Abound®					
18”W	SPLH-ABND-GALGLSS.M540464	7.0	0.6	\$421	\$459
21”W	SPLH-ABND-GALGLSS.M482171	8.0	0.7	\$444	\$482
24”W	SPLH-ABND-GALGLSS.M482172	9.0	0.7	\$455	\$494
27”W	SPLH-ABND-GALGLSS.M482173	10.0	0.8	\$469	\$507
30”W	SPLH-ABND-GALGLSS.M482174	10.5	0.9	\$481	\$520
33”W	SPLH-ABND-GALGLSS.M482175	11.0	1.0	\$493	\$531
36”W	SPLH-ABND-GALGLSS.M482176	12.0	1.1	\$551	\$590
39”W	SPLH-ABND-GALGLSS.M482177	12.5	1.2	\$565	\$603
42”W	SPLH-ABND-GALGLSS.M482178	13.0	1.3	\$583	\$621
45”W	SPLH-ABND-GALGLSS.M482179	14.0	1.4	\$619	\$658
48”W	SPLH-ABND-GALGLSS.M482180	14.5	1.5	\$643	\$682
51”W	SPLH-ABND-GALGLSS.M540465	15.0	1.6	\$643	\$682
54”W	SPLH-ABND-GALGLSS.M541046	15.7	1.7	\$660	\$699
57”W	SPLH-ABND-GALGLSS.M482181	16.0	1.7	\$743	\$782
60”W	SPLH-ABND-GALGLSS.M482182	17.0	1.8	\$756	\$795
72”W	SPLH-ABND-GALGLSS.M482183	19.5	2.2	\$894	\$933

NOTES:

- Gallery Panels are 3” wider than corresponding glass to allow for proper fit and function.
- Glass is inset 1½” from end of Standard Gallery Panels. Gallery-to-Gallery Panels have ½” glass inset.
- ! Cannot hang or stack on top of Frameless Glass.
- ! Frameless Glass can only be used on the top of Gallery Panels. Glass integrates into notch cutout in the top of the panel.

STANDARD GALLERY PANELS	
Gallery Panel Width	Gallery Glass Width
21”W Gallery Panel	18”W Glass
24”W Gallery Panel	21”W Glass
27”W Gallery Panel	24”W Glass
30”W Gallery Panel	27”W Glass
33”W Gallery Panel	30”W Glass
36”W Gallery Panel	33”W Glass
39”W Gallery Panel	36”W Glass
42”W Gallery Panel	39”W Glass
45”W Gallery Panel	42”W Glass
48”W Gallery Panel	45”W Glass
51”W Gallery Panel	48”W Glass
60”W Gallery Panel	57”W Glass
63”W Gallery Panel	60”W Glass
75”W Gallery Panel	72”W Glass

SPLIT GALLERY PANELS	
Gallery Panel Width	Gallery Glass Width
87”W Split Panel	(2) 39”W Glass
99”W Split Panel	(2) 45”W Glass
111”W Split Panel	(2) 51”W Glass
123”W Split Panel	(2) 57”W Glass

GALLERY-TO-GALLERY PANELS	
Gallery Panel Width	Gallery Glass Width
18”W G2G Panel	18”W Glass
24”W G2G Panel	24”W Glass
30”W G2G Panel	30”W Glass
36”W G2G Panel	36”W Glass
42”W G2G Panel	42”W Glass
48”W G2G Panel	48”W Glass
54”W G2G Panel	54”W Glass
60”W G2G Panel	60”W Glass
72”W G2G Panel	72”W Glass

HOW TO SPECIFY

Select Model Number

S P L H - A B N D - G A L G L S S . M 4 8 2 1 7 1 .

Select Glass

Q Clear Glass
R Frosted Glass

Q

GALLERY PANELS

Accelerate® Frameless Glass

OPEN MARKET



Icon Legend on page 19

WORKSTATIONS

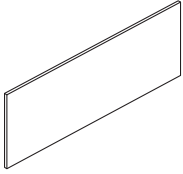

DESCRIPTION	MODEL	SHIP WEIGHT	CUBE	CLEAR GLASS	FROSTED GLASS
7½"H Gallery Glass, Wing, End of Run, for Accelerate®					
18"W	HEGFG0718	7.9	0.6	\$448	\$846
21"W	HEGFG0721	8.3	0.7	\$460	\$867
24"W	HEGFG0724	9.2	0.7	\$473	\$891
27"W	HEGFG0727	9.9	0.8	\$485	\$913
30"W	HEGFG0730	10.5	0.9	\$500	\$939
33"W	HEGFG0733	11.2	1.0	\$514	\$965
36"W	HEGFG0736	11.8	1.1	\$525	\$985
39"W	HEGFG0739	12.5	1.2	\$588	\$1098
42"W	HEGFG0742	13.1	1.3	\$602	\$1125
45"W	HEGFG0745	13.8	1.4	\$620	\$1158
48"W	HEGFG0748	14.4	1.5	\$660	\$1229
54"W	HEGFG0754	15.8	1.6	\$704	\$1349
57"W	HEGFG0757	16.4	1.7	\$731	\$1358
60"W	HEGFG0760	17.0	1.8	\$793	\$1470
72"W	HEGFG0772	19.6	2.2	\$850	\$1573

NOTES:

- Gallery Panels are 3" wider than corresponding glass to allow for proper fit and function.
- Glass is inset 1½" from end of Standard Gallery Panels. Gallery-to-Gallery Panels have ½" glass inset.
- ⓘ Cannot hang or stack on top of Frameless Glass.
- ⓘ Frameless Glass can only be used on the top of Gallery Panels. Glass integrates into notch cutout in the top of the panel.

STANDARD GALLERY PANELS	
Gallery Panel Width	Gallery Glass Width
21"W Gallery Panel	18"W Glass
24"W Gallery Panel	21"W Glass
27"W Gallery Panel	24"W Glass
30"W Gallery Panel	27"W Glass
33"W Gallery Panel	30"W Glass
36"W Gallery Panel	33"W Glass
39"W Gallery Panel	36"W Glass
42"W Gallery Panel	39"W Glass
45"W Gallery Panel	42"W Glass
48"W Gallery Panel	45"W Glass
51"W Gallery Panel	48"W Glass
60"W Gallery Panel	57"W Glass
63"W Gallery Panel	60"W Glass
75"W Gallery Panel	72"W Glass

GALLERY-TO-GALLERY PANELS	
Gallery Panel Width	Gallery Glass Width
18"W G2G Panel	18"W Glass
24"W G2G Panel	24"W Glass
30"W G2G Panel	30"W Glass
36"W G2G Panel	36"W Glass
42"W G2G Panel	42"W Glass
48"W G2G Panel	48"W Glass
54"W G2G Panel	54"W Glass
60"W G2G Panel	60"W Glass
72"W G2G Panel	72"W Glass





HOW TO SPECIFY

<p>Select Model Number</p> <p>HEGFG0736</p>	<p>Select Glass</p> <p>Q Clear Glass R Frosted Glass</p> <p>Q</p>
---	---

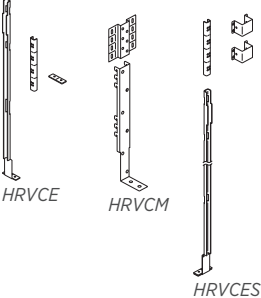

GALLERY PANELS

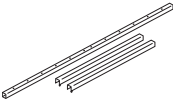
Abound[®] Connector Kits

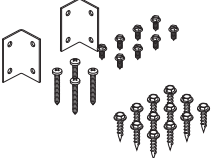
	DESCRIPTION	MODEL	SHIP WEIGHT	CUBE	LIST PRICE BY PAINT GRADE		
					P1	P2	
	Gallery Panel Connectors						
	Spanning End of Run and L Connector	HRVCE	0.83	0.1	\$102	\$110	
	Wing Middle Attachment Brackets	HRVCM	0.62	0.1	\$119	\$129	
	Split Gallery Panel Connector	HRVCES	2.00	0.1	\$99	\$107	
	Gallery Connector Kits						
	35"	HRVC35GP	1.0	0.3	\$244	\$258	
	42"	HRVC42GP	1.5	0.4	\$271	\$287	
	50"	HRVC50GP	1.5	0.5	\$283	\$299	
	57½"	HRVC57GP	1.8	0.5	\$279	\$297	
	65"	HRVC65GP	2.0	0.6	\$330	\$348	
	Gallery Connector Kits, Flat						
	35"	HRVC35GPF	1.16	0.5	\$230	\$255	
	42"	HRVC42GPF	1.49	0.7	\$257	\$284	
	50"	HRVC50GPF	1.64	0.7	\$269	\$296	
	57"	HRVC57GPF	1.80	0.7	\$265	\$294	
	65"	HRVC65GPF	2.13	1.0	\$316	\$345	
		Gallery Panel Stiffener					
		For 75"W Panels	HRVGS7578	5.6	0.9	\$134	\$144
	Gallery Panel Wall Starter						
	35"H	HRVGWS35	4.1	0.4	\$119	\$129	
	42½"H	HRVGWS42	4.9	0.5	\$125	\$135	
	50"H	HRVGWS50	5.7	0.6	\$130	\$140	
	57½"H	HRVGWS57	6.5	0.6	\$137	\$147	
	DESCRIPTION	MODEL	SHIP WEIGHT	CUBE	LIST PRICE		
	Gallery Panel-to-Storage Kits						
	Laminate Storage Ganging Kit	HRVGLSK	0.1	0.1	\$58		
	Metal Storage Ganging Kit	HRVGMSK	0.1	0.1	\$14		

NOTES:

- HRVCE is used in L and spanning (T) end of run applications.
- Wing Middle Connector Kits accommodate both single-sided and dual-sided applications.
- For more rigidity, the Gallery Panel can be tied to a storage or a non-adjustable surface. Use HRVGLSK for laminate or HRVGMSK for metal storage.
- HAT bases can be tied to Gallery Panels using HAT-to-Gallery brackets on page 497.

- ⓘ Wing Middle Connector Kits must be used in any Wing Middle application in conjunction with model HRVCM.
- ⓘ Wing Middle Connector Kits are required for Wing Middle applications and are used only with Wing Middle Gallery Panels.
- ⓘ Gallery Panels can only connect to standard panel frames; Gallery Panels cannot connect to each other.

HOW TO SPECIFY

<p>Select Model Number</p> <p>HRVC42GP</p>	<p>Select Paint Color</p> <p>See page 467</p> <p>T1</p>
---	--

GALLERY PANELS

Accelerate[®] Connector Kits

OPEN MARKET



Icon Legend on page 19

WORKSTATIONS

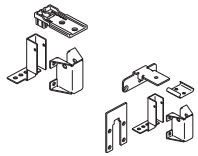

DESCRIPTION	MODEL	SHIP WEIGHT	CUBE	LIST PRICE BY PAINT GRADE	
				P1	P2
Gallery Panel End Connector	HEGPEC	1.4	0.1	\$146	\$156
Spanning End of Run Connector w/Glass	HEGSFGA	6.3	0.8	\$226	\$236
<p>! Spanning End Connector w/Glass must be used in T-configurations when using a Spanning Gallery Panel with Glass.</p> <p>! All L-configurations, with or without glass, use HEGPEC.</p>					

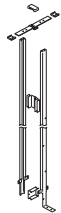

Gallery Panel Mid Connector, Single-Sided					
35"H	HEGMC351	4.0	0.5	\$228	\$238
42½"H	HEGMC421	4.6	0.5	\$228	\$238
50"H	HEGMC501	5.2	0.6	\$260	\$270
57½"H	HEGMC571	5.7	0.8	\$287	\$297
65"H	HEGMC651	6.3	0.8	\$312	\$322
72"H	HEGMC721	6.9	0.9	\$352	\$362

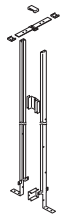

Gallery Panel Mid Connector, Double-Sided					
35"H	HEGMC352	4.0	0.5	\$228	\$238
42½"H	HEGMC422	4.6	0.5	\$228	\$238
50"H	HEGMC502	5.2	0.6	\$260	\$270
57½"H	HEGMC572	5.7	0.8	\$287	\$297
65"H	HEGMC652	6.3	0.8	\$312	\$322
72"H	HEGMC722	6.9	0.9	\$352	\$362

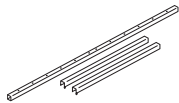

Gallery Panel Stiffener					
For 75"W Panels	HRVGS7578	5.6	0.9	\$134	\$144



Gallery Panel Wall Starter					
35"H	HRVGWS35	4.1	0.4	\$119	\$129
42½"H	HRVGWS42	4.9	0.5	\$125	\$135
50"H	HRVGWS50	5.7	0.6	\$130	\$140
57½"H	HRVGWS57	6.5	0.6	\$137	\$147

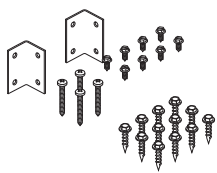

DESCRIPTION	MODEL	SHIP WEIGHT	CUBE	LIST PRICE
Gallery Panel-to-Storage Kits				
Laminate Storage Ganging Kit	HRVGLSK	0.1	0.1	\$58
Metal Storage Ganging Kit	HRVGMSK	0.1	0.1	\$14

NOTES:

- For more rigidity, the Gallery Panel can be tied to a storage or a non-adjustable surface. Use HRVGLSK for laminate or HRVGMSK for metal storage.
- HAT bases can be tied to Gallery Panels using HAT-to-Gallery brackets on page 497.

- ! Gallery Panels can only connect to standard panel frames; Gallery Panels cannot connect to each other.
- ! See Gallery Panel and Connector illustration on page 473 for placement and application.

HOW TO SPECIFY

<p>Select Model Number</p> <p>HEGMC501</p>	<p>Select Paint Color</p> <p>See page 467</p> <p>T1</p>
--	---



GALLERY PANELS

Height Adjustable Tie-In Brackets

	DESCRIPTION	MODEL	SHIP WEIGHT	CUBE	LIST PRICE BY PAINT GRADE		
					P1	P2	P3
	Rectangle Leg, T-Foot Brackets						
	HAT to Panel, Left Hand	HHALRETL	4.0	0.2	\$181	\$197	\$206
	HAT to Panel, Right Hand	HHALRETR	4.0	0.2	\$181	\$197	\$206
	HAT to Gallery Panel	HHALRETG	3.5	0.2	\$181	\$197	\$206
	Rectangle Leg, C-Foot Brackets						
	HAT to Panel, Left Hand	HHALRECL	4.0	0.2	\$181	\$197	\$206
	HAT to Panel, Right Hand	HHALRECR	4.0	0.2	\$181	\$197	\$206
	HAT to Gallery Panel	HHALRECG	3.5	0.2	\$181	\$197	\$206
	DESCRIPTION	MODEL	SHIP WEIGHT	CUBE	LIST PRICE		
	Gallery-to-Gallery Template	HRVGTGG	1.1	0.5	\$78		
	HAT-to-Gallery Template	HHALGPT	1.1	0.1	\$56		

NOTES:

- Tie-in brackets are used to tie a height adjustable table to either a Standard Panel or Gallery Panel for added rigidity.
- Bracket ties into the approach side of the height adjustable worksurface – this removes the need for a wing panel.
- Can be used as a value engineering option to replace wing panels.
- Available in all paint colors to match panel trim or coordinating colors to the height adjustable base.
- Brackets telescope to account for 24" and 30" deep worksurfaces and screen attachments.

❗ Brackets must be used on a return panel, not a spine wall, except if stations are back-to-back on a spine wall and a tie-in bracket is used at a minimum every 96".

❗ C-legs with a 30"D worksurface and a screen must be specified with T-leg brackets.

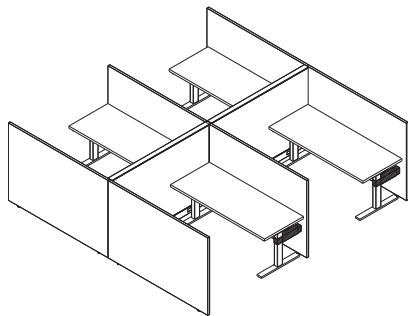

SINGLE BRACKET

Systems Application

- Max Height (with Glass): 65"H
- Max Width: 96"; tops greater than 72"W **will not align**.

DUAL-SIDED PANEL BENCH

Systems Application

- Max Height (with Glass): 65"H
- Bracket needed every 96" on both sides; tops greater than 72"W **will not align**.

Gallery Panel Application

- Max Height (with Glass): 65"H
- Max Width: 75"; no top size restrictions.

Gallery Panel Application

- Max Height (with Glass): 65"H
- Bracket Needed: Single Panel (75") with brackets on each leg (same height).

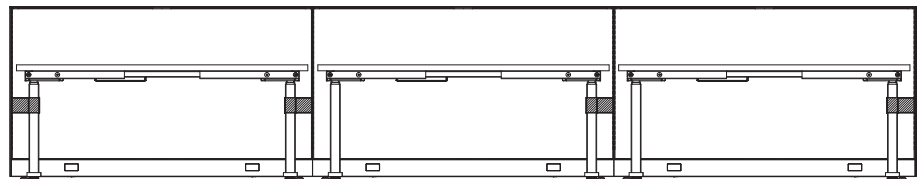

❗ Overhead storage cannot be used without return panels.

HOW TO SPECIFY

<p>Select Model Number</p> <p>HHALRECL .</p>	<p>Select Paint Color</p> <p>See page 467</p> <p>PR6</p>
--	--

GALLERY PANELS

Accessories

OPEN MARKET



Icon Legend on page 19

WORKSTATIONS

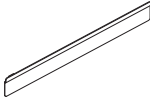
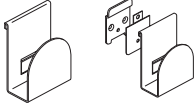
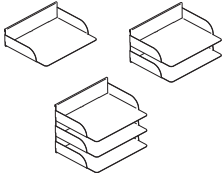
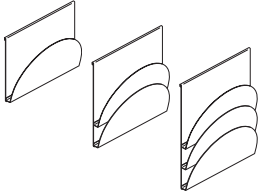
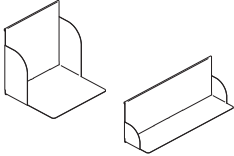
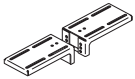
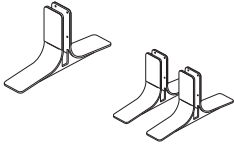
	DESCRIPTION	MODEL	SHIP WEIGHT	CUBE	LIST PRICE BY PAINT GRADE		
					P1	P2	P3
	Gallery Panel Accessory Rail						
	12"W	HRVGR12	2.0	0.2	\$170	\$183	\$195
	18"W	HRVGR18	2.5	0.4	\$185	\$198	\$210
	24"W	HRVGR24	3.3	0.4	\$201	\$214	\$226
	30"W	HRVGR30	3.5	0.4	\$217	\$230	\$242
	36"W	HRVGR36	4.4	0.5	\$232	\$245	\$257
	Accessory Rail Mounted Coat/Bag Hook	HRVGRCH	1.5	0.1	\$74	\$87	\$99
	Accessory Face Mounted Coat/Bag Hook	HRVGFCH	1.7	0.1	\$74	\$87	\$99
	Accessory Rail Mounted Paper Tray						
Single	HRVGRPT1	4.1	0.6	\$99	\$112	\$124	
Double	HRVGRPT2	7.1	0.6	\$124	\$137	\$149	
Triple	HRVGRPT3	10.1	1.1	\$148	\$161	\$173	
	Accessory Rail Mounted Angle File						
	Single	HRVGRAF1	4.6	0.6	\$99	\$112	\$124
	Double	HRVGRAF2	6.6	0.6	\$124	\$137	\$149
Triple	HRVGRAF3	8.5	1.1	\$148	\$161	\$173	
	Accessory Rail Mounted Binder Shelf	HRVGRBS	7.6	1.6	\$124	\$137	\$149
	Accessory Rail Mounted Wide Personal Shelf	HRVGRPS	8.0	1.0	\$124	\$137	\$149
	Gallery Countertop Kit	HRVGCKS	1.9	0.1	\$226	\$236	\$245
<p>! Bracket kit includes one right and one left hand bracket. Order two sets of brackets for the straight countertop models and three sets for the corner countertop models.</p>							
	Gallery Panel Foot						
	1 Pack	HRVGPF1	10.4	1.3	\$268	\$281	\$293
2 Pack	HRVGPF2	19.7	1.3	\$534	\$560	\$583	
<p>! Gallery Panel Foot should be installed 6" from the outside edge of Gallery Panel.</p> <p>! Cannot be used with Gallery Panels 24"W or narrower.</p>							

HOW TO SPECIFY

<p>Select Model Number</p> <p>HRVGR18</p>	<p>Select Paint Color</p> <p>T1</p> <p>See page 467</p>
---	---



GALLERY PANELS Tackboards and Markerboards

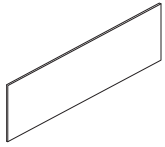

DESCRIPTION	MODEL	SHIP WEIGHT	CUBE	LIST PRICE BY FABRIC GRADE								
				AA	A	B	C	D	E	F	G	
Gallery Panel Tackboards												
36"W x 11"H	HRVTB11	7.0	1.1	\$343	\$349	\$352	\$355	\$358	\$363	\$369	\$374	
36"W x 18½"H	HRVTB18	10.0	1.8	\$402	\$408	\$411	\$414	\$417	\$422	\$428	\$433	
15"H x 24"W	HRVTB1524	4.5	2.3	\$296	\$302	\$305	\$308	\$311	\$316	\$322	\$327	
15"H x 30"W	HRVTB1530	5.5	2.8	\$322	\$328	\$331	\$334	\$337	\$342	\$348	\$353	
15"H x 36"W	HRVTB1536	6.6	3.3	\$353	\$359	\$362	\$365	\$368	\$373	\$379	\$384	
15"H x 48"W	HRVTB1548	9.7	4.3	\$376	\$382	\$385	\$388	\$391	\$396	\$402	\$407	
15"H x 60"W	HRVTB1560	11.8	5.4	\$397	\$403	\$406	\$409	\$412	\$417	\$423	\$428	
22"H x 24"W	HRVTB2224	6.3	3.2	\$310	\$316	\$319	\$322	\$325	\$330	\$336	\$341	
22"H x 30"W	HRVTB2230	7.7	3.9	\$336	\$342	\$345	\$348	\$351	\$356	\$362	\$367	
22"H x 36"W	HRVTB2236	9.2	4.6	\$370	\$376	\$379	\$382	\$385	\$390	\$396	\$401	
22"H x 48"W	HRVTB2248	13.1	6.1	\$397	\$403	\$406	\$409	\$412	\$417	\$423	\$428	
22"H x 60"W	HRVTB2260	16.0	7.5	\$408	\$414	\$417	\$420	\$423	\$428	\$434	\$439	

NOTES:

- Tackboard attaches to Gallery Panel by screwing painted metal frame onto Gallery Panel surface. Fabric insert attaches to painted metal frame with hook and loop.
- Attachment hardware for Tackboard is provided.

! No template is provided for placement and leveling of Tackboard.

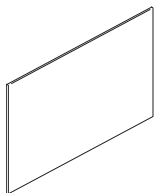

DESCRIPTION	MODEL	SHIP WEIGHT	CUBE	LIST PRICE BY PAINT GRADE	
				P1	P2
Markerboards					
15"H x 24"W	HRVM1524	7.6	2.3	\$358	\$371
15"H x 30"W	HRVM1530	8.8	2.8	\$383	\$396
22½"H x 36"W	HRVM2236	15.5	3.3	\$413	\$426
22½"H x 48"W	HRVM2248	20.0	6.1	\$464	\$477
22½"H x 60"W	HRVM2260	23.4	7.5	\$478	\$491

NOTES: Markerboard attaches to Gallery Panel by screwing markerboard rail onto Gallery Panel surface. Attachment hardware for markerboard is provided.

! No template is provided for placement and leveling of markerboard.

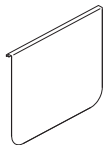

Hanging Markerboards					
20"H x 30"W	HRVHM2030	8.7	3.6	\$336	\$349
26"H x 30"W	HRVHM2630	11.0	4.6	\$464	\$477

NOTES: Hanging Markerboards hang on the top edge of a Gallery Panel. Hanging Markerboards can also be slipped onto any 1½" thick work surface.

NOTES:

- Provides writable surface when painted in markerboard paint; non-writable when specified in other paint colors.

HOW TO SPECIFY

<p>Select Model Number</p> <p>HRVTB11</p>	<p>Select Fabric</p> <p>See pages 372-373</p> <p>APN11</p>	
<p>Select Model Number</p> <p>HRVTB1548</p>	<p>Select Fabric</p> <p>APN11</p>	<p>Select Paint Color</p> <p>P8T</p>
<p>Select Model Number</p> <p>HRVTB1548</p>	<p>Select Paint Color</p> <p>P8T</p>	

GRAVITATION™ POWER BEAM

Want to see more? Scan here
to check out hon.com.



WORKSTATIONS



Graviton™ Power Beam shown with Coordinate™ Height Adjustable Desks, Fuse™ Storage, Astir™, Mav, and Solve® Seating.

GRAVITATION™ BEAM

Bringing power and privacy to individual workspaces and team areas, Gravitation™ Beam offers a sleek look and multiple aesthetic options to complement any environment. Designed for movement and flexibility, it adapts to changing needs with ease.



FEATURES

- Pairs perfectly with height adjustable tables or alongside soft seating.
- Offered in a variety of paint options.
- Available in 3 widths: 48", 60", and 72".
- Create L, X, and T configurations using universal connectors.
- Painted metal screens available to provide privacy and space division.

GRAVITATION™ POWER BEAM ORDERING INFORMATION

PAINT

PAINTS CODES

- P1**
 ◆ Black P71
 ◆ Brownstone P7D
 ◆ Charcoal P02
 ◆ Cove P096
 ◆ Designer White PJW
 ◆ Dune P094
 ◆ Fossil P28
 ◆ Greige T5
 ◆ Harbor P097
 ◆ Loft LOFT
 ◆ Muslin T3
 ◆ Sage P095
 ◆ Titanium P8T
- P2**
 ◆ Champagne Metallic T4
 ◆ Gunmetal Metallic PR3
 ◆ Silver PR6
 ◆ Solar Black P8X
- P3**
 ◆ Atom P8S
 ◆ Bullseye PJJ
 ◆ Ember P8P
 ◆ Ion P8N
 ◆ Iris P8J
 ◆ Krypton P8F
 ◆ Regatta P8M
- P6**
 ◆ Markerboard MKB

FABRIC SCREENS — GRADE A

NOBLE CODES

- ◆ Aegean NBLE18
 ◆ Amethyst NBLE19
 ◆ Aspen NBLE14
 ◆ Aster NBLE20
 ◆ Blossom NBLE21
 ◆ Bluebell NBLE22
 ◆ Bordeaux NBLE01
 ◆ Brick NBLE02
 ◆ Chambray NBLE10
 ◆ Chamomile NBLE23
 ◆ Clementine NBLE04
 ◆ Conifer NBLE24
 ◆ Cottage NBLE25
 ◆ Darkness NBLE26
 ◆ Dawn NBLE13
 ◆ Denim NBLE09
 ◆ Desert Sand NBLE27
 ◆ Dewfall NBLE28
 ◆ Dusted Sage NBLE29
 ◆ Flax NBLE30
 ◆ Grass NBLE07
 ◆ Gunmetal NBLE15
 ◆ Harmony NBLE31
 ◆ Harvest NBLE12
 ◆ Ice Caves NBLE32
 ◆ Icicle NBLE33
 ◆ Inky NBLE34
 ◆ Iris NBLE35
 ◆ Jade NBLE06
 ◆ Knight NBLE17
 ◆ Mesa NBLE03
 ◆ Monarch NBLE36
 ◆ Pacific NBLE08
 ◆ Pitch NBLE37
 ◆ Queen Bee NBLE38
 ◆ Rainforest NBLE05
 ◆ Regal NBLE11
 ◆ Sandcastle NBLE39
 ◆ Sedona NBLE40
 ◆ Stormy NBLE16
 ◆ Sunbeam NBLE41
 ◆ Voyager NBLE42
 ◆ Windy Day NBLE43

LAMINATE

L1 LAMINATES CODES

- Woodgrain**
 ◆ Bourbon Cherry H
 ◆ Cognac COGN
 ◆ Field Elm LWFE
 ◆ Florence Walnut LWF1
 ◆ Harvest C
 ◆ Kingswood Walnut LK11
 ◆ Mahogany N
 ◆ Mocha MOCH
 ◆ Natural Maple D
 ◆ Pinnacle PINC
 ◆ Shaker Cherry F
 ◆ Sterling Ash LSA1
- Solid**
 ◆ Black P
 ◆ Charcoal S
 ◆ Designer White LDW1
 ◆ Loft LOFT
- Patterned**
 ◆ Handspun Chestnut LAHC
 ◆ Handspun Dove LAHD
 ◆ Handspun Pearl LAHP
 ◆ Handspun Slate LAHS
 ◆ Silver Mesh B9
- L2 LAMINATES CODES**
- Woodgrain**
 ◆ Beigewood LWBE
 ◆ Fawn Cypress LFC1
 ◆ Lowell Ash LLA1
 ◆ Natural Recon LNR1
 ◆ Phantom Ecrú LPE1
 ◆ Portico Teak LPT1
 ◆ Skyline Walnut LSW1

Duplex Color Recommended to Coordinate with Paint Color

Paint Color	Paint Code	Duplex Color	Duplex Code
Black	P	Black	P
Brownstone	P7D	Brownstone	EY
Charcoal	S	Charcoal	S
Designer White	PJW	Designer White	DW
Fossil	P28	Charcoal	S
Greige	T5	Muslin	T3
Light Gray	Q	Loft	LOFT
Loft	LOFT	Loft	LOFT
Muslin	T3	Muslin	T3
Putty	L	Black	P
Shadow	SHDW	Muslin	T3
Silver	PR6	Titanium	T1
Titanium	P8T	Titanium	T1
Champagne Metallic	T4	Muslin	T3
Platinum Metallic	T1	Titanium	T1

◆◆◆ For lead time information see page 21.

GRAVITATION™ POWER BEAM ORDERING INFORMATION

Gravitation™ Ordering Checklist

When specifying Gravitation™ Power Beams for your workspace, follow the ordering checklist below to ensure full functionality.

- Beams (HBEAM48, 60, or 72).
- Legs to go with beams based on how the beams will be connected (HBLEG23).
- Electrical Harnesses, Receptacles, and In-feeds.
- Specify connectors, power hubs, and/or power poles (HBEORH23, HBEORT23, HBILNH23, HBCONU, etc.).
- Port Covers (for any power/data ports left unused).
- Metal, fabric, and PET screens and acrylic, fabric, and laminate modesties available.

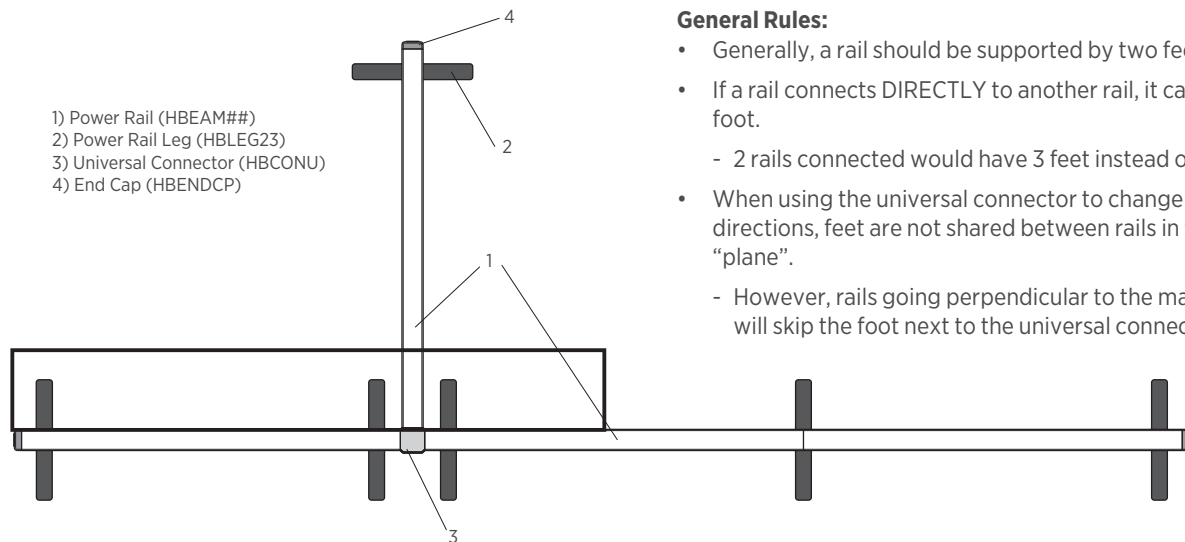

General Rules:

- Generally, a rail should be supported by two feet.
- If a rail connects DIRECTLY to another rail, it can share a foot.
 - 2 rails connected would have 3 feet instead of 4.
- When using the universal connector to change directions, feet are not shared between rails in the same “plane”.
 - However, rails going perpendicular to the main line will skip the foot next to the universal connector.

❗ When two rails share a leg, the leg is centered between the legs in the “outer slot”. When the leg is positioned **at the end of a run of rails** (i.e., the rail doesn’t connect to another rail), the leg will be inset 1/8” from the end of the rail, not the end cap, in the “inner slot”.

Cable Capacity

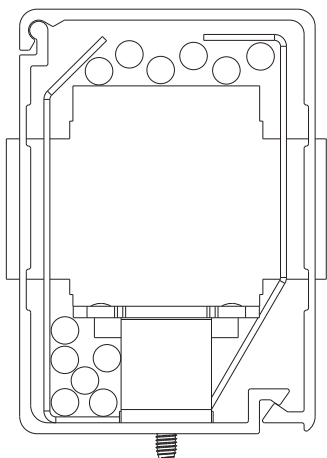

- The Power Rail housing allows continuous voice and data lines to run without interruption.
- Lay-in is provided for environments where systems furniture or cabling are subject to frequent change.
- Lower cavity allows for 6 voice/data cables (1/4” diameter).
- Upper cavity lay-in allows 6 voice/data cables (1/4” diameter).



Icon Legend on page 19

GRAVITATION™ 48"W Bundles

WORKSTATIONS

QTY	DESCRIPTION	MODEL	LIST PRICE	PRICE EXTENSION
1	Gravitation™ Power Beam 48"W	HBEAM48	\$508	\$508
2	Gravitation™ Legs 23"H	HBLEG23	\$178	\$356
1	End of Run Power Harness	HMPEEK48	\$298	\$298
4	Duplexes	HH873501	\$58	\$232
2	Gravitation™ Power Beam End Cap	HBENDCP	\$89	\$178
TOTAL:			\$1,572	

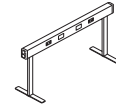

1-PACK — 48"W

QTY	DESCRIPTION	BUNDLE SKU	LIST PRICE BY PAINT GRADE		
			P1	P2	P3
1	1-PACK BUNDLE	HBDL148	\$1,571	\$1,646	\$1,682

SPECIFYING EXAMPLE: Model.Paint

QTY	DESCRIPTION	MODEL	LIST PRICE	PRICE EXTENSION
2	Gravitation™ Power Beam 48"W	HBEAM48	\$508	\$1,016
3	Gravitation™ Legs 23"H	HBLEG23	\$178	\$534
1	End of Run Power Harness	HMPEEK48	\$298	\$298
1	Power Harness	HH871248	\$286	\$286
4	Duplexes	HH873501	\$58	\$232
4	Duplexes	HH873502	\$58	\$232
2	Gravitation™ Power Beam End Cap	HBENDCP	\$89	\$178
TOTAL:			\$2,776	

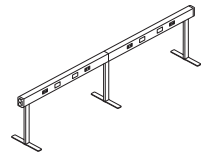

2-PACK — 48"W

QTY	DESCRIPTION	BUNDLE SKU	LIST PRICE BY PAINT GRADE		
			P1	P2	P3
1	2-PACK BUNDLE	HBDL248	\$2,774	\$2,898	\$2,958

SPECIFYING EXAMPLE: Model.Paint

QTY	DESCRIPTION	MODEL	LIST PRICE	PRICE EXTENSION
3	Gravitation™ Power Beam 48"W	HBEAM48	\$508	\$1,524
4	Gravitation™ Legs 23"H	HBLEG23	\$178	\$712
1	End of Run Power Harness	HMPEEK48	\$298	\$298
2	Power Harness	HH871248	\$286	\$572
4	Duplexes	HH873501	\$58	\$232
4	Duplexes	HH873502	\$58	\$232
4	Duplexes	HH873503	\$58	\$232
2	Gravitation™ Power Beam End Cap	HBENDCP	\$89	\$178
TOTAL:			\$3,980	

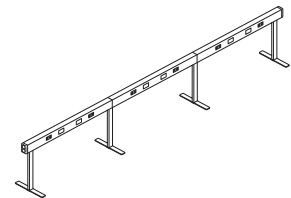

3-PACK — 48"W

QTY	DESCRIPTION	BUNDLE SKU	LIST PRICE BY PAINT GRADE		
			P1	P2	P3
1	3-PACK BUNDLE	HBDL348	\$3,977	\$4,150	\$4,235

SPECIFYING EXAMPLE: Model.Paint

QTY	DESCRIPTION	MODEL	LIST PRICE	PRICE EXTENSION
4	Gravitation™ Power Beam 48"W	HBEAM48	\$508	\$2,032
5	Gravitation™ Legs 23"H	HBLEG23	\$178	\$890
1	End of Run Power Harness	HMPEEK48	\$298	\$298
3	Power Harness	HH871248	\$286	\$858
4	Duplexes	HH873502	\$58	\$232
4	Duplexes	HH873503	\$58	\$232
4	Duplexes	HH873504	\$58	\$232
2	Gravitation™ Power Beam End Cap	HBENDCP	\$89	\$178
TOTAL:			\$4,952	

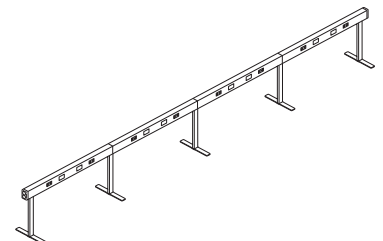

4-PACK — 48"W

QTY	DESCRIPTION	BUNDLE SKU	LIST PRICE BY PAINT GRADE		
			P1	P2	P3
1	4-PACK BUNDLE	HBDL448	\$5,180	\$5,402	\$5,511

SPECIFYING EXAMPLE: Model.Paint

! Power in-feeds and port covers are not included in Bundles and must be specified separately.

GRAVITATION™ 60"W Bundles



Icon Legend on page 19

WORKSTATIONS

QTY	DESCRIPTION	MODEL	LIST PRICE	PRICE EXTENSION
1	Gravitation™ Power Beam 60"W	HBEAM60	\$557	\$557
2	Gravitation™ Legs 23"H	HBLEG23	\$178	\$356
1	End of Run Power Harness	HMPEEK60	\$298	\$298
4	Duplexes	HH873501	\$58	\$232
2	Gravitation™ Power Beam End Cap	HBENDCP	\$89	\$178

TOTAL: \$1,621

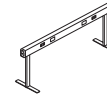

1-PACK — 60"W

QTY	DESCRIPTION	BUNDLE SKU	LIST PRICE BY PAINT GRADE		
			P1	P2	P3
1	1-PACK BUNDLE	HBBDL160	\$1,620	\$1,698	\$1,736

SPECIFYING EXAMPLE: Model.Paint

QTY	DESCRIPTION	MODEL	LIST PRICE	PRICE EXTENSION
2	Gravitation™ Power Beam 60"W	HBEAM60	\$557	\$1,114
3	Gravitation™ Legs 23"H	HBLEG23	\$178	\$534
1	End of Run Power Harness	HMPEEK60	\$298	\$298
1	Power Harness	HH871260	\$286	\$286
4	Duplexes	HH873501	\$58	\$232
4	Duplexes	HH873502	\$58	\$232
2	Gravitation™ Power Beam End Cap	HBENDCP	\$89	\$178

TOTAL: \$2,874

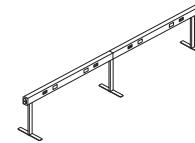

2-PACK — 60"W

QTY	DESCRIPTION	BUNDLE SKU	LIST PRICE BY PAINT GRADE		
			P1	P2	P3
1	2-PACK BUNDLE	HBBDL260	\$2,872	\$3,002	\$3,067

SPECIFYING EXAMPLE: Model.Paint

QTY	DESCRIPTION	MODEL	LIST PRICE	PRICE EXTENSION
3	Gravitation™ Power Beam 60"W	HBEAM60	\$557	\$1,671
4	Gravitation™ Legs 23"H	HBLEG23	\$178	\$712
1	End of Run Power Harness	HMPEEK60	\$298	\$298
2	Power Harness	HH871260	\$286	\$572
4	Duplexes	HH873501	\$58	\$232
4	Duplexes	HH873502	\$58	\$232
4	Duplexes	HH873503	\$58	\$232
2	Gravitation™ Power Beam End Cap	HBENDCP	\$89	\$178

TOTAL: \$4,127

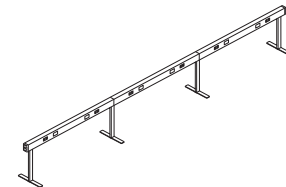

3-PACK — 60"W

QTY	DESCRIPTION	BUNDLE SKU	LIST PRICE BY PAINT GRADE		
			P1	P2	P3
1	3-PACK BUNDLE	HBBDL360	\$4,124	\$4,306	\$4,397

SPECIFYING EXAMPLE: Model.Paint

QTY	DESCRIPTION	MODEL	LIST PRICE	PRICE EXTENSION
4	Gravitation™ Power Beam 60"W	HBEAM60	\$557	\$2,228
5	Gravitation™ Legs 23"H	HBLEG23	\$178	\$890
1	End of Run Power Harness	HMPEEK60	\$298	\$298
3	Power Harness	HH871260	\$286	\$858
4	Duplexes	HH873501	\$58	\$232
4	Duplexes	HH873502	\$58	\$232
4	Duplexes	HH873503	\$58	\$232
4	Duplexes	HH873504	\$58	\$232
2	Gravitation™ Power Beam End Cap	HBENDCP	\$89	\$178

TOTAL: \$5,380

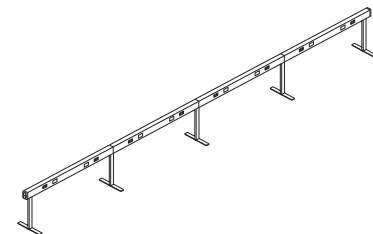

4-PACK — 60"W

QTY	DESCRIPTION	BUNDLE SKU	LIST PRICE BY PAINT GRADE		
			P1	P2	P3
1	4-PACK BUNDLE	HBBDL460	\$5,376	\$5,611	\$5,728

SPECIFYING EXAMPLE: Model.Paint

ⓘ Power in-feeds and port covers are not included in Bundles and must be specified separately.



Icon Legend on page 19

GRAVITATION™ 72"W Bundles

WORKSTATIONS

QTY	DESCRIPTION	MODEL	LIST PRICE	PRICE EXTENSION
1	Gravitation™ Power Beam 72"W	HBEAM72	\$652	\$652
2	Gravitation™ Legs 23"H	HBLEG23	\$178	\$356
1	End of Run Power Harness	HMPEEK72	\$298	\$298
4	Duplexes	HH873501	\$58	\$232
2	Gravitation™ Power Beam End Cap	HBENDCP	\$89	\$178
TOTAL:			\$1,716	

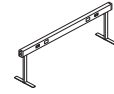

1-PACK – 72"W

QTY	DESCRIPTION	BUNDLE SKU	LIST PRICE BY PAINT GRADE		
			P1	P2	P3
1	1-PACK BUNDLE	HBDL172	\$1,715	\$1,800	\$1,842

SPECIFYING EXAMPLE: Model.Paint

QTY	DESCRIPTION	MODEL	LIST PRICE	PRICE EXTENSION
2	Gravitation™ Power Beam 72"W	HBEAM72	\$652	\$1,304
3	Gravitation™ Legs 23"H	HBLEG23	\$178	\$534
1	End of Run Power Harness	HMPEEK72	\$298	\$298
1	Power Harness	HH871272	\$286	\$286
4	Duplexes	HH873501	\$58	\$232
4	Duplexes	HH873502	\$58	\$232
2	Gravitation™ Power Beam End Cap	HBENDCP	\$89	\$178
TOTAL:			\$3,064	

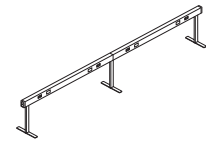

2-PACK – 72"W

QTY	DESCRIPTION	BUNDLE SKU	LIST PRICE BY PAINT GRADE		
			P1	P2	P3
1	2-PACK BUNDLE	HBDL272	\$3,062	\$3,207	\$3,278

SPECIFYING EXAMPLE: Model.Paint

QTY	DESCRIPTION	MODEL	LIST PRICE	PRICE EXTENSION
3	Gravitation™ Power Beam 72"W	HBEAM72	\$652	\$1,956
4	Gravitation™ Legs 23"H	HBLEG23	\$178	\$712
1	End of Run Power Harness	HMPEEK72	\$298	\$298
2	Power Harness	HH871272	\$286	\$572
4	Duplexes	HH873501	\$58	\$232
4	Duplexes	HH873502	\$58	\$232
4	Duplexes	HH873503	\$58	\$232
2	Gravitation™ Power Beam End Cap	HBENDCP	\$89	\$178
TOTAL:			\$4,412	

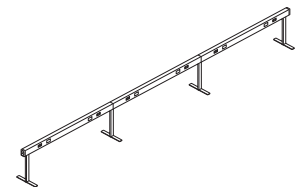

3-PACK – 72"W

QTY	DESCRIPTION	BUNDLE SKU	LIST PRICE BY PAINT GRADE		
			P1	P2	P3
1	3-PACK BUNDLE	HBDL372	\$4,409	\$4,613	\$4,714

SPECIFYING EXAMPLE: Model.Paint

QTY	DESCRIPTION	MODEL	LIST PRICE	PRICE EXTENSION
4	Gravitation™ Power Beam 72"W	HBEAM72	\$652	\$2,608
5	Gravitation™ Legs 23"H	HBLEG23	\$178	\$890
1	End of Run Power Harness	HMPEEK72	\$298	\$298
3	Power Harness	HH871272	\$286	\$858
4	Duplexes	HH873502	\$58	\$232
4	Duplexes	HH873503	\$58	\$232
4	Duplexes	HH873504	\$58	\$232
2	Gravitation™ Power Beam End Cap	HBENDCP	\$89	\$178
TOTAL:			\$5,528	

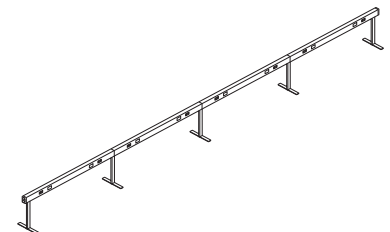

4-PACK – 72"W

QTY	DESCRIPTION	BUNDLE SKU	LIST PRICE BY PAINT GRADE		
			P1	P2	P3
1	4-PACK BUNDLE	HBDL472	\$5,756	\$6,020	\$6,149

SPECIFYING EXAMPLE: Model.Paint

! Power in-feeds and port covers are not included in Bundles and must be specified separately.

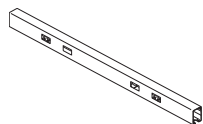

GRAVITATION™ POWER BEAM

**DESCRIPTION****Power Beam**

48"W

60"W

72"W

MODEL**SHIP WEIGHT****CUBE****LIST PRICE BY PAINT GRADE****P1****P2****P3****HBEAM48**

7

0.6

\$508**\$545****\$563****HBEAM60**

9

0.7

\$557**\$597****\$617****HBEAM72**

11

0.9

\$652**\$700****\$723****Beam Legs**

23"H

HBLEG23

5

0.6

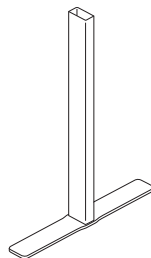
\$178**\$188****\$193****NOTES:**

- Beams and legs specified separately.
 - Order power harness separately to corresponding beam length.
 - Beams ship with mounting brackets for 8-Trac electrical to be installed in the field.
 - Beams ship with internal guides to retain power/data wires during installation (internal wire management).
 - 2 ports for electrical and 2 ports for data are provided on each side of the rail, total of 8 ports.
 - Electrical in-feed can also be accomplished through an electrical knockout (not data) in the face of the rail using a base in-feed.
 - Beam height when installed is 23"H. This height aligns with the Empower® height adjustable trough. Gravitation™ and Coordinate™ can be used as single-sided height adjustable benching.
 - 2-Pack metal port covers specified separately to cover unused power/data ports.
 - Electrical harnesses, duplexes, and power feeds ordered separately.
 - Leveling capability of 1/4" internal to rail for clean aesthetic.
- ⚠ With in-line connections between beams, one leg can be shared. Requires one more leg than the number of beams.
- ⚠ Specify paint; not available in Putty (L), Platinum Metallic (T1), and Champagne Metallic (T4).
- ⚠ When two rails share a leg, the leg is centered between the legs in the "outer slot". When the leg is positioned **at the end of a run of rails** (i.e., the rail doesn't connect to another rail), the leg will be inset 1/8" from the end of the rail, not the end cap, in the "inner slot".

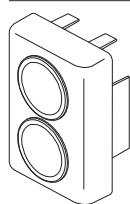
**Power Beam End Cap****HBENDCP**

1

0.1

\$89**\$96****\$99****NOTES:**

- Power can enter into the beam from the floor, wall, or ceiling.
- When using the power pole, please note attachment to beam is up to the installer, as well as field-cutting the power pole to access power and data wires.
- End caps have integral knockout ports with plastic grommets to allow for power/data in-feed (without sharp edges).
- End caps add 1" to the length of the run.

HOW TO SPECIFY

Select Model Number

H B E A M 6 0 .

Select Paint Color



See page 501

P R 6



Icon Legend on page 19

GRAVITATION™ POWER BEAM

	DESCRIPTION	MODEL	SHIP WEIGHT	CUBE	LIST PRICE BY PAINT GRADE		
					P1	P2	P3
 HBPRTCV	Knockout Port Covers, Metal	HBPRTCV	0.5	0.1	\$37	\$40	\$41
 HBCONU	Universal Connector ⓘ Used to change direction of beam (L, T, X). Cannot bring in-feed into Universal Connector; use Power Hubs in these instances (HBXXX23).	HBCONU	2.0	0.1	\$265	\$280	\$287

NOTES:

- Universal Connector is used to change beam direction when power is not coming in at that location. Power Hub will be used to bring in power at a change of connection.
- Port Covers used to cover open power or data ports if not in use, as desired.
- Able to connect rails in T-, X-, or L-configurations.

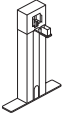
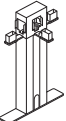
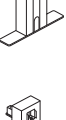
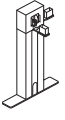
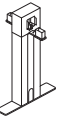
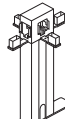
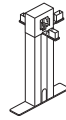
	DESCRIPTION	MODEL	SHIP WEIGHT	CUBE	LIST PRICE BY PAINT GRADE		
					P1	P2	P3
	Power Hub, 23''H End of Run Power Hub	HBEORH23	10	4.0	\$347	\$373	\$384
	End of Run Power Hub, T	HBEORT23	14	4.0	\$383	\$411	\$424
	End of Run Power Hub, L	HBEORL23	13	4.0	\$339	\$364	\$376
	In-Line Power Hub	HBILNH23	13	4.0	\$365	\$392	\$404
	In-Line Power Hub, X	HBILNX23	15	4.0	\$386	\$414	\$427
	In-Line Power Hub, T	HBILNT23	14	4.0	\$368	\$395	\$408
	ⓘ Power Hub is used when electrical needs to enter at a connection. For change of direction only (not bringing in power) use Universal Connector.						

SIN 33721

NOTES:

- Hub connectors allow power to enter the beam by bringing it through the bottom of the hub or knocking out the mouse hole in the hub.
- Specify correct hub based on desired location of power entering the beam.
- ⓘ Power Hub is used when electrical needs to enter at a connection. For change of direction only (not bringing in power) use Universal Connector (HBCONU).
- ⓘ Hubs are dual use — change of direction “connector” (when choosing L, T, or X hubs) and to bring power to the beam; choose Universal Connector if change of direction is needed **without** bringing power to the beam (HBCONU).
- ⓘ Power can enter the beam in six different ways.
 1. Bring in-feed from floor or wall into end of beam with no cover (see local electrical codes to ensure the use of this solution) — metal flexible (HH871912) or Sealtight (HMP144) conduit available based on code compliance.
 2. HH870070 freestanding Power Pole at end of run.
 3. Vertebrae Wire Manager (HBVWM) from end of beam.
 4. 96” Power Pole (HB96PP) with beam Power Pole Connectors (HBPP*K).
 5. Power Hubs (HBXXX23, see above).
 6. Power Hubs (HBXXX23, see above) with 96” Power Pole (HB96PP) with Hub Connectors (HBPPCK).

HOW TO SPECIFY

Select Model Number	Select Paint Color
	See page 501
H B C O N U .	P R 6

GRAVITATION™ POWER BEAM

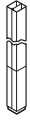

DESCRIPTION

Power Pole — w/o Receptacles
10'5"

MODEL

HH870070

SHIP WEIGHT

14

CUBE

0.5

LIST PRICE

\$570

NOTES: For ceiling in-feed, utilize a freestanding Power Pole placed adjacent to the Power Beam. Power Pole runs to the floor. Specify paint.

⚠ Must be field cut.

⚠ Does not ship with attachment hardware, it is up to the installer to attach Power Pole to the beam.



DESCRIPTION

Power Pole
96"H

MODEL

HB96PP

SHIP WEIGHT

5.0

CUBE

0.9

LIST PRICE BY PAINT GRADE

P1

\$924

P2

\$993

P3

\$1028

NOTES: Power Pole connects to hub or with Mid or End Cap connectors. Power Pole terminates at beam or hub height (does not run to the floor).

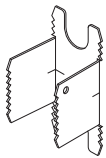

Power Pole Splice Kit

HBPPSK

0.25 Ⓢ

0.1

\$72

N/A

N/A

NOTES: Use Splice Kit to join two Power Poles when one pole does not meet the required ceiling height.

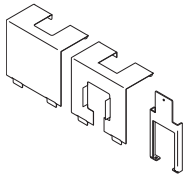

Power Pole Power Hub Connector

HBPPCK

1.0 Ⓢ

0.1

\$72

\$78

\$81

NOTES: Specify when bringing Power Pole into Power Hub.

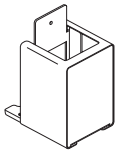

Power Pole End Cap Connector

HBPPEK

1.5 Ⓢ

0.1

\$72

\$78

\$81

NOTES: Specify when bringing Power Pole into the end of a beam.

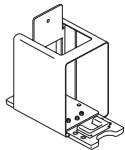

Power Pole Mid Connector

HBPPMK

1.5 Ⓢ

0.1

\$72

\$78

\$81

NOTES: Specify when bringing Power Pole into junction of two beams.



Vertebrae Wire Manager

HBVWM

1.8 Ⓢ

0.2

\$368

\$397

\$411

NOTES: Connects to end of beam — Vertebrae conceals cords entering the beam.



Floor Anchor Bracket

HBFAB

0.2 Ⓢ

0.1

\$32

\$35

\$36

NOTES: Used to connect beam to the floor in situations where the beam needs to be tethered to the ground so users cannot move it.

HOW TO SPECIFY

Select Model Number

HB96PP.







Select Paint Color

See page 501

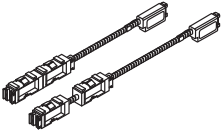
PR6

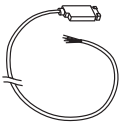
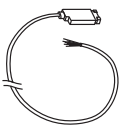
GRAVITATION™ POWER BEAM

Electrical

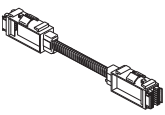
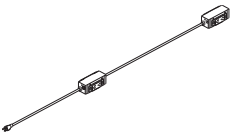
DESCRIPTION	MAX. RECEPT. CAP. PER PANEL SIDE	MODEL		SHIP WEIGHT	CUBE	LIST PRICE
		FOUR-CIRCUIT 3 + 1 2 + 2	THREE-CIRCUIT, SEPARATE NEUTRALS			
 <p>Electrical Power Harnesses, Frames — w/duplex capacity For 48"W For 60"W For 72"W</p>	2	HH871248	HH871248A	3.0	0.5	\$286
	2	HH871260	HH871260A	3.0	0.5	\$286
	2	HH871272	HH871272A	5.0	0.5	\$286
 <p>Abound® Duplex Receptacles Circuit 1 Circuit 2 Circuit 3 Circuit 4 Circuit 1 — 20 amp outlet Circuit 3 (2 + 2)</p> <p><i>Each marked with Circuit Number</i></p>		HH873501	HH873501A	0.5	0.1	\$58
		HH873502	HH873502A	0.5	0.1	\$58
		HH873503	HH873503A	0.5	0.1	\$58
		HH873504		0.5	0.1	\$58
		HH871601	HH871601A	1.0	0.1	\$58
	HH873506		0.5	0.1	\$58	
Specify color.						
 <p>Ceiling In-Feed 144" long conduit, Flex Cable — 7/8" dia. 216" long conduit, Flex Cable — 7/8" dia.</p>		HH871912	HH871912A	4.0	0.5	\$315
		HH871918	HH871918A	4.0	0.5	\$409
<p>⚠ Must be used with Power Pole. Power in-feed models HH871912 and HH871918 plug into the end of any power block. No portion of the cable can be exposed after installation.</p>						
DESCRIPTION		MODEL		SHIP WEIGHT	CUBE	LIST PRICE
 <p>Power In-Feed — Sealtight 144" long conduit, Sealtight Cable — 7/8" diameter</p>		HMP144		7	1.2	\$438
	<p>NOTES: For use as ceiling, floor and wall in-feed. If three-circuit, separate neutral in-feed is required, please contact Tailored Solutions. ⚠ Bend radius of Sealtight in-feed is limited — use in straight entrance applications.</p>					
 <p>HHTADF3</p>  <p>HHTADF4</p>  <p>HHTADJ5 Black only</p>	AMP Data Faceplates					
	Three-port flex-mode faceplate		HHTADF3	1	0.2	\$34
	Four-port flex-mode faceplate		HHTADF4	1	0.2	\$34
<p>⚠ Data faceplates available in Black (E4) only.</p>						
AMP RJ45 CAT 5E Jack — Black (P)		HHTADJ5	1	0.1	\$53	
AMP RJ45 CAT 6 Jack — Black (P)		HHTADJ6	1	0.1	\$72	
<p>Models HHTADJ5 and HHTADJ6 snap into faceplate. NOTES: AMP Data Faceplates attach to bottom of panel or at worksurface height in front of baserail covers for easy cable routing. Faceplates cannot be installed back-to-back in a panel application.</p>						
	End of Run Electrical Kit					
	48"W		HMPEEK48	3	0.5	\$298
	60"W		HMPEEK60	3	0.5	\$298
	72"W		HMPEEK72	5	0.5	\$298
	Soft Wire Power Harness w / In-Feed		HHSWFTWR	5	0.7	\$1215
	<p>⚠ This model is UL listed. It is not covered by the UL registration for the Gravitation™ series. ⚠ Daisy-chain applications are not available with soft wire model.</p>					

HOW TO SPECIFY

Select
Model Number

HH871248

GRAVITATION™ POWER BEAM Screens

OPEN MARKET

WORKSTATIONS

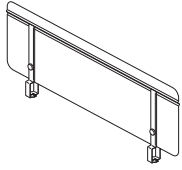

DESCRIPTION

Gravitation™ Metal Screen
48"W x 20"H
60"W x 20"H
72"W x 20"H

MODEL

HUSMGRV2048
HUSMGRV2060
HUSMGRV2072

SHIP WEIGHT

10.0
12.0
14.0

CUBE

3.5
2.3
4.9

LIST PRICE BY PAINT GRADE

P1	P2	P3
\$454	\$490	\$508
\$547	\$590	\$612
\$587	\$633	\$656

NOTES:

- A screen can be mounted above the beam to add privacy.
- Screens ship with mounting hardware.
- Screens are wipeable.
- Screens are magnetic.
- Also available in Markerboard paint.

HOW TO SPECIFY

Select Model Number <input type="text" value="HUSMGRV2048"/>	Select Paint Color See page 501 <input type="text" value="P71"/>
--	---

DESCRIPTION

Gravitation™ PET Screen
48"W x 20"H
60"W x 20"H
72"W x 20"H

MODEL

HUSPGRV2048
HUSPGRV2060
HUSPGRV2072

SHIP WEIGHT

26.5
32.0
37.3

CUBE

2.9
3.4
3.9

LIST PRICE BY PAINT GRADE

P1	P2	P3
\$646	\$655	\$662
\$714	\$723	\$730
\$788	\$797	\$804

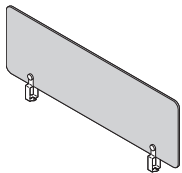

HOW TO SPECIFY

Select Model Number <input type="text" value="HUSPGRV2048"/>	Select PET Color DDB1 Dark Blue DGN1 Green DGY4 Dark Gray DGY3 Medium Gray <input type="text" value="DGN1"/>	Select Paint Color See page 501 <input type="text" value="PR6"/>
--	--	---

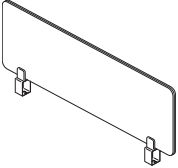
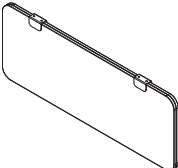

GRAVITATION™ POWER BEAM Screens

DESCRIPTION	MODEL	SHIP WEIGHT	CUBE	LIST PRICE BY FABRIC GRADE		
				AA	A	B
 <p>Fabric Above Screens 48"W x 20"H 60"W x 20"H 72"W x 20"H</p>	HUSFGRV2048	11.4	2.5	\$1040	\$1040	\$1096
	HUSFGRV2060	13.0	3.0	\$1140	\$1140	\$1202
	HUSFGRV2072	14.6	3.6	\$1331	\$1331	\$1407
 <p>Gravitation™ Fabric Modesty Panels 48"W x 13"H 60"W x 13"H 72"W x 13"H</p>	HUSFGRV1348	9.0	1.6	\$817	\$817	\$861
	HUSFGRV1360	10.0	2.0	\$866	\$866	\$915
	HUSFGRV1372	11.0	2.4	\$953	\$953	\$1007

HOW TO SPECIFY

<p>Select Model Number</p> <p>H U S F G R V 2 0 4 8 .</p>	<p>Select Fabric</p> <p>See page 501</p> <p>N B L E 1 8 .</p>	<p>Select Bracket Paint</p> <p>See page 501</p> <p>P R 6</p>
--	--	---

DESCRIPTION	MODEL	SHIP WEIGHT	CUBE	LIST PRICE
 <p>Acrylic Gravitation™ Modesty Panels 48"W x 13"H 60"W x 13"H 72"W x 13"H</p>	HUSAGRV1348	11.2	3.8	\$843
	HUSAGRV1360	12.8	4.7	\$999
	HUSAGRV1372	14.4	5.5	\$1145

HOW TO SPECIFY

<p>Select Model Number</p> <p>H U S A G R V 1 3 4 8 .</p>	<p>Select Bracket Paint</p> <p>See page 501</p> <p>P R 6</p>
--	---

GRAVITATION™ POWER BEAM Screens

OPEN MARKET

WORKSTATIONS

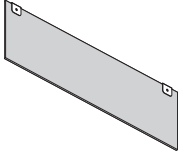

DESCRIPTION	MODEL	SHIP WEIGHT	CUBE	LIST PRICE BY LAMINATE GRADE	
				L1	L2
Gravitation™ Laminate Modesty Panels					
48"W x 13"H	HUSLGRV1348	13.1	3.7	\$519	\$538
60"W x 13"H	HUSLGRV1360	15.1	4.6	\$634	\$661
72"W x 13"H	HUSLGRV1372	17.2	5.4	\$759	\$793

HOW TO SPECIFY

<p>Select Model Number</p> <p>HUSLGRV1348</p>	<p>Select Laminate Color</p> <p>See page 501</p> <p>LFWE</p>	<p>Select Bracket Paint</p> <p>See page 501</p> <p>PR6</p>
---	--	--

SYSTEMS SHARED COMPONENTS

Want to see more?
Scan here to check
out hon.com.



Systems Worksurfaces, Accelerate® Panels, Systems Overhead Storage, Ignition® Seating.

SYSTEMS SHARED COMPONENTS

Panel-based workstations make efficient use of space, giving your people a place of their own that's still part of the action. Modular components are easy to specify and install, so you can configure them just about any which way — and reconfigure fast when your needs change. Systems models integrate seamlessly with Abode, Abound, Accelerate, Empower and Voi models and can be configured to create freestanding or height adjustable workstations.

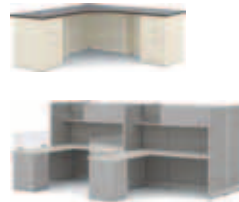

FEATURES

- Systems worksurfaces and supports can be used with Abode, Abound, Accelerate, Coordinate, Empower and Voi products.
- Systems electrical and data components can be used with Abode, Abound, Accelerate and Empower products.
- Systems storage can be used with Abound and Accelerate products.

SYSTEMS OVERHEAD AND SHELVES SPECIFYING

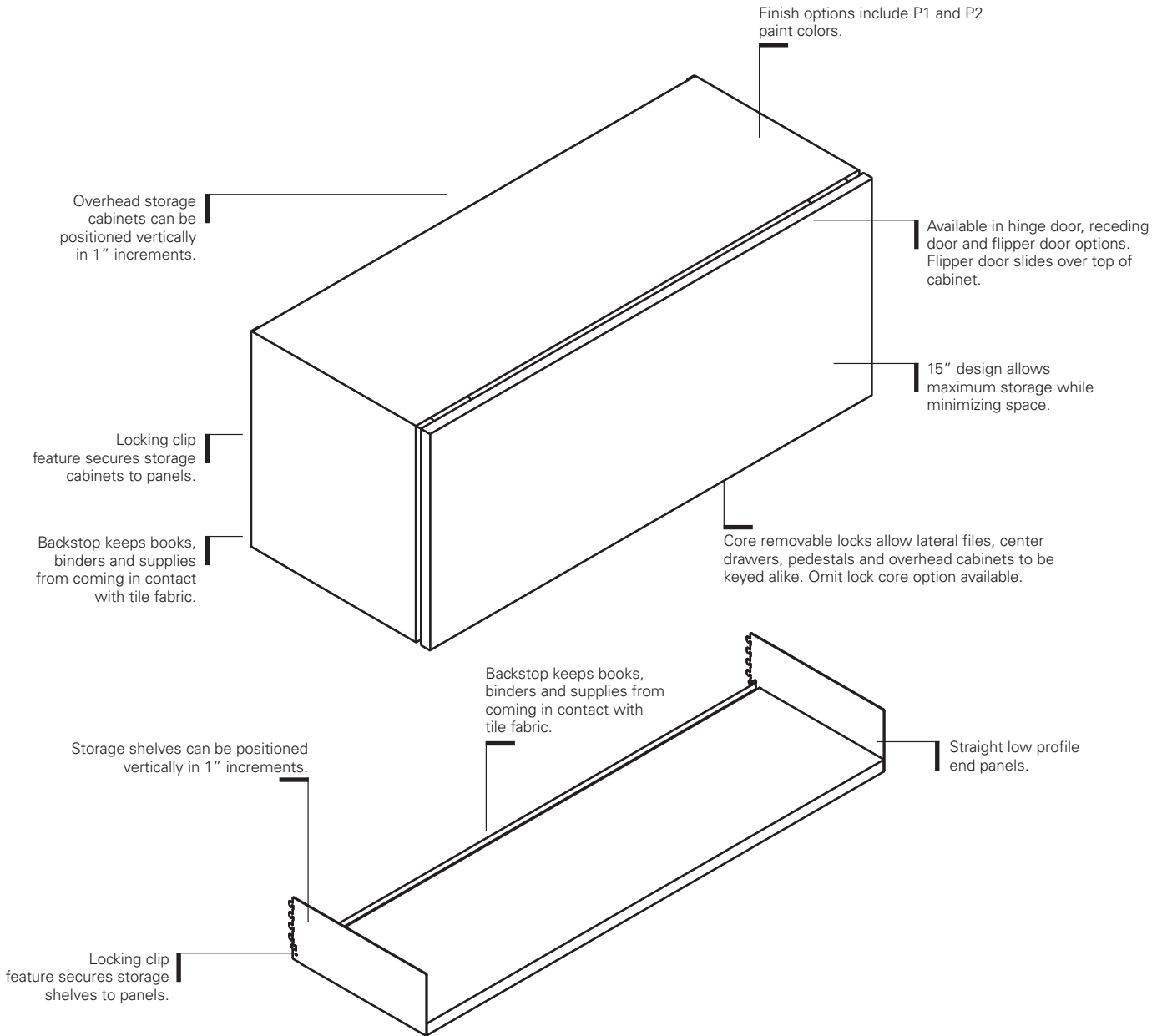

PRODUCT DIMENSIONS

Overhead Storage Cabinet

Width 24", 30", 36", 42", 48", 60"

Inside width Flipper and Receding door — $\frac{3}{8}$ " less than width
Hinged door — $1\frac{3}{4}$ " less than width

Depth $14\frac{7}{8}$ "

Inside depth $12\frac{7}{8}$ "

Height 15"

Inside height $12\frac{3}{4}$ "

Open Shelf

Width 24", 30", 36", 42", 48", 60"

Depth $14\frac{3}{8}$ "

Height $5\frac{5}{8}$ "

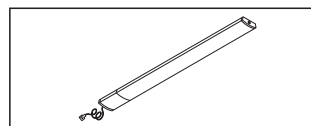

Task lights can be mounted beneath storage shelves and overhead storage cabinets.

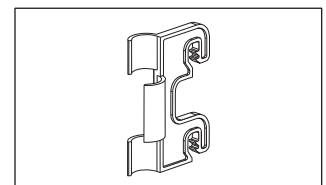

Cord retainer clips fasten into panel slots to anchor power cords. Available in black only. Clips are provided with undershelf mounted task lights.

SYSTEMS OVERHEAD AND SHELVES SPECIFYING

SPECIFICATION GUIDELINES

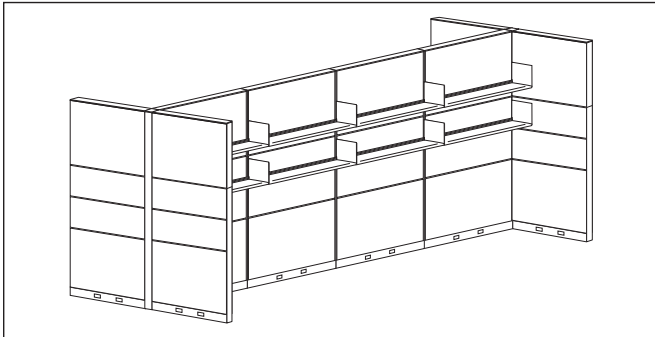

In a panel run, only two overhead storage cabinets or open storage shelves are recommended per panel side. When suspending overhead storage off-module only one storage unit per panel side is allowed.

When overhead storage units are suspended from stacking frames, the following guidelines should be adhered to:

A maximum of two overhead storage units can be suspended from each side of stacking frames on any given panel.

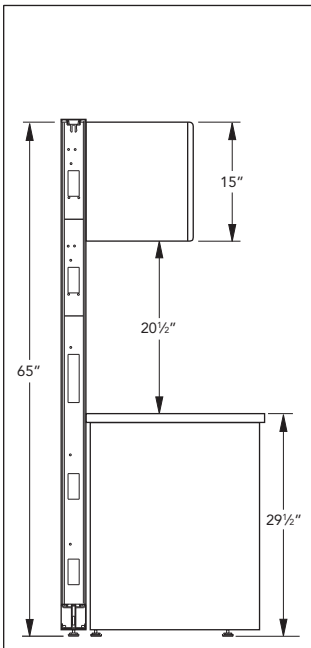

Overhead Storage cabinets and the **Open Shelf** can also be mounted to a maximum height of 65"H on all systems. Voi overheads not to be mounted on Accelerate stackers.

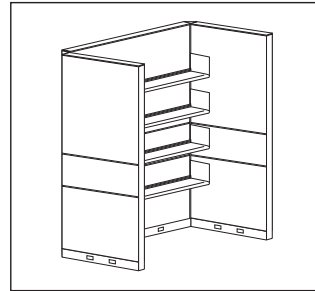

No limitation to the number of units on structural frames when units are spaced 12" apart and when the run is supported with return panels of equal height to the spine wall on each side of storage shelves or overhead storage cabinets.

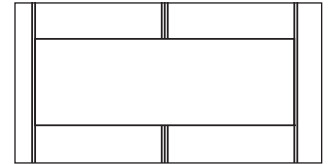

Storage shelf and overhead width must correspond with width of panel(s). It is possible to span two panels when combined panel width equals cabinet or shelf width.

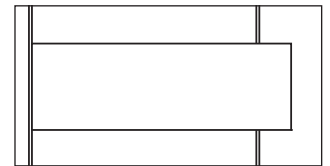

Overhead Cabinets can be mounted on a panel equal to or up to 18" narrower than cabinet.

Not applicable for ETA overheads, Voi overheads, and shelves.

ABOUND® Electrical and Data

Abound® features capabilities for cable management, including electrical, voice, and data. The 8-wire electrical system can be integrated at base pathway and beltline. The open structure of the frame allows voice and data cables to be routed both vertically and horizontally.

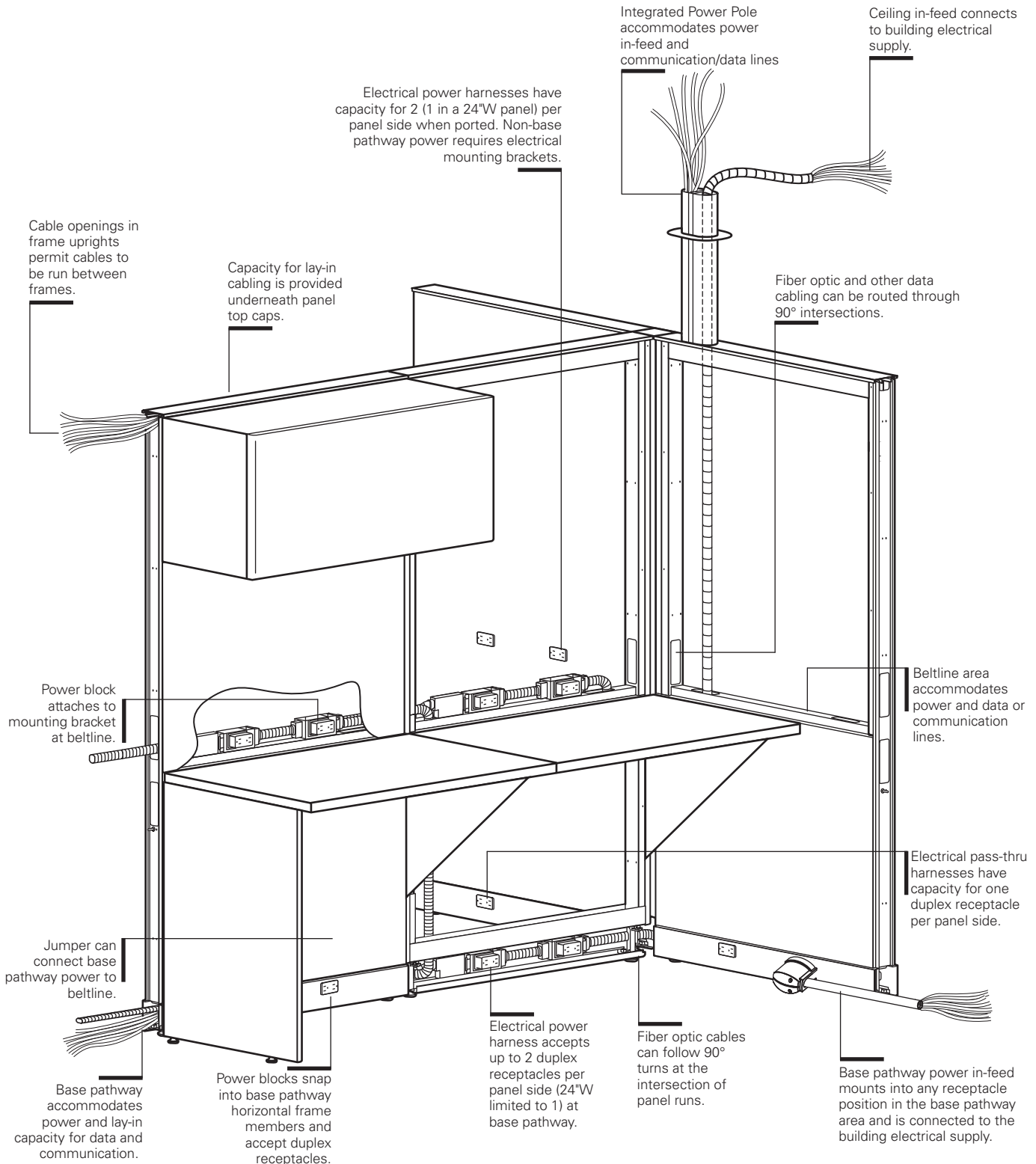

THE ABOUND ELECTRICAL SYSTEMS

Abound offers a choice of three electrical systems:

- Four-circuit, 3 + 1
- Four-circuit, 2 + 2
- Three-circuit, separate neutrals

All three systems utilize an 8-wire electrical system, rated at 20 amps per circuit (15 amps Canadian). See pages 522-523 for a detailed explanation of each electrical system.

Abound frames and electrical components are UL Listed. Electrical components are also CSA certified.

Installation and use of the electrical system, the number of receptacles used on a given circuit and connections to the building power supply should be in compliance with all local and national electrical codes.

Caution: Electrical equipment cords or extension cords MUST NOT BE ROUTED through cable openings in frame sides.

Abound's electrical harnesses are UL listed and are considered raceways themselves as defined by the National Electrical Code. This means there is no separation requirement between the electrical harnesses and communications cables per Sec. 800-52 of the National Electrical Code. Communication cables may be placed next to Abound's electrical components without a metal septum and will still meet the guidelines of the Telecommunications Industry Association for separation of power and data.

IN-FEEDS

Power in-feed cables deliver power from building to system. In-feed cables are housed in conduit to separate electrical system from communications and data lines.

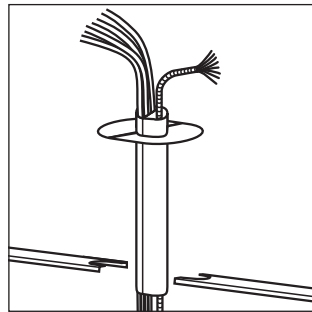

Integrated power and communications poles provide capacity for routing power supply directly through the top of any structural or stacking frame using same width trim/connector kit in place of top cap. Avoid glass or translucent tiles in upper position of frames with integrated power poles. Power pole has a cavity on each side of a center septum. When using a ceiling power in-feed, consider that the in-feed must connect into an electrical harness located in an adjacent panel. (See pages 524-525 for cable capacity.)

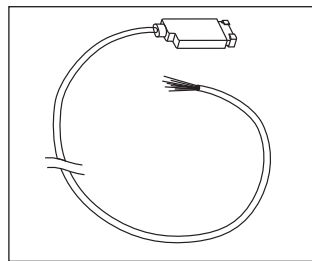

Ceiling power in-feed connects to a prewired electrical harness in the beltline or base pathway, traverses through an adjacent panel and terminates in the junction box at the top of the integrated power pole. For use with integrated power pole models HEP65 and HEP35. No portion of the flex cable can be exposed after installation.

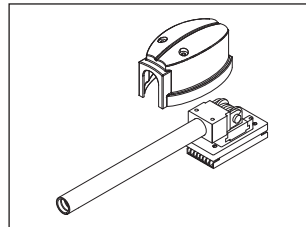

Sealtight base pathway power in-feed attaches to a receptacle opening at the base pathway. A heavy rubber sheathing shields conduit, allowing in-feed to be exposed.

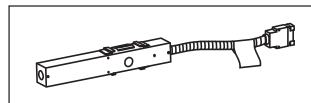

Hardwire (New York Code) power in-feed (model H871400) is used when local electrical codes require hardwire entry. When used in 24"W, 30"W and 36"W panels, power can be routed only in one direction. When used in 42", 48"W and 60"W panels, an electrical pass-thru cable or harness for that panel width can be used to route power back in the opposite direction. Unit must connect to a power or pass-thru harness positioned in the base pathway area of an adjacent panel. Customer to furnish all cabling and wiring from power entry to power source. Junction box can be positioned at any duplex receptacle location.

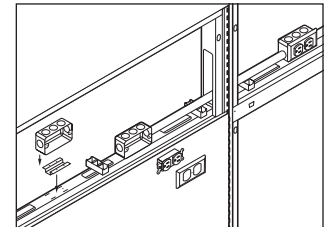

HARDWARE (CHICAGO CODE) JUNCTION BOX

Wiring harnesses and snap connectors are not allowed in Chicago — base pathways must be comprised of all metallic components. Concealed mounting is the only option at beltline. For the base pathway, junction box (model HH873500) clips directly into receptacle locations. Customer must furnish conduit, wiring, standard duplex receptacles with metal covers for the beltline and designer-type receptacles for the base pathway. Power entry can be routed from the ceiling, via an Abound power pole, or from the floor into a junction box (model HH873500).

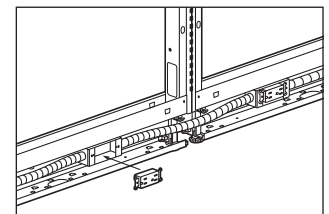

ABOUND[®] Electrical and Data

POWER

Power blocks on electrical power harness and pass-thru harness accept duplex receptacles.

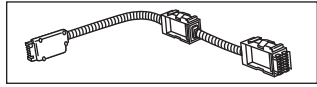

Electrical power harnesses are used to distribute power in panels. Abound electrical can be located at base pathway or beltline only. Connectors at both ends of power harnesses allow power distribution in either direction.

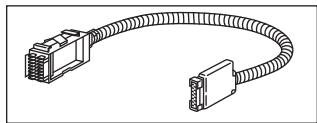

Electrical pass-thru harnesses have capacity to handle one duplex receptacle on each side of the panel when exposed.

A 60" pass-thru harness can be used to jump up to a single duplex receptacle per side at beltline and connecting to a power harness at base pathway.

Electrical power harnesses and pass-thru cables cannot be routed at 90° at beltline once frames are connected to connector blocks.

Electrical pass-thru cables distribute power through any panel where receptacles are not required. Cable length cannot be stretched.

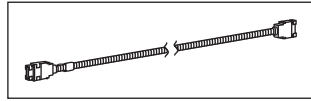

Electrical jumper cables connect power from base pathway or beltline to a harness located on any horizontal member as needed. Jumper cable plugs into power block end of electrical power harness or electrical pass-thru harness.

Model HH871366 is 66" to jump up to 30 inches vertically – base pathway to beltline or beltline to base pathway.

Jumper can also be used from beltline to adjacent beltline at 90° juncture.

POWER BLOCKS

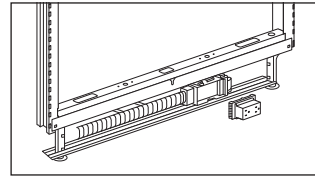

Base pathway mounting: Power blocks snap directly onto brackets in base pathway area.

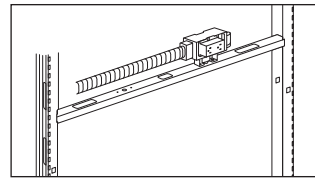

Beltline electrical mounting: For ported receptacles at beltline mount power blocks onto Electrical Mounting Brackets which screw into the panel frame. Electrical Mounting Brackets must be ordered separately. Data/Electrical Port Tiles must be used where exposed receptacles will be located.

RECEPTACLES

Duplex receptacles snap into power blocks of power harnesses or pass-through harnesses. Duplexes are available in multiple colors. Each receptacle is labeled to indicate which circuit it will be connected to.

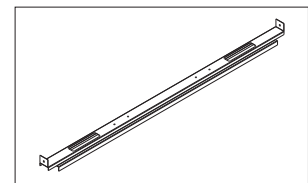
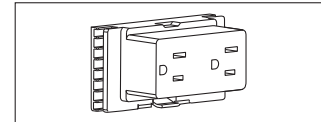

OPTIONAL STIFFENER SUPPORT
Stiffener supports can be used to provide additional rigidity to a panel when fabric tiles are on both sides of the frame. May also be used for routing power/data at non-standard heights.

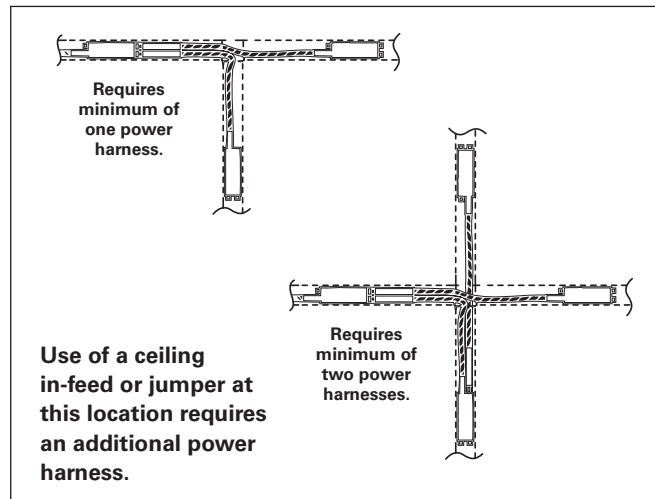

All electrical power harnesses and pass-thru harnesses will stretch 3½", allowing them to span "T" and "X" intersections and "S" extended straight connections.

ACCELERATE® Electrical and Data

Accelerate® features capabilities for cable management, including electrical, voice, and data. The 8-wire electrical system can be integrated at base pathway. See Systems electrical pages 535-540 for electrical models to be used with Accelerate® Systems products. See page 386 for Abound® frame horizontal and vertical wire capacity and page 525 for base pathway capacity.

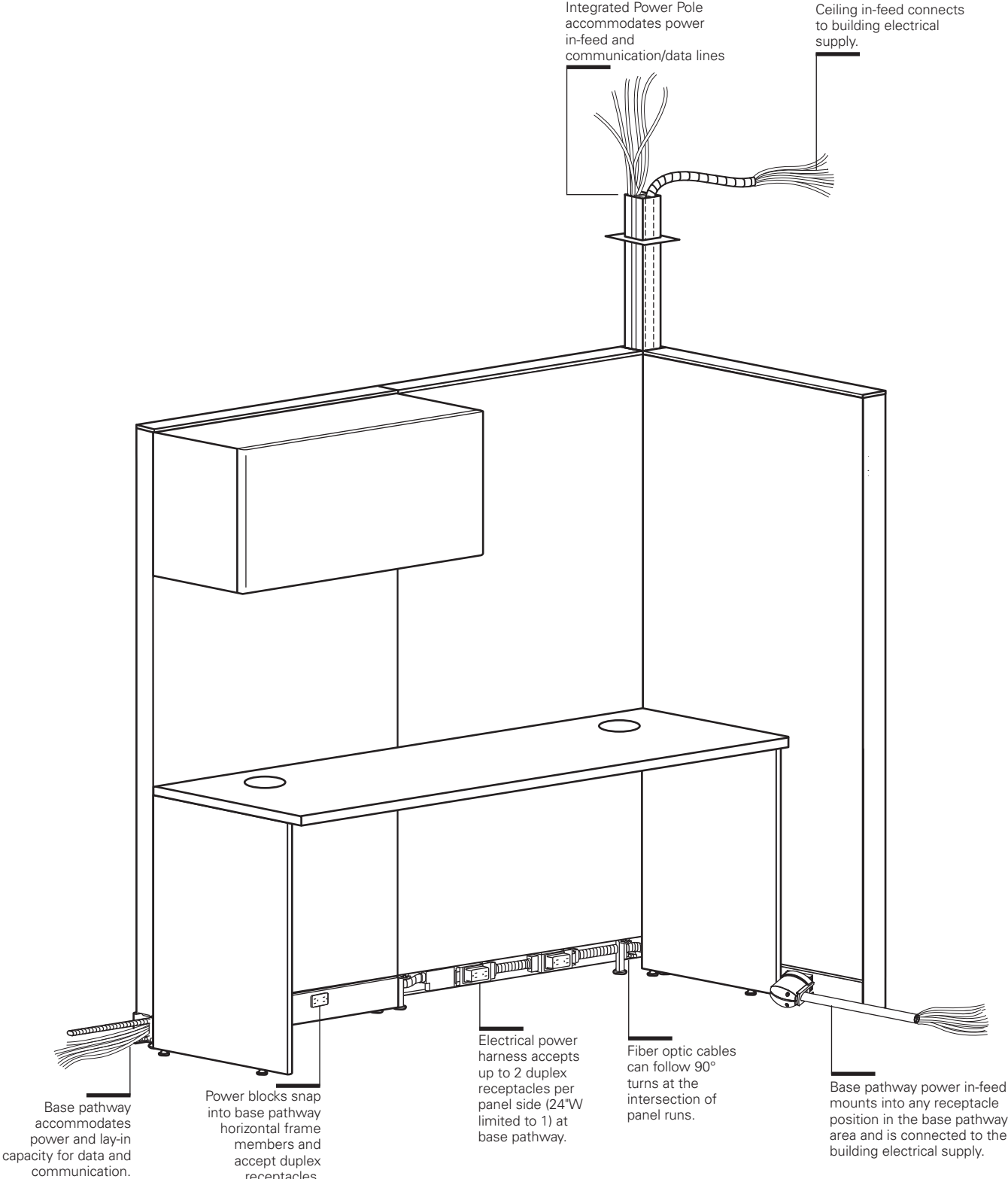

ACCELERATE® Electrical and Data

THE ACCELERATE ELECTRICAL SYSTEMS

Accelerate offers a choice of three electrical systems:

- Four-circuit, 3 + 1
- Four-circuit, 2 + 2
- Three-circuit, separate neutrals

All three systems utilize an 8-wire electrical system, rated at 20 amps per circuit (15 amps Canadian). See pages 522-523 for a detailed explanation of each electrical system.

Accelerate panels and electrical components are UL Listed. Electrical components are also CSA certified.

Installation and use of the electrical system, the number of receptacles used on a given circuit and connections to the building power supply should be in compliance with all local and national electrical codes.

Caution: Electrical equipment cords or extension cords MUST NOT BE ROUTED through cable openings in frame sides.

Accelerate's electrical harnesses are UL listed and are considered raceways themselves as defined by the National Electrical Code. This means there is no separation requirement between the electrical harnesses and communications cables per Sec. 800-52 of the National Electrical Code. Communication cables may be placed next to Accelerate's electrical components without a metal septum and will still meet the guidelines of the Telecommunications Industry Association for separation of power and data.

IN-FEEDS

Power in-feed cables deliver power from building to system. In-feed cables are housed in conduit to separate electrical system from communications and data lines.

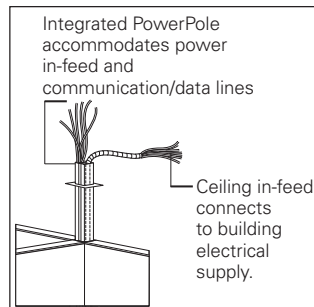

Integrated power and communications poles provide capacity for routing power supply directly through the top of any connector. When using a ceiling power in-feed, consider that the in-feed must connect into an electrical harness located in an adjacent panel. (See pages 524-525 for cable capacity.)

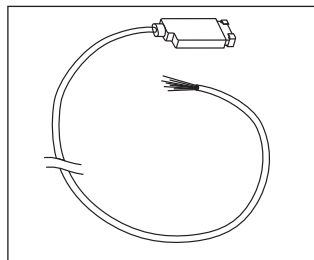

Ceiling power in-feed connects to a prewired electrical harness in the beltline or base pathway, traverses through an adjacent panel and terminates in the junction box at the top of the integrated power pole. For use with integrated power pole models HECPP. No portion of the flex cable can be exposed after installation.

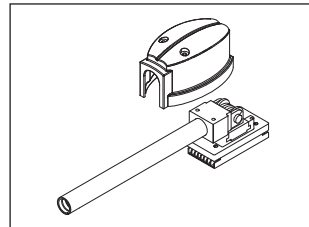

Sealtight base pathway power in-feed attaches to a receptacle opening at the base pathway. A heavy rubber sheathing shields conduit, allowing in-feed to be exposed.

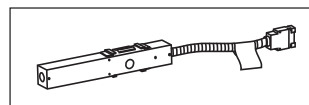

Hardwire (New York Code) power in-feed (model H871400) is used when local electrical codes require hardwire entry. When used in 24"W, 30"W and 36"W panels, power can be routed only in one direction. When used in 42", 48"W and 60"W panels, an electrical pass-thru cable or harness for that panel width can be used to route power back in the opposite direction. Unit must connect to a power or pass-thru harness positioned in the base pathway area of an adjacent panel. Customer to furnish all cabling and wiring from power entry to power source. Junction box can be positioned at any duplex receptacle location.

HARDWARE (CHICAGO CODE) JUNCTION BOX

Wiring harnesses and snap connectors are not allowed in Chicago — base pathways must be comprised of all metallic components. Concealed mounting is the only option at beltline. For the base pathway, junction box (model HH871500) clips directly into receptacle locations. Customer must furnish conduit, wiring, standard duplex receptacles with metal covers for the beltline and designer-type receptacles for the base pathway. Power entry can be routed from the ceiling, via an Accelerate power pole, or from the floor into a junction box (model HH871500). See Systems electrical pages 535-540 for electrical models to be used with Accelerate® Systems products.

DUPLEX RECEPTACLES

For Duplex Receptacle models that can be used on Accelerate® panel systems, please see page 538.

All Systems electrical components can be found on pages 535-540.

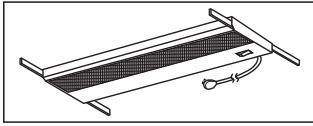

LIGHTING

Task lights can be recessed under storage cabinets or storage shelves.

Task lights in four sizes are available to correspond to cabinet or shelf width. They have 9' power cords in black, connected in the right rear corner. All models feature LED light strip for improved light quality. Task lights with a fused plug to meet Chicago electrical code are also available.

Recommendation: Provide a separate circuit for task lights for proper long-term operation without RF interference to computers that may be in use.

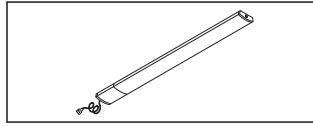

LED TASK LIGHTS

No finish specification required. Attaches magnetically to underside of overhead storage, or attaches with provided screws.

Occupancy sensor attaches to a single or starter LED light and will automatically turn the light off after no motion is detected for 30 minutes.

Just like all the LED light models, the occupancy sensor features a soft-touch on/off switch. LED task lights have a lifetime of 50,000 hours and have a dimmer feature that allows the user to adjust the amount of light output.

Daisy chain options are available. To use the daisy chain application, must start with model HLED17A or HLED31A.

VOICE/DATA RECEPTACLES

Abound not only provides space for large volumes of voice and data cables, it also offers several means of mounting commercially available voice and data components.

Commercially available modular data faceplates can be mounted in vacant base receptacle openings or can be mounted in data/electrical port tiles above or below the worksurface.

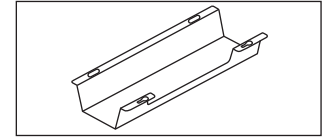

Cable management troughs attach to worksurfaces with provided screws. The graphite metal troughs are designed with cord access cut outs. These cut outs give users access to inside the trough without having to detach it from the worksurface.

SYSTEMS ELECTRICAL SPECIFYING INFORMATION

To Order:

1. Determine which electrical system you will use after consulting your electrician and computer support personnel:

- **The Four-circuit system (4-Hot/2-Neutral/2-Ground)**
 - 3 + 1 option
 - 2 + 2 option
- **The Three-circuit system (3-Hot/3-Neutral/2-Ground)**

2. Determine location, quantity and circuit of duplexes.
3. Determine the appropriate choice and use of Isolated, Isolated/Dedicated and Separate Neutral circuits.
4. Specify appropriate Power Harnesses* and Pass-Thru Cables.*
5. Determine the location, quantity and type of Power In-feed needed.

* Select Power Harness models (HH8712XX) and Pass-Thru Cables (HH8711XX) with the last two digits being 1" (or 2") smaller than the associate panel width.

Electrical System Options

The four-circuit, eight-wire electrical system is widely specified and trusted by hundreds of thousands of end-users. This proven system delivers four circuits for every power in-feed in either a 3 + 1 or 2 + 2 configuration. The isolated/dedicated circuits are ideal for sensitive computing equipment, while the common circuits are suitable for faxes, copiers, task lights and other peripherals.

Both the 3 + 1 and 2 + 2 systems use the same pre-wired components, making it easy to adjust as electrical needs change.

You can also choose a three-circuit, eight-wire system that has a dedicated neutral for every hot circuit. The three-circuit components have model numbers with an "A" suffix and appear in a gray box in this pricer.

Four-circuit, 3 + 1 Receptacle Option

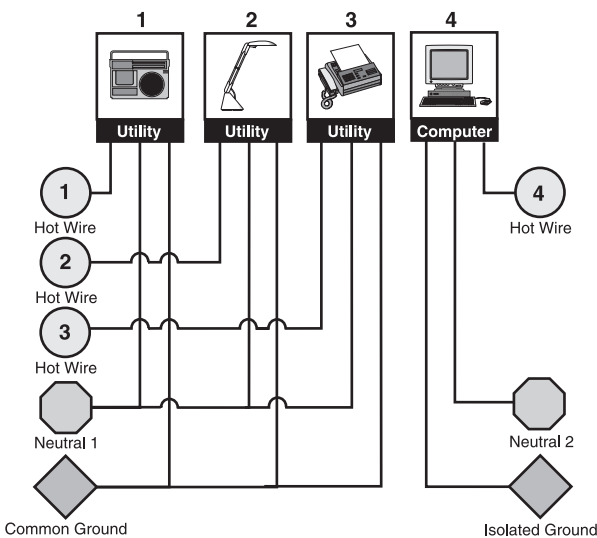

The 3 + 1 option is the electrical standard used by The HON Company for many years in most of their systems products. This wiring option provides three utility circuits plus an isolated/dedicated circuit for more sensitive equipment.

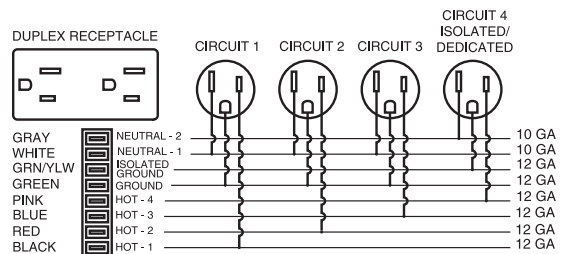

Four-circuit, 2 + 2 Receptacle Option

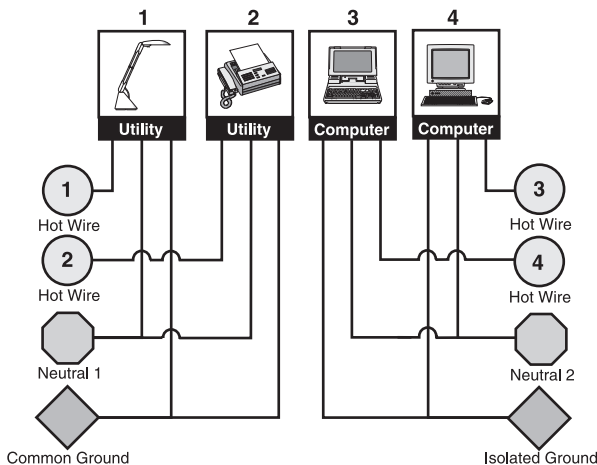

The 2 + 2 option is a wiring option that provides two utility circuits and two isolated circuits for more extensive computer usage applications.

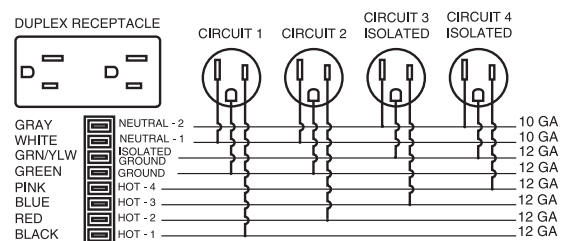

SYSTEMS ELECTRICAL SPECIFYING INFORMATION

Three-circuit, separate neutrals

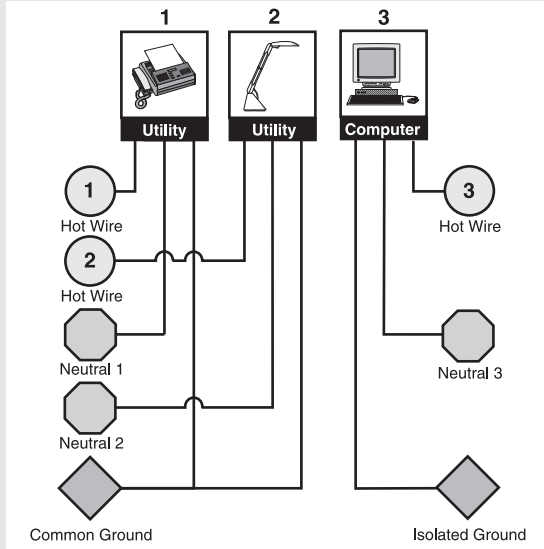

The Three-circuit, separate neutrals configuration is a wiring option that provides separate neutrals for each of the three circuits. Two circuits share a common ground, and one circuit is isolated/dedicated. The three-circuit components have model numbers with an "A" suffix and appear in a gray box in this pricer.

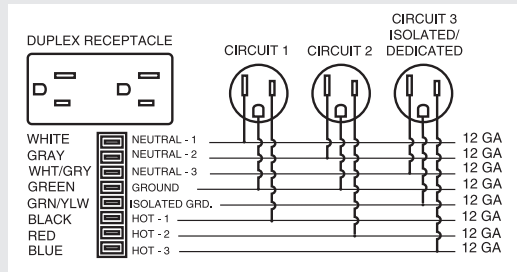

Two 8-wire, 20 AMP (15 AMP Canadian) electrical systems are offered					
Electrical System	Circuitry	Receptacle Capacity			
Four-circuit 4-Hot/2-Neutral/2-Ground (10 gauge neutral wires)	3 + 1	Common Circuit-1 HH873501	Common Circuit-2 (1) HH873502	Common Circuit-3 HH873503	Iso/Dedicated Circuit-4 HH873504
	2 + 2	Common Circuit-1 HH873501	Common Circuit-2 HH873502	Isolated Circuit-3 HH873506	Isolated Circuit-4 HH873504
Three-circuit 3-Hot/3-Neutral/2-Ground (12 gauge neutral wires)	w/separate neutrals	Common Circuit-1 HH873501A	Common Circuit-2 HH873502A	Iso/Dedicated Circuit-3 HH873503A	N/A

(1) Circuit-2 (one of the 3 common circuits sharing a neutral wire) cannot be used with a single-phase building electrical supply.

Notes:

- Four-circuit components and three-circuit components (with suffix "A") cannot be used together.
- Components of the two systems are keyed differently to prevent components of one system from being connected to components of another system.
- HON Cat. Nos. are printed on the UL labels, and components are color-coded to provide visual identification of the different components.
- Four-circuit components have black plastic parts.
- Three-circuit components have rust-colored terminal ends and receptacle backs are rust colored.

Typical power usage by the most commonly specified office equipment.

Source: Industry Analysis, Inc., Rochester, NY

EQUIPMENT	AMPS	EQUIPMENT	AMPS	EQUIPMENT	AMPS
Computers		Copiers		FAX Machines	
Personal Computer	3	Desktop Copier	15	InkJet FAX	less than 1
Notebook Computer	3	Console Copier	20	Thermal FAX	less than 1
		Copier/Duplicator	30	Plain paper FAX	8
Monitors		Printers		Task Lights	
13" Color Monitor	2	Dot Matrix	less than 1	36" T8 Fluorescent	0.2/bulb
17" Color Monitor	3	InkJet	less than 1	48" T8 Fluorescent	0.3/bulb
21" Color Monitor	4	Personal Laser or LED	8		
		Workgroup Laser or LED	15		

Duplex Receptacles



15 AMP Receptacle

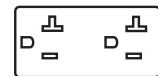

20 AMP Receptacle
(Required by some large copiers.)

SYSTEMS ELECTRICAL SPECIFYING INFORMATION

- Abound and Accelerate panels are UL listed.
- Electrical components are UL Listed and CSA Certified.
- It is the customer's responsibility to ensure that use of the pre-wired electrical system, the number of receptacles used on a given circuit, and connection to a building power source, be in compliance with all local and national electrical codes.
- Contact Customer Service for additional information.
- Pedestals and Lateral Files, positioned under worksurfaces, may render some receptacles inaccessible, and may prohibit use of grommets.
- Four-circuit components and Three-circuit components (with suffix "A") cannot be used together. See pages 522-523.
- Three-way panel connections require at least one power harness.
- Four-way panel connections require at least two power harnesses.
- A licensed electrician must make connections to a building electrical supply.

Definition of components:

Electrical Power Harness

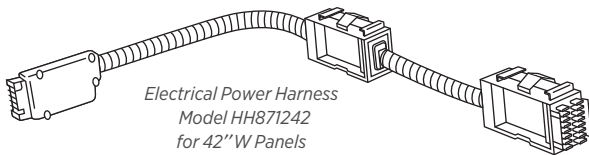

- Used to distribute power in panels.
- Power distribution in either direction.
- Specify Power Harness to match panel width.
- Double-sided: receptacles can be inserted into both sides of Power Blocks.

- ❗ Three-way panel connections require at least one power harness.
- ❗ 4-way panel connections require at least two power harnesses.

Electrical Pass-Thru Cables

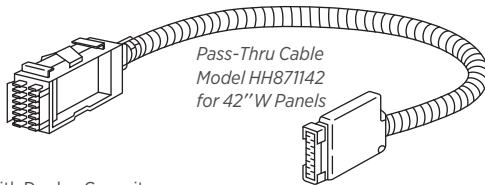

Pass-Thru Cable With Duplex Capacity:

- Use in panels where multiple receptacles are not required.
- Added feature: has capacity for one receptacle on each side of a panel. Feature offers future expansion and is an alternative to Power Harnesses.

Various Electrical Layouts



Straight Line

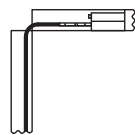

90 Degree Corner

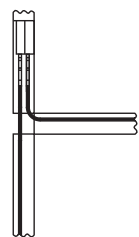

"T" Connection

When ending power in two return panels, wiring pigtails must be returned to original panel run.

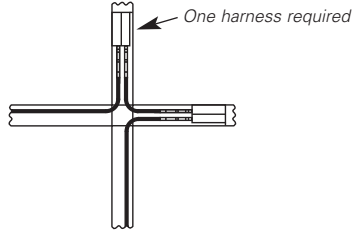

"X" or Cross Connection

To power a 4-way panel connection from one direction, specify at least two double block harnesses.

Duplex Receptacles

- 15 amp outlet configuration.
- Models HH871601 and HH871601A have a 20 amp outlet configuration.
- Fit back-to-back into the Power Block(s) of Power and Pass-Thru Harnesses.
- Labeled with the provided circuit. Circuits connected to the Isolated Ground are identified with an orange triangle; circuits that do not share a neutral or ground have an orange circuit number.

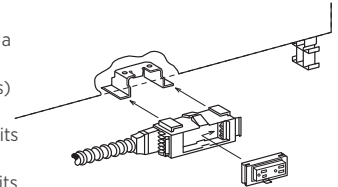

Power In-Feed (Base) Models HH879072 (72") and HH879168 (168")

- Used to connect the panel electrical system to the building electrical supply at a power block.
- Plugs into any receptacle position; can be rotated Left or Right.
- Conduit is UL listed Black Liquid-tight conduit (outside diameter is 7/8").

- ❗ A licensed electrician must make connections to a building electrical supply.
- ❗ Must be positioned through a receptacle opening in the baserail cover, prior to an electrician connecting to the power source.

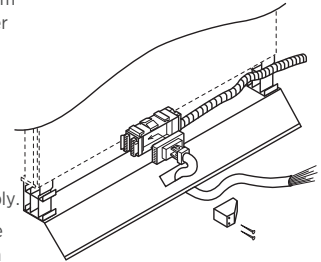

Power In-Feed Model (Ceiling) HH871912 and HH871918

- Used to connect the panel electrical system to the building electrical supply.
- ❗ A licensed electrician must make connections to a building electrical supply.
- ❗ Model uses UL recognized flex-cable conduit — no portion can be left exposed (i.e., must be in a power pole).
- ❗ Power Pole must be ordered separately.

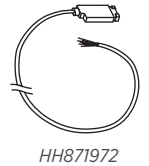

HH871912

Note: In-feed cables listed above may be field-cut to desired length.

Electrical Jumper Cables

- ❗ When used to connect power between the base pathway and the beltline area, the jumper must be connected to a power block at one end of a run, routed into an adjacent panel that does not contain a power harness, then routed back into the panel containing a power harness or pass-thru cable and connected to a power harness in the other pathway.

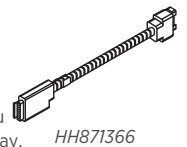

HH871366

Abound Electrical Mounting Brackets

- Use to mount ported receptacles at beltline.
- Screw into the panel frame.
- ❗ One mounting bracket required at beltline for each 24" W pass-thru or power harness. Two required for 30"-60" W power harness.

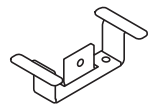

HH8988EBN

WORKING WITH CABLE MANAGEMENT

Base Pathway Receptacle Locations

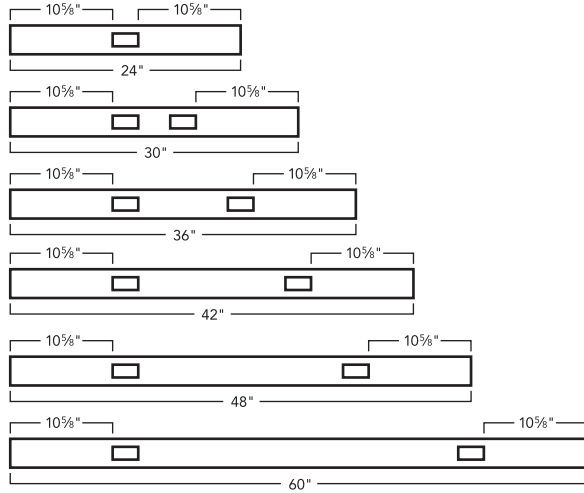

Abound® Lay-in Cable Capacity

The top and base pathway allow continuous voice and data lines to run through and between panels without interruption. Lay-in is provided for environments where systems furniture or cabling are subject to frequent change. All capacities are for Cat 6 cable with a 0.25" diameter.

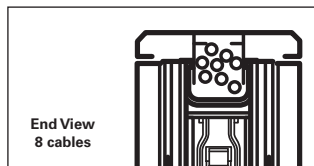

Top pathway accepts up to 8 voice/data cables (.25" dia.).

Circuit Usage

Strategy 1

Circuits to Equipment

Assign specific uses for each of the circuits:

- For example, in a four-circuit system:
 - Circuit 1* – Calculators, fans, etc.
 - Circuit 2* – Task lights (could be wired to wall switch)
 - Circuit 3* – Computer monitors
 - Circuit 4* – CPUs

Strategy 2

Circuits to Workstations

Assign specific workstations to each of the three available circuits. Use circuit 4 for power-sensitive electronic equipment.

Placement of pedestals and lateral files may render some duplex locations inaccessible. Pedestal placement may also affect compatibility with pull-up receptacles.

Abound® Lay-In Cable Capacity

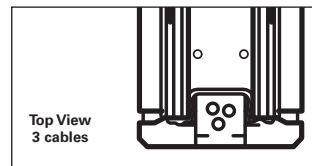

Variable height junctions accept up to 3 voice/data cables (.25" dia.).

Abound® Cable Capacity

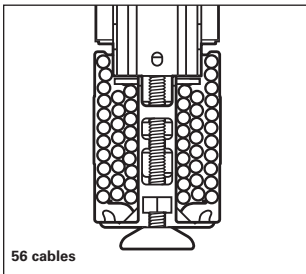

Abound® base pathway accepts up to 56 voice/data cables (.25" dia.) (6.03 sq. in.) at 60% fill.

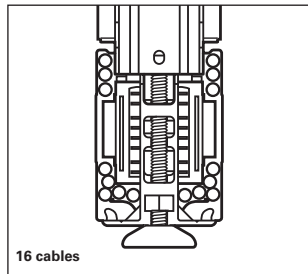

When electrical system shares base pathway, the cable capacity in Abound is reduced to 16 cables (2.25 sq. in.). Cable quantities listed are at 60% fill ratio.

Accelerate® Cable Capacity

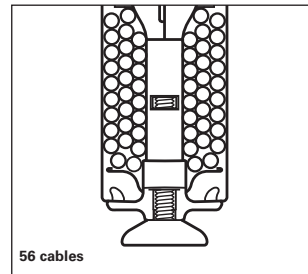

Accelerate® base pathway accepts up to 56 voice/data cables (.25" dia.) (6.27 sq. in.) at 60% fill.

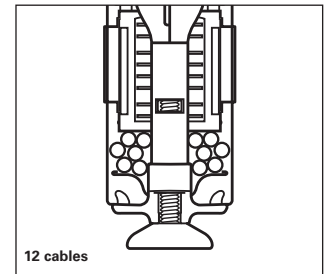

When the electrical system shares the base pathway, the cable capacity in Accelerate® is reduced to 12 cables (.25" dia.) (2.03 sq. in.) at 60% fill ratio.

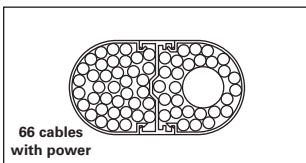

Cable capacity of the power pole, in addition to electrical in-feed is 2.79 sq. in. on one side and 2.91 sq. in. on the other for a total capacity of 66 cables with power of .25" diameter.

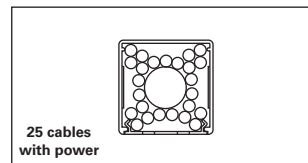

Integrated Power Pole: 2" x 2" overall, 3.3" interior accommodates a total of 25 cables with power of .25" diameter. Available in two heights: 6'6" or 13', the power pole connects via the universal connector and the overall height is the sum of the connector and the power pole. Constructed of aluminum with a powder coat paint finish in the specified color. Power pole requires a Ceiling In-Feed.

Ceiling In-Feeds: UL listed as raceways. This means the electrical components are completely shielded and meet any requirements for separation of electrical components and communications cables per Section 800-52 of the National Electrical Code.

SYSTEMS

Working with Worksurfaces and Supports

Worksurfaces are 1½" thick with particle-board core and with top surfaces finished in high-pressure laminate. Bottom surfaces are covered with a backer sheet.

Worksurface bracket kits support worksurface by attaching to an adjacent return panel the same width as the worksurface depth. Brackets allow one end of a worksurface to be supported by a panel return.



Cantilever brackets can be inserted into panel reveals in 1" vertical increments. Left or right handed. One size is used for both 24"D and 30"D worksurfaces. 18" Cantilever brackets are used for 18"D worksurfaces. DO NOT USE cantilever brackets at the end of a worksurface where no return panel is positioned or in worksurface runs longer than 72"W.

Wire management grommets are standard in most worksurfaces (unless "no grommet" worksurfaces selected).

Corner worksurfaces optimize use of space, and provide a convenient location for computer and monitor.

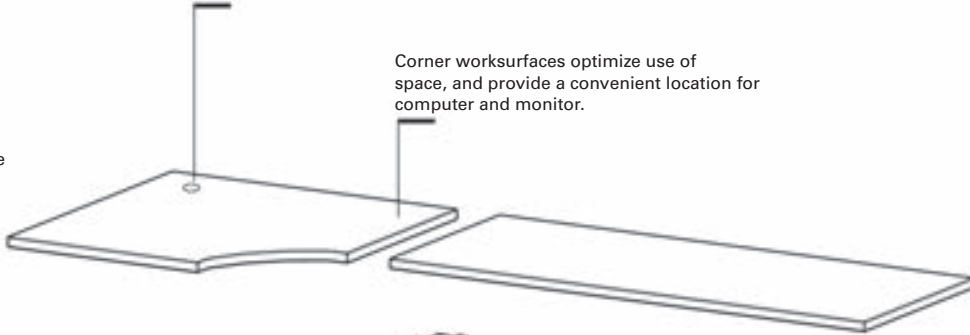

Flat brackets can be used to connect one worksurface perpendicular to another worksurface.

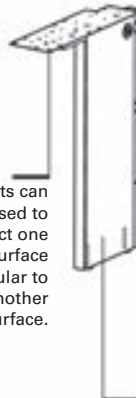

End-panel supports are used at the end of a run when no return panel is present. Straight worksurfaces adjacent to 120° connections must be supported by full end panels. Leveling glides provide 2¾" of adjustment.

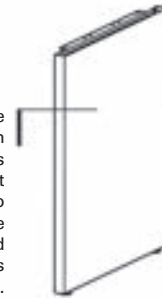

Support legs are used to support worksurfaces only in a shared position.

Primary worksurfaces are available in 18", 24" and 30" depths. Nominal worksurface width is equal to nominal panel width. Other support hardware is ordered separately.

Corner worksurfaces with woodgrain laminate have grain direction diagonal to adjacent worksurfaces. All other support hardware is ordered separately.

Wire management grommets are standard in most worksurfaces. Worksurfaces less than 48"W have one grommet centered on edge of worksurface. Rectangular worksurfaces over 42"W have two grommets. Peninsulas have one grommet. Corner Worksurfaces have one grommet (one on each back edge). D-Shaped worksurfaces and countertops do not have grommets.

Edgeband is available on laminate tops in standard colors (customer specified) to match or complement solid, patterned, or woodgrain laminates.

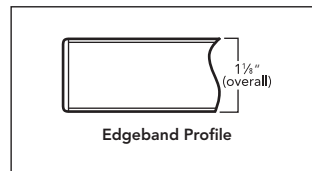

Working with Worksurfaces and Supports

Optional width worksurfaces are available for use with panel runs having a TEE or Extended Straight connection.

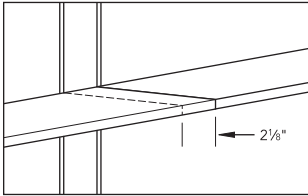

Worksurfaces can be configured at 29 1/2" with end-panel supports and support legs, or at various heights on 1" increments using specific product configurations.

Worksurface support options include:

- Open leg models
- Support column
- Flat brackets
- Worksurface bracket kit
- Cantilever bracket
- Universal support leg
- End-panel support
- Freestanding pedestal

Other worksurface supports include:

- Support columns
- External channel supports
- Support pedestals
- Pedestals with panel-to-pedestal bracket
- Desking freestanding shared leg

Support Guidelines:

- Unsupported panel runs greater than 72"W need floor support for improved stability.
- Worksurface bracket kit should be used to tie panels to worksurfaces for added stability.
- A panel run without a return needs a floor support.
- Unsupported worksurface spans of 60"W-84"W require an external worksurface support channel. It is recommended for 48"W-60"W.
- Cantilevers only to be used on worksurface runs 48"W or less.

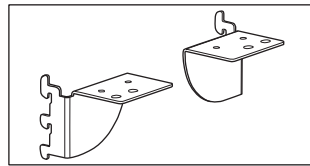

Worksurface bracket kit allows one end of a worksurface to be supported by a return panel. Return panel width must be the same as the depth of the worksurface.

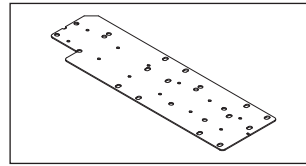

Flat brackets can be used to connect one worksurface perpendicular to another worksurface.

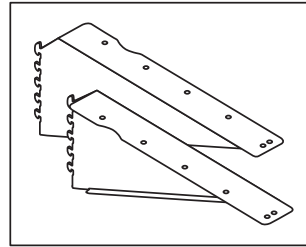

Cantilever brackets are left or right handed. They can be inserted into panel reveals in 1" vertical increments. One size is used for both 24" and 30"D worksurfaces. 18" Cantilever brackets are used for 18"D worksurfaces. Both left and right brackets are required in shared applications.

Important: Do not use cantilever brackets at the end of a worksurface where no 90° return panel is positioned.

- Do not use to support worksurfaces from which a hanging pedestal is suspended, or which a peninsula worksurface is attached.
- Do not use to support worksurfaces supported with permanent wall hanger kit.

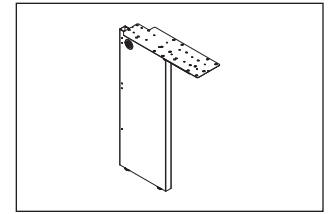

Universal support legs are used to support worksurfaces only in a shared position.

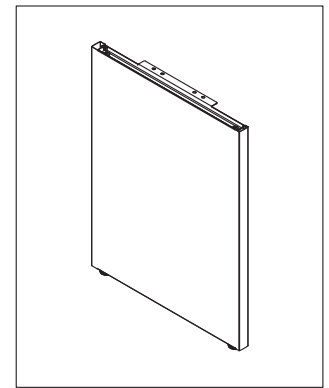

End-panel supports are used in place of return panels at the end of worksurface runs. Straight worksurfaces adjacent to 120° connections must be supported by full end panels. End-panel supports are ordered for right- or left-handed application. Leveling glides provide 1/2" of adjustment.

SYSTEMS

Working with Worksurfaces and Supports

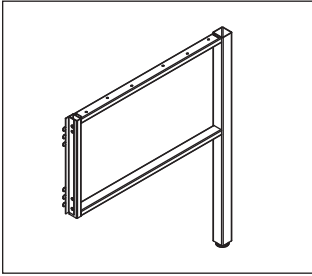

Open Leg models are used to support various worksurface configurations and include attaching hardware and leveling glides.

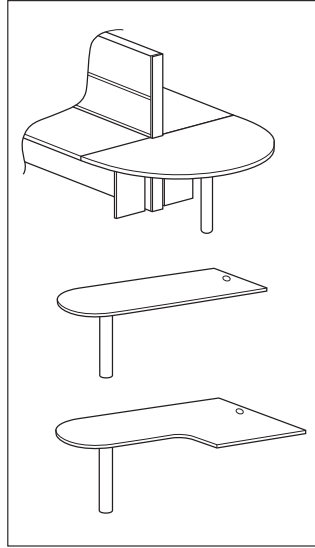

D-Shaped, Peninsula and Jetty worksurfaces require support columns (ordered separately).

Countertops are available in straight or corner configurations.

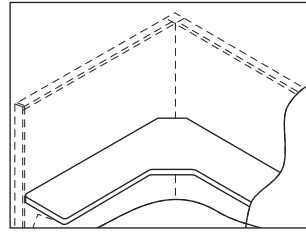

Corner shelves are available in Edgeband. Attachment brackets are included.

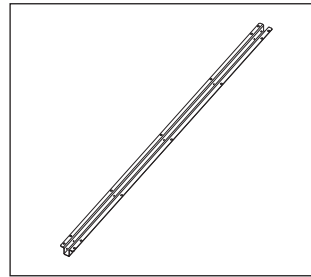

- Unsupported worksurface spans of 60"W-84"W require an external worksurface support channel. It is recommended for 48"W-60"W.

EXTERNAL CHANNEL SELECTION GUIDE

Support Combination		Rectangle Worksurface Width			
		Recommended		Required	
Worksurface End Support 1	Worksurface End Support 2	54	60	66	72
End Panel	End Panel	42"	48"	54"	60"
End Panel	Pedestal	NA	NA	NA	42"
End Panel	Worksurface Brackets	42"	48"	54"	60"
End Panel	Cantilever	42"	48"	54"	60"
End Panel	Open Leg	42"	48"	54"	60"
Pedestal	Pedestal	NA	NA	NA	NA
Pedestal	Worksurface Brackets	NA	NA	NA	42"
Pedestal	Cantilever	NA	NA	NA	42"
Pedestal	Open Leg	NA	NA	NA	42"
Worksurface Brackets	Worksurface Brackets	42"	48"	54"	60"
Worksurface Brackets	Cantilever	42"	48"	54"	60"
Worksurface Brackets	Open Leg	42"	48"	54"	60"
Height Adjustable Base	NA	42"	48"	54"	60"

See page 191 for External Channel models.

Supports above are recommended for worksurfaces 54"W or 60"W. For 66"-72" worksurfaces, the supports are required.



Icon Legend on page 19

SYSTEMS Overhead and Shelves

WORKSTATIONS

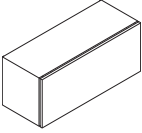
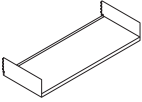
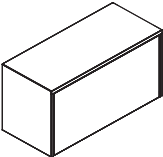
	DESCRIPTION	MODEL	SHIP WEIGHT	CUBE	LIST PRICE BY PAINT GRADE	
					P1	P2
	Metal Flipper Door Overheads					
	24"W x 14 3/8"D x 15"H	HRVOH24FM	35	3.6	\$715	\$767
	30"W x 14 3/8"D x 15"H	HRVOH30FM	38	4.4	\$727	\$779
	36"W x 14 3/8"D x 15"H	HRVOH36FM	41	5.3	\$761	\$813
	42"W x 14 3/8"D x 15"H	HRVOH42FM	46	6.1	\$798	\$850
	48"W x 14 3/8"D x 15"H	HRVOH48FM	52	6.9	\$835	\$887
	60"W x 14 3/8"D x 15"H	HRVOH60FM	62	8.6	\$1099	\$1151
	72"W x 14 3/8"D x 15"H	HRVOH72FM	82	10.6	\$1259	\$1311
	Open Shelf					
	24"W x 14 3/8"D x 5 1/2"H	HRVSH24	13	1.2	\$309	\$327
	30"W x 14 3/8"D x 5 1/2"H	HRVSH30	15	1.5	\$335	\$353
	36"W x 14 3/8"D x 5 1/2"H	HRVSH36	16	1.8	\$357	\$375
	42"W x 14 3/8"D x 5 1/2"H	HRVSH42	17	1.9	\$370	\$388
	48"W x 14 3/8"D x 5 1/2"H	HRVSH48	18	2.3	\$386	\$404
	60"W x 14 3/8"D x 5 1/2"H	HRVSH60	20	2.9	\$473	\$491
	72"W x 14 3/8"D x 5 1/2"H	HRVSH72	32	3.6	\$616	\$634
	Receding Door Overhead					
	30"W x 13 3/8"D x 15"H	HRVOH1530RM	38	5.7	\$922	\$978
	36"W x 13 3/8"D x 15"H	HRVOH1536RM	41	6.8	\$973	\$1029
	42"W x 13 3/8"D x 15"H	HRVOH1542RM	46	7.8	\$1033	\$1089
	48"W x 13 3/8"D x 15"H	HRVOH1548RM	52	8.9	\$1120	\$1176
	60"W x 13 3/8"D x 15"H	HRVOH1560RM	62	11.2	\$1695	\$1751

NOTES:

- Overhead Storage Cabinets with doors are standard with a factory installed core removable lock located on the underside of the cabinet.
- All units feature an anti-dislodgement device.
- 60" and 72"W units are one piece cabinet with two doors.
- Upmount kits can be used with all metal overheads.
- Units install directly onto panel frame verticals or to wall hanger kits.

! Keyed alike cores must be ordered separately — see page 699.

HOW TO SPECIFY

<p>Select Model Number</p> <p>HRVOH24FM</p>	<p>Select Paint Color</p> <p>See page 413</p> <p>T4</p>	<p>Select Lock Option</p> <p>L Lock X Omit Lock (deduct \$20) (where applicable)</p> <p>See page 699</p> <p>L</p>
---	---	---

SYSTEMS

ETA Overheads and Shelves

GSA SIN 33721



Icon Legend on page 19

WORKSTATIONS

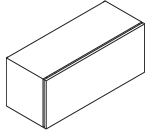

DESCRIPTION

Flipper Door Overheads

24"W x 13"D x 15"H
 30"W x 13"D x 15"H
 36"W x 13"D x 15"H
 42"W x 13"D x 15"H
 48"W x 13"D x 15"H
 60"W x 13"D x 15"H
 72"W x 13"D x 15"H

MODEL

HEOHRTA1524FD
HEOHRTA1530FD Ⓢ
HEOHRTA1536FD Ⓢ
HEOHRTA1542FD
HEOHRTA1548FD Ⓢ
HEOHRTA1560FD Ⓢ
HEOHRTA1572FD Ⓢ

SHIP WEIGHT

21
24
27
30
33
42
49

CUBE

1.6
1.6
1.6
1.8
2.1
2.5
3.0

LIST PRICE BY PAINT GRADE

P1 **P2**

\$559 **\$611**
\$567 **\$619**
\$595 **\$647**
\$624 **\$676**
\$649 **\$701**
\$856 **\$908**
\$1063 **\$1115**

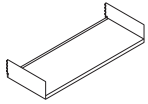

Open Shelves

24"W x 13"D x 5 5/8"H
 30"W x 13"D x 5 5/8"H
 36"W x 13"D x 5 5/8"H
 42"W x 13"D x 5 5/8"H
 48"W x 13"D x 5 5/8"H
 60"W x 13"D x 5 5/8"H
 72"W x 13"D x 5 5/8"H

HESHRTA24
HESHRTA30 Ⓢ
HESHRTA36 Ⓢ
HESHRTA42
HESHRTA48 Ⓢ
HESHRTA60 Ⓢ
HESHRTA72

10
11
12
13
14
16
18

1.9
1.9
1.9
2.1
2.4
3.0
3.5

\$262 **\$280**
\$283 **\$301**
\$300 **\$318**
\$310 **\$328**
\$328 **\$346**
\$399 **\$417**
\$470 **\$488**

NOTES:

- Storage Cabinets with doors are standard with a factory installed core removable lock located on the underside of the cabinet.
- All units feature an anti-dislodgement device.
- Accepts under cabinet lighting.
- ETA overheads and shelves ship flat packed.
- Only one installer is needed to assemble an ETA overhead on a panel (all sizes).
- Attachment brackets are attached to the back of the unit (included).
- ETA overheads and shelves are slightly less deep than built-up models. Please note when using next to built-up models.
- Order overhead and shelf to match the width of panel being used.
- Units install directly onto panel frame verticals or to wall hanger kits.

ⓘ Keyed alike cores must be ordered separately — see page 699.

ⓘ Cannot be used in off-modular applications because attachment bracket is attached to the back of the case and cannot be moved.

ⓘ ETA overheads and shelves do not work with horizontal track. Must be used with vertical track if not hung directly on panels due to the teeth attachment bracket.

HOW TO SPECIFY

Select Model Number

Select Paint Color

See page 413

H E O H R T A 1 5 2 4 F D .

T 1



Icon Legend on page 19

SYSTEMS Overhead Storage

WORKSTATIONS

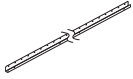

DESCRIPTION	MODEL	SHIP WEIGHT	CUBE	LIST PRICE BY PAINT GRADE	
				P1	P2
Abound®/Accelerate® Horizontal Wall Track for Overhead Storage 60"W	HTWTH	5	0.8	\$112	N/A
NOTES: Use when mounting overhead storage and when a permanent wall hanger kit is not desired. For 72"W overheads, use two wall tracks cut to 36".					
ⓘ Cannot be used with ETA storage or Voi®. Can only be used with systems flipper door, receding door and hinged door overheads.					

HOW TO SPECIFY

Select Model Number

HTWTH

SYSTEMS

Overhead Accessories

GSA SIN 33721



Icon Legend on page 19

WORKSTATIONS

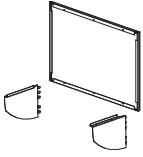

DESCRIPTION	MODEL	SHIP WEIGHT	CUBE	LIST PRICE BY PAINT GRADE	
				P1	P2
Upmount Kits for Overheads					
24"W	HRVUP24	7.0	0.3	\$206	\$225
30"W	HRVUP30	8.0	0.3	\$217	\$236
36"W	HRVUP36	10.0	0.4	\$223	\$242
42"W	HRVUP42	11.0	0.4	\$234	\$253
48"W	HRVUP48	12.0	0.5	\$243	\$262
60"W	HRVUP60	16.0	0.6	\$261	\$280
<ul style="list-style-type: none"> Includes two upmount brackets, full back panel and installation hardware. Brackets require a clearance of 6½" below bottom of overhead cabinet. Full back panel adds ½" to depth of overhead case. 					
<p>⚠ Kit width must correspond to the width of the overhead case.</p>					



Overhead Shelf Dividers Shelf Dividers — package of 6	H38SHFDV	3.0 Ⓞ	0.2	\$212	\$224
---	-----------------	-------	-----	--------------	--------------

Specify paint

NOTES:

- Upmount Bracket allows mounting of Overhead Cabinet up to 15" above height of panel.
- Upmount Kits for overheads can be used with flipper or receding door overheads. See page 529.

⚠ Upmount Kits not for use on Accelerate stackers.

HOW TO SPECIFY

Select Model Number	Select Paint Color
H 3 8 S H F D V .	See page 413
T 1	



DESCRIPTION	MODEL	SHIP WEIGHT	CUBE	LIST PRICE BY PAINT GRADE	
				P1	P2
Cord Cover					
• Allows routing of task light cords.					
• Vertical height 10".	HECC10	0.7 Ⓞ	0.2	\$53	\$61
• Vertical height 15".	HECC15	1.0 Ⓞ	0.3	\$53	\$61
• Cord cover can be positioned into panel slots and used under task lights and under worksurfaces.					

Specify paint

HOW TO SPECIFY

Select Model Number	Select Paint Color
H E C C 1 0 .	See page 413
T 1	



SYSTEMS

Overhead Accessories

	DESCRIPTION	MODEL	SHIP WEIGHT	CUBE	LIST PRICE
	Tackboard				
	20"W x 18"H	HETB2018	2	0.5	\$138
	24"W x 18"H	HETB2418	3	0.6	\$169
	30"W x 18"H	HETB3018	3	0.7	\$197
	36"W x 18"H	HETB3618	8	0.9	\$224
	42"W x 18"H	HETB4218	10	1.0	\$250
	48"W x 18"H	HETB4818	12	1.2	\$275
	60"W x 18"H	HETB6018	13	1.5	\$303
72"W x 18"H	HETB7218	15	1.8	\$333	
SPECIFYING EXAMPLE: HETB2018.APN15					

NOTES:

- Works with both Abound® and Accelerate® panel systems.
- Specify fabric, see pages 372-373 for fabric options.

HOW TO SPECIFY

Select Model Number	Select Fabric Color
H E T B 2 0 1 8 .	A P N 1 5

SYSTEMS

Electrical Components

GSA SIN 33721



Icon Legend on page 19

WORKSTATIONS

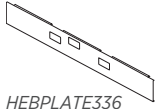

HEBPLATE336

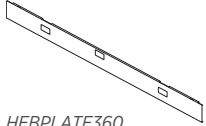

HEBPLATE360

DESCRIPTION

Accelerate® Base Pathway Cover w/Additional Knockout

Width	MODEL	SHIP WEIGHT	CUBE
36"W	HEBPLATE336	7	0.4
42"W	HEBPLATE342	8	0.4
48"W	HEBPLATE348	9	0.4
60"W	HEBPLATE360	11	0.5
72"W	HEBPLATE372	14	0.6

NOTES: Specify paint, see page 413.

SPECIFYING EXAMPLE: HEBPLATE336.T4

SHIP WEIGHT CUBE

LIST PRICE BY PAINT GRADE

P1 P2

Abound® Base Pathway Cover w/Additional Knockout

Width	MODEL	SHIP WEIGHT	CUBE
36"W	HRVBPLATE336	7	0.4
42"W	HRVBPLATE342	8	0.4
48"W	HRVBPLATE348	9	0.4
60"W	HRVBPLATE360	11	0.5

NOTES: Specify paint, see page 371.

SPECIFYING EXAMPLE: HRVBPLATE336.T4

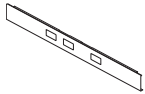

HRVBPLATE336

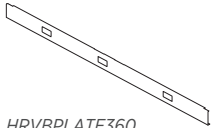

HRVBPLATE360

NOTES:

- Specify Pathways to match trim color.
- Standard raceways with two knockouts are standard on panels. If additional three knockout kickplate is ordered, the two port version can be saved or discarded.

HOW TO SPECIFY

Select Model Number

Select Paint Color

See page 413

H E B P L A T E 3 3 6 .

T 4

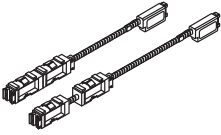
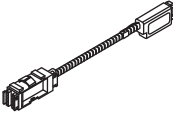
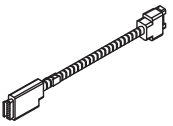

SYSTEMS Electrical Components

DESCRIPTION	MAX. RECEPT. CAP. PER PANEL SIDE	MODEL		SHIP WEIGHT	CUBE	LIST PRICE
		FOUR-CIRCUIT 3 + 1 2 + 2	THREE-CIRCUIT, SEPARATE NEUTRALS			
Electrical Power Harnesses, Frames — w/duplex capacity						
 For 24"W	1	HH871224 ☉	HH871224A	2.0	0.5	\$271
For 30"W	2	HH871230 ☉	HH871230A	2.0	0.5	\$271
For 36"W	2	HH871236 ☉	HH871236A	2.5	0.5	\$271
For 42"W	2	HH871242	HH871242A	3.0	0.5	\$286
For 48"W	2	HH871248 ☉	HH871248A	3.0	0.5	\$286
For 60"W	2	HH871260 ☉	HH871260A	3.0	0.5	\$286
For 72"W (for use with Accelerate® 72"W panels only)	2	HH871272	HH871272A	5.0	0.5	\$286
Electrical Pass-Thru Cables, Frames — w/duplex capacity						
 For 24"W	1	HH871124 ☉	HH871124A	2.0	0.5	\$172
For 30"W	1	HH871130 ☉	HH871130A	2.0	0.5	\$172
For 36"W	1	HH871136 ☉	HH871136A	2.0	0.5	\$172
For 42"W	1	HH871142	HH871142A	2.5	0.5	\$181
For 48"W	1	HH871148 ☉	HH871148A	2.5	0.5	\$181
For 60"W	1	HH871160 ☉	HH871160A	3.0	0.5	\$181
For 72"W (for use with Accelerate® 72"W panels only)	1	HH871172	HH871172A	5.0	0.5	\$181
NOTES: For use when data will be terminated in one cutout in the panel.						
Electrical Pass-Thru Harness without Power Block						
 For 24"W Frames	0	HH871024	HH871024A	2.0	0.5	\$159
For 30"W Frames	0	HH871030	HH871030A	2.0	0.5	\$159
For 36"W Frames	0	HH871036	HH871036A	2.0	0.5	\$159
For 42"W Frames	0	HH871042	HH871042A	3.0	0.5	\$164
For 48"W Frames	0	HH871048	HH871048A	3.0	0.5	\$164
For 60"W Frames	0	HH871060	HH871060A	3.0	0.5	\$164
For 72"W Frame Runs	0	HH871072		4.0	0.5	\$227

NOTES:

- Duplex receptacles on page 538.
- Electric harnesses are intended for use with HON Systems furniture and are approved under GSA SIN 33721. When purchased separately and used without HON Systems furniture, the models are considered Open Market.

! Four-circuit components and three-circuit components (with "A" suffix) not designed to be used together. See pages 522-523.

HOW TO SPECIFY

<p>Select Model Number</p>	<p>Select Color</p> <p>See page 413</p>
<p>HH871048 .</p>	<p>P</p>

SYSTEMS

Electrical Components

GSA SIN 33721



Icon Legend on page 19

WORKSTATIONS

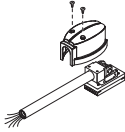
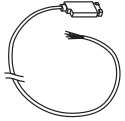
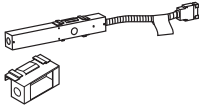
	DESCRIPTION	MODEL		SHIP WEIGHT	CUBE	LIST PRICE
		FOUR-CIRCUIT 3+1 2+2	THREE-CIRCUIT, SEPARATE NEUTRALS			
	Electrical Jumper Cables Jumper for up to 36" vertical jump, 66" long	HH871366	HH871366A	3.0	0.5	\$186
	Power In-Feed Cables — Base In-Feed 72" long conduit, Sealtight Cable — 7/8" diameter	HH879072 ☹	HH879072A	4.5	0.3	\$303
	168" long conduit, Sealtight Cable — 7/8" diameter	HH879168	HH879168A	9.0	0.4	\$703
	Ceiling In-Feed 144" long conduit, Flex Cable — 7/8" dia.	HH871912 ☹	HH871912A	4.0	0.5	\$315
	216" long conduit, Flex Cable — 7/8" dia.	HH871918	HH871918A	4.0	0.5	\$409
	☹ Must be used with Power Pole. Power in-feed models HH871912 and HH871918 plug into the end of any power block. No portion of the cable can be exposed after installation.					
 <i>Use when local codes require</i>	Hardwire Applications Hardwire Power In-feed	HH871400 ☹ *	HH871400A *	4.0	0.3	\$296
	☹ Customer to furnish all cabling and wiring from power entry to power source (approved for use by city of New York).					
	Hardwire Junction Box (6-pack)	HH871500 ☹		4.5	0.1	\$629
	☹ For use with Accelerate® and Abound® Beltline only.					
	☹ Hardwire Junction Boxes cannot be installed back-to-back in panel applications.					
	Hardwire Junction Box (6-pack)	HH873500		4.5	0.2	\$586
	☹ For use with Abound® Raceway panels only.					
	NOTES: Junction Box can be positioned at any Duplex Receptacle location in 30"W or wider panels.					
	☹ Contact Tailored Solutions for back-to-back Junction Box standard special number.					

NOTES:

• Duplex receptacles on page 538.

☹ Four-circuit components and three-circuit components (with "A" suffix) not designed to be used together. See pages 522-523.

☹ To connect power between the base pathway and the beltline area on Abound, four-circuit jumper cables (H8713xx) must be connected to a power block at one end of a run, routed into an adjacent panel that contains no power harness, then routed back into the panel that contains a power harness (or pass-thru cable), and connected to a power harness in the other pathway.

* De-emphasized.

HOW TO SPECIFY

Select Model Number	Select Color
HH871366 . P	See page 413



SYSTEMS Electrical Components



DESCRIPTION	MODEL	SHIP WEIGHT	CUBE	LIST PRICE BY PAINT GRADE		
				P1	P2	P3
Abound® Integrated Power Pole For 35"H-50"H Frames. Poles are 78"H. For 65"H-95"H Frames. Poles are 52"H. NOTES: Power Pole includes ceiling trim piece.	HEP35	9 Ⓢ	0.6	\$504		
	HEP65	6 Ⓢ	0.4	\$357		

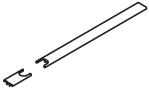

DESCRIPTION	FLAT MODEL	CHAMFERED MODEL	SHIP WEIGHT	CUBE	LIST PRICE BY PAINT GRADE		
					P1	P2	P3
Power Pole Trim Kit (Abound® only) 24"W 30"W 36"W 42"W 48"W 60"W	HRVP24PF	HRVP24P	2 Ⓢ	0.3	\$180		
	HRVP30PF	HRVP30P	3 Ⓢ	0.4	\$189		
	HRVP36PF	HRVP36P	4 Ⓢ	0.5	\$199		
	HRVP42PF	HRVP42P	5 Ⓢ	0.5	\$202		
	HRVP48PF	HRVP48P	6 Ⓢ	0.6	\$208		
	HRVP60PF	HRVP60P	7 Ⓢ	0.7	\$222		

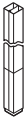

DESCRIPTION	MODEL	SHIP WEIGHT	CUBE	LIST PRICE
Power Pole — w/o Receptacles (Voi® only) 10'5"	HH870070	14	0.5	\$570

- Used for routing In-Feed Cable from ceiling to panel baserail. Double cavity, plus conduit of In-Feed Cable serves as the division of electrical and communications cabling.

Specify paint color for HH870070, not available in Putty



DESCRIPTION	MODEL	SHIP WEIGHT	CUBE	LIST PRICE BY PAINT GRADE		
				P1	P2	P3
Accelerate® Integrated Power Pole 78"H x 2"W x 2"D 156"H x 2"W x 2"D	HECPP Ⓢ	14 Ⓢ	0.5	\$364	\$385	\$387
	HECPP156	28	1.0	\$878	\$899	\$901

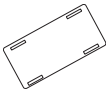

DESCRIPTION	MODEL	SHIP WEIGHT	CUBE	LIST PRICE
Receptacle Cover Replacements Quantity 25 ⓘ For use with Accelerate® panels only. ⓘ Specify Color — Available in Black (P) and Muslin (T3) only.	HEREPCVR	1 Ⓢ	0.1	\$97

HOW TO SPECIFY

Select Model Number H R V P 2 4 P .	Select Paint Color See page 413 T 4
--	---

SYSTEMS

Electrical Components

GSA SIN 33721



Icon Legend on page 19



Each marked with
Circuit Number

DESCRIPTION	MODEL		SHIP WEIGHT	CUBE	LIST PRICE
	FOUR-CIRCUIT	THREE-CIRCUIT,			
	3 + 1 2 + 2	SEPARATE NEUTRALS			
Abound® Duplex Receptacles					
Circuit 1	HH873501	HH873501A	0.5	0.1	\$58
Circuit 2	HH873502	HH873502A	0.5	0.1	\$58
Circuit 3	HH873503	HH873503A	0.5	0.1	\$58
Circuit 4 — isolated, dedicated circuit	HH873504		0.5	0.1	\$58
Circuit 1 — 20 amp outlet	HH871601	HH871601A	1.0	0.1	\$58
Circuit 3 (2 + 2)	HH873506		0.5	0.1	\$58

Specify color.

❗ Duplex receptacle models above are for use with Abound® models only.



Each marked with
Circuit Number

DESCRIPTION	MODEL		SHIP WEIGHT	CUBE	CORE LIST PRICE
	FOUR-CIRCUIT	THREE-CIRCUIT,			
	3 + 1 2 + 2	SEPARATE NEUTRALS			
Accelerate® Duplex Receptacles					
Circuit 1	HH871501 ☉	HH871501A	1.0	0.5	\$58
Circuit 2	HH871502 ☉	HH871502A	1.0	0.5	\$58
Circuit 3 (except 2 + 2 — see below)	HH871503 ☉	HH871503A	1.0	0.5	\$58
Circuit 4 — isolated, dedicated circuit	HH871504 ☉		1.0	0.5	\$58
Circuit 1 (20 amp outlet configuration)	HH871601		1.0	0.5	\$58
Circuit 3 (2 + 2)	HH871506		1.0	0.5	\$58

Specify Paint.

NOTES: Use with Accelerate® models.

SPECIFYING EXAMPLE: HH871501.S

See page 413 for color options.



DESCRIPTION	MODEL		SHIP WEIGHT	CUBE	LIST PRICE
	FOUR-CIRCUIT	THREE-CIRCUIT,			
	3 + 1 2 + 2	SEPARATE NEUTRALS			
Data/Electrical Port Kit					
Specify color	HHT2DP		1.0	0.1	\$35

NOTES:

• Data/Electrical Port Kit used for field installations of additional data accessories.

❗ Four-circuit components and three-circuit components (with "A" suffix) not designed to be used together. See pages 522-523.

Maximum Receptacle Capacity in Abound Panel Base Raceways

Widths	24	30	36	42	48	60
Maximum of 1 duplex per panel side	X					
Maximum of 2 duplexes per panel side		X	X	X	X	X

Duplex Color Recommended to Coordinate with Paint Color			
Paint Color	Paint Code	Duplex Color	Duplex Code
Black	P	Black	P
Brownstone	P7D	Brownstone	EY
Charcoal	S	Charcoal	S
Designer White	PJW	Designer White	DW
Fossil	P28	Charcoal	S
Greige	T5	Muslin	T3
Light Gray	Q	Loft	LOFT
Loft	LOFT	Loft	LOFT
Muslin	T3	Muslin	T3
Putty	L	Black	P
Silver	PR6	Titanium	TI
Titanium	P8T	Titanium	TI
Champagne Metallic	T4	Muslin	T3
Platinum Metallic	T1	Titanium	TI

Data / Electrical Port Kit Color Recommended to Coordinate with Paint Color			
Paint Color	Paint Code	Data / Port Kit Color	Data / Port Kit Code
Black	P	Black	P
Brownstone	P7D	Brownstone	EY
Charcoal	S	Charcoal	S
Designer White	PJW	Designer White	DW
Fossil	P28	Charcoal	S
Greige	T5	Muslin	T3
Light Gray	Q	Loft	LOFT
Loft	LOFT	Loft	LOFT
Muslin	T3	Muslin	T3
Putty	L	Black	P
Silver	PR6	Titanium	TI
Titanium	P8T	Titanium	TI
Champagne Metallic	T4	Muslin	T3
Platinum Metallic	T1	Titanium	TI

HOW TO SPECIFY

Select Model Number

HH873501 . P

Select Color

See page 413



Icon Legend on page 19

SYSTEMS Electrical Components

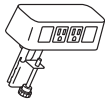

DESCRIPTION

MODEL

SHIP WEIGHT

CUBE

LIST PRICE

Power & Data Center

2 Receptacles 2 Data Accessory

- Standard with two receptacles and openings for two data ports.
- 6' power cord with standard three-prong plug.
- Fits on any worksurface with a 4" overhang.
- UL Listed.

HCOMDOME2

2.5 **Ⓢ**

0.2

\$391

NOTES: Cable ports accommodate up to four individual voice and data outlets, and can be mounted anywhere there is an electrical receptacle opening. Data/Electrical Port Kit used for field installations of additional data accessories.

- ⚠ Four-circuit components and three-circuit components (with "A" suffix) not designed to be used together. See pages 522-523.
- ⚠ Duplex receptacle models shown on the previous page are for use with Abound® models only.
- ⚠ Color finish coordinates with HON's Loft. *Specify LOFT when ordering. Example: HCOMDOME2.LOFT*



Model HPWRMOD3WC shown

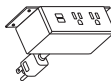

Model HPWRMOD2UWM shown

Power Modules

3 Receptacles with Worksurface Clamp

3 Receptacles with Under-Worksurface Mounting Bracket

2 Receptacles 2 USB with Worksurface Clamp

2 Receptacles 2 USB with Under-Worksurface Mounting Bracket

- 6' power cord with standard three-prong plug.
- Under-worksurface mounting bracket models work with any top that has a 5" x 5" square clearance.
- Worksurface clamp models work on any top with a 4" overhang.
- UL Listed.

HPWRMOD3WC

2.3 **Ⓢ**

0.2

\$409

HPWRMOD3UWM

2.3 **Ⓢ**

0.2

\$409

HPWRMOD2WC Ⓢ

2.3 **Ⓢ**

0.2

\$652

HPWRMOD2UWM

2.3 **Ⓢ**

0.2

\$652

NOTES: Cable ports accommodate up to four individual voice and data outlets, and can be mounted anywhere there is an electrical receptacle opening. Data/Electrical Port Kit used for field installations of additional data accessories.

- ⚠ Four-circuit components and three-circuit components (with "A" suffix) not designed to be used together. See pages 522-523.
- ⚠ Duplex receptacle models shown on the previous page are for use with Abound® models only.
- ⚠ Color finish coordinates with HON's Charcoal or White. *Specify STRM for Storm and SNW for Snow when ordering. Example: HPWRMOD3WC.STRM*



Vertebrae

HMPVWM28

3.0

0.3

\$294

NOTES: 30"H x 3 1/8"W x 1 1/2"D. Ships unassembled.

- ⚠ Clear finish. Specify "X" for finish option.
- SPECIFYING EXAMPLE: HMPVWM28.X**

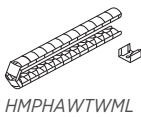

HMPHAWTWML



HMPHATFWML

Wire Managers for Height Adjustable

Workstation to Trough

Trough to Floor

HMPHAWTWML Ⓢ

3.0

0.1

\$354

HMPHATFWML

2.0

0.3

\$309

- ⚠ Wire Manager Workstation to Trough only available in black.
- ⚠ HMPHATFWML Trough to Floor cable manager is 3" x 1 1/2".

OPEN MARKET

NOTES:

- For additional information see pages 724 and 727.

HOW TO SPECIFY

<p>Select Model Number</p> <p>H C O M D O M E 2</p>	<p>Select Color</p> <p>See page 413</p> <p>L O F T</p>
--	---

SYSTEMS

Electrical and Data

GSA SIN 33721 EXCEPT AS NOTED



Icon Legend on page 19

WORKSTATIONS

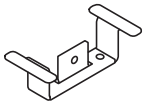

DESCRIPTION

MODEL

SHIP WEIGHT

CUBE

LIST PRICE

Abound Electrical Mounting Brackets (pack of 12)

HH8988EBN

3.0

0.1

\$85

- ❗ 1 bracket required at beltline for each pass-thru harness and 24"W power harness and 2 for 30"-60"W power harness.
- ❗ Bracket for use at beltline only. Dimension of raceway mounting bracket is different and not interchangeable. Bracket height for beltline changed Q1 2019.
- ❗ If adding onto product produced prior to Q1 2019, please contact HON Customer Support.

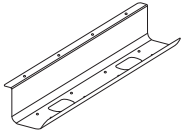

Cable Management Tray

24"
36"

HJTRGH24
HJTRGH36

2.0
3.0

0.3
0.4

\$99
\$121

Black only

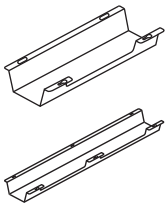

Cable Management Troughs

17"W — Single
17"W — 10-Pack
36"W — Single
36"W — 10-Pack

HCTROUGH17
HCTROUGH1710
HCTROUGH36
HCTROUGH3610

2.7
14.0
4.9
30.0

0.5
0.5
0.9
0.9

\$94
\$841
\$155
\$1415

- Cable management troughs ship flat packed.
- The troughs attach to underneath the worksurface with screws.
- The 17"W has one wire access cut out on the user side. The 36" has two wire access cut outs. These cut outs give users access to inside the trough without having to detach it from the worksurface.
- Color: Graphite.
- Material: Metal.
- TAA Compliant.
- Slim profile design.

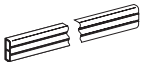

Black only

Wire Manager

- HHEM model clips to bottom of panels. (62"W)
- Slits in wire manager allows cable to be passed into unit.

HHEM620

10.0

0.5

\$139



HHTADF3

AMP Data Faceplates

Three-port flex-mode faceplate
Four-port flex-mode faceplate

HHTADF3
HHTADF4

1.0
1.0

0.2
0.2

\$34
\$34



HHTADF4

- ❗ Data faceplates available in Black (E4) only.



HHTADJ5
Black only

AMP RJ45 CAT 5E Jack — Black (P)
AMP RJ45 CAT 6 Jack — Black (P)

HHTADJ5
HHTADJ6

1.0
1.0

0.1
0.1

\$53
\$72

Models HHTADJ5 and HHTADJ6 snap into faceplate.

NOTES: AMP Data Faceplates attach to bottom of panel or at worksurface height in front of baserail covers for easy cable routing. Faceplates cannot be installed back-to-back in a panel application.

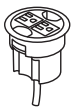

SIN 33721T

Power Hub, 3" Grommet Mount, 6' Cord

HGRMTAC

1.3

0.2

\$167

- Fits in 3" round grommet holes on the following product lines: Coordinate, Huddle, Motivate, all laminate and veneer casegoods series, and Systems Worksurfaces.
- Two grounded AC power outlets.
- Includes 6' cord with three-prong plug.
- Field installed with Plug-and-play ease.

- ❗ Available in black only (no color designation so use .X - Specify: HGRMTAC.X).



SIN 33721T

Power/USB Hub, 3" Grommet Mount

HGRMTUSB2

1.3

0.2

\$300

- One grounded AC power outlet with 2 USB ports.
- UL Listed.

NOTES: For additional information see page 723.

- ❗ Available in black only (no color designation so use .X - Specify: HGRMTUSB2.X).



SYSTEMS WORKSURFACES

Primary

DESCRIPTION	MODEL	SHIP WEIGHT	CUBE	L1 LIST PRICE	L2 LIST PRICE	UPCHARGE BY PREFIX/SUFFIX		
						"B/T"	"C/T"	
Primary and/or Return Worksurfaces								
24"W x 18"D	HWR1824P	23	2.1	\$385	\$396	N/A	N/A	
30"W x 18"D	HWR1830P	28	2.1	\$400	\$411	N/A	N/A	
36"W x 18"D	HWR1836P	35	2.5	\$415	\$426	N/A	N/A	
42"W x 18"D	HWR1842P	39	2.8	\$427	\$438	N/A	N/A	
48"W x 18"D	HWR1848P	44	3.2	\$473	\$484	N/A	N/A	
54"W x 18"D	HWR1854P	48	4.0	\$526	\$542	N/A	N/A	
60"W x 18"D	HWR1860P	53	4.0	\$541	\$557	N/A	N/A	
66"W x 18"D	HWR1866P	65	4.7	\$579	\$595	N/A	N/A	
72"W x 18"D	HWR1872P	67	4.7	\$594	\$610	N/A	N/A	
24"W x 24"D	HWR2424P	31	2.2	\$394	\$405	\$39	\$39	
30"W x 24"D	HWR2430P	37	2.2	\$411	\$422	\$41	\$41	
36"W x 24"D	HWR2436P ☉	46	2.5	\$446	\$462	\$39	\$39	
42"W x 24"D	HWR2442P	52	2.5	\$490	\$506	\$38	\$38	
48"W x 24"D	HWR2448P ☉	58	3.3	\$520	\$536	\$42	\$42	
54"W x 24"D	HWR2454P	64	4.0	\$551	\$572	\$40	\$40	
60"W x 24"D	HWR2460P ☉	70	4.0	\$614	\$635	\$40	\$40	
66"W x 24"D	HWR2466P	86	4.8	\$659	\$680	\$39	\$39	
72"W x 24"D	HWR2472P ☉	89	4.8	\$679	\$700	\$40	\$40	
84"W x 24"D	HWR2484P	103	5.1	\$962	\$989	\$32	\$32	

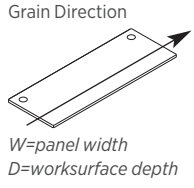

NOTES:

- Worksurfaces are constructed of laminate on 1/8" solid core high-performance particleboard.
- Models up to 42"W are standard with one centered grommet. Models 48"W and wider are standard with two grommets.
- Accelerate® adds a "C" prefix and "T" suffix and Abound® adds a "B" prefix and "T" suffix to the Model Number for primary worksurfaces to span a TEE or EXTENDED STRAIGHT connection (adds 2 1/4" to width). Add corresponding upcharge per model.
- Add suffix "N" to Model Number for worksurfaces with no grommets. No upcharge.
- ! 18"D models are not available in Tee-Span but can be accommodated through Tailored Solutions.
- ! EXTENDED STRAIGHT worksurfaces are available with grommets only.
- ! 60"W, 66"W and 72"W worksurfaces require one or more of the following: worksurface support brackets, end panel, external channel universal support leg or pedestal support in conjunction with cantilever brackets.
- ! When a run of worksurfaces equals or exceeds 6 feet, a floor support is required for worksurface structural assurance.
- ! All worksurfaces load tested to BIFMA standards.
- ! All worksurfaces with an unsupported span of 54" or larger require the use of an external channel. See table on page 542 for required length by application.

HOW TO SPECIFY

<p>Select Model Number</p> <p>For Tee-Span or Extended straight connection: Accelerate® adds a "C" prefix and "T" suffix (add upcharge per model)</p> <p>Abound® adds a "B" prefix and "T" suffix (add upcharge per model)</p> <p>No Grommet option: Add "N" suffix (no upcharge)</p> <p>HWR2424P .</p> <p>HCWR2424PT .</p> <p>HBWR2424PT .</p> <p>HWR2424PN .</p>	<p>Select Laminate</p> <p>See page 413</p> <p>A5 .</p> <p>A5 .</p> <p>A5 .</p> <p>A5 .</p>	<p>Select Edge Color</p> <p>See page 413</p> <p>K .</p> <p>K .</p> <p>K .</p> <p>K .</p>	<p>Select Grommet Color</p> <p>See page 413</p> <p>T1</p> <p>T1</p> <p>T1</p>
---	---	---	--

SYSTEMS WORKSURFACES

Primary

GSA SIN 33721



Icon Legend on page 19

WORKSTATIONS

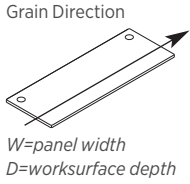

DESCRIPTION	MODEL	SHIP WEIGHT	CUBE	L1 LIST PRICE	L2 LIST PRICE	UPCHARGE BY PREFIX/SUFFIX	
						"B/T"	"C/T"
Primary and/or Return Worksurfaces							
24"W x 30"D	HWR3024P	47	2.2	\$411	\$424	\$41	\$41
30"W x 30"D	HWR3030P	56	2.6	\$473	\$486	\$41	\$41
36"W x 30"D	HWR3036P	62	3.1	\$500	\$516	\$42	\$42
42"W x 30"D	HWR3042P	64	3.6	\$531	\$547	\$40	\$40
48"W x 30"D	HWR3048P	68	4.0	\$562	\$578	\$38	\$38
54"W x 30"D	HWR3054P	80	5.0	\$602	\$623	\$40	\$40
60"W x 30"D	HWR3060P	101	5.0	\$668	\$689	\$40	\$40
66"W x 30"D	HWR3066P	105	6.0	\$713	\$734	\$39	\$39
72"W x 30"D	HWR3072P	105	6.0	\$761	\$782	\$40	\$40
84"W x 30"D	HWR3084P	127	6.2	\$1027	\$1054	\$45	\$45

NOTES:

- Worksurfaces are constructed of laminate on 1 1/8" solid core high-performance particleboard.
- Models up to 42"W are standard with one centered grommet. Models 48"W and wider are standard with two grommets.
- Accelerate® adds a "C" prefix and "T" suffix and Abound® adds a "B" prefix and "T" suffix to the Model Number for primary worksurfaces to span a TEE or EXTENDED STRAIGHT connection (adds 2 1/4" to width). Add corresponding upcharge per model.
- Add suffix "N" to Model Number for worksurfaces with no grommets. No upcharge.

- ! EXTENDED STRAIGHT worksurfaces are available with grommets only.
- ! 60"W, 66"W, 72"W, and 84"W worksurfaces require one or more of the following: worksurface support brackets, end panel, external channel universal support leg or pedestal support in conjunction with cantilever brackets.
- ! When a run of worksurfaces equals or exceeds 6 feet, a floor support is required for worksurface structural assurance.
- ! All worksurfaces load tested to BIFMA standards.
- ! All worksurfaces with an unsupported span of 54" or larger require the use of an external channel.

EXTERNAL CHANNEL SELECTION GUIDE

Support Combination		Rectangle Worksurface Width				
Worksurface End Support 1	Worksurface End Support 2	54	60	66	72	84
End Panel	End Panel	42"	48"	54"	60"	72"
End Panel	Pedestal	NA	NA	NA	42"	48"
End Panel	Worksurface Brackets	42"	48"	54"	60"	72"
End Panel	Cantilever	42"	48"	54"	60"	72"
End Panel	Open Leg	42"	48"	54"	60"	72"
Pedestal	Pedestal	NA	NA	NA	NA	NA
Pedestal	Worksurface Brackets	NA	NA	NA	42"	48"
Pedestal	Cantilever	NA	NA	NA	42"	48"
Pedestal	Open Leg	NA	NA	NA	42"	48"
Worksurface Brackets	Worksurface Brackets	42"	48"	54"	60"	72"
Worksurface Brackets	Cantilever	42"	48"	54"	60"	72"
Worksurface Brackets	Open Leg	42"	48"	54"	60"	72"
Height Adjustable Base	NA	42"	48"	54"	60"	72"

See page 191 for External Channel models.

HOW TO SPECIFY

<p>Select Model Number</p> <p>For Tee-Span or Extended straight connection: Accelerate® adds a "C" prefix and "T" suffix (add upcharge per model)</p> <p>Abound® adds a "B" prefix and "T" suffix (add upcharge per model)</p> <p>No Grommet option: Add "N" suffix (no upcharge)</p> <p>HWR3024P .</p> <p>HCWR3024PT .</p> <p>HBWR3024PT .</p> <p>HWR3024PN .</p>	<p>Select Laminate</p> <p>See page 413</p> <p>A 5 .</p> <p>A 5 .</p> <p>A 5 .</p> <p>A 5 .</p>	<p>Select Edge Color</p> <p>See page 413</p> <p>K .</p> <p>K .</p> <p>K .</p> <p>K .</p>	<p>Select Grommet Color</p> <p>See page 413</p> <p>T 1</p> <p>T 1</p> <p>T 1</p>
---	---	---	---



SYSTEMS WORKSURFACES

Wedge

	DESCRIPTION	MODEL	SHIP WEIGHT	CUBE	L1 LIST PRICE	L2 LIST PRICE
<p>Grain Direction</p>	Wedge Worksurfaces					
	48" A x 24" B x 30" C	HWD244830P	64	4.8	\$713	\$729
	54" A x 24" B x 30" C	HWD245430P	80	4.8	\$765	\$786
	60" A x 24" B x 30" C	HWD246030P	101	4.8	\$819	\$840
	66" A x 24" B x 30" C	HWD246630P	105	5.7	\$871	\$892
	72" A x 24" B x 30" C	HWD247230P	109	5.7	\$930	\$951
	Wedge Worksurfaces					
	48" A x 30" B x 24" C	HWD304824P	64	4.8	\$713	\$729
	54" A x 30" B x 24" C	HWD305424P	80	4.8	\$765	\$786
	60" A x 30" B x 24" C	HWD306024P	101	4.8	\$819	\$840
	66" A x 30" B x 24" C	HWD306624P	105	5.7	\$871	\$892
	72" A x 30" B x 24" C	HWD307224P	109	5.7	\$930	\$951

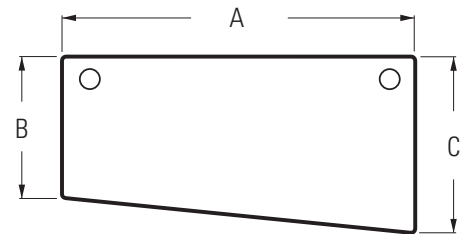
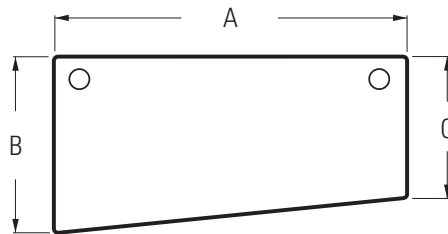

See matrix on page 542.

NOTES:

- Worksurfaces may be used with Accelerate®, Abound® and Voi® products.
- Worksurfaces are constructed of laminate on 1½" solid core particleboard.
- Refer to Worksurface Supports, pages 554-558.
- Universal support leg can be used to share support when worksurfaces are placed side-by-side.
- Add suffix "N" to Model Number for worksurfaces with no grommets. No upcharge.
- Woodgrain runs horizontally across surface.
- ! 60"W, 66"W and 72"W worksurfaces require one or more of the following: worksurface support brackets, end panel, external channel universal support leg or pedestal support in conjunction with cantilever brackets. A full end panel can also be used for support in place of cantilever brackets.
- ! When a run of worksurfaces equals or exceeds 6 feet, a floor support is required for worksurface structural assurance.
- ! All worksurfaces with an unsupported span of 54" or larger require the use of an external channel. See table on page 542 for required length by application.

HOW TO SPECIFY

<p>Select Model Number</p> <p>No Grommet option: Add "N" suffix (no upcharge)</p> <p>HWD244830P .</p> <p>HWD244830PN .</p>	<p>Select Laminate</p> <p>See page 413</p> <p>A5 .</p> <p>A5 .</p>	<p>Select Edge Color</p> <p>See page 413</p> <p>K .</p> <p>K .</p>	<p>Select Grommet Color</p> <p>See page 413</p> <p>T1</p>
---	---	---	--

SYSTEMS WORKSURFACES

Corner

GSA SIN 33721



Icon Legend on page 19

WORKSTATIONS

Grain Direction

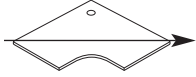

W=panel width

D=worksurface depth

DESCRIPTION

Corner Worksurfaces with Curved User Edge

36"W x 24"D

42"W x 24"D

48"W x 24"D

42"W x 30"D

48"W x 30"D

- HWC3624P will not accept the H4022, H4028, or H4029 keyboard platforms.

- ❗ Corner worksurfaces must match exactly the panel behind them, i.e.: a 36" panel must be used on the back two sides of model HWC3624P.

MODEL

HWC3624P

HWC4224P

HWC4824P

HWC4230P

HWC4830P

SHIP WEIGHT

53

65

76

72

77

CUBE

3.7

4.9

6.3

6.3

6.3

L1 LIST PRICE

\$633

\$674

\$766

\$802

\$870

L2 LIST PRICE

\$649

\$690

\$782

\$818

\$886

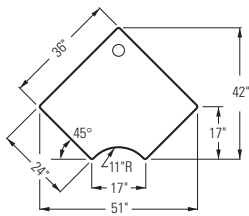

HWC3624P

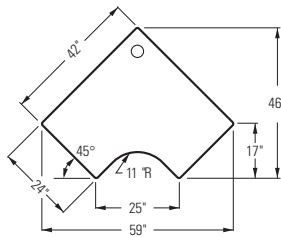

HWC4224P

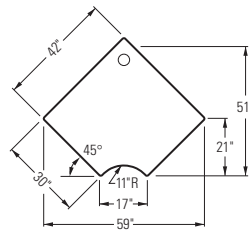

HWC4230P

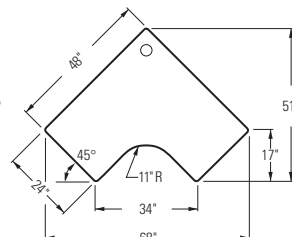

HWC4824P

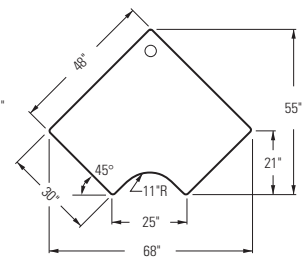

HWC4830P

NOTES:

- Worksurfaces may be used with Accelerate®, Abound® and Voi® products.
- Add suffix **"N"** to Model Number for worksurfaces with no grommets. No upcharge.
- Worksurfaces are constructed of laminate on 1/8" solid core high-performance particleboard.
- Refer to Worksurface Supports, pages 554-558.

HOW TO SPECIFY

Select Model Number

No Grommet option: Add **"N"** suffix (no upcharge)

HWC3624P

HWC3624PN

Select Laminate

See page 413

AS

AS

Select Edge Color

See page 413

K

K

Select Grommet Color

See page 413

T1



SYSTEMS WORKSURFACES

Corner

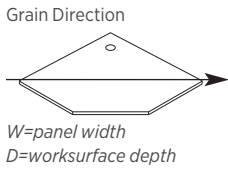

DESCRIPTION

Corner Worksurfaces with Straight User Edge

- 36"W x 24"D
- 42"W x 24"D
- 48"W x 24"D
- 42"W x 30"D
- 48"W x 30"D

MODEL

SHIP WEIGHT

CUBE

L1 LIST PRICE

L2 LIST PRICE

HWCS3624P	53	3.7	\$608	\$624
HWCS4224P	65	4.9	\$640	\$656
HWCS4824P	76	6.3	\$712	\$728
HWCS4230P	72	6.3	\$780	\$796
HWCS4830P	77	6.3	\$795	\$811

• HWCS3624P will not accept the H4022, H4028, or H4029 keyboard platforms.

! Corner worksurfaces must match exactly the panel behind them, i.e.: a 36" panel must be used on the back two sides of model HWCS3624P.

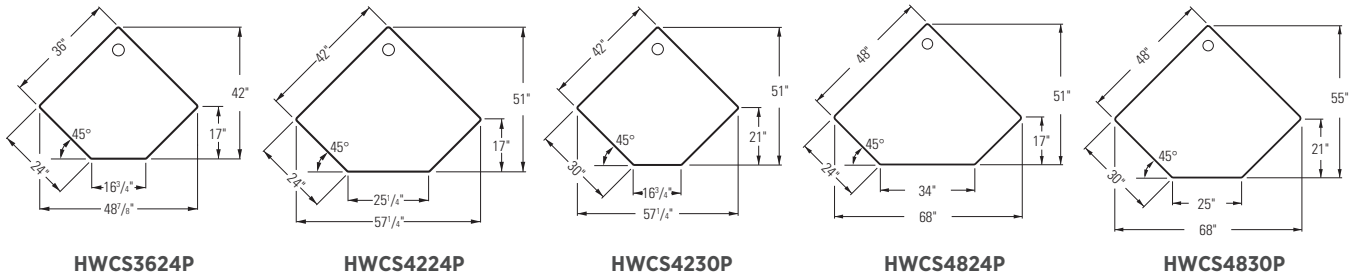

NOTES:

- Worksurfaces may be used with Accelerate®, Abound® and Voi® products.
- Add suffix **"N"** to Model Number for worksurfaces with no grommets. No upcharge.
- Worksurfaces are constructed of laminate on 1/8" solid core high-performance particleboard.
- Refer to Worksurface Supports, pages 554-558.

HOW TO SPECIFY

<p>Select Model Number</p> <p>No Grommet option: Add "N" suffix (no upcharge)</p> <p>HWCS3624P .</p> <p>HWCS3624PN .</p>	<p>Select Laminate</p> <p>See page 413</p> <p>AS .</p> <p>AS .</p>	<p>Select Edge Color</p> <p>See page 413</p> <p>K .</p> <p>K .</p>	<p>Select Grommet Color</p> <p>See page 413</p> <p>T1</p>
--	---	---	--

SYSTEMS WORKSURFACES

120 Degree Corner

GSA SIN 33721



Icon Legend on page 19

WORKSTATIONS

Grain Direction

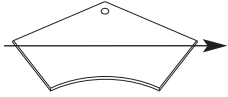

W=panel width
D=worksurface depth

DESCRIPTION

Around® and Accelerate® 120 Degree Corner Worksurfaces with Curved User Edge

MODEL	SHIP WEIGHT	CUBE	L1 LIST PRICE	L2 LIST PRICE
36"W x 24"D HBWCT3624P	75	7.7	\$935	\$1013
42"W x 24"D HBWCT4224P	96	9.2	\$1005	\$1083
48"W x 24"D HBWCT4824P	107	9.2	\$1176	\$1254
42"W x 30"D HBWCT4230P	102	11.4	\$1341	\$1419
48"W x 30"D HBWCT4830P	112	11.4	\$1431	\$1509

• HBWCT3624P will not accept the H4022, HE4022, H4028, or H4029 keyboard platforms.

❗ Corner worksurfaces must match exactly the panel behind them, i.e.: a 36" panel must be used on the back two sides of model HBWCT3624P.

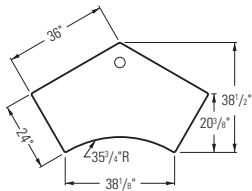

HBWCT3624P

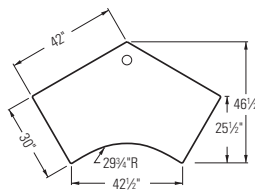

HBWCT4230P

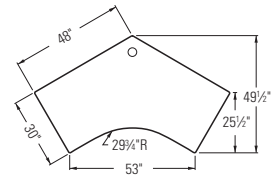

HBWCT4830P

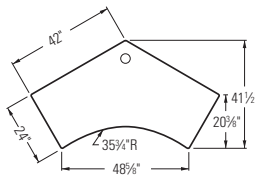

HBWCT4224P

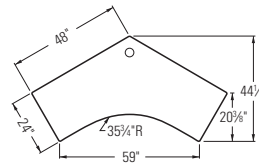

HBWCT4824P

NOTES:

- Worksurfaces are constructed of laminate on 1/8" solid core high-performance particleboard.
- Add suffix "N" to Model Number for worksurfaces with no grommets. No upcharge.
- Refer to Worksurface Supports, pages 554-558.
- If used at an end of run, full end panel needs to be ordered — see page 554.

HOW TO SPECIFY

<p>Select Model Number</p> <p>No Grommet option: Add "N" suffix (no upcharge)</p> <p>HBWCT3624P .</p> <p>HBWCT3624PN .</p>	<p>Select Laminate</p> <p>See page 413</p> <p>AS .</p> <p>AS .</p>	<p>Select Edge Color</p> <p>See page 413</p> <p>K .</p> <p>K .</p>	<p>Select Grommet Color</p> <p>See page 413</p> <p>T1</p>
---	---	---	--



SYSTEMS WORKSURFACES

Corner Cove

DESCRIPTION	MODEL	SHIP WEIGHT	CUBE	L1	L2
				LIST PRICE	LIST PRICE
<p>Corner Cove Worksurfaces, Left Hand</p> <p>60" A x 36" B x 24" C x 24" D 60" A x 36" B x 30" C x 24" D</p> <p>60" A x 48" B x 24" C x 24" D 60" A x 48" B x 24" C x 30" D 60" A x 48" B x 30" C x 24" D 60" A x 48" B x 30" C x 30" D</p> <p>72" A x 36" B x 24" C x 24" D 72" A x 36" B x 30" C x 24" D</p> <p>72" A x 48" B x 24" C x 24" D 72" A x 48" B x 24" C x 30" D 72" A x 48" B x 30" C x 24" D 72" A x 48" B x 30" C x 30" D</p>	HWV73AALP	67	5.9	\$722	\$749
	HWV73BALP	76	5.9	\$748	\$775
	HWV75AALP	85	7.7	\$795	\$827
	HWV75ABLP	94	7.7	\$826	\$858
	HWV75BALP	92	7.7	\$826	\$858
	HWV75BBLP	99	7.7	\$858	\$890
	HWV93AALP	75	7.0	\$795	\$827
	HWV93BALP	83	7.0	\$826	\$858
	HWV95AALP	96	9.2	\$1008	\$1045
	HWV95ABLP	107	9.2	\$1038	\$1075
	HWV95BALP	102	9.2	\$1038	\$1075
	HWV95BBLP	112	9.2	\$1072	\$1109

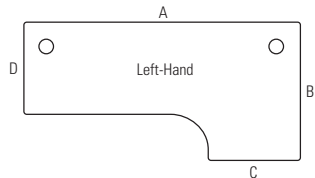
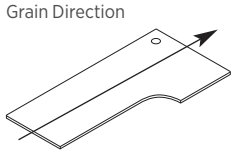

NOTES:

- Worksurfaces may be used with Accelerate®, Abound® and Voi® products.
- Worksurfaces are constructed of laminate on 1/8" solid core high-performance particleboard.
- Add suffix **"N"** to Model Number for worksurfaces with no grommets. No upcharge.
- Refer to Worksurface Supports, pages 554-558.
- ❗ Does NOT include a rear support bracket. If rear support bracket is needed, order HWSB2.
- ❗ Panel-hung application requires two panels of corresponding width joined at 90°.
- ❗ When a run of worksurfaces equals or exceeds 6 feet, a floor support is required for work surface structural assurance.
- ❗ 60"W, 66"W and 72"W worksurfaces require one or more of the following: work surface support brackets, end panel, external channel universal support leg or pedestal support in conjunction with cantilever brackets.
- ❗ All worksurfaces with an unsupported span of 54" or larger require the use of an external channel. See table on page 542 for required length by application.

HOW TO SPECIFY

<p>Select Model Number</p> <p>No Grommet option: Add "N" suffix (no upcharge)</p> <p>HWV73AALP .</p> <p>HWV73AALPN .</p>	<p>Select Laminate</p> <p>See page 413</p> <p>AS .</p> <p>AS .</p>	<p>Select Edge Color</p> <p>See page 413</p> <p>K .</p> <p>K .</p>	<p>Select Grommet Color</p> <p>See page 413</p> <p>T1</p>
--	---	---	--

SYSTEMS WORKSURFACES

Corner Cove

GSA SIN 33721



Icon Legend on page 19

WORKSTATIONS

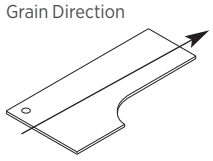

DESCRIPTION	MODEL	SHIP WEIGHT	CUBE	L1 LIST PRICE	L2 LIST PRICE
Corner Cove Worksurfaces, Right Hand					
60" A x 36" B x 24" C x 24" D	HWV73AARP	67	5.9	\$722	\$749
60" A x 36" B x 30" C x 24" D	HWV73BARP	76	5.9	\$748	\$775
60" A x 48" B x 24" C x 24" D	HWV75AARP	85	7.7	\$795	\$827
60" A x 48" B x 24" C x 30" D	HWV75ABRP	94	7.7	\$826	\$858
60" A x 48" B x 30" C x 24" D	HWV75BARP	92	7.7	\$826	\$858
60" A x 48" B x 30" C x 30" D	HWV75BBRP	99	7.7	\$858	\$890
72" A x 36" B x 24" C x 24" D	HWV93AARP	75	7.0	\$795	\$827
72" A x 36" B x 30" C x 24" D	HWV93BARP	83	7.0	\$826	\$858
72" A x 48" B x 24" C x 24" D	HWV95AARP	96	9.2	\$1008	\$1045
72" A x 48" B x 24" C x 30" D	HWV95ABRP	107	9.2	\$1038	\$1075
72" A x 48" B x 30" C x 24" D	HWV95BARP	102	9.2	\$1038	\$1075
72" A x 48" B x 30" C x 30" D	HWV95BBRP	112	9.2	\$1072	\$1109

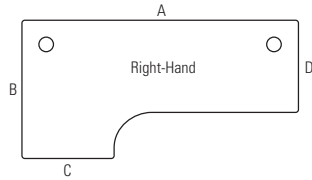

NOTES:

- Worksurfaces may be used with Accelerate®, Abound® and Voi® products.
- Worksurfaces are constructed of laminate on 1/8" solid core high-performance particleboard.
- Add suffix **"N"** to Model Number for worksurfaces with no grommets. No upcharge.
- Refer to Worksurface Supports, pages 554-558.
- ❗ Does NOT include a rear support bracket. If rear support bracket is needed, order HWSB2.
- ❗ Panel-hung application requires two panels of corresponding width joined at 90°.
- ❗ When a run of worksurfaces equals or exceeds 6 feet, a floor support is required for worksurface structural assurance.
- ❗ 60"W, 66"W and 72"W worksurfaces require one or more of the following: worksurface support brackets, end panel, external channel universal support leg or pedestal support in conjunction with cantilever brackets.
- ❗ All worksurfaces with an unsupported span of 54" or larger require the use of an external channel. See table on page 542 for required length by application.

HOW TO SPECIFY

<p>Select Model Number</p> <p>No Grommet option: Add "N" suffix (no upcharge)</p> <p>HWV73AARP .</p> <p>HWV73AARP N .</p>	<p>Select Laminate</p> <p>See page 413</p> <p>AS .</p> <p>AS .</p>	<p>Select Edge Color</p> <p>See page 413</p> <p>K .</p> <p>K .</p>	<p>Select Grommet Color</p> <p>See page 413</p> <p>T1</p>
---	---	---	--



SYSTEMS WORKSURFACES

Jetty / Peninsula

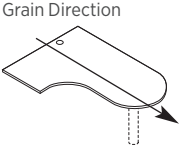
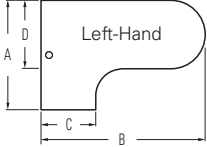
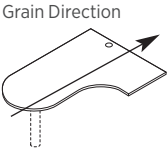
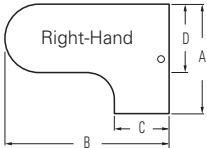
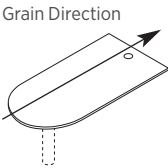
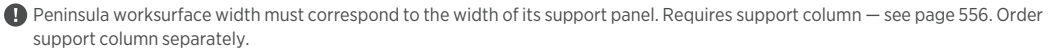
	DESCRIPTION	MODEL	SHIP WEIGHT	CUBE	L1 LIST PRICE	L2 LIST PRICE
	Jetty Worksurfaces, Left Hand					
	48" A x 66" B x 24" C x 30" D	HWJ58ABLP	84	9.2	\$1075	\$1107
	48" A x 72" B x 24" C x 30" D	HWJ59ABLP	88	9.2	\$1082	\$1114
						
	Jetty Worksurfaces, Right Hand					
	48" A x 66" B x 24" C x 30" D	HWJ58ABRP	84	9.2	\$1075	\$1107
	48" A x 72" B x 24" C x 30" D	HWJ59ABRP	88	9.2	\$1082	\$1114
						
	Peninsula Worksurfaces					
	60" W x 24" D	HWP2460P	65	4.9	\$505	\$526
	66" W x 24" D	HWP2466P	72	4.6	\$616	\$637
	72" W x 24" D	HWP2472P	95	5.5	\$692	\$713
	60" W x 30" D	HWP3060P	68	5.0	\$808	\$829
	66" W x 30" D	HWP3066P	75	6.0	\$887	\$908
	72" W x 30" D	HWP3072P	98	6.0	\$975	\$996
						

NOTES:

- Worksurfaces may be used with Accelerate®, Abound® and Voi® products.
- Worksurfaces are constructed of laminate on 1½" solid core high-performance particleboard.
- Order support column separately — see page 556.
- Can also be attached perpendicular to a primary worksurface using Flat Brackets. Do not attach to a worksurface supported with Cantilever Brackets.
- Add suffix "N" to Model Number for worksurfaces with no grommets. No upcharge.
- Refer to Worksurface Supports, pages 554-558.

ⓘ Not designed to be used freestanding.

ⓘ All worksurfaces with an unsupported span of 54" or larger require the use of an external channel. See table on page 542 for required length by application.

HOW TO SPECIFY

<p>Select Model Number</p> <p>No Grommet option: Add "N" suffix (no upcharge)</p> <p>HWJ58ABLP .</p> <p>HWJ58ABLPN .</p>	<p>Select Laminate</p> <p>See page 413</p> <p>AS .</p> <p>AS .</p>	<p>Select Edge Color</p> <p>See page 413</p> <p>K .</p> <p>K .</p>	<p>Select Grommet Color</p> <p>See page 413</p> <p>T1</p>
---	---	---	--

SYSTEMS WORKSURFACES

Half-Round / Quarter Round / 60° Wedge

GSA SIN 33721



Icon Legend on page 19

WORKSTATIONS

Grain Direction

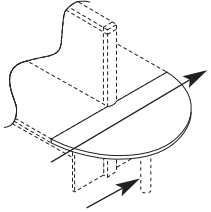

Requires Support Column — see page 556.

DESCRIPTION

Abound® Half-Round Worksurfaces
 50"W x 30"D Connects to two 24"D Worksurfaces
 62"W x 36"D Connects to two 30"D Worksurfaces

Accelerate® Half-Round Worksurfaces
 50"W x 30"D Connects to two 24"D Worksurfaces
 62"W x 36"D Connects to two 30"D Worksurfaces

NOTES: Order one Support Column and two Universal Support Legs or Full End Panel — see pages 554-556.

MODEL

HBWD2450P
HBWD3062P

HCWD2450P
HCWD3062P

SHIP WEIGHT

52
 58

52
 58

CUBE

5.0
 6.1

5.0
 6.1

L1 LIST PRICE

\$797
\$930

\$797
\$930

L2 LIST PRICE

\$813
\$951

\$813
\$951

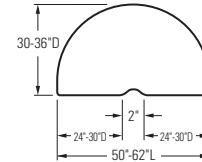

NOTES:

- Worksurfaces are constructed of laminate on 1½" solid core high-performance particleboard.

Half-Round Worksurfaces

- Order Support Column and End Panels separately.

HOW TO SPECIFY

Select Model Number

HBWD2450P .
 HCWD2450P .

Select Laminate

See page 413

A5 .
 A5 .

Select Edge Color

See page 413

K
 K



SYSTEMS COUNTERTOPS

Straight and Corner

	DESCRIPTION	MODEL	SHIP WEIGHT	CUBE	L1 LIST PRICE	L2 LIST PRICE
Grain Direction 	Abound® and Accelerate® 15"D Straight Countertops					
	24"W x 15"D	HBCSR1524P	19	1.4	\$286	\$297
	30"W x 15"D	HBCSR1530P	25	1.4	\$317	\$328
	36"W x 15"D	HBCSR1536P	27	1.6	\$354	\$365
	42"W x 15"D	HBCSR1542P	32	1.8	\$363	\$374
	48"W x 15"D	HBCSR1548P	38	2.1	\$384	\$395
	60"W x 15"D	HBCSR1560P	48	2.6	\$487	\$503
66"W x 15"D	HBCSR1566P	53	2.7	\$503	\$519	
72"W x 15"D	HBCSR1572P	59	3.1	\$523	\$539	
Grain Direction 	Abound® and Accelerate® 15"D Corner Countertops					
	24"W x 24"D	HBCSR2424P	44	1.4	\$546	\$562
	30"W x 30"D	HBCSR3030P	51	1.4	\$634	\$650
	36"W x 36"D	HBCSR3636P	58	1.6	\$706	\$727

NOTES:

- Countertops constructed with high-pressure laminate.
- Specify laminate and Edgeband options color.

HOW TO SPECIFY

<p>Select Model Number</p> <p>H B C S R 1 5 2 4 P .</p>	<p>Select Laminate</p> <p>See page 413</p> <p>A 5 .</p>	<p>Select Edge Color</p> <p>See page 413</p> <p>K</p>
--	--	--

SYSTEMS COUNTERTOPS

Straight and Corner

GSA SIN 33721



Icon Legend on page 19

WORKSTATIONS

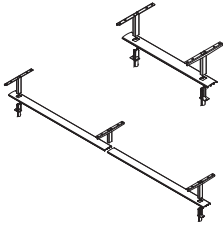

DESCRIPTION	FLAT MODEL	CHAMFERED MODEL	SHIP WEIGHT	CUBE	LIST PRICE BY PAINT GRADE	
					P1	P2
Abound® Raised Straight Countertop Kits						
24"W	HRVBR1524F	HRVBR1524	5	1.0	\$179	\$197
30"W	HRVBR1530F	HRVBR1530	5	1.0	\$187	\$205
36"W	HRVBR1536F	HRVBR1536	6	2.0	\$198	\$216
42"W	HRVBR1542F	HRVBR1542	6	2.0	\$204	\$222
48"W	HRVBR1548F	HRVBR1548	7	2.0	\$212	\$230
60"W	HRVBR1560F	HRVBR1560	8	2.0	\$251	\$269
66"W	HRVBR1566F	HRVBR1566	8	3.0	\$269	\$287
72"W	HRVBR1572F	HRVBR1572	9	3.0	\$288	\$306

! Do not order top caps for the panels the Countertop Kits will be installed on. Countertop Kits come with the necessary top caps and hardware.

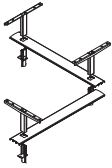

Abound® Raised Corner Countertop Kits						
24"W	HRVBR1524PF	HRVBR1524P	5	1.0	\$222	\$240
30"W	HRVBR1530PF	HRVBR1530P	6	1.0	\$232	\$250
36"W	HRVBR1536PF	HRVBR1536P	6	2.0	\$243	\$261

! Do not order top caps for the panels the Countertop Kits will be installed on. Countertop Kits come with the necessary top caps and hardware.

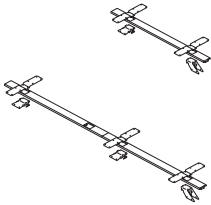

Abound® Straight Countertop Kits						
24"W	HBCKIT24F	HBCKIT24	5	0.7	\$69	\$75
30"W	HBCKIT30F	HBCKIT30	5	0.9	\$73	\$80
36"W	HBCKIT36F	HBCKIT36	6	0.9	\$76	\$83
42"W	HBCKIT42F	HBCKIT42	6	1.2	\$79	\$86
48"W	HBCKIT48F	HBCKIT48	7	1.4	\$81	\$88
60"W	HBCKIT60F	HBCKIT60	8	1.8	\$84	\$92
66"W	HBCKIT66F	HBCKIT66	8	1.8	\$87	\$95
72"W	HBCKIT72F	HBCKIT72	9	1.9	\$90	\$98

! Straight Countertop Kits must match the width of the corresponding panel onto which they are installed.

! 66"W kit must be used with 30" and 36"W frames.

! 72"W kit must be used with two 36"W frames.

! Do not order top caps for the panels onto which the Countertop Kits are installed. Countertop Kits come with the necessary top caps and hardware.

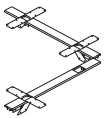

Abound® Corner Countertop Kits						
24"W	HBCKIT24F	HBCKIT24	5	0.7	\$83	\$90
30"W	HBCKIT30F	HBCKIT30	6	1.0	\$92	\$100
36"W	HBCKIT36F	HBCKIT36	6	1.0	\$95	\$103

! Do not order top caps for the panels the Countertop Kits will be installed on. Countertop Kits come with the necessary top caps and hardware.

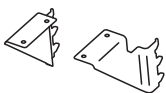

Accelerate® Countertop Bracket Kit	HECB01	1	0.1	\$71	\$75
---	---------------	----------	-----	-------------	-------------

! For use with all panel heights, except 42½".

! Top caps required and specified separately from Accelerate® Countertop Bracket Kits.

Accelerate® Countertop Bracket Kit for 42½"H Panels	HECB42	1	0.1	\$71	\$75
--	---------------	----------	-----	-------------	-------------

! For use with 42½"H Panels only.

! Top caps required and specified separately from Accelerate® Countertop Bracket Kits.

! Bracket kits include one right and one left hand bracket. Order two sets of brackets for the straight countertop models and three sets for the corner countertop models. To be used on Accelerate® panels only.

SPECIFYING EXAMPLE: HECB01.LOFT

HOW TO SPECIFY

Select Model Number

Select Paint Color

See page 413

HRVBR1524

A5



SYSTEMS SHELVES

Corner Shelves

DESCRIPTION	MODEL	SHIP WEIGHT	CUBE	L1	L2
				LIST PRICE	LIST PRICE
Corner Shelves 36" x 36" x 12"D 42" x 42" x 12"D	HCS3636P	33	3.6	\$519	\$540
	HCS4242P	33	3.6	\$544	\$571

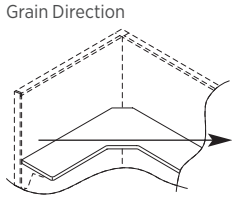

NOTES:

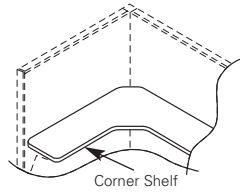

- Corner Shelves may be used with both Abound® and Accelerate® systems products.
- Diagonal leading edge = 10½"
- Diagonal depth = 22½"
- Includes panel attachment brackets.

HOW TO SPECIFY

<p>Select Model Number</p> <p>HCS3636P</p>	<p>Select Laminate</p> <p>See page 413</p> <p>AS</p>	<p>Select Edge Color</p> <p>See page 413</p> <p>K</p>	<p>Select Paint Color</p> <p>See page 413</p> <p>T1</p>
---	---	--	--

SYSTEMS Worksurface Supports

GSA SIN 33721



Icon Legend on page 19

WORKSTATIONS

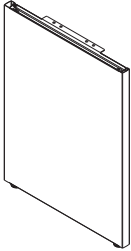

Specify paint

DESCRIPTION	MODEL	SHIP WEIGHT	CUBE	LIST PRICE BY PAINT GRADE	
				P1	P2
Abound® and Accelerate® Full End Panel*					
29½" H x 11" D — Right — Panel Mount	HRVEP1129R	16	1.4	\$266	\$297
29½" H x 11" D — Left — Panel Mount	HRVEP1129L	16	1.4	\$266	\$297
29½" H x 24" D — Right — Panel Mount	HRVEP2429R	21	1.4	\$287	\$318
29½" H x 24" D — Left — Panel Mount	HRVEP2429L	21	1.4	\$287	\$318
29½" H x 30" D — Right — Panel Mount	HRVEP3029R	23	1.4	\$313	\$344
29½" H x 30" D — Left — Panel Mount	HRVEP3029L	23	1.4	\$313	\$344

NOTES: The use of an end panel at the end of a worksurface will increase the rigidity of the workstation. If the panel is a greater dimension than the worksurface, an end panel is required if the run of the worksurfaces is 8 feet or greater. Levelers provide ½" vertical adjustment.

- ! *Must be connected into panel slots. When an installation of worksurfaces is 8 feet or greater, a full end panel or universal support leg must be used at 90 degree panel junctions or in a shared position to support adjoining worksurfaces.
- ! End panel support with bracket will attach to both Accelerate® and Abound® panels.

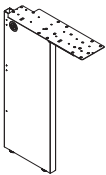

Non-handed unit
Specify paint

Abound® and Accelerate® Universal Support Leg*					
29½" H to support 24" D	HRVCLG24	16	1.4	\$255	\$286
29½" H to support 30" D	HRVCLG30	17	1.4	\$278	\$309

NOTES: Use at 90° panel junctions or in a shared position to support adjoining worksurfaces. Provided with flat bracket. Levelers provide ½" vertical adjustment.

- ! *Must be connected into panel slots. When an installation of worksurfaces is 8 feet or greater, a full end panel or universal support leg must be used at 90 degree panel junctions or in a shared position to support adjoining worksurfaces.

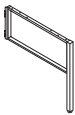

Open Leg Models*					
29½" H x 12" D	HOLEG12	7	0.5	\$191	\$222
29½" H x 18" D	HOLEG18	9	1.4	\$221	\$252
29½" H x 24" D	HOLEG24	11	1.2	\$266	\$297
29½" H x 30" D	HOLEG30	15	1.8	\$291	\$322

NOTES: Open leg includes attaching hardware and leveling glides. Leveling glides provide ¼" of adjustment. Open leg is universal shared with a left- and right-hand attachment bracket.

- ! *Must be connected into frame slots. Specify paint.

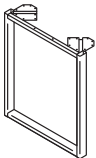

O-Leg Support for Worksurfaces					
20" D x 28½" H	HLSL2028O	15	3.7	\$394	\$399
24" D x 28½" H	HLSL2428O	17	3.7	\$428	\$433
30" D x 28½" H	HLSL3028O	19	5.4	\$474	\$479

NOTES: Ship fully assembled, 1/pack. Non-handed. Use the anti-dislodgement bracket when using a worksurface in a peninsula application with a post or O-leg.



DESCRIPTION	MODEL	SHIP WEIGHT	CUBE	LIST PRICE BY PAINT GRADE		
				P1	P2	P3
Voi® for Systems O-Leg-to-Panel Attachment Bracket						
Left handed bracket (quantity 1)	HLSLPBL	3	0.4	\$134	\$139	N/A
Right handed bracket (quantity 1)	HLSLPBR	3	0.4	\$134	\$139	N/A

NOTES: Used to connect Voi O-Leg to a systems panel for additional workstation rigidity. Bracket designed to work with edgeband worksurfaces only. Brackets are handed, come one per package and include self-tapping screws. Specify paint.

NOTES:

- The supports included on this page can be used with Systems and Worksurfaces.

HOW TO SPECIFY

Select Model Number

Select Paint Color

See page 173

HRVEP1129R

T1



SYSTEMS Worksurface Supports

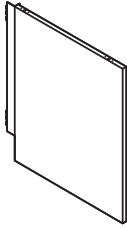

DESCRIPTION	MODEL	SHIP WEIGHT	CUBE	LIST PRICE BY PAINT GRADE	
				P1	P2
Laminate End Panel Support with Panel Bracket					
29½”H x 24”D, Left handed	HLSL2428EBL	3	2.2	\$348	\$353
29½”H x 24”D, Right handed	HLSL2428EBR	3	2.2	\$348	\$353
29½”H x 30”D, Left handed	HLSL3028EBL	3	3.2	\$370	\$375
29½”H x 30”D, Right handed	HLSL3028EBR	3	3.2	\$370	\$375

NOTES: Includes laminate end panel and brackets to attach end panel support to a panel. Order to correspond to worksurface depth. Specify laminate and paint. Can be used with Abound® and Accelerate® Systems products.

NOTES:

- The supports included on this page and on previous page can be used with Systems and Worksurfaces.

HOW TO SPECIFY

<p>Select Model Number</p> <p>H L S L 2 4 2 8 E B L .</p>	<p>Select Laminate</p> <p>L2 Laminate Upcharge \$11 See page 413</p> <p>H .</p>	<p>Select Paint Color</p> <p>See page 413</p> <p>T 1</p>
--	--	---

SYSTEMS

Worksurface Supports

GSA SIN 33721



Icon Legend on page 19

WORKSTATIONS

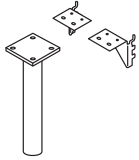

Non-handed unit
Specify paint

DESCRIPTION

Support Column*

For 29½" Height. 3" diameter.

MODEL

HCNLEG29

SHIP WEIGHT

13 Ⓞ

CUBE

1.1

LIST PRICE BY PAINT GRADE

P1

\$281

P2

\$310

NOTES: Used to support one end of a peninsula, round or half-round worksurface. (Includes panel support brackets.) Levelers provide 1½" vertical adjustment.

! *Brackets must be connected into panel slots.



Post Leg Base

• Single Post Leg with Hardware Pack

HMBPOST1

18

2.3

\$380

\$393

• Requires hardware bracket model HWSA2. Please see below for HWSA2 bracket ordering information.

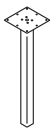

Post Leg Base

28½"H x 2" square

HLSL28P

15

1.0

\$385

\$390

NOTES: Requires hardware bracket model HWSA2 when used to support a peninsula.

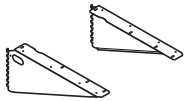

Specify paint

Accessory Cantilever*

18"D Pair

HCTL182

4 Ⓞ

0.3

\$87

\$98

24"D Pair

HCTL242 Ⓞ

5 Ⓞ

0.3

\$110

\$121

18"D Right-Hand Cantilever

HCTL181R

3.2 Ⓞ

0.2

\$48

\$59

18"D Left-Hand Cantilever

HCTL181L

3.2 Ⓞ

0.2

\$48

\$59

24"D Right-Hand Cantilever

HCTL241R

3.7 Ⓞ

0.6

\$60

\$71

24"D Left-Hand Cantilever

HCTL241L

3.7 Ⓞ

0.6

\$60

\$71

! *Must be connected into panel slots.

! Accelerate® only: Cantilevers only to be used on worksurface runs 72"W or less.

! Use with runs 72" or less – avoid installation on only one side of a straight connection except to support corner worksurfaces. Floor support is required for runs longer than 72".

! DO NOT position at the end of a panel run where no 90 degree return panel is positioned.

! DO NOT use to support worksurfaces from which a hanging pedestal is suspended, or to which a peninsula worksurface is attached.

! DO NOT use cantilever brackets to support worksurfaces supported with permanent wall hanger kit.

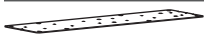

Flat Bracket

18"D

HHN831118

3 Ⓞ

0.2

\$83

N/A

24"D

HHN831124 Ⓞ

3 Ⓞ

0.3

\$85

N/A

30"D

HHN831130

3 Ⓞ

0.4

\$85

N/A

NOTES: Flat Brackets can be used to connect one worksurface perpendicular to another worksurface.

! Charcoal only.

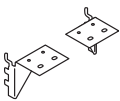

Specify paint

Worksurface Bracket Kit*

One Pair

HWSB2 Ⓞ

1 Ⓞ

0.1

\$62

\$66

NOTES: Used to connect the end of a worksurface to a panel of the same width.

! Always use when the depth side of a worksurface is against a panel (return/wing panel) of the same dimension. This will increase the sturdiness of the workstation.

! *Must be connected into panel slots.

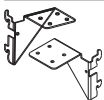

Anti-Dislodgement Bracket Kit

HWSA2

1

0.1

\$60

\$64

NOTES: To be used with models HMBPOST1 and HLSL28P Post Leg Base.

NOTES:







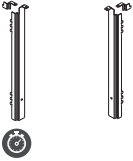

- The supports included on this page can be used with Systems Worksurfaces.

HOW TO SPECIFY

Select Model Number H C T L 2 4 2 .	Select Paint Color T 1 See page 413
---	--



WORKSURFACE BRACKETS

	DESCRIPTION	MODEL	SHIP		LIST PRICE BY PAINT GRADE		
			WEIGHT	CUBE	P1	P2	P3
	Flagship® Pedestal to Panel Bracket Kit, Left	HPD2PNBRK2L	3.0 	0.3	\$148	\$157	\$159
	Flagship® Pedestal to Panel Bracket Kit, Right	HPD2PNBRK2R	3.0 	0.3	\$148	\$157	\$159
NOTES: Bracket to attach 22 ⁷ / ₈ "D pedestals to 24"D worksurface or 28 ⁷ / ₈ "D pedestals to 30"D worksurface.							
	Worksurface to Tower Bracket Kit						
	Bracket to attach storage towers to worksurfaces.	HSTB2W1	4.0 	0.6	\$112	\$126	\$128
NOTES: Replaces the need for a panel attached end panel. Standard with hardware to attach bracket to panel and worksurface.							
 Bracket cannot be used as a support when placing Stack-on Storage on worksurface over bracket. Must use two full-sized supports when using Stack-on Storage.							
 Not for use with systems support pedestals.							
	Worksurface-to-Wing Panel Bracket						
	24"W	HWSR24	2.5	0.4	\$78	N/A	N/A
	30"W	HWSR30	3.0	0.4	\$78	N/A	N/A
	36"W	HWSR36	3.5	0.5	\$78	N/A	N/A
	42"W	HWSR42	4.0	0.5	\$78	N/A	N/A
	48"W	HWSR48	4.5	0.6	\$78	N/A	N/A
NOTES:							
• To be used when the adjacent wing panel is wider than the worksurface depth.							
• Specify support to the same width as your adjacent wing panel, not the depth of your worksurface.							
• Support spans the entire width of the wing panel.							
• Supports are non-handed.							

HOW TO SPECIFY

<p>Select Model Number</p> <p>HPD2PNBRK2L . T1</p>	<p>Select Paint Color</p> <p>See page 413</p>
--	---

SYSTEMS

Worksurface Supports

GSA SIN 33721



Icon Legend on page 19

WORKSTATIONS

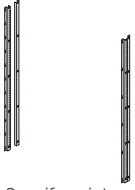

Specify paint

DESCRIPTION	MODEL	SHIP WEIGHT	CUBE	LIST PRICE BY PAINT GRADE	
				P1	P2
Abound® and Accelerate® Permanent-Wall Hanger Kit Wall Hanger Kit (2 pieces) 66"H LH/RH End Pair	HRVC35PCE ⓘ	6	0.7	\$293	\$314
Shared Wall Hanger Kit 66"H	HRVC35PCM	3	0.7	\$155	\$166

NOTES: Anchor devices are not supplied with these models. Refer to Abound® or Accelerate® Installation instructions for appropriate hardware. Used to hang storage cabinets and bookshelves from permanent wall, and/or to attach worksurfaces to permanent wall.

- ⓘ Attachment to masonry walls is not recommended.
- ⓘ Worksurfaces should not be supported with Cantilever brackets when using Permanent-Wall Hanger Kit.

NOTES:

- Wall track has 1/8" x 1/2" slots on 1" centers.
- Customer to furnish connecting hardware. (Refer to Installation Instructions for appropriate hardware.)
- Includes a cover for top of channel.

HOW TO SPECIFY

<p>Select Model Number</p> <p>HRVC35PCE</p>	<p>Select Paint Color</p> <p>See page 413</p> <p>T1</p>
---	---

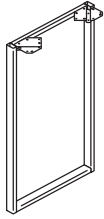

STANDING-HEIGHT WORKSURFACE SUPPORTS

**DESCRIPTION****Standing-Height O-Leg Support for Worksurfaces**

24"D x 41"H

30"D x 41"H

NOTES: Ship fully assembled, 1/package. Non-handed.

MODEL	SHIP WEIGHT	CUBE	LIST PRICE BY PAINT GRADE	
			P1	P2
HLSL2441O	16	5.3	\$571	\$578
HLSL3041O	17	6.5	\$639	\$646

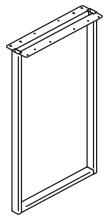
**Standing-Height O-Leg Shared Support for Worksurfaces**

24"D x 41"H

30"D x 41"H

NOTES: Ship fully assembled, 1/package. Non-handed.

HLSL2441SL	16	5.3	\$644	\$651
HLSL3041SL	17	6.5	\$711	\$718

NOTES:

- O-leg glides have 2" adjustability.
- Shared O-legs create a cleaner aesthetic in all applications where two legs are used side-by-side.
- O-Leg to Panel Attachment Brackets are used to connect Voi® O-Legs to a systems panel for additional worksurface rigidity.

! O-legs may only be attached to worksurfaces, not storage units.

HOW TO SPECIFY

Select
Model Number

H L S L 2 4 4 1 O

Select
Paint Color

See page 173

T 1

SYSTEMS

Standard Height Support Pedestals

GSA SIN 33721



Icon Legend on page 19

WORKSTATIONS

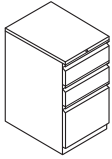

DESCRIPTION

Standard Height Freestanding Support Pedestals — Box/Box/File
 15"W x 19⁷/₈"D x 28"H
 15"W x 22⁷/₈"D x 28"H

MODEL

HVFB20R
HVFB23R

SHIP WEIGHT

89.0
 95.0

CUBE

7.0
 8.0

LIST PRICE BY PAINT GRADE

P1	P2	P3
\$715	\$745	\$761
\$736	\$766	\$784

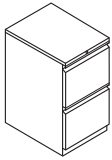

Standard Height Freestanding Support Pedestals — File/File
 15"W x 19⁷/₈"D x 28"H
 15"W x 22⁷/₈"D x 28"H

HVFF20R
HVFF23R

88.0
 94.0

7.0
 8.0

\$709	\$739	\$755
\$730	\$760	\$778

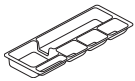

Optional Pencil Tray

HV-UT1

0.5

0.1

\$94	N/A	N/A
------	-----	-----

- For use with mobile and freestanding pedestal models.
- No specification required.

NOTES:

- 28"H fits under all HON worksurfaces and desk shells.
- Ball-bearing suspension on file drawer (90% extension), and box drawer (90% extension on both drawers).
- File drawers have high sides for filing front-to-back.
- Available in "R" pull only.
- Pencil tray standard in top box drawer.
- One box divider standard in each box drawer.
- One crossrail standard in each file drawer.

Freestanding models must be used under a worksurface only.

HOW TO SPECIFY

Select Model Number

H V F B 2 0 R .

Select Lock Option

L Lock (no upcharge)

L .

Select Paint Color

See page 413

P

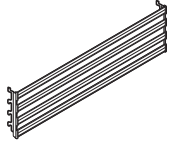

DESCRIPTION	MODEL	SHIP WEIGHT	CUBE	LIST PRICE BY PAINT GRADE		
				P1	P2	P3
Paper Management Support Bars						
24"W x 5"H	HNPBWSW24	1.3	0.4	\$252	\$265	\$275
30"W x 5"H	HNPBWSW30	1.5	0.5	\$270	\$283	\$293
36"W x 5"H	HNPBWSW36	2.0	0.6	\$280	\$293	\$303
42"W x 5"H	HNPBWSW42	5.0	0.7	\$294	\$307	\$317
48"W x 5"H	HNPBWSW48	7.0	0.8	\$306	\$319	\$329
60"W x 5"H	HNPBWSW60	9.0	0.9	\$347	\$360	\$370

ⓘ Recommended weight capacity not to exceed 80 pounds. Paper management bar attaches to Systems panels/frames to accommodate work flow accessories.

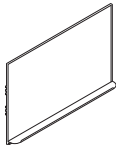

DESCRIPTION	MODEL	SHIP WEIGHT	CUBE	LIST PRICE
Markerboards				
36"W x 24"H	HHMRK36	15.0	3.2	\$654
42"W x 24"H	HHMRK42	17.0	4.0	\$709
48"W x 24"H	HHMRK48	19.0	4.6	\$763

ⓘ No color specification required.

ⓘ Can be used as a writing surface/magnetic bulletin board.

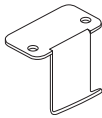

Back Pack Hook (10 per carton)	HCLA65	10.0	0.1	\$119
---------------------------------------	---------------	------	-----	--------------

NOTES: Assembly: attaches to bottom of desk with (2) screws, included.

ⓘ Available in Titanium finish only, no specification needed.

OPEN MARKET



HOW TO SPECIFY

Select Model Number

H N P M B S W 2 4

Select Paint Color

See page 413

P 8 S



Versé® Panels shown with SmartLink® Value Mobile Storage, Between™ Multi-Purpose Table, and Motivate® Stacking Chair.

VERSÉ®

Create more personal space in open areas with the Versé panel system. Easily connected and endlessly reconfigurable, Versé panels can maintain sightlines or maximize privacy, and keep frequently used items conveniently within reach. It's the smart long-term investment to support short-term work environments that are constantly changing.



FEATURES

- A variety of Versé panel widths and heights easily connect to one another to form workstations or offer privacy as space dividers. Available in sizes ranging from 24"-72"W and 42"-72"H.
- Steel hanging shelf hangs off the top of a Versé panel.
- Choose from three paint options to customize your office space.

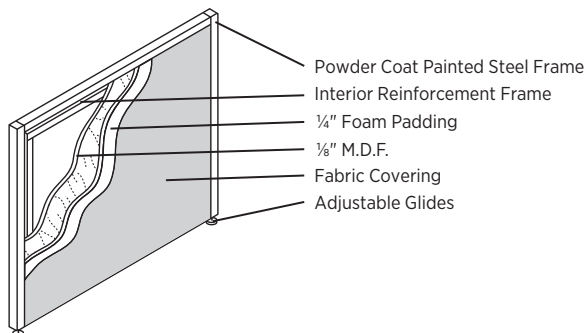
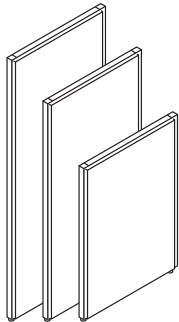
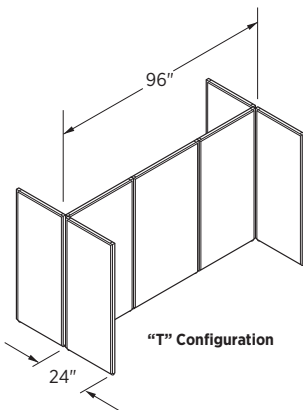
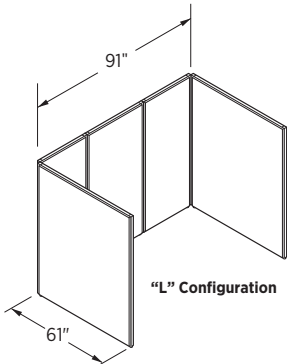

FEATURES

Panels

- Use Versé as a privacy panel (stand-alone) to create space division.

QuickConnect (See page 566 for more details on this hardware.)

- Our QuickConnect connectors allow for easy installation. Simply snap on the connectors at the top and bottom of the panel and slide the panels together. There are only two connectors to specify for almost all configurations.

Storage

- Shelving capabilities. Each shelf width must match width of panel.

PANEL DIMENSIONS AND GROWTH ALLOWANCES

- All panel runs must be supported at each end of the panel run and supported at least every 8' within the panel run (maximum of 8' between supports).
- Support can be in the form of an adjustable wall bracket or return panel at 90° to the run.
- When using an "L" configuration, the return panel must measure at least 60% (minimum 36") of the unsupported run.
- When using a "T" configuration, each return panel must measure at least 20% of the unsupported run.
- Return panels can be no more than 24" lower than the panel height in the unsupported run.
- When used in conjunction with hanging shelves, panel width must match width of shelf.

VERSÉ PANELS

Includes

- Adjustable glides with all panels.

What Do I Need?

- QuickConnect Connectors.

Special Notes

- Versé panels feature a soft, padded look.
- Panels packed two per carton when possible.

VERSÉ® Panel System

Connection Type	Connectors Needed
Straight	1 pair – 180°
2-way (L)	1 pair – 90°
3-way (T)	2 pair – 90°
4-way (X)	3 pair – 90°

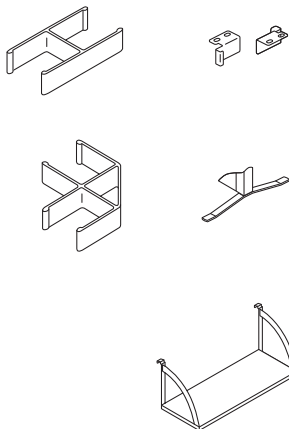

CONNECTING HARDWARE

Versé QuickConnect User Instructions

- Versé QuickConnect is easy to install. Simply snap on the connectors at the top and bottom of the panel and slide the panels together. There are only two connectors to specify for almost all configurations, including multi-height connections.
- 180° Straight Connector – use when connecting two panels together for a straight connection or for multi-height straight connections.
- 90° Corner Connector – use for 2-way, 3-way and 4-way corner connections. Only one pair is needed per corner connection or for multi-height corner connections.

HARDWARE

Special Notes

- Connectors add to the overall dimensions of the panel installation.
- These connector dimensions are important when space planning and sizing your panel layout.
- All hardware items may ship by a parcel service.
- Use HBV-PBS bracket with freestanding furniture for optimal workstation rigidity.

SHELVES

- Steel shelves are 14½" high.
- End brackets included.
- Must match panel width.
- Easy assembly; no tools required.

PAINT & PANEL FABRIC ORDERING CODES

PAINTS	
Black	P
Light Gray	Q
Putty	L

FABRIC PANELS	
SEAWAY	2310
◇ Grey	2310GRE

FABRIC PANELS <i>continued</i>	
CENTURION*	CU
◇ Apricot	CU47
◇ Bark	CU25
◇ Black	CU10
◇ Espresso	CU49
◇ Fog	CU03
◇ Frost	CU22
◇ Goldenrod	CU27
◇ Indigo	CU06
◇ Iris	CU50
◇ Iron Ore	CU19
◇ Jade	CU83
◇ Marsala	CU63
◇ Morel	CU24
◇ Navy	CU98
◇ Peacock	CU97
◇ Pear	CU84
◇ Ruby	CU67
◇ Sapphire	CU09

FABRIC PANELS <i>continued</i>	
CONTOURETT POLYURETHANE*	VUR
◇ Baltic	VUR94
◇ Beach	VUR23
◇ Black	VUR10
◇ Bordeaux	VUR63
◇ Buff	VUR22
◇ Cloud	VUR18
◇ Coffee Bean	VUR49
◇ Crater	VUR51
◇ Flame	VUR62
◇ Graphite	VUR19
◇ Iron	VUR20
◇ Luggage	VUR26
◇ Marine	VUR92
◇ Navy	VUR95
◇ Nimbus	VUR93
◇ Ocean	VUR96
◇ Pumpkin	VUR42

FABRIC PANELS <i>continued</i>	
CONTOURETT POLYURETHANE*	VUR <i>continued</i>
◇ Quarry	VUR24
◇ Red	VUR64
◇ Safari	VUR27
◇ Sage	VUR82
◇ Steel	VUR21
◇ Storm	VUR17
◇ Taupe	VUR28
◇ Trunk	VUR50

* Centurion and Contourett fabrics are only able to exceed 54" in one direction (vertically or horizontally), not both directions.

! To clean Versé Panels with Contourett use a 1:5 diluted bleach and water mixture or Virex II 256. Leave cleaning solution on for at least 30 seconds but no longer than two minutes. Thoroughly remove the solution from the surface with a clean cloth and warm water. May cause discoloration if left on the surface longer than the suggested time or not removed after sanitizing.

◇◇◇ For lead time information see page 21.

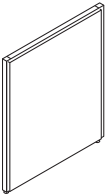
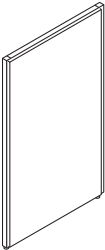
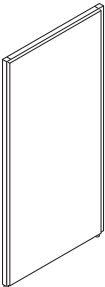
	DESCRIPTION	MODEL	SHIP WEIGHT	CUBE	LIST PRICE
	42" H Panel				
	42" H x 24" W	HBV-P4224	18	1.8	\$429
	42" H x 30" W	HBV-P4230	22	2.2	\$445
	42" H x 36" W	HBV-P4236	24	2.7	\$451
	42" H x 42" W	HBV-P4242	33	3.1	\$453
	42" H x 48" W	HBV-P4248	34	3.6	\$473
	42" H x 60" W	HBV-P4260	36	4.4	\$508
	42" H x 72" W	HBV-P4272	48	5.3	\$585
	60" H Panel				
	60" H x 24" W	HBV-P6024	30	2.5	\$476
	60" H x 30" W	HBV-P6030	33	3.2	\$494
	60" H x 36" W	HBV-P6036	35	3.8	\$495
	60" H x 42" W	HBV-P6042	37	4.4	\$519
	60" H x 48" W	HBV-P6048	42	5.0	\$526
	60" H x 60" W	HBV-P6060	54	6.4	\$549
	60" H x 72" W	HBV-P6072	60	7.5	\$642
	72" H Panel				
	72" H x 24" W	HBV-P7224	39	3.0	\$536
	72" H x 30" W	HBV-P7230	40	3.8	\$546
	72" H x 36" W	HBV-P7236	44	4.5	\$573
	72" H x 42" W	HBV-P7242	46	5.2	\$599
	72" H x 48" W	HBV-P7248	50	6.0	\$614
	72" H x 60" W	HBV-P7260	62	7.5	\$679

NOTES:

- **HON 5-Year Limited Warranty.**
- Panels feature 1" powder coat painted steel frame construction with interior reinforcement, ¼" foam padding and ⅛" M.D.F.
- All panels include adjustable glides.
- To free-stand a single Versé panel or to stabilize the end of a panel run, order T-base stabilizing foot shown on page 566.

HOW TO SPECIFY

<p>Select Model Number</p> <p>HBV - P 4 2 2 4</p>	<p>Select Upholstery</p> <p>See page 564</p> <p>2 3 1 0 G R E</p>	<p>Select Trim Color</p> <p>See page 564</p> <p>P</p>
--	--	--



VERSÉ® Panel System

OPEN MARKET

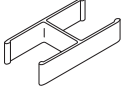
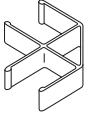

Icon Legend on page 19

WORKSTATIONS

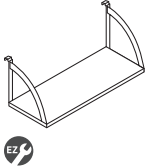
	DESCRIPTION	MODEL	SHIP WEIGHT	CUBE	LIST PRICE
	180° QuickConnect Straight Panel Connector Pair NOTES: 180° connector to be used to connect two panels in a straight connection or for multi-height straight connections.	HBV-QC180	0.1	0.3	\$36
	90° QuickConnect Panel Connector Pair NOTES: 90° connector to be used for 2-way, 3-way or 4-way corner connections, or for multi-height connections.	HBV-QC90	0.1	0.3	\$36
	Wall Bracket	HBV-PWB1	0.2	0.3	\$75
	Panel-to-Worksurface Bracket Pair	HBV-PBS	0.3	0.3	\$63
	T-Base Stabilizing Foot 1¼"H x 18¾"L	HBV-TBASE	6.0	0.3	\$68
	Hanging Shelves 24"W x 12¾"D 30"W x 12¾"D 36"W x 12¾"D 42"W x 12¾"D 48"W x 12¾"D 60"W x 12¾"D NOTES: Shelves hang over the top of panels. Supporting panel must match the width of the shelf.	HBV-VSH24 HBV-VSH30 HBV-VSH36 HBV-VSH42 HBV-VSH48 HBV-VSH60	9.0 10.0 12.0 13.0 14.0 19.0	1.2 1.5 1.8 2.0 2.3 2.9	\$274 \$305 \$332 \$357 \$409 \$464

NOTES:

- **HON 5-Year Limited Warranty.**
- T-base stabilizing foot optional.
- Extruded aluminum connectors are sold in pairs and are used at top and bottom of panels.
- Shelves feature steel construction with powder coat paint finish.
- Shelves ship easy to assemble – no tools required.

HOW TO SPECIFY

<p>Select Model Number</p> <p>HBV-QC180</p>	<p>Select Trim Color</p> <p>See page 564</p> <p>P</p>
---	---

OVERVIEW OF PERSONAL STORAGE AND PEDESTALS

LATERAL FILES

Advantages:

a) The most efficient means of conventional filing; b) Ideal for active filing in workstations, where higher volume capacity is necessary and retrieval is frequent

Considerations:

2-drawer steel lateral files fit under standard-height worksurfaces when using panel systems.

VERTICAL FILES

Advantages:

a) Economical; b) The most widely used filing method; c) requires minimal floor space

Considerations:

Vertical files are best suited for long-term storage, where retrieval is less frequent. For larger banks of files, lateral files are more space-efficient than vertical files.

BOOKCASES

Advantages:

a) These units are ideal for binders, reference books or other items; b) Available with your choice of fixed or movable shelves

Considerations:

If working with panel systems, it is more attractive to specify units that are lower than the panel height.

FILING TECHNIQUES

Type	Standing Files	Hanging Files
Advantages	Inexpensive. Uses existing file folders.	Easier organization and identification of the file folders. Files viewed from top. Remaining files hold their place when folders are removed. Easier to re-stock.
Requirements	Follower block or Dividers	Hangrails or high-drawer sides
Can be used in	<ul style="list-style-type: none"> Vertical files (front-to-back only) Lateral files (side-to-side only in drawers) Shelf files (side-to-side only) 	<ul style="list-style-type: none"> Vertical files (front-to-back only) Lateral files (front-to-back or side-to-side in drawers)

Contain[®]/Flagship[®]/Brigade[®] Series Pedestals Utilization with 38000 Series.

Pedestal Depths	Abound [®] and Accelerate [®] Panel-Hung Worksurfaces			38000 Series Modular Desks		
	18" Deep	24" Deep	30" Deep	24" Deep	30" Deep	36" Deep
16 ³ / ₄ " Deep	•	•	•	•	•	•
22 ⁷ / ₈ " Deep		•	•	•*	•	•
28 ⁷ / ₈ " Deep			•		•	•

* Cannot attach 22⁷/₈"D Hanging Pedestal.

WORKING WITH STORAGE PEDESTALS

Storage Pedestals are available in 5 styles:

- Box/File Mobile.....(Model Nos. beginning with HSPM)
- Freestanding(Model Nos. beginning with HSPF)
- Hanging(Model Nos. beginning with HSPH)
- Worksurface Supporting**(Model Nos. beginning with HSPS)
- Under Worksurface Mobile.....(Model Nos. beginning with HSPM)

Worksurface height supporting pedestals have a taller base plate, resulting in a taller overall cabinet height. Consideration must be made to ensure that units align visually with each other. The accompanying chart will help you select the correct pedestal for your application.

Pedestal Models (Nos. begin with)	Style	Overall Height	Base Height	Spacer Required Below Worksurface
HSPM or H15	Box/File mobile	22 ⁵ / ₈ "	N/A	N/A
HSPF	Freestanding	28"	3 ¹ / ₂ "	NO
HSPH or H14	Hanging	19 ¹ / ₂ "	N/A	N/A
HSPS or H19 or H36	Worksurface supporting**	28"	3 ¹ / ₈ "	NO
HSPM or H18 or H33	Under Worksurface mobile	28"	3 ¹ / ₈ "	NO

** Units will support conventional 29¹/₂"H worksurfaces, WITHOUT SPACERS.

LATERAL FILING OPTIONS

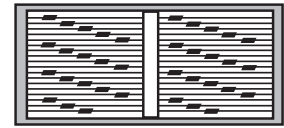

Front-to-back filing:

30" wide files*: 30¹/₂" of filing with letter/letter rows.

36" wide files*: 30¹/₂" of filing with letter/letter, legal/legal, or letter/legal rows.

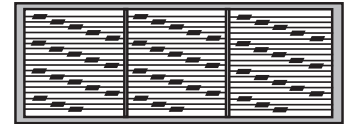

42" wide files**: 45³/₄" of filing with 3 rows letter or 30¹/₂" of 2 rows legal, or 2 standard printout rows.

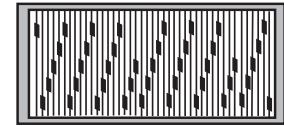

Side-to-side filing:

30" wide files: 27" of filing with letter or legal.

36" wide files: 33" of filing with letter or legal.

42" wide files: 39" of filing with letter or legal.

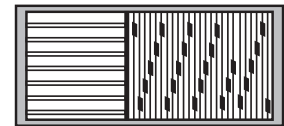

Combination filing:

(front-to-back with side-to-side in one drawer)

30" wide files: not recommended.

36" wide files: 15¹/₄" of front-to-back filing and 20¹/₄" of side-to-side legal filing.

42" wide files: 15¹/₄" of front-to-back filing and 26¹/₄" of side-to-side legal filing.

* Requires H919491 optional hangrails.

** Requires H919492 optional hangrails.

HON LATERAL FILES AT A GLANCE

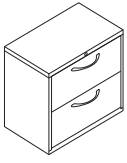

Flagship®

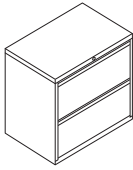

**Brigade®
Model H872L**

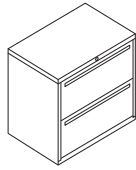

**Brigade®
Model H772L**

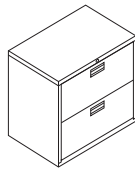

**Brigade®
Model H672L**



400 Series

Flagship Series lateral files are 18"D.

Brigade® 800 and 700 Series lateral files are all 18"D.

STORAGE

Series	Widths Available	Heights Available	Suspension Style	Usage	Pull	Safety Interlock	Lock	Features
Flagship, Brigade® 800, 700, 600	30" 36" 42"	2 dwr 3 dwr 4 dwr 5 dwr	Heavy-Duty ball-bearing (telescoping)	Intensive	Flagship Series 3 Pulls available. See page 570. Brigade® 800 Series Full-width radius designer style Brigade® 700 Series Full-width designer style Brigade® 600 Series Anodized Aluminum	Positive Mechanical	Core removable	<ul style="list-style-type: none"> • 4 leveling glides • 2 hangrails per drawer • Rack resistant case reinforcement • Flagship® and Brigade® can be used with Storage Islands
400	30" 36"	2 dwr 4 dwr	Ball-bearing	Moderate	Color-matched polymer Monochromatic drawer pulls	Positive Mechanical	Core removable	<ul style="list-style-type: none"> • 2 leveling glides

All products meet or exceed ANSI/BIFMA and ISTA performance standards.

HON VERTICAL FILES AT A GLANCE

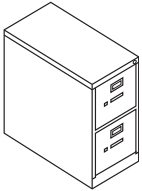

Model H212

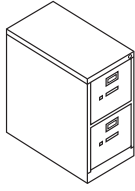

Model H312



Model H512

Vertical files listed below meet or exceed ANSI/BIFMA and ISTA performance standards. They are available in 15"W letter and 18¼"W legal widths.

Series	Depth	Heights Available	Suspension Style	Lock	Accepts Hanging Files	Features
210 Series	28½"	2 dwr 4 dwr 5 dwr	Three-part telescoping, ball-bearing steel suspension	INCLUDED core removable	YES (Hangrails not required)	Follower Block standard
310 Series	26½"	2 dwr 4 dwr 5 dwr	Three-part telescoping, ball-bearing steel suspension	INCLUDED core removable	YES (Hangrails not required)	Follower Block standard
510 Series	25"	2 dwr 4 dwr	Three-part telescoping, ball-bearing steel suspension	INCLUDED core removable	YES (Hangrails not required)	Adjustable wire follower

STORAGE AND FILES ORDERING INFORMATION

CONTAIN® PRODUCT

L1 LAMINATES CODES

Woodgrain

- ◆ Bourbon Cherry H
- ◆ Cognac COGN
- ◆ Field Elm LWFE
- ◆ Florence Walnut LFW1
- ◆ Harvest C
- ◆ Kingswood Walnut LK11
- ◆ Mahogany N
- ◆ Mocha MOCH
- ◆ Natural Maple D
- ◆ Pinnacle PINC
- ◆ Shaker Cherry F
- ◆ Sterling Ash LSA1

L2 LAMINATES CODES

Woodgrain

- ◆ Beigewood LWBE
- ◆ Fawn Cypress LFC1
- ◆ Lowell Ash LLA1
- ◆ Natural Recon LNRI
- ◆ Phantom Ecru LPE1
- ◆ Portico Teak LPT1
- ◆ Skyline Walnut LSW1

OPTIONAL LAMINATE TOPS FOR LATERAL FILES AND CONTAIN® CREDENZAS

L1 LAMINATES CODES

Woodgrain

- ◆ Bourbon Cherry H
- ◆ Cognac COGN
- ◆ Field Elm LWFE
- ◆ Florence Walnut LFW1
- ◆ Harvest C
- ◆ Kingswood Walnut LK11
- ◆ Mahogany N
- ◆ Mocha MOCH
- ◆ Natural Maple D
- ◆ Pinnacle PINC
- ◆ Shaker Cherry F
- ◆ Sterling Ash LSA1

Solid

- ◆ Charcoal S
- ◆ Designer White LDW1
- ◆ Loft LOFT

Patterned

- ◆ Handspun Chestnut LAHC
- ◆ Handspun Dove LAHD
- ◆ Handspun Pearl LAHP
- ◆ Handspun Slate LAHS
- ◆ Silver Mesh* B9
- ◆ Gray* G2
- ◆ White* G1

L2 LAMINATES CODES

Woodgrain

- ◆ Beigewood LWBE
- ◆ Fawn Cypress LFC1
- ◆ Lowell Ash LLA1
- ◆ Natural Recon LNRI
- ◆ Phantom Ecru LPE1
- ◆ Portico Teak LPT1
- ◆ Skyline Walnut LSW1

OPTIONAL LAMINATE TOPS FOR STEEL BOOKCASES

L1 LAMINATES CODES

Woodgrain

- ◆ Bourbon Cherry H
- ◆ Field Elm LWFE
- ◆ Florence Walnut LFW1
- ◆ Harvest C
- ◆ Kingswood Walnut LK11
- ◆ Mahogany N
- ◆ Natural Maple D
- ◆ Shaker Cherry F
- ◆ Sterling Ash LSA1

Solid

- ◆ Charcoal S
- ◆ Designer White LDW1

Patterned

- ◆ Handspun Chestnut LAHC
- ◆ Handspun Dove LAHD
- ◆ Handspun Pearl LAHP
- ◆ Handspun Slate LAHS
- ◆ Silver Mesh* B9
- ◆ Steel Mesh* A9
- ◆ Gray* G2
- ◆ White* G1

1870 SERIES BOOKCASES

L1 LAMINATES CODES

Woodgrain

- ◆ Cognac COGN
- ◆ Harvest C
- ◆ Mahogany N

FLAGSHIP®, CONTAIN® PRODUCT, BRIGADE PEDESTALS, BRIGADE 800, 700, 600 LATERAL FILES, 210, 310, AND 510 SERIES VERTICAL FILES, BRIGADE STORAGE CABINETS, BRIGADE STEEL BOOKCASES

PAINTS CODES

P1

- ◆ Black P
- ◆ Brownstone P7D
- ◆ Charcoal S
- ◆ Designer White PJW
- ◆ Fossil P28
- ◆ Greige T5
- ◆ Light Gray Q
- ◆ Loft LOFT
- ◆ Muslin T3
- ◆ Putty L
- ◆ Titanium P8T

P2

- ◆ Champagne Metallic T4
- ◆ Gunmetal Metallic PR3
- ◆ Platinum Metallic T1
- ◆ Silver** PR6
- ◆ Solar Black** P8X

400 SERIES LATERAL

PAINTS CODES

P1

- ◆ Black P
- ◆ Light Gray Q
- ◆ Loft LOFT
- ◆ Putty L

FLAMESAFE™

PAINTS CODES

P1

- ◆ Black P
- ◆ Light Gray Q
- ◆ Putty L

PULL OPTIONS FOR CONTAIN® AND FLAGSHIP® STORAGE

Suffix "A"



Satin Chrome Arch Pull

Suffix "N"



Full Face Integral Drawer Pull

Suffix "R"



Full Radius Drawer Pull

NOTES: Arch pulls available in Satin Chrome only.

* Laminate colors will have the following pre-set edgeband colors:

** Only available on Flagship® Pedestals and Contain®.

Laminate	Edge
Handspun Chestnut	Loft
Handspun Dove	Loft
Handspun Pearl	Loft
Handspun Slate	Charcoal
Silver Mesh	Loft
Steel Mesh	Charcoal
Gray	Charcoal
White	Charcoal

Edgeband matches top except as noted.

For Champagne Metallic Paint, Muslin is the suggested edgeband color. When Champagne Metallic Paint is selected, pulls are standard in Muslin.

- The HON Company has elected to discontinue the HON Choice paint program, as of 12/31/2018, and roll it into our standard specials process.
- A special request will need to be submitted to receive pricing and order information.

◆◆◆ For lead time information see page 21.



Brigade® Storage.

STORAGE

BRIGADE®

You don't need an army to bring order to your office. Just a brigade. Sturdily built to rigorous specifications, our Brigade storage is ready to serve any organization needing top-quality storage. With welded construction and features like heavy-duty steel ball-bearing suspensions, it outlasts and outperforms most build-it-yourself options. Brigade was built to soldier on.



FEATURES

- Clean, straightforward design complements and blends in with any workspace.
- Optional Storage Islands laminate tops provide extra surface area for technology tools, collating or stand-up work.
- With a combination of reasonable pricing and high quality, Brigade is a value that's hard to beat.
- Heavy-duty Steel ball-bearing drawer suspensions operate easily and quietly.
- Mechanical interlock prevents more than one drawer from being opened at a time, for stability.

BRIGADE® ORDERING INFORMATION

BRIGADE PRODUCTS

PAINTS CODES

P1	
◆ Black	P
◆ Brownstone	P7D
◆ Charcoal	S
◆ Designer White	PJW
◆ Fossil	P28
◆ Greige	T5
◆ Light Gray	Q
◆ Loft	LOFT
◆ Muslin	T3
◆ Putty	L
◆ Titanium	P8T
P2	
◆ Champagne Metallic	T4
◆ Gunmetal Metallic	PR3
◆ Platinum Metallic	T1

OPTIONAL LAMINATE TOPS FOR LATERAL FILES AND CONTAIN® CRENZAS

L1 LAMINATES CODES

Woodgrain	
◆ Bourbon Cherry	H
◆ Cognac	COGN
◆ Field Elm	LWFE
◆ Florence Walnut	LFW1
◆ Harvest	C
◆ Kingswood Walnut	LK11
◆ Mahogany	N
◆ Mocha	MOCH
◆ Natural Maple	D
◆ Pinnacle	PINC
◆ Shaker Cherry	F
◆ Sterling Ash	LSA1

Solid

◆ Charcoal	S
◆ Designer White	LDW1
◆ Loft	LOFT

Patterned

◆ Handspun Chestnut	LAHC
◆ Handspun Dove	LAHD
◆ Handspun Pearl	LAHP
◆ Handspun Slate	LAHS
◆ Silver Mesh*	B9
◆ Steel Mesh*	A9
◆ Gray*	G2
◆ White*	G1

L2 LAMINATES CODES

Woodgrain	
◆ Beigewood	LWBE
◆ Fawn Cypress	LFC1
◆ Lowell Ash	LLA1
◆ Natural Recon	LNRI
◆ Phantom Ecrú	LPE1
◆ Portico Teak	LPT1
◆ Skyline Walnut	LSW1

For Champagne Metallic Paint, Muslin is the suggested edgeband color.

- The HON Company has elected to discontinue the HON Choice paint program, as of 12/31/2018, and roll it into our standard specials process.
- A special request will need to be submitted to receive pricing and order information.

* Laminate colors will have the following pre-set edgeband colors:

Laminate	Edge
Handspun Chestnut	Loft
Handspun Dove	Loft
Handspun Pearl	Loft
Handspun Slate	Charcoal
Silver Mesh	Loft
Steel Mesh	Charcoal
Gray	Charcoal
White	Charcoal

Edgeband matches top except as noted.

◆◆◆ For lead time information see page 21.



Icon Legend on page 19

BRIGADE® Standard Height Pedestals

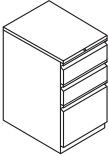
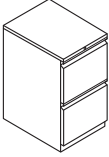
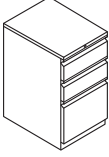
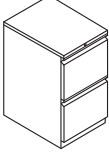
	DESCRIPTION	MODEL	SHIP WEIGHT	CUBE	LIST PRICE BY PAINT GRADE		
					P1	P2	P3
	Standard Height Mobile Pedestals — Box/Box/File						
	15"W x 19 ⁷ / ₈ "D x 28"H 15"W x 22 ⁷ / ₈ "D x 28"H	H33720(?) H33723(?) ☹	73 77	6.6 7.5	\$810 \$834	\$840 \$864	\$869 \$893
	Standard Height Mobile Pedestals — File/File						
	15"W x 19 ⁷ / ₈ "D x 28"H 15"W x 22 ⁷ / ₈ "D x 28"H	H33820(?) H33823(?) ☹	73 77	6.6 7.5	\$810 \$834	\$840 \$864	\$869 \$893
	Standard Height Freestanding Support Pedestals — Box/Box/File						
	15"W x 19 ⁷ / ₈ "D x 28"H 15"W x 22 ⁷ / ₈ "D x 28"H	H36720(?) H36723(?)	61 83	6.6 7.5	\$794 \$823	\$824 \$853	\$853 \$882
	Standard Height Freestanding Support Pedestals — File/File						
	15"W x 19 ⁷ / ₈ "D x 28"H 15"W x 22 ⁷ / ₈ "D x 28"H	H36820(?) H36823(?)	61 83	6.6 7.5	\$794 \$823	\$824 \$853	\$853 \$882

STORAGE

NOTES:

- 28"H fits under all HON worksurfaces and desk shells.
 - Pencil tray standard in top box drawer.
 - One box divider standard in each box drawer.
 - One crossrail standard in each file drawer.
 - Ball-bearing suspension on file and box drawers with 90% extension.
 - File drawers have high sides for filing front-to-back.
 - See pages 670-671 for accessories and pedestal utilization information.
 - Equipped with HON "One Key" interchangeable core removable locks.
 - Front casters are fixed, rear casters swivel on mobile pedestals.
 - "N" Pull matches Brigade 700 Series lateral file pull.
 - "R" pull matches Brigade 800 Series Lateral Pull.
 - See pages 670-671 for Pedestal Accessories. Additional Flagship pedestal models on pages 627-628.
- ☹ Freestanding support pedestals that are not positioned and attached under a worksurface, require a counterweight kit found on page 670.

HOW TO SPECIFY

<p>Select Model Number</p> <p>Select the Pull</p> <p>N Full Face Integral R Full Radius</p> <p>H 3 3 7 2 0 R</p>	<p>Select Lock Option</p> <p>L Lock</p> <p>L</p>	<p>Select Paint Color</p> <p>See page 572</p> <p>P</p>
---	--	--

BRIGADE® 800 SERIES

Lateral Files w/Drawers

GSA SIN 33721



Icon Legend on page 19

STORAGE



DESCRIPTION

Lateral File — 2 Drawer

30"W x 18"D x 28"H
36"W x 18"D x 28"H
42"W x 18"D x 28"H

MODEL

SHIP WEIGHT

CUBE

LIST PRICE BY PAINT GRADE

P1

P2

P3

H872	121	12.2	\$1127	\$1162	\$1198
H882	131	14.3	\$1258	\$1293	\$1329
H892	141	16.7	\$1454	\$1489	\$1525



Lateral File — 3 Drawer

30"W x 18"D x 39½"H
36"W x 18"D x 39½"H
42"W x 18"D x 39½"H

H873	158	16.4	\$1599	\$1634	\$1670
H883	175	19.1	\$1782	\$1817	\$1853
H893	190	22.4	\$2066	\$2101	\$2137

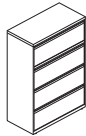

Lateral File — 4 Drawer

30"W x 18"D x 52½"H
36"W x 18"D x 52½"H
42"W x 18"D x 52½"H

H874	197	21.4	\$1936	\$2007	\$2075
H884	217	25.1	\$2196	\$2267	\$2335
H894	232	29.4	\$2521	\$2592	\$2660

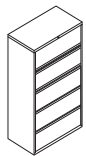

Lateral File — 5 Drawer

30"W x 18"D x 64¼"H
36"W x 18"D x 64¼"H
42"W x 18"D x 64¼"H

H875	199	25.8	\$2571	\$2642	\$2710
H885	215	30.1	\$2895	\$2966	\$3034
H895	244	35.3	\$3342	\$3413	\$3481

NOTES:

- 30", 36" & 42" case widths with drawers, 18" case depth.
- Flush top and sides.
- Reinforced case construction.
- Four adjustable leveling glides.
- Full-width radius designer style pull.
- Features drawer extension restraint; mechanical interlock inhibits the extension of more than one drawer at a time.
- Three-part, telescoping, steel ball-bearing suspension.
- Two adjustable hangrails per drawer for side-to-side filing.
- Counterweight included where applicable to meet ANSI/BIFMA stability requirements.
- Lock mechanism secures both sides of drawer.
- Baked enamel finish over rust-inhibiting phosphate pre-treatment.
- Equipped with HON "One Key" interchangeable core removable locks.
- Optional laminate tops and accessories — see page 667.
- See page 667 for Lateral File Accessories.

! Keyed alike cores must be ordered separately — see page 699.

HOW TO SPECIFY

Select Model Number <input type="text" value="H872"/>	Select Lock Option <input type="text" value="L"/>	Select Paint Color <input type="text" value="T1"/>
---	---	--



Icon Legend on page 19

BRIGADE® 800 SERIES Lateral Files w/Storage

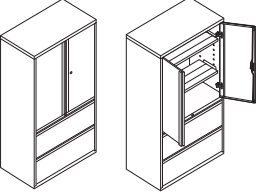
	DESCRIPTION	MODEL	SHIP WEIGHT	CUBE	LIST PRICE BY PAINT GRADE		
					P1	P2	P3
	Lateral File w/Storage — 2 Drawer						
	30"W x 18"D x 64¼"H	H875LS	174	27.5	\$2065	\$2136	\$2204
	36"W x 18"D x 64¼"H	H885LS	210	32.9	\$2274	\$2345	\$2413
	42"W x 18"D x 64¼"H	H895LS	228	38.0	\$2600	\$2671	\$2739

NOTES:

- 30", 36" & 42" case widths, 18" case depth.
- 46¼"H case - matches height of 800 Series 5 Drawer laterals.
- Bottom two openings are lateral drawers, remainder of case is storage shelves.
- Lateral file drawer features are same as 800 Series Laterals shown on previous page.
- Inside dimension of storage case is 36¼"H. Includes 2 adjustable shelves, adjustable in 2" increments. Bottom shelves accept two rows of 3-ring binders; top opening measures: 10¼".
- Storage case is standard with 2 hinged doors. Door pulls match lateral file drawer pulls.
- Equipped with HON "One Key" interchangeable core removable locks. Locks on storage case and lateral file are keyed alike. Lateral file drawers lock independently from storage case.
- Four adjustable leveling glides.
- See page 667 for Lateral File Accessories and page 579 for Wire Dividers.

STORAGE

HOW TO SPECIFY

<p>Select Model Number</p> <p>H 8 7 5 L S .</p>	<p>Select Lock Option</p> <p>L Lock</p> <p>L .</p>	<p>Select Paint Color</p> <p>See page 572</p> <p>T 1</p>
--	---	---

BRIGADE® 700 SERIES

Lateral Files w/Drawers

GSA SIN 33721



Icon Legend on page 19

STORAGE

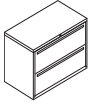
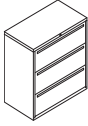
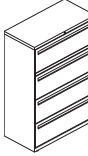
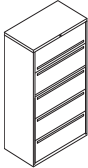
	DESCRIPTION	MODEL	SHIP WEIGHT	CUBE	LIST PRICE BY PAINT GRADE		
					P1	P2	P3
	Lateral File — 2 Drawer (locking)						
	30"W x 18"D x 28"H	H772	121	12.2	\$1127	\$1162	\$1198
	36"W x 18"D x 28"H	H782	131	14.3	\$1258	\$1293	\$1329
	42"W x 18"D x 28"H	H792	141	16.7	\$1454	\$1489	\$1525
	Lateral File — 3 Drawer (locking)						
	30"W x 18"D x 39 ¹ / ₈ "H	H773	158	16.4	\$1599	\$1634	\$1670
	36"W x 18"D x 39 ¹ / ₈ "H	H783	175	19.1	\$1782	\$1853	\$1921
	42"W x 18"D x 39 ¹ / ₈ "H	H793	190	22.4	\$2066	\$2101	\$2137
	Lateral File — 4 Drawer (locking)						
	30"W x 18"D x 52 ¹ / ₂ "H	H774	197	21.4	\$1936	\$2007	\$2075
	36"W x 18"D x 52 ¹ / ₂ "H	H784	217	25.1	\$2196	\$2267	\$2335
	42"W x 18"D x 52 ¹ / ₂ "H	H794	232	29.4	\$2521	\$2592	\$2660
	Lateral File — 5 Drawer (locking)						
	30"W x 18"D x 64 ¹ / ₄ "H	H775	199	25.8	\$2571	\$2642	\$2710
	36"W x 18"D x 64 ¹ / ₄ "H	H785	215	30.1	\$2895	\$2966	\$3034
	42"W x 18"D x 64 ¹ / ₄ "H	H795	244	35.3	\$3342	\$3413	\$3481

NOTES: Top drawer is a roll-out shelf.

NOTES:

- 30", 36" & 42" case widths with drawers, 18" case depth.
- Flush top and sides.
- Reinforced case construction.
- Four adjustable leveling glides.
- Full-face integral drawer pulls.
- Features drawer extension restraint; mechanical interlock inhibits the extension of more than one drawer at a time.
- Three-part, telescoping, steel ball-bearing suspension.
- Two adjustable hangrails per drawer/rollout shelf for side-to-side filing.
- Counterweight included where applicable to meet ANSI/BIFMA stability requirements.
- Lock mechanism secures both sides of drawer.
- Baked enamel finish over rust-inhibiting phosphate pre-treatment.
- Optional laminate tops and accessories — see page 667.
- Equipped with HON "One Key" interchangeable core removable locks.
- See page 667 for Lateral File Accessories.

! Keyed alike cores must be ordered separately — see page 699.

HOW TO SPECIFY

<p>Select Model Number</p> <p>H 7 7 2 .</p>	<p>Select Lock Option</p> <p>L Lock</p> <p>L .</p>	<p>Select Paint Color</p> <p>See page 572</p> <p>T 1</p>
--	---	---



Icon Legend on page 19

BRIGADE® 700 SERIES Lateral Files w/Storage

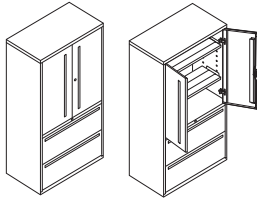

DESCRIPTION

Lateral File w/Storage — 2 Drawer
 30"W x 18"D x 64¼"H
 36"W x 18"D x 64¼"H
 42"W x 18"D x 64¼"H

MODEL	SHIP WEIGHT	CUBE	LIST PRICE BY PAINT GRADE		
			P1	P2	P3
H775LS	175	27.5	\$2065	\$2136	\$2204
H785LS	211	32.9	\$2274	\$2345	\$2413
H795LS	230	38.0	\$2600	\$2671	\$2739

NOTES:

- 30", 36" & 42" case widths, 18" case depth.
- 64¼"H case - matches height of 700 Series 5 Drawer laterals.
- Bottom two openings are lateral drawers, remainder of case is storage shelves.
- Lateral file drawer features are same as 700 Series Laterals shown on previous page.
- Inside dimension of storage case is 36¼"H. Includes 2 adjustable shelves, adjustable in 2" increments. Bottom shelves accept two rows of 3-ring binders; top opening measures: 10¼".
- Storage case is standard with 2 hinged doors. Door pulls match lateral file drawer pulls.
- Equipped with HON "One Key" interchangeable core removable locks. Locks on storage case and lateral file are keyed alike. Lateral file drawers lock independently from storage case.
- Four adjustable leveling glides.
- See page 667 for Lateral File Accessories and page 579 for Wire Dividers.

STORAGE

HOW TO SPECIFY

<p>Select Model Number</p> <p>H 7 7 5 L S .</p>	<p>Select Lock Option</p> <p>L Lock</p> <p>L .</p>	<p>Select Paint Color</p> <p>See page 572</p> <p>T 1</p>
--	---	---

BRIGADE® 600 SERIES Lateral Files w/Drawers

GSA SIN 33721



Icon Legend on page 19

STORAGE

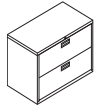

DESCRIPTION

Lateral File — 2 Drawer

30"W x 18"D x 28"H
36"W x 18"D x 28"H
42"W x 18"D x 28"H

MODEL

SHIP WEIGHT

CUBE

LIST PRICE BY PAINT GRADE

P1

P2

P3

H672	121	12.2	\$1039	\$1110	\$1178
H682	131	14.3	\$1119	\$1154	\$1190
H692	141	16.7	\$1318	\$1353	\$1389

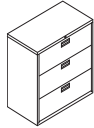

Lateral File — 3 Drawer

30"W x 18"D x 39¹/₈"H
36"W x 18"D x 39¹/₈"H
42"W x 18"D x 39¹/₈"H

H673	158	16.4	\$1425	\$1496	\$1564
H683	175	19.1	\$1560	\$1595	\$1631
H693	190	22.4	\$1831	\$1866	\$1902



Lateral File — 4 Drawer

30"W x 18"D x 52¹/₂"H
36"W x 18"D x 52¹/₂"H
42"W x 18"D x 52¹/₂"H

H674	197	21.4	\$1771	\$1842	\$1910
H684	217	25.1	\$1935	\$2006	\$2074
H694	232	29.4	\$2294	\$2365	\$2433

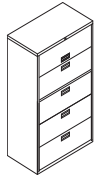

Lateral File — 5 Drawer

30"W x 18"D x 64¹/₄"H
36"W x 18"D x 64¹/₄"H
42"W x 18"D x 64¹/₄"H

H675	199	25.8	\$2352	\$2423	\$2491
H685	215	30.1	\$2513	\$2584	\$2652
H695	244	35.3	\$3031	\$3102	\$3170

NOTES:

- 30", 36" & 42" case widths with drawers, 18" case depth.
- Flush top and sides.
- Reinforced case construction.
- Four adjustable leveling glides.
- Features drawer extension restraint; mechanical interlock inhibits the extension of more than one drawer at a time.
- Three-part, telescoping, steel ball-bearing suspension.
- Two adjustable hangrails per drawer/roll-out shelf for side-to-side filing.
- Counterweight included where applicable to meet ANSI/BIFMA stability requirements.
- Lock mechanism secures both sides of drawer.
- Baked enamel finish over rust-inhibiting phosphate pre-treatment.
- Bright anodized aluminum recessed drawer pull.
- Equipped with HON "One Key" interchangeable core removable locks.
- Optional laminate tops and accessories — see page 667.
- See page 667 for Lateral File Accessories.

Keyed alike cores must be ordered separately — see page 699.

HOW TO SPECIFY

<p>Select Model Number</p> <p>H 6 7 2 .</p>	<p>Select Lock Option</p> <p>L Lock</p> <p>L .</p>	<p>Select Paint Color</p> <p>See page 572</p> <p>T 1</p>
---	--	--

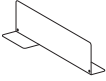
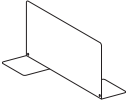

BRIGADE[®] Metal Dividers

	DESCRIPTION	MODEL	SHIP WEIGHT	CUBE	LIST PRICE P1
	Metal Box Divider				
	10 pack	HSCABD10	7	0.7	\$227
	2 pack	HSCABD02	2	0.7	\$59
	ⓘ Metal dividers available in Black only. No need to specify.				
	Metal File Divider				
	10 pack	HSCAFD10	12	0.7	\$270
	2 pack	HSCAFD02	3	0.7	\$73
	ⓘ Metal dividers available in Black only. No need to specify.				

STORAGE

HOW TO SPECIFY

Select
Model Number

H S C A B D 1 0

BRIGADE® Steel Bookcases

GSA SIN 33721



Icon Legend on page 19

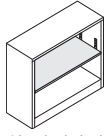

Shaded shelves
are adjustable.

DESCRIPTION

Steel Bookcase

34½"W x 12⅝"D x 29"H, 2-Shelf
34½"W x 12⅝"D x 41"H, 3-Shelf
34½"W x 12⅝"D x 59"H, 4-Shelf
34½"W x 12⅝"D x 71"H, 5-Shelf
34½"W x 12⅝"D x 81⅝"H, 6-Shelf

MODEL	SHIP WEIGHT	CUBE	LIST PRICE BY PAINT GRADE		
			P1	P2	P3
HS30ABC	44	9.6	\$367	\$402	\$438
HS42ABC	57	13.3	\$439	\$474	\$510
HS60ABC	77	18.9	\$655	\$726	\$794
HS72ABC	87	22.6	\$746	\$817	\$885
HS82ABC	97	27.5	\$1078	\$1149	\$1217

Extra Shelf for all Models

NOTES: Edge is ¾" thick. Specify: Paint

HB9	7 Ⓞ	0.3	\$126	\$140	\$151
------------	-----	-----	--------------	--------------	--------------

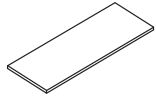

STORAGE

NOTES:

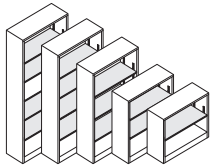

- Available in 2, 3, 4, 5, and 6 shelf models.
- Inside shelf depth is 12⅝".
- Bookcase shelves easily adjust in ½" increments (shaded shelves are adjustable).
- Optional laminate tops available.
- Baked enamel finish over rust-inhibiting phosphate pre-treatment.

HOW TO SPECIFY

Select Model Number

HS30ABC .

Select Paint Color

See page 572

P

DESCRIPTION

Laminate Top for all Models

NOTES: Specify: Laminate

MODEL **SHIP WEIGHT** **CUBE** **LIST PRICE**

H511596 16 Ⓞ 0.7 **\$371**

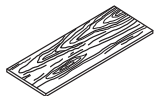

HOW TO SPECIFY

Select Model Number

H511596 .

Select Laminate

See page 572

N



Icon Legend on page 19

BRIGADE® Storage Cabinets

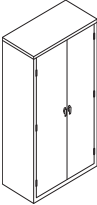
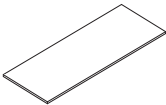
	DESCRIPTION	MODEL	SHIP WEIGHT	CUBE	LIST PRICE BY PAINT GRADE		
					P1	P2	P3
 71 3/4" High	Storage Cabinets 36"W x 18 1/8"D x 72"H 36"W x 24 1/8"D x 72"H NOTES: Includes 5 adjustable shelves.	HSC1872 HSC2472	131 149	36.5 46.7	\$1439 \$1804	\$1510 \$1875	\$1578 \$1943
	Storage Cabinet 36"W x 18 1/8"D x 41 1/4"H NOTES: Includes 2 adjustable shelves.	HSC1842	82	21.8	\$1217	\$1265	\$1311
	Additional Shelves 36"W x 18"D 36"W x 24"D	HAS18 HAS24	6 8	0.6 0.7	\$174 \$215	\$188 \$229	\$199 \$240
	Conversion Kit Hanging Bar and brackets to convert a Storage Cabinet into a Wardrobe Cabinet. NOTES: Necessary hardware included to screw into shelf. ! For use on 72"H HSC Model Storage Cabinets shown above, only. ! Aluminum finish only. No need to specify paint color. SPECIFY: HWC72	HWC72	5	0.4	\$160		

STORAGE

NOTES:

- Product shipped fully assembled.
- All shelves are adjustable in 2" increments.
- Stretch-wrap cartoning.
- Flush top.
- Two adjustable leveling glides standard.
- Reinforced base.
- One locking handle, one fixed handle.
- Adjustable shelves.
- Doors have vertical stiffener standard.
- Positive door stops.
- Equipped with HON "One Key" interchangeable core removable locks.
- ! Keyed alike cores must be ordered separately – see page 699.

HOW TO SPECIFY

Select Model Number H S C 2 4 7 2	Select Lock Option L	Select Paint Color P
---	--------------------------------	--------------------------------



Contain Storage.

CONTAIN

Harder-working storage. That's what you need. So we re-examined it from the inside out and developed our new Contain storage solutions. With a variety of shapes and sizes, functions and configurations, Contain can help you expand your capabilities for storage, efficiency, and collaboration — and elevate your aesthetic too.



FEATURES

- Contain provides the storage solutions you need, where you need them. Personal workstations, private offices, shared spaces, Contain has you covered.
- Combine metal and laminate to create a unique and unified look for your office.
- Add a pop of color with HON standard or Colorway™ options — available in single or dual paint.
- Maximize your footprint with integrated height adjustable credenzas.
- Choose between a footed base to create a stand-alone furniture aesthetic, a recessed kickplate that matches both the drawer fronts, or an optional flush kickplate.
- Pair mobile credenzas and pedestals with seat cushions to turn any space into a collaborative hub.
- Leave the key in the past with our three digital locking options.
- Incorporate lockers and wardrobes into Storage Islands to create simple touchdown spaces throughout the office.
- Choose between 5 different pull options to enhance your office design aesthetic.

CONTAIN® ORDERING INFORMATION

STORAGE

CONTAIN® PRODUCTS CASE AND FRONT PAINT AND ACCESSORIES

PAINTS CODES

P1	
◆ Black	P
◆ Brownstone	P7D
◆ Charcoal	S
◆ Cove	P096
◆ Designer White	PJW
◆ Dune	P094
◆ Fossil	P28
◆ Greige	T5
◆ Harbor	P097
◆ Light Gray	Q
◆ Loft	LOFT
◆ Muslin	T3
◆ Putty	L
◆ Sage	P095
◆ Textured Charcoal	P7A
◆ Textured Designer White	PK7
◆ Titanium	P8T
P2	
◆ Champagne Metallic	T4
◆ Gunmetal Metallic	PR3
◆ Platinum Metallic	T1
◆ Silver	PR6
◆ Solar Black	P8X
P3	
◆ Atom	P8S
◆ Bullseye	PJF
◆ Ember	P8P
◆ Ion	P8N
◆ Iris	P8J
◆ Krypton	P8F
◆ Regatta	P8M

CONTAIN® PRODUCTS FRONT LAMINATE AND ACCESSORIES

L1 LAMINATES CODES

Woodgrain	
◆ Bourbon Cherry	H
◆ Cognac	COGN
◆ Field Elm	LWFE
◆ Florence Walnut	LFW1
◆ Harvest	C
◆ Kingswood Walnut	LK11
◆ Mahogany	N
◆ Mocha	MOCH
◆ Natural Maple	D
◆ Pinnacle	PINC
◆ Shaker Cherry	F
◆ Sterling Ash	LSA1

L2 LAMINATES CODES

Woodgrain	
◆ Beigewood	LWBE
◆ Fawn Cypress	LFC1
◆ Lowell Ash	LLA1
◆ Natural Recon	LNRI
◆ Phantom Ecru	LPE1
◆ Portico Teak	LPT1
◆ Skyline Walnut	LSW1

CONTAIN® LATERAL AND CREENZA LAMINATE TOPS

L1 LAMINATES CODES

Woodgrain	
◆ Bourbon Cherry	H
◆ Cognac	COGN
◆ Field Elm	LWFE
◆ Florence Walnut	LFW1
◆ Harvest	C
◆ Kingswood Walnut	LK11
◆ Mahogany	N
◆ Mocha	MOCH
◆ Natural Maple	D
◆ Pinnacle	PINC
◆ Shaker Cherry	F
◆ Sterling Ash	LSA1

Solid

◆ Charcoal	S
◆ Designer White	LDW1
◆ Loft	LOFT

Patterned

◆ Handspun Chestnut	LAHC
◆ Handspun Dove	LAHD
◆ Handspun Pearl	LAHP
◆ Handspun Slate	LAHS
◆ Silver Mesh*	B9
◆ Steel Mesh*	A9
◆ Gray*	G2
◆ White*	G1

L2 LAMINATES CODES

Woodgrain	
◆ Beigewood	LWBE
◆ Fawn Cypress	LFC1
◆ Lowell Ash	LLA1
◆ Natural Recon	LNRI
◆ Phantom Ecru	LPE1
◆ Portico Teak	LPT1
◆ Skyline Walnut	LSW1

CONTAIN® FABRIC WIRE MANAGER — GRADE 1

DAPPER

◆ Ash	DAPR20
◆ Breeze	DAPR06
◆ Canvas	DAPR25
◆ Charcoal	DAPR01
◆ Clover	DAPR22
◆ Currant	DAPR00
◆ Fawn	DAPR35
◆ Fern	DAPR85
◆ Gerbera	DAPR16
◆ Grape	DAPR33
◆ Jewel	DAPR08
◆ Marigold	DAPR65
◆ Onyx	DAPR10
◆ Orchid	DAPR90
◆ Parrot	DAPR59
◆ Poppy	DAPR19
◆ Sapphire	DAPR07
◆ Scarlet	DAPR45
◆ Sepia	DAPR30
◆ Sky	DAPR44
◆ Slate	DAPR15
◆ Sorbet	DAPR55
◆ Spring	DAPR80
◆ Terracotta	DAPR13
◆ Titanium	DAPR17
◆ Varsity	DAPR09
◆ Zest	DAPR70

HAMILTON

◆ Biscotti	HAML11
◆ Cabernet	HAML08
◆ Carolina	HAML21
◆ Charcoal	HAML17
◆ Chocolate	HAML13
◆ Cloud	HAML18
◆ Dane	HAML16
◆ Dusty Rose	HAML07
◆ Esmeralda	HAML06
◆ Fern	HAML04
◆ Fresh	HAML03
◆ Granola	HAML19
◆ Lilac	HAML14
◆ Lime	HAML05
◆ Lipstick	HAML09
◆ Oxford	HAML20
◆ Passion Fruit	HAML02
◆ Pepper	HAML15
◆ Powder	HAML12
◆ Sunrise	HAML01

CONTAIN® FABRIC WIRE MANAGER — GRADE 3

MOXIE

◆ Barnwood	SX09
◆ Basalt	SX23
◆ Bayou	SX02
◆ Bermuda	SX52
◆ Biscotti	SX08
◆ Blackberry	SX48
◆ Blarney	SX49
◆ Blueberry	SX05
◆ Bonsai	SX20
◆ Brigade	SX53
◆ Butterscotch	SX54
◆ Carob	SX24
◆ Chalk	SX50
◆ Chartreuse	SX34
◆ Cherry	SX38
◆ Cinnamon	SX13
◆ Cobalt	SX01
◆ Coconut	SX06
◆ Concrete	SX43
◆ Cozumel	SX55
◆ Cumin	SX32
◆ Dover	SX56
◆ Dragonfly	SX44
◆ Earl Grey	SX40
◆ Elysian	SX04
◆ Evergreen	SX21
◆ Fatigue	SX18
◆ Fawn	SX30
◆ Flint	SX39
◆ Forsythia	SX57
◆ Grenache	SX58
◆ Hazel	SX31
◆ Hemp	SX45
◆ Hickory	SX25
◆ Holly	SX51
◆ Jam	SX16
◆ Kelly	SX33
◆ Lemongrass	SX19
◆ Lime	SX41
◆ Macintosh	SX12
◆ Midnight	SX59
◆ Mulberry	SX15
◆ Muslin	SX60
◆ Pacifica	SX61
◆ Parchment	SX07
◆ Peacock	SX03
◆ Phantom	SX62
◆ Pineapple	SX42
◆ Plum	SX17
◆ Punch	SX46
◆ Riverstone	SX47
◆ Russet	SX14
◆ Smokestack	SX22
◆ Tangerine	SX37
◆ Terracotta	SX11
◆ Thicket	SX35
◆ Walnut	SX10

CONTAIN[®] ORDERING INFORMATION

CONTAIN[®] FABRIC WIRE MANAGER – GRADE 3

PURL	PURL
◆ Alpaca	PURL08
◆ Braid	PURL10
◆ Deep	PURL12
◆ Graze	PURL05
◆ Loom	PURL06
◆ Needle	PURL07
◆ Pasture	PURL02
◆ Ranch	PURL04
◆ Shuttle	PURL09
◆ Skein	PURL01
◆ Thistle	PURL11
◆ Yearling	PURL03

QUILL	QUL
◆ Aviary	QUL03
◆ Feather	QUL02
◆ Fountain	QUL06
◆ Ink	QUL05
◆ Metal	QUL04
◆ Reed	QUL08
◆ Scroll	QUL01

STORAGE

PULL OPTIONS FOR CONTAIN[®] STORAGE

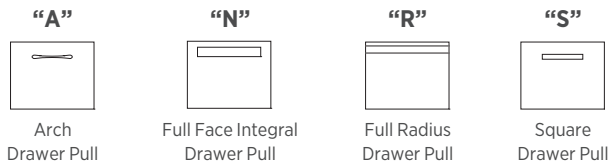

NOTES: Arch Pulls available in Satin Chrome only.

* Laminate colors will have the following pre-set edgeband colors:

Laminate	Edge
Handspun Chestnut	Loft
Handspun Dove	Fossil
Handspun Pearl	Fossil
Handspun Slate	Charcoal
Silver Mesh	Loft
Steel Mesh	Charcoal
Gray	Charcoal
White	Charcoal

Edgeband matches top except as noted.

For Champagne Metallic Paint, Muslin is the suggested edgeband color. When Champagne Metallic Paint is selected, pulls are standard in Muslin.

◆◆◆ For lead time information see page 21.

CONTAIN[®] Towers

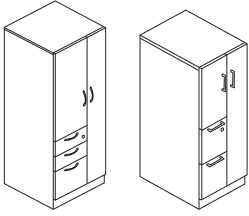

Metal Personal Towers with Plinth Base

65", 50", 42"H
24", 18"W
24"D

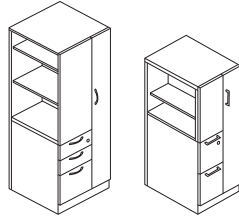

Metal Side-Access Personal Towers with Plinth Base

65", 50", 42"H
24", 18"W
24"D

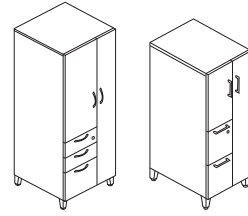

Metal Personal Towers with Footed Base

65", 50", 42"H
24", 18"W
24"D

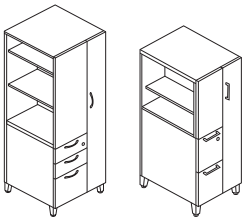

Metal Side-Access Personal Towers with Footed Base

65", 50", 42"H
24", 18"W
24"D

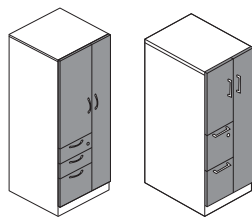

Metal Personal Towers with Laminate Fronts, Plinth Base

65", 50", 42"H
24", 18"W
24"D

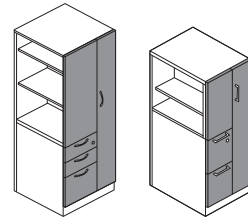

Metal Side-Access Personal Towers with Laminate Fronts, Plinth Base

65", 50", 42"H
24", 18"W
24"D

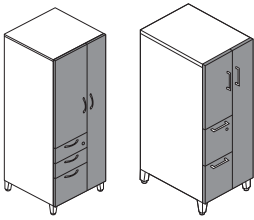

Metal Personal Towers with Laminate Fronts, Footed Base

65", 50", 42"H
24", 18"W
24"D

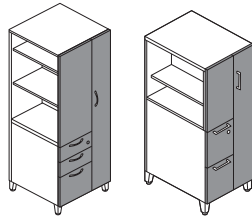

Metal Side-Access Towers with Laminate Fronts, Footed Base

65", 50", 42"H
24", 18"W
24"D

NOTES:

- ❗ 18"W Tower models available in File/File configuration only.
- ❗ 24"W Tower models available in both Box/Box/File and File/File configurations.

CONTAIN[®] Lockers & Wardrobes

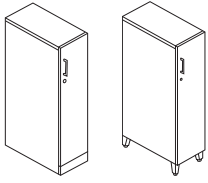

Wardrobe Tower with Metal Front

65", 50", 42"H
12"W
24", 18"D

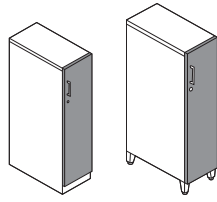

Wardrobe Tower with Laminate Front

65", 50", 42"H
12"W
24", 18"D

NOTES:

- Available with Plinth Base or Footed.
- Doors available hinged left or right.

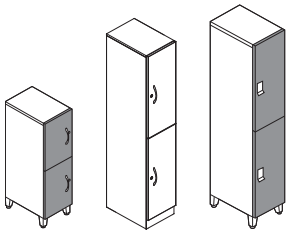

Double Locker, Metal or Laminate Fronts

65"H x 12"W x 18"D, Two Doors
45"H x 12"W x 18"D, Two Doors

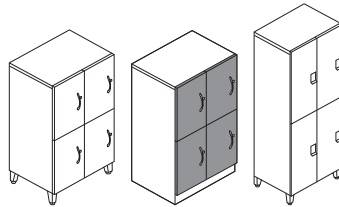

Quad Locker, Metal or Laminate Fronts

65"H x 24"W x 18"D, Four Doors
45"H x 24"W x 18"D, Four Doors

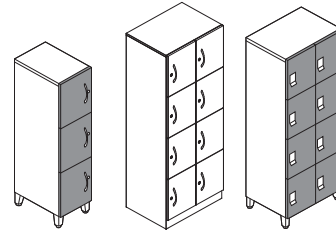

Cubby Locker, Metal or Laminate Fronts

65"H x 12"W x 18"D, Four Doors
50"H x 12"W x 18"D, Three Doors
65"H x 24"W x 18"D, Eight Doors
50"H x 24"W x 18"D, Six Doors

NOTES:

- Available with Flush or Recessed Plinth, or Footed.
- Doors available hinged left or right.
- Electronic Keypad or RFID Lock Pulls available to be specified on all sizes (upcharges apply).

CONTAIN[®] Metal Storage

METAL CREDENZAS WITH PANEL FRAMES

Guidelines for using Contain[®] Credenzas in place of standard panel systems configurations

Side-mounted Credenzas

Use 1 storage-to-panel bracket set.

The minimum credenza size is 22"H x 36"W x 18"D.

With a mid-run floor support, the maximum panel run is 144".

Without a mid-run panel attached floor support, the maximum panel run is 96".

Overheads and shelves cannot be used with 22"H side mounted credenzas.

Worksurfaces (if specified) must be mounted on the same side of the parent run as the credenzas.

Panel frame maximum height is 68".

Counterweight is required, if using unit with drawers.

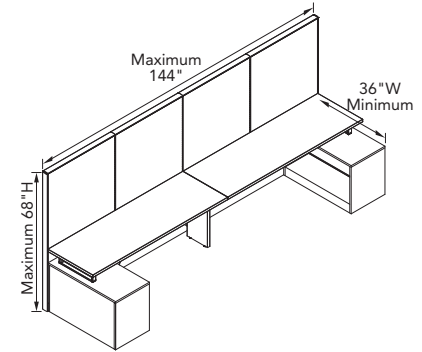

Back-mounted Credenzas — Modular

Use 2 storage-to-panel bracket sets per Credenza — 2 LH and 2 RH.

The minimum credenza size is 22"H x 36"W x 18"D.

The maximum panel run between back-mounted credenzas is 60".

Overheads and shelves cannot be used with 22"H back mounted credenzas.

Worksurfaces (if specified) must be mounted on the same side of the parent run as the credenzas.

Panel frame maximum height is 68".

Counterweights are required in a single side run configuration as shown.

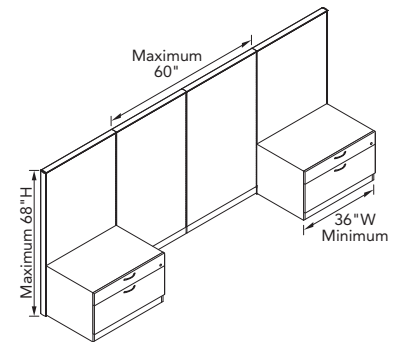

Side-mounted Credenzas — with Return Panel

Use 1 storage-to-panel bracket on Credenza LH or RH of set.

The minimum credenza size is 22"H x 36"W x 18"D.

The minimum size for panel return is 35"H x 36"W.

With a mid-run panel attached floor support, the maximum panel run is 144".

Without a mid-run floor support, the maximum panel run is 96".

Overheads and shelves cannot be used with 22"H side mounted credenzas.

Worksurfaces (if specified) must be mounted on the same side of the parent run as the credenzas.

Panel frame maximum height is 68".

Counterweight is required, if using unit with drawers.

Mid-run floor support options include:

Back-to-Back Credenzas

Panel Attached O-legs

Panel Attached Support Legs

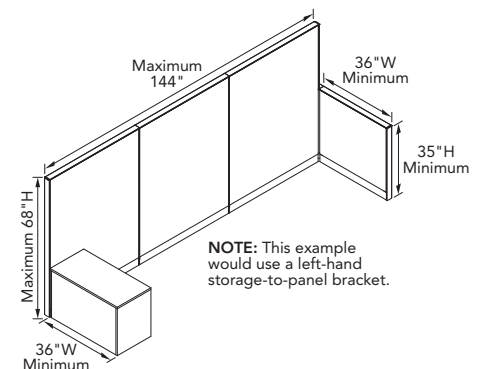

COUNTERWEIGHT REQUIREMENTS FOR CONTAIN[®] CREDENZAS

Series	24"W Box/File Unit	30"W Box/File Unit	36"W Box/File Unit	42"W Combo Unit	48"W Combo Unit	60"W Combo Unit	72"W Combo Unit
18"D	HSCACW35 35 lbs. (two 12½ lb. and two 5 lb. counterweights)	HSCACW50 50 lbs. (four 12½ lb. counterweights)	HSCACW50 50 lbs. (four 12½ lb. counterweights)	HSCACW25 25 lbs. (two 12½ lb. counterweights)	HSCACW25 25 lbs. (two 12½ lb. counterweights)	HSCACW35 35 lbs. (two 12½ lb. and two 5 lb. counterweights)	HSCACW35 35 lbs. (two 12½ lb. and two 5 lb. counterweights)

Counterweight is not required if credenzas are used within a standard Systems set up and attached with the Credenza Storage-to-Panel Brackets.

CONTAIN® DIGITAL LOCK SPECIFICATIONS

Digital Keypad Lock Specification Information for Contain® Pedestals, Credenzas, Personal Files, Lateral Files, and Towers

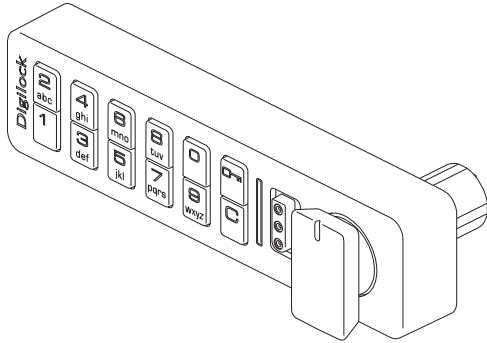

Right-Hand Keypad Lock

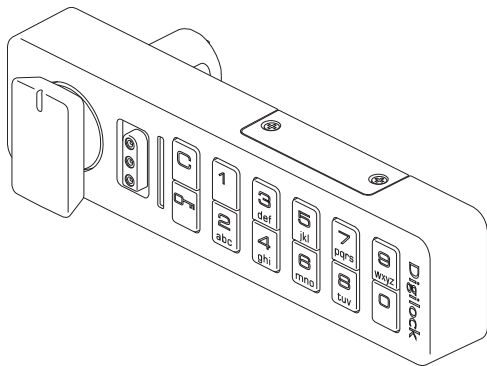

Left-Hand Keypad Lock

The digital keypad lock option helps modernize the workspace by eliminating the need to carry physical keys. The digital lock feature provides an alternative to standard lock and key, allowing users to simply input a code to unlock their Contain® storage unit. The digital keypad also supports shared applications where workstations or storage units support multiple users. These locks ship in “shared mode” by default; shared mode indicates that the lock will “forget” the paired 4-digit code after the lock is opened, allowing the unit to be used by multiple users.

❗ Order at least one Programming Key and Manager Key per install.

Digital Keypad Locks:

- Offered on all Contain® pedestal and undermount models.
- Ship factory installed.
- Offered in a brushed nickel finish.
- Digital keypad lock requires input of a user-selected 4-digit code.
- Digital keypad locks are powered using 2 premium lithium CR2032 batteries.
- Battery life is dependent on the frequency of operation but can last up to 5-7 years.
- **Every digital keypad installation site will require one Programming Key and at least one Manager Key, sold separately.**

Programming Key

- A Programming Key is a device used to initialize locks out of factory default mode and register Manager Keys to the locks.
- Only one Programming Key should be specified per installation site because multiple Programming Keys are not compatible with each other.
- Add-on digital lock orders should be programmed with the original Programming Key.
- Programming Key is the same key as Contain® Digilocks and can work across both Contain® and Fuse™.

Manager Key

- A Manager Key is used to bypass a locked unit; this operates as the “master key” and it is recommended that building facilitators have at least one Manager Key.
- Up to 6 Manager Keys may be registered to each lock.
- Manager Keys provide external power to locks in case of battery failure.

Digital Lock Keys and Accessories		
Description	Model	List Price
Programming Key	HSLDIGPRG	\$218
Manager Key	HSLDIGMGR	\$170

CONTAIN® DIGITAL LOCK SPECIFICATIONS

Digital Keypad & RFID Lock Specification Information for Contain® Lockers

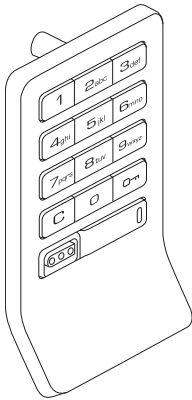

Keypad Lock Pull

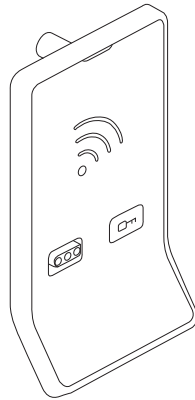

RFID Lock Pull

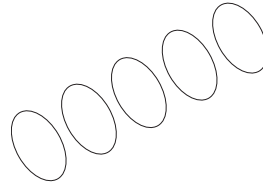

RFID Lock Pull

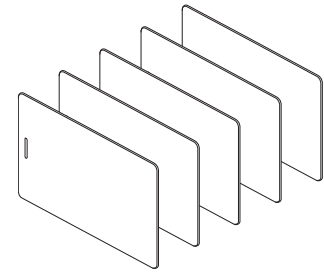

RFID Cards

STORAGE

The digital keypad and RFID lock options support applications where workstations or storage areas are shared by multiple users. This is an alternative to a standard lock and key. This feature facilitates the use of storage by multiple users through eliminating the need to keep and hand-off physical keys. These locks ship in “shared mode” by default; shared mode indicates that the lock will “forget” the paired 4-digit code or RFID badge after the lock is opened, allowing the unit to be used by multiple users.

❗ Order at least one Programming Key and Manager Key per install.

Digital Keypad & RFID Locks:

- Offered on Contain® lockers.
- Ship factory installed.
- Integral Pull/Lock design replaces a specified pull on eLock models.
- Offered in a polished silver finish.
- Digital keypad lock requires input of a user-selected 4-digit code.
- RFID lock requires a compatible RFID card or sticker.
- Digital keypad locks and RFID locks are powered using 4 premium AA batteries.
- Battery life is dependent on the frequency of operation but can last up to 5-7 years.

RFID locks require user to present a compatible RFID card or sticker to the lock in order to gain access. This is the same technology as “badge” systems that allows employers to grant employees with cards that can be scanned to gain access to entrances and buildings. HON locks *may or may not be* compatible with these existing badge systems.

- For existing RFID badge system compatibility, badges must operate on a 13.56 MHz frequency with both iClass (ISO 15693) and Mifare (ISO 14443).
- If existing badge system is not compatible with 13.56 MHz frequency, compatible RFID badges or RFID stickers are sold separately as an accessory model.

Digital Lock Accessory Models (page 618)

- RFID-compatible cards and stickers are sold as accessory models in increments of 5, 25, or 100.
- RFID cards are plain white and have a lanyard cut.
- RFID stickers are plain white, approximately 1” in diameter and may be added to the back of an existing badge or employee identification card.
- **Every digital keypad or RFID installation site will require one Programming Key and at least one Manager Key, sold separately.**

Programming Key

- A Programming Key is a device used to initialize locks out of factory default mode and register Manager Keys to the locks.
- Only one Programming Key should be specified per installation site because multiple Programming Keys are not compatible with each other.
- Add-on digital lock orders should be programmed with the original Programming Key.
- Programming Key is the same key as Fuse™ Digilocks and can work across both Contain® and Fuse™.

Manager Key

- A Manager Key is used to bypass a locked unit; this operates as the “master key” and it is recommended that building facilitators have at least one Manager Key.
- Up to 6 Manager Keys may be registered to each lock.
- Manager Keys provide external power to locks in case of battery failure.

Digital Lock Keys and Accessories		
Description	Model	List Price
Programming Key	HSLDIGPRG	\$218
Manager Key	HSLDIGMGR	\$170
5 pk RFID Cards	HSLRFID5C	\$144
25 pk RFID Cards	HSLRFID25C	\$673
100 pk RFID Cards	HSLRFID100C	\$2548
5 pk RFID Stickers	HSLRFID5S	\$77
25 pk RFID Stickers	HSLRFID25S	\$338
100 pk RFID Stickers	HSLRFID100S	\$1276



Icon Legend on page 19

CONTAIN[®] Metal Credenzas

	DESCRIPTION	MODEL	SHIP WEIGHT	CUBE	LIST PRICE BY CASE PAINT GRADE		
					P1	P2	P3
	Low Credenza, Box/Lateral Left, Open Shelf Right						
	72"W x 18"D x 22"H	HSCP227218RBFOM	150	20.7	\$2577	\$2648	\$2719
	60"W x 18"D x 22"H	HSCP226018RBFOM	130	17.3	\$2325	\$2396	\$2467
	48"W x 18"D x 22"H	HSCP224818RBFOM	111	14.0	\$2145	\$2216	\$2287
	Low Credenza, Box/Lateral Right, Open Shelf Left						
	72"W x 18"D x 22"H	HSCP227218LBFOM	150	20.7	\$2577	\$2648	\$2719
	60"W x 18"D x 22"H	HSCP226018LBFOM	130	17.3	\$2325	\$2396	\$2467
	48"W x 18"D x 22"H	HSCP224818LBFOM	111	14.0	\$2145	\$2216	\$2287
	Low Credenza, Box/Lateral						
	36"W x 18"D x 22"H	HSCP223618BFM	87	10.6	\$1577	\$1612	\$1649
	30"W x 18"D x 22"H	HSCP223018BFM	76	9.0	\$1512	\$1547	\$1584
	Open Shelf						
	36"W x 18"D x 22"H	HSCP223618O	66	10.6	\$1125	\$1160	\$1197
	30"W x 18"D x 22"H	HSCP223018O	60	9.0	\$1036	\$1071	\$1108

STORAGE

NOTES:

- Metal chassis and drawer fronts.
 - Lateral and wide box drawers operate on ball-bearing suspension with full extension.
 - Steel ball-bearing drawer suspensions.
 - Ships complete with standard kickplate.
 - Field installable counterweight sold separately.
 - File drawers accept hanging folders in letter or legal size.
 - Steel frame provides durability.
 - Use with laminate tops and credenza seat cushions. Order separately — see pages 596-597.
- ! Locking units equipped with HON "One Key" interchangeable core removable locks. Keyed alike core model HF23S, in Satin, must be ordered separately. See page 596.

HOW TO SPECIFY

<p>Select Model Number</p> <p>H S C P 2 2 3 6 1 8 O .</p>	<p>Select Base</p> <p>BK Flush Plinth BX Recessed Plinth</p> <p>B X .</p>	<p>Select Case Paint</p> <p>See page 583</p> <p>P J W .</p>	<p>Select Shelf Paint</p> <p>See page 583 P2 upcharge (+ \$16) P3 upcharge (+ \$37)</p> <p>P J W</p>
--	--	--	---

<p>Select Model Number</p> <p>H S C P 2 2 7 2 1 8 R B F O M .</p>	<p>Select Base</p> <p>BK Flush Plinth BX Recessed Plinth</p> <p>B X .</p>	<p>Select Pull</p> <p>A Arch PRO Silver R Radius N Integral S Square PR6 Silver</p> <p>A P R O .</p>	<p>Select Case Paint</p> <p>See page 583</p> <p>P J W .</p>	<p>Select Front Paint</p> <p>See page 583 NA Matches Case (+ \$0) P1 upcharge (+ \$157) P2 upcharge (+ \$178) P3 upcharge (+ \$199)</p> <p>N A .</p>	<p>Select Shelf Paint</p> <p>See page 583 Not specified for models HSCP223018BFM and HSCP223618BFM P2 upcharge (+ \$16) P3 upcharge (+ \$37)</p> <p>P J W .</p>	<p>Select Lock</p> <p>L Standard Lock X Omit Lock (- \$20) EBNL eLock (+ \$340)</p> <p>L</p>
--	--	---	--	---	--	---



CONTAIN[®] Footed Metal Credenzas

GSA SIN 33721

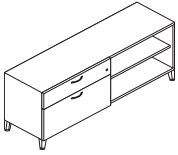
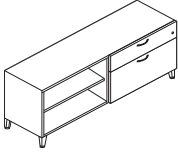

Icon Legend on page 19

STORAGE

	DESCRIPTION	MODEL	SHIP WEIGHT	CUBE	LIST PRICE BY CASE PAINT GRADE		
					P1	P2	P3
	Footed Low Credenza, Box/Lateral Left, Open Shelf Right						
	72"W x 18"D x 22"H	HSCF227218RBFOM	150	17.7	\$2784	\$2855	\$2926
	60"W x 18"D x 22"H	HSCF226018RBFOM	130	14.9	\$2535	\$2606	\$2677
	48"W x 18"D x 22"H	HSCF224818RBFOM	111	12.0	\$2312	\$2383	\$2454
	Footed Low Credenza, Box/Lateral Right, Open Shelf Left						
	72"W x 18"D x 22"H	HSCF227218LBFOM	150	17.7	\$2784	\$2855	\$2926
	60"W x 18"D x 22"H	HSCF226018LBFOM	130	14.9	\$2535	\$2606	\$2677
	48"W x 18"D x 22"H	HSCF224818LBFOM	111	12.0	\$2312	\$2383	\$2454
	Footed Low Credenza, Box/Lateral						
	36"W x 18"D x 22"H	HSCF223618BFM	87	9.1	\$1744	\$1779	\$1816
	30"W x 18"D x 22"H	HSCF223018BFM	76	7.7	\$1678	\$1713	\$1750
	Footed Open Shelf						
	36"W x 18"D x 22"H	HSCF223618O	66	9.1	\$1292	\$1327	\$1364
	30"W x 18"D x 22"H	HSCF223018O	60	7.7	\$1202	\$1237	\$1274

NOTES:

- Lateral and wide box drawers operate on ball-bearing suspension with full extension.
- Steel ball-bearing drawer suspensions.
- Ships complete with standard footed base.
- Field installable counterweight sold separately.
- File drawers accept hanging folders in letter or legal size.
- Steel frame provides durability.
- Feet are shipped with the credenza unit and are easily assembled.
- Use with laminate tops and credenza seat cushions. Order separately — see pages 596-597.

🔒 Locking units equipped with HON "One Key" interchangeable core removable locks. Keyed alike core model HF23S, in Satin, must be ordered separately. See page 596.

HOW TO SPECIFY

Select Model Number	Select Foot	Select Case Paint	Select Shelf Paint
	SF Contain Foot T1 Platinum Metallic PR6 Silver	See page 583	See page 583 P2 upcharge (+ \$16) P3 upcharge (+ \$37)
H S C F 2 2 3 6 1 8 O .	S F T 1 .	P J W .	P J W

Select Model Number	Select Foot	Select Pull	Select Case Paint	Select Front Paint	Select Shelf Paint	Select Lock
	SF Contain Foot T1 Platinum Metallic PR6 Silver	A Arch PRO Silver R Radius N Integral S Square PR6 Silver	See page 583	See page 583 NA Matches Case (+ \$0) P1 upcharge (+ \$157) P2 upcharge (+ \$178) P3 upcharge (+ \$199)	See page 583 Not specified for models HSCF223618BFM and HSCF223018BFM P2 upcharge (+ \$16) P3 upcharge (+ \$37)	L Standard Lock X Omit Lock (- \$20) EBNL eLock (+ \$340)
H S C F 2 2 7 2 1 8 R B F O M .	S F T 1 .	A P R O .	P J W .	N A .	P J W .	L



Icon Legend on page 19

Metal Credenzas with Laminate Fronts

	DESCRIPTION	MODEL	SHIP WEIGHT	CUBE	LIST PRICE BY CASE PAINT GRADE		
					P1	P2	P3
	Metal Low Credenza, Laminated Front, Box/Lateral Left, Open Shelf Right						
	72"W x 18"D x 22"H	HSCP227218RBFOL	152	20.7	\$2858	\$2929	\$3000
	60"W x 18"D x 22"H	HSCP226018RBFOL	132	17.3	\$2608	\$2679	\$2750
	48"W x 18"D x 22"H	HSCP224818RBFOL	113	14.0	\$2425	\$2496	\$2567
	Metal Low Credenza, Laminated Front, Box/Lateral Right, Open Shelf Left						
	72"W x 18"D x 22"H	HSCP227218LBFOL	152	20.7	\$2858	\$2929	\$3000
	60"W x 18"D x 22"H	HSCP226018LBFOL	132	17.3	\$2608	\$2679	\$2750
	48"W x 18"D x 22"H	HSCP224818LBFOL	113	14.0	\$2425	\$2496	\$2567
	Metal Low Credenza, Laminated Front Box/Lateral						
	36"W x 18"D x 22"H	HSCP223618BFL	89	10.6	\$1859	\$1894	\$1931
	30"W x 18"D x 22"H	HSCP223018BFL	76	9.0	\$1792	\$1827	\$1864

STORAGE

NOTES:

- Lateral and wide box drawers operate on ball-bearing suspension with full extension.
- Steel ball-bearing drawer suspensions.
- Ships complete with standard kickplate.
- Field installable counterweight sold separately.
- File drawers accept hanging folders in letter or legal size.
- Steel frame provides durability.
- Use with laminate tops and credenza seat cushions. Order separately — see pages 596-597.

ⓘ Locking units equipped with HON "One Key" interchangeable core removable locks. Keyed alike core model HF23S, in Satin, must be ordered separately. See page 596.

HOW TO SPECIFY

Select Model Number	Select Base	Select Pull	Select Case Paint	Select Front Laminate	Select Shelf Paint	Select Lock
	BX Recessed Plinth	A Arch PRO Silver S Square PR6 Silver	See page 583	See page 583 L2 upcharge (+ \$37)	See page 583 Not specified for models HSCP223618BFL and HSCP223018BFL P2 upcharge (+ \$16) P3 upcharge (+ \$37)	L Standard Lock X Omit Lock (- \$20) EBNL eLock (+ \$340)
H S C P 2 2 7 2 1 8 R B F O L	B X	A P R O	P J W	L S A 1	P J W	L



Icon Legend on page 19

STORAGE

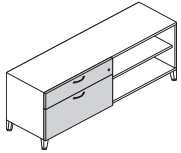

DESCRIPTION	MODEL	SHIP WEIGHT	CUBE	LIST PRICE BY CASE PAINT GRADE		
				P1	P2	P3
Footed Low Credenza, Laminate Front, Box/Lateral Left, Open Shelf Right						
72"W x 18"D x 22"H	HSCF227218RBFOL	152	17.7	\$3068	\$3139	\$3210
60"W x 18"D x 22"H	HSCF226018RBFOL	132	14.9	\$2814	\$2885	\$2956
48"W x 18"D x 22"H	HSCF224818RBFOL	113	12.0	\$2592	\$2663	\$2734

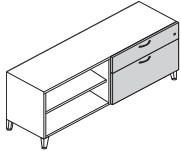

Footed Low Credenza, Laminate Front, Box/Lateral Right, Open Shelf Left						
72"W x 18"D x 22"H	HSCF227218LBFOL	152	17.7	\$3068	\$3139	\$3210
60"W x 18"D x 22"H	HSCF226018LBFOL	132	14.9	\$2814	\$2885	\$2956
48"W x 18"D x 22"H	HSCF224818LBFOL	113	12.0	\$2592	\$2663	\$2734

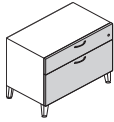

Footed Low Credenza, Laminate Front Box/Lateral						
36"W x 18"D x 22"H	HSCF223618BFL	89	9.1	\$2025	\$2060	\$2097
30"W x 18"D x 22"H	HSCF223018BFL	78	7.7	\$1960	\$1995	\$2032

NOTES:

- Lateral and wide box drawers operate on ball-bearing suspension with full extension.
- Steel ball-bearing drawer suspensions.
- Ships complete with standard footed base.
- Field installable counterweight sold separately.
- File drawers accept hanging folders in letter or legal size.
- Steel frame provides durability.
- Feet are shipped with the credenza unit and are easily assembled.
- Use with laminate tops and credenza seat cushions. Order separately — see pages 596-597.

! Locking units equipped with HON "One Key" interchangeable core removable locks. Keyed alike core model HF23S, in Satin, must be ordered separately. See page 596.

HOW TO SPECIFY

Select Model Number	Select Foot	Select Pull	Select Case Paint	Select Front Laminate	Select Shelf Paint	Select Lock
	SF Contain Foot T1 Platinum Metallic PR6 Silver	A Arch PRO Silver S Square PR6 Silver	See page 583	See page 583 L2 upcharge (+ \$37)	See page 583 Not specified for models HSCF223618BFL and HSCF223018BFL P2 upcharge (+ \$16) P3 upcharge (+ \$37)	L Standard Lock X Omit Lock (- \$20) EBNL eLock (+ \$340)
H S C F 2 2 7 2 1 8 R B F O L .	S F T 1 .	A P R O .	P J W .	L S A 1 .	P J W .	L



Icon Legend on page 19

CONTAIN[®] Metal Credenzas

	DESCRIPTION	MODEL	SHIP WEIGHT	CUBE	LIST PRICE BY CASE PAINT GRADE		
					P1	P2	P3
	Plinth, Metal Front Integrated HAT Combo Unit Credenzas						
	72"W x 18"D x 22"H	HSCP227218RBFOMHAT	152	20.7	\$2835	\$2905	\$2976
	60"W x 18"D x 22"H	HSCP226018RBFOMHAT	132	17.3	\$2556	\$2626	\$2697
	48"W x 18"D x 22"H	HSCP224818RBFOMHAT	113	14.0	\$2359	\$2429	\$2500
	Plinth, Metal Front Integrated HAT Combo Unit Credenzas						
	72"W x 18"D x 22"H	HSCP227218LBFOMHAT	152	20.7	\$2835	\$2905	\$2976
	60"W x 18"D x 22"H	HSCP226018LBFOMHAT	132	17.3	\$2556	\$2626	\$2697
	48"W x 18"D x 22"H	HSCP224818LBFOMHAT	113	14.0	\$2359	\$2429	\$2500
	Plinth, Integrated HAT Open Shelf Credenzas						
	36"W x 18"D x 22"H	HSCP223618ROHAT	89	10.6	\$1537	\$1571	\$1608
	30"W x 18"D x 22"H	HSCP223018ROHAT	78	9.0	\$1417	\$1451	\$1488
	Plinth, Integrated HAT Open Shelf Credenzas						
	36"W x 18"D x 22"H	HSCP223618LOHAT	89	10.6	\$1537	\$1571	\$1608
	30"W x 18"D x 22"H	HSCP223018LOHAT	78	9.0	\$1417	\$1451	\$1488

STORAGE

NOTES:

- Metal chassis and drawer fronts.
- Lateral and wide box drawers operate on ball-bearing suspension with full extension.
- Steel ball-bearing drawer suspensions.
- Ships complete with standard kickplate.
- Field installable counterweight sold separately.
- File drawers accept hanging folders in letter or legal size.
- Steel frame provides durability.
- Use with laminate tops and credenza seat cushions. Order separately — see pages 596-597.
- For use with Coordinate™ 2 Stage C and T bases, 24"D or 30"D.

- ! **Install Tip:** Will not accommodate pre-drilled Coordinate™ top locations in captured panel systems setups due to offset position in credenza and will require field location from credenza leg to bottom of top.
- ! Recommended to use vertical fabric wire manager model HFBRZPWM to manage cords from worksurface to inside credenza through grommet opening. See page 597.
- ! Counterweights are not required in HAT credenza applications.
- ! Locking units equipped with HON "One Key" interchangeable core removable locks. Keyed alike core model HF23S, in Satin, must be ordered separately. See page 596.

HOW TO SPECIFY

<p>Select Model Number</p> <p>H S C P 2 2 3 6 1 8 R O H A T .</p>	<p>Select Base</p> <p>BK Flush Plinth BX Recessed Plinth</p> <p>B X .</p>	<p>Select Case Paint</p> <p>See page 583</p> <p>P J W .</p>	<p>Select Shelf Paint</p> <p>See page 583 P2 upcharge (+ \$16) P3 upcharge (+ \$37)</p> <p>P J W</p>
--	--	--	---

<p>Select Model Number</p> <p>H S C P 2 2 7 2 1 8 R B F O M H A T .</p>	<p>Select Base</p> <p>BK Flush Plinth BX Recessed Plinth</p> <p>B X .</p>	<p>Select Pull</p> <p>A Arch PRO Silver R Radius N Integral S Square PR6 Silver</p> <p>A P R O .</p>	<p>Select Case Paint</p> <p>See page 583</p> <p>P J W .</p>	<p>Select Front Paint</p> <p>See page 583 NA Matches Case (+ \$0) P1 upcharge (+ \$157) P2 upcharge (+ \$178) P3 upcharge (+ \$199)</p> <p>N A .</p>	<p>Select Shelf Paint</p> <p>See page 583 P2 upcharge (+ \$16) P3 upcharge (+ \$37)</p> <p>P J W .</p>	<p>Select Lock</p> <p>L Standard Lock X Omit Lock (- \$20) EBNL eLock (+ \$340)</p> <p>L</p>
--	--	---	--	---	---	---

CONTAIN[®] Footed Metal Credenzas

OPEN MARKET



Icon Legend on page 19

STORAGE

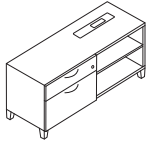

DESCRIPTION	MODEL	SHIP WEIGHT	CUBE	LIST PRICE BY CASE PAINT GRADE		
				P1	P2	P3
Footed, Metal Front Integrated HAT Combo Unit Credenzas						
72"W x 18"D x 22"H	HSCF227218RBFOMHAT	152	20.7	\$3062	\$3132	\$3203
60"W x 18"D x 22"H	HSCF226018RBFOMHAT	132	17.3	\$2788	\$2858	\$2929
48"W x 18"D x 22"H	HSCF224818RBFOMHAT	113	14.0	\$2542	\$2612	\$2683

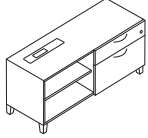

Footed, Metal Front Integrated HAT Combo Unit Credenzas						
72"W x 18"D x 22"H	HSCF227218LBFOMHAT	152	20.7	\$3062	\$3132	\$3203
60"W x 18"D x 22"H	HSCF226018LBFOMHAT	132	17.3	\$2788	\$2858	\$2929
48"W x 18"D x 22"H	HSCF224818LBFOMHAT	113	14.0	\$2542	\$2612	\$2683



Footed, Integrated HAT Open Shelf Credenzas						
36"W x 18"D x 22"H	HSCF223618ROHAT	89	10.6	\$1562	\$1596	\$1633
30"W x 18"D x 22"H	HSCF223018ROHAT	78	9.0	\$1455	\$1489	\$1526



Footed, Integrated HAT Open Shelf Credenzas						
36"W x 18"D x 22"H	HSCF223618LOHAT	89	10.6	\$1562	\$1596	\$1633
30"W x 18"D x 22"H	HSCF223018LOHAT	78	9.0	\$1455	\$1489	\$1526

NOTES:

- Lateral and wide box drawers operate on ball-bearing suspension with full extension.
 - Steel ball-bearing drawer suspensions.
 - Ships complete with standard footed base.
 - Field installable counterweight sold separately.
 - File drawers accept hanging folders in letter or legal size.
 - Steel frame provides durability.
 - Feet are shipped with the credenza unit and are easily assembled.
 - Use with laminate tops and credenza seat cushions. Order separately — see pages 596-597.
 - For use with Coordinate™ 2 Stage C and T bases, 24"D or 30"D.
- ⚠ Install Tip: Will not accommodate pre-drilled Coordinate™ top locations in captured panel systems setups due to offset position in credenza and will require field location from credenza leg to bottom of top.
- ⚠ Recommended to use vertical fabric wire manager model HFBZPZPW to manage cords from worksurface to inside credenza through grommet opening. See page 597.
- ⚠ Counterweights are not required in HAT credenza applications.
- ⚠ Locking units equipped with HON "One Key" interchangeable core removable locks. Keyed alike core model HF23S, in Satin, must be ordered separately. See page 596.

HOW TO SPECIFY

<p>Select Model Number</p> <p>HSCF223018ROHAT</p>	<p>Select Foot</p> <p>SF Contain Foot T1 Platinum Metallic PR6 Silver</p> <p>SFT1</p>	<p>Select Case Paint</p> <p>See page 583</p> <p>PJW</p>	<p>Select Shelf Paint</p> <p>See page 583 P2 upcharge (+ \$16) P3 upcharge (+ \$37)</p> <p>PJW</p>
--	--	--	---

<p>Select Model Number</p> <p>HSCF227218RBFOMHAT</p>	<p>Select Foot</p> <p>SF Contain Foot T1 Platinum Metallic PR6 Silver</p> <p>SFT1</p>	<p>Select Pull</p> <p>A Arch PRO Silver R Radius N Integral S Square PR6 Silver</p> <p>APRO</p>	<p>Select Case Paint</p> <p>See page 583</p> <p>PJW</p>	<p>Select Front Paint</p> <p>See page 583 NA Matches Case (+ \$0) P1 upcharge (+ \$157) P2 upcharge (+ \$178) P3 upcharge (+ \$199)</p> <p>NA</p>	<p>Select Shelf Paint</p> <p>See page 583 P2 upcharge (+ \$16) P3 upcharge (+ \$37)</p> <p>PJW</p>	<p>Select Lock</p> <p>L Standard Lock X Omit Lock (- \$20) EBNL eLock (+ \$340)</p> <p>L</p>
---	--	--	--	--	---	---



Icon Legend on page 19

CONTAIN® Footed Metal Credenzas

	DESCRIPTION	MODEL	SHIP WEIGHT	CUBE	LIST PRICE BY CASE PAINT GRADE		
					P1	P2	P3
	Footed, Metal Front Low Credenza Box / Open Bottom						
	36"W x 18"D x 22"H	HSCF223618BOM	89	10.6	\$1631	\$1665	\$1702
	30"W x 18"D x 22"H	HSCF223018BOM	78	9.0	\$1569	\$1603	\$1640
	Footed, Metal Front Low Credenza Open / File Drawer Bottom						
	36"W x 18"D x 22"H	HSCF223618OFM	89	10.6	\$1725	\$1759	\$1796
	30"W x 18"D x 22"H	HSCF223018OFM	78	9.0	\$1661	\$1695	\$1732
	Footed, Metal Front Combo Unit Credenzas w/ Open Shelf						
	36"W x 18"D x 22"H, RH Open	HSCF223618RBFOM	89	10.6	\$1678	\$1748	\$1819
	36"W x 18"D x 22"H, LH Open	HSCF223618LBFOM	89	10.6	\$1678	\$1748	\$1819
	Footed, Metal Front, Open Shelf, File Drawer Bottom Personal File						
	30"W x 18"D x 28"H	HSFCF283018OFM	98	11.2	\$1690	\$1724	\$1761

STORAGE

NOTES:

- Lateral and wide box drawers operate on ball-bearing suspension with full extension.
 - Steel ball-bearing drawer suspensions.
 - Ships complete with standard footed base.
 - Field installable counterweight sold separately.
 - File drawers accept hanging folders in letter or legal size.
 - Steel frame provides durability.
 - Feet are shipped with the credenza unit and are easily assembled.
 - Use with laminate tops and credenza seat cushions. Order separately — see pages 596-597.
- ! Locking units equipped with HON "One Key" interchangeable core removable locks. Keyed alike core model HF23S, in Satin, must be ordered separately. See page 596.

HOW TO SPECIFY

Select Model Number	Select Foot	Select Pull	Select Case Paint	Select Front Paint	Select Shelf Paint	Select Lock
	SF Contain Foot TI Platinum Metallic PR6 Silver	A Arch PRO Silver R Radius N Integral S Square PR6 Silver	See page 583	See page 583 NA Matches Case (+ \$0) P1 upcharge (+ \$157) P2 upcharge (+ \$178) P3 upcharge (+ \$199)	See page 583 Only specified on models HSCF223618RBFOM and HSCF223618LBFOM P2 upcharge (+ \$16) P3 upcharge (+ \$37)	L Standard Lock X Omit Lock (- \$20) EBNL eLock (+ \$340)
HSCF223618RBFOM	SFTI	APRO	PJW	NA	PJW	L

CONTAIN[®] Metal Credenzas

OPEN MARKET



Icon Legend on page 19

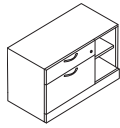

DESCRIPTION

MODEL

SHIP WEIGHT CUBE

LIST PRICE BY CASE PAINT GRADE

P1 P2 P3

Plinth, Metal Front Combo Unit Credenzas w/ Open Shelf

36"W x 18"D x 22"H, RH Open

HSCP223618RBFOM

89

10.6

\$1557

\$1627

\$1698

36"W x 18"D x 22"H, LH Open

HSCP223618LBFOM

89

10.6

\$1557

\$1627

\$1698

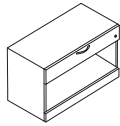

Plinth, Metal Front Low Credenza Box / Open Bottom

36"W x 18"D x 22"H

HSCP223618BOM

89

10.6

\$1476

\$1510

\$1547

30"W x 18"D x 22"H

HSCP223018BOM

78

9.0

\$1414

\$1448

\$1485

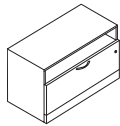

Plinth, Metal Front Low Credenza Open / File Drawer Bottom

36"W x 18"D x 22"H

HSCP223618OFM

89

10.6

\$1561

\$1595

\$1632

30"W x 18"D x 22"H

HSCP223018OFM

78

9.0

\$1496

\$1530

\$1567

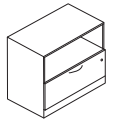

Plinth, Metal Front, Open Shelf, File Drawer Bottom Personal File

30"W x 18"D x 28"H

HSFCP283018OFM

98

11.2

\$1536

\$1570

\$1607

NOTES:

- Metal chassis and drawer fronts.
- Lateral and wide box drawers operate on ball-bearing suspension with full extension.
- Steel ball-bearing drawer suspensions.
- Ships complete with standard kickplate.
- Field installable counterweight sold separately.
- File drawers accept hanging folders in letter or legal size.
- Steel frame provides durability.
- Use with laminate tops and credenza seat cushions. Order separately — see pages 596-597.

! Locking units equipped with HON "One Key" interchangeable core removable locks. Keyed alike core model HF23S, in Satin, must be ordered separately. See page 596.

HOW TO SPECIFY

Select Model Number	Select Base	Select Pull	Select Case Paint	Select Front Paint	Select Shelf Paint	Select Lock
H S C P 2 2 3 6 1 8 R B F O M .	BK Flush Plinth BX Recessed Plinth	A Arch PRO Silver R Radius N Integral S Square PR6 Silver	See page 583	See page 583 NA Matches Case (+ \$0) P1 upcharge (+ \$157) P2 upcharge (+ \$178) P3 upcharge (+ \$199)	See page 583 Only specified on models HSCP223618RBFOM and HSCP223618LBFOM P2 upcharge (+ \$16) P3 upcharge (+ \$37)	L Standard Lock X Omit Lock (- \$20) EBNL eLock (+ \$340)
H S C P 2 2 3 6 1 8 R B F O M .	B X .	A P R O .	P J W .	N A .	P J W .	L



Icon Legend on page 19

CONTAIN[®] Metal Credenzas

	DESCRIPTION	MODEL	SHIP WEIGHT	CUBE	LIST PRICE BY CASE PAINT GRADE		
					P1	P2	P3
	Plinth, Laminate Front Integrated HAT Combo Unit Credenzas						
	72"W x 18"D x 22"H	HSCP227218RBFOLHAT	152	20.7	\$3142	\$3212	\$3283
	60"W x 18"D x 22"H	HSCP226018RBFOLHAT	132	17.3	\$2869	\$2939	\$3010
	48"W x 18"D x 22"H	HSCP224818RBFOLHAT	113	14.0	\$2667	\$2737	\$2808
	Plinth, Laminate Front Integrated HAT Combo Unit Credenzas						
	72"W x 18"D x 22"H	HSCP227218LBFOLHAT	152	20.7	\$3142	\$3212	\$3283
	60"W x 18"D x 22"H	HSCP226018LBFOLHAT	132	17.3	\$2869	\$2939	\$3010
	48"W x 18"D x 22"H	HSCP224818LBFOLHAT	113	14.0	\$2667	\$2737	\$2808
	Plinth, Laminate Front Low Credenza Box / Open Bottom						
	36"W x 18"D x 22"H	HSCP223618BOL	89	10.6	\$1739	\$1773	\$1810
	30"W x 18"D x 22"H	HSCP223018BOL	78	9.0	\$1676	\$1710	\$1747
	Plinth, Laminate Front Low Credenza Open / File Drawer Bottom						
	36"W x 18"D x 22"H	HSCP223618OFL	89	10.6	\$1839	\$1873	\$1910
	30"W x 18"D x 22"H	HSCP223018OFL	78	9.0	\$1773	\$1807	\$1844
	Plinth, Laminate Front, Open Shelf, File Drawer Bottom Personal File						
	30"W x 18"D x 28"H	HSFCP283018OFL	98	11.2	\$1766	\$1800	\$1837
	Plinth, Laminate Front Combo Unit Credenzas w/ Open Shelf						
	36"W x 18"D x 22"H, RH Open	HSCP223618RBFOL	89	10.6	\$1760	\$1830	\$1901
	36"W x 18"D x 22"H, LH Open	HSCP223618LBFOL	89	10.6	\$1760	\$1830	\$1901

STORAGE

NOTES:

- Metal chassis and drawer fronts.
- Lateral and wide box drawers operate on ball-bearing suspension with full extension.
- Steel ball-bearing drawer suspensions.
- Ships complete with standard kickplate.
- Field installable counterweight sold separately.
- File drawers accept hanging folders in letter or legal size.
- Steel frame provides durability.
- Use with laminate tops and credenza seat cushions. Order separately — see pages 596-597.
- For use with Coordinate™ 2 Stage C and T bases, 24"D or 30"D.

- ❗ **Install Tip:** Will not accommodate pre-drilled Coordinate™ top locations in captured panel systems setups due to offset position in credenza and will require field location from credenza leg to bottom of top.
- ❗ Recommended to use vertical fabric wire manager model HFBRZPWM to manage cords from worksurface to inside credenza through grommet opening. See page 597.
- ❗ Counterweights are not required in HAT credenza applications.
- ❗ Locking units equipped with HON "One Key" interchangeable core removable locks. Keyed alike core model HF23S, in Satin, must be ordered separately. See page 596.

HOW TO SPECIFY

Select Model Number	Select Base	Select Pull	Select Case Paint	Select Front Laminate	Select Shelf Paint	Select Lock
HSCP223618RBFOL	BX Recessed Plinth	A Arch PRO Silver S Square PR6 Silver	See page 583	See page 583 L2 upcharge (+ \$37)	See page 583 Only specified on models ending in -FOL and -FOLHAT P2 upcharge (+ \$16) P3 upcharge (+ \$37)	L Standard Lock X Omit Lock (- \$20) EBNL eLock (+ \$340)
HSCP223618RBFOL	BX	APRO	PJW	LSA1	PJW	L



Icon Legend on page 19

STORAGE

	DESCRIPTION	MODEL	SHIP WEIGHT	CUBE	LIST PRICE BY CASE PAINT GRADE		
					P1	P2	P3
	Footed, Laminate Front Integrated HAT Combo Unit Credenzas						
	72"W x 18"D x 22"H	HSCF227218RBFOLHAT	152	20.7	\$3374	\$3444	\$3515
	60"W x 18"D x 22"H	HSCF226018RBFOLHAT	132	17.3	\$3094	\$3164	\$3235
	48"W x 18"D x 22"H	HSCF224818RBFOLHAT	113	14.0	\$2851	\$2921	\$2992
	Footed, Laminate Front Integrated HAT Combo Unit Credenzas						
	72"W x 18"D x 22"H	HSCF227218LBFOLHAT	152	20.7	\$3374	\$3444	\$3515
	60"W x 18"D x 22"H	HSCF226018LBFOLHAT	132	17.3	\$3094	\$3164	\$3235
	48"W x 18"D x 22"H	HSCF224818LBFOLHAT	113	14.0	\$2851	\$2921	\$2992
	Footed, Laminate Front Low Credenza Box / Open Bottom						
	36"W x 18"D x 22"H	HSCF223618BOL	89	10.6	\$1894	\$1928	\$1965
	30"W x 18"D x 22"H	HSCF223018BOL	78	9.0	\$1834	\$1868	\$1905
	Footed, Laminate Front Low Credenza Open / File Drawer Bottom						
	36"W x 18"D x 22"H	HSCF223618OFL	78	9.0	\$2004	\$2038	\$2075
	30"W x 18"D x 22"H	HSCF223018OFL	78	9.0	\$1940	\$1974	\$2011
	Footed, Laminate Front Combo Unit Credenzas w/ Open Shelf						
	36"W x 18"D x 22"H, RH Open	HSCF223618RBFOL	89	10.6	\$1881	\$1951	\$2022
	36"W x 18"D x 22"H, LH Open	HSCF223618LBFOL	89	10.6	\$1881	\$1951	\$2022
	Footed, Laminate Front, Open Shelf, File Drawer Bottom Personal File						
30"W x 18"D x 28"H	HSFCF283018OFL	98	11.2	\$1920	\$1954	\$1991	

NOTES:

- Lateral and wide box drawers operate on ball-bearing suspension with full extension.
- Steel ball-bearing drawer suspensions.
- Ships complete with standard footed base.
- Field installable counterweight sold separately.
- File drawers accept hanging folders in letter or legal size.
- Steel frame provides durability.
- Feet are shipped with the credenza unit and are easily assembled.
- Use with laminate tops and credenza seat cushions. Order separately — see pages 596-597.
- For use with Coordinate™ 2 Stage C and T bases, 24"D or 30"D.

⚠ Install Tip: Will not accommodate pre-drilled Coordinate™ top locations in captured panel systems setups due to offset position in credenza and will require field location from credenza leg to bottom of top.

⚠ Recommended to use vertical fabric wire manager model HFBRZPWM to manage cords from worksurface to inside credenza through grommet opening. See page 597.

⚠ Counterweights are not required in HAT credenza applications.

⚠ Locking units equipped with HON "One Key" interchangeable core removable locks. Keyed alike core model HF23S, in Satin, must be ordered separately. See page 596.

HOW TO SPECIFY

Select Model Number	Select Foot	Select Pull	Select Case Paint	Select Front Laminate	Select Shelf Paint	Select Lock
HSCF2223618RBFOL	SF Contain Foot T1 Platinum PR6 Silver	A Arch PRO Silver S Square PR6 Silver	See page 583	See page 583 L2 upcharge (+ \$37)	See page 583 Only specified on models ending in -FOL and -FOLHAT P2 upcharge (+ \$16) P3 upcharge (+ \$37)	L Standard Lock X Omit Lock (- \$20) EBNL eLock (+ \$340)
HSCF2223618RBFOL	SFT1	APRO	PJW	LSA1	PJW	L



Icon Legend on page 19

CONTAIN[®] Metal Credenzas

	DESCRIPTION	MODEL	SHIP WEIGHT	CUBE	LIST PRICE BY CASE PAINT GRADE		
					P1	P2	P3
	Mobile, Metal Front Low Credenza Box / Open Bottom						
	36"W x 18"D x 22"H 30"W x 18"D x 22"H	HSCM223618BOM HSCM223018BOM	89 78	10.6 9.0	\$1862 \$1799	\$1896 \$1833	\$1933 \$1870
	Mobile, Metal Front Low Credenza Open / File Drawer Bottom						
	36"W x 18"D x 22"H 30"W x 18"D x 22"H	HSCM223618OFM HSCM223018OFM	89 78	10.6 9.0	\$2134 \$2063	\$2168 \$2097	\$2205 \$2134
	Mobile, Metal Front Low Credenza Box / File Drawer						
	36"W x 18"D x 22"H 30"W x 18"D x 22"H	HSCM223618BFM HSCM223018BFM	89 78	10.6 9.0	\$2378 \$2307	\$2412 \$2341	\$2449 \$2378
	Mobile, Metal Front Combo Unit Credenzas w/ Open Shelf						
	36"W x 18"D x 22"H, RH Open 36"W x 18"D x 22"H, LH Open	HSCM223618RBFOM HSCM223618LBFOM	89 78	10.6 9.0	\$1957 \$1957	\$2027 \$2027	\$2098 \$2098
	Mobile, Metal Front Low Credenza Open / File Drawer Bottom						
	36"W x 18"D x 22"H 30"W x 18"D x 22"H	HSCM223618O HSCM223018O	89 78	10.6 9.0	\$1881 \$1782	\$1915 \$1816	\$1952 \$1853

STORAGE

NOTES:

- Metal chassis and drawer fronts.
 - Lateral and wide box drawers operate on ball-bearing suspension with full extension.
 - Steel ball-bearing drawer suspensions.
 - Ships complete with standard kickplate.
 - Field installable counterweight sold separately.
 - File drawers accept hanging folders in letter or legal size.
 - Steel frame provides durability.
 - Use with laminate tops and credenza seat cushions. Order separately — see pages 596-597.
- ! Locking units equipped with HON "One Key" interchangeable core removable locks. Keyed alike core model HF23S, in Satin, must be ordered separately. See page 596.

HOW TO SPECIFY

Select Model Number	Select Caster	Select Pull	Select Case Paint	Select Front Paint	Select Shelf Paint	Select Lock
HSCM223618RBFOM	H Hard Caster	A Arch PRO Silver R Radius N Integral S Square PR6 Silver	See page 583	See page 583 NA Matches Case (+ \$0) P1 upcharge (+ \$157) P2 upcharge (+ \$178) P3 upcharge (+ \$199)	See page 583 Only specified on models HSCM223618RBFOM and HSCM223618LBFOM P2 upcharge (+ \$16) P3 upcharge (+ \$37)	L Standard Lock X Omit Lock (- \$20) EBNL eLock (+ \$340)
	H	APRO	PJW	NA	PJW	L



	DESCRIPTION	MODEL	SHIP WEIGHT	CUBE	LIST PRICE BY CASE PAINT GRADE		
					P1	P2	P3
	Mobile Laminate Front Low Credenza Box / Open Bottom						
	36"W x 18"D x 22"H 30"W x 18"D x 22"H	HSCM223618BOL HSCM223018BOL	89 78	10.6 9.0	\$2124 \$2065	\$2158 \$2099	\$2195 \$2136
	Mobile, Laminate Front Low Credenza Open / File Drawer Bottom						
	36"W x 18"D x 22"H 30"W x 18"D x 22"H	HSCM223618OFL HSCM223018OFL	89 78	10.6 9.0	\$2235 \$2171	\$2269 \$2205	\$2306 \$2242
	Mobile, Laminate Front Low Credenza Box / File Drawer						
	36"W x 18"D x 22"H 30"W x 18"D x 22"H	HSCM223618BFL HSCM223018BFL	89 78	10.6 9.0	\$2688 \$2617	\$2722 \$2651	\$2759 \$2688
	Mobile, Laminate Front Combo Unit Credenzas w/ Open Shelf						
	36"W x 18"D x 22"H, RH Open 36"W x 18"D x 22"H, LH Open	HSCM223618RBFOL HSCM223618LBFOL	89 89	10.6 10.6	\$1996 \$1996	\$2066 \$2066	\$2137 \$2137

NOTES:

- Lateral and wide box drawers operate on ball-bearing suspension with full extension.
- Steel ball-bearing drawer suspensions.
- Ships complete with standard footed base.
- Field installable counterweight sold separately.
- File drawers accept hanging folders in letter or legal size.
- Steel frame provides durability.
- Feet are shipped with the credenza unit and are easily assembled.
- Use with laminate tops and credenza seat cushions. Order separately — see pages 596-597.

! Locking units equipped with HON "One Key" interchangeable core removable locks. Keyed alike core model HF23S, in Satin, must be ordered separately. See page 596.

HOW TO SPECIFY

Select Model Number	Select Caster	Select Pull	Select Case Paint	Select Front Laminate	Select Shelf Paint	Select Lock
	H Hard Caster	A Arch PRO Silver S Square PR6 Silver	See page 583	See page 583 L2 upcharge (+ \$37)	See page 583 Only specified on models HSCM223618RBFOM and HSCM223618LBFOM P2 upcharge (+ \$16) P3 upcharge (+ \$37)	L Standard Lock X Omit Lock (- \$20) EBNL eLock (+ \$340)
H S C M 2 2 3 6 1 8 R B F O L .	H .	A P R O .	P J W .	L S A 1 .	P J W .	L



Icon Legend on page 19

CONTAIN® Personal Files

	DESCRIPTION	MODEL	SHIP WEIGHT	CUBE	LIST PRICE BY CASE PAINT GRADE		
					P1	P2	P3
	Box/Box/File 30"W x 18"D x 28"H	HSFCP283018BBFM	90	11.3	\$1746	\$1781	\$1818
	Footed, Box/Box/File 30"W x 18"D x 28"H	HSFCF283018BBFM	90	11.3	\$1920	\$1955	\$1992
	Box/Box/File, Laminate Front Base 30"W x 18"D x 28"H	HSFCP283018BBFL	90	11.3	\$2007	\$2042	\$2079
	Footed, Box/Box/File, Laminate Front 30"W x 18"D x 28"H	HSFCF283018BBFL	90	11.3	\$2182	\$2217	\$2254

STORAGE

NOTES:

- Lateral and wide box drawers operate on ball-bearing suspension with full extension.
- Steel ball-bearing drawer suspensions.
- Field installable counterweight sold separately.
- File drawers accept hanging folders in letter or legal size.
- Steel frame provides durability.

🔑 Locking units equipped with HON "One Key" interchangeable core removable locks.

HOW TO SPECIFY

Select Model Number	Select Base/Foot	Select Pull	Select Case Paint	Select Front Paint	Select Lock
	BK Flush Plinth BX Recessed Plinth SF Contain Foot T1 Platinum Metallic PR6 Silver	A Arch PRO Silver R Radius N Integral S Square PR6 Silver	See page 583	See page 583 NA Matches Case (+ \$0) P1 upcharge (+ \$157) P2 upcharge (+ \$178) P3 upcharge (+ \$199)	L Standard Lock X Omit Lock (- \$20) EBNL eLock (+ \$340)
HSFCP283018BBFM.	BX.	APRO.	PJW.	NA.	L

Select Model Number	Select Base/Foot	Select Pull	Select Case Paint	Select Front Laminate	Select Lock
	BX Recessed Plinth SF Contain Foot T1 Platinum Metallic PR6 Silver	A Arch PRO Silver S Square PR6 Silver	See page 583	See page 583 L2 upcharge (+ \$37)	L Standard Lock X Omit Lock (- \$20) EBNL eLock (+ \$340)
HSFCF283018BBFL.	SFT1.	APRO.	PJW.	LSA1.	L

CONTAIN® Lateral Files

GSA SIN 33721



Icon Legend on page 19

STORAGE

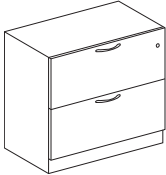
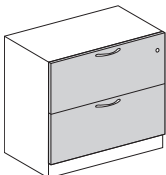
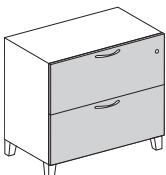
	DESCRIPTION	MODEL	SHIP WEIGHT	CUBE	LIST PRICE BY CASE PAINT GRADE		
					P1	P2	P3
	2 Drawer Lateral						
	30"W x 18"D x 28"H 36"W x 18"D x 28"H	HSLP283018FFM HSLP283618FFM	90 101	11.3 13.4	\$1359 \$1597	\$1394 \$1632	\$1431 \$1669
	Footed 2 Drawer Lateral						
	30"W x 18"D x 28"H 36"W x 18"D x 28"H	HSLF283018FFM HSLF283618FFM	90 101	11.3 13.4	\$1591 \$1757	\$1626 \$1792	\$1663 \$1829
	2 Drawer Lateral, Laminate Front						
	30"W x 18"D x 28"H 36"W x 18"D x 28"H	HSLP283018FFL HSLP283618FFL	98 109	11.3 13.4	\$1682 \$1834	\$1717 \$1869	\$1754 \$1906
	Footed 2 Drawer Lateral, Laminate Front						
	30"W x 18"D x 28"H 36"W x 18"D x 28"H	HSLF283018FFL HSLF283618FFL	98 109	11.3 13.4	\$1834 \$2019	\$1869 \$2054	\$1906 \$2091

NOTES:

- Lateral and wide box drawers operate on ball-bearing suspension with full extension.
- Steel ball-bearing drawer suspensions.
- Field installable counterweight sold separately.
- File drawers accept hanging folders in letter or legal size.
- Steel frame provides durability.
- Contain® Laterals can be used with Storage Islands.

! Locking units equipped with HON "One Key" interchangeable core removable locks.



HOW TO SPECIFY

Select Model Number	Select Base/Foot	Select Pull	Select Case Paint	Select Front Paint	Select Lock
	BK Flush Plinth BX Recessed Plinth SF Contain Foot T1 Platinum Metallic PR6 Silver	A Arch PRO Silver R Radius N Integral S Square PR6 Silver	See page 583	See page 583 NA Matches Case (+ \$0) P1 upcharge (+ \$157) P2 upcharge (+ \$178) P3 upcharge (+ \$199)	L Standard Lock X Omit Lock (- \$20) EBNL eLock (+ \$340)
H S L P 2 8 3 0 1 8 F F M .	B X .	A P R O .	P J W .	N A .	L

Select Model Number	Select Base/Foot	Select Pull	Select Case Paint	Select Front Laminate	Select Lock
	BX Recessed Plinth SF Contain Foot T1 Platinum Metallic PR6 Silver	A Arch PRO Silver S Square PR6 Silver	See page 583	See page 583 L2 upcharge (+ \$37)	L Standard Lock X Omit Lock (- \$20) EBNL eLock (+ \$340)
H S L F 2 8 3 0 1 8 F F L .	S F T 1 .	A P R O .	P J W .	L S A 1 .	L

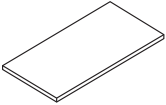

CONTAIN® Lateral File Accessories

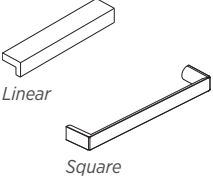
	DESCRIPTION	MODEL	SHIP WEIGHT	CUBE	LIST PRICE BY LAMINATE GRADE	
					L1	L2
 SIN 33721	Square Edge Laminate Top					
	72"W x 18"D x 1/8" Thick	H919472	48	3.5	\$1155	\$1171
	60"W x 18"D x 1/8" Thick	H919460	32	3.0	\$985	\$1001
	48"W x 18"D x 1/8" Thick	H919448	31	2.6	\$865	\$876
	36"W x 18"D x 1/8" Thick	H919436	25	1.8	\$714	\$725
	30"W x 18"D x 1/8" Thick	H919430	20	1.6	\$570	\$581
NOTES: Square-edge laminate tops provide a finished look to laterals. See Storage Islands on page 649 for full laminate solution. Specify laminate only. SPECIFYING EXAMPLE: H919448.C						
	DESCRIPTION	MODEL	SHIP WEIGHT	CUBE	LIST PRICE	
 OPEN MARKET	Front-to-Back Hangrail Kits					
	15"D for 24"D Credenza or 18"D Lateral	HSCAHR15	0.1	0.2	\$29	
No specification needed.						
	DESCRIPTION	MODEL	SHIP WEIGHT	CUBE	LIST PRICE	
 OPEN MARKET	Counterweight for Contain 28"H Laterals					
	50 lbs for 30" Lateral	HSLACW50	2.0	55.0	\$275	
	57½ lbs for 36" Lateral	HSLACW57	2.0	63.0	\$288	
No specification needed.						
	DESCRIPTION	MODEL	SHIP WEIGHT	CUBE	LIST PRICE	
 Linear Square OPEN MARKET	Field Installable Drawer/Door Handle Kits					
	Field Installable Pull, 2 Pack	HPULL2	0.4	0.3	\$73	
	Field Installable Pull, 3 Pack	HPULL3	0.5	0.3	\$83	
NOTES: Square and Linear pull packs provide the option to coordinate with Fuse™ Storage. Pull packs are field installable on all Contain® Storage Products, excluding electronic locking units.						

STORAGE

HOW TO SPECIFY

Select Model Number H 9 1 9 4 7 2 .	Select Laminate See page 583 C
Select Model Number H P U L L 2 .	Select Pull LP Linear Black LPR6 Linear Silver SPR6 Square Silver L P R 6

CONTAIN® Metal Credenzas Accessories

GSA SIN 33721



Icon Legend on page 19

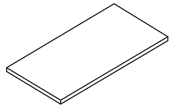

DESCRIPTION	MODEL	SHIP WEIGHT	CUBE	LIST PRICE BY LAMINATE GRADE	
				L1	L2
Square Edge Laminate Top					
72"W x 18"D x 1/8" Thick	H919472	48.0	3.5	\$1155	\$1171
60"W x 18"D x 1/8" Thick	H919460	32.0	3.0	\$985	\$1001
48"W x 18"D x 1/8" Thick	H919448	31.0	2.6	\$865	\$876
36"W x 18"D x 1/8" Thick	H919436	25.0 Ⓢ	1.8	\$714	\$725
30"W x 18"D x 1/8" Thick	H919430	20.0 Ⓢ	1.6	\$570	\$581

NOTES: Square-edge laminate tops provide a finished look to credenzas.

! Specify laminate only.

SPECIFYING EXAMPLE: H919448.C

STORAGE

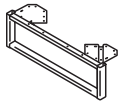

DESCRIPTION	MODEL	SHIP WEIGHT	CUBE	LIST PRICE BY PAINT GRADE		
				P1	P2	P3
Worksurface O-Leg						
30"W x 6 1/2"H	HSCAWS6530	7.0	1.0	\$306	\$317	\$322
24"W x 6 1/2"H	HSCAWS6524	6.0	1.0	\$255	\$266	\$271
20"W x 6 1/2"H	HSCAWS6520	5.0	1.0	\$222	\$233	\$238

NOTES: Worksurfaces with O-Legs may be placed upon Low Credenzas to create layering.

! Specify paint only.

SPECIFYING EXAMPLE: HSCAWS6530.S



Credenza Kickplates						
For 36" Box/File Model	HSCK36BF	3.0	0.5	\$176	\$187	\$203
For 30" Box/File Model	HSCK30BF	2.0	0.4	\$162	\$173	\$189
For 24" Box/File Model	HSCK24BF	2.0	0.4	\$145	\$156	\$172
For 36" Open File Model	HSCK36O	3.0	0.5	\$176	\$187	\$203
For 30" Open File Model	HSCK30O	2.0	0.4	\$162	\$173	\$189

! Specify paint only.

SPECIFYING EXAMPLE: HSCK36BF.S

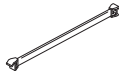

Credenza Hangrail Kits						
12" for front-to-back filing	HSCAHR12	1.0 Ⓢ	0.4	\$25	N/A	N/A

NOTES: For legal filing, hangrail kit hooks on the front hangrail and the side-to-side hangrail. No specification needed.

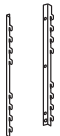

Credenza Storage-to-Panel Bracket	HSCAPB	0.2 Ⓢ	0.4	\$264	\$277	\$285
--	---------------	--------------	-----	--------------	--------------	--------------

! Specify paint only.

SPECIFYING EXAMPLE: HSCAPB.S

Credenza Counterweight Kit						
	HSCACW50	55.0 Ⓢ	2.0	\$294	N/A	N/A
	HSCACW35	40.0 Ⓢ	2.0	\$265	N/A	N/A
	HSCACW25	30.0 Ⓢ	2.0	\$237	N/A	N/A

NOTES: Field installable counterweight sold separately. No specification needed.

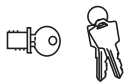

Removable Lock Core Kit—Satin	HF23S	0.2 Ⓢ	0.1	\$61	N/A	N/A
--------------------------------------	--------------	--------------	-----	-------------	------------	------------

• Use when specifying omit lock application.

- Specify quantity of each key number from 101E-225E.
- Includes: 1-core, 2-keys, 1-core removal tool and instructions.
- Removable lock core kits with specific key number must be ordered to facilitate keying alike in the field.
- For specific models, look for the Omit Lock Core icon throughout this publication.

NOTES: If key number isn't specified, number will be at random. Core matches manufactured lock on Contain® product but can be used with Contain® metal casegoods and laminate product.

HOW TO SPECIFY

Select Model Number <div style="border: 1px solid black; padding: 2px; display: flex; gap: 5px;"> H919448 </div>	Select Laminate See page 583 <div style="border: 1px solid black; padding: 2px; display: flex; gap: 5px;"> C </div>
Select Model Number <div style="border: 1px solid black; padding: 2px; display: flex; gap: 5px;"> HSCAWS6530 </div>	Select Paint See page 583 <div style="border: 1px solid black; padding: 2px; display: flex; gap: 5px;"> S </div>



Icon Legend on page 19

CONTAIN[®] Metal Credenzas Accessories

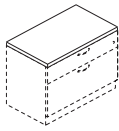

DESCRIPTION	MODEL	SHIP													
		WEIGHT	CUBE	1	2	3	4	5	6	7	8	9	10	11	12
Credenza Cushion 36"W x 18"D for 36", 60", and 72" Credenzas	HSCAUC1836	16.3	1.6	\$376	\$416	\$456	\$497	\$548	\$600	\$652	\$704	\$756	\$807	\$859	\$912
30"W x 18"D for 30", 48", and 60" Credenzas	HSCAUC1830	16.3	1.6	\$351	\$391	\$431	\$472	\$523	\$575	\$627	\$679	\$731	\$782	\$834	\$887
24"W x 18"D for 48" Credenzas	HSCAUC1824	16.3	1.9	\$328	\$368	\$408	\$449	\$500	\$552	\$604	\$656	\$708	\$759	\$811	\$864

NOTES: See pages 22-24 for available fabrics.
SPECIFYING EXAMPLE: HSCAUC1836.APN23

NOTES:

- For matching Pedestal Seats, see page 621.
- Credenza Cushions are available in 24", 30" and 36" size options.
- Choose from multiple upholstery options, see pages 22-24.

HOW TO SPECIFY

<p>Select Model Number</p> <p>H S C A U C 1 8 3 6 .</p>	<p>Select Fabric</p> <p>See pages 22-24</p> <p>C U 1 0</p>
---	--

DESCRIPTION	MODEL	SHIP WEIGHT	CUBE	LIST PRICE
Fabric Wire Manager (Pack of 2)	HFBRZPWM	2	0.6	\$350



OPEN MARKET

HOW TO SPECIFY

<p>Select Model Number</p> <p>H F B R Z P W M .</p>	<p>Select Fabric</p> <p>See page 583</p> <p>P</p>
---	---

DESCRIPTION	MODEL	SHIP WEIGHT	CUBE	LIST PRICE
				P1
Metal Box Divider 10 pack	HSCABD10	7	0.7	\$227
2 pack	HSCABD02	2	0.7	\$59

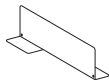

! Metal dividers available in Black only. No need to specify.

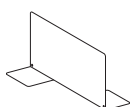

Metal File Divider 10 pack	HSCAFD10	12	0.7	\$270
2 pack	HSCAFD02	3	0.7	\$73

! Metal dividers available in Black only. No need to specify.

STORAGE

CONTAIN[®] Metal Personal Towers

GSA SIN 33721



Icon Legend on page 19

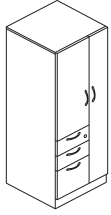

DESCRIPTION	MODEL	SHIP WEIGHT	CUBE	LIST PRICE BY CASE PAINT GRADE		
				P1	P2	P3
Personal Tower with Metal Fronts, Door/Box/Box/File						
65"H x 24"W x 24"D, Wardrobe Left	HSTP652424LBBFM	178	27.2	\$2711	\$2792	\$2863
65"H x 24"W x 24"D, Wardrobe Right	HSTP652424RBBFM	178	27.2	\$2711	\$2792	\$2863
50"H x 24"W x 24"D, Wardrobe Left	HSTP502424LBBFM	146	21.2	\$2537	\$2618	\$2689
50"H x 24"W x 24"D, Wardrobe Right	HSTP502424RBBFM	146	21.2	\$2537	\$2618	\$2689
42"H x 24"W x 24"D, Wardrobe Left	HSTP422424LBBFM	132	16.8	\$2180	\$2233	\$2311
42"H x 24"W x 24"D, Wardrobe Right	HSTP422424RBBFM	132	16.8	\$2180	\$2233	\$2311

STORAGE

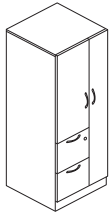

Personal Tower with Metal Fronts, Door/File/File						
65"H x 24"W x 24"D, Wardrobe Left	HSTP652424LFFM	178	27.2	\$2641	\$2722	\$2793
65"H x 24"W x 24"D, Wardrobe Right	HSTP652424RFFM	178	27.2	\$2641	\$2722	\$2793
50"H x 24"W x 24"D, Wardrobe Left	HSTP502424LFFM	146	21.1	\$2471	\$2552	\$2623
50"H x 24"W x 24"D, Wardrobe Right	HSTP502424RFFM	146	21.1	\$2471	\$2552	\$2623
42"H x 24"W x 24"D, Wardrobe Left	HSTP422424LFFM	132	16.8	\$2111	\$2164	\$2242
42"H x 24"W x 24"D, Wardrobe Right	HSTP422424RFFM	132	16.8	\$2111	\$2164	\$2242

NOTES:

- Metal chassis and drawer fronts.
- Steel frame provides durability.
- Leveling glides can be adjusted from outside or inside the case.
- Heavy-duty, telescoping ball-bearing slides.
- Baked, epoxy/polyester, powder coating finish.
- One lock secures doors and drawers.
- Pencil tray standard in top box drawer.
- One box divider standard in each box drawer.
- One crossrail standard in each file drawer.
- Shelves are only in the cabinet side above the drawer units.
- 42"H units do not include an adjustable shelf in the upper cabinet section.
- 50"H units include one adjustable shelf.
- 65"H units include two adjustable shelves.

! Locking units equipped with HON "One Key" interchangeable core removable locks. Keyed alike core model HF23S, in Satin, must be ordered separately. See page 596.

HOW TO SPECIFY

Select Model Number	Select Base	Select Pull	Select Case Paint	Select Front Paint	Select Lock
BK Flush Plinth BX Recessed Plinth	A Arch PRO Silver R Radius N Integral S Square PR6 Silver	See page 583	See page 583 NA Matches Case (+ \$0) P1 upcharge (+ \$157) P2 upcharge (+ \$178) P3 upcharge (+ \$199)	L Standard Lock X Omit Lock (- \$20) EBNL eLock (+ \$340)	
H S T P 6 5 2 4 2 4 L F F M .	B X .	A P R O .	P J W .	N A .	L



Icon Legend on page 19

CONTAIN[®] Metal Side Access Towers

	DESCRIPTION	MODEL	SHIP WEIGHT	CUBE	LIST PRICE BY CASE PAINT GRADE		
					P1	P2	P3
	Side Access Tower with Metal Fronts, Shelves/Box/Box/File						
	65”H x 24”W x 24”D, Wardrobe Left	HSTSP652424LBBFM	178	27.2	\$2870	\$2951	\$3022
	65”H x 24”W x 24”D, Wardrobe Right	HSTSP652424RBBFM	178	27.2	\$2870	\$2951	\$3022
	50”H x 24”W x 24”D, Wardrobe Left	HSTSP502424LBBFM	146	21.2	\$2688	\$2769	\$2840
	50”H x 24”W x 24”D, Wardrobe Right	HSTSP502424RBBFM	146	21.2	\$2688	\$2769	\$2840
	42”H x 24”W x 24”D, Wardrobe Left	HSTSP422424LBBFM	132	16.8	\$2425	\$2478	\$2556
	42”H x 24”W x 24”D, Wardrobe Right	HSTSP422424RBBFM	132	16.8	\$2425	\$2478	\$2556
	Side Access Tower with Metal Fronts, Shelves/File/File						
	65”H x 24”W x 24”D, Wardrobe Left	HSTSP652424LFFM	178	27.2	\$2804	\$2885	\$2956
	65”H x 24”W x 24”D, Wardrobe Right	HSTSP652424RFFM	178	27.2	\$2804	\$2885	\$2956
	50”H x 24”W x 24”D, Wardrobe Left	HSTSP502424LFFM	146	21.2	\$2620	\$2701	\$2772
	50”H x 24”W x 24”D, Wardrobe Right	HSTSP502424RFFM	146	21.2	\$2620	\$2701	\$2772
	42”H x 24”W x 24”D, Wardrobe Left	HSTSP422424LFFM	132	16.8	\$2359	\$2412	\$2490
	42”H x 24”W x 24”D, Wardrobe Right	HSTSP422424RFFM	132	16.8	\$2359	\$2412	\$2490

STORAGE

NOTES:

- Towers can be used to support a worksurface. In order to do so, order bracket model HSTB2W1.
- Metal chassis and drawer fronts.
- Steel frame provides durability.
- Leveling glides can be adjusted from outside or inside the case.
- Heavy-duty, telescoping ball-bearing slides.
- Baked, epoxy/polyester, powder coating finish.
- One lock secures doors and drawers.
- Pencil tray standard in top box drawer.
- One box divider standard in each box drawer.
- One crossrail standard in each file drawer.

ⓘ Locking units equipped with HON “One Key” interchangeable core removable locks. Keyed alike core model HF23S, in Satin, must be ordered separately. See page 596.

HOW TO SPECIFY

Select Model Number	Select Base	Select Pull	Select Case Paint	Select Front Paint	Select Panel Paint	Select Lock
	BK Flush Plinth BX Recessed Plinth	A Arch PRO Silver R Radius N Integral S Square PR6 Silver	See page 583	See page 583 NA Matches Case (+ \$0) P1 upcharge (+ \$157) P2 upcharge (+ \$178) P3 upcharge (+ \$199)	NA Matches Case	L Standard Lock X Omit Lock (- \$20) EBNL eLock (+ \$340)
HSTSP652424LFFM	BX	APRO	PJW	NA	NA	L

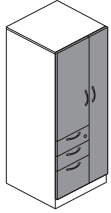

DESCRIPTION	MODEL	SHIP WEIGHT	CUBE	LIST PRICE BY PAINT GRADE		
				P1	P2	P3
Personal Tower with Laminate Fronts, Door/Box/Box/File						
65"H x 24"W x 24"D, Wardrobe Left	HSTP652424LBBFL	178	27.2	\$3104	\$3185	\$3256
65"H x 24"W x 24"D, Wardrobe Right	HSTP652424RBBFL	178	27.2	\$3104	\$3185	\$3256
50"H x 24"W x 24"D, Wardrobe Left	HSTP502424LBBFL	146	21.2	\$2907	\$2988	\$3059
50"H x 24"W x 24"D, Wardrobe Right	HSTP502424RBBFL	146	21.2	\$2907	\$2988	\$3059
42"H x 24"W x 24"D, Wardrobe Left	HSTP422424LBBFL	132	16.8	\$2496	\$2549	\$2627
42"H x 24"W x 24"D, Wardrobe Right	HSTP422424RBBFL	132	16.8	\$2496	\$2549	\$2627

Personal Tower with Laminate Fronts, Door/File/File						
65"H x 24"W x 24"D, Wardrobe Left	HSTP652424LFFL	178	27.2	\$3038	\$3119	\$3190
65"H x 24"W x 24"D, Wardrobe Right	HSTP652424RFFL	178	27.2	\$3038	\$3119	\$3190
50"H x 24"W x 24"D, Wardrobe Left	HSTP502424LFFL	146	21.2	\$2840	\$2921	\$2992
50"H x 24"W x 24"D, Wardrobe Right	HSTP502424RFFL	146	21.2	\$2840	\$2921	\$2992
42"H x 24"W x 24"D, Wardrobe Left	HSTP422424LFFL	132	16.8	\$2427	\$2480	\$2558
42"H x 24"W x 24"D, Wardrobe Right	HSTP422424RFFL	132	16.8	\$2427	\$2480	\$2558

STORAGE

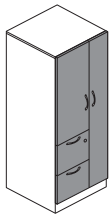

NOTES:

- Metal chassis with laminate drawer/door fronts.
- Steel frame provides durability.
- Leveling glides can be adjusted from outside or inside the case.
- Heavy-duty, telescoping ball-bearing slides.
- Baked, epoxy/polyester, powder coating finish.
- One lock secures doors and drawers.
- Pencil tray standard in top box drawer.
- One box divider standard in each box drawer.
- One crossrail standard in each file drawer.
- Shelves are only in the cabinet side above the drawer units.
- 42"H units do not include an adjustable shelf in the upper cabinet section.
- 50"H units include one adjustable shelf.
- 65"H units include two adjustable shelves.

! Locking units equipped with HON "One Key" interchangeable core removable locks. Keyed alike core model HF23S, in Satin, must be ordered separately. See page 596.

HOW TO SPECIFY

<p>Select Model Number</p> <p>H S T P 6 5 2 4 2 4 L F F L .</p>	<p>Select Base</p> <p>BX Recessed Plinth</p> <p>B X .</p>	<p>Select Pull</p> <p>A Arch PRO Silver S Square PR6 Silver</p> <p>A P R O .</p>	<p>Select Case Paint</p> <p>See page 583</p> <p>P J W .</p>	<p>Select Front Laminate</p> <p>See page 583 L2 upcharge (+ \$37)</p> <p>L S A 1 .</p>	<p>Select Lock</p> <p>L Standard Lock X Omit Lock (- \$20) EBNL eLock (+ \$340)</p> <p>L</p>
--	--	---	--	---	---



Icon Legend on page 19

Metal Side Access Towers with Laminate Fronts

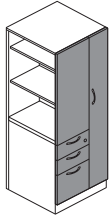

DESCRIPTION	MODEL	SHIP WEIGHT	CUBE	LIST PRICE BY PAINT GRADE		
				P1	P2	P3
Side Access Tower with Laminate Fronts, Shelves/Box/Box/File						
65”H x 24”W x 24”D, Wardrobe Left	HSTSP652424LBBFL	178	27.2	\$3290	\$3371	\$3442
65”H x 24”W x 24”D, Wardrobe Right	HSTSP652424RBBFL	178	27.2	\$3290	\$3371	\$3442
50”H x 24”W x 24”D, Wardrobe Left	HSTSP502424LBBFL	146	21.2	\$3079	\$3160	\$3231
50”H x 24”W x 24”D, Wardrobe Right	HSTSP502424RBBFL	146	21.2	\$3079	\$3160	\$3231
42”H x 24”W x 24”D, Wardrobe Left	HSTSP422424LBBFL	132	16.8	\$2778	\$2831	\$2909
42”H x 24”W x 24”D, Wardrobe Right	HSTSP422424RBBFL	132	16.8	\$2778	\$2831	\$2909

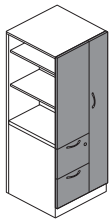

Side Access Tower with Laminate Fronts, Shelves/File/File						
65”H x 24”W x 24”D, Wardrobe Left	HSTSP652424LFFL	178	27.2	\$3224	\$3305	\$3376
65”H x 24”W x 24”D, Wardrobe Right	HSTSP652424RFFL	178	27.2	\$3224	\$3305	\$3376
50”H x 24”W x 24”D, Wardrobe Left	HSTSP502424LFFL	146	21.2	\$3014	\$3095	\$3166
50”H x 24”W x 24”D, Wardrobe Right	HSTSP502424RFFL	146	21.2	\$3014	\$3095	\$3166
42”H x 24”W x 24”D, Wardrobe Left	HSTSP422424LFFL	132	16.8	\$2712	\$2765	\$2843
42”H x 24”W x 24”D, Wardrobe Right	HSTSP422424RFFL	132	16.8	\$2712	\$2765	\$2843

STORAGE

NOTES:

- Towers can be used to support a worksurface. In order to do so, order bracket model HSTB2W1.
- Metal chassis with laminate drawer/door fronts.
- Steel frame provides durability.
- Leveling glides can be adjusted from outside or inside the case.
- Heavy-duty, telescoping ball-bearing slides.
- Baked, epoxy/polyester, powder coating finish.
- One lock secures doors and drawers.
- Pencil tray standard in top box drawer.
- One box divider standard in each box drawer.
- One crossrail standard in each file drawer.

ⓘ Locking units equipped with HON “One Key” interchangeable core removable locks. Keyed alike core model HF23S, in Satin, must be ordered separately. See page 596.

HOW TO SPECIFY

<p>Select Model Number</p> <p>H S T S P 6 5 2 4 2 4 L F F L .</p>	<p>Select Base</p> <p>BX Recessed Plinth</p> <p>B X .</p>	<p>Select Pull</p> <p>A Arch PRO Silver S Square PR6 Silver</p> <p>A P R O .</p>	<p>Select Case Paint</p> <p>See page 583</p> <p>P J W .</p>	<p>Select Front Laminate</p> <p>See page 583 L2 upcharge (+ \$37)</p> <p>L S A 1 .</p>	<p>Select Lock</p> <p>L Standard Lock X Omit Lock (- \$20) EBNL eLock (+ \$340)</p> <p>L</p>
--	--	---	--	---	---

CONTAIN[®] Footed Metal Personal Towers

GSA SIN 33721



Icon Legend on page 19

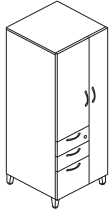

DESCRIPTION	MODEL	SHIP WEIGHT	CUBE	LIST PRICE BY CASE PAINT GRADE		
				P1	P2	P3
Footed Personal Tower with Metal Fronts, Door/Box/Box/File						
65"H x 24"W x 24"D, Wardrobe Left	HSTF652424LBBFM	178	25.8	\$2870	\$2951	\$3022
65"H x 24"W x 24"D, Wardrobe Right	HSTF652424RBBFM	178	25.8	\$2870	\$2951	\$3022
50"H x 24"W x 24"D, Wardrobe Left	HSTF502424LBBFM	146	19.8	\$2699	\$2780	\$2851
50"H x 24"W x 24"D, Wardrobe Right	HSTF502424RBBFM	146	19.8	\$2699	\$2780	\$2851
42"H x 24"W x 24"D, Wardrobe Left	HSTF422424LBBFM	132	18.2	\$2339	\$2392	\$2470
42"H x 24"W x 24"D, Wardrobe Right	HSTF422424RBBFM	132	18.2	\$2339	\$2392	\$2470

STORAGE

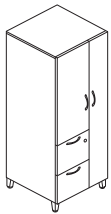

DESCRIPTION	MODEL	SHIP WEIGHT	CUBE	LIST PRICE BY CASE PAINT GRADE		
				P1	P2	P3
Footed Personal Tower with Metal Fronts, Door/File/File						
65"H x 24"W x 24"D, Wardrobe Left	HSTF652424LFFM	178	25.8	\$2804	\$2885	\$2956
65"H x 24"W x 24"D, Wardrobe Right	HSTF652424RFFM	178	25.8	\$2804	\$2885	\$2956
50"H x 24"W x 24"D, Wardrobe Left	HSTF502424LFFM	146	19.8	\$2631	\$2712	\$2783
50"H x 24"W x 24"D, Wardrobe Right	HSTF502424RFFM	146	19.8	\$2631	\$2712	\$2783
42"H x 24"W x 24"D, Wardrobe Left	HSTF422424LFFM	132	18.2	\$2273	\$2326	\$2404
42"H x 24"W x 24"D, Wardrobe Right	HSTF422424RFFM	132	18.2	\$2273	\$2326	\$2404

NOTES:

- Metal chassis and drawer fronts.
- Steel frame provides durability.
- Leveling glides can be adjusted from outside or inside the case.
- Heavy-duty, telescoping ball-bearing slides.
- Baked, epoxy/polyester, powder coating finish.
- One lock secures doors and drawers.
- Pencil tray standard in top box drawer.
- One box divider standard in each box drawer.
- One crossrail standard in each file drawer.
- Shelves are only in the cabinet side above the drawer units.
- 42"H units do not include an adjustable shelf in the upper cabinet section.
- 50"H units include one adjustable shelf.
- 65"H units include two adjustable shelves.

ⓘ Locking units equipped with HON "One Key" interchangeable core removable locks. Keyed alike core model HF23S, in Satin, must be ordered separately. See page 596.

HOW TO SPECIFY

Select Model Number H S T F 4 2 2 4 2 4 L B B F M .	Select Foot SF Contain Foot T1 Platinum Metallic PR6 Silver	Select Pull A Arch PRO Silver R Radius N Integral S Square PR6 Silver	Select Case Paint See page 583 P J W .	Select Front Paint See page 583 NA Matches Case (+ \$0) P1 upcharge (+ \$157) P2 upcharge (+ \$178) P3 upcharge (+ \$199)	Select Lock L Standard Lock X Omit Lock (- \$20) EBNL eLock (+ \$340)
---	---	--	---	---	---



Icon Legend on page 19

Footed Metal Side Access Towers

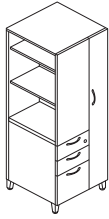

DESCRIPTION	MODEL	SHIP WEIGHT	CUBE	LIST PRICE BY CASE PAINT GRADE		
				P1	P2	P3
Footed Side Access Tower with Metal Fronts, Shelves/Box/Box/File						
65”H x 24”W x 24”D, Wardrobe Left	HSTSF652424LBBFM	178	25.8	\$3031	\$3112	\$3183
65”H x 24”W x 24”D, Wardrobe Right	HSTSF652424RBBFM	178	25.8	\$3031	\$3112	\$3183
50”H x 24”W x 24”D, Wardrobe Left	HSTSF502424LBBFM	146	19.8	\$2848	\$2929	\$3000
50”H x 24”W x 24”D, Wardrobe Right	HSTSF502424RBBFM	146	19.8	\$2848	\$2929	\$3000
42”H x 24”W x 24”D, Wardrobe Left	HSTSF422424LBBFM	132	18.2	\$2587	\$2640	\$2718
42”H x 24”W x 24”D, Wardrobe Right	HSTSF422424RBBFM	132	18.2	\$2587	\$2640	\$2718

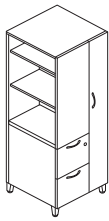

DESCRIPTION	MODEL	SHIP WEIGHT	CUBE	LIST PRICE BY CASE PAINT GRADE		
				P1	P2	P3
Footed Side Access Tower with Metal Fronts, Shelves/File/File						
65”H x 24”W x 24”D, Wardrobe Left	HSTSF652424LFFM	178	25.8	\$2965	\$3046	\$3117
65”H x 24”W x 24”D, Wardrobe Right	HSTSF652424RFFM	178	25.8	\$2965	\$3046	\$3117
50”H x 24”W x 24”D, Wardrobe Left	HSTSF502424LFFM	146	19.8	\$2780	\$2861	\$2932
50”H x 24”W x 24”D, Wardrobe Right	HSTSF502424RFFM	146	19.8	\$2780	\$2861	\$2932
42”H x 24”W x 24”D, Wardrobe Left	HSTSF422424LFFM	132	18.2	\$2520	\$2573	\$2651
42”H x 24”W x 24”D, Wardrobe Right	HSTSF422424RFFM	132	18.2	\$2520	\$2573	\$2651

STORAGE

NOTES:

- Towers can be used to support a worksurface. In order to do so, order bracket model HSTB2W1.
- Metal chassis and drawer fronts.
- Steel frame provides durability.
- Leveling glides can be adjusted from outside or inside the case.
- Heavy-duty, telescoping ball-bearing slides.
- Baked, epoxy/polyester, powder coating finish.
- One lock secures doors and drawers.
- Pencil tray standard in top box drawer.
- One box divider standard in each box drawer.
- One crossrail standard in each file drawer.

ⓘ Locking units equipped with HON “One Key” interchangeable core removable locks. Keyed alike core model HF23S, in Satin, must be ordered separately. See page 596.

HOW TO SPECIFY

<p>Select Model Number</p> <p>H S T S F 4 2 2 4 2 4 R B B F M</p>	<p>Select Foot</p> <p>SF Contain Foot T1 Platinum Metallic PR6 Silver</p> <p>S F T 1</p>	<p>Select Pull</p> <p>A Arch PRO Silver R Radius N Integral S Square PR6 Silver</p> <p>A P R O</p>	<p>Select Case Paint</p> <p>See page 583</p> <p>P J W</p>	<p>Select Front Paint</p> <p>See page 583 NA Matches Case (+ \$0) P1 upcharge (+ \$157) P2 upcharge (+ \$178) P3 upcharge (+ \$199)</p> <p>N A</p>	<p>Select Panel Paint</p> <p>NA Matches Case</p> <p>N A</p>	<p>Select Lock</p> <p>L Standard Lock X Omit Lock (- \$20) EBNL eLock (+ \$340)</p> <p>L</p>
--	---	---	--	---	--	---

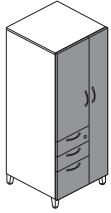

DESCRIPTION	MODEL	SHIP WEIGHT	CUBE	LIST PRICE BY PAINT GRADE		
				P1	P2	P3
Footed Personal Tower with Laminate Fronts, Door/Box/Box/File						
65"H x 24"W x 24"D, Wardrobe Left	HSTF652424LBBFL	178	25.8	\$3266	\$3347	\$3418
65"H x 24"W x 24"D, Wardrobe Right	HSTF652424RBBFL	178	25.8	\$3266	\$3347	\$3418
50"H x 24"W x 24"D, Wardrobe Left	HSTF502424LBBFL	146	19.8	\$3068	\$3149	\$3220
50"H x 24"W x 24"D, Wardrobe Right	HSTF502424RBBFL	146	19.8	\$3068	\$3149	\$3220
42"H x 24"W x 24"D, Wardrobe Left	HSTF422424LBBFL	132	18.2	\$2656	\$2709	\$2787
42"H x 24"W x 24"D, Wardrobe Right	HSTF422424RBBFL	132	18.2	\$2656	\$2709	\$2787

STORAGE

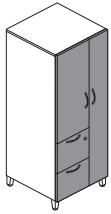

DESCRIPTION	MODEL	SHIP WEIGHT	CUBE	LIST PRICE BY PAINT GRADE		
				P1	P2	P3
Footed Personal Tower with Laminate Fronts, Door/File/File						
65"H x 24"W x 24"D, Wardrobe Left	HSTF652424LFFL	178	25.8	\$3199	\$3280	\$3351
65"H x 24"W x 24"D, Wardrobe Right	HSTF652424RFFL	178	25.8	\$3199	\$3280	\$3351
50"H x 24"W x 24"D, Wardrobe Left	HSTF502424LFFL	146	19.8	\$3000	\$3081	\$3152
50"H x 24"W x 24"D, Wardrobe Right	HSTF502424RFFL	146	19.8	\$3000	\$3081	\$3152
42"H x 24"W x 24"D, Wardrobe Left	HSTF422424LFFL	132	18.2	\$2590	\$2643	\$2721
42"H x 24"W x 24"D, Wardrobe Right	HSTF422424RFFL	132	18.2	\$2590	\$2643	\$2721

NOTES:

- Metal chassis with laminate drawer/door fronts.
- Steel frame provides durability.
- Leveling glides can be adjusted from outside or inside the case.
- Heavy-duty, telescoping ball-bearing slides.
- Baked, epoxy/polyester, powder coating finish.
- One lock secures doors and drawers.
- Pencil tray standard in top box drawer.
- One box divider standard in each box drawer.
- One crossrail standard in each file drawer.
- Shelves are only in the cabinet side above the drawer units.
- 42"H units do not include an adjustable shelf in the upper cabinet section.
- 50"H units include one adjustable shelf.
- 65"H units include two adjustable shelves.

ⓘ Locking units equipped with HON "One Key" interchangeable core removable locks. Keyed alike core model HF23S, in Satin, must be ordered separately. See page 596.

HOW TO SPECIFY

Select Model Number	Select Foot	Select Pull	Select Case Paint	Select Front Laminate	Select Lock
SF Contain Foot T1 Platinum Metallic PR6 Silver	A Arch PRO Silver S Square PR6 Silver	See page 583	See page 583 L2 upcharge (+ \$37)	L Standard Lock X Omit Lock (- \$20) EBNL eLock (+ \$340)	
HSTF652424LBBFL	SFT1	APRO	PJW	LSA1	L



Icon Legend on page 19

Footed Metal Side Access Towers with Laminate Fronts

	DESCRIPTION	MODEL	SHIP WEIGHT	CUBE	LIST PRICE BY PAINT GRADE		
					P1	P2	P3
	Footed Side Access Tower with Laminate Fronts, Shelves/Box/Box/File						
	65”H x 24”W x 24”D, Wardrobe Left	HSTSF652424LBBFL	178	25.8	\$3452	\$3533	\$3604
	65”H x 24”W x 24”D, Wardrobe Right	HSTSF652424RBBFL	178	25.8	\$3452	\$3533	\$3604
	50”H x 24”W x 24”D, Wardrobe Left	HSTSF502424LBBFL	146	19.8	\$3241	\$3322	\$3393
	50”H x 24”W x 24”D, Wardrobe Right	HSTSF502424RBBFL	146	19.8	\$3241	\$3322	\$3393
	42”H x 24”W x 24”D, Wardrobe Left	HSTSF422424LBBFL	132	18.2	\$2940	\$2993	\$3071
	42”H x 24”W x 24”D, Wardrobe Right	HSTSF422424RBBFL	132	18.2	\$2940	\$2993	\$3071
	Footed Side Access Tower with Laminate Fronts, Shelves/File/File						
	65”H x 24”W x 24”D, Wardrobe Left	HSTSF652424LFFL	178	25.8	\$3384	\$3465	\$3536
	65”H x 24”W x 24”D, Wardrobe Right	HSTSF652424RFFL	178	25.8	\$3384	\$3465	\$3536
	50”H x 24”W x 24”D, Wardrobe Left	HSTSF502424LFFL	146	19.8	\$3174	\$3255	\$3326
	50”H x 24”W x 24”D, Wardrobe Right	HSTSF502424RFFL	146	19.8	\$3174	\$3255	\$3326
	42”H x 24”W x 24”D, Wardrobe Left	HSTSF422424LFFL	132	18.2	\$2871	\$2924	\$3002
	42”H x 24”W x 24”D, Wardrobe Right	HSTSF422424RFFL	132	18.2	\$2871	\$2924	\$3002
	Tower Kickplates (Field Installable)						
	For 24” Tower, Left	HSTAKL	2	0.3	\$216	\$225	\$230
	For 24” Tower, Right	HSTAKR	2	0.3	\$216	\$225	\$230
	Specify: Model.Paint						
	SPECIFYING EXAMPLE: HSATKL.P						

STORAGE

NOTES:

- Towers can be used to support a worksurface. In order to do so, order bracket model HSTB2W1.
- Metal chassis with laminate drawer/door fronts.
- Steel frame provides durability.
- Leveling glides can be adjusted from outside or inside the case.
- Heavy-duty, telescoping ball-bearing slides.
- Baked, epoxy/polyester, powder coating finish.
- One lock secures doors and drawers.
- Pencil tray standard in top box drawer.
- One box divider standard in each box drawer.
- One crossrail standard in each file drawer.
- Shelves are only in the cabinet side above the drawer units.
- 42”H units do not include an adjustable shelf in the upper cabinet section.
- 50”H units include one adjustable shelf.
- 65”H units include two adjustable shelves.

ⓘ Locking units equipped with HON “One Key” interchangeable core removable locks. Keyed alike core model HF23S, in Satin, must be ordered separately. See page 596.

HOW TO SPECIFY

Select Model Number	Select Foot	Select Pull	Select Case Paint	Select Front Laminate	Select Lock
	SF Contain Foot T1 Platinum Metallic PR6 Silver	A Arch PRO Silver S Square PR6 Silver	See page 583	See page 583 L2 upcharge (+ \$37)	L Standard Lock X Omit Lock (- \$20) EBNL eLock (+ \$340)
HSTSF652424LBBFL	SFT1	APRO	PJW	LSA1	L

CONTAIN[®] 18"W Slim Metal Personal Towers

GSA SIN 33721



Icon Legend on page 19

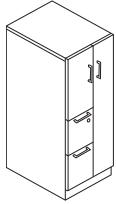

DESCRIPTION	MODEL	SHIP WEIGHT	CUBE	LIST PRICE BY CASE PAINT GRADE		
				P1	P2	P3
18" W Slim Personal Tower, Plinth w/Metal Fronts						
65"H x 18"W x 24"D, Left Hand	HSTP651824LFFM	148	19.4	\$2327	\$2408	\$2479
65"H x 18"W x 24"D, Right Hand	HSTP651824RFFM	148	19.4	\$2327	\$2408	\$2479
50"H x 18"W x 24"D, Left Hand	HSTP501824LFFM	121	16.0	\$2174	\$2255	\$2326
50"H x 18"W x 24"D, Right Hand	HSTP501824RFFM	121	16.0	\$2174	\$2255	\$2326
42"H x 18"W x 24"D, Left Hand	HSTP421824LFFM	109	13.7	\$1859	\$1912	\$1990
42"H x 18"W x 24"D, Right Hand	HSTP421824RFFM	109	13.7	\$1859	\$1912	\$1990

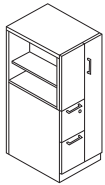

DESCRIPTION	MODEL	SHIP WEIGHT	CUBE	LIST PRICE BY CASE PAINT GRADE		
				P1	P2	P3
18" W Slim Side Access Tower, Plinth, Metal Fronts						
65"H x 18"W x 24"D, Left Hand	HSTSP651824LFFM	148	19.4	\$2466	\$2547	\$2618
65"H x 18"W x 24"D, Right Hand	HSTSP651824RFFM	148	19.4	\$2466	\$2547	\$2618
50"H x 18"W x 24"D, Left Hand	HSTSP501824LFFM	121	16.0	\$2308	\$2389	\$2460
50"H x 18"W x 24"D, Right Hand	HSTSP501824RFFM	121	16.0	\$2308	\$2389	\$2460
42"H x 18"W x 24"D, Left Hand	HSTSP421824LFFM	109	13.7	\$2076	\$2129	\$2207
42"H x 18"W x 24"D, Right Hand	HSTSP421824RFFM	109	13.7	\$2076	\$2129	\$2207

NOTES:

- Towers can be used to support a worksurface. In order to do so, order bracket model HSTB2W1.
- Metal chassis and drawer fronts.
- Steel frame provides durability.
- Leveling glides can be adjusted from outside or inside the case.
- Heavy-duty, telescoping ball-bearing slides.
- Baked, epoxy/polyester, powder coating finish.
- One lock secures doors and drawers.
- One crossrail standard in each file drawer.
- Shelves are only in the cabinet side above the drawer units.
- 42"H units do not include an adjustable shelf in the upper cabinet section.
- 50"H units include one adjustable shelf.
- 65"H units include two adjustable shelves.

ⓘ Locking units equipped with HON "One Key" interchangeable core removable locks. Keyed alike core model HF23S, in Satin, must be ordered separately. See page 596.

HOW TO SPECIFY

Select Model Number	Select Base	Select Pull	Select Case Paint	Select Front Paint	Select Lock
	BK Flush Plinth BX Recessed Plinth	A Arch PRO Silver S Square PR6 Silver	See page 583	See page 583 NA Matches Case (+ \$0) P1 upcharge (+ \$157) P2 upcharge (+ \$178) P3 upcharge (+ \$199)	L Standard Lock X Omit Lock (- \$20) EBNL eLock (+ \$340)
HSTP651824LFFM.	BX.	APRO.	PJW.	NA.	L.

Select Model Number	Select Base	Select Pull	Select Case Paint	Select Front Paint	Select Panel Paint	Select Lock
	BK Flush Plinth BX Recessed Plinth	A Arch PRO Silver S Square PR6 Silver	See page 583	See page 583 NA Matches Case (+ \$0) P1 upcharge (+ \$157) P2 upcharge (+ \$178) P3 upcharge (+ \$199)	NA Matches Case	L Standard Lock X Omit Lock (- \$20) EBNL eLock (+ \$340)
HSTSP651824LFFM.	BX.	APRO.	PJW.	NA.	NA.	L.



Icon Legend on page 19

18"W Slim Metal Personal Towers

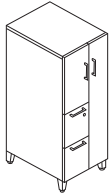

DESCRIPTION	MODEL	SHIP WEIGHT	CUBE	LIST PRICE BY CASE PAINT GRADE		
				P1	P2	P3
18" W Slim Personal Tower, Footed w/Metal Fronts						
65"H x 18"W x 24"D, Left Hand	HSTF651824LFFM	148	19.4	\$2488	\$2569	\$2640
65"H x 18"W x 24"D, Right Hand	HSTF651824RFFM	148	19.4	\$2488	\$2569	\$2640
50"H x 18"W x 24"D, Left Hand	HSTF501824LFFM	121	14.9	\$2335	\$2416	\$2487
50"H x 18"W x 24"D, Right Hand	HSTF501824RFFM	121	14.9	\$2335	\$2416	\$2487
42"H x 18"W x 24"D, Left Hand	HSTF421824LFFM	109	12.6	\$2020	\$2073	\$2151
42"H x 18"W x 24"D, Right Hand	HSTF421824RFFM	109	12.6	\$2020	\$2073	\$2151

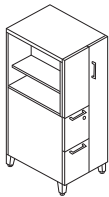

DESCRIPTION	MODEL	SHIP WEIGHT	CUBE	LIST PRICE BY CASE PAINT GRADE		
				P1	P2	P3
18" W Slim Side Access Tower, Footed w/Metal Fronts						
65"H x 18"W x 24"D, Left Hand	HSTSF651824LFFM	148	19.4	\$2629	\$2710	\$2781
65"H x 18"W x 24"D, Right Hand	HSTSF651824RFFM	148	19.4	\$2629	\$2710	\$2781
50"H x 18"W x 24"D, Left Hand	HSTSF501824LFFM	121	14.9	\$2466	\$2547	\$2618
50"H x 18"W x 24"D, Right Hand	HSTSF501824RFFM	121	14.9	\$2466	\$2547	\$2618
42"H x 18"W x 24"D, Left Hand	HSTSF421824LFFM	109	12.6	\$2237	\$2290	\$2368
42"H x 18"W x 24"D, Right Hand	HSTSF421824RFFM	109	12.6	\$2237	\$2290	\$2368

STORAGE

NOTES:

- Towers can be used to support a worksurface. In order to do so, order bracket model HSTB2W1.
- Metal chassis and drawer fronts.
- Steel frame provides durability.
- Leveling glides can be adjusted from outside or inside the case.
- Heavy-duty, telescoping ball-bearing slides.
- Baked, epoxy/polyester, powder coating finish.
- One lock secures doors and drawers.
- One crossrail standard in each file drawer.
- Shelves are only in the cabinet side above the drawer units.
- 42"H units do not include an adjustable shelf in the upper cabinet section.
- 50"H units include one adjustable shelf.
- 65"H units include two adjustable shelves.

ⓘ Locking units equipped with HON "One Key" interchangeable core removable locks. Keyed alike core model HF23S, in Satin, must be ordered separately. See page 596.

HOW TO SPECIFY

Select Model Number H S T F 6 5 1 8 2 4 L F F M .	Select Foot SF Contain Foot T1 Platinum Metallic PR6 Silver	Select Pull A Arch PRO Silver S Square PR6 Silver	Select Case Paint See page 583	Select Front Paint See page 583 NA Matches Case (+ \$0) P1 upcharge (+ \$157) P2 upcharge (+ \$178) P3 upcharge (+ \$199)	Select Lock L Standard Lock X Omit Lock (- \$20) EBNL eLock (+ \$340)
---	---	--	--	---	---

Select Model Number H S T S F 6 5 1 8 2 4 L F F M .	Select Foot SF Contain Foot T1 Platinum Metallic PR6 Silver	Select Pull A Arch PRO Silver S Square PR6 Silver	Select Case Paint See page 583	Select Front Paint See page 583 NA Matches Case (+ \$0) P1 upcharge (+ \$157) P2 upcharge (+ \$178) P3 upcharge (+ \$199)	Select Panel Paint NA Matches Case	Select Lock L Standard Lock X Omit Lock (- \$20) EBNL eLock (+ \$340)
---	---	--	--	---	--	---

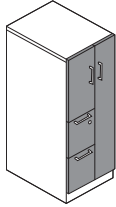

DESCRIPTION	MODEL	SHIP WEIGHT	CUBE	LIST PRICE BY PAINT GRADE		
				P1	P2	P3
18"W Slim Personal Tower, Plinth w/Laminate Fronts						
65"H x 18"W x 24"D, Left Hand	HSTP651824LFFL	148	19.4	\$2675	\$2756	\$2827
65"H x 18"W x 24"D, Right Hand	HSTP651824RFFL	148	19.4	\$2675	\$2756	\$2827
50"H x 18"W x 24"D, Left Hand	HSTP501824LFFL	121	16.0	\$2501	\$2582	\$2653
50"H x 18"W x 24"D, Right Hand	HSTP501824RFFL	121	16.0	\$2501	\$2582	\$2653
42"H x 18"W x 24"D, Left Hand	HSTP421824LFFL	109	13.7	\$2138	\$2191	\$2269
42"H x 18"W x 24"D, Right Hand	HSTP421824RFFL	109	13.7	\$2138	\$2191	\$2269

STORAGE

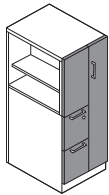

DESCRIPTION	MODEL	SHIP WEIGHT	CUBE	LIST PRICE BY PAINT GRADE		
				P1	P2	P3
18"W Slim Side Access Tower, Plinth, Laminate Fronts						
65"H x 18"W x 24"D, Left Hand	HSTSP651824LFFL	148	19.4	\$2838	\$2919	\$2990
65"H x 18"W x 24"D, Right Hand	HSTSP651824RFFL	148	19.4	\$2838	\$2919	\$2990
50"H x 18"W x 24"D, Left Hand	HSTSP501824LFFL	121	16.0	\$2652	\$2733	\$2804
50"H x 18"W x 24"D, Right Hand	HSTSP501824RFFL	121	16.0	\$2652	\$2733	\$2804
42"H x 18"W x 24"D, Left Hand	HSTSP421824LFFL	109	13.7	\$2387	\$2440	\$2518
42"H x 18"W x 24"D, Right Hand	HSTSP421824RFFL	109	13.7	\$2387	\$2440	\$2518

NOTES:

- Towers can be used to support a worksurface. In order to do so, order bracket model HSTB2W1.
- Metal chassis with laminate drawer/door fronts.
- Steel frame provides durability.
- Leveling glides can be adjusted from outside or inside the case.
- Heavy-duty, telescoping ball-bearing slides.
- Baked, epoxy/polyester, powder coating finish.
- One lock secures doors and drawers.
- One crossrail standard in each file drawer.
- Shelves are only in the cabinet side above the drawer units.
- 42"H units do not include an adjustable shelf in the upper cabinet section.
- 50"H units include one adjustable shelf.
- 65"H units include two adjustable shelves.

! Locking units equipped with HON "One Key" interchangeable core removable locks. Keyed alike core model HF23S, in Satin, must be ordered separately. See page 596.

HOW TO SPECIFY

<p>Select Model Number</p> <p>H S T S P 6 5 1 8 2 4 L F F L .</p>	<p>Select Base</p> <p>BX Recessed Plinth</p> <p>B X .</p>	<p>Select Pull</p> <p>A Arch PRO Silver S Square PR6 Silver</p> <p>A P R O .</p>	<p>Select Case Paint</p> <p>See page 583</p> <p>P J W .</p>	<p>Select Front Laminate</p> <p>See page 583 L2 upcharge (+ \$37)</p> <p>L S A 1 .</p>	<p>Select Lock</p> <p>L Standard Lock X Omit Lock (- \$20) EBNL eLock (+ \$340)</p> <p>L</p>
--	--	---	--	---	---



Icon Legend on page 19

18"W Slim Personal Towers with Laminate Fronts

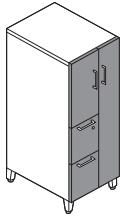

DESCRIPTION

MODEL

SHIP WEIGHT CUBE

LIST PRICE BY PAINT GRADE
P1 P2 P3

18" W Slim Personal Tower, Footed w/Laminate Fronts

65"H x 18"W x 24"D, Left Hand	HSTF651824LFFL	148	19.4	\$2837	\$2918	\$2989
65"H x 18"W x 24"D, Right Hand	HSTF651824RFFL	148	19.4	\$2837	\$2918	\$2989
50"H x 18"W x 24"D, Left Hand	HSTF501824LFFL	121	16.0	\$2660	\$2741	\$2812
50"H x 18"W x 24"D, Right Hand	HSTF501824RFFL	121	16.0	\$2660	\$2741	\$2812
42"H x 18"W x 24"D, Left Hand	HSTF421824LFFL	109	13.7	\$2298	\$2351	\$2429
42"H x 18"W x 24"D, Right Hand	HSTF421824RFFL	109	13.7	\$2298	\$2351	\$2429

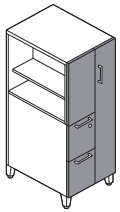

18" W Slim Side Access Tower, Footed, Laminate Fronts

65"H x 18"W x 24"D, Left Hand	HSTSF651824LFFL	148	19.4	\$2997	\$3078	\$3149
65"H x 18"W x 24"D, Right Hand	HSTSF651824RFFL	148	19.4	\$2997	\$3078	\$3149
50"H x 18"W x 24"D, Left Hand	HSTSF501824LFFL	121	14.9	\$2813	\$2894	\$2965
50"H x 18"W x 24"D, Right Hand	HSTSF501824RFFL	121	14.9	\$2813	\$2894	\$2965
42"H x 18"W x 24"D, Left Hand	HSTSF421824LFFL	109	12.6	\$2547	\$2600	\$2678
42"H x 18"W x 24"D, Right Hand	HSTSF421824RFFL	109	12.6	\$2547	\$2600	\$2678

STORAGE

NOTES:

- Towers can be used to support a worksurface. In order to do so, order bracket model HSTB2W1.
- Metal chassis with laminate drawer/door fronts.
- Steel frame provides durability.
- Leveling glides can be adjusted from outside or inside the case.
- Heavy-duty, telescoping ball-bearing slides.
- Baked, epoxy/polyester, powder coating finish.
- One lock secures doors and drawers.
- One crossrail standard in each file drawer.
- Shelves are only in the cabinet side above the drawer units.
- 42"H units do not include an adjustable shelf in the upper cabinet section.
- 50"H units include one adjustable shelf.
- 65"H units include two adjustable shelves.

! Locking units equipped with HON "One Key" interchangeable core removable locks. Keyed alike core model HF23S, in Satin, must be ordered separately. See page 596.

HOW TO SPECIFY

<p>Select Model Number</p> <p>H S T S F 6 5 1 8 2 4 L F F L .</p>	<p>Select Foot</p> <p>SF Contain Foot T1 Platinum Metallic PR6 Silver</p> <p>S F T 1 .</p>	<p>Select Pull</p> <p>A Arch PRO Silver S Square PR6 Silver</p> <p>A P R O .</p>	<p>Select Case Paint</p> <p>See page 583</p> <p>P J W .</p>	<p>Select Front Laminate</p> <p>See page 583 L2 upcharge (+ \$37)</p> <p>L S A 1 .</p>	<p>Select Lock</p> <p>L Standard Lock X Omit Lock (- \$20) EBNL eLock (+ \$340)</p> <p>L</p>
--	---	---	--	---	---

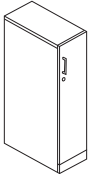

DESCRIPTION	MODEL	SHIP WEIGHT	CUBE	LIST PRICE BY CASE PAINT GRADE		
				P1	P2	P3
Wardrobe Tower, Plinth w/Metal Fronts						
65"H x 12"W x 24"D, Right Hand	HSWP651224RM	108	14.8	\$1494	\$1575	\$1646
65"H x 12"W x 24"D, Left Hand	HSWP651224LM	108	14.8	\$1494	\$1575	\$1646
50"H x 12"W x 24"D, Right Hand	HSWP501224RM	87	11.5	\$1382	\$1463	\$1534
50"H x 12"W x 24"D, Left Hand	HSWP501224LM	87	11.5	\$1382	\$1463	\$1534
42"H x 12"W x 24"D, Right Hand	HSWP421224RM	77	9.9	\$1154	\$1207	\$1285
42"H x 12"W x 24"D, Left Hand	HSWP421224LM	77	9.9	\$1154	\$1207	\$1285
Wardrobe Tower, Footed w/Metal Fronts						
65"H x 12"W x 18"D, Right Hand	HSWP651218RM	108	14.8	\$1370	\$1451	\$1522
65"H x 12"W x 18"D, Left Hand	HSWP651218LM	108	14.8	\$1370	\$1451	\$1522
50"H x 12"W x 18"D, Right Hand	HSWP501218RM	87	11.5	\$1269	\$1350	\$1421
50"H x 12"W x 18"D, Left Hand	HSWP501218LM	87	11.5	\$1269	\$1350	\$1421
42"H x 12"W x 18"D, Right Hand	HSWP421218RM	77	9.9	\$1060	\$1113	\$1191
42"H x 12"W x 18"D, Left Hand	HSWP421218LM	77	9.9	\$1060	\$1113	\$1191

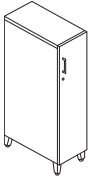

Wardrobe Tower, Footed w/Metal Fronts						
65"H x 12"W x 24"D, Right Hand	HSWF651224RM	108	14.1	\$1656	\$1737	\$1808
65"H x 12"W x 24"D, Left Hand	HSWF651224LM	108	14.1	\$1656	\$1737	\$1808
50"H x 12"W x 24"D, Right Hand	HSWF501224RM	87	10.8	\$1545	\$1626	\$1697
50"H x 12"W x 24"D, Left Hand	HSWF501224LM	87	10.8	\$1545	\$1626	\$1697
42"H x 12"W x 24"D, Right Hand	HSWF421224RM	77	9.1	\$1316	\$1369	\$1447
42"H x 12"W x 24"D, Left Hand	HSWF421224LM	77	9.1	\$1316	\$1369	\$1447
Wardrobe Tower, Footed w/Metal Fronts						
65"H x 12"W x 18"D, Right Hand	HSWF651218RM	108	11.0	\$1532	\$1613	\$1684
65"H x 12"W x 18"D, Left Hand	HSWF651218LM	108	11.0	\$1532	\$1613	\$1684
50"H x 12"W x 18"D, Right Hand	HSWF501218RM	87	8.4	\$1430	\$1511	\$1582
50"H x 12"W x 18"D, Left Hand	HSWF501218LM	87	8.4	\$1430	\$1511	\$1582
42"H x 12"W x 18"D, Right Hand	HSWF421218RM	77	7.1	\$1220	\$1273	\$1351
42"H x 12"W x 18"D, Left Hand	HSWF421218LM	77	7.1	\$1220	\$1273	\$1351

NOTES: Wardrobes come installed with a rod accessory to accept clothing hangars or a Fuse™ work tool coat hook can be added (sold separately). Wardrobes have slots cut into the inner liner that allow the user to hang Fuse™ work tool accessories inside the unit. 42"H wardrobes have 2 slots; 50"H and 65"H wardrobes have 4 slots. Wardrobes ship with one adjustable shelf. 42"H and 50"H wardrobes have 3 shelf locations; 65"H wardrobes have 6 shelf locations.

NOTES:

- 1 18"D Wardrobes: 42"H and 50"H plinth wardrobes can be freestanding. 18"D footed units must be attached to a panel, worksurface, or ganged to another unit.
- 1 24"D Wardrobes: 42"H and 50"H plinth and footed wardrobes can be freestanding.
- 1 65"H Wardrobes: 18"D and 24"D must be attached to a panel, worksurface, or ganged to another unit.

HOW TO SPECIFY

<p>Select Model Number</p> <p>HSWF651224RM</p>	<p>Select Base/Foot</p> <p>BK Flush Plinth BX Recessed Plinth SF Contain Foot T1 Platinum Metallic PR6 Silver</p> <p>SFT1</p>	<p>Select Pull</p> <p>A Arch PRO Silver N Integral S Square PR6 Silver</p> <p>APRO</p>	<p>Select Case Paint</p> <p>See page 583</p> <p>PJW</p>	<p>Select Front Paint</p> <p>See page 583 NA Matches Case (+ \$0) P1 upcharge (+ \$157) P2 upcharge (+ \$178) P3 upcharge (+ \$199)</p> <p>NA</p>	<p>Select Lock</p> <p>L Standard Lock X Omit Lock (- \$20)</p> <p>L</p>
---	--	---	--	--	---



Icon Legend on page 19

CONTAIN® Wardrobes with eLock

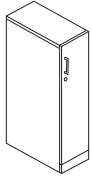

DESCRIPTION	MODEL	SHIP WEIGHT	CUBE	LIST PRICE BY CASE PAINT GRADE		
				P1	P2	P3
Wardrobe Tower, Plinth w/Metal Fronts						
65”H x 12”W x 24”D, Right Hand	HSWP651224RME	108	14.8	\$1849	\$1930	\$2001
65”H x 12”W x 24”D, Left Hand	HSWP651224LME	108	14.8	\$1849	\$1930	\$2001
50”H x 12”W x 24”D, Right Hand	HSWP501224RME	87	11.5	\$1737	\$1818	\$1889
50”H x 12”W x 24”D, Left Hand	HSWP501224LME	87	11.5	\$1737	\$1818	\$1889
42”H x 12”W x 24”D, Right Hand	HSWP421224RME	77	9.9	\$1509	\$1562	\$1640
42”H x 12”W x 24”D, Left Hand	HSWP421224LME	77	9.9	\$1509	\$1562	\$1640
Wardrobe Tower, Footed w/Metal Fronts						
65”H x 12”W x 18”D, Right Hand	HSWP651218RME	108	14.8	\$1726	\$1807	\$1878
65”H x 12”W x 18”D, Left Hand	HSWP651218LME	108	14.8	\$1726	\$1807	\$1878
50”H x 12”W x 18”D, Right Hand	HSWP501218RME	87	11.5	\$1624	\$1705	\$1776
50”H x 12”W x 18”D, Left Hand	HSWP501218LME	87	11.5	\$1624	\$1705	\$1776
42”H x 12”W x 18”D, Right Hand	HSWP421218RME	77	9.9	\$1415	\$1468	\$1546
42”H x 12”W x 18”D, Left Hand	HSWP421218LME	77	9.9	\$1415	\$1468	\$1546

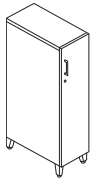

Wardrobe Tower, Footed w/Metal Fronts						
65”H x 12”W x 24”D, Right Hand	HSWF651224RME	108	14.1	\$2011	\$2092	\$2163
65”H x 12”W x 24”D, Left Hand	HSWF651224LME	108	14.1	\$2011	\$2092	\$2163
50”H x 12”W x 24”D, Right Hand	HSWF501224RME	87	10.8	\$1900	\$1981	\$2052
50”H x 12”W x 24”D, Left Hand	HSWF501224LME	87	10.8	\$1900	\$1981	\$2052
42”H x 12”W x 24”D, Right Hand	HSWF421224RME	77	9.1	\$1671	\$1724	\$1802
42”H x 12”W x 24”D, Left Hand	HSWF421224LME	77	9.1	\$1671	\$1724	\$1802
Wardrobe Tower, Footed w/Metal Fronts						
65”H x 12”W x 18”D, Right Hand	HSWF651218RME	108	11.0	\$1888	\$1969	\$2040
65”H x 12”W x 18”D, Left Hand	HSWF651218LME	108	11.0	\$1888	\$1969	\$2040
50”H x 12”W x 18”D, Right Hand	HSWF501218RME	87	8.4	\$1785	\$1866	\$1937
50”H x 12”W x 18”D, Left Hand	HSWF501218LME	87	8.4	\$1785	\$1866	\$1937
42”H x 12”W x 18”D, Right Hand	HSWF421218RME	77	7.1	\$1575	\$1628	\$1706
42”H x 12”W x 18”D, Left Hand	HSWF421218LME	77	7.1	\$1575	\$1628	\$1706

NOTES: Wardrobes come installed with a rod accessory to accept clothing hangars or a Fuse™ work tool coat hook can be added (sold separately). Wardrobes have slots cut into the inner liner that allow the user to hang Fuse™ work tool accessories inside the unit. 42”H wardrobes have 2 slots; 50”H and 65”H wardrobes have 4 slots. Wardrobes ship with one adjustable shelf. 42”H and 50”H wardrobes have 3 shelf locations; 65”H wardrobes have 6 shelf locations.

NOTES:

- 1 18”D Wardrobes: 42”H and 50”H plinth wardrobes can be freestanding. 18”D footed units must be attached to a panel, worksurface, or ganged to another unit.
- 1 24”D Wardrobes: 42”H and 50”H plinth and footed wardrobes can be freestanding.
- 1 65”H Wardrobes: 18”D and 24”D must be attached to a panel, worksurface, or ganged to another unit.

HOW TO SPECIFY

<p>Select Model Number</p> <p>HSWF651224RME</p>	<p>Select Base/Foot</p> <p>BK Flush Plinth BX Recessed Plinth SF Contain Foot T1 Platinum Metallic PR6 Silver</p> <p>SFT1</p>	<p>Select Pull</p> <p>E Keypad Electronic D RFID Electronic Lock Pull</p> <p>D</p>	<p>Select Case Paint</p> <p>See page 583</p> <p>PJW</p>	<p>Select Front Paint</p> <p>See page 583</p> <p>NA Matches Case (+ \$0) P1 upcharge (+ \$157) P2 upcharge (+ \$178) P3 upcharge (+ \$199)</p> <p>NA</p>
---	--	---	---	--

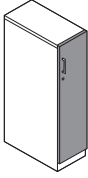

DESCRIPTION	MODEL	SHIP WEIGHT	CUBE	LIST PRICE BY PAINT GRADE		
				P1	P2	P3
Wardrobe Tower, Plinth w/Laminate Fronts						
65"H x 12"W x 24"D, Right Hand	HSWP651224RL	108	14.8	\$1718	\$1799	\$1870
65"H x 12"W x 24"D, Left Hand	HSWP651224LL	108	14.8	\$1718	\$1799	\$1870
50"H x 12"W x 24"D, Right Hand	HSWP501224RL	87	11.5	\$1591	\$1672	\$1743
50"H x 12"W x 24"D, Left Hand	HSWP501224LL	87	11.5	\$1591	\$1672	\$1743
42"H x 12"W x 24"D, Right Hand	HSWP421224RL	77	9.9	\$1328	\$1381	\$1459
42"H x 12"W x 24"D, Left Hand	HSWP421224LL	77	9.9	\$1328	\$1381	\$1459
Wardrobe Tower, 18"D w/Laminate Fronts						
65"H x 12"W x 18"D, Right Hand	HSWP651218RL	108	11.6	\$1576	\$1657	\$1728
65"H x 12"W x 18"D, Left Hand	HSWP651218LL	108	11.6	\$1576	\$1657	\$1728
50"H x 12"W x 18"D, Right Hand	HSWP501218RL	87	9.0	\$1459	\$1540	\$1611
50"H x 12"W x 18"D, Left Hand	HSWP501218LL	87	9.0	\$1459	\$1540	\$1611
42"H x 12"W x 18"D, Right Hand	HSWP421218RL	77	7.7	\$1218	\$1271	\$1349
42"H x 12"W x 18"D, Left Hand	HSWP421218LL	77	7.7	\$1218	\$1271	\$1349

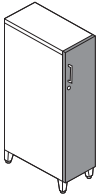

Wardrobe Tower, Footed w/Laminate Fronts						
65"H x 12"W x 24"D, Right Hand	HSWF651224RL	108	14.1	\$1879	\$1960	\$2031
65"H x 12"W x 24"D, Left Hand	HSWF651224LL	108	14.1	\$1879	\$1960	\$2031
50"H x 12"W x 24"D, Right Hand	HSWF501224RL	87	10.8	\$1753	\$1834	\$1905
50"H x 12"W x 24"D, Left Hand	HSWF501224LL	87	10.8	\$1753	\$1834	\$1905
42"H x 12"W x 24"D, Right Hand	HSWF421224RL	77	9.1	\$1489	\$1542	\$1620
42"H x 12"W x 24"D, Left Hand	HSWF421224LL	77	9.1	\$1489	\$1542	\$1620
Wardrobe Tower, 18"D w/Laminate Fronts						
65"H x 12"W x 18"D, Right Hand	HSWF651218RL	108	11.0	\$1737	\$1818	\$1889
65"H x 12"W x 18"D, Left Hand	HSWF651218LL	108	11.0	\$1737	\$1818	\$1889
50"H x 12"W x 18"D, Right Hand	HSWF501218RL	87	8.4	\$1620	\$1701	\$1772
50"H x 12"W x 18"D, Left Hand	HSWF501218LL	87	8.4	\$1620	\$1701	\$1772
42"H x 12"W x 18"D, Right Hand	HSWF421218RL	77	7.1	\$1378	\$1431	\$1509
42"H x 12"W x 18"D, Left Hand	HSWF421218LL	77	7.1	\$1378	\$1431	\$1509

NOTES: Wardrobes come installed with a rod accessory to accept clothing hangars or a Fuse™ work tool coat hook can be added (sold separately). Wardrobes have slots cut into the inner liner that allow the user to hang Fuse™ work tool accessories inside the unit. 42"H wardrobes have 2 slots; 50"H and 65"H wardrobes have 4 slots. Wardrobes ship with one adjustable shelf. 42"H and 50"H wardrobes have 3 shelf locations; 65"H wardrobes have 6 shelf locations.

NOTES:

- ❶ 18"D Wardrobes: 42"H and 50"H plinth wardrobes can be freestanding. 18"D footed units must be attached to a panel, worksurface, or ganged to another unit.
- ❷ 24"D Wardrobes: 42"H and 50"H plinth and footed wardrobes can be freestanding.
- ❸ 65"H Wardrobes: 18"D and 24"D must be attached to a panel, worksurface, or ganged to another unit.

HOW TO SPECIFY

<p>Select Model Number</p> <p>HSWF651224RL</p>	<p>Select Base/Foot</p> <p>BX Recessed Plinth SF Contain Foot T1 Platinum Metallic PR6 Silver</p> <p>SFT1</p>	<p>Select Pull</p> <p>A Arch PRO Silver S Square PR6 Silver</p> <p>APRO</p>	<p>Select Case Paint</p> <p>See page 583</p> <p>PJW</p>	<p>Select Front Laminate</p> <p>See page 583 L2 upcharge (+ \$37)</p> <p>LSA1</p>	<p>Select Lock</p> <p>L Standard Lock X Omit Lock (- \$20)</p> <p>L</p>
---	--	--	--	--	--



Icon Legend on page 19

CONTAIN® Wardrobes with eLock

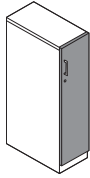

DESCRIPTION

Wardrobe Tower, Plinth w/Laminate Fronts

65”H x 12”W x 24”D, Right Hand
 65”H x 12”W x 24”D, Left Hand
 50”H x 12”W x 24”D, Right Hand
 50”H x 12”W x 24”D, Left Hand
 42”H x 12”W x 24”D, Right Hand
 42”H x 12”W x 24”D, Left Hand

65”H x 12”W x 18”D, Right Hand
 65”H x 12”W x 18”D, Left Hand
 50”H x 12”W x 18”D, Right Hand
 50”H x 12”W x 18”D, Left Hand
 42”H x 12”W x 18”D, Right Hand
 42”H x 12”W x 18”D, Left Hand

MODEL	SHIP WEIGHT	CUBE	LIST PRICE BY PAINT GRADE		
			P1	P2	P3
HSWP651224RLE	108	14.8	\$2074	\$2155	\$2226
HSWP651224LLE	108	14.8	\$2074	\$2155	\$2226
HSWP501224RLE	87	11.5	\$1946	\$2027	\$2098
HSWP501224LLE	87	11.5	\$1946	\$2027	\$2098
HSWP421224RLE	77	9.9	\$1683	\$1736	\$1814
HSWP421224LLE	77	9.9	\$1683	\$1736	\$1814
HSWP651218RLE	108	11.6	\$1932	\$2013	\$2084
HSWP651218LLE	108	11.6	\$1932	\$2013	\$2084
HSWP501218RLE	87	9.0	\$1815	\$1896	\$1967
HSWP501218LLE	87	9.0	\$1815	\$1896	\$1967
HSWP421218RLE	77	7.7	\$1573	\$1626	\$1704
HSWP421218LLE	77	7.7	\$1573	\$1626	\$1704

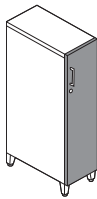

Wardrobe Tower, Footed w/Laminate Fronts

65”H x 12”W x 24”D, Right Hand
 65”H x 12”W x 24”D, Left Hand
 50”H x 12”W x 24”D, Right Hand
 50”H x 12”W x 24”D, Left Hand
 42”H x 12”W x 24”D, Right Hand
 42”H x 12”W x 24”D, Left Hand

65”H x 12”W x 18”D, Right Hand
 65”H x 12”W x 18”D, Left Hand
 50”H x 12”W x 18”D, Right Hand
 50”H x 12”W x 18”D, Left Hand
 42”H x 12”W x 18”D, Right Hand
 42”H x 12”W x 18”D, Left Hand

HSWF651224RLE	108	14.1	\$2235	\$2316	\$2387
HSWF651224LLE	108	14.1	\$2235	\$2316	\$2387
HSWF501224RLE	87	10.8	\$2108	\$2189	\$2260
HSWF501224LLE	87	10.8	\$2108	\$2189	\$2260
HSWF421224RLE	77	9.1	\$1844	\$1897	\$1975
HSWF421224LLE	77	9.1	\$1844	\$1897	\$1975
HSWF651218RLE	108	11.0	\$2093	\$2174	\$2245
HSWF651218LLE	108	11.0	\$2093	\$2174	\$2245
HSWF501218RLE	87	8.4	\$1976	\$2057	\$2128
HSWF501218LLE	87	8.4	\$1976	\$2057	\$2128
HSWF421218RLE	77	7.1	\$1733	\$1786	\$1864
HSWF421218LLE	77	7.1	\$1733	\$1786	\$1864

NOTES: Wardrobes come installed with a rod accessory to accept clothing hangars or a Fuse™ work tool coat hook can be added (sold separately). Wardrobes have slots cut into the inner liner that allow the user to hang Fuse™ work tool accessories inside the unit. 42”H wardrobes have 2 slots; 50”H and 65”H wardrobes have 4 slots. Wardrobes ship with one adjustable shelf. 42”H and 50”H wardrobes have 3 shelf locations; 65”H wardrobes have 6 shelf locations.

NOTES:

- 1 18”D Wardrobes: 42”H and 50”H plinth wardrobes can be freestanding. 18”D footed units must be attached to a panel, worksurface, or ganged to another unit.
- 1 24”D Wardrobes: 42”H and 50”H plinth and footed wardrobes can be freestanding.
- 1 65”H Wardrobes: 18”D and 24”D must be attached to a panel, worksurface, or ganged to another unit.

HOW TO SPECIFY

Select Model Number H S W F 6 5 1 2 2 4 R L E .	Select Base/Foot BX Recessed Plinth SF Contain Foot T1 Platinum Metallic PR6 Silver	Select Pull E Keypad Electronic D RFID Electronic Lock Pull	Select Case Paint See page 583 P J W .	Select Front Laminate See page 583 L2 upcharge (+ \$37) L S A 1
---	--	--	---	---

CONTAIN® Metal Lockers

GSA SIN 33721



Icon Legend on page 19

STORAGE

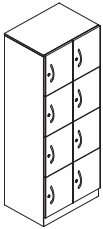

DESCRIPTION

Double Lockers, Plinth w/Metal Front
65”H x 12”W x 18”D, Right Hand, 2 Door
65”H x 12”W x 18”D, Left Hand, 2 Door
42”H x 12”W x 18”D, Right Hand, 2 Door
42”H x 12”W x 18”D, Left Hand, 2 Door

MODEL

HSDLP651218RM
HSDLP651218LM
HSDLP421218RM
HSDLP421218LM

SHIP WEIGHT CUBE

108 11.6
108 11.6
77 7.7
77 7.7

LIST PRICE BY CASE PAINT GRADE

P1 P2 P3

\$1647 \$1728 \$1799
\$1647 \$1728 \$1799
\$1497 \$1550 \$1628
\$1497 \$1550 \$1628

Quad Lockers, Plinth w/Metal Front
65”H x 24”W x 18”D, Right Hand, 4 Door
65”H x 24”W x 18”D, Left Hand, 4 Door
42”H x 24”W x 18”D, Right Hand, 4 Door
42”H x 24”W x 18”D, Left Hand, 4 Door

HSQLP652418RM
HSQLP652418LM
HSQLP422418RM
HSQLP422418LM

148 20.5
148 20.5
109 13.7
109 13.7

\$2467 \$2548 \$2619
\$2467 \$2548 \$2619
\$1976 \$2029 \$2107
\$1976 \$2029 \$2107

Cubby Lockers, Plinth w/Metal Front
65”H x 12”W x 18”D, Right Hand, 4 Door
65”H x 12”W x 18”D, Left Hand, 4 Door
50”H x 12”W x 18”D, Right Hand, 3 Door
50”H x 12”W x 18”D, Left Hand, 3 Door

HSCLP651218RM
HSCLP651218LM
HSCLP501218RM
HSCLP501218LM

92 11.6
92 11.6
81 9.0
81 9.0

\$1675 \$1756 \$1827
\$1675 \$1756 \$1827
\$1422 \$1475 \$1553
\$1422 \$1475 \$1553

65”H x 24”W x 18”D, Right Hand, 8 Door
65”H x 24”W x 18”D, Left Hand, 8 Door
50”H x 24”W x 18”D, Right Hand, 6 Door
50”H x 24”W x 18”D, Left Hand, 6 Door

HSCLP652418RM
HSCLP652418LM
HSCLP502418RM
HSCLP502418LM

148 20.5
148 20.5
121 16.0
121 16.0

\$2615 \$2696 \$2767
\$2615 \$2696 \$2767
\$2081 \$2134 \$2212
\$2081 \$2134 \$2212

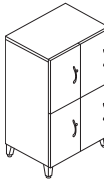
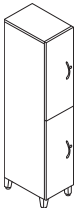

Double Lockers, Footed w/Metal Front
65”H x 12”W x 18”D, Right Hand, 2 Door
65”H x 12”W x 18”D, Left Hand, 2 Door
42”H x 12”W x 18”D, Right Hand, 2 Door
42”H x 12”W x 18”D, Left Hand, 2 Door

HSDLF651218RM
HSDLF651218LM
HSDLF421218RM
HSDLF421218LM

92 11.0
92 11.0
74 7.1
74 7.1

\$1809 \$1890 \$1961
\$1809 \$1890 \$1961
\$1660 \$1713 \$1791
\$1660 \$1713 \$1791

Quad Lockers, Footed w/Metal Front
65”H x 24”W x 18”D, Right Hand, 4 Door
65”H x 24”W x 18”D, Left Hand, 4 Door
42”H x 24”W x 18”D, Right Hand, 4 Door
42”H x 24”W x 18”D, Left Hand, 4 Door

HSQLF652418RM
HSQLF652418LM
HSQLF422418RM
HSQLF422418LM

148 19.4
148 19.4
109 12.6
109 12.6

\$2630 \$2711 \$2782
\$2630 \$2711 \$2782
\$2134 \$2187 \$2265
\$2134 \$2187 \$2265

Cubby Lockers, Footed w/Metal Front
65”H x 12”W x 18”D, Right Hand, 4 Door
65”H x 12”W x 18”D, Left Hand, 4 Door
50”H x 12”W x 18”D, Right Hand, 3 Door
50”H x 12”W x 18”D, Left Hand, 3 Door

HSCLF651218RM
HSCLF651218LM
HSCLF501218RM
HSCLF501218LM

92 11.0
92 11.0
81 8.4
81 8.4

\$1836 \$1917 \$1988
\$1836 \$1917 \$1988
\$1582 \$1635 \$1713
\$1582 \$1635 \$1713

65”H x 24”W x 18”D, Right Hand, 8 Door
65”H x 24”W x 18”D, Left Hand, 8 Door
50”H x 24”W x 18”D, Right Hand, 6 Door
50”H x 24”W x 18”D, Left Hand, 6 Door

HSCLF652418RM
HSCLF652418LM
HSCLF502418RM
HSCLF502418LM

148 19.4
148 19.4
121 14.9
121 14.9

\$3142 \$3223 \$3294
\$3142 \$3223 \$3294
\$2688 \$2741 \$2819
\$2688 \$2741 \$2819

NOTES:

- Lockers can be ganged either side-to-side or back-to-back.
- “Double” and “Quad” lockers include two double coat hooks in each compartment.
- Contain® Lockers can be used with Storage Islands, see page 651.

ⓘ Lockers: 42”H x 12”W and 50”H x 12”W plinth lockers can be freestanding. 65”H x 12”W plinth lockers and all heights of 12”W footed lockers must be attached to a panel, worksurface, or ganged to another unit.

HOW TO SPECIFY

Select Model Number H S Q L P 6 5 2 4 1 8 R M .	Select Base/Foot BK Flush Plinth BX Recessed Plinth SF Contain Foot T1 Platinum Metallic PR6 Silver	Select Pull A Arch PRO Silver N Integral S Square PR6 Silver	Select Case Paint See page 583	Select Front Paint See page 583 NA Matches Case (+ \$0) P1 upcharge (+ \$157) P2 upcharge (+ \$178) P3 upcharge (+ \$199)	Select Lock L Standard Lock X Omit Lock - \$40 (2 Doors) - \$60 (3 Doors) - \$80 (4 Doors) - \$120 (6 Doors) - \$160 (8 Doors)
B X .	A P R O .	P J W .	N A .	L	



Icon Legend on page 19

Metal Lockers with Laminate Fronts

STORAGE

DESCRIPTION	MODEL	SHIP WEIGHT	CUBE	LIST PRICE BY PAINT GRADE		
				P1	P2	P3
Double Lockers, Plinth w/Laminate Front 65"H x 12"W x 18"D, Right Hand, 2 Door 65"H x 12"W x 18"D, Left Hand, 2 Door 42"H x 12"W x 18"D, Right Hand, 2 Door 42"H x 12"W x 18"D, Left Hand, 2 Door	HSDLP651218RL	108	11.6	\$1895	\$1976	\$2047
	HSDLP651218LL	108	11.6	\$1895	\$1976	\$2047
	HSDLP421218RL	77	7.7	\$1723	\$1776	\$1854
	HSDLP421218LL	77	7.7	\$1723	\$1776	\$1854
Quad Lockers, Plinth w/Laminate Front 65"H x 24"W x 18"D, Right Hand, 4 Door 65"H x 24"W x 18"D, Left Hand, 4 Door 42"H x 24"W x 18"D, Right Hand, 4 Door 42"H x 24"W x 18"D, Left Hand, 4 Door	HSQLP652418RL	148	20.5	\$2839	\$2920	\$2991
	HSQLP652418LL	148	20.5	\$2839	\$2920	\$2991
	HSQLP422418RL	109	13.7	\$2272	\$2325	\$2403
	HSQLP422418LL	109	13.7	\$2272	\$2325	\$2403
Cubby Lockers, Plinth w/Laminate Front 65"H x 12"W x 18"D, Right Hand, 4 Door 65"H x 12"W x 18"D, Left Hand, 4 Door 50"H x 12"W x 18"D, Right Hand, 3 Door 50"H x 12"W x 18"D, Left Hand, 3 Door	HSCLP651218RL	92	11.6	\$1926	\$2007	\$2078
	HSCLP651218LL	92	11.6	\$1926	\$2007	\$2078
	HSCLP501218RL	81	9.0	\$1635	\$1688	\$1766
	HSCLP501218LL	81	9.0	\$1635	\$1688	\$1766
65"H x 24"W x 18"D, Right Hand, 8 Door 65"H x 24"W x 18"D, Left Hand, 8 Door 50"H x 24"W x 18"D, Right Hand, 6 Door 50"H x 24"W x 18"D, Left Hand, 6 Door	HSCLP652418RL	148	20.5	\$3428	\$3509	\$3580
	HSCLP652418LL	148	20.5	\$3428	\$3509	\$3580
	HSCLP502418RL	121	16.0	\$2906	\$2959	\$3037
	HSCLP502418LL	121	16.0	\$2906	\$2959	\$3037
Double Lockers, Footed w/Laminate Front 65"H x 12"W x 18"D, Right Hand, 2 Door 65"H x 12"W x 18"D, Left Hand, 2 Door 42"H x 12"W x 18"D, Right Hand, 2 Door 42"H x 12"W x 18"D, Left Hand, 2 Door	HSDLF651218RL	92	11.0	\$2057	\$2138	\$2209
	HSDLF651218LL	92	11.0	\$2057	\$2138	\$2209
	HSDLF421218RL	74	7.1	\$1884	\$1937	\$2015
	HSDLF421218LL	74	7.1	\$1884	\$1937	\$2015
Quad Lockers, Footed w/Laminate Front 65"H x 24"W x 18"D, Right Hand, 4 Door 65"H x 24"W x 18"D, Left Hand, 4 Door 42"H x 24"W x 18"D, Right Hand, 4 Door 42"H x 24"W x 18"D, Left Hand, 4 Door	HSQLF652418RL	148	19.4	\$2999	\$3080	\$3151
	HSQLF652418LL	148	19.4	\$2999	\$3080	\$3151
	HSQLF422418RL	109	12.6	\$2433	\$2486	\$2564
	HSQLF422418LL	109	12.6	\$2433	\$2486	\$2564
Cubby Lockers, Footed w/Laminate Front 65"H x 12"W x 18"D, Right Hand, 4 Door 65"H x 12"W x 18"D, Left Hand, 4 Door 50"H x 12"W x 18"D, Right Hand, 3 Door 50"H x 12"W x 18"D, Left Hand, 3 Door	HSCLF651218RL	92	11.0	\$2087	\$2168	\$2239
	HSCLF651218LL	92	11.0	\$2087	\$2168	\$2239
	HSCLF501218RL	81	8.4	\$1794	\$1847	\$1925
	HSCLF501218LL	81	8.4	\$1794	\$1847	\$1925
65"H x 24"W x 18"D, Right Hand, 8 Door 65"H x 24"W x 18"D, Left Hand, 8 Door 50"H x 24"W x 18"D, Right Hand, 6 Door 50"H x 24"W x 18"D, Left Hand, 6 Door	HSCLF652418RL	148	19.4	\$3588	\$3669	\$3740
	HSCLF652418LL	148	19.4	\$3588	\$3669	\$3740
	HSCLF502418RL	121	14.9	\$3067	\$3120	\$3198
	HSCLF502418LL	121	14.9	\$3067	\$3120	\$3198

NOTES:

- Lockers can be ganged either side-to-side or back-to-back.
- "Double" and "Quad" lockers include two double coat hooks in each compartment.
- Contain® Lockers can be used with Storage Islands, see page 651.
- ⓘ Lockers: 42"H x 12"W and 50"H x 12"W plinth lockers can be freestanding. 65"H x 12"W plinth lockers and all heights of 12"W footed lockers must be attached to a panel, worksurface, or ganged to another unit.

HOW TO SPECIFY

<p>Select Model Number</p> <p>H S Q L P 6 5 2 4 1 8 R L .</p>	<p>Select Base/Foot</p> <p>BX Recessed Plinth SF Contain Foot T1 Platinum Metallic PR6 Silver</p> <p>B X .</p>	<p>Select Pull</p> <p>A Arch PRO Square S Square PR6 Silver</p> <p>A P R O .</p>	<p>Select Case Paint</p> <p>See page 583</p> <p>P J W .</p>	<p>Select Front Laminate</p> <p>See page 583 L2 upcharge (+ \$37)</p> <p>L S A 1 .</p>	<p>Select Lock</p> <p>L Standard Lock X Omit Lock - \$40 (2 Doors) - \$60 (3 Doors) - \$80 (4 Doors) - \$120 (6 Doors) - \$160 (8 Doors)</p> <p>L</p>
--	--	--	--	--	--

CONTAIN® Metal Lockers with eLock

GSA SIN 33721



Icon Legend on page 19

STORAGE

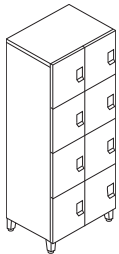
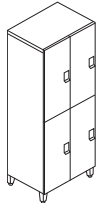
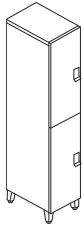
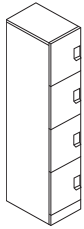
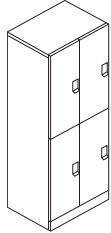
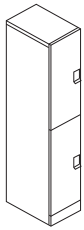

DESCRIPTION	MODEL	SHIP WEIGHT	CUBE	LIST PRICE BY CASE PAINT GRADE		
				P1	P2	P3
Double Lockers, Plinth w/Metal Front, eLock						
65"H x 12"W x 18"D, Right Hand, 2 Door	HSDLP651218RME	92	11.6	\$2358	\$2439	\$2510
65"H x 12"W x 18"D, Left Hand, 2 Door	HSDLP651218LME	92	11.6	\$2358	\$2439	\$2510
42"H x 12"W x 18"D, Right Hand, 2 Door	HSDLP421218RME	74	7.7	\$2206	\$2259	\$2337
42"H x 12"W x 18"D, Left Hand, 2 Door	HSDLP421218LME	74	7.7	\$2206	\$2259	\$2337
Quad Lockers, Plinth w/Metal Front, eLock						
65"H x 24"W x 18"D, Right Hand, 4 Door	HSQLP652418RME	148	20.5	\$3887	\$3968	\$4039
65"H x 24"W x 18"D, Left Hand, 4 Door	HSQLP652418LME	148	20.5	\$3887	\$3968	\$4039
42"H x 24"W x 18"D, Right Hand, 4 Door	HSQLP422418RME	109	13.7	\$3395	\$3448	\$3526
42"H x 24"W x 18"D, Left Hand, 4 Door	HSQLP422418LME	109	13.7	\$3395	\$3448	\$3526
Cubby Lockers, Plinth w/Metal Front, eLock						
65"H x 12"W x 18"D, Right Hand, 4 Door	HSCLP651218RME	92	11.6	\$3095	\$3176	\$3247
65"H x 12"W x 18"D, Left Hand, 4 Door	HSCLP651218LME	92	11.6	\$3095	\$3176	\$3247
50"H x 12"W x 18"D, Right Hand, 3 Door	HSCLP501218RME	81	9.0	\$2487	\$2540	\$2618
50"H x 12"W x 18"D, Left Hand, 3 Door	HSCLP501218LME	81	9.0	\$2487	\$2540	\$2618
65"H x 24"W x 18"D, Right Hand, 8 Door	HSCLP652418RME	148	20.5	\$5454	\$5535	\$5606
65"H x 24"W x 18"D, Left Hand, 8 Door	HSCLP652418LME	148	20.5	\$5454	\$5535	\$5606
50"H x 24"W x 18"D, Right Hand, 6 Door	HSCLP502418RME	121	16.0	\$4211	\$4264	\$4342
50"H x 24"W x 18"D, Left Hand, 6 Door	HSCLP502418LME	121	16.0	\$4211	\$4264	\$4342
Double Lockers, Footed w/Metal Front, eLock						
65"H x 12"W x 18"D, Right Hand, 2 Door	HSDLF651218RME	92	11.0	\$2519	\$2600	\$2671
65"H x 12"W x 18"D, Left Hand, 2 Door	HSDLF651218LME	92	11.0	\$2519	\$2600	\$2671
42"H x 12"W x 18"D, Right Hand, 2 Door	HSDLF421218RME	74	7.1	\$2370	\$2423	\$2501
42"H x 12"W x 18"D, Left Hand, 2 Door	HSDLF421218LME	74	7.1	\$2370	\$2423	\$2501
Quad Lockers, Footed w/Metal Front, eLock						
65"H x 24"W x 18"D, Right Hand, 4 Door	HSQLF652418RME	148	19.4	\$4049	\$4130	\$4201
65"H x 24"W x 18"D, Left Hand, 4 Door	HSQLF652418LME	148	19.4	\$4049	\$4130	\$4201
42"H x 24"W x 18"D, Right Hand, 4 Door	HSQLF422418RME	109	12.6	\$3555	\$3608	\$3686
42"H x 24"W x 18"D, Left Hand, 4 Door	HSQLF422418LME	109	12.6	\$3555	\$3608	\$3686
Cubby Lockers, Footed w/Metal Front, eLock						
65"H x 12"W x 18"D, Right Hand, 4 Door	HSCLF651218RME	92	11.0	\$3256	\$3337	\$3408
65"H x 12"W x 18"D, Left Hand, 4 Door	HSCLF651218LME	92	11.0	\$3256	\$3337	\$3408
50"H x 12"W x 18"D, Right Hand, 3 Door	HSCLF501218RME	81	8.4	\$2645	\$2698	\$2776
50"H x 12"W x 18"D, Left Hand, 3 Door	HSCLF501218LME	81	8.4	\$2645	\$2698	\$2776
65"H x 24"W x 18"D, Right Hand, 8 Door	HSCLF652418RME	148	20.5	\$5981	\$6062	\$6133
65"H x 24"W x 18"D, Left Hand, 8 Door	HSCLF652418LME	148	20.5	\$5981	\$6062	\$6133
50"H x 24"W x 18"D, Right Hand, 6 Door	HSCLF502418RME	121	16.0	\$4818	\$4871	\$4949
50"H x 24"W x 18"D, Left Hand, 6 Door	HSCLF502418LME	121	16.0	\$4818	\$4871	\$4949

NOTES:

- Lockers can be ganged either side-to-side or back-to-back.
- "Double" and "Quad" lockers include two double coat hooks in each compartment.
- Contain® Lockers can be used with Storage Islands, see page 651.

ⓘ Lockers: 42"H x 12"W and 50"H x 12"W plinth lockers can be freestanding. 65"H x 12"W plinth lockers and all heights of 12"W footed lockers must be attached to a panel, worksurface, or ganged to another unit.

ⓘ Every digital keypad or RFID installation site will require one Programming Key and at least one Manager Key, sold separately.

HOW TO SPECIFY

<p>Select Model Number</p> <p>H S Q L P 6 5 2 4 1 8 R M E .</p>	<p>Select Base/Foot</p> <p>BK Flush Plinth BX Recessed Plinth SF Contain Foot T1 Platinum Metallic PR6 Silver</p> <p>B X .</p>	<p>Select Pull</p> <p>E Keypad Electronic Lock D RFID Electronic Lock Pull + \$209 (2 Doors) + \$314 (3 Doors) + \$418 (4 Doors) + \$625 (6 Doors) + \$836 (8 Doors)</p> <p>D .</p>	<p>Select Case Paint</p> <p>See page 583</p> <p>P J W .</p>	<p>Select Front Paint</p> <p>See page 583</p> <p>NA Matches Case (+ \$0) P1 upcharge (+ \$157) P2 upcharge (+ \$178) P3 upcharge (+ \$199)</p> <p>N A</p>
--	---	--	--	---



Metal Lockers with Laminate Fronts and eLock

STORAGE

DESCRIPTION	MODEL	SHIP WEIGHT	CUBE	LIST PRICE BY PAINT GRADE			
				P1	P2	P3	
Double Lockers, Plinth w/Laminate Front, eLock 65”H x 12”W x 18”D, Right Hand, 2 Door 65”H x 12”W x 18”D, Left Hand, 2 Door 42”H x 12”W x 18”D, Right Hand, 2 Door 42”H x 12”W x 18”D, Left Hand, 2 Door	HSDLP651218RLE	92	11.6	\$2605	\$2686	\$2757	
	HSDLP651218LLE	92	11.6	\$2605	\$2686	\$2757	
	HSDLP421218RLE	74	7.7	\$2433	\$2486	\$2564	
	HSDLP421218LLE	74	7.7	\$2433	\$2486	\$2564	
Quad Lockers, Plinth w/Laminate Front, eLock 65”H x 24”W x 18”D, Right Hand, 4 Door 65”H x 24”W x 18”D, Left Hand, 4 Door 42”H x 24”W x 18”D, Right Hand, 4 Door 42”H x 24”W x 18”D, Left Hand, 4 Door	HSQLP652418RLE	148	20.5	\$4259	\$4340	\$4411	
	HSQLP652418LLE	148	20.5	\$4259	\$4340	\$4411	
	HSQLP422418RLE	109	13.7	\$3692	\$3745	\$3823	
	HSQLP422418LLE	109	13.7	\$3692	\$3745	\$3823	
Cubby Lockers, Plinth w/Laminate Front, eLock 65”H x 12”W x 18”D, Right Hand, 4 Door 65”H x 12”W x 18”D, Left Hand, 4 Door 50”H x 12”W x 18”D, Right Hand, 3 Door 50”H x 12”W x 18”D, Left Hand, 3 Door 65”H x 24”W x 18”D, Right Hand, 8 Door 65”H x 24”W x 18”D, Left Hand, 8 Door 50”H x 24”W x 18”D, Right Hand, 6 Door 50”H x 24”W x 18”D, Left Hand, 6 Door	HSCLP651218RLE	92	11.6	\$3346	\$3427	\$3498	
	HSCLP651218LLE	92	11.6	\$3346	\$3427	\$3498	
	HSCLP501218RLE	81	9.0	\$2700	\$2753	\$2831	
	HSCLP501218LLE	81	9.0	\$2700	\$2753	\$2831	
	HSCLP652418RLE	148	20.5	\$6267	\$6348	\$6419	
	HSCLP652418LLE	148	20.5	\$6267	\$6348	\$6419	
	HSCLP502418RLE	121	16.0	\$5035	\$5088	\$5166	
	HSCLP502418LLE	121	16.0	\$5035	\$5088	\$5166	
	Double Lockers, Footed w/Laminate Front, eLock 65”H x 12”W x 18”D, Right Hand, 2 Door 65”H x 12”W x 18”D, Left Hand, 2 Door 42”H x 12”W x 18”D, Right Hand, 2 Door 42”H x 12”W x 18”D, Left Hand, 2 Door	HSDLF651218RLE	92	11.0	\$2767	\$2848	\$2919
		HSDLF651218LLE	92	11.0	\$2767	\$2848	\$2919
		HSDLF421218RLE	74	7.1	\$2593	\$2646	\$2724
		HSDLF421218LLE	74	7.1	\$2593	\$2646	\$2724
Quad Lockers, Footed w/Laminate Front, eLock 65”H x 24”W x 18”D, Right Hand, 4 Door 65”H x 24”W x 18”D, Left Hand, 4 Door 42”H x 24”W x 18”D, Right Hand, 4 Door 42”H x 24”W x 18”D, Left Hand, 4 Door	HSQLF652418RLE	148	19.4	\$4419	\$4500	\$4571	
	HSQLF652418LLE	148	19.4	\$4419	\$4500	\$4571	
	HSQLF422418RLE	109	12.6	\$3852	\$3905	\$3983	
	HSQLF422418LLE	109	12.6	\$3852	\$3905	\$3983	
Cubby Lockers, Footed w/Laminate Front, eLock 65”H x 12”W x 18”D, Right Hand, 4 Door 65”H x 12”W x 18”D, Left Hand, 4 Door 50”H x 12”W x 18”D, Right Hand, 3 Door 50”H x 12”W x 18”D, Left Hand, 3 Door 65”H x 24”W x 18”D, Right Hand, 8 Door 65”H x 24”W x 18”D, Left Hand, 8 Door 50”H x 24”W x 18”D, Right Hand, 6 Door 50”H x 24”W x 18”D, Left Hand, 6 Door	HSCLF651218RLE	92	11.0	\$3508	\$3589	\$3660	
	HSCLF651218LLE	92	11.0	\$3508	\$3589	\$3660	
	HSCLF501218RLE	81	8.4	\$2859	\$2912	\$2990	
	HSCLF501218LLE	81	8.4	\$2859	\$2912	\$2990	
	HSCLF652418RLE	148	19.4	\$6427	\$6508	\$6579	
	HSCLF652418LLE	148	19.4	\$6427	\$6508	\$6579	
	HSCLF502418RLE	121	14.9	\$5196	\$5249	\$5327	
	HSCLF502418LLE	121	14.9	\$5196	\$5249	\$5327	

NOTES:

- Lockers can be ganged either side-to-side or back-to-back.
- “Double” and “Quad” lockers include two double coat hooks in each compartment.
- Contain® Lockers can be used with Storage Islands, see page 651.
- ⓘ Lockers: 42”H x 12”W and 50”H x 12”W plinth lockers can be freestanding. 65”H x 12”W plinth lockers and all heights of 12”W footed lockers must be attached to a panel, worksurface, or ganged to another unit.
- ⓘ Every digital keypad or RFID installation site will require one Programming Key and at least one Manager Key, sold separately.

HOW TO SPECIFY

<p>Select Model Number</p> <p>H S Q L P 6 5 2 4 1 8 R L E .</p>	<p>Select Base/Foot</p> <p>BX Recessed Plinth SF Contain Foot T1 Platinum Metallic PR6 Silver</p> <p>B X .</p>	<p>Select Pull</p> <p>E Keypad Electronic Lock D RFID Electronic Lock Pull + \$209 (2 Doors) + \$314 (3 Doors) + \$418 (4 Doors) + \$625 (6 Doors) + \$836 (8 Doors)</p> <p>D .</p>	<p>Select Case Paint</p> <p>See page 583</p> <p>P J W .</p>	<p>Select Front Laminate</p> <p>See page 583 L2 upcharge (+ \$37)</p> <p>L S A 1</p>
--	--	--	--	--

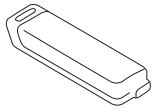

DESCRIPTION

MODEL

SHIP WEIGHT

CUBE

LIST PRICE

Digital Keys

Digilock Programming Key
Digilock Manager Key

HSLDIGPRG
HSLDIGMGR

0.8
0.8

0.0
0.0

\$218
\$170

NOTES: A Programming Key is used to initialize locks out of factory default mode and register Manager Keys to the locks. Manager Keys are used to bypass a locked unit, operating as the “master key” and it is recommended that building facilitators have at least one Manager Key. Up to 6 Manager Keys may be registered to each lock. Manager Keys provide external power to locks in case of battery failure. Programming Key is the same key as Fuse™ Digilocks and can work across both Contain® and Fuse™.

- ⓘ Only one Programming Key should be specified per installation and multiple Programming Keys are not compatible with each other.
- ⓘ Add-on digital lock orders should be programmed with the original Programming Key.

RFID Cards

Digilock RFID Cards, Pack of 5
Digilock RFID Cards, Pack of 25
Digilock RFID Cards, Pack of 100

HSLRFID5C
HSLRFID25C
HSLRFID100C

0.3
0.5
1.9

0.0
0.0
0.0

\$144
\$673
\$2548

NOTES: RFID cards are plain white and have a lanyard cutout.

RFID Stickers

Digilock RFID Stickers, Pack of 5
Digilock RFID Stickers, Pack of 25
Digilock RFID Stickers, Pack of 100

HSLRFID5S
HSLRFID25S
HSLRFID100S

0.3
0.5
1.9

0.0
0.0
0.0

\$77
\$338
\$1276

NOTES: RFID stickers are plain white, approximately 1” in diameter and may be added to the back of an existing employee badge or identification card.

STORAGE

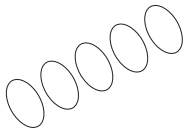
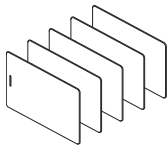

HOW TO SPECIFY

Select
Model Number

H S L R F I D 2 5 C



Icon Legend on page 19

CONTAIN[®] Metal Pedestals

	DESCRIPTION	MODEL	SHIP WEIGHT	CUBE	LIST PRICE BY CASE PAINT GRADE		
					P1	P2	P3
	Hanging Pedestal with Metal Fronts, Box/File						
	18"H x 15"W x 18"D	HSPH181518BFFM	35.0	4.4	\$751	\$781	\$810
	18"H x 15"W x 24"D	HSPH181524BFFM	41.3	5.2	\$806	\$836	\$865
	18"H x 15"W x 30"D	HSPH181530BFFM	50.4	6.5	\$846	\$876	\$905
	Mobile Pedestal with Metal Fronts, Box/File						
	21"H x 15"W x 18"D	HSPM211518BFFM	50.3	4.5	\$751	\$781	\$810
	21"H x 15"W x 24"D	HSPM211524BFFM	43.1	5.6	\$806	\$836	\$865
	Mobile Pedestal with Metal Fronts, Box/Box/File						
	27"H x 15"W x 18"D	HSPM271518BBFFM	78.1	6.9	\$973	\$1003	\$1032
	27"H x 15"W x 24"D	HSPM271524BBFFM	54.9	7.1	\$1027	\$1057	\$1086
	27"H x 15"W x 30"D	HSPM271530BBFFM	72.4	8.8	\$1079	\$1109	\$1138
	Mobile Pedestal with Metal Fronts, File/File						
	27"H x 15"W x 18"D	HSPM271518FFM	50.2	5.7	\$973	\$1003	\$1032
	27"H x 15"W x 24"D	HSPM271524FFM	54.9	7.1	\$1027	\$1057	\$1086
	27"H x 15"W x 30"D	HSPM271530FFM	64.4	8.8	\$1079	\$1109	\$1138
	Plinth Support Pedestal with Metal Fronts, Box/Box/File						
	28"H x 15"W x 18"D	HSPSP281518BBFFM	49.0	6.3	\$940	\$970	\$999
	28"H x 15"W x 24"D	HSPSP281524BBFFM	57.1	7.9	\$991	\$1021	\$1050
	28"H x 15"W x 30"D	HSPSP281530BBFFM	57.7	9.7	\$1045	\$1075	\$1104
	Plinth Support Pedestal with Metal Fronts, File/File						
	28"H x 15"W x 18"D	HSPSP281518FFM	45.1	6.3	\$940	\$970	\$999
	28"H x 15"W x 24"D	HSPSP281524FFM	51.3	7.9	\$991	\$1021	\$1050
	28"H x 15"W x 30"D	HSPSP281530FFM	60.4	9.7	\$1045	\$1075	\$1104

STORAGE

NOTES:

- Ball-bearing suspension on box and file drawer. (100%)
- Drawers color to be interior gray steel.
- See page 621 for Pedestal Seat.
- File drawer has high sides and back for filing front to back and side to side.
- Counterweight standard on all mobile peds.
- Pencil tray standard in top box drawer.
- One box divider standard in each box drawer.
- One crossrail standard in each file drawer.
- 24"D and 30"D pedestals accommodate legal files side to side.
- ! A-Pull available in Satin Chrome only.
- ! Locking units equipped with HON "One Key" interchangeable core removable locks. Keyed alike core model HF23S, in Satin, must be ordered separately. See page 596.

HOW TO SPECIFY

Select Model Number	Select Base <i>Specify for Plinth models only</i> BK Flush Plinth BX Recessed Plinth	Select Pull A Arch PRO Silver R Radius N Integral	Select Case Paint See page 583	Select Front Paint See page 583 NA Matches Case (+ \$0) P1 upcharge (+ \$27) P2 upcharge (+ \$48) P3 upcharge (+ \$68)	Select Lock L Standard Lock X Omit Lock (- \$20) EBNL eLock (+ \$340)
H S P H 1 8 1 5 3 0 B F F M .	B X .	A P R O .	P J W .	N A .	L

CONTAIN[®] Footed Metal Pedestals

GSA SIN 33721



Icon Legend on page 19

	DESCRIPTION	MODEL	SHIP WEIGHT	CUBE	LIST PRICE BY CASE PAINT GRADE		
					P1	P2	P3
	Footed Freestanding Pedestal with Metal Fronts, Box/File						
	22"H x 15"W x 18"D	HSPFF221518BFM	52.5	4.5	\$884	\$914	\$943
	22"H x 15"W x 24"D	HSPFF221524BFM	58.8	5.6	\$934	\$964	\$993
	Footed Support Pedestal with Metal Fronts, Box/Box/File						
	28"H x 15"W x 18"D	HSPSF281518BBFM	49.2	5.7	\$1104	\$1134	\$1163
	28"H x 15"W x 24"D	HSPSF281524BBFM	56.9	7.1	\$1153	\$1183	\$1212
	28"H x 15"W x 30"D	HSPSF281530BBFM	67.8	8.8	\$1209	\$1239	\$1268
	Footed Support Pedestal with Metal Fronts, File/File						
	28"H x 15"W x 18"D	HSPSF281518FFM	49.2	5.7	\$1104	\$1134	\$1163
	28"H x 15"W x 24"D	HSPSF281524FFM	56.9	7.1	\$1153	\$1183	\$1212
	28"H x 15"W x 30"D	HSPSF281530FFM	67.8	8.8	\$1209	\$1239	\$1268
	Flush Pedestal Kickplates (Field Installable)	HSPAK15	2.0	0.2	\$148	\$157	\$162
	Specify: Model.Paint SPECIFYING EXAMPLE: HSPAK.P						

NOTES:

- Ball-bearing suspension on box and file drawer. (100%)
- Drawers color to be interior gray steel.
- File drawer has high sides and back for filing front-to-back and side-to-side.
- Counterweight standard on all mobile peds.
- See page 621 for Pedestal Seat.
- Pencil tray standard in top box drawer.
- One box divider standard in each box drawer.
- One crossrail standard in each file drawer.
- 24"D and 30"D pedestals accommodate legal files side-to-side.

! A-Pull available in Satin Chrome only.

! Locking units equipped with HON "One Key" interchangeable core removable locks. Keyed alike core model HF23S, in Satin, must be ordered separately. See page 596.

HOW TO SPECIFY

Select Model Number	Select Foot	Select Pull	Select Case Paint	Select Front Paint	Select Lock
	SF Contain Foot T1 Platinum Metallic PR6 Silver	A Arch PRO Silver R Radius N Integral	See page 583	See page 583 NA Matches Case (+ \$0) P1 upcharge (+ \$27) P2 upcharge (+ \$48) P3 upcharge (+ \$89)	L Standard Lock X Omit Lock (- \$20) EBNL eLock (+ \$340)
H S P F F 2 2 1 5 2 4 B F M .	S F T 1 .	A P R O .	P J W .	N A .	L



CONTAIN[®] Pedestal Accessories

DESCRIPTION	MODEL	SHIP WEIGHT	CUBE	LIST PRICE
Counterweight — Freestanding Support Pedestals or Systems Support and Mobile Pedestals	HPCW1	18	0.1	\$269
! No specification needed.				

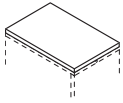

DESCRIPTION	MODEL	SHIP WEIGHT	CUBE	FABRIC PRICE CODES			
Pedestal Seat 15"W x 18"D x 2"H NOTES: Works with Contain [®] and Flagship [®] Pedestals and Mobile Pedestals.	HPSEAT18ND	16.3 Ⓞ	0.9	1	\$227	8	\$432
				2	\$253	9	\$465
				3	\$278	10	\$497
				4	\$303	11	\$530
				5	\$335	12	\$562
				6	\$368	L	—
				7	\$400		

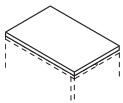

Pedestal Seat 15"W x 22 ⁷ / ₈ "D x 2"H SPECIFYING EXAMPLE: HPSEAT24ND.CU10	HPSEAT24ND	10.0 Ⓞ	1.2	1	\$267	8	\$472
				2	\$293	9	\$505
				3	\$318	10	\$537
				4	\$343	11	\$570
				5	\$375	12	\$602
				6	\$408	L	—
				7	\$440		

STORAGE

HOW TO SPECIFY

Select Model Number	Select Fabric
	See pages 22-24 for seating fabric options
HPSEAT24ND.	CU10

CONTAIN[®] Metal Pedestals with Laminate Fronts

GSA SIN 33721



Icon Legend on page 19

STORAGE

	DESCRIPTION	MODEL	SHIP WEIGHT	CUBE	LIST PRICE BY PAINT GRADE		
					P1	P2	P3
	Hanging Pedestal with Laminate Fronts, Box/File						
	18"H x 15"W x 18"D, Arch Pull	HSPH181518BFL	37.6	4.5	\$961	\$991	\$1020
	18"H x 15"W x 24"D, Arch Pull	HSPH181524BFL	43.8	5.6	\$1014	\$1044	\$1073
	18"H x 15"W x 30"D, Arch Pull	HSPH181530BFL	53.0	6.3	\$1054	\$1084	\$1113
	Mobile Pedestal with Laminate Fronts, Box/File						
	21"H x 15"W x 18"D, Arch Pull	HSPM211518BFL	57.9	4.5	\$961	\$991	\$1020
	21"H x 15"W x 24"D, Arch Pull	HSPM211524BFL	50.7	5.6	\$1014	\$1044	\$1073
	Mobile Pedestal with Laminate Fronts, Box/Box/File						
	27"H x 15"W x 18"D, Arch Pull	HSPM271518BBFL	80.3	6.9	\$1246	\$1276	\$1305
	27"H x 15"W x 24"D, Arch Pull	HSPM271524BBFL	63.4	7.1	\$1299	\$1329	\$1358
	27"H x 15"W x 30"D, Arch Pull	HSPM271530BBFL	75.2	8.8	\$1353	\$1383	\$1412
	Mobile Pedestal with Laminate Fronts, File/File						
	27"H x 15"W x 18"D, Arch Pull	HSPM271518FFL	53.3	5.7	\$1246	\$1276	\$1305
	27"H x 15"W x 24"D, Arch Pull	HSPM271524FFL	58.1	7.1	\$1299	\$1329	\$1358
	27"H x 15"W x 30"D, Arch Pull	HSPM271530FFL	67.6	8.8	\$1353	\$1383	\$1412
	Plinth Support Pedestal with Laminate Fronts, Box/Box/File						
	28"H x 15"W x 18"D, Arch Pull	HSPSP281518BBFL	51.7	6.3	\$1216	\$1246	\$1275
	28"H x 15"W x 24"D, Arch Pull	HSPSP281524BBFL	59.9	7.9	\$1265	\$1295	\$1324
	28"H x 15"W x 30"D, Arch Pull	HSPSP281530BBFL	71.1	9.7	\$1320	\$1350	\$1379
	Plinth Support Pedestal with Laminate Fronts, File/File						
	28"H x 15"W x 18"D, Arch Pull	HSPSP281518FFL	47.6	6.3	\$1216	\$1246	\$1275
	28"H x 15"W x 24"D, Arch Pull	HSPSP281524FFL	54.5	7.9	\$1265	\$1295	\$1324
	28"H x 15"W x 30"D, Arch Pull	HSPSP281530FFL	63.6	9.7	\$1320	\$1350	\$1379

NOTES:

- Ball-bearing suspension on box and file drawer. (100%)
- Drawers color to be interior gray steel.
- File drawer has high sides and back for filing front-to-back and side-to-side.
- Counterweight standard on all mobile peds.
- See page 621 for Pedestal Seat.
- Pencil tray standard in top box drawer.
- One box divider standard in each box drawer.
- One crossrail standard in each file drawer.
- 24"D and 30"D pedestals accommodate legal files side-to-side.

! Drawer Fronts available with Satin Chrome Arch only.

! Locking units equipped with HON "One Key" interchangeable core removable locks. Keyed alike core model HF23S, in Satin, must be ordered separately. See page 596.

HOW TO SPECIFY

Select Model Number	Select Base <i>Specify for Plinth models only</i> BX Recessed Plinth	Select Pull A Arch PRO Silver	Select Case Paint See page 583	Select Front Laminate See page 583 L2 upcharge (+ \$11)	Select Lock L Standard Lock X Omit Lock (- \$20) EBNL eLock (+ \$340)
HSPSP281524BBFL	BX	APRO	PJW	LSA1	L



Icon Legend on page 19

Footed Metal Pedestals with Laminate Fronts

	DESCRIPTION	MODEL	SHIP WEIGHT	CUBE	LIST PRICE BY PAINT GRADE		
					P1	P2	P3
	Footed Freestanding Pedestal with Laminate Fronts, Box/File						
	22"H x 15"W x 18"D, Arch Pull	HSPFF221518BFL	54.7	4.5	\$1091	\$1121	\$1150
	22"H x 15"W x 24"D, Arch Pull	HSPFF221524BFL	60.9	5.6	\$1141	\$1171	\$1200
	Footed Support Pedestal with Laminate Fronts, Box/Box/File						
	28"H x 15"W x 18"D, Arch Pull	HSPSF281518BBFL	59.0	5.7	\$1375	\$1405	\$1434
	28"H x 15"W x 24"D, Arch Pull	HSPSF281524BBFL	59.0	7.1	\$1428	\$1458	\$1487
	28"H x 15"W x 30"D, Arch Pull	HSPSF281530BBFL	69.9	8.8	\$1479	\$1509	\$1538
	Footed Support Pedestal with Laminate Fronts, File/File						
	28"H x 15"W x 18"D, Arch Pull	HSPSF281518FFL	51.4	5.7	\$1375	\$1405	\$1434
	28"H x 15"W x 24"D, Arch Pull	HSPSF281524FFL	59.0	7.1	\$1428	\$1458	\$1487
	28"H x 15"W x 30"D, Arch Pull	HSPSF281530FFL	69.9	8.8	\$1479	\$1509	\$1538

STORAGE

NOTES:

- Ball-bearing suspension on box and file drawer. (100%)
- Drawers color to be interior gray steel.
- File drawer has high sides and back for filing front-to-back and side-to-side.
- Counterweight standard on all mobile peds.
- See page 621 for Pedestal Seat.
- Pencil tray standard in top box drawer.
- One box divider standard in each box drawer.
- One crossrail standard in each file drawer.
- 24"D and 30"D pedestals accommodate legal files side-to-side.

❗ Drawer Fronts available with Satin Chrome Arch only.

❗ Locking units equipped with HON "One Key" interchangeable core removable locks. Keyed alike core model HF23S, in Satin, must be ordered separately. See page 596.

HOW TO SPECIFY

Select Model Number	Select Foot	Select Pull	Select Case Paint	Select Front Laminate	Select Lock
	SF Contain Foot T1 Platinum Metallic PR6 Silver	A Arch PRO Silver	See page 583	See page 583 L2 upcharge (+ \$11)	L Standard Lock X Omit Lock (- \$20) EBNL eLock (+ \$340)
H S P S F 2 8 1 5 2 4 B B F L .	S F T 1 .	A P R O .	P J W .	L S A 1 .	L

CONTAIN[®] Pedestal Accessories

GSA SIN 33721



Icon Legend on page 19

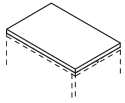

DESCRIPTION

Pedestal Seat

15"W x 22⁷/₈"D x 2"H

NOTES: For seating fabrics, see pages 22-24.

SPECIFYING EXAMPLE: HPSEAT24ND.APN23

MODEL

HPSEAT24ND

SHIP WEIGHT

10

CUBE

1.2

FABRIC PRICE CODES

1	\$267	8	\$472
2	\$293	9	\$505
3	\$318	10	\$537
4	\$343	11	\$570
5	\$375	12	\$602
6	\$408	L	—
7	\$440		

NOTES:

- See Brigade[®] pedestals on page 573 for additional pedestal options. See pages 670-671 for Pedestal Accessories.

STORAGE

HOW TO SPECIFY

Select
Model Number

Select
Fabric

See pages 22-24 for seating fabric options

H P S E A T 2 4 .

A P N 2 3



STORAGE

Flagship® Modular Storage.

FLAGSHIP®

Pedestals in more than 40 styles. Lateral files in 15 sizes. These are just some of the reasons why Flagship is one of HON's top metal storage collections, and why HON is America's filing and storage leader. Today's offices run on information, and Flagship helps them sort, store and share every bit of it — plus all of the personal items and daily supplies employees depend on. It's the best-built storage available from any manufacturer at any price.



FEATURES

- Rugged, high-quality construction makes HON America's leader in filing and storage.
- ColorCorrect® lets you match your Flagship storage to many office furniture manufacturers.
- Add seat cushions to mobile pedestals for short-term, stow-away guest seating.
- Modular Storage with bins for easy access and customization.
- Lateral files with storage cabinets not only corral all your info, they double as collaborative hubs.
- Squeeze more storage capacity into a smaller workstation footprint by using pedestals as worksurface supports.
- Archival filing doesn't have to be stuffy. Outfit any open space with a wall full of storage, available at a moment's notice.

FLAGSHIP® ORDERING INFORMATION

STORAGE

FLAGSHIP® PRODUCTS

PAINTS CODES

- P1**
- ◆ Black P
 - ◆ Brownstone P7D
 - ◆ Cove P096
 - ◆ Charcoal S
 - ◆ Designer White PJW
 - ◆ Dune P094
 - ◆ Fossil P28
 - ◆ Greige T5
 - ◆ Harbor P097
 - ◆ Light Gray Q
 - ◆ Loft LOFT
 - ◆ Muslin T3
 - ◆ Putty L
 - ◆ Sage P095
 - ◆ Titanium P8T
- P2**
- ◆ Champagne Metallic T4
 - ◆ Gunmetal Metallic PR3
 - ◆ Platinum Metallic T1

OPTIONAL LAMINATE TOPS FOR LATERAL FILES

L1 LAMINATES CODES

- Woodgrain**
- ◆ Bourbon Cherry H
 - ◆ Cognac COGN
 - ◆ Field Elm LWFE
 - ◆ Florence Walnut LFW1
 - ◆ Harvest C
 - ◆ Kingswood Walnut LK11
 - ◆ Mahogany N
 - ◆ Mocha MOCH
 - ◆ Natural Maple D
 - ◆ Pinnacle PINC
 - ◆ Shaker Cherry F
 - ◆ Sterling Ash LSA1

Solid

- ◆ Charcoal S
- ◆ Designer White LDW1
- ◆ Loft LOFT

Patterned

- ◆ Handspun Chestnut LAHC
- ◆ Handspun Dove LAHD
- ◆ Handspun Pearl LAHP
- ◆ Handspun Slate LAHS
- ◆ Silver Mesh* B9
- ◆ Steel Mesh* A9
- ◆ Gray* G2
- ◆ White* G1

L2 LAMINATES CODES

- Woodgrain**
- ◆ Beigewood LWBE
 - ◆ Fawn Cypress LFC1
 - ◆ Lowell Ash LLA1
 - ◆ Natural Recon LNRI
 - ◆ Phantom Ecrú LPE1
 - ◆ Portico Teak LPT1
 - ◆ Skyline Walnut LSW1

PULL OPTIONS FOR FLAGSHIP® STORAGE

Suffix "A"



Arch
Drawer Pull

Suffix "N"



Full Face Integral
Drawer Pull

Suffix "R"



Full Radius
Drawer Pull

NOTES: Arch pulls available in Satin Chrome only.

* Laminate colors will have the following pre-set edgeband colors:

Laminate	Edge
Handspun Chestnut	Loft
Handspun Dove	Loft
Handspun Pearl	Loft
Handspun Slate	Charcoal
Silver Mesh	Loft
Steel Mesh	Charcoal
Gray	Charcoal
White	Charcoal

Edgeband matches top except as noted.



For Champagne Metallic Paint, Muslin is the suggested edgeband color. When Champagne Metallic Paint is selected, pulls are standard in Muslin.

◆◆◆ For lead time information see page 21.

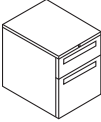

Icon Legend on page 19

Hanging and Standard Height Pedestals

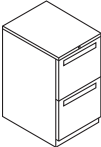
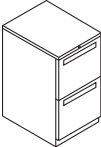
	DESCRIPTION	MODEL	SHIP WEIGHT	CUBE	LIST PRICE BY PAINT GRADE		
					P1	P2	P3
	Hanging Pedestals — Box/File						
	15"W x 16 ⁷ / ₈ "D x 19 ¹ / ₂ "H 15"W x 22 ⁷ / ₈ "D x 19 ¹ / ₂ "H	H14917(?) H14923(?)	41 48	4.4 6.0	\$719 \$765	\$749 \$795	\$778 \$824
	Standard Height Mobile Pedestals — Box/Box/File						
	15"W x 16 ⁷ / ₈ "D x 28"H 15"W x 22 ⁷ / ₈ "D x 28"H 15"W x 28 ⁷ / ₈ "D x 28"H	H18717(?) H18723(?) H18730(?)	76 88 102	5.9 8.0 9.8	\$920 \$991 \$1063	\$950 \$1021 \$1093	\$979 \$1050 \$1122
	Standard Height Mobile Pedestals — File/File						
	15"W x 16 ⁷ / ₈ "D x 28"H 15"W x 22 ⁷ / ₈ "D x 28"H 15"W x 28 ⁷ / ₈ "D x 28"H	H18817(?) H18823(?) H18830(?)	72 85 98	5.9 8.0 9.8	\$920 \$991 \$1063	\$950 \$1021 \$1093	\$979 \$1050 \$1122
	Standard Height Freestanding Support Pedestals — Box/Box/File						
	15"W x 16 ⁷ / ₈ "D x 28"H 15"W x 22 ⁷ / ₈ "D x 28"H 15"W x 28 ⁷ / ₈ "D x 28"H	H19717(?) H19723(?) H19730(?)	59 73 87	5.9 8.0 9.8	\$908 \$975 \$1049	\$938 \$1005 \$1079	\$967 \$1034 \$1108
	Standard Height Freestanding Support Pedestals — File/File						
	15"W x 16 ⁷ / ₈ "D x 28"H 15"W x 22 ⁷ / ₈ "D x 28"H 15"W x 28 ⁷ / ₈ "D x 28"H	H19817(?) H19823(?) H19830(?)	55 70 83	5.9 8.0 9.8	\$908 \$975 \$1049	\$938 \$1005 \$1079	\$967 \$1034 \$1108

STORAGE

NOTES:

- 28"H fits under all HON worksurfaces and desk shells.
 - 22⁷/₈"D and 28⁷/₈"D pedestals accommodate legal files side-to-side.
 - Pencil tray standard in top box drawer.
 - One box divider standard in each box drawer.
 - One crossrail standard in each file drawer.
 - Steel ball-bearing suspension on file and box drawers.
 - Full extension on all drawers.
 - File drawers have high sides for filing front-to-back.
 - See pages 670-671 for accessories and pedestal utilization information.
 - Equipped with HON "One Key" interchangeable core removable locks.
 - Hanging units are mounted using keyhole slots in top of pedestals; all hardware provided.
 - Counterweight standard in mobile pedestals.
 - Omit lock-option available. See page 699 for ordering instructions.
 - See Brigade® pedestals on page 573 for additional pedestal options. See pages 670-671 for Pedestal Accessories.
- ! Freestanding support pedestals that are not positioned and attached under a worksurface require a counterweight kit found on page 670.

HOW TO SPECIFY

<p>Select Model Number</p> <p>A Satin Chrome Arch N Full Face Integral R Full Radius</p> <p>H 1 4 9 1 7 A</p>	<p>Select Lock Option</p> <p>L Lock (no upcharge) X Omit Lock (deduct \$20)</p> <p>L</p>	<p>Select Paint Color</p> <p>See page 626</p> <p>P</p>
---	--	--

FLAGSHIP® Mobile Pedestals

GSA SIN 33721



Icon Legend on page 19



H15923N

DESCRIPTION	MODEL	SHIP WEIGHT	CUBE	LIST PRICE BY PAINT GRADE		
				P1	P2	P3
Mobile Pedestals — Box/File 15"W x 22 ⁷ / ₈ "D x 22"H	H15923(?)	92	6.0	\$773	\$803	\$832

STORAGE

NOTES:

- Pencil tray standard in top box drawer.
- One box divider standard in each box drawer.
- One crossrail standard in each file drawer.
- File drawers have high sides for filing front-to-back.
- Steel ball-bearing suspension on file drawer, and box drawer.
- See pages 670-671 for accessories and pedestal utilization information.
- Equipped with HON "One Key" interchangeable core removable locks.
- Counterweight standard.
- Omit lock-option available. See page 699 for ordering instructions.

HOW TO SPECIFY

<p>Select Model Number</p> <p>A Satin Chrome Arch N Full Face Integral R Full Radius</p> <p>H 1 5 9 2 3 A .</p>	<p>Select Lock Option</p> <p>L Lock (no upcharge) X Omit Lock (deduct \$20)</p> <p>L .</p>	<p>Select Paint Color</p> <p>See page 626</p> <p>T 1</p>
--	---	---

DESCRIPTION	MODEL	SHIP WEIGHT	CUBE	FABRIC PRICE CODES			
<p>Pedestal Seat 15"W x 22⁷/₈"D x 2"H</p>	HPSEAT24ND	10	1.2	1	\$267	8	\$472
				2	\$293	9	\$505
				3	\$318	10	\$537
				4	\$343	11	\$570
				5	\$375	12	\$602
				6	\$408	L	—
				7	\$440		

NOTES:

- See Brigade® pedestals on page 573 for additional pedestal options. See pages 670-671 for Pedestal Accessories.

HOW TO SPECIFY

<p>Select Model Number</p> <p>H P S E A T 2 4 N D .</p>	<p>Select Fabric</p> <p>See pages 22-24 for seating fabric options</p> <p>C U I 0</p>
--	--



Icon Legend on page 19

18" Deep Lateral Files with Drawers

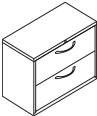
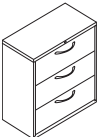
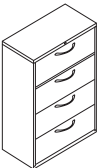
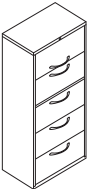
	DESCRIPTION	MODEL	SHIP WEIGHT	CUBE	LIST PRICE BY PAINT GRADE		
					P1	P2	P3
 Standard Height	Standard Height Lateral File — 2 Drawer						
	30"W x 18"D x 28"H	H9170(?)	138	12.3	\$1299	\$1334	\$1370
	36"W x 18"D x 28"H	H9180(?)	156	14.5	\$1436	\$1471	\$1507
	42"W x 18"D x 28"H	H9190(?)	177	16.8	\$1660	\$1695	\$1731
 Lateral File — 3 Drawer	30"W x 18"D x 39 ¹ / ₈ "H	H9173(?)	150	16.9	\$1701	\$1736	\$1772
	36"W x 18"D x 39 ¹ / ₈ "H	H9183(?)	174	20.0	\$1909	\$1944	\$1980
	42"W x 18"D x 39 ¹ / ₈ "H	H9193(?)	197	23.2	\$2209	\$2244	\$2280
 Lateral File w/o Posting Shelf — 4 Drawer	30"W x 18"D x 52 ¹ / ₂ "H	H9174(?)	176	22.1	\$2143	\$2214	\$2282
	36"W x 18"D x 52 ¹ / ₂ "H	H9184(?)	198	26.2	\$2432	\$2503	\$2571
	42"W x 18"D x 52 ¹ / ₂ "H	H9194(?)	213	30.3	\$2789	\$2860	\$2928
 Lateral File w/o Posting Shelf — 5 Drawer	30"W x 18"D x 64 ¹ / ₄ "H	H9175(?)	203	26.8	\$2735	\$2806	\$2874
	36"W x 18"D x 64 ¹ / ₄ "H	H9185(?)	238	31.8	\$3080	\$3151	\$3219
	42"W x 18"D x 64 ¹ / ₄ "H	H9195(?)	264	36.8	\$3570	\$3641	\$3709
	NOTES: Top drawer is a roll-out shelf.						

STORAGE

NOTES:

- 28"H lateral fit under standard 38000 Series and worksurfaces.
- Flush top and sides.
- Reinforced case construction.
- Lock mechanism serves both sides of drawer.
- Equipped with HON "One Key" interchangeable core removable locks.
- Counterweight included where applicable to meet ANSI/BIFMA stability requirements.
- Three-part, telescoping, steel ball-bearing suspension.
- Features drawer extension restraint; mechanical interlock inhibits the extension of more than one drawer at a time.
- Optional laminate tops and accessories — see page 667.
- Matching Pedestals — see page 627.
- Omit lock-option available. See page 699 for ordering instructions.
- See page 667 for Lateral File Accessories.
- Flagship® laterals can be used with Storage Islands, see page 651.

HOW TO SPECIFY

<p>Select Model Number</p> <p>Select the Pull</p> <p>A Satin Chrome Arch N Full Face Integral R Full Radius</p> <p>H 9 1 7 0 A</p>	<p>Select Lock Option</p> <p>L Lock (no upcharge) X Omit Lock (deduct \$20)</p> <p>L</p>	<p>Select Paint Color</p> <p>See page 626</p> <p>P</p>
--	---	--

FLAGSHIP® Lateral File with Storage

GSA SIN 33721



Icon Legend on page 19

DESCRIPTION	MODEL	SHIP WEIGHT	CUBE	LIST PRICE BY PAINT GRADE		
				P1	P2	P3
Lateral Files with Storage and Hinged Doors 36"W x 18"D x 64¼"H NOTES: Lateral File drawers lock independently from storage case.	H9185LS(?)	203	31.8	\$2952	\$3023	\$3091

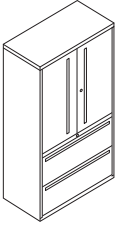

Model H9185LSN shown

Lateral Files with Open Shelves, No Doors 36"W x 18"D x 64¼"H	H9185LSN(?)	184	31.8	\$2692	\$2763	\$2831
---	--------------------	-----	------	---------------	---------------	---------------

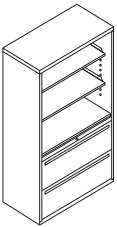

Model H9185LSNN shown

NOTES:

- 64¼"H models complement Flagship lateral file heights.
- Equipped with HON "One Key" interchangeable core removable locks. Locks on storage cabinet doors and lateral file are keyed alike.
- Three-part, telescoping, steel ball-bearing suspension.
- Includes two adjustable shelves, adjustable in 2" increments.
- Lock mechanism serves both sides of drawer.
- Features drawer extension restraint; mechanical interlock inhibits the extension of more than one drawer at a time.
- Wire management grommet in back of unit.
- Omit lock-option available. See page 699 for ordering instructions.
- Flush top and sides.

HOW TO SPECIFY

<p>Select Model Number</p> <p>Select the Pull</p> <p>A Satin Chrome Arch N Full Face Integral R Full Radius</p> <p>H 9 1 8 5 L S A .</p>	<p>Select Lock Option</p> <p>L Lock (no upcharge) X Omit Lock (deduct \$40 for model H9185LS) (deduct \$20 for model H9185LSN)</p> <p>L .</p>	<p>Select Paint Color</p> <p>See page 626</p> <p>P</p>
--	--	--



Icon Legend on page 19

FLAGSHIP® Modular Storage

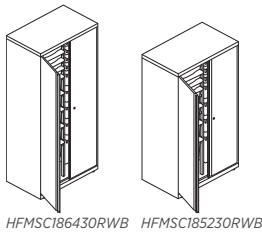

HFMSC186430RWB HFMSC185230RWB

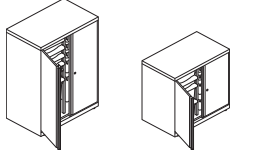

HFMSC183930RWB HFMSC182830RWB

DESCRIPTION

Modular Storage Cabinet
 18"D x 28"H x 30"W
 18"D x 39 1/8"H x 30"W
 18"D x 52 1/2"H x 30"W
 18"D x 64 1/4"H x 30"W

MODEL	SHIP WEIGHT	CUBE	LIST PRICE BY PAINT GRADE		
			P1	P2	P3
HFMSC182830RWB	119	12.0	\$1373	\$1408	\$1444
HFMSC183930RWB	138	16.2	\$1663	\$1698	\$1734
HFMSC185230RWB	176	22.4	\$2008	\$2079	\$2147
HFMSC186430RWB	184	28.2	\$2340	\$2411	\$2479

NOTES:

- Shipped fully assembled.
- Pre-configured trays and rails are included, see chart below.
- Additional Tray Kits may be purchased separately.
- Full radius handle on both doors.
- Four adjustable leveling glides standard.
- Reinforced top and base.
- Equipped with HON "One Key" interchangeable core removable locks standard.
- Doors have vertical stiffener standard.
- Positive door stops.
- Meets or exceeds ANSI/BIFMA and ISTA standards.
- Certified SCS Indoor Advantage Gold.

Pre-Configured Cabinets/Tray Kits

64" High Cabinet		52" High Cabinet		39" High Cabinet		28" High Cabinet	
1	2	1	2	1	2	1	2
3	4	3	4	3	4	3	4
5	6	5	6	5	6	5	6
7	8	7	8	7	8	7	8
1	2	1	2	1	2	1	2
3	4	3	4	3	4	3	4
5	6	5	6	5	6	5	6
7	8	7	8	7	8	7	8
1	2	1	2	1	2	1	2
						3	4

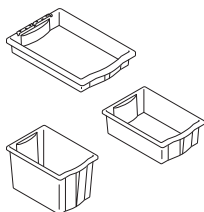

DESCRIPTION

Accessories — Tray Kit
 3"H, 2 bins and 4 rails
 6"H, 2 bins and 4 rails
 12"H, 2 bins and 4 rails

MODEL	SHIP WEIGHT	CUBE	LIST PRICE
HFMBIN3	7 Ⓞ	4.0	\$77
HFMBIN6	10 Ⓞ	4.5	\$92
HFMBIN12	12 Ⓞ	5.0	\$108

NOTES: Modular Storage Cabinets come with rails and bins. Additional bins and rails may be ordered in sets of 2. Availability and usage are outlined below.

NOTES:

- Tray height options include: 3", 6", 12".
- Trays may only be used in 12" width single column/section only.
- All trays are suspended off a pair of storage rails, trays slide easily in and out and are removable.
- Trays and storage rails are field installed and may be easily reconfigured.
- Front and rear handles are integrated for easy handling/transport.
- Translucent material provides visibility to contents.

HOW TO SPECIFY

<p>Select Model Number</p> <p>H F M S C 1 8 6 4 3 0 R W B .</p>	<p>Select Lock Option</p> <p>L Lock (no upcharge) X Omit Lock (deduct \$20) See page 699 for omit lock ordering instructions</p> <p>L .</p>	<p>Select Glide</p> <p>G Glide</p> <p>G .</p>	<p>Select Paint Color</p> <p>See page 626</p> <p>L D W 1</p>
--	--	--	---

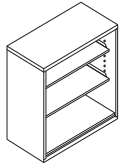

DESCRIPTION

3 Shelf
36"W x 18"D x 39½"H

MODEL	SHIP WEIGHT	CUBE	LIST PRICE BY PAINT GRADE		
			P1	P2	P3
HFSC183640W	100	20.0	\$1136	\$1207	\$1275

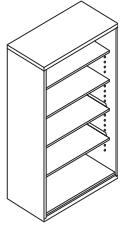

5 Shelf
36"W x 18"D x 64¼"H

NOTES: 64¼"H models complement Flagship lateral file heights.

HFSC183664W	148	31.8	\$1682	\$1753	\$1821
--------------------	-----	------	---------------	---------------	---------------

STORAGE

NOTES:

- Flush top and sides.
- Reinforced case construction.
- Shelves adjust in 2" increments.
- Wire management grommet in back of unit.

HOW TO SPECIFY

Select Model Number

HFSC183640W.

Select Paint Color

See page 626

P



Icon Legend on page 19

FLAGSHIP® Storage Cabinets

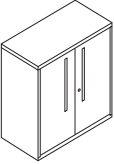
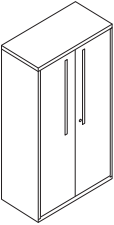
	DESCRIPTION	MODEL	SHIP WEIGHT	CUBE	LIST PRICE BY PAINT GRADE		
					P1	P2	P3
 Model HFSC183640N shown	Storage Cabinets 36"W x 18"D x 39 7/8"H (with lock) 2 adjustable shelves	HFSC183640(?)	119	20.0	\$1407	\$1478	\$1546
 Model HFSC183664N shown	Storage Cabinets 36"W x 18"D x 64 1/4"H (with lock) 4 adjustable shelves NOTES: 64 1/4"H models complement Flagship lateral file heights.	HFSC183664(?)	184	31.8	\$2050	\$2121	\$2189

STORAGE

NOTES:

- Flush top and sides.
- Reinforced case construction.
- Includes adjustable shelves, adjustable in 2" increments.
- Four adjustable leveling glides are standard.
- Equipped with HON "One Key" interchangeable core removable locks.
- Wire management grommet in back of unit.
- Omit lock-option available. See page 699 for ordering instructions.

HOW TO SPECIFY

<p>Select Model Number</p> <p>Select the Pull</p> <p>A Satin Chrome Arch N Full Face Integral R Full Radius</p> <p>H F S C 1 8 3 6 4 0 A</p>	<p>Select Lock Option</p> <p>L Lock (no upcharge) X Omit Lock (deduct \$20)</p> <p>L</p>	<p>Select Paint Color</p> <p>See page 626</p> <p>P</p>
---	---	--

FLAMESAFE™ ORDERING INFORMATION

FLAMESAFE™ PRODUCTS

PAINTS CODES

P1

- ◆ Black P
- ◆ Light Gray Q
- ◆ Putty L

STORAGE

◆◆◆ For lead time information see page 21.



FLAMESAFE™ Fire-Resistant Files

STORAGE

	DESCRIPTION	MODEL	SHIP WEIGHT	CUBE	LIST PRICE
	Vertical File — 2-Drawer, Letter 17¾"W x 25"D x 27¾"H	H52 *	304	10.0	\$5543
	Vertical File — 2-Drawer, Legal 20¾"W x 25"D x 27¾"H	H52C	330	13.0	\$5684
	Vertical File — 4-Drawer, Letter 17¾"W x 25"D x 52¾"H	H54 *	531	17.0	\$8532
	Vertical File — 4-Drawer, Legal 20¾"W x 25"D x 52¾"H	H54C *	561	21.0	\$8711

NOTES:

- Full suspension.
- Non-asbestos.
- Follower block comes standard.
- Chrome drawer pulls, thumb latch and label holder.
- Rated: Filing Device Class 350, 1700° for one hour with drop test.
- UL listed.
- High drawer sides.
- Insulated in drawer face and between drawers.
- **Full Lifetime Warranty.**
- ! Lock is NOT core removable.
- * De-emphasized.

HOW TO SPECIFY

<p>Select Model Number</p> <p>H 5 2 .</p>	<p>Select Lock Option</p> <p>P Lock</p> <p>P .</p>	<p>Select Paint Color</p> <p>See page 634</p> <p>P</p>
--	---	---

	DESCRIPTION	MODEL	SHIP WEIGHT	CUBE	LIST PRICE
	Lateral File — 2-Drawer 31½"W x 22½"D x 27¾"H	H32 *	470	11.0	\$8162
	Lateral File — 4-Drawer 31½"W x 22½"D x 52¾"H NOTES: Lateral Drawer inside dimensions: 25¾"W x 15½"D x 10¾"H	H34 *	795	26.0	\$12317

NOTES:

- Telescoping suspension.
- Non-asbestos.
- Rated: Filing Device Class 350, 1700° for one hour with drop test.
- Insulated in drawer face and between drawers.
- UL listed.
- 4 hangrails per opening, standard.
- Black, plastic recessed drawer pulls.
- **Full Lifetime Warranty.**
- ! Lock is NOT core removable.
- * De-emphasized.

HOW TO SPECIFY

<p>Select Model Number</p> <p>H 3 2 .</p>	<p>Select Lock Option</p> <p>P Lock</p> <p>P .</p>	<p>Select Paint Color</p> <p>See page 634</p> <p>P</p>
--	---	---



Fuse™ Storage shown with Solve® Seating and Coordinate™ Desk.

FUSE™

Who says storage has to be boring? With a completely modern take on form and function, not to mention an ultra-cool color palette, Fuse storage adds personality to any home office or corporate workspace. With personal storage space for just about everything, Fuse keeps you organized even in small spaces.



FEATURES

- Designed to make the most of the compressed footprint of desking, benching and height-adjustable workstations.
- Extra thick, low profile case provides increased strength and durability while providing a modern 360-degree aesthetic for your storage needs.
- Extended height drawers give you the extra capacity to neatly store what matters most to you.
- Add a pop of color with an optional two-tone design to give new meaning to personal space.
- Alcove for stowing backpack, purse, bag, or other personal items.
- Rear casters swivel and front casters are fixed for easier mobility.
- Casters are designed to clear the top of Coordinate™ feet.
- File drawer has high sides to allow front-to-back filing for 15" wide models.
- Side-to-side filing uses file bars for support for 10" wide models.
- Standard core removable locks make rekeying a breeze.
- Electronic keypad lock option allows for ease of locking and unlocking personal items with your Fuse™ unit.

FUSE™ ORDERING INFORMATION

FUSE™ PRODUCTS

PAINTS	CODES
P1	
◆ Black	P
◆ Brownstone	P7D
◆ Charcoal	P02
◆ Cove	P096
◆ Designer White	PJW
◆ Dune	P094
◆ Fossil***	P28
◆ Greige	T5
◆ Harbor	P097
◆ Loft	LOFT
◆ Muslin	T3
◆ Sage	P095
◆ Textured Charcoal	P7A
◆ Textured Designer White	PK7
◆ Titanium	P8T
P2*	
◆ Champagne Metallic	T4
◆ Gunmetal Metallic	PR3
◆ Silver	PR6
◆ Solar Black	P8X
P3**	
◆ Amethyst*	P091
◆ Atom	P8S
◆ Blossom***	P8K
◆ Bullseye	PJF
◆ Cobalt Mica*	P090
◆ Ember	P8P
◆ Ion	P8N
◆ Iris	P8J
◆ Krypton	P8F
◆ Ochre	P093
◆ Regatta	P8M
◆ Sienna	P092
◆ Succulent***	P8A

PULLS

◆ Linear Black	LP
◆ Linear Silver	LPR6
◆ Square Silver	SPR6

WORKPLACE TOOLS

◆ Designer White	DW
------------------	----

PULL OPTIONS FOR FUSE™ STORAGE



Square

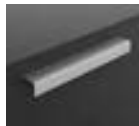

Linear

*P2 upcharges \$19 for each dot option selected.

**P3 upcharges \$42 for each dot option selected.

***TREND COLORS: These colors are intended to be an inspirational option for the trending market. Product application is limited and color availability is approximately two years to coincide with evolving workplace trends.

- The HON Company has elected to discontinue the HON Choice paint program, as of 12/31/2018, and roll it into our standard specials process.
- A special request will need to be submitted to receive pricing and order information.

◆◆◆ For lead time information see page 21.

* De-emphasized

FUSE™ Pedestals

Fuse Pedestal Functionality with Workplace Tools

STORAGE

Large & Slim Trays

- Ships in 9" and/or 15" bin drawers where applicable
- Organizes notepads, rulers, pens, pencils, paper clips, sticky notes, etc
- Radiused compartments allow for easy pick up of those small items
- Versatile tray can be utilized on top of your pedestal, drawers, or on the worksurface

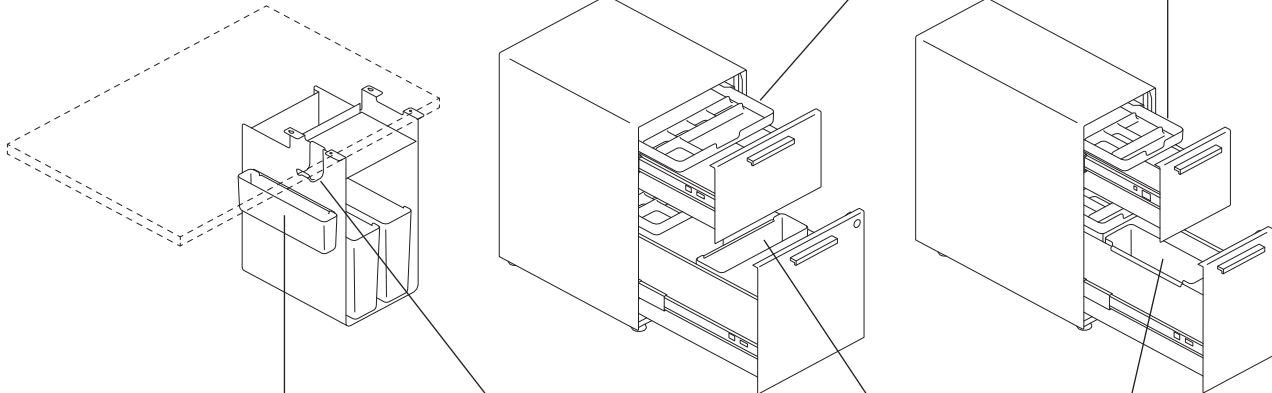

Side Saddle

- Stores small personal items such as your phone, tablet, and other organizational items
- Hangs on the drawer side, sits on the drawer bottom, undermount side slot and case top.
- Division in the bottom creates two storage areas
- Also hangs on the paper management support bars on page 407

Hook

- Used to hang backpacks, coats, headphones, umbrellas, and other personal items
- Can be used only in the undermount side slot or case top lip
- Thoughtfully designed to stay in place
- Supports up to 20 pounds

Hot File

- Take multiple project folders with you to your next meeting
- Ridges in the bottom keep files upright
- Hangs on the drawer side, undermount or sit in the drawer bottom to subdivide space
- Makes files accessible without having to even open a drawer
- Also hangs on the paper management support bars on page 407

Configuration Options - Fuse

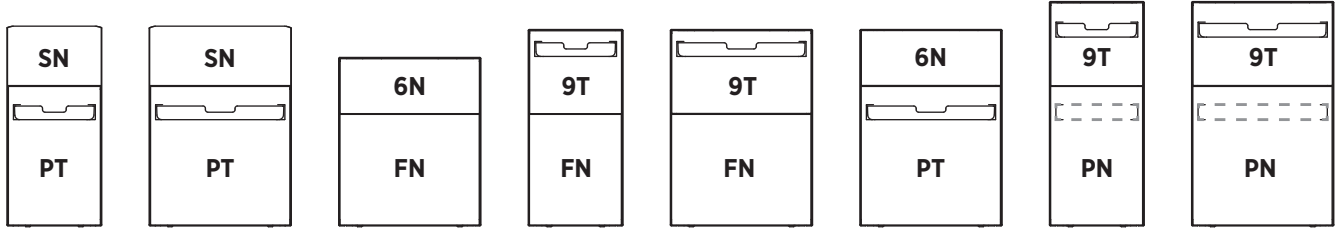

Legend

- 6N = 6" Box No Tray
- 9T = 9" Box Bin with Tray
- SN = Alcove
- FN = 12" File No Tray
- PN = 15" File No Tray
- PT = 15" Bin with Tray

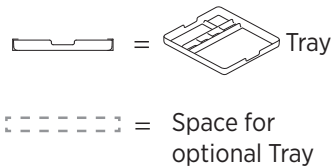

FUSE™ DIGITAL LOCK SPECIFICATIONS

Digital Keypad Lock Specification Information for Fuse™ Pedestals

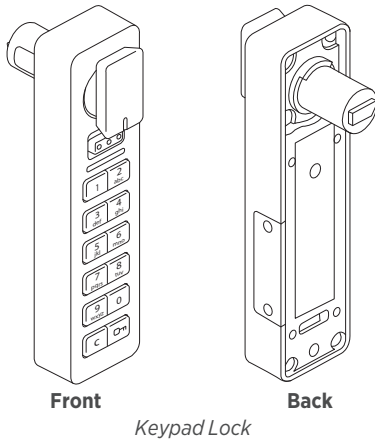

Keypad Lock

The digital keypad lock option helps modernize the workspace by eliminating the need to carry physical keys. The digital lock feature provides an alternative to standard lock and key, allowing users to simply input a code to unlock their Fuse™ storage unit. The digital keypad also supports shared applications where workstations or storage units support multiple users. These locks ship in “shared mode” by default; shared mode indicates that the lock will “forget” the paired 4-digit code after the lock is opened, allowing the unit to be used by multiple users.

❗ Order at least one Programming Key and Manager Key per install.

Digital Keypad Locks:

- Offered on all Fuse™ pedestal and undermount models.
- Ship factory installed.
- Offered in a brushed nickel finish.
- Digital keypad lock requires input of a user-selected 4-digit code.
- Digital keypad locks are powered using 2 premium lithium CR2032 batteries.
- Battery life is dependent on the frequency of operation but can last up to 5-7 years.
- **Every digital keypad installation site will require *one* Programming Key and *at least one* Manager Key, sold separately.**

Programming Key

- A Programming Key is a device used to initialize locks out of factory default mode and register Manager Keys to the locks.
- Only one Programming Key should be specified per installation site because multiple Programming Keys are not compatible with each other.
- Add-on digital lock orders should be programmed with the original Programming Key.
- Programming Key is the same key as Contain® Digilocks and can work across both Contain® and Fuse™.

Manager Key

- A Manager Key is used to bypass a locked unit; this operates as the “master key” and it is recommended that building facilitators have at least one Manager Key.
- Up to 6 Manager Keys may be registered to each lock.
- Manager Keys provide external power to locks in case of battery failure.

Digital Lock Keys and Accessories		
Description	Model	List Price
Programming Key	HSLDIGPRG	\$160
Manager Key	HSLDIGMGR	\$125

FUSE™ Mobile Pedestals

GSA SIN 33721



Icon Legend on page 19

STORAGE

	DESCRIPTION	MODEL	SHIP WEIGHT	CUBE	LIST PRICE
	Mobile Pedestal, 6" Box/12" File 15"W x 19"D x 20 ³ / ₈ "H	HAPMAP196NFN	48	5.0	\$800
	15"W x 23"D x 20 ³ / ₈ "H NOTES: No tray, Specification of tray color not required.	HAPMAP236NFN	54	5.9	\$859
	Mobile Pedestal, 9" Bin with Tray/12" File 15"W x 19"D x 23 ³ / ₈ "H	HAPMBP199TFN	53	5.7	\$902
	15"W x 23"D x 23 ³ / ₈ "H	HAPMBP239TFN	58	6.7	\$965
	Mobile Pedestal, 6" Box/15" Bin with Tray 15"W x 19"D x 23 ³ / ₈ "H	HAPMBP196NPT	53	5.7	\$902
	15"W x 23"D x 23 ³ / ₈ "H	HAPMBP236NPT	58	6.7	\$965
	Mobile Pedestal, 9" Bin with Tray/15" Bin 15"W x 19"D x 26 ³ / ₈ "H	HAPMCP199TPN	58	6.4	\$972
	15"W x 23"D x 26 ³ / ₈ "H	HAPMCP239TPN	62	7.5	\$1032
	Mobile Pedestal, Alcove/15" File with Tray 15"W x 19"D x 21 ¹ / ₂ "H NOTES: Top matches drawer color.	HAPMBP19SNPT	58	5.7	\$840
	Slim Mobile Pedestal, 9" Bin with Tray/12" File 10"W x 23"D x 23 ³ / ₈ "H	HAPMBS239TFN ☺	47	4.9	\$918
	Slim Mobile Pedestal, 9" Bin with Tray/15" Bin 10"W x 23"D x 26 ³ / ₈ "H	HAPMCS239TPN	52	5.4	\$988
	Slim Mobile Pedestal, Alcove/15" Bin with Tray 10"W x 23"D x 21 ¹ / ₂ "H NOTES: Top matches drawer color.	HAPMBS23SNPT	43	4.9	\$855

HOW TO SPECIFY

Select Model Number	Select Pull Option	Select Case Color	Select Drawer Color	Select Tray Color	Select Lock Option
	SPR6 Square Silver LPR6 Linear Silver LP Linear Black	See page 637 P2 upcharge (+ \$19) P3 upcharge (+ \$42)	See page 637 P2 upcharge (+ \$19) P3 upcharge (+ \$42)	DW Designer White	L Standard Lock X Omit Lock (deduct \$20)
H A P M A P 1 9 6 N F N .	S P R 6 .	P .	P .	D W .	L .



Icon Legend on page 19

Mobile Pedestals with eLock

STORAGE

	DESCRIPTION	MODEL	SHIP WEIGHT	CUBE	LIST PRICE
	Mobile Pedestal, 6" Box/12" File, eLock 15"W x 19"D x 20 3/8"H 15"W x 23"D x 20 3/8"H NOTES: No tray, Specification of tray color not required.	HAPMAP196NFNE HAPMAP236NFNE	48 54	5.0 5.9	\$1101 \$1159
	Mobile Pedestal, 9" Box/12" File, eLock 15"W x 19"D x 23 3/8"H 15"W x 23"D x 23 3/8"H	HAPMBP199TFNE HAPMBP239TFNE	53 58	5.7 6.7	\$1202 \$1266
	Mobile Pedestal, 6" Box/15" File, eLock 15"W x 19"D x 23 3/8"H 15"W x 23"D x 23 3/8"H	HAPMBP196NPTE HAPMBP236NPTE	53 58	5.7 6.7	\$1202 \$1266
	Mobile Pedestal, 9" Box/15" File, eLock 15"W x 19"D x 26 3/8"H 15"W x 23"D x 26 3/8"H	HAPMCP199TPNE HAPMCP239TPNE	58 62	6.4 7.5	\$1272 \$1332
	Mobile Pedestal, Alcove/15" File, eLock 15"W x 19"D x 21 1/2"H NOTES: Top matches drawer color.	HAPMBP19SNPTE	45	5.7	\$1140
	Slim Mobile Pedestal, 9" Box/12" File, eLock 10"W x 23"D x 23 3/8"H	HAPMBS239TFNE	47	4.9	\$1219
	Slim Mobile Pedestal, 9" Box/15" File, eLock 10"W x 23"D x 26 3/8"H	HAPMCS239TPNE	52	5.4	\$1289
	Slim Mobile Pedestal, Alcove/15" File, eLock 10"W x 23"D x 21 1/2"H NOTES: Top matches drawer color.	HAPMBS23SNPTE	43	4.9	\$1155

NOTES:

ⓘ Every installation will require one Programming Key and at least one Manager Key.

HOW TO SPECIFY

Select Model Number	Select Pull Option	Select Case Color	Select Drawer Color	Select Tray Color	Select Lock Option
SPR6 Square Silver LPR6 Linear Silver LP Linear Black	See page 637 P2 upcharge (+ \$19) P3 upcharge (+ \$42)	See page 637 P2 upcharge (+ \$19) P3 upcharge (+ \$42)	DW Designer White	EBNL eLock Brushed Nickel	
H A P M A P 1 9 6 N F N E .	S P R 6 .	P .	P .	D W .	E B N L

FUSE™ Freestanding Pedestals

GSA SIN 33721



Icon Legend on page 19

STORAGE

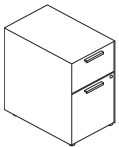
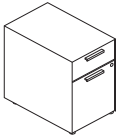
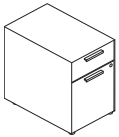
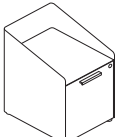
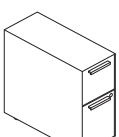
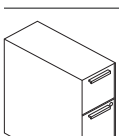
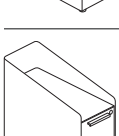
	DESCRIPTION	MODEL	SHIP WEIGHT	CUBE	LIST PRICE
	Freestanding Pedestal, 9" Bin with Tray/12" File 15"W x 19"D x 21"H	HAPGBP199TFN	53	5.7	\$877
	15"W x 23"D x 21"H	HAPGBP239TFN	58	5.7	\$937
	Freestanding Pedestal, 6" Box/15" Bin with Tray 15"W x 19"D x 21"H	HAPGBP196NPT	53	5.7	\$877
	15"W x 23"D x 21"H	HAPGBP236NPT	58	5.7	\$937
	Freestanding Pedestal, 9" Bin with Tray/15" Bin 15"W x 19"D x 24"H	HAPGCP199TPN	58	5.7	\$942
	15"W x 23"D x 24"H	HAPGCP239TPN	62	5.7	\$1004
	Freestanding Pedestal, Alcove/15" Bin with Tray 15"W x 19"D x 21"H NOTES: Top matches drawer color.	HAPGBP195NPT	45	5.7	\$816
	Slim Freestanding Pedestal, 9" Bin with Tray/12" File 10"W x 23"D x 21"H	HAPGBS239TFN	47	5.7	\$892
	Slim Freestanding Pedestal, 9" Bin with Tray/15" Bin 10"W x 23"D x 24"H	HAPGCS239TPN	52	5.4	\$958
	Slim Freestanding Pedestal, Alcove/15" Bin with Tray 10"W x 23"D x 21"H NOTES: Top matches drawer color.	HAPGBS235NPT	43	4.9	\$831

HOW TO SPECIFY

Select Model Number	Select Pull Option	Select Case Color	Select Drawer Color	Select Tray Color	Select Lock Option
	SPR6 Square Silver LPR6 Linear Silver LP Linear Black	See page 637 P2 upcharge (+ \$19) P3 upcharge (+ \$42)	See page 637 P2 upcharge (+ \$19) P3 upcharge (+ \$42)	DW Designer White	L Standard Lock X Omit Lock (deduct \$20)
H A P G B P 1 9 9 T F N .	S P R 6 .	P .	P .	D W .	L .



Icon Legend on page 19

Freestanding Pedestals with eLock

	DESCRIPTION	MODEL	SHIP WEIGHT	CUBE	LIST PRICE
	Freestanding Pedestal, 9" Box/12" File, eLock				
	15"W x 19"D x 21"H 15"W x 23"D x 21"H	HAPGBP199TFNE HAPGBP239TFNE	53 58	5.7 6.7	\$1177 \$1237
	Freestanding Pedestal, 6" Box/15" File, eLock				
	15"W x 19"D x 21"H 15"W x 23"D x 21"H	HAPGBP196NPTE HAPGBP236NPTE	53 58	5.7 6.7	\$1177 \$1237
	Freestanding Pedestal, 9" Box/15" File, eLock				
	15"W x 19"D x 24"H 15"W x 23"D x 24"H	HAPGCP199TPNE HAPGCP239TPNE	58 62	6.4 7.5	\$1243 \$1304
	Freestanding Pedestal, Alcove/15" File, eLock 15"W x 19"D x 21"H NOTES: Top matches drawer color.	HAPGBP195NPTE	45	5.7	\$1116
	Slim Freestanding Pedestal, 9" Box/12" File, eLock 10"W x 23"D x 24"H	HAPGBS239TFNE	47	4.9	\$1193
	Slim Freestanding Pedestal, 9" Box/15" File, eLock 10"W x 23"D x 24"H	HAPGCS239TPNE	52	5.4	\$1258
	Slim Freestanding Pedestal, Alcove/15" File 10"W x 23"D x 24"H NOTES: Top matches drawer color.	HAPGBS235NPTE	43	4.9	\$1131

STORAGE

NOTES:

! Every installation will require one Programming Key and at least one Manager Key.

HOW TO SPECIFY

<p>Select Model Number</p> <p>H A P G B P 1 9 9 T F N E .</p>	<p>Select Pull Option</p> <p>SPR6 Square Silver LPR6 Linear Silver LP Linear Black</p> <p>S P R 6 .</p>	<p>Select Case Color</p> <p>See page 637 P2 upcharge (+ \$19) P3 upcharge (+ \$42)</p> <p>P .</p>	<p>Select Drawer Color</p> <p>See page 637 P2 upcharge (+ \$19) P3 upcharge (+ \$42)</p> <p>P .</p>	<p>Select Tray Color</p> <p>DW Designer White</p> <p>D W .</p>	<p>Select Lock Option</p> <p>EBNL eLock Brushed Nickel</p> <p>E B N L</p>
--	--	--	--	---	--

FUSE™ Pedestal Cushion

GSA SIN 33721



Icon Legend on page 19

	DESCRIPTION	MODEL	SHIP WEIGHT	CUBE	FABRIC PRICE CODES			
	Seat Cushion For 19"D Pedestal	HAESC19	6	1.0	1	\$250	8	\$395
					2	\$276	9	\$414
					3	\$301	10	\$432
					4	\$319	11	\$451
					5	\$338	12	\$470
					6	\$357	L	—
					7	\$376		
	Seat Cushion For 23"D Pedestal	HPSEAT24ND	10 	1.2	1	\$267	8	\$472
					2	\$293	9	\$505
					3	\$318	10	\$537
					4	\$343	11	\$570
					5	\$375	12	\$602
					6	\$408	L	—
					7	\$440		

STORAGE





HOW TO SPECIFY

Select Model Number	Select Fabric See pages 22-24 for seating fabric options
H A E S C 1 9	C U 1 0

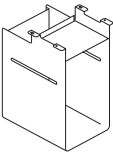
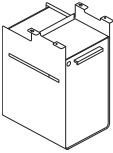

Undermount Storage

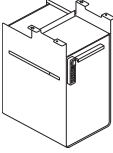
STORAGE

	DESCRIPTION	MODEL	SHIP WEIGHT	CUBE	LIST PRICE
	Undermount Storage Cubby 10"W x 14 ³ / ₈ "D x 19 ³ / ₄ "H NOTES: No need to specify door color or lock option.	HAUFO15N	19	3.3	\$483
	Undermount Storage Cubby with Locking Door Right-Hinged Left-Hinged 10"W x 14 ³ / ₈ "D x 19 ³ / ₄ "H NOTES: Right-Hinged shown.	HAUFHR15N  HAUFHL15N	24	3.3	\$572
	Undermount Storage Cubby with Locking Door, eLock Right-Hinged Left-Hinged 10"W x 14 ³ / ₈ "D x 19 ³ / ₄ "H  Every installation will require one Programming Key and at least one Manager Key.	HAUFHR15NE HAUFHL15NE	24	3.3	\$872

NOTES:

- Compatible with all HON benching, desking, and height adjustable tables, except where required space is unavailable.
- Ensure weight limit of height adjustable table system is considered before adding undermount storage.
- Open and hinged door units contain a side slot on each side which can be used to hang Workplace Tools.
- Can accommodate two Hot Files, HAEHF, side-by-side.
- 42 lb. storage capacity based on BIFMA loading standards.

 Workplace Tools trays will not fit in cubby.

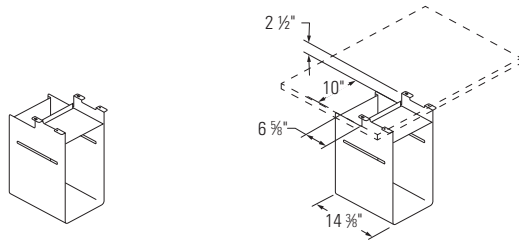

HAUFO15N
Undermount Open Cubby

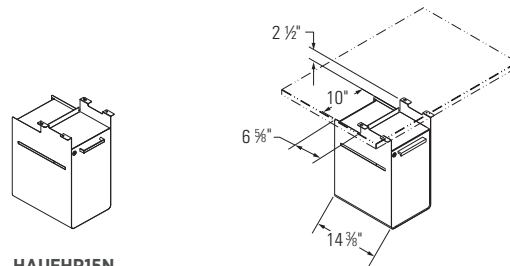



HAUFHR15N
Undermount Storage Cubby
with Locking Door

HOW TO SPECIFY

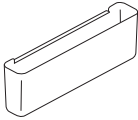

<p>Select Model Number</p> <p>HAUFO15N</p>	<p>Select Case Color</p> <p>See page 637 P2 upcharge (+ \$19) P3 upcharge (+ \$42)</p> <p>P</p>	<p>Select Door Color</p> <p>See page 637 P2 upcharge (+ \$19) P3 upcharge (+ \$42)</p> <p>P</p>	<p>Select Lock Option</p> <p>L Standard Lock X Omit Lock (deduct \$20) EBNL Digital Lock Brushed Nickel <i>(Specify for eLock models only)</i></p> <p>L</p>
---	--	--	---

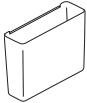
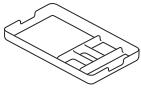
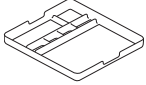

	DESCRIPTION	MODEL	SHIP WEIGHT	CUBE	LIST PRICE
	Side Saddle 12¼"W x 2½"D x 4"H	HAESS	0.6	0.1	\$52
	Hook 1⅝"W x 2¼"D x 3¼"H	HAECBH	0.1	0.1	\$35
	Hot File 12¼"W x 3⅞"D x 9½"H	HAEHF	0.7	1.5	\$76
	Slim Tray 8½"W x 14⅞"D x 1½"H	HAEST	1.0	0.2	\$67
	Large Tray 13½"W x 14⅞"D x 1½"H	HAELT	1.5	0.2	\$76

NOTES:

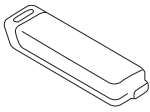
- Side Saddle and Hot File work on Paper Management Support Bars on page 407.
- Hook weight limit 20 lbs.

	DESCRIPTION	MODEL	SHIP WEIGHT	CUBE	LIST PRICE
	Digital Keys Digilock Programming Key	HSLDIGPRG	0.8 	0.0	\$218
	Digilock Manager Key	HSLDIGMGR	0.8 	0.0	\$170
<p>NOTES: A Programming Key is used to initialize locks out of factory default mode and register Manager Keys to the locks. Manager Keys are used to bypass a locked unit, operating as the "master key" and it is recommended that building facilitators have at least one Manager Key. Up to 6 Manager Keys may be registered to each lock. Manager Keys provide external power to locks in case of battery failure. Programming Key is the same key as Contain® Digilocks and can work across both Contain® and Fuse™.</p> <ul style="list-style-type: none"> ! Only one Programming Key should be specified per installation and multiple Programming Keys are not compatible with each other. ! Add-on digital lock orders should be programmed with the original Programming Key. ! Digital lock user guides and manager programming instructions included. 					

HOW TO SPECIFY

Select Model Number	Select Color
HAESS.	DW Designer White

STORAGE ISLANDS

Want to see more? Scan here
to check out hon.com.



STORAGE

Storage Islands shown with Ignition[®] Café-Height Stools, Flagship[®], and Contain[®] Storage.

STORAGE ISLANDS

Time to pack your bags and take flight for an organizational oasis. Storage Islands don't just offer intuitive design and unsurpassed efficiency, they create flexible work suites that will make any project feel like a vacation. Whether you're a creative collaborator or intensely focused on a singular project, these dynamic units are easily customizable with a variety of vibrant color options and offer seamless adaptability to meet the demands of any work day.



FEATURES

- Storage Islands promotes dual-purpose spaces, where functional storage and impromptu collaboration occur simultaneously.
- Clean, straightforward design complements and blends in with any workspace.
- Combine metal, laminate, and color to create a unique and unified look for your office.
- Storage Islands works best with Contain[®] lockers, wardrobes, and Flagship[®] and Brigade[®] laterals.
- Will work with 3-high Flagship[®] and Brigade[®] laterals, bookcases, and storage cabinets along with Contain[®] 42½" lockers and wardrobes.
- Add Storage Islands to existing HON Storage banks or specify in new office configurations.
- Pair storage options to consolidate storage away from the workspace, allowing more room for people to interact, work, and move freely.

STORAGE ISLANDS ORDERING INFORMATION

WORKSURFACES

L1 LAMINATES CODES

Woodgrain

- ◆ Bourbon Cherry H
- ◆ Cognac COGN
- ◆ Field Elm LWFE
- ◆ Florence Walnut LFW1
- ◆ Harvest C
- ◆ Kingswood Walnut LK11
- ◆ Mahogany N
- ◆ Mocha MOCH
- ◆ Natural Maple D
- ◆ Pinnacle PINC
- ◆ Shaker Cherry F
- ◆ Sterling Ash LSA1

Solid

- ◆ Black P
- ◆ Charcoal S
- ◆ Designer White LDW1
- ◆ Loft LOFT

L2 LAMINATES CODES

Woodgrain

- ◆ Beigewood LWBE
- ◆ Fawn Cypress LFC1
- ◆ Lowell Ash LLA1
- ◆ Natural Recon LNR1
- ◆ Phantom Ecrú LPE1
- ◆ Portico Teak LPT1
- ◆ Skyline Walnut LSW1

WORKSURFACE EDGE BAND

Woodgrain

- ◆ Beigewood DE
- ◆ Bourbon Cherry H
- ◆ Cognac COGN
- ◆ Fawn Cypress FC
- ◆ Field Elm FE
- ◆ Florence Walnut FW
- ◆ Harvest C
- ◆ Kingswood Walnut KI
- ◆ Lowell Ash DL
- ◆ Mahogany N
- ◆ Mocha MOCH
- ◆ Natural Maple D
- ◆ Natural Recon NR
- ◆ Phantom Ecrú PE
- ◆ Pinnacle PINC
- ◆ Portico Teak DP
- ◆ Shaker Cherry F
- ◆ Skyline Walnut SW
- ◆ Sterling Ash SA

Solid

- ◆ Black P
- ◆ Brownstone EY
- ◆ Charcoal S
- ◆ Designer White DW
- ◆ Fossil EH
- ◆ Loft LOFT

O-LEGS

PAINTS CODES

P1

- ◆ Black P
- ◆ Brownstone P7D
- ◆ Charcoal S
- ◆ Cove P096
- ◆ Designer White PJW
- ◆ Dune P094
- ◆ Fossil P28
- ◆ Greige T5
- ◆ Harbor P097
- ◆ Loft LOFT
- ◆ Muslin T3
- ◆ Sage P095
- ◆ Titanium P8T

P2

- ◆ Champagne Metallic T4
- ◆ Gunmetal Metallic PR3
- ◆ Platinum Metallic T1
- ◆ Silver PR6
- ◆ Solar Black P8X

P3

- ◆ Amethyst* P091
- ◆ Atom P8S
- ◆ Blossom* P8K
- ◆ Bullseye PJF
- ◆ Cobalt Mica* P090
- ◆ Ember P8P
- ◆ Ion P8N
- ◆ Iris P8J
- ◆ Krypton P8F
- ◆ Ochre P093
- ◆ Regatta P8M
- ◆ Sienna P092
- ◆ Succulent* P8A

* TREND COLORS: These colors are intended to be an inspirational option for the trending market. Product application is limited and color availability is approximately two years to coincide with evolving workplace trends.

◆◆◆ For lead time information see page 21.

* De-emphasized

STORAGE ISLANDS SPECIFYING GUIDE

Top

Available in single depth (18") or double depth (36") surface.

- Select dimensionality based on configuration and the number of undersurface units being spanned.

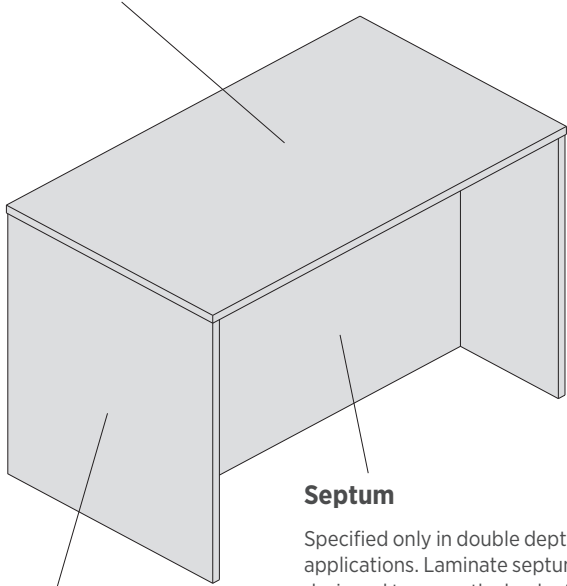

End Panel

Specified in both 18"D and 36"D applications to conceal the sides of storage units.

Septum

Specified only in double depth (36") applications. Laminate septum designed to cover the back of storage units and create a clean countertop application. Septum must be connected to end panels or an adjacent septum.

Back

Specified only in 18"D configurations to conceal the back of storage units.

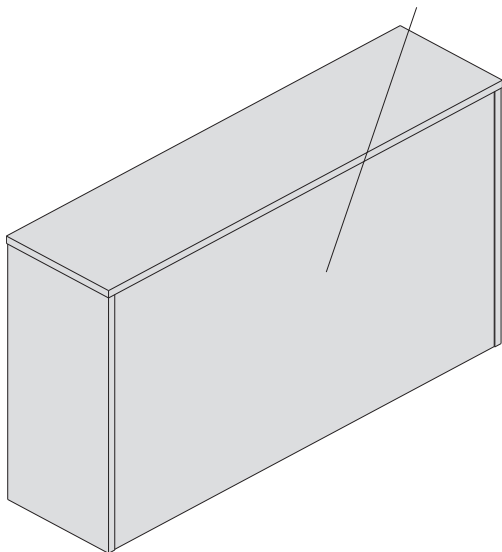

Specifying Islands Top

1. Select top depth.
 - Single (18") or double (36")
2. Select desired Islands configuration.
 - Top only
 - Top + End Panels
 - Top + End Panels + Back or Septum
3. Determine top width.
 - Identify the number of side-to-side storage units the top will cover. This number represents the number of **spans**.

* Note: Front-to-back units do not factor into number of spans. Although top or end panels accept a septum, it is not required to add septum based on application.

Specifying End Panels, Back, or Septum

4. Identify storage units Islands will wrap. This determines correct height.
 - Contain® Height = 40¹/₂"
 - Flagship®/Brigade® Height = 38¹/₂"
5. Specify additional components to complete your Islands configuration.
 - End panels, back, or septum
 - The width and number of units spanned on the septum must match the width and number of units spanned on the top.

Peninsula Applications

Specify an O-Leg or laminate return panel to create an open span collaboration space.

* Note: Under-surface storage must support at least one side of the open span.

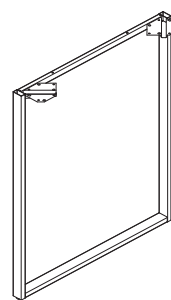

O-Leg

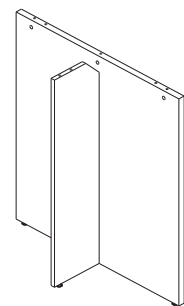

Return Panel

O-Leg & Return Panel

Specified to support open span top in Islands peninsula configuration.

STORAGE ISLANDS SPECIFYING GUIDE

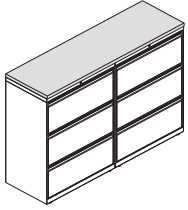

18"D - Single Depth

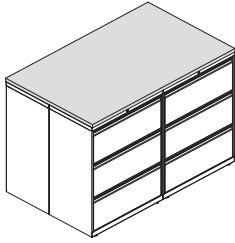

36"D - Double Depth

Light Configuration

Top Only
See page 654 to specify top only.

STORAGE

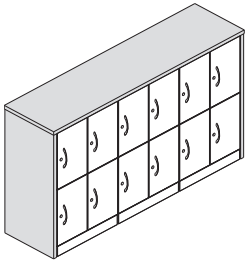

18"D - Single Depth

Medium Configuration

Top + 2 End Panels
See page 655 to specify top designed for end panel configuration.

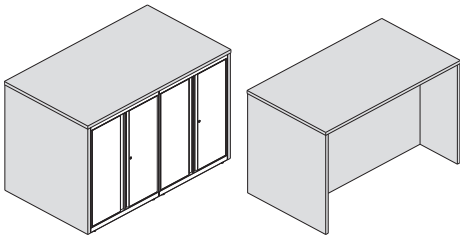

36"D - Double Depth

Heavy Configuration

Top + 2 End Panels + Back (18"D)
Top + 2 End Panels + Septum (36"D)

See page 656 to specify top designed for end panel and back/septum configuration.

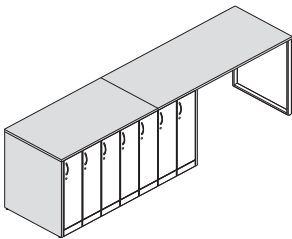

Joined Configuration

Top + 1 End Panel + Septum (36"D)

See page 657 to specify top designed for single end panel and septum configuration.

⚠ This application is designed to join worksurfaces to create a run greater than 84".

NOTES: End panels, backs, septums, and support legs specified separately from tops. See pages 658-659 for specification options.

STORAGE ISLANDS SPECIFYING GUIDE

WORKING WITH STORAGE ISLANDS WITH CONTAIN® OR FLAGSHIP®/BRIGADE® PRODUCT LINES

Storage Islands come in 2" height variances designed to be used with Contain® or Flagship®/Brigade® product lines. Worksurfaces and end supports are made of 1¼" particleboard with 2mm edgeband and laminate on both sides of all surfaces. Center septums are made of ¾" particleboard with 0.5mm edgeband and laminate on both sides.

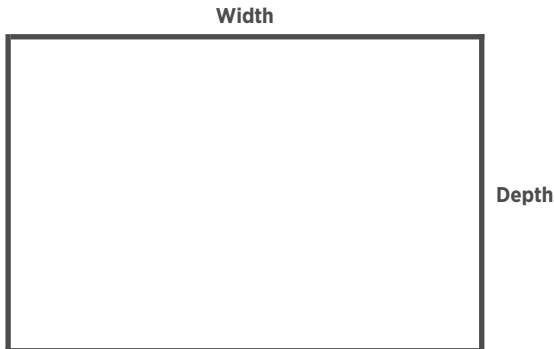

	Depths
18"D No Back, No End Panels	18.19
18"D No Back, With End Panels	18.44
18"D Back and End Panels	19.455
36"D No Back, No End Panels	36.69
36"D End Panels	

End Panel Sizes		
	Depths	Height
18"D No Back, Contain®	18.19	40.8
18"D No Back, Flagship®		38.8
18"D With Back, Contain®	19.20	40.8
18"D With Back, Flagship®		38.8
36"D End Panels, Contain®	36.44	40.8
36"D End Panels, Flagship®		38.8



	Width Sizes						
	S1	S2	S3	S4	S5	S6	S7
No End Panels	84.00"	S1 + 0.125	S1 + 0.25	S1 + 0.375	S1 + 0.5	S1 + 0.625	S1 + 0.75
1 End Panel	85.372"						
2 End Panels	86.744"						

*S1 spans a single storage unit, which is noted at the end of the model number. Start with the S1 number displayed in the table above. Depending on your Islands configuration, the top width increases accordingly based on the 2 factors below.

- 1). The number of end panels you attach to the worksurface.
- 2). The number of side-to-side storage units the surface spans.

NOTES:

- Use the width of the worksurface you select. Models correspond to the correct surface width.
- Span represents the total number of side-to-side units. Front-to-back units do not factor into number of units spanned.

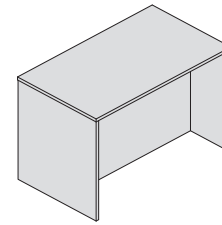

Countertop Application

- When specifying a countertop application, the end of a septum cannot be left open. The septum must connect to an end panel or adjacent septum.

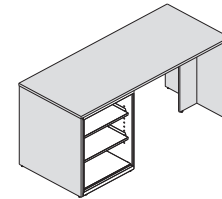

Peninsula Application

- Peninsula applications can only be completed with 36"D worksurfaces and end panels.
- Back-to-back storage specified without an end panel will result in an ~3/8" gap between storage units.
- In a peninsula application, one end of the worksurface must be supported by undersurface storage. The opposing end can be supported with an O-leg or laminate end panel.



- Unsupported surface runs greater than 54"W require the installation of an external stiffener.
- External stiffener extends 1½" below the worksurface.
- For 36"W surfaces, 2 external stiffeners are needed on the underneath side of the worksurface.

STORAGE ISLANDS

Planning Typicals

QTY	DESCRIPTION	MODEL	LIST PRICE	PRICE EXTENSION
1	Islands Top, Double Depth, Span 2 36"D x 60"W	HSISLAUTNPNB6036S2	\$749	\$749
4	Brigade® Lateral File, 3 Drawer 30"W x 18"D x 39 1/8"H	H873	\$1,599	\$6,396
TOTAL:			\$7,145	

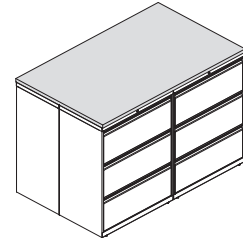

QTY	DESCRIPTION	MODEL	LIST PRICE	PRICE EXTENSION
1	Islands Top for Use w/2 End Panels and Back, Span 3 18"D x 72"W	HSISLAUT2PYB7218S3	\$578	\$578
1	Islands End Panels, Contain® Height, Back, Left 42"H x 18"W	HSISLACEYB1842L	\$280	\$280
1	Islands End Panels, Contain® Height, Back, Right 42"H x 18"W	HSISLACEYB1842R	\$280	\$280
1	Islands Back, Contain® Height, 2 End Panels, Span 3 42"H x 72"W	HSISLACB2P7242S3	\$600	\$600
3	Contain® Quad Locker, Plinth Base 42"H x 24"W x 18"D	HSQLP422418RM	\$1,976	\$5,928
TOTAL:			\$7,666	

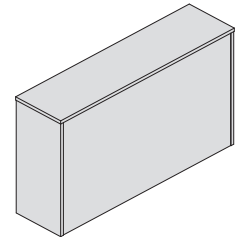
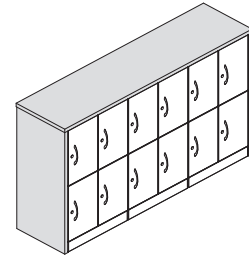

QTY	DESCRIPTION	MODEL	LIST PRICE	PRICE EXTENSION
1	Islands Top for Use w/2 End Panels & Septum, Span 2 36"D x 60"W	HSISLAUT2PYB6036S2	\$898	\$898
2	Islands End Panel, Flagship® Height, Septum 42"H x 36"W	HSISLAFEYB3642	\$487	\$974
1	Islands Septum, Flagship® Height, 2 End Panels, Span 2 42"H x 60"W	HSISLAFB2P6042S2	\$513	\$513
2	Flagship® Modular Storage Cabinet 39 1/8"H x 30"W x 18"D	HFMSC183930RWB	\$1,663	\$3,326
TOTAL:			\$5,711	

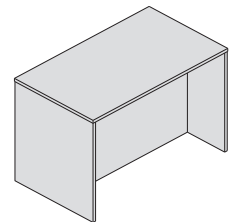
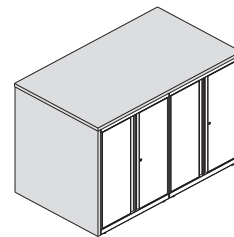

STORAGE ISLANDS

Planning Typical

QTY	DESCRIPTION	MODEL	LIST PRICE	PRICE EXTENSION
1	Islands Top for Use w/2 End Panels and Septum, Span 2 36"D x 84"W	HSISLAUT2PYB8436S2	\$1,045	\$1,045
1	Islands End Panel, Flagship® Height, Back 42"H x 36"W	HSISLAFESP3642	\$487	\$487
1	Flagship® Height, Return Panel 42"H x 36"W	HSISLAFESP3642	\$487	\$487
2	Flagship® Bookcase, 3-Shelves 39½"H x 30"W x 18"D	HFSC183640W	\$1,136	\$2,272
TOTAL:			\$4,291	

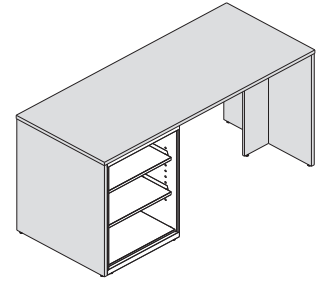

QTY	DESCRIPTION	MODEL	LIST PRICE	PRICE EXTENSION
2	Islands Top for Use w/1 End Panel & Septum, Span 2 36"D x 60"W	HSISLAUT1PYB6036S2	\$861	\$1,722
2	Islands Septum, Flagship® Height, 2 End Panels, Span 2 42"H x 60"W	HSISLAFB2P6042S2	\$513	\$1,026
2	Islands End Panel, Flagship® Height, Septum 42"H x 36"W	HSISLAFEB3642	\$487	\$974
4	Flagship® Lateral File, 3 Drawer 39½"H x 30"W x 18"D	H9173(?)	\$1,701	\$6,804
1	Flat Bracket 18"D	HHN831118	\$83	\$83
TOTAL:			\$10,609	

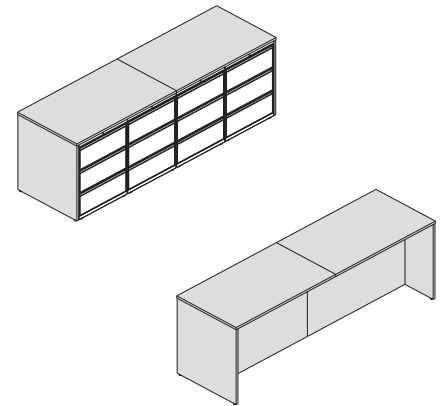

QTY	DESCRIPTION	MODEL	LIST PRICE	PRICE EXTENSION
1	Islands Top, 1 End Panel and Septum, Span 5 36"D x 60"W	HSISLAUT1PYB6036S5	\$861	\$861
2	Islands End Panel, Contain® Height, Back, No Septum 42"H x 36"W	HSISLACEYB3642	\$487	\$974
1	Islands Top, 1 End Panel and Septum, Span 2 36"D x 84"W	HSISLAUT1PYB8436S2	\$1,001	\$1,001
1	Islands O-Leg, Contain® Height 42"H x 36"W	HSISLACO3642	\$702	\$702
2	External Stiffener Channel 48"W, for 60" Worksurface	HLSLZ5SC60	\$135	\$270
14	Contain® Wardrobe, Plinth Base 42"H x 12"W x 18"D	HSWP421224RM	\$1,154	\$16,156
TOTAL:			\$19,964	

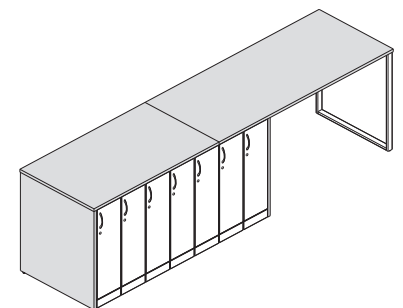

! On joined application, top seam only allowed when supported by storage underneath seam.

STORAGE

STORAGE ISLANDS

Top Only Applications

GSA SIN 33721



Icon Legend on page 19

STORAGE

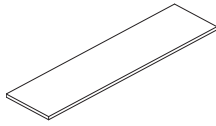
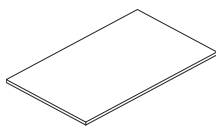
	DESCRIPTION	MODEL	SHIP WEIGHT	CUBE	LIST PRICE BY LAMINATE GRADE	
					L1	L2
	Islands Tops, Single Depth					
	18"D x 24"W, Spans 1	HSISLAUTNPB2418S1	15	2.0	\$275	\$286
	18"D x 30"W, Spans 1	HSISLAUTNPB3018S1	18	2.5	\$309	\$321
	18"D x 36"W, Spans 1	HSISLAUTNPB3618S1	22	2.9	\$338	\$351
	18"D x 36"W, Spans 3	HSISLAUTNPB3618S3	22	2.9	\$360	\$374
	18"D x 42"W, Spans 1	HSISLAUTNPB4218S1	25	3.3	\$380	\$395
	18"D x 48"W, Spans 1	HSISLAUTNPB4818S1	28	3.8	\$409	\$425
	18"D x 48"W, Spans 2	HSISLAUTNPB4818S2	28	3.8	\$409	\$425
	18"D x 48"W, Spans 4	HSISLAUTNPB4818S4	28	3.8	\$409	\$425
	18"D x 60"W, Spans 1	HSISLAUTNPB6018S1	35	4.7	\$429	\$445
	18"D x 60"W, Spans 2	HSISLAUTNPB6018S2	35	4.7	\$429	\$445
	18"D x 60"W, Spans 5	HSISLAUTNPB6018S5	35	4.7	\$429	\$445
	18"D x 72"W, Spans 1	HSISLAUTNPB7218S1	42	5.6	\$463	\$481
	18"D x 72"W, Spans 2	HSISLAUTNPB7218S2	42	5.6	\$463	\$481
	18"D x 72"W, Spans 3	HSISLAUTNPB7218S3	42	5.6	\$463	\$481
18"D x 72"W, Spans 6	HSISLAUTNPB7218S6	42	5.6	\$463	\$481	
18"D x 84"W, Spans 1	HSISLAUTNPB8418S1	48	6.4	\$499	\$518	
18"D x 84"W, Spans 2	HSISLAUTNPB8418S2	48	6.4	\$499	\$518	
18"D x 84"W, Spans 7	HSISLAUTNPB8418S7	49	6.5	\$499	\$518	
	Islands Tops, Double Depth					
	36"D x 24"W, Spans 1	HSISLAUTNPB2436S1	29	3.8	\$479	\$497
	36"D x 30"W, Spans 1	HSISLAUTNPB3036S1	35	4.6	\$542	\$562
	36"D x 36"W, Spans 1	HSISLAUTNPB3636S1	42	5.3	\$590	\$612
	36"D x 36"W, Spans 3	HSISLAUTNPB3636S3	42	5.4	\$626	\$649
	36"D x 42"W, Spans 1	HSISLAUTNPB4236S1	49	6.2	\$664	\$690
	36"D x 48"W, Spans 1	HSISLAUTNPB4836S1	56	7.0	\$712	\$739
	36"D x 48"W, Spans 2	HSISLAUTNPB4836S2	56	7.0	\$712	\$739
	36"D x 48"W, Spans 4	HSISLAUTNPB4836S4	56	7.0	\$712	\$739
	36"D x 60"W, Spans 1	HSISLAUTNPB6036S1	69	8.6	\$749	\$778
	36"D x 60"W, Spans 2	HSISLAUTNPB6036S2	69	8.6	\$749	\$778
	36"D x 60"W, Spans 5	HSISLAUTNPB6036S5	70	8.7	\$749	\$778
	36"D x 72"W, Spans 1	HSISLAUTNPB7236S1	83	10.3	\$811	\$842
	36"D x 72"W, Spans 2	HSISLAUTNPB7236S2	83	10.3	\$811	\$842
	36"D x 72"W, Spans 3	HSISLAUTNPB7236S3	83	10.3	\$811	\$842
36"D x 72"W, Spans 6	HSISLAUTNPB7236S6	83	10.3	\$811	\$842	
36"D x 84"W, Spans 1	HSISLAUTNPB8436S1	96	11.9	\$869	\$902	
36"D x 84"W, Spans 2	HSISLAUTNPB8436S2	96	11.9	\$869	\$902	
36"D x 84"W, Spans 7	HSISLAUTNPB8436S7	97	12.0	\$869	\$902	

NOTES:

- Top specified to create "light" configuration . See page 650.
- Worksurfaces are made of 1/8" high-performance particleboard with 2mm edgeband and laminate on both sides of all surfaces.
- Grain direction on all worksurfaces runs horizontal.

HOW TO SPECIFY

<p>Select Model Number</p> <p>HSISLAUTNPB6036S5</p>	<p>Select Laminate</p> <p>See page 648</p> <p>LKI1</p>	<p>Select Edge</p> <p>See page 648</p> <p>KI</p>
---	--	--



STORAGE ISLANDS

Tops for Use with 2 End Panels

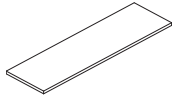

DESCRIPTION	MODEL	SHIP WEIGHT	CUBE	LIST PRICE BY LAMINATE GRADE	
				L1	L2
Islands Tops for use with End Panels 18"D x 24"W, 2 End Panels, Spans 1	HSISLAUT2PNB2418S1	17	2.2	\$330	\$343
18"D x 30"W, 2 End Panels, Spans 1	HSISLAUT2PNB3018S1	20	2.6	\$371	\$385
18"D x 36"W, 2 End Panels, Spans 1	HSISLAUT2PNB3618S1	23	3.1	\$405	\$420
18"D x 36"W, 2 End Panels, Spans 3	HSISLAUT2PNB3618S3	23	3.1	\$412	\$428
18"D x 42"W, 2 End Panels, Spans 1	HSISLAUT2PNB4218S1	27	3.5	\$455	\$472
18"D x 48"W, 2 End Panels, Spans 2	HSISLAUT2PNB4818S2	30	4.0	\$489	\$507
18"D x 48"W, 2 End Panels, Spans 4	HSISLAUT2PNB4818S4	30	4.0	\$489	\$507
18"D x 60"W, 2 End Panels, Spans 2	HSISLAUT2PNB6018S2	37	4.9	\$514	\$533
18"D x 60"W, 2 End Panels, Spans 5	HSISLAUT2PNB6018S5	37	4.9	\$514	\$533
18"D x 72"W, 2 End Panels, Spans 2	HSISLAUT2PNB7218S2	44	5.8	\$555	\$576
18"D x 72"W, 2 End Panels, Spans 3	HSISLAUT2PNB7218S3	44	5.8	\$555	\$576
18"D x 72"W, 2 End Panels, Spans 6	HSISLAUT2PNB7218S6	44	5.8	\$509	\$528
18"D x 84"W, 2 End Panels, Spans 2	HSISLAUT2PNB8418S2	51	6.6	\$598	\$620
18"D x 84"W, 2 End Panels, Spans 7	HSISLAUT2PNB8418S7	51	6.7	\$598	\$620

STORAGE

NOTES:

- Top specified to create "medium" configuration . See page 650.
- Worksurfaces are made of 1 1/8" high-performance particleboard with 2mm edgeband and laminate on both sides of all surfaces.
- Grain direction on all worksurfaces runs horizontal.

HOW TO SPECIFY

<p>Select Model Number</p> <p>HSISLAUT2PNB3618S3</p>	<p>Select Laminate</p> <p>See page 648</p> <p>LKI1</p>	<p>Select Edge</p> <p>See page 648</p> <p>KI</p>
---	---	---

STORAGE ISLANDS

Tops for Use with 2 End Panels and Back/Septum

GSA SIN 33721



Icon Legend on page 19

STORAGE

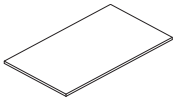
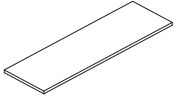

DESCRIPTION	MODEL	SHIP WEIGHT	CUBE	LIST PRICE BY LAMINATE GRADE	
				L1	L2
Islands Tops for Use with 2 End Panels and Back/Septum					
18"D x 48"W, 2 End Panels and Back, Spans 2	HSISLAUT2PYB4818S2	32	4.4	\$509	\$528
18"D x 48"W, 2 End Panels and Back, Spans 4	HSISLAUT2PYB4818S4	32	4.4	\$509	\$528
18"D x 60"W, 2 End Panels and Back, Spans 2	HSISLAUT2PYB6018S2	39	5.4	\$536	\$556
18"D x 60"W, 2 End Panels and Back, Spans 5	HSISLAUT2PYB6018S5	39	5.4	\$536	\$556
18"D x 72"W, 2 End Panels and Back, Spans 2	HSISLAUT2PYB7218S2	46	6.3	\$578	\$600
18"D x 72"W, 2 End Panels and Back, Spans 3	HSISLAUT2PYB7218S3	46	6.3	\$578	\$600
18"D x 72"W, 2 End Panels and Back, Spans 6	HSISLAUT2PYB7218S6	46	6.3	\$578	\$600
18"D x 84"W, 2 End Panels and Back, Spans 2	HSISLAUT2PYB8418S2	53	7.3	\$622	\$645
18"D x 84"W, 2 End Panels and Back, Spans 7	HSISLAUT2PYB8418S7	54	7.3	\$622	\$645
<hr/>					
36"D x 48"W, 2 End Panels and Septum, Spans 2	HSISLAUT2PYB4836S2	59	7.4	\$854	\$886
36"D x 48"W, 2 End Panels and Septum, Spans 4	HSISLAUT2PYB4836S4	59	7.4	\$854	\$886
36"D x 60"W, 2 End Panels and Septum, Spans 2	HSISLAUT2PYB6036S2	72	9.0	\$898	\$932
36"D x 60"W, 2 End Panels and Septum, Spans 5	HSISLAUT2PYB6036S5	73	9.0	\$898	\$932
36"D x 72"W, 2 End Panels and Septum, Spans 2	HSISLAUT2PYB7236S2	86	10.6	\$972	\$1009
36"D x 72"W, 2 End Panels and Septum, Spans 3	HSISLAUT2PYB7236S3	86	10.6	\$972	\$1009
36"D x 72"W, 2 End Panels and Septum, Spans 6	HSISLAUT2PYB7236S6	86	10.7	\$972	\$1009
36"D x 84"W, 2 End Panels and Septum, Spans 2	HSISLAUT2PYB8436S2	99	12.3	\$1045	\$1084
36"D x 84"W, 2 End Panels and Septum, Spans 7	HSISLAUT2PYB8436S7	100	12.4	\$1045	\$1084

NOTES:

- Top specified to create "heavy" configuration . See page 650.
- Worksurfaces are made of 1½" high-performance particleboard with 2mm edgeband and laminate on both sides of all surfaces.
- Grain direction on all worksurfaces runs horizontal.

HOW TO SPECIFY

<p>Select Model Number</p> <p>HSISLAUT2PYB6036S2</p>	<p>Select Laminate</p> <p>See page 648</p> <p>LKI1</p>	<p>Select Edge</p> <p>See page 648</p> <p>KI</p>
--	--	--



STORAGE ISLANDS

Islands Tops for Use with 1 End Panel and Septum

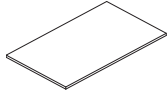

DESCRIPTION	MODEL	SHIP WEIGHT	CUBE	LIST PRICE BY LAMINATE GRADE	
				L1	L2
Islands Tops for Use with One End Panel & Septum					
36"D x 48"W, 1 End Panel and Septum, Spans 2	HSISLAUTIPYB4836S2	57	7.2	\$819	\$850
36"D x 48"W, 1 End Panel and Septum, Spans 4	HSISLAUTIPYB4836S4	57	7.2	\$819	\$850
36"D x 60"W, 1 End Panel and Septum, Spans 2	HSISLAUTIPYB6036S2	71	8.8	\$861	\$894
36"D x 60"W, 1 End Panel and Septum, Spans 5	HSISLAUTIPYB6036S5	71	8.9	\$861	\$894
36"D x 72"W, 1 End Panel and Septum, Spans 2	HSISLAUTIPYB7236S2	84	10.5	\$931	\$966
36"D x 72"W, 1 End Panel and Septum, Spans 3	HSISLAUTIPYB7236S3	84	10.5	\$931	\$966
36"D x 72"W, 1 End Panel and Septum, Spans 6	HSISLAUTIPYB7236S6	85	10.5	\$931	\$966
36"D x 84"W, 1 End Panel and Septum, Spans 2	HSISLAUTIPYB8436S2	98	12.1	\$1001	\$1039
36"D x 84"W, 1 End Panel and Septum, Spans 7	HSISLAUTIPYB8436S7	98	12.2	\$1001	\$1039

NOTES:

- Worksurfaces are made of 1½" high-performance particleboard with 2mm edgeband and laminate on both sides of all surfaces.
- Grain direction on all worksurfaces runs horizontal.
- Single end panel application designed to join worksurfaces to create run greater than 84".

DESCRIPTION	MODEL	SHIP WEIGHT	CUBE	LIST PRICE
 <p>Flat Bracket 18"D</p> <p>NOTES: Use the flat bracket in countertop applications where 2 worksurfaces come together and there is not a storage unit or end panel connecting them.</p> <p>ⓘ Available in Charcoal only.</p>	HHN831118	3 ⓘ	0.2	\$83

NOTES:

- Top specified to create "joint" configuration. See page 650.
- ⓘ 36"W with back-to-back storage without an end panel will result in approximately 3/8" exposed gap between storage units.

HOW TO SPECIFY

<p>Select Model Number</p> <p>HSISLAUT1PYB6036S5</p>	<p>Select Laminate</p> <p>See page 648</p> <p>LK11</p>	<p>Select Edge</p> <p>See page 648</p> <p>KI</p>
--	--	--

STORAGE ISLANDS

Islands Septum/Back and End Panels

GSA SIN 33721



Icon Legend on page 19

STORAGE

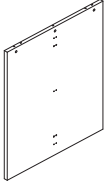

DESCRIPTION	MODEL	SHIP WEIGHT	CUBE	LIST PRICE BY LAMINATE GRADE	
				L1	L2
Islands End Panels, Contain® Height					
42"H x 18"W, Contain® Height, No Back	HSISLACENB1842	24	3.3	\$280	\$291
42"H x 18"W, Contain® Height, Back, Left-Hand	HSISLACEYB1842L	26	3.3	\$280	\$291
42"H x 18"W, Contain® Height, Back, Right-Hand	HSISLACEYB1842R	26	3.3	\$280	\$291
42"H x 36"W, Contain® Height, No Septum	HSISLACEYB3642	45	6.0	\$487	\$505
42"H x 36"W, Contain® Height, Septum	HSISLACESP3642	45	6.0	\$487	\$505
Islands End Panels, Flagship® Height					
42"H x 18"W, Flagship® Height, No Back	HSISLAFENB1842	24	3.1	\$280	\$291
42"H x 18"W, Flagship® Height, Back, Left-Hand	HSISLAFEYB1842L	24	3.1	\$280	\$291
42"H x 18"W, Flagship® Height, Back, Right-Hand	HSISLAFEYB1842R	24	3.1	\$280	\$291
42"H x 36"W, Flagship® Height, No Septum	HSISLAFEYB3642	47	5.7	\$487	\$505
42"H x 36"W, Flagship® Height, Septum	HSISLAFESP3642	47	5.7	\$487	\$505

NOTES: Panels are made of 1½" high-performance particleboard with 2mm edgeband and laminate on both sides of all surfaces. Grain direction on all End Panels runs vertical. 18"W end panels require selection of right or left model numbers for installation purposes.

! Models HSISLACESP3642 and HSISLAFESP3642 come with short end panel which can be discarded when used as an end panel.

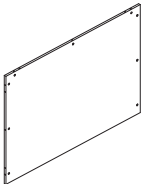

Islands Septum/Back, Contain® Height					
42"H x 48"W, 2 End Panels, Spans 2	HSISLACB2P4842S2	42	8.1	\$467	\$485
42"H x 72"W, 2 End Panels, Spans 3	HSISLACB2P7242S3	63	11.9	\$600	\$622
42"H x 48"W, 2 End Panels, Spans 4	HSISLACB2P4842S4	42	8.1	\$467	\$485
42"H x 60"W, 2 End Panels, Spans 5	HSISLACB2P6042S5	53	10.0	\$513	\$532
42"H x 72"W, 2 End Panels, Spans 6	HSISLACB2P7242S6	63	11.9	\$600	\$622
42"H x 84"W, 2 End Panels, Spans 7	HSISLACB2P8442S7	73	13.8	\$730	\$758
Islands Septum/Back, Flagship® Height					
42"H x 60"W, 2 End Panels, Spans 2	HSISLAFB2P6042S2	50	10.0	\$513	\$532
42"H x 72"W, 2 End Panels, Spans 2	HSISLAFB2P7242S2	59	11.9	\$600	\$622
42"H x 84"W, 2 End Panels, Spans 2	HSISLAFB2P8442S2	69	13.7	\$730	\$758

NOTES: Septums/Backs are made of ¾" high-performance particleboard with 0.5mm edgeband and laminate on both sides of all surfaces. Grain direction on all Septums/Backs runs horizontal.

NOTES:

- End panels and septum are shipped with mounting hardware included, 1/pack.

HOW TO SPECIFY

<p>Select Model Number</p> <p>HSISLACB2P6042S5</p>	<p>Select Laminate</p> <p>See page 648</p> <p>LK11</p>
--	--



STORAGE ISLANDS

Peninsula Supports

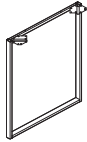

DESCRIPTION

Islands O-Leg
 42”H x 36”W, Contain® Height
 42”H x 36”W, Flagship® Height

MODEL	SHIP WEIGHT	CUBE	LIST PRICE BY PAINT GRADE		
			P1	P2	P3
HSISLACO3642	21	6.8	\$702	\$711	\$723
HSISLAF03642	21	6.8	\$702	\$711	\$723

DESCRIPTION

External Support Channel
 42”W for a 54” Open Worksurface Run
 48”W for a 60” Open Worksurface Run
 54”W for a 66” Open Worksurface Run
 60”W for a 72” Open Worksurface Run
 72”W for an 84” Open Worksurface Run

MODEL	SHIP WEIGHT	CUBE	LIST PRICE
HLSLZ5SC54	5	0.5	\$129
HLSLZ5SC60	6	0.5	\$135
HLSLZ5SC66	7	0.5	\$141
HLSLZ5SC72	7	0.5	\$152
HLSLZ5SC84	12	0.7	\$152

NOTES: 36”W surfaces will need 2 external stiffeners on either side of the worksurface.

📌 Available in Graphite paint only.



DESCRIPTION

Islands Return Panels
 42”H x 36”W, Contain® Height, Return Panel
 42”H x 36”W, Flagship® Height, Return Panel

MODEL	SHIP WEIGHT	CUBE	LIST PRICE BY LAMINATE GRADE	
			L1	L2
HSISLACESP3642	56	4.6	\$487	\$505
HSISLAFESP3642	58	4.6	\$487	\$505

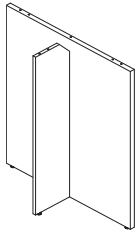

NOTES:

- Voi® O-legs installed in peninsula application are centered front-to-back on the worksurface. The O-leg will be 1/2” inset from the edge of the worksurface.
- 📌 When specifying a peninsula application, at least one side of the open worksurface span must be supported with undersurface storage. Islands tops cannot be specified with only O-leg or Laminate Return Panel supports.

HOW TO SPECIFY

<p>Select Model Number</p> <p>H S I S L A C O 3 6 4 2 . T 1</p>	<p>Select Paint/Laminate</p> <p>See page 648</p>
--	--

400 SERIES

Want to see more? Scan here
to check out hon.com.



STORAGE



400 Series Lateral Files.

400 SERIES

Economical 400 Series lateral files from HON offer features not often found on competitors' files, such as a tamper-resistant enclosed base and factory-installed counterweights on two- and four-drawer cabinets to stabilize the center of gravity when a drawer is opened. Even the removable lock core system stands out among higher-priced rivals.



FEATURES

- Lateral files have counterweights for stability and a two-sided lock mechanism that resists tampering.
- Removable lock core can be changed as security needs require.
- Leveling glides compensate for uneven floors.
- Heavy-duty Steel ball-bearing drawer suspensions operate easily and quietly.
- Four vertical reinforcements keep the cabinet sturdy and the drawers gliding smoothly.
- Drawer handle design coordinates with HON Metro Classic Steel desks.

400 SERIES Lateral Files

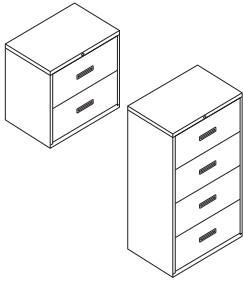

DESCRIPTION

Steel Lateral Files

- 30"W x 18"D x 28"H — 2 Drawer
- 30"W x 18"D x 53½"H — 4 Drawer
- 36"W x 18"D x 28"H — 2 Drawer
- 36"W x 18"D x 53½"H — 4 Drawer

NOTES: Drawers lock. Features ball-bearing slide suspensions.

MODEL	SHIP WEIGHT	CUBE	LIST PRICE
H432	109	12.4	\$1090
H434	169	22.1	\$1609
H482	124	12.4	\$1140
H484	185	22.1	\$1836

NOTES:

- Reinforced case construction.
- Two adjustable leveling glides in front corners.
- Baked enamel finish.
- Monochromatic drawer pulls.
- **HON 5-Year Limited Warranty.**

STORAGE

HOW TO SPECIFY

<p>Select Model Number</p> <div style="border: 1px solid gray; padding: 5px; display: flex; justify-content: space-between; align-items: center;"> H432 </div>	<p>Select Lock Option</p> <p>L Lock</p> <div style="border: 1px solid gray; padding: 5px; display: flex; justify-content: space-between; align-items: center;"> L </div>	<p>Select Paint Color</p> <p>P Black Q Light Gray LOFT Loft L Putty</p> <div style="border: 1px solid gray; padding: 5px; display: flex; justify-content: space-between; align-items: center;"> P </div>
---	--	--

VERTICAL FILES

Want to see more? Scan here
to check out [hon.com](https://www.hon.com).



STORAGE



310 Series Verticals with Perpetual® Seating.

VERTICAL FILES

Have lots to store but not a lot to spend? HON has a lot of filing solutions to fit your budget. Perfect for small businesses, home and professional offices, schools and more, HON's vertical files are value priced and available in multiple styles and sizes.



FEATURES

- Our vertical filing cabinets offer both legal and letter drawer sizes to accommodate all your filing needs.
- HON One Key core removable locks can be changed or interchanged as security demands change.
- Double-walled front kickplate stands up to impact.
- High drawer sides support hanging file folders, eliminating the need for extra-cost hangrails.

VERTICAL FILES ORDERING INFORMATION

210, 310, & 510 VERTICAL FILES

PAINTS CODES

P1

- ◆ Black P
- ◆ Brownstone P7D
- ◆ Charcoal S
- ◆ Designer White PJW
- ◆ Fossil P28
- ◆ Greige T5
- ◆ Light Gray Q
- ◆ Loft LOFT
- ◆ Muslin T3
- ◆ Putty L
- ◆ Titanium P8T

P2

- ◆ Champagne Metallic T4
- ◆ Gunmetal Metallic PR3
- ◆ Platinum Metallic T1

◆◆◆ For lead time information see page 21.

210 SERIES Vertical Files

GSA SIN 33721



Icon Legend on page 19

STORAGE



DESCRIPTION

Vertical File — 2 Drawer
15"W x 28½"D x 29"H, Letter
18¼"W x 28½"D x 29"H, Legal

MODEL	SHIP WEIGHT	CUBE	LIST PRICE BY PAINT GRADE		
			P1	P2	P3
H212	65	11.92	\$1155	\$1185	\$1214
H212C	71	14.06	\$1403	\$1433	\$1462

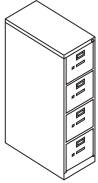

Vertical File — 4 Drawer
15"W x 28½"D x 52"H, Letter
18¼"W x 28½"D x 52"H, Legal

H214	114	19.64	\$1501	\$1549	\$1595
H214C	123	23.18	\$1781	\$1829	\$1875

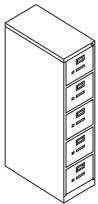

Vertical File — 5 Drawer
15"W x 28½"D x 60"H, Letter
18¼"W x 28½"D x 60"H, Legal

H215	136	22.31	\$2005	\$2053	\$2099
H215C	145	26.33	\$2381	\$2429	\$2475

NOTES:

- High capacity file, 28½" Case depth with 27 front-to-back filing inches per drawer.
- Letter or legal sizes available.
- Three-part, telescoping, steel ball-bearing suspension.
- Bright aluminum drawer pulls, label holders and thumb latch.
- Standard interchangeable core removable locks. Equipped with HON "One Key" system.
- Accepts hanging files. High drawer sides hold hanging file folders without use of hangrails.
- Follower block comes standard.
- Baked enamel finish over rust-inhibiting phosphate pre-treatment.
- See page 668 for Vertical File Accessories.

ⓘ Keyed alike cores must be ordered separately — see page 699.





HOW TO SPECIFY

<p>Select Model Number</p> <p>H 2 1 2 .</p>	<p>Select Lock Option</p> <p>P Lock</p> <p>P .</p>	<p>Select Paint Color</p> <p>See page 663</p> <p>T 1</p>
--	---	---

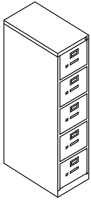

Icon Legend on page 19

310 SERIES Vertical Files

	DESCRIPTION	MODEL	SHIP WEIGHT	CUBE	LIST PRICE BY PAINT GRADE		
					P1	P2	P3
	Vertical File — 2 Drawer 15"W x 26½"D x 29"H, Letter 18¼"W x 26½"D x 29"H, Legal	H312  H312C	60 66	9.2 13.2	\$759 \$968	\$789 \$998	\$818 \$1027
	Vertical File — 4 Drawer 15"W x 26½"D x 52"H, Letter 18¼"W x 26½"D x 52"H, Legal	H314  H314C	107 116	16.03 21.76	\$1032 \$1267	\$1080 \$1315	\$1126 \$1361
	Vertical File — 5 Drawer 15"W x 26½"D x 60"H, Letter 18¼"W x 26½"D x 60"H, Legal	H315  H315C	128 137	20.94 24.72	\$1512 \$1806	\$1560 \$1854	\$1606 \$1900



STORAGE

NOTES:

- 26½" Case depth with 25 front-to-back filing inches per drawer.
- Letter or legal sizes available.
- Three-part, telescoping, steel ball-bearing suspension.
- Bright aluminum drawer pulls, label holders and thumb latch.
- Standard interchangeable core removable locks. Equipped with HON "One Key" system.
- Accepts hanging files. High drawer sides hold hanging file folders without use of hangrails.
- Follower block comes standard.
- Baked enamel finish over rust-inhibiting phosphate pre-treatment.
- See page 668 for Vertical File Accessories.

 Keyed alike cores must be ordered separately — see page 699.

HOW TO SPECIFY

Select Model Number 	Select Lock Option P Lock 	Select Paint Color See page 663 
---	--	--

510 SERIES Vertical Files

GSA SIN 33721



Icon Legend on page 19



DESCRIPTION

Vertical File — 2 Drawer
15"W x 25"D x 29"H, Letter
18¼"W x 25"D x 29"H, Legal

MODEL	SHIP WEIGHT	CUBE	LIST PRICE BY PAINT GRADE		
			P1	P2	P3
H512	58	8.12	\$666	\$696	\$725
H512C	63	9.71	\$850	\$880	\$909

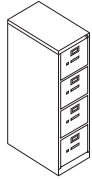

Vertical File — 4 Drawer
15"W x 25"D x 52"H, Letter
18¼"W x 25"D x 52"H, Legal

MODEL	SHIP WEIGHT	CUBE	LIST PRICE BY PAINT GRADE		
			P1	P2	P3
H514	102	17.42	\$896	\$944	\$990
H514C	112	20.65	\$1100	\$1148	\$1194

STORAGE

NOTES:

- 25" Case depth with 23½" front-to-back filing inches per drawer.
- Letter and legal sizes are available.
- Three-part telescoping, ball-bearing steel suspension.
- Bright aluminum drawer pulls, label holders and thumb latch.
- Standard interchangeable core removable locks. Equipped with HON "One Key" system.
- Accepts hanging files. High drawer sides hold hanging file folders without use of hangrails.
- Adjustable wire follower.
- Baked enamel finish over rust-inhibiting phosphate pre-treatment.

! Keyed alike cores must be ordered separately — see page 699.





HOW TO SPECIFY

<p>Select Model Number</p> <p>H 5 1 2 .</p>	<p>Select Lock Option</p> <p>P Lock</p> <p>P .</p>	<p>Select Paint Color</p> <p>See page 663</p> <p>T 1</p>
--	---	---

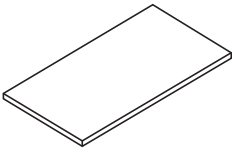
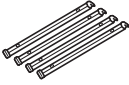

LATERAL FILE ACCESSORIES

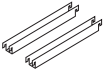
STORAGE

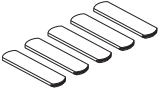

	DESCRIPTION	MODEL	SHIP WEIGHT	CUBE	LIST PRICE
	Square Edge Laminate Top				
	30"W x 18"D x 1/8" Thick	H919430	20.0	1.6	\$570
	36"W x 18"D x 1/8" Thick	H919436	25.0	1.8	\$714
	42"W x 18"D x 1/8" Thick	H919442	30.0	2.1	\$780
	60"W x 18"D x 1/8" Thick	H919460	32.0	3.0	\$985
	66"W x 18"D x 1/8" Thick	H919466	40.0	3.2	\$1127
	72"W x 18"D x 1/8" Thick	H919472	48.0	3.5	\$1155
NOTES: Compatible with Flagship® and Brigade® 18"D Lateral Files only. Laminate tops are abrasion- and stain-resistant laminate. See Storage Islands pages for broad offering of laminate top options compatible with Contain®, Flagship®, and Brigade®.					
	Single Rail Hanging File Racks (4/pack)	H919491	1.0	0.4	\$96
	NOTES: For front-to-back filing — 30"W, 36"W and 42"W files. Order one package per drawer for 42"W files. One package will do two 30"W or 36"W file drawers. Racks span between 15 1/4"W rails. Hanging file racks and dividers available in Gray only.				
	 Gray only.				
	Double-Rail Hanging File Racks (2/pack)	H919492	1.5	0.4	\$96
	NOTES: For 3 rows front-to-back — 42"W files. Order one package per drawer. Racks span between 15 1/4"W rails. Hanging file racks and dividers available in Gray only.				
	 Gray only.				
	Magnetic Label Holder	H919493	1.6	0.1	\$30
	5 pack				

NOTES:

- Compatible with Flagship®, Brigade® 800, 700, and 600 Series Lateral Files.
- See Contain® Accessories for hanging file racks compatible with Contain® Storage Products.

HOW TO SPECIFY

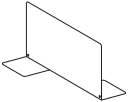
<p>Select Model Number</p> <div style="border: 1px solid black; padding: 2px; display: flex; gap: 5px;"> H919430 </div>	<p>Select Laminate</p> <p>See page 570</p> <div style="border: 1px solid black; padding: 2px; display: flex; gap: 5px;"> N </div>
---	---

	DESCRIPTION	MODEL	SHIP WEIGHT	CUBE	LIST PRICE
	Metal File Divider				
	10 pack	HSCAFD10	12	0.7	\$270
	2 pack	HSCAFD02	3	0.7	\$73
	 Metal dividers available in Black only. No need to specify.				

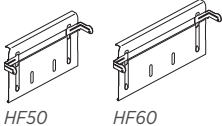
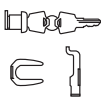

VERTICAL FILE ACCESSORIES

	DESCRIPTION	MODEL	SHIP WEIGHT	CUBE	LIST PRICE
 HF50 HF60 SIN 33721	Follower Block (4/pack)				
	Legal	HF60	8.0	0.6	\$150
	Letter	HF50	7.0	0.5	\$142
 Lock info page 699.	Chrome Core Removable Lock Kit (Field installable)	HF24	0.2	0.2	\$86
	Bulk Package — 6 HF24 Lock Kits (Individually shrink wrapped)	HF246	1.2	0.2	\$393
OPEN MARKET					

STORAGE

HOW TO SPECIFY

Select
Model Number

HF60



Icon Legend on page 19

MOBILE PEDESTALS

	DESCRIPTION	MODEL	SHIP WEIGHT	CUBE	LIST PRICE
	Mobile Pedestal 15"W x 20"D x 28"H, Box/Box/File 15"W x 20"D x 28"H, File/File	HBMP2B * HBMP2F *	60 60	6.9 6.9	\$732 \$732

NOTES:

- Pencil tray standard in top box drawer.
- One box divider standard in each box drawer.
- One crossrail standard in each file drawer.
- Ball-bearing suspension with 90% extension.
- Steel frame construction for everyday use.
- **HON 5-Year Limited Warranty.**





* De-emphasized.

STORAGE

HOW TO SPECIFY

<p>Select Model Number</p> <p>H B M P 2 B . P</p>	<p>Select Paint Color</p> <p>P Black Q Light Gray L Putty</p>
--	--

PEDESTAL ACCESSORIES

DESCRIPTION	MODEL	SHIP WEIGHT	CUBE	LIST PRICE
Counterweight — Freestanding Support Pedestals or Systems Support and Mobile Pedestals  No specification needed.	HPCW1	18.0	0.1	\$269
Follower Block — 1-Pack. Gray only. Double-Rail Hanging File Racks — 2-Pack. Gray only (for side-to-side). Adjustable Glides — 4-Pack Field installable, used to convert mobile pedestals to freestanding support pedestals. NOTES: Hardware included. Compatible with Contain®.	HF80 H519495 H20040AG	1.0 0.5 1.0	0.3 0.5 0.6	\$67 \$48 \$87
Caster Package — Field Installable Four Casters (2 swivel, 2 fixed) NOTES: Used to convert Freestanding Support Pedestals to Mobile Pedestals. Does not work on Contain® or Flagship® B/F mobile pedestals.  Not designed to be used on pedestals without a counterweight.	H1050CST	1.0 	0.6	\$62
Lock Core Replacement Kit — Chrome (Specify quantity of each key number from 101E-225E.) Contains one core, two keys, one core removable tool and instructions. Refer to page 699. SIN 33721 Master Key (one key) — Available to authorized dealers only. OPEN MARKET	HF23C HF22	0.1  0.1 	0.1 0.1	\$63 \$39



NOTES:

- Compatible with Flagship®, Brigade® and Systems Support Pedestals.

HOW TO SPECIFY

Select
Model Number

H F 2 3 C

DESCRIPTION	MODEL	SHIP WEIGHT	CUBE	FABRIC PRICE CODES
Pedestal Seat 15"W x 18"D x 2"H NOTES: Works with Contain® and Flagship® Pedestals.	HPSEAT18ND	16.3 	0.9	1 \$227 8 \$432 2 \$253 9 \$465 3 \$278 10 \$497 4 \$303 11 \$530 5 \$335 12 \$562 6 \$368 L — 7 \$400
Pedestal Seat 15"W x 22 ⁷ / ₈ "D x 2"H NOTES: Works with Contain®, Flagship®, and Fuse™ Pedestals.	HPSEAT24ND	10.0 	1.2	1 \$267 8 \$472 2 \$293 9 \$505 3 \$318 10 \$537 4 \$343 11 \$570 5 \$375 12 \$602 6 \$408 L — 7 \$440

HOW TO SPECIFY

Select
Model Number

H P S E A T 2 4 N D .

Select
Fabric

See pages 22-24 for seating fabric options

C U 1 0



PEDESTAL ACCESSORIES

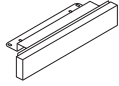

DESCRIPTION

Flush Front Kick Plate
For 28”H Flagship® Pedestals

MODEL	SHIP WEIGHT	CUBE	LIST PRICE BY PAINT GRADE		
			P1	P2	P3
HKP2800	3 Ⓞ	0.2	\$157	\$166	\$171

NOTES:

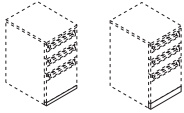

- Mounts to base of pedestal to provide a flush appearance to coordinate with laterals, file centers and storage towers.
- Kick plate is field installable.

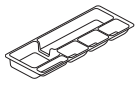

DESCRIPTION

Optional Pencil Tray

- ⓘ For use with mobile and freestanding pedestal models.
- ⓘ No specification required.

MODEL	SHIP WEIGHT	CUBE	LIST PRICE
HV-UT1	0.5	0.1	\$94

STORAGE

HOW TO SPECIFY

Select Model Number

H K P 2 8 0 0 .

Select Paint Color

See page 570

P

LAMINATE BOOKCASES

Want to see more? Scan here
to check out hon.com.



STORAGE



1870 Series Bookcases.

LAMINATE BOOKCASES

These sturdy laminate bookcases coordinate with most HON laminate desks. The scratch-, spill- and stain-resistant laminate will ensure that they keep their good looks.



1870 SERIES FEATURES

- Shelves adjust on 1/4" increments.
- Leveling glides keep them nicely aligned, even if the floor isn't.
- Easy to assemble, using high-precision cam-locks and wood dowels, with no glue needed.

BOOKCASES ORDERING INFORMATION

1870 SERIES BOOKCASES

L1 LAMINATES CODES

Woodgrain

- ◆ Cognac COGN
- ◆ Harvest C
- ◆ Mahogany N

◆◆◆ For lead time information see page 21.

1870 SERIES Laminate Bookcases

GSA SIN 33721



Icon Legend on page 19

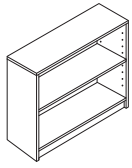

DESCRIPTION

Laminate Bookcase

- 36"W x 11½"D x 29⅞"H, 2-Shelf (1 adjustable)
- 36"W x 11½"D x 36⅞"H, 3-Shelf (2 adjustable)
- 36"W x 11½"D x 48¾"H, 4-Shelf (3 adjustable)
- 36"W x 11½"D x 60⅞"H, 5-Shelf (3 adjustable)
- 36"W x 11½"D x 72⅝"H, 6-Shelf (4 adjustable)
- 36"W x 11½"D x 84"H, 6-Shelf (4 adjustable)

MODEL

SHIP WEIGHT

CUBE

LIST PRICE

H1871	48	1.5	\$339
H1872	60	1.7	\$377
H1874	77	2.6	\$454
H1875	92	2.8	\$532
H1876	109	3.4	\$611
H1877	124	4.5	\$694

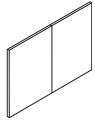

Set of doors with hinges used to conceal lower shelf contents
36"W x 25¾"H

H1801

23 **Ⓢ**

1.0

\$282

STORAGE

NOTES:

- Square edge profile complements many different furniture designs.
- Abrasion- and stain-resistant laminate, over durable solid core, high-performance particleboard.
- ¾" thick shelves adjust in ¼" increments to suit a variety of storage needs (two shelves are fixed in 5- and 6-shelf units).
- Cam-lock fasteners and wood dowels ensure pieces go together easily and precisely.
- Equipped with four adjustable leveling glides.
- Shelves will deflect under large amounts of weight.
- ⅛" hardboard back panel.
- Optional doors available to conceal lower shelf contents.
- Easy-to-assemble instructions included.

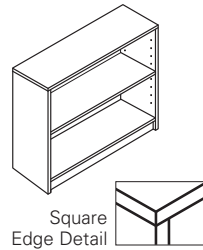

HOW TO SPECIFY

Select Model Number

Select Laminate

- COGN** Cognac
- C** Harvest
- N** Mahogany

H 1 8 7 1 .

N

ACOUSTIC SOLUTIONS

by unika vaev

Want to see more? Scan here
to check out hon.com.



Acoustic Solutions by Unika Vaev Wall Tiles shown with Contain® Lateral Storage.

UNIVERSAL SCREENS

UNIKA VAEV

The workplace as we know it is evolving. With the increasing popularity of open concept layouts, the need for creative ways to divide space and absorb sound is greater than ever. Introducing HON acoustics by Unika Vaev. We've partnered with one of the most trusted brands in the acoustic industry to bring you several of their most popular models from their standard collection. This partnership will fulfill the growing need for sound absorption in the workplace by providing proven acoustic solutions sold by HON.

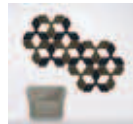

FEATURES

- Choose from wall, ceiling, and freestanding acoustic products.
- Unique shapes and designs allow for a functional and customized space.
- Freestanding and select hanging models allow for a creative way to divide your space.
- Blend in or stand out with multiple finish options.
- Products ship directly from Unika Vaev.
- Follows HON standard freight terms.
- Please see HON.com for care and installation guide.
- **HON 5-Year Limited Warranty.**

ACOUSTIC SOLUTIONS ORDERING INFORMATION

	ecoustic® Felt	Solid Core	Salsa	Dox	Fraster Felt
Wall Mounted Tiles					
e3 Collection		•			
ecoustic® Foliar	•				
ecoustic® Linear	•				
ecoustic® Matrix	•				
ecoustic® Torque	•				
Ceiling-Mounted Tiles					
ecoustic® Arbor Alto		•			
ecoustic® Ceiling Flats		•			
ecoustic® Matrix	•				
ecoustic® Torque	•				
ecoustic® Measure Baffles		•			
Hanging Screens					
ScreenTrak® Bass Collection	•				
ScreenTrak® Alto		•			
Free-standing Screens					
MixMax					•
Softline			•	•	

(02/2020)

ScreenTrak and ecoustic are registered trademarks of Unika Vaev.

ACOUSTIC SOLUTIONS ORDERING INFORMATION

ECOUSTIC*

Lemon*	EF15
Baltic*	EF36
Nautical**	EF41
Paprika*	EF53
Berry*	EF55
Aqua*	EF62
Field*	EF68
Aubergine*	EF76
Fossil*	EF78
Dove**	EF87
Oyster**	EF88
Quartz*	EF92
Spray**	EF63
Cameo**	EF19
Caper*	EF64
Charcoal*	EF79
Cobalt*	EF35
Cream**	EF94
Fresco**	EF65
Green*	EF67
Indigo*	EF40
Jet*	EF80
Light Grey*	EF81
Lime*	EF66
Natural**	EF95
Oatmeal**	EF89
Opal**	EF93
Orange*	EF52
Pewter*	EF91
Red*	EF54
Yellow*	EF10
White**	EF96
Taupe*	EF90
Sky**	EF39

SOLID CORE

Almond	DAL1
Arizona	DAZ1
Cool	DCL1
Galaxy	DGX1
Oxide	DXD1
Snowdrop	DSW1
Tungsten	DTG1
Denim	DDM1
Fawn	DFN1
Horizon	DHN1
Olive	DLV1

SALSA

Dark Mid Grey	DL32
Mid Grey	SL36

DOX

Black	DOX50
Dark Grey	DOX51
Middle Grey	DOX52
Light Grey	DOX53

FRASTER FELT

Red	FF102
Orange	FF105
Ochre	FF130
Wine	FF136
Off White	FF150
Beige	FF160
Silver	FF170
Charcoal	FF175
Beaver	FF190
Deer	FF220
Truffle	FF250
Mint	FF262
Curry	FF274
Azur	FF312
Citrus	FF398
Banana	FF399
Dust Green	FF415
Black	FF426
Aubergine	FF437
Moss	FF448
Sepia	FF463
Tomato	FF484
Flamingo	FF534
Midnight	FF539
Ocean	FF540
Sky	FF541







To view these options in the HON Surface Materials Guide visit hon.com/fabrics-and-finishes.

* Applied over Black solid core on ScreenTrak® Bass Hanging Screens.
** Applied over White solid core on ScreenTrak® Bass Hanging Screens.

ACOUSTIC SOLUTIONS

Wall

OPEN MARKET

	DESCRIPTION	MODEL	SHIP WEIGHT	CUBE	LIST PRICE
	e3 Solid Core Parallelogram 8 ³ / ₄ " x 7 ¹ / ₂ " x 1 ¹ / ₂ ", Box of 15	HUVPAWT	5.0	0.2	\$1108
	e3 Solid Core Triangle 8 ³ / ₄ " Equilateral Sides, Box of 30	HUVTRWT	5.2	0.6	\$1108
	e3 Solid Core Rectangle 8 ³ / ₄ " x 17 ¹ / ₂ ", Box of 7	HUVREWT	5.4	1.0	\$1108
	e3 Solid Core Large Square 8 ³ / ₄ " x 8 ³ / ₄ ", Box of 15	HUVLSWT	5.2	0.6	\$1054
	e3 Solid Core Small Square 2 ¹ / ₄ " x 2 ¹ / ₄ ", Box of 60	HUVSSWT	5.2	0.6	\$1054
	e3 Solid Core Wave 17 ¹ / ₂ " x 8 ¹ / ₂ ", Box of 8	HUVVWWT	5.2	0.6	\$1108
	e3 Solid Core Hexagon 17 ¹ / ₂ " x 15 ¹ / ₄ ", Box of 5	HUVHEWT	5.2	0.6	\$1108



NOTES:

- Tiles sold in sets of individual shapes. Tiles can be arranged and combined to form larger and more intricate shapes. Attaches to wall by adhesive backing that ships already applied to the tiles.

Content: 100% PET (>50% Recycled PET)

Application: Wall

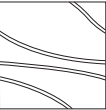
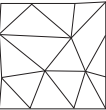
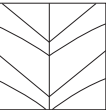
NRC: 0.40

	DESCRIPTION	MODEL	SHIP WEIGHT	CUBE	LIST PRICE
	Drift ecoustic® Wall Tiles 19 ¹ / ₁₆ "W x 19 ¹ / ₁₆ "H x 1 ¹ / ₄ "D, 8 per box NOTES: Attaches via wall clips. Content: 100% PET (>50% Recycled PET) Application: Wall NRC: 0.85	HUVDRT	13.2	4.3	\$3575
	Matrix ecoustic® Wall Tiles 19 ¹ / ₁₆ "W x 19 ¹ / ₁₆ "H x 1 ¹ / ₈ "D, 8 per box NOTES: Attaches via wall clips. Content: 100% PET (>50% Recycled PET) Application: Wall NRC: 0.90	HUVMAWT	13.2	4.3	\$3575
	Torque ecoustic® Wall Tiles 22 ² / ₈ "W x 22 ² / ₈ "H x 1 ¹ / ₈ "D, 8 per box NOTES: Attaches via wall clips. Content: 100% PET (>50% Recycled PET) Application: Wall NRC: 0.80	HUVTOWT	15.4	5.3	\$3575
	Foliar ecoustic® Wall Tiles 17 ¹ / ₂ "W x 19 ³ / ₄ "H x 2 ³ / ₁₆ "D, 5 per box NOTES: Attachment plastic frame screws to the wall. Content: 100% PET (>50% Recycled PET) Application: Wall NRC: 0.80	HUVFOWT	9.0	3.0	\$2890

HOW TO SPECIFY

Select Model Number

Select Material

See page 677

Specify ecoustic® Felt for Wall Tiles and PET Solid Core for e3 Tiles

H U V D R W T .

E F 5 2

ACOUSTIC SOLUTIONS

Ceiling Tiles and Screens

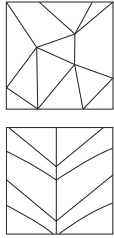

DESCRIPTION

Matrix ecoustic® Ceiling Tiles
 23³/₈"W x 23³/₈"H x 2⁹/₁₆"D, Pack of 8 tiles
 47¹/₁₆"W x 23³/₈"H x 2⁹/₁₆"D, Pack of 8 tiles

Torque ecoustic® Ceiling Tiles
 23³/₈"W x 23³/₈"H x 1⁷/₈"D, Pack of 8 tiles
 47¹/₁₆"W x 23³/₈"H x 1⁷/₈"D, Pack of 8 tiles

NOTES: Matrix and Torque tile packs contain groups of eight solid colors. Fits directly into 2' x 2' or 2' x 4' drop ceiling grid. Tiles replace ceiling tiles already in the grid. Tiles slide into grid at an angle and are held in by the edge of the tile. No hardware is needed.
 Content: 100% PET (>50% Recycled PET)
 Application: Ceiling
 NRC: 0.80 (Torque), 0.75 (Matrix)

MODEL	SHIP WEIGHT	CUBE	LIST PRICE
HUVMAWT24	15.4	5.3	\$3649
HUVMAWT48	30.9	10.7	\$5490

HUVTOWT24	15.4	5.3	\$3649
HUVTOWT48	30.9	10.7	\$5490

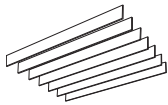

Measure Baffles

47"W x 10³/₄"H
 96"W x 10³/₄"H

NOTES: Ships 4 per box with 4' hanging cords. Attaches via ceiling brackets (not included). Attachment hardware to ceiling should be procured by installers.
 Content: 100% PET
 Application: Ceiling
 NRC: 0.80

HUVMBHS48	15.0	0.8	\$1401
HUVMBHS96	30.0	1.6	\$1759

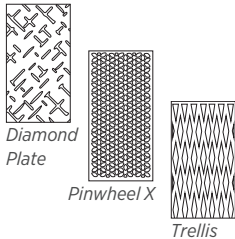

ScreenTrak® Bass Hanging Screen — Felt

95"H x 46"W x 1/2"D, Diamond Plate
 95"H x 46"W x 1/2"D, Pinwheel X
 95"H x 46"W x 1/2"D, Trellis

NOTES: Solid core with felt on top — black or white solid core is automatically assigned to each color. See page 676 for color/felt applications.

HUVSTBHS	17.4	2.7	\$2881
HUVSTBHSP	17.4	2.7	\$2881
HUVSTBHST	17.4	2.7	\$2881

ScreenTrak® Alto Hanging Screen — Solid Color Core

95"H x 46"W x 1/2"D, Diamond Plate
 95"H x 46"W x 1/2"D, Pinwheel X
 95"H x 46"W x 1/2"D, Trellis

NOTES: Ships with 10' hanging cords.

⚠ Ceiling attachment is not included due to many ceiling types and materials. Attachment hardware to ceiling should be procured by installers.

Content: 100% PET (>50% Recycled PET)
 Application: Vertical Surfaces/Screens
 NRC: 0.20

HUVSTAHS	17.4	2.7	\$2566
HUVSTAHS	17.4	2.7	\$2566
HUVSTAHS	17.4	2.7	\$2566

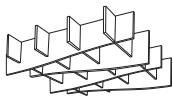

Arbor Alto ecoustic® Hanging Screen — Solid Color Core

48"H x 48"W x 4¹/₄"-7¹/₄"D

NOTES: Kit format contains 8 fins and 4' hanging cords.

⚠ Ceiling attachment is not included due to many ceiling types and materials. Attachment hardware to ceiling should be procured by installers.

Content: 100% PET
 Application: Ceiling
 NRC: 0.80

HUVAHS	15.0	0.8	\$1497
--------	------	-----	--------



ecoustic® Ceiling Flats

24" x 24", Box of 16
 24" x 48", Box of 8

NOTES: Fits directly into 2' x 2' or 2' x 4' dropped ceiling grid. Flats replace ceiling tiles already in the grid. Tiles slide into grid at an angle and are held in by the edge of the tile. No hardware is needed.

Content: 100% PET (>50% Recycled PET)
 Application: Ceiling
 NRC: 0.85
 Tiles are .47" thick.

HUVCFCT24	15.4	5.3	\$2622
HUVCFCT48	30.9	10.7	\$2786

HOW TO SPECIFY

<p>Select Model Number</p> <p>H U V S T A H S P</p>	<p>Select Felt/Solid Core</p> <p>See pages 676-677</p> <p>D L F 1</p>
---	---

UNIVERSAL SCREENS

ACOUSTIC SOLUTIONS

Floor Screens

OPEN MARKET

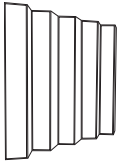

DESCRIPTION

MixMax
55"W x 59"H
63"W x 59"H

MODEL

HUVMF55
HUVMF63

SHIP WEIGHT

19.8
22.7

CUBE

24.4
24.4

LIST PRICE

\$4314
\$4767

NOTES:

- Available in one solid color. For multicolor options contact HON Tailored Solutions.
- Content: 100% 3mm Wool Felt exterior. 100% Foamed PVC Plate interior.
- Application: Floor Screen
- NRC: 0.80

UNIVERSAL SCREENS

HOW TO SPECIFY

Select
Model Number

Select
Fraster Felt

See pages 676-677

H U V M M F S 5 5 .

F F 1 3 0

ACOUSTIC SOLUTIONS Floor Screens

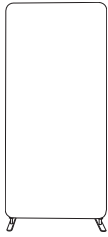

DESCRIPTION

Softline Floor Screen with Leg Set

32"W x 54"H
32"W x 59"H
32"W x 67"H

40"W x 54"H
40"W x 59"H
40"W x 67"H

47"W x 54"H
47"W x 59"H
47"W x 67"H

NOTES: Legs allow for screens to be freestanding.

Softline Floor Screen with Leg Set and Casters

32"W x 54"H
32"W x 59"H
32"W x 67"H

40"W x 54"H
40"W x 59"H
40"W x 67"H

47"W x 54"H
47"W x 59"H
47"W x 67"H

NOTES: Casters allow screens to be mobile.

MODEL

SHIP WEIGHT

CUBE

LIST PRICE

HUVSLFS3254L	25	12.5	\$1550
HUVSLFS3259L	30	12.5	\$1814
HUVSLFS3267L	35	12.5	\$2002
HUVSLFS4054L	27	10.4	\$1727
HUVSLFS4059L	33	10.4	\$1947
HUVSLFS4067L	38	10.4	\$2147
HUVSLFS4754L	30	7.8	\$1872
HUVSLFS4759L	36	7.8	\$2083
HUVSLFS4767L	43	7.8	\$2251

HUVSLFS3254LC	26	12.5	\$1622
HUVSLFS3259LC	31	12.5	\$1884
HUVSLFS3267LC	36	12.5	\$2075
HUVSLFS4054LC	28	10.4	\$1800
HUVSLFS4059LC	34	10.4	\$2018
HUVSLFS4067LC	39	10.4	\$2218
HUVSLFS4754LC	31	7.8	\$1943
HUVSLFS4759LC	37	7.8	\$2155
HUVSLFS4767LC	44	7.8	\$2324

NOTES:

- Softline is manufactured on the basis of technical, environmental, and production ethical requirements. There are no emissions to air, water, or land during the production of Softline. The sound-absorbent core of Softline contains recycled materials. Materials in Softline screens are recyclable, either as material recycling or energy recovery.
- Softline screens are 2" thick.
- Core Content: 100% Mineral Wool
- Frame Content: 100% Pine
- Base Content: 100% Steel lacquered in Black, Gray, or White
- Application: Floor Screen
- NRC: 0.75
- Each screen ships with one in-line connector.
- Screen legs prohibit screens from sitting directly at an L-, T-, or X-connection. Space must be provided to prevent legs from overlapping.

UNIVERSAL SCREENS

HOW TO SPECIFY

<p>Select Model Number</p> <p>H U V S L F S 4 0 5 4 L</p>	<p>Select Fabric</p> <p>See page 677</p> <p>S L 4 0</p>	<p>Select Paint Color</p> <p><i>Specify on screens with legs and legs with casters only</i></p> <p>SVR Silver WHTT White Texture BLKT Black Texture</p> <p>WHTT</p>
--	--	--

UNIVERSAL SCREENS

Want to see more? Scan here to check out hon.com.



Universal Screens shown with Ignition® 2.0 Seating and Contain® Storage.

UNIVERSAL SCREENS

UNIVERSAL SCREENS

HON's Universal Screens platform was designed with a user's privacy in mind. From stand-alone offices to training rooms to workstations, this solution optimizes shared open spaces by encouraging optional discretion. With visual barriers available in a wide variety of material options and personal tool accessories to encourage personalized comfort and control, HON Universal Screens help define boundaries without discouraging connection.



FEATURES

- A variety of different mounting styles to accommodate a wide range of applications throughout the office.
- The screens offer a cohesive design aesthetic to help define and personalize any space.
- Screens were designed to be paired with the entire HON portfolio.
- Universal Screens offer a broad range of material options: fabric, metal, glass, laminate, acrylic, and PET.
- Universal Screens provide consistent sizes between various applications to create a consistent appearance across all applications.

UNIVERSAL SCREENS ORDERING INFORMATION

FABRIC — GRADE 1

DAPPER	DAPR
◆ Ash	DAPR20
◆ Breeze	DAPR06
◆ Canvas	DAPR25
◆ Charcoal	DAPR01
◆ Clover	DAPR22
◆ Currant	DAPR00
◆ Fawn	DAPR35
◆ Fern	DAPR85
◆ Gerbera	DAPR16
◆ Grape	DAPR33
◆ Jewel	DAPR08
◆ Marigold	DAPR65
◆ Onyx	DAPR10
◆ Orchid	DAPR90
◆ Parrot	DAPR59
◆ Poppy	DAPR19
◆ Sapphire	DAPR07
◆ Scarlet	DAPR45
◆ Sepia	DAPR30
◆ Sky	DAPR44
◆ Slate	DAPR15
◆ Sorbet	DAPR55
◆ Spring	DAPR80
◆ Terracotta	DAPR13
◆ Titanium	DAPR17
◆ Varsity	DAPR09
◆ Zest	DAPR70

FABRIC — GRADE A

APPOINT	APN
◆ Artichoke	APN11
◆ Blackberry	APN32
◆ Bronze	APN22
◆ Carbon	APN28
◆ Chai	APN12
◆ Cherry	APN30
◆ Dark Pewter	APN17
◆ Dune	APN15
◆ Espresso	APN23
◆ Framboise	APN31
◆ Frost	APN34
◆ Jet	APN27
◆ Lawn	APN25
◆ Mandarin	APN29
◆ Morel	APN09
◆ Nimbus	APN16
◆ Platinum	APN24
◆ Turquoise	APN26

CENTURION	CU
<i>Not available on heights over 54" H</i>	
◆ Apricot	CU47
◆ Bark	CU25
◆ Black	CU10
◆ Espresso	CU49
◆ Fog	CU03
◆ Frost	CU22
◆ Goldenrod	CU27
◆ Indigo	CU06
◆ Iris	CU50
◆ Iron Ore	CU19
◆ Jade	CU83
◆ Marsala	CU63
◆ Morel	CU24
◆ Navy	CU98
◆ Peacock	CU97
◆ Pear	CU84
◆ Ruby	CU67
◆ Sapphire	CU09

FABRIC — GRADE A *continued*

ETCH*	ECH
◆ Axis	ECH13
◆ Blend	ECH14
◆ Cast	ECH12
◆ Highlight	ECH10
◆ Midtone	ECH11
◆ Outline	ECH08
◆ Shade	ECH09
◆ Tonal	ECH16
◆ Vanish	ECH15

LANDSCAPE*	LN
◆ Azure	LN55
◆ Cornsilk	LN15
◆ Drift	LN05
◆ Khaki	LN20
◆ Sheen	LN10
◆ Slate	LN35
◆ Umber	LN25
◆ Urban	LN30

NOBLE	NBLE
◆ Aegean	NBLE18
◆ Amethyst	NBLE19
◆ Aspen	NBLE14
◆ Aster	NBLE20
◆ Blossom	NBLE21
◆ Bluebell	NBLE22
◆ Bordeaux	NBLE01
◆ Brick	NBLE02
◆ Chambray	NBLE10
◆ Chamomile	NBLE23
◆ Clementine	NBLE04
◆ Conifer	NBLE24
◆ Cottage	NBLE25
◆ Darkness	NBLE26
◆ Dawn	NBLE13
◆ Denim	NBLE09
◆ Desert Sand	NBLE27
◆ Dewfall	NBLE28
◆ Dusted Sage	NBLE29
◆ Flax	NBLE30
◆ Grass	NBLE07
◆ Gunmetal	NBLE15
◆ Harmony	NBLE31
◆ Harvest	NBLE12
◆ Ice Caves	NBLE32
◆ Icicle	NBLE33
◆ Inky	NBLE34
◆ Iris	NBLE35
◆ Jade	NBLE06
◆ Knight	NBLE17
◆ Mesa	NBLE03
◆ Monarch	NBLE36
◆ Pacific	NBLE08
◆ Pitch	NBLE37
◆ Queen Bee	NBLE38
◆ Rainforest	NBLE05
◆ Regal	NBLE11
◆ Sandcastle	NBLE39
◆ Sedona	NBLE40
◆ Stormy	NBLE16
◆ Sunbeam	NBLE41
◆ Voyager	NBLE42
◆ Windy Day	NBLE43

REFLECTIONS*	REF
◆ Galvanized	REF29
◆ Ice	REF20
◆ Loggia	REF21
◆ Mistral	REF28
◆ Moonstone	REF23
◆ Pewter	REF22
◆ Stainless	REF24
◆ Vanilla	REF25
◆ Winter	REF27

FABRIC — GRADE A *continued*

REFUGE*	RFG
◆ Artesian	RFG96
◆ Dune	RFG92
◆ Eclipse	RFG90
◆ Frost	RFG93
◆ Glacier	RFG91
◆ Mineral	RFG98
◆ Tidal	RFG94

TEMPEST*	TP
◆ Dragonfly	TP30
◆ Frost	TP15
◆ Full Stream	TP80
◆ Gold Rush	TP10
◆ Slate	TP45
◆ Tumbleweed	TP70
◆ Wind Chill	TP40
◆ Zebra	TP35

VAST	VST
◆ Atmosphere	VST06
◆ Bay	VST04
◆ Beach	VST11
◆ Country Side	VST13
◆ Desert	VST12
◆ Garden	VST02
◆ Grasslands	VST03
◆ Highway	VST09
◆ Mountain Range	VST08
◆ Ocean	VST07
◆ Open Air	VST05
◆ Tundra	VST10
◆ Vineyard	VST01

FABRIC — GRADE B

COAST*	COA
<i>Not available on Accelerate*</i>	
◆ Channel	COA14
◆ Dune	COA03
◆ Headlands	COA10
◆ Marsh	COA02
◆ Pebble	COA12
◆ Pier	COA13
◆ Shoal	COA01
◆ Silt	COA06
◆ Tide	COA08

SPIN*	SPIN
◆ Alabaster	SPIN02
◆ Cavern	SPIN03
◆ Cobblestone	SPIN04
◆ Ember	SPIN06
◆ Flame	SPIN07
◆ Heron	SPIN13
◆ Oat	SPIN01
◆ Ocean	SPIN12
◆ Plum	SPIN15
◆ Pool	SPIN11
◆ Raven	SPIN10
◆ Rhubarb	SPIN14
◆ Tropic	SPIN08
◆ Willow	SPIN05

TERRAIN*	TRRN
◆ Bay	TRRN05
◆ Bayou	TRRN35
◆ Canyon	TRRN30
◆ Cliff	TRRN45
◆ Crest	TRRN25
◆ Delta	TRRN10
◆ Plateau	TRRN15
◆ Ridge	TRRN20
◆ Valley	TRRN40

METAL SCREENS

PAINTS CODES

P1	CODES
◆ Black	P71
◆ Brownstone	P7D
◆ Cove	P096
◆ Designer White	PJW
◆ Dune	P094
◆ Flint	P02
◆ Fossil	P28
◆ Greige	T5
◆ Harbor	P097
◆ Light Grey	Q
◆ Loft	LOFT
◆ Muslin	T3
◆ Putty	L
◆ Sage	P095
◆ Titanium	P8T

P2	CODES
◆ Champagne Metallic	T4
◆ Gunmetal Metallic	PR3
◆ Platinum Metallic	T1
◆ Silver	PR6
◆ Solar Black	P8X

P3	CODES
◆ Amethyst	P091
◆ Atom	P8S
◆ Blossom	P8K
◆ Bullseye	PJF
◆ Cobalt Mica	P090
◆ Ember	P8P
◆ Ion	P8N
◆ Iris	P8J
◆ Krypton	P8F
◆ Ochre	P093
◆ Regatta	P8M
◆ Sienna	P092
◆ Succulent	P8A

P6	CODES
◆ Markerboard	MKB

LAMINATE

L1 LAMINATES CODES

Woodgrain	CODES
◆ Bourbon Cherry	H
◆ Cognac	COGN
◆ Field Elm	LWFE
◆ Florence Walnut	LFW1
◆ Harvest	C
◆ Kingswood Walnut	LK11
◆ Mahogany	N
◆ Mocha	MOCH
◆ Natural Maple	D
◆ Pinnacle	PINC
◆ Shaker Cherry	F
◆ Sterling Ash	LSA1

Solid	CODES
◆ Black	P
◆ Charcoal	S
◆ Designer White	LDW1
◆ Loft	LOFT

Patterned	CODES
◆ Handspun Chestnut	LAHC
◆ Handspun Dove	LAHD
◆ Handspun Pearl	LAHP
◆ Handspun Slate	LAHS
◆ Silver Mesh	B9

L2 LAMINATES CODES

Woodgrain	CODES
◆ Beigewood	LWBE
◆ Fawn Cypress	LFC1
◆ Lowell Ash	LLA1
◆ Natural Recon	LNRI
◆ Phantom Ecu	LPE1
◆ Portico Teak	LPT1
◆ Skyline Walnut	LSW1

◆◆◆ For lead time information see page 21.

* Directional fabrics

* De-emphasized

UNIVERSAL SCREENS

Statement of Line

FABRIC SCREENS



Modesty Screen

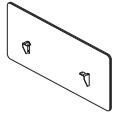

Fixed Above/Below Screen

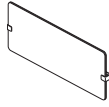

Movable Above/Below Screen

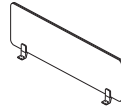

Up Mount Screen

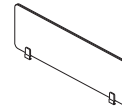

Side Mount Screen

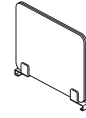

Front-to-Back Screen

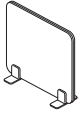

Sit-on-Surface Screen

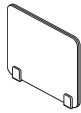

Top Mount Screen

GLASS SCREENS

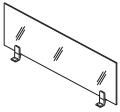

Up Mount Screen

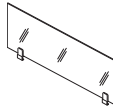

Side Mount Screen

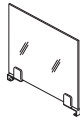

Front-to-Back Screen

UNIVERSAL SCREENS

ACRYLIC SCREENS



Modesty Screen

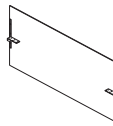

Fixed Above/Below Screen

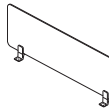

Up Mount Screen

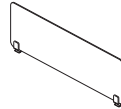

Side Mount Screen

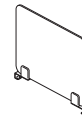

Front-to-Back Screen

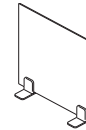

Sit-on-Surface Screen

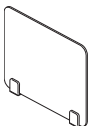

Top Mount Screen

LAMINATE SCREENS

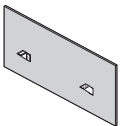

Fixed Above/Below Screen

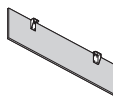

Modesty Screen

METAL SCREENS

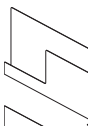

Lateral Organizer Screens

UNIVERSAL SCREENS SPECIFICATION GUIDE

AVAILABLE SCREEN MATERIALS, MOUNTING METHODS, AND SIZES

Desktop Mounted Screens

		Up Mount	Top Mount	Side Mount	F-2-B	S.O.S.	Lat Org	Modesty
Acrylic	H	13, 20	13, 20	13, 20	13, 20	13, 20		13
	W	36, 42, 48, 52, 54, 58, 60, 64, 66, 70, 72	20, 22, 24, 28, 30, 36	20, 22, 24, 28, 30, 36, 42, 46, 48, 52, 54, 58, 60, 64, 66, 70, 72	20, 22, 24, 28, 30, 36	22, 28, 34		30, 36, 42, 48, 54, 60, 66, 72
Fabric	H	13, 20	13, 20	13, 20	13, 20	13, 20		13
	W	36, 42, 46, 48, 52, 54, 58, 60, 64, 66, 70, 72	20, 22, 24, 28, 30, 36	20, 22, 24, 28, 30, 36, 42, 46, 48, 52, 54, 58, 60, 64, 66, 70, 72	20, 22, 24, 28, 30, 36	22, 28, 34		30, 36, 42, 48, 54, 60, 66, 72
Laminate	H							13
	W							30, 36, 42, 48, 54, 60, 66, 72
Glass	H	13, 20		13, 20	13, 20			
	W	36, 42, 46, 48, 52, 54, 58, 60, 64, 66, 70, 72		20, 22, 24, 28, 30, 36, 42, 46, 48, 52, 54, 58, 60, 64, 66, 70, 72	20, 22, 24, 28, 30, 36			
Metal	H						13, 20	
	W						21, 27	

Above/Below Screens

		Movable A/B	Fixed A/B
Acrylic	H		27
	W		46, 48, 52, 54, 58, 60, 64, 66, 70, 72
Fabric	H	27, 34	27, 34
	W	42, 46, 48, 52, 54, 58, 60, 64, 66, 70, 72	42, 46, 48, 52, 54, 58, 60, 64, 66, 70, 72
Laminate	H		27
	W		46, 48, 52, 54, 58, 60, 64, 66, 70, 72

Series Specific Screens

		Empower®	Gravitation™	Gravitation™ Modesty
Acrylic	H	13, 20		13
	W	42, 48, 54, 60, 66, 72		48, 60, 72
Fabric	H	13, 20	20	13
	W	42, 48, 54, 60, 66, 72	48, 60, 72	48, 60, 72
Laminate	H			13
	W			48, 60, 72
Glass	H	13, 20		
	W	42, 48, 54, 60, 66, 72		
PET	H	13, 20	20	
	W	42, 48, 54, 60, 66, 72	48, 60, 72	
Metal	H		20	
	W		48, 60, 72	

UNIVERSAL SCREENS SPECIFICATION GUIDE

SUPPORT CLEARANCE RULES

	Above/ Below Movable	Above/Below Fixed	Up Mount	Top Mount	Side Mount	Front-to- Back	Sit-on- Surface	Modesty
Recommended Inset from Edge of Worksurface								
Voi® O-Leg	>9"	No Inset	No Inset	No Inset	Not Compatible	2"	No Inset	6"
Voi® Angled Leg	>9"	No Inset	No Inset	No Inset	Not Compatible	Not Compatible	No Inset	6"
End Panel Leg	18"	6"	12"	No Inset	Not Compatible	Not Compatible	No Inset	6"
Huddle Post Leg	9"	No Inset	No Inset	No Inset	No Inset	No Inset	No Inset	6"
Coordinate™ Base	No Inset	No Inset	No Inset	No Inset	No Inset	No Inset	No Inset	No Inset
Coordinate™ Shroud	6"	No Inset	No Inset	No Inset	No Inset	No Inset	No Inset	6"
Pedestal	>Ped Width	Ped Width - 12"	Ped Width - 6"	No Inset	Not Compatible	Not Compatible	No Inset	Ped Width

SCREEN MOUNTING TECH AND SPEC INFORMATION

Movable Above/Below

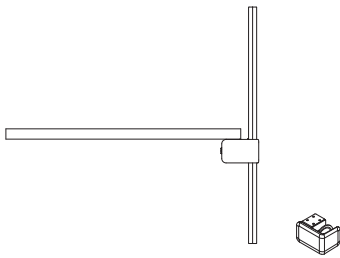

- Available in fabric only.
- Screen is offset from edge of worksurface by 1" for cord management and to allow the use of worksurface mounted accessories.
- Mounting brackets attach to the underside of the worksurface.
- Screen is secured to the brackets with thumb screws. Allowing user to adjust height up/down.
- Minimum height above or below worksurface is 6".
- Brackets are secured on the outside edge of the screen.
- Brackets ship uninstalled.

Sit-on-Surface Screen

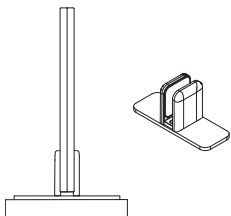

- Available in fabric or acrylic.
- Screen is slightly offset from the top of the worksurface.
- Brackets come with anti-slip neoprene foam pads.
- Brackets are designed to be rotated 90 degrees when needed.
- Screen is secured to the brackets by tightening two set screws in bracket against screen material.
- Brackets ship uninstalled.

Fixed Above/Below

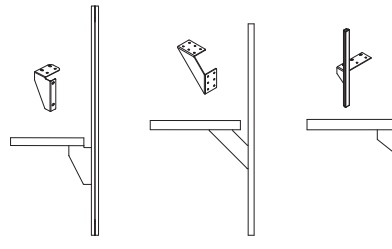

- Available in fabric, acrylic, or laminate.
- Screen is offset from the edge of the worksurface by 1" for cord management and to allow the use of worksurface mounted accessories.
- Mounting brackets attach to the underside of the worksurface.
- Fabric screens are secured to the brackets via metal fasteners to threaded inserts embedded in screen. Brackets are inset 10" (30-40"W) or 12" (42"W+) from edge of screen depending on size. Brackets ship installed.
- Acrylic screens are secured to the brackets via a metal fastener. Brackets are located on edge of screen. Brackets ship uninstalled.
- Laminate screens are secured to the brackets via wood screws. Brackets are inset 10" (30-42"W) or 12" (48"W+). Brackets ship uninstalled.

Top Mount Screen

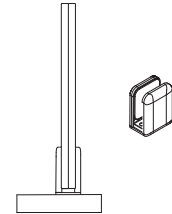

- Available in fabric or acrylic.
- Screen is slightly offset from the top of the worksurface.
- Mounting brackets attach to the top of the worksurface with either double sided tape or wood screws.
- Screen is secured to the brackets by tightening two set screws in bracket against screen material.
- Bracket location is flexible and can be adjusted as needed.
- Recommended inset location is -6-12" from edge of screen.
- Brackets ship uninstalled.

Side Mount Screen

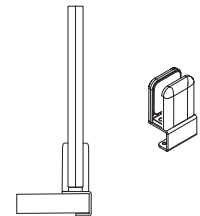

- Available in fabric or acrylic.
- Screen is slightly offset from the top of the worksurface.
- Mounting brackets wrap around the edge of the worksurface.
- Screen is secured to the brackets by tightening two set screws in bracket against screen material.
- Bracket location is flexible and can be adjusted as needed.
- Recommended inset location is -6-12" from edge of screen.
- Can only be used with flat edged worksurfaces/tables.
- Brackets ship uninstalled.

UNIVERSAL SCREENS SPECIFICATION GUIDE

SCREEN MOUNTING TECH AND SPEC INFORMATION

Modesty Panel

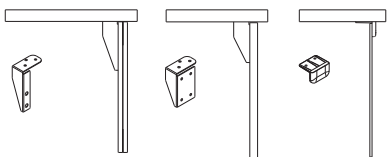

- Available in fabric, acrylic, or laminate.
- Mounting brackets attach to the underside of the work surface.
- Fabric modesty is secured to brackets via metal fasteners to threaded inserts embedded in screen. Brackets are inset 10" (30-40"W) or 12" (42"W+) from edge of screen depending on size. Brackets ship installed.
- Acrylic modesty is secured to brackets via metal fasteners through predrilled holes in the modesty panel. Brackets are inset 10" (36"W) or 12" (42"W+) from edge of screen depending on size. Brackets ship uninstalled.
- Laminate modesty is secured to brackets via wood screws. Brackets are inset 10" (30-42"W) or 12" (48"W+). Brackets ship uninstalled.

Up Mount Screen

- Available in fabric, acrylic, or glass.
- Screen is offset from top of work surface by 1" for cord management and to allow the use of work surface mounted accessories.
- Mounting brackets attach to the underside of the work surface.
- Screen is secured to the brackets by tightening two set screws in bracket against screen material.
- Bracket location is flexible and can be adjusted as needed. Recommended inset location is -6-12" from edge of screen.
- Can only be used with flat edged work surfaces/tables.
- Brackets ship uninstalled.

Front-to-Back Screen

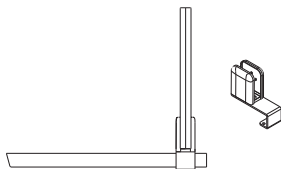

- Available in fabric, acrylic, or glass.
- Screen is slightly offset from the top of the work surface.
- Mounting brackets wrap around the front and rear edge of the work surface.
- Screen is secured to the brackets by tightening two set screws in bracket against screen material.
- Bracket location is fixed on either side of the screen.
- Can only be used with flat edged work surfaces/tables.
- Brackets ship uninstalled.

Empower® Shared Screens

- Available in fabric, glass, acrylic, or PET.
- Mounting brackets clamp in gap between fixed height work surfaces.
- Screens will provide 1"+ of access between screen and rear edge of work surface for the power trough.
- Screen is secured to the brackets by tightening two set screws in bracket against screen material.
- Bracket location is flexible and can be adjusted as needed. Recommended inset location is -6-12" from edge of screen.
- Screen only mounts to dual sided fixed height applications. For height adjustable or single sided applications, select a desktop mounted screen.
- Brackets ship uninstalled.

Gravitation™ Modesty

- Available in fabric, acrylic, or laminate.
- Gravitation™ modesty **MUST** match the beam size.
- Mounting brackets attach to the underside of the Gravitation™ power beam.
- Fabric modesty is secured to the brackets via magnetic connection. Bracket location is flexible and can be adjusted as needed. Recommended inset location is -6-12" from edge of screen.
- Acrylic and laminate modesties are secured to the mounting brackets via metal fasteners through predrilled holes in the screen material. Bracket location is fixed -3" from edge of modesty.
- Brackets come uninstalled.
- Can be used with, or without, a Gravitation™ Mounted Screen.

Gravitation™ Mounted Screens

- Available in fabric, PET, or metal.
- Gravitation™ screen **MUST** match the beam size.
- Mounting brackets wrap around and secure to the underside of the Gravitation™ power beam.
- Screens are slightly offset from the top of the power beam.
- Fabric screens are secured to the brackets by tightening two set screws in bracket against screen material. Brackets are in a fixed location -8.5" from edge of screen.
- PET screens are secured to the brackets via metal fasteners through predrilled holes in the screen material. Brackets are in a fixed location -8.5" from edge of screen.
- Metal screens are secured to the brackets via metal fasteners through predrilled holes in the screen material. Brackets are in a fixed location -8.5" from edge of screen.
- Brackets come uninstalled.
- Can be used with, or without, a Gravitation™ Modesty Panel.

Lateral Desktop Organizer

- Available in metal only.
- Screens sit flush on top of work surface.
- Screen wraps around the front or rear edge of the work surface.
- Can only be used with flat edged work surfaces/tables.
- Mounting bracket is integral to screen.

UNIVERSAL SCREENS

Fabric Screens

OPEN MARKET



Icon Legend on page 19

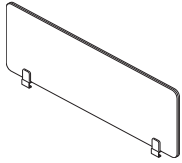

DESCRIPTION	MODEL	SHIP WEIGHT	CUBE	LIST PRICE	UPCHARGE BY FABRIC GRADE					
					B	C	D	E	F	G
Fabric Side Mount Screens — Undersized										
13"H x 22"W	HUSFFSM1322	6.8	0.8	\$777	\$33	\$65	\$98	\$142	\$184	\$228
13"H x 28"W	HUSFFSM1328	7.4	1.0	\$802	\$35	\$68	\$103	\$149	\$194	\$240
13"H x 46"W	HUSFFSM1346	8.5	1.4	\$928	\$43	\$85	\$128	\$185	\$242	\$299
13"H x 52"W	HUSFFSM1352	9.0	1.6	\$993	\$48	\$95	\$142	\$204	\$266	\$330
13"H x 58"W	HUSFFSM1358	9.5	1.8	\$1057	\$52	\$103	\$154	\$223	\$291	\$360
13"H x 64"W	HUSFFSM1364	10.0	2.0	\$1119	\$56	\$111	\$167	\$241	\$314	\$389
13"H x 70"W	HUSFFSM1370	10.5	2.2	\$1187	\$60	\$121	\$180	\$261	\$340	\$421
Fabric Side Mount Screens — True to Size										
13"H x 20"W	HUSFFSM1320	6.7	0.8	\$765	\$32	\$63	\$96	\$137	\$180	\$222
13"H x 24"W	HUSFFSM1324	7.0	0.8	\$790	\$34	\$67	\$101	\$145	\$190	\$235
13"H x 30"W	HUSFFSM1330	7.5	1.0	\$815	\$35	\$71	\$105	\$152	\$199	\$246
13"H x 36"W	HUSFFSM1336	7.9	1.0	\$869	\$39	\$78	\$116	\$169	\$220	\$271
13"H x 42"W	HUSFFSM1342	8.0	1.2	\$898	\$41	\$81	\$122	\$176	\$230	\$285
13"H x 48"W	HUSFFSM1348	8.9	1.6	\$959	\$45	\$89	\$134	\$195	\$253	\$314
13"H x 54"W	HUSFFSM1354	9.4	1.8	\$1028	\$50	\$99	\$148	\$215	\$280	\$346
13"H x 60"W	HUSFFSM1360	9.9	2.0	\$1088	\$54	\$107	\$160	\$231	\$303	\$375
13"H x 66"W	HUSFFSM1366	10.4	2.2	\$1152	\$58	\$115	\$173	\$251	\$328	\$405
13"H x 72"W	HUSFFSM1372	10.9	2.4	\$1223	\$63	\$125	\$188	\$271	\$354	\$437
20"H x 20"W	HUSFFSM2020	7.7	2.4	\$863	\$39	\$77	\$115	\$167	\$217	\$268
20"H x 24"W	HUSFFSM2024	8.2	1.3	\$892	\$40	\$81	\$121	\$175	\$228	\$283
20"H x 30"W	HUSFFSM2030	9.0	1.6	\$938	\$43	\$87	\$130	\$189	\$246	\$304
20"H x 36"W	HUSFFSM2036	9.5	1.9	\$1004	\$49	\$96	\$144	\$207	\$271	\$335
20"H x 42"W	HUSFFSM2042	9.8	1.9	\$1040	\$51	\$101	\$151	\$218	\$285	\$352
20"H x 48"W	HUSFFSM2048	11.1	2.5	\$1116	\$56	\$111	\$166	\$240	\$313	\$387
20"H x 54"W	HUSFFSM2054	11.9	2.8	\$1201	\$61	\$122	\$183	\$265	\$345	\$427
20"H x 60"W	HUSFFSM2060	12.7	3.0	\$1220	\$62	\$125	\$187	\$270	\$353	\$436
20"H x 66"W	HUSFFSM2066	13.5	3.3	\$1316	\$69	\$137	\$206	\$298	\$389	\$481
20"H x 72"W	HUSFFSM2072	14.3	3.6	\$1420	\$76	\$152	\$227	\$329	\$429	\$530

UNIVERSAL SCREENS

HOW TO SPECIFY

Select Model Number

HUSFFSM1320

Select Fabric

See page 683

NBLE18

Select Bracket Paint

See page 683

P71



Icon Legend on page 19

UNIVERSAL SCREENS

Fabric Screens

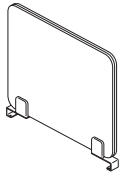

DESCRIPTION	MODEL	SHIP WEIGHT	CUBE	LIST PRICE	UPCHARGE BY FABRIC GRADE					
					B	C	D	E	F	G
Fabric Front-to-Back Screens										
13"H x 20"W	HUSFLAT1320	6.7	3.6	\$761	\$32	\$63	\$96	\$137	\$180	\$222
13"H x 22"W	HUSFLAT1322	6.8	0.8	\$773	\$33	\$65	\$98	\$142	\$184	\$228
13"H x 24"W	HUSFLAT1324	7.0	0.8	\$786	\$34	\$67	\$101	\$145	\$190	\$235
13"H x 28"W	HUSFLAT1328	7.4	1.0	\$798	\$35	\$68	\$103	\$149	\$194	\$240
13"H x 30"W	HUSFLAT1330	7.5	1.0	\$811	\$35	\$71	\$105	\$152	\$199	\$246
13"H x 36"W	HUSFLAT1336	7.9	1.2	\$865	\$39	\$78	\$116	\$169	\$220	\$271
20"H x 20"W	HUSFLAT2020	7.7	1.2	\$859	\$39	\$77	\$115	\$167	\$217	\$268
20"H x 22"W	HUSFLAT2022	7.9	1.2	\$874	\$39	\$79	\$118	\$171	\$223	\$275
20"H x 24"W	HUSFLAT2024	8.2	1.3	\$888	\$40	\$81	\$121	\$175	\$228	\$283
20"H x 28"W	HUSFLAT2028	8.7	1.5	\$904	\$41	\$83	\$124	\$179	\$235	\$290
20"H x 30"W	HUSFLAT2030	9.0	1.6	\$934	\$43	\$87	\$130	\$189	\$246	\$304
20"H x 36"W	HUSFLAT2036	9.5	1.9	\$1000	\$49	\$96	\$144	\$207	\$271	\$335

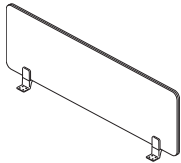

DESCRIPTION	MODEL	SHIP WEIGHT	CUBE	LIST PRICE	UPCHARGE BY FABRIC GRADE					
					B	C	D	E	F	G
Fabric Up Mount Screens										
13"H x 36"W	HUSFUPM1336	7.8	1.2	\$820	\$37	\$74	\$110	\$159	\$208	\$258
13"H x 42"W	HUSFUPM1342	8.2	1.4	\$847	\$39	\$78	\$115	\$168	\$219	\$270
13"H x 46"W	HUSFUPM1346	8.5	1.6	\$876	\$41	\$81	\$122	\$176	\$229	\$285
13"H x 48"W	HUSFUPM1348	8.5	1.6	\$907	\$43	\$85	\$128	\$185	\$241	\$298
13"H x 52"W	HUSFUPM1352	9.0	1.8	\$938	\$45	\$89	\$134	\$194	\$253	\$313
13"H x 54"W	HUSFUPM1354	9.2	1.8	\$972	\$48	\$95	\$141	\$204	\$266	\$329
13"H x 58"W	HUSFUPM1358	9.5	2.0	\$999	\$50	\$98	\$147	\$212	\$276	\$342
13"H x 60"W	HUSFUPM1360	9.6	2.0	\$1028	\$51	\$102	\$152	\$220	\$288	\$356
13"H x 64"W	HUSFUPM1364	9.9	2.2	\$1058	\$53	\$106	\$158	\$229	\$299	\$369
13"H x 66"W	HUSFUPM1366	10.1	2.2	\$1090	\$55	\$110	\$165	\$239	\$311	\$385
13"H x 70"W	HUSFUPM1370	10.4	2.4	\$1122	\$57	\$114	\$171	\$248	\$323	\$400
13"H x 72"W	HUSFUPM1372	10.5	2.4	\$1155	\$60	\$119	\$178	\$258	\$336	\$415
20"H x 36"W	HUSFUPM2036	9.5	1.9	\$995	\$49	\$98	\$146	\$211	\$274	\$340
20"H x 42"W	HUSFUPM2042	10.3	2.2	\$1013	\$50	\$100	\$149	\$216	\$282	\$348
20"H x 46"W	HUSFUPM2046	10.8	2.5	\$1032	\$52	\$102	\$153	\$222	\$289	\$358
20"H x 48"W	HUSFUPM2048	11.0	2.0	\$1052	\$53	\$105	\$157	\$227	\$296	\$367
20"H x 52"W	HUSFUPM2052	11.6	2.8	\$1087	\$55	\$109	\$164	\$238	\$310	\$383
20"H x 54"W	HUSFUPM2054	11.8	2.8	\$1121	\$57	\$114	\$171	\$247	\$322	\$400
20"H x 58"W	HUSFUPM2058	12.3	3.0	\$1140	\$59	\$116	\$175	\$253	\$330	\$408
20"H x 60"W	HUSFUPM2060	12.6	3.0	\$1160	\$60	\$120	\$179	\$259	\$337	\$417
20"H x 64"W	HUSFUPM2064	13.1	3.3	\$1178	\$61	\$122	\$182	\$264	\$344	\$427
20"H x 66"W	HUSFUPM2066	13.3	3.3	\$1198	\$62	\$125	\$187	\$270	\$353	\$435
20"H x 70"W	HUSFUPM2070	13.8	3.6	\$1219	\$64	\$127	\$191	\$276	\$360	\$446
20"H x 72"W	HUSFUPM2072	14.1	3.6	\$1258	\$66	\$132	\$198	\$287	\$375	\$463

UNIVERSAL SCREENS

HOW TO SPECIFY

<p>Select Model Number</p> <p>H U S F L A T 1 3 2 0</p>	<p>Select Fabric</p> <p>See page 683</p> <p>N B L E 1 8</p>	<p>Select Bracket Paint</p> <p>See page 683</p> <p>P 7 1</p>
---	---	--

UNIVERSAL SCREENS

Fabric Screens

OPEN MARKET



Icon Legend on page 19

UNIVERSAL SCREENS

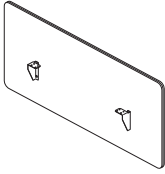

DESCRIPTION	MODEL	SHIP WEIGHT	CUBE	LIST PRICE	UPCHARGE BY FABRIC GRADE					
					B	C	D	E	F	G
Fabric Fixed Above/Below Screens										
27"H x 42"W	HUSFABF2742	9.1	2.8	\$1232	\$63	\$126	\$188	\$272	\$355	\$439
27"H x 46"W	HUSFABF2746	9.9	3.2	\$1256	\$64	\$129	\$193	\$280	\$364	\$451
27"H x 48"W	HUSFABF2748	10.4	3.2	\$1281	\$66	\$132	\$198	\$287	\$374	\$462
27"H x 52"W	HUSFABF2752	11.2	3.6	\$1307	\$68	\$135	\$203	\$294	\$383	\$474
27"H x 54"W	HUSFABF2754	11.7	3.6	\$1332	\$69	\$138	\$207	\$301	\$392	\$485
27"H x 58"W	HUSFABF2758	12.5	4.0	\$1359	\$72	\$143	\$214	\$309	\$403	\$499
27"H x 60"W	HUSFABF2760	13.0	4.0	\$1386	\$74	\$146	\$219	\$317	\$413	\$512
27"H x 64"W	HUSFABF2764	13.8	4.4	\$1467	\$79	\$157	\$235	\$340	\$444	\$549
27"H x 66"W	HUSFABF2766	14.3	4.4	\$1556	\$84	\$169	\$252	\$366	\$477	\$591
27"H x 70"W	HUSFABF2770	15.1	4.8	\$1650	\$90	\$181	\$271	\$393	\$514	\$635
27"H x 72"W	HUSFABF2772	15.6	4.8	\$1752	\$98	\$195	\$292	\$423	\$551	\$683
34"H x 42"W	HUSFABF3442	11.4	3.5	\$1092	\$54	\$107	\$160	\$231	\$303	\$374
34"H x 46"W	HUSFABF3446	12.5	3.9	\$1112	\$55	\$109	\$164	\$238	\$310	\$383
34"H x 48"W	HUSFABF3448	13.1	3.9	\$1133	\$56	\$112	\$168	\$244	\$317	\$393
34"H x 52"W	HUSFABF3452	14.1	4.4	\$1259	\$65	\$129	\$194	\$280	\$365	\$452
34"H x 54"W	HUSFABF3454	14.7	4.4	\$1404	\$75	\$149	\$222	\$322	\$421	\$520
34"H x 58"W	HUSFABF3458	15.8	4.9	\$1462	\$78	\$156	\$234	\$339	\$443	\$547
34"H x 60"W	HUSFABF3460	16.3	4.9	\$1520	\$82	\$164	\$245	\$356	\$463	\$574
34"H x 64"W	HUSFABF3464	17.4	5.4	\$1568	\$85	\$170	\$255	\$369	\$482	\$596
34"H x 66"W	HUSFABF3466	18.0	5.4	\$1632	\$89	\$179	\$268	\$388	\$506	\$626
34"H x 70"W	HUSFABF3470	19.0	5.9	\$1643	\$90	\$180	\$270	\$391	\$510	\$632
34"H x 72"W	HUSFABF3472	19.6	5.9	\$1743	\$97	\$194	\$290	\$421	\$548	\$679

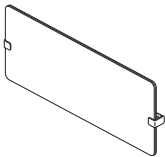

Fabric Movable Above/Below Screens										
27"H x 42"W	HUSFABM2742	12.9	2.9	\$1190	\$63	\$126	\$188	\$272	\$355	\$439
27"H x 46"W	HUSFABM2746	13.7	3.3	\$1214	\$64	\$129	\$193	\$280	\$364	\$451
27"H x 48"W	HUSFABM2748	14.1	3.3	\$1239	\$66	\$132	\$198	\$287	\$374	\$462
27"H x 52"W	HUSFABM2752	14.8	3.7	\$1264	\$68	\$135	\$203	\$294	\$383	\$474
27"H x 54"W	HUSFABM2754	15.2	3.7	\$1289	\$69	\$138	\$207	\$301	\$392	\$485
27"H x 58"W	HUSFABM2758	16.0	4.1	\$1316	\$72	\$143	\$214	\$309	\$403	\$499
27"H x 60"W	HUSFABM2760	16.3	4.1	\$1343	\$74	\$146	\$219	\$317	\$413	\$512
27"H x 64"W	HUSFABM2764	17.1	4.5	\$1424	\$79	\$157	\$235	\$340	\$444	\$549
27"H x 66"W	HUSFABM2766	17.5	4.5	\$1511	\$84	\$169	\$252	\$366	\$477	\$591
27"H x 70"W	HUSFABM2770	18.2	4.9	\$1606	\$90	\$181	\$271	\$393	\$514	\$635
27"H x 72"W	HUSFABM2772	18.6	4.9	\$1707	\$98	\$195	\$292	\$423	\$551	\$683
34"H x 42"W	HUSFABM3442	15.0	3.5	\$1051	\$54	\$107	\$160	\$231	\$303	\$374
34"H x 46"W	HUSFABM3446	15.9	4.0	\$1071	\$55	\$109	\$164	\$238	\$310	\$383
34"H x 48"W	HUSFABM3448	16.4	4.0	\$1091	\$56	\$112	\$168	\$244	\$317	\$393
34"H x 52"W	HUSFABM3452	17.4	4.5	\$1217	\$65	\$129	\$194	\$280	\$365	\$452
34"H x 54"W	HUSFABM3454	17.9	4.5	\$1361	\$75	\$149	\$222	\$322	\$421	\$520
34"H x 58"W	HUSFABM3458	18.8	5.0	\$1418	\$78	\$156	\$234	\$339	\$443	\$547
34"H x 60"W	HUSFABM3460	19.3	5.0	\$1476	\$82	\$164	\$245	\$356	\$463	\$574
34"H x 64"W	HUSFABM3464	20.2	5.5	\$1524	\$85	\$170	\$255	\$369	\$482	\$596
34"H x 66"W	HUSFABM3466	20.7	5.5	\$1588	\$89	\$179	\$268	\$388	\$506	\$626
34"H x 70"W	HUSFABM3470	21.7	6.0	\$1598	\$90	\$180	\$270	\$391	\$510	\$632
34"H x 72"W	HUSFABM3472	22.1	6.0	\$1699	\$97	\$194	\$290	\$421	\$548	\$679

HOW TO SPECIFY

Select Model Number

HUSFABF2742

Select Fabric

See page 683

NBLE18

Select Bracket Paint

See page 683

P71



Icon Legend on page 19

UNIVERSAL SCREENS

Fabric Screens

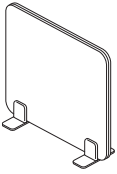
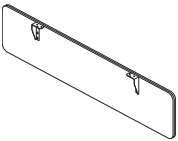
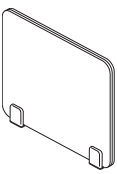
DESCRIPTION	MODEL	SHIP WEIGHT	CUBE	LIST PRICE	UPCHARGE BY FABRIC GRADE						
					B	C	D	E	F	G	
Fabric Sit-on-Surface Screens — Undersized											
	13”H x 22”W	HUSFSOS1322	6.8	0.8	\$747	\$33	\$65	\$98	\$142	\$184	\$228
	13”H x 28”W	HUSFSOS1328	7.4	1.0	\$772	\$35	\$68	\$103	\$149	\$194	\$240
	13”H x 34”W	HUSFSOS1334	7.9	1.2	\$811	\$37	\$74	\$110	\$160	\$208	\$259
	20”H x 22”W	HUSFSOS2022	7.9	1.2	\$848	\$39	\$79	\$118	\$171	\$223	\$275
	20”H x 28”W	HUSFSOS2028	8.7	1.5	\$878	\$41	\$83	\$124	\$179	\$235	\$290
	20”H x 34”W	HUSFSOS2034	9.5	1.9	\$941	\$45	\$91	\$136	\$198	\$258	\$319
Fabric Modesty Screens — True to Size											
	13”H x 30”W	HUSFMOD1330	3.1	0.9	\$926	\$42	\$84	\$127	\$183	\$239	\$295
	13”H x 36”W	HUSFMOD1336	3.7	1.1	\$959	\$44	\$89	\$133	\$193	\$251	\$311
	13”H x 42”W	HUSFMOD1342	4.4	1.3	\$976	\$45	\$91	\$136	\$198	\$258	\$319
	13”H x 48”W	HUSFMOD1348	5.0	1.5	\$1011	\$49	\$96	\$144	\$207	\$271	\$335
	13”H x 54”W	HUSFMOD1354	5.6	1.7	\$1056	\$52	\$102	\$153	\$221	\$288	\$357
	13”H x 60”W	HUSFMOD1360	6.2	1.9	\$1102	\$54	\$108	\$161	\$235	\$306	\$378
	13”H x 66”W	HUSFMOD1366	6.9	2.1	\$1185	\$60	\$120	\$178	\$259	\$337	\$417
13”H x 72”W	HUSFMOD1372	7.5	2.3	\$1275	\$66	\$131	\$197	\$285	\$371	\$459	
Fabric Top Mount Screens											
	13”H x 20”W	HUSFTPM1320	6.7	0.8	\$761	\$32	\$63	\$96	\$137	\$180	\$222
	13”H x 22”W	HUSFTPM1322	6.8	0.8	\$773	\$33	\$65	\$98	\$142	\$184	\$228
	13”H x 24”W	HUSFTPM1324	7.0	0.8	\$786	\$34	\$67	\$101	\$145	\$190	\$235
	13”H x 28”W	HUSFTPM1328	7.4	1.0	\$798	\$35	\$68	\$103	\$149	\$194	\$240
	13”H x 30”W	HUSFTPM1330	7.5	1.0	\$811	\$35	\$71	\$105	\$152	\$199	\$246
	13”H x 36”W	HUSFTPM1336	7.9	1.0	\$865	\$39	\$78	\$116	\$169	\$220	\$271
	20”H x 20”W	HUSFTPM2020	7.7	2.4	\$859	\$39	\$77	\$115	\$167	\$217	\$268
	20”H x 22”W	HUSFTPM2022	7.9	1.2	\$874	\$39	\$79	\$118	\$171	\$223	\$275
	20”H x 24”W	HUSFTPM2024	8.2	1.3	\$888	\$40	\$81	\$121	\$175	\$228	\$283
	20”H x 28”W	HUSFTPM2028	8.7	1.5	\$904	\$41	\$83	\$124	\$179	\$235	\$290
20”H x 30”W	HUSFTPM2030	9.0	1.6	\$934	\$43	\$87	\$130	\$189	\$246	\$304	
20”H x 36”W	HUSFTPM2036	9.5	1.9	\$1000	\$49	\$96	\$144	\$207	\$271	\$335	

UNIVERSAL SCREENS

HOW TO SPECIFY

<p>Select Model Number</p> <p>H U S F S O S 1 3 2 2 .</p>	<p>Select Fabric</p> <p>See page 683</p> <p>N B L E 1 8 .</p>	<p>Select Bracket Paint</p> <p>See page 683</p> <p>P 7 1</p>
--	--	---

UNIVERSAL SCREENS

Glass Screens

OPEN MARKET



Icon Legend on page 19

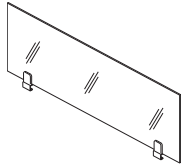

DESCRIPTION

Glass Side Mount Screens

13"H x 20"W
 13"H x 22"W
 13"H x 24"W
 13"H x 28"W
 13"H x 30"W
 13"H x 36"W
 13"H x 42"W
 13"H x 46"W
 13"H x 48"W
 13"H x 52"W
 13"H x 54"W
 13"H x 58"W
 13"H x 60"W
 13"H x 64"W
 13"H x 66"W
 13"H x 70"W
 13"H x 72"W

20"H x 20"W
 20"H x 22"W
 20"H x 24"W
 20"H x 28"W
 20"H x 30"W
 20"H x 36"W
 20"H x 42"W
 20"H x 46"W
 20"H x 48"W
 20"H x 52"W
 20"H x 54"W
 20"H x 58"W
 20"H x 60"W
 20"H x 64"W
 20"H x 66"W
 20"H x 70"W
 20"H x 72"W

MODEL	SHIP WEIGHT	CUBE	CLEAR GLASS	FROSTED GLASS
HUSGFSM1320	13.2	1.2	\$833	\$887
HUSGFSM1322	14.0	1.2	\$864	\$921
HUSGFSM1324	14.8	1.2	\$877	\$935
HUSGFSM1328	16.4	1.4	\$893	\$953
HUSGFSM1330	17.2	1.5	\$910	\$971
HUSGFSM1336	19.7	1.7	\$979	\$1047
HUSGFSM1342	22.1	2.0	\$1001	\$1072
HUSGFSM1346	23.8	2.2	\$1027	\$1101
HUSGFSM1348	24.6	2.2	\$1036	\$1110
HUSGFSM1352	26.2	2.5	\$1065	\$1142
HUSGFSM1354	27.0	2.5	\$1075	\$1153
HUSGFSM1358	28.7	2.7	\$1105	\$1186
HUSGFSM1360	29.5	2.7	\$1116	\$1198
HUSGFSM1364	31.1	3.0	\$1152	\$1238
HUSGFSM1366	31.9	3.0	\$1162	\$1248
HUSGFSM1370	33.6	3.2	\$1190	\$1279
HUSGFSM1372	34.4	3.2	\$1200	\$1290
HUSGFSM2020	17.9	1.6	\$889	\$948
HUSGFSM2022	19.2	1.6	\$919	\$981
HUSGFSM2024	20.5	1.8	\$935	\$999
HUSGFSM2028	23.1	2.0	\$953	\$1018
HUSGFSM2030	24.4	2.1	\$970	\$1037
HUSGFSM2036	28.3	2.5	\$1091	\$1171
HUSGFSM2042	32.1	2.8	\$1153	\$1239
HUSGFSM2046	34.7	3.2	\$1179	\$1267
HUSGFSM2048	36.0	3.2	\$1189	\$1278
HUSGFSM2052	38.6	3.6	\$1236	\$1331
HUSGFSM2054	39.9	3.6	\$1245	\$1340
HUSGFSM2058	42.5	3.9	\$1283	\$1382
HUSGFSM2060	43.8	3.9	\$1292	\$1392
HUSGFSM2064	46.3	4.3	\$1353	\$1459
HUSGFSM2066	47.6	4.3	\$1362	\$1469
HUSGFSM2070	50.2	4.7	\$1408	\$1519
HUSGFSM2072	51.5	4.7	\$1419	\$1531

NOTES:

! Glass screens cannot be used with height adjustable tables.

HOW TO SPECIFY

<p>Select Model Number</p> <p>H U S G F S M 1 3 2 0 .</p>	<p>Select Glass</p> <p>Q Clear Glass R Frosted Glass</p> <p>Q .</p>	<p>Select Bracket Paint</p> <p>See page 683</p> <p>P 7 1</p>
---	---	--



UNIVERSAL SCREENS

Glass Screens

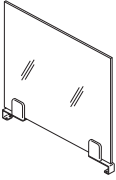
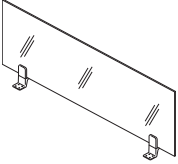
DESCRIPTION	MODEL	SHIP WEIGHT	CUBE	CLEAR GLASS	FROSTED GLASS
Glass Front-to-Back Screens					
 13"H x 20"W	HUSGLAT1320	13.2	1.2	\$834	\$888
13"H x 22"W	HUSGLAT1322	14.0	1.2	\$865	\$922
13"H x 24"W	HUSGLAT1324	14.8	1.2	\$878	\$936
13"H x 28"W	HUSGLAT1328	16.4	1.4	\$894	\$954
13"H x 30"W	HUSGLAT1330	17.2	1.5	\$911	\$972
13"H x 36"W	HUSGLAT1336	19.7	1.7	\$980	\$1048
20"H x 20"W	HUSGLAT2020	17.9	1.6	\$890	\$949
20"H x 22"W	HUSGLAT2022	19.2	1.6	\$920	\$982
20"H x 24"W	HUSGLAT2024	20.5	1.8	\$936	\$1000
20"H x 28"W	HUSGLAT2028	23.1	2.0	\$954	\$1019
20"H x 30"W	HUSGLAT2030	24.4	2.5	\$971	\$1038
20"H x 36"W	HUSGLAT2036	28.3	2.5	\$1092	\$1172
Glass Up Mount Screens					
 13"H x 36"W	HUSGUPM1336	18.5	1.7	\$958	\$1025
13"H x 42"W	HUSGUPM1342	20.7	2.0	\$981	\$1050
13"H x 46"W	HUSGUPM1346	22.2	2.2	\$1006	\$1079
13"H x 48"W	HUSGUPM1348	23.0	2.2	\$1016	\$1090
13"H x 52"W	HUSGUPM1352	24.4	2.5	\$1044	\$1120
13"H x 54"W	HUSGUPM1354	25.2	2.5	\$1055	\$1132
13"H x 58"W	HUSGUPM1358	26.7	2.7	\$1084	\$1164
13"H x 60"W	HUSGUPM1360	27.4	2.7	\$1094	\$1175
13"H x 64"W	HUSGUPM1364	28.9	3.0	\$1130	\$1215
13"H x 66"W	HUSGUPM1366	29.7	3.0	\$1140	\$1226
13"H x 70"W	HUSGUPM1370	31.2	3.2	\$1168	\$1256
13"H x 72"W	HUSGUPM1372	31.9	3.2	\$1178	\$1267
20"H x 36"W	HUSGUPM2036	27.0	2.5	\$1023	\$1097
20"H x 42"W	HUSGUPM2042	30.7	2.8	\$1048	\$1125
20"H x 46"W	HUSGUPM2046	33.2	3.2	\$1076	\$1156
20"H x 48"W	HUSGUPM2048	34.4	3.2	\$1087	\$1168
20"H x 52"W	HUSGUPM2052	36.8	3.6	\$1117	\$1200
20"H x 54"W	HUSGUPM2054	38.0	3.6	\$1129	\$1214
20"H x 58"W	HUSGUPM2058	40.5	3.9	\$1161	\$1249
20"H x 60"W	HUSGUPM2060	41.7	3.9	\$1173	\$1262
20"H x 64"W	HUSGUPM2064	44.2	4.3	\$1212	\$1306
20"H x 66"W	HUSGUPM2066	45.4	4.3	\$1223	\$1318
20"H x 70"W	HUSGUPM2070	47.8	4.7	\$1253	\$1350
20"H x 72"W	HUSGUPM2072	49.1	4.7	\$1264	\$1362

NOTES:

! Glass screens cannot be used with height adjustable tables.

HOW TO SPECIFY

<p>Select Model Number</p> <p>H U S G U P M 1 3 3 6</p>	<p>Select Glass</p> <p>Q Clear Glass R Frosted Glass</p> <p>Q</p>	<p>Select Bracket Paint</p> <p>See page 683</p> <p>P 7 1</p>
--	--	---

UNIVERSAL SCREENS

UNIVERSAL SCREENS

Acrylic Screens

OPEN MARKET



Icon Legend on page 19

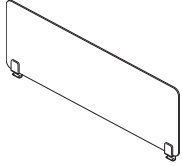

DESCRIPTION	MODEL	SHIP WEIGHT	CUBE	LIST PRICE BY PAINT GRADE		
				P1	P2	P3
Acrylic Side Mount Screens						
13"H x 20"W	HUSAFSM1320	8.6	1.9	\$623	\$638	\$654
13"H x 22"W	HUSAFSM1322	9.0	1.9	\$675	\$690	\$706
13"H x 24"W	HUSAFSM1324	9.3	2.0	\$685	\$700	\$716
13"H x 28"W	HUSAFSM1328	10.0	2.2	\$727	\$742	\$758
13"H x 30"W	HUSAFSM1330	10.4	2.5	\$784	\$799	\$815
13"H x 36"W	HUSAFSM1336	11.5	2.9	\$797	\$812	\$828
13"H x 42"W	HUSAFSM1342	12.6	3.3	\$966	\$981	\$997
13"H x 46"W	HUSAFSM1346	13.3	3.8	\$978	\$993	\$1009
13"H x 48"W	HUSAFSM1348	13.6	3.8	\$988	\$1003	\$1019
13"H x 52"W	HUSAFSM1352	14.4	4.2	\$1107	\$1122	\$1138
13"H x 54"W	HUSAFSM1354	14.7	4.2	\$1129	\$1144	\$1160
13"H x 58"W	HUSAFSM1358	15.4	4.6	\$1135	\$1150	\$1166
13"H x 60"W	HUSAFSM1360	15.8	4.6	\$1141	\$1156	\$1172
13"H x 64"W	HUSAFSM1364	16.5	5.1	\$1270	\$1285	\$1301
13"H x 66"W	HUSAFSM1366	16.9	5.1	\$1282	\$1297	\$1313
13"H x 70"W	HUSAFSM1370	17.6	5.5	\$1287	\$1302	\$1318
13"H x 72"W	HUSAFSM1372	18.0	5.5	\$1292	\$1307	\$1323
20"H x 20"W	HUSAFSM2020	10.7	2.7	\$743	\$758	\$774
20"H x 22"W	HUSAFSM2022	11.3	2.7	\$806	\$821	\$837
20"H x 24"W	HUSAFSM2024	11.8	2.9	\$884	\$899	\$915
20"H x 28"W	HUSAFSM2028	13.0	3.3	\$957	\$972	\$988
20"H x 30"W	HUSAFSM2030	13.6	3.6	\$967	\$982	\$998
20"H x 36"W	HUSAFSM2036	15.3	4.2	\$1169	\$1184	\$1200
20"H x 42"W	HUSAFSM2042	17.0	4.9	\$1466	\$1481	\$1497
20"H x 46"W	HUSAFSM2046	18.1	5.5	\$1471	\$1486	\$1502
20"H x 48"W	HUSAFSM2048	18.7	5.5	\$1477	\$1492	\$1508
20"H x 52"W	HUSAFSM2052	19.8	6.2	\$1482	\$1497	\$1513
20"H x 54"W	HUSAFSM2054	20.4	6.2	\$1751	\$1766	\$1782
20"H x 58"W	HUSAFSM2058	21.5	6.8	\$1761	\$1776	\$1792
20"H x 60"W	HUSAFSM2060	22.1	6.8	\$1773	\$1788	\$1804
20"H x 64"W	HUSAFSM2064	23.2	7.5	\$2031	\$2046	\$2062
20"H x 66"W	HUSAFSM2066	23.8	7.5	\$2036	\$2051	\$2067
20"H x 70"W	HUSAFSM2070	25.0	8.1	\$2041	\$2056	\$2072
20"H x 72"W	HUSAFSM2072	25.5	8.1	\$2047	\$2062	\$2078

UNIVERSAL SCREENS

HOW TO SPECIFY

Select Model Number

H U S A F S M 1 3 2 0 .

Select Bracket Paint

See page 683

P 7 1



UNIVERSAL SCREENS

Acrylic Screens

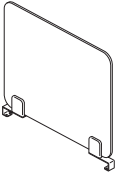
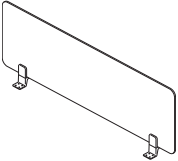
DESCRIPTION	MODEL	SHIP WEIGHT	CUBE	LIST PRICE BY PAINT GRADE		
				P1	P2	P3
Acrylic Front-to-Back Screens						
 13"H x 20"W	HUSALAT1320	8.6	1.9	\$624	\$639	\$655
13"H x 22"W	HUSALAT1322	9.0	1.9	\$676	\$691	\$707
13"H x 24"W	HUSALAT1324	9.3	2.0	\$686	\$701	\$717
13"H x 28"W	HUSALAT1328	10.0	2.2	\$728	\$743	\$759
13"H x 30"W	HUSALAT1330	10.4	2.5	\$785	\$800	\$816
13"H x 36"W	HUSALAT1336	11.5	2.9	\$798	\$813	\$829
Acrylic Up Mount Screens						
 13"H x 36"W	HUSAUPM1336	10.9	2.9	\$733	\$748	\$762
13"H x 42"W	HUSAUPM1342	11.9	3.3	\$871	\$886	\$900
13"H x 46"W	HUSAUPM1346	12.6	3.8	\$881	\$896	\$910
13"H x 48"W	HUSAUPM1348	12.9	3.8	\$893	\$908	\$922
13"H x 52"W	HUSAUPM1352	13.6	4.2	\$1013	\$1028	\$1042
13"H x 54"W	HUSAUPM1354	13.9	4.2	\$1024	\$1039	\$1053
13"H x 58"W	HUSAUPM1358	14.6	4.6	\$1035	\$1050	\$1064
13"H x 60"W	HUSAUPM1360	14.9	4.6	\$1046	\$1061	\$1075
13"H x 64"W	HUSAUPM1364	15.6	5.1	\$1156	\$1171	\$1185
13"H x 66"W	HUSAUPM1366	15.9	5.1	\$1166	\$1181	\$1195
13"H x 70"W	HUSAUPM1370	16.6	5.5	\$1178	\$1193	\$1207
13"H x 72"W	HUSAUPM1372	16.9	5.5	\$1188	\$1203	\$1217
20"H x 36"W	HUSAUPM2036	14.7	4.2	\$993	\$1008	\$1022
20"H x 42"W	HUSAUPM2042	16.3	4.9	\$1220	\$1235	\$1249
20"H x 46"W	HUSAUPM2046	17.4	5.5	\$1231	\$1246	\$1260
20"H x 48"W	HUSAUPM2048	18.0	5.5	\$1242	\$1257	\$1271
20"H x 52"W	HUSAUPM2052	19.0	6.2	\$1447	\$1462	\$1476
20"H x 54"W	HUSAUPM2054	19.6	6.2	\$1459	\$1474	\$1488
20"H x 58"W	HUSAUPM2058	20.7	6.8	\$1470	\$1485	\$1499
20"H x 60"W	HUSAUPM2060	21.2	6.8	\$1481	\$1496	\$1510
20"H x 64"W	HUSAUPM2064	22.3	7.5	\$1676	\$1691	\$1705
20"H x 66"W	HUSAUPM2066	22.8	7.5	\$1687	\$1702	\$1716
20"H x 70"W	HUSAUPM2070	23.9	8.1	\$1709	\$1724	\$1738
20"H x 72"W	HUSAUPM2072	24.4	8.1	\$1720	\$1735	\$1749

UNIVERSAL SCREENS

HOW TO SPECIFY

<p>Select Model Number</p> <p>HUSALAT1320</p>	<p>Select Bracket Paint</p> <p>See page 683</p> <p>P71</p>
---	--

UNIVERSAL SCREENS

Acrylic Screens

OPEN MARKET



Icon Legend on page 19

UNIVERSAL SCREENS

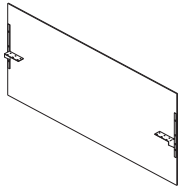
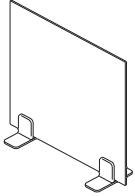
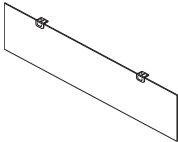
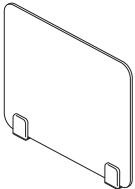
DESCRIPTION	MODEL	SHIP WEIGHT	CUBE	LIST PRICE BY PAINT GRADE		
				P1	P2	P3
Acrylic Fixed Above/Below Screens						
 27"H x 46"W	HUSAABF2746	19.9	7.2	\$1543	\$1558	\$1588
27"H x 48"W	HUSAABF2748	20.7	7.2	\$1595	\$1610	\$1640
27"H x 52"W	HUSAABF2752	22.5	8.0	\$1846	\$1861	\$1891
27"H x 54"W	HUSAABF2754	23.3	8.0	\$1899	\$1914	\$1944
27"H x 58"W	HUSAABF2758	25.1	8.9	\$1871	\$1886	\$1916
27"H x 60"W	HUSAABF2760	25.9	8.9	\$1923	\$1938	\$1968
27"H x 64"W	HUSAABF2764	27.6	9.8	\$2161	\$2176	\$2206
27"H x 66"W	HUSAABF2766	28.5	9.8	\$2214	\$2229	\$2259
27"H x 70"W	HUSAABF2770	30.2	10.6	\$2173	\$2188	\$2218
27"H x 72"W	HUSAABF2772	31.1	10.6	\$2225	\$2240	\$2270
Acrylic Sit-on-Surface Screens						
 13"H x 22"W	HUSASOS1322	7.6	1.9	\$650	\$664	\$678
13"H x 28"W	HUSASOS1328	8.4	2.5	\$702	\$716	\$730
13"H x 34"W	HUSASOS1334	9.1	2.9	\$761	\$775	\$789
20"H x 22"W	HUSASOS2022	9.2	2.7	\$781	\$795	\$809
20"H x 28"W	HUSASOS2028	10.3	3.3	\$932	\$946	\$960
20"H x 34"W	HUSASOS2034	11.5	4.2	\$1133	\$1147	\$1161
Acrylic Modesty Screens						
 13"H x 30"W	HUSAMOD1330	10.9	2.5	\$567	\$575	\$583
13"H x 36"W	HUSAMOD1336	12.0	2.9	\$649	\$657	\$665
13"H x 42"W	HUSAMOD1342	13.2	3.3	\$818	\$826	\$834
13"H x 48"W	HUSAMOD1348	14.4	3.8	\$840	\$848	\$856
13"H x 54"W	HUSAMOD1354	15.5	4.2	\$981	\$989	\$997
13"H x 60"W	HUSAMOD1360	16.7	4.6	\$1003	\$1011	\$1019
13"H x 66"W	HUSAMOD1366	17.9	5.1	\$1134	\$1142	\$1150
13"H x 72"W	HUSAMOD1372	19.0	5.5	\$1156	\$1164	\$1172
Acrylic Top Mount Screens						
 13"H x 20"W	HUSATPM1320	8.6	1.9	\$624	\$639	\$655
13"H x 22"W	HUSATPM1322	9.0	1.9	\$676	\$691	\$707
13"H x 24"W	HUSATPM1324	9.3	2.0	\$686	\$701	\$717
13"H x 28"W	HUSATPM1328	10.0	2.2	\$728	\$743	\$759
13"H x 30"W	HUSATPM1330	10.4	2.5	\$785	\$800	\$816
13"H x 36"W	HUSATPM1336	11.5	2.9	\$798	\$813	\$829
20"H x 20"W	HUSATPM2020	10.7	2.7	\$744	\$759	\$775
20"H x 22"W	HUSATPM2022	11.3	2.7	\$807	\$822	\$838
20"H x 24"W	HUSATPM2024	11.8	2.9	\$885	\$900	\$916
20"H x 28"W	HUSATPM2028	13.0	3.3	\$958	\$973	\$989
20"H x 30"W	HUSATPM2030	13.6	3.6	\$968	\$983	\$999
20"H x 36"W	HUSATPM2036	15.3	4.2	\$1170	\$1185	\$1201

HOW TO SPECIFY

<p>Select Model Number</p> <p>H U S A A B F 2 7 4 8 .</p>	<p>Select Bracket Paint</p> <p>See page 683</p> <p>P 7 1</p>
---	--



UNIVERSAL SCREENS

Laminate Screens

	DESCRIPTION	MODEL	SHIP WEIGHT	CUBE	LIST PRICE BY LAMINATE GRADE	
					L1	L2
	Laminate Fixed Above/Below Screens					
	27"H x 46"W	HUSLABF2746	27.3	3.7	\$951	\$987
	27"H x 48"W	HUSLABF2748	28.5	3.8	\$983	\$1021
	27"H x 52"W	HUSLABF2752	30.9	4.1	\$1018	\$1058
	27"H x 54"W	HUSLABF2754	32.1	4.2	\$1153	\$1201
	27"H x 58"W	HUSLABF2758	34.5	4.5	\$1196	\$1246
	27"H x 60"W	HUSLABF2760	35.6	4.7	\$1242	\$1295
	27"H x 64"W	HUSLABF2764	38.0	5.0	\$1289	\$1344
	27"H x 66"W	HUSLABF2766	39.2	5.1	\$1338	\$1396
	27"H x 70"W	HUSLABF2770	41.6	5.4	\$1391	\$1451
	27"H x 72"W	HUSLABF2772	42.8	5.6	\$1445	\$1508
	Laminate Modesty Screens					
	13"H x 30"W	HUSLMOD1330	8.6	1.4	\$606	\$623
	13"H x 36"W	HUSLMOD1336	10.3	1.6	\$619	\$637
	13"H x 42"W	HUSLMOD1342	12.0	1.9	\$633	\$652
	13"H x 48"W	HUSLMOD1348	13.7	2.1	\$646	\$665
	13"H x 54"W	HUSLMOD1354	15.4	2.3	\$753	\$779
	13"H x 60"W	HUSLMOD1360	17.2	2.6	\$767	\$794
	13"H x 66"W	HUSLMOD1366	18.9	2.8	\$886	\$919
	13"H x 72"W	HUSLMOD1372	20.6	3.1	\$898	\$932

NOTES:

❗ Laminate Fixed Above/Below Screens cannot be used with height adjustable tables unless paired with Fuse™ undermount pedestal.

UNIVERSAL SCREENS

HOW TO SPECIFY

<p>Select Model Number</p> <p>H U S L A B F 2 7 4 6 .</p>	<p>Select Laminate</p> <p>See page 683</p> <p>L W F E .</p>	<p>Select Bracket Paint</p> <p>See page 683</p> <p>P 7 1</p>
--	--	---

UNIVERSAL SCREENS

Metal Screens

OPEN MARKET



Icon Legend on page 19

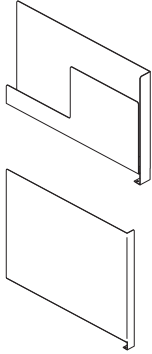

DESCRIPTION

Metal Lateral Organizer Screens

13''H x 20''W, Left Handed
 13''H x 20''W, Right Handed
 13''H x 26''W, Left Handed
 13''H x 26''W, Right Handed

20''H x 20''W, Left Handed
 20''H x 20''W, Right Handed
 20''H x 26''W, Left Handed
 20''H x 26''W, Right Handed

MODEL	SHIP WEIGHT	CUBE	LIST PRICE BY PAINT GRADE		
			P1	P2	P3
HUSMSOS1320L	7	1.2	\$521	\$536	\$551
HUSMSOS1320R	7	1.2	\$521	\$536	\$551
HUSMSOS1326L	10	1.5	\$567	\$582	\$597
HUSMSOS1326R	10	1.5	\$567	\$582	\$597
HUSMSOS2020L	10	1.0	\$573	\$588	\$603
HUSMSOS2020R	10	1.0	\$573	\$588	\$603
HUSMSOS2026L	13	1.2	\$624	\$639	\$654
HUSMSOS2026R	13	1.2	\$624	\$639	\$654

NOTES:

- Clamps to back edge of worksurface at 13''H and 20''H.
- Screen is designed to sit back from front edge of worksurface.
- Space for folders is 1½'' and holds approximately 340 sheets of paper.
- Folder storage is one-sided — LH and RH options available.

UNIVERSAL SCREENS

HOW TO SPECIFY

Select Model Number

HUSMSOS1320L.



Select Paint Color

See page 683

P71

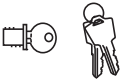
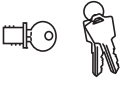

CORE REMOVABLE LOCK KITS

	DESCRIPTION	MODEL	SHIP WEIGHT	CUBE	LIST PRICE
 SIN 33721	Chrome Removable Lock Core Kit (for metal casegoods) • Use when specifying omit lock application. • Specify quantity of each key number from 101E-225E. • Includes: 1-core, 2-keys, 1-core removal tool and instructions. • Removable lock core kits with specific key number must be ordered to facilitate keying alike in the field. • For specific models, look for the Omit Lock Core icon throughout this publication. NOTES: If key number isn't specified, number will be at random. Core matches manufactured lock on metal casegoods product but can be used with Contain® and laminate product.	HF23C	0.1 Ⓔ	0.1	\$63
	Satin Removable Lock Core Kit (for metal and laminate casegoods) • Use when specifying omit lock application. • Specify quantity of each key number from 101E-225E. • Includes: 1-core, 2-keys, 1-core removal tool and instructions. • Removable lock core kits with specific key number must be ordered to facilitate keying alike in the field. • For specific models, look for the Omit Lock Core icon throughout this publication. NOTES: If key number isn't specified, number will be at random. Core matches manufactured lock on metal casegoods product but can be used with metal casegoods and laminate product. For laminate stack-on and wall mounted storage models with locks, use HF27S.	HF23S	0.1 Ⓔ	0.1	\$61
 SIN 33721	Black Removable Lock Core Kit (for laminate products) Specify quantity of each key number from 101E-225E. Includes: 1-core, 2-keys, 1-core removal tool, and instructions. NOTES: If key number isn't specified, number will be at random. Core matches manufactured lock on laminate product but can be used with metal casegoods product. For laminate stack-on and wall mounted storage models with locks, use HF27B.	HF23B	0.1 Ⓔ	0.1	\$45
	Removable Lock Core Kit Black Satin • For stack-on and wall mounted storage laminate models (with locks) in 10500, 10700, Valido, Voi, Concinnity, and 94000 Series. • Specify quantity of each key number from 101E to 225E. • Includes: 1-core, 2-keys, 1-core removal tool, and instructions. NOTES: If key number isn't specified, number will be at random.	HF27B HF27S	0.2 0.2	0.02 0.02	\$45 \$45
 OPEN MARKET	Master Key (one key) Will open all HON product with HON "One Key" interchangeable core removable locks. Available to authorized dealers only. Will open HF23B, HF23C, HF23S, HF24, HF27B, and HF27S locks numbered 101E-225E. Will open old HON style MB series locks.	HF22	0.1 Ⓔ	0.1	\$39
	Chrome Core Removable Lock Kit for Vertical Files Field Installable. Specify key number from 101E-225E. Includes: 1-lock with core, 2-keys and attaching linkage. NOTES: If key number isn't specified, number will be at random.	HF24	0.2 Ⓔ	0.2	\$86
 OPEN MARKET	Bulk Package 6 HF24 Lock Kits (Individually shrink wrapped) NOTES: Bulk Package key numbers are at random and cannot be specified.	HF246	1.2 Ⓔ	0.2	\$393

NOTES:

- HON "One Key" interchangeable core removable locks are standard on most HON products. Look for the HON "One Key" icon.
- Keyed alike cores are listed above.
- If key number is not specified, number will be at random.
- For keyed alike locks:
 - Order standard product which will be shipped with factory installed locks and random numbered cores or omit lock option where offered.
 - Order the appropriate quantity of like numbered cores required for each workstation or keyed area.
 - Simply replace the factory installed cores with the replacement cores after product has been installed.
- To install new core:
 - Lock must be in the unlocked position.
 - Insert core removal key and pull core straight out.
 - Insert new core with core removable key, hold core into lock and withdraw core removal key.
 - Retain original core for future use.
- To provide normal lead times, key numbers cannot be specified on HON products at time of order. This also eliminates need for tagging and tracking each product's lock number during installation.
- Black removable lock core kit used on laminate casegoods.
- Chrome removable lock core kit used on metal casegoods.



HOW TO ORDER CORE REMOVABLE LOCK KITS:

Specify: Model Number.X
Key Number
Examples: HF23C.X121E
HF23C.X (Key number not specified)

NOTES: Key orders without numbers specified will be keyed at random.
Numbers 101E-225E are available.

SAMPLE ORDER:

Quantity	Model	Key Code
6	HF23C.	X121E
4	HF23B.	X121E
5	HF24.	X121E
1	HF22.	X
2	HF24.	X



TOUCH-UP PAINT

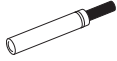

DESCRIPTION

MODEL

SHIP WEIGHT

CUBE

LIST PRICE BY PAINT GRADE

P1

P2

P3

1 Touch-up Paint (.6 oz.)

HPMARKER1

0.1

0.1

\$53

\$61

\$72

NOTES: Touch-up Paint available in P1, P2, and P3 colors.

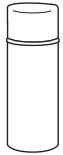

Spray Paint (12 oz.)

HSPRAY

0.5

0.1

\$53

\$61

\$72

NOTES: Touch-up Paint available in P1, P2, and P3 colors.

! Designer White Texture (PK7) for use with Solve base only.

NOTES:

- Allows minor repairs in the field.
- Shippable by small package carrier, ground only.
- Must specify color when ordering.

HOW TO SPECIFY

Select Model Number

Select Color

See page 702

HPMARKER1 . P

WORKPLACE TOOLS



Flock® Modular Seating with Dean Power Module Under-Surface Mount.

WORKPLACE TOOLS

Workplace tools provide the finishing touch on any high-performance workspace. From storage options to technological tools and lighting solutions, HON's Workplace Tools deliver organization and efficiency to the office. Workplace Tools put everything you need to be productive within arm's reach, provide easy access to the connectivity you need to be successful and help you keep your workspace neat.



PRODUCT CATEGORIES

- Monitor Arms
- Keyboard Trays and Center Drawers
- Paper Management and Organizational Tools
- Task Lights
- Electrical and Power Management Accessories
- Ergonomic and Healthy Workplace Solutions

WORKPLACE TOOLS ORDERING INFORMATION

LAMINATE CENTER DRAWERS, LAMINATE PAPER MANAGEMENT MODELS HLVPM1/HLDST1/ HLSL1472LS/HLSL1460LS

L1 LAMINATES CODES

Woodgrain

- ◆ Bourbon Cherry H
- ◆ Cognac COGN
- ◆ Florence Walnut LFW1
- ◆ Harvest C
- ◆ Kingswood Walnut LK11
- ◆ Mahogany N
- ◆ Mocha MOCH
- ◆ Natural Maple D
- ◆ Pinnacle PINC
- ◆ Shaker Cherry F
- ◆ Sterling Ash LSA1

Solid

- ◆ Black P
- ◆ Charcoal S
- ◆ Designer White LDW1
- ◆ Loft LOFT

L2 LAMINATES CODES

Woodgrain

- ◆ Lowell Ash LLA1
- ◆ Natural Recon LNR1
- ◆ Phantom Ecreu LPE1
- ◆ Portico Teak LPT1
- ◆ Skyline Walnut LSW1

LAMINATE KEYBOARD PLATFORM MODELS H4022/HE4022

L1 LAMINATES CODES

Woodgrain

- ◆ Bourbon Cherry H
- ◆ Cognac COGN
- ◆ Field Elm LWEF
- ◆ Florence Walnut LFW1
- ◆ Harvest C
- ◆ Kingswood Walnut LK11
- ◆ Mahogany N
- ◆ Mocha MOCH
- ◆ Natural Maple D
- ◆ Pinnacle PINC
- ◆ Shaker Cherry F
- ◆ Sterling Ash LSA1

Solid

- ◆ Black P
- ◆ Charcoal S
- ◆ Designer White LDW1

Patterned

- ◆ Handspun Chestnut LAHC
- ◆ Handspun Dove LAHD
- ◆ Handspun Pearl LAHP
- ◆ Handspun Slate LAHS
- ◆ Silver Mesh B9
- ◆ Steel Mesh A9
- ◆ Gray G2
- ◆ White G1

L2 LAMINATES CODES

Woodgrain

- ◆ Beigewood LWBE
- ◆ Fawn Cypress LFC1
- ◆ Lowell Ash LLA1
- ◆ Natural Recon LNR1
- ◆ Phantom Ecreu LPE1
- ◆ Portico Teak LPT1
- ◆ Skyline Walnut LSW1

METAL PAPER MANAGEMENT MODELS HHPS1 AND HDPS1

PAINT CODES

P1

- ◆ Black P
- ◆ Brownstone P7D
- ◆ Charcoal S
- ◆ Designer White PJW
- ◆ Fossil P28
- ◆ Greige T5
- ◆ Light Gray Q
- ◆ Loft LOFT
- ◆ Muslin T3
- ◆ Putty L
- ◆ Titanium P8T

P2

- ◆ Champagne Metallic T4
- ◆ Gunmetal Metallic PR3
- ◆ Platinum Metallic T1
- ◆ Silver PR6

P3

- ◆ Amethyst * P091
- ◆ Atom P8S
- ◆ Blossom P8K
- ◆ Bullseye PJF
- ◆ Cobalt Mica * P090
- ◆ Ember P8P
- ◆ Ion P8N
- ◆ Iris P8J
- ◆ Krypton P8F
- ◆ Ochre P093
- ◆ Regatta P8M
- ◆ Sienna P092
- ◆ Succulent P8A

METAL CENTER DRAWERS*, CORNER SLEEVES, METAL KEYBOARD PLATFORM, STORAGE CUBES, DRAWER ORGANIZER, HAND SANITIZER STATION

PAINT CODES

P1

- ◆ Black P
- ◆ Brownstone P7D
- ◆ Charcoal S
- ◆ Designer White PJW
- ◆ Fossil P28
- ◆ Greige T5
- ◆ Light Gray Q
- ◆ Loft LOFT
- ◆ Muslin T3
- ◆ Putty L
- ◆ Titanium P8T

P2

- ◆ Champagne Metallic T4
- ◆ Gunmetal Metallic PR3
- ◆ Platinum Metallic T1
- ◆ Silver PR6
- ◆ Solar Black P8X

P3

- ◆ Amethyst * P091
- ◆ Atom P8S
- ◆ Blossom P8K
- ◆ Bullseye PJF
- ◆ Cobalt Mica * P090
- ◆ Ember P8P
- ◆ Ion P8N
- ◆ Iris P8J
- ◆ Krypton P8F
- ◆ Ochre P093
- ◆ Regatta P8M
- ◆ Sienna P092
- ◆ Succulent P8A

* Metal center drawer models HD2 and HD8 limited to P1 Paints, Champagne Metallic, and Platinum Metallic.







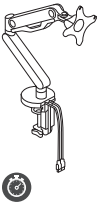
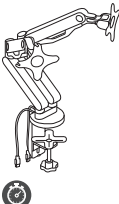
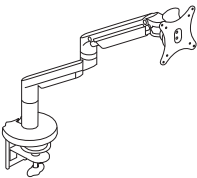

◆◆◆ For lead time information see page 21.

* De-emphasized

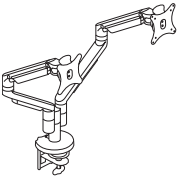

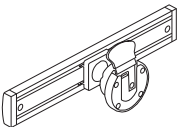
Icon Legend on page 19

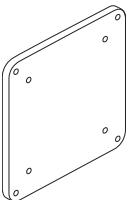
MONITOR ARMS

	DESCRIPTION	MODEL	SHIP WEIGHT	CUBE	LIST PRICE
	<p>Single Monitor Arm with 2 USB Ports</p> <p>NOTES: Easy adjustment. Height adjusts to 17" tall. Monitor tilt and swivel capability. Enclosed cable management. Grommet or desktop mounting. Clean appearance. HON 5-Year Limited Warranty.</p> <ul style="list-style-type: none"> Available in Silver only, no specification needed. Cannot be used in Empower® height adjustable applications. Arm holds monitors up to 19 lbs. 	HBSMAUSB	38.6	2.4	\$330
	<p>Dual Monitor Arm with 2 USB Ports</p> <p>NOTES: Easy adjustment. Height adjusts to 17" tall. Monitor tilt and swivel capability. Enclosed cable management. Grommet or desktop mounting. Clean appearance. In some applications the Monitor Arms may extend 12 or more inches into the worksurface. HON 5-Year Limited Warranty.</p> <ul style="list-style-type: none"> Available in Silver only, no specification needed. Cannot be used in Empower® height adjustable applications. Each arm holds monitors up to 19 lbs. 	HBDMAUSB	41.9	2.6	\$492
	<p>Single Dynamic Monitor Arm</p> <ul style="list-style-type: none"> 180° of rotation at base with optional 360° rotation. Arms extend 22" and retract up to 3". Monitor mount rotates 180° and tilts +/-30°. Monitor can be rotated from landscape to portrait position. <ul style="list-style-type: none"> Arms hold monitors from 6.2-18 lbs. Optional counterweight HPACW available to support monitors as low as 5 lbs. Back side of monitor arm base features opening for wire management through grommet when utilizing clamp mount. 	HMASTS	11.5 	0.8	\$600
	<p>Dual Dynamic Monitor Arm</p> <ul style="list-style-type: none"> Arms have 65° rotation at base with optional 130° and 360° rotations. Arms extend 22" and retract up to 3". Monitor mount rotates 180° and tilts +/-30°. Monitor can be rotated from landscape to portrait position. <ul style="list-style-type: none"> Arms hold monitors from 6.2-18 lbs. Optional counterweight HPACW available to support monitors as low as 5 lbs. Back side of monitor arm base features opening for wire management through grommet when utilizing clamp mount. 	HMASD	17.0 	1.1	\$1152
	<p>Sliding Mount for Monitor Arm</p> <ul style="list-style-type: none"> Supports monitors up to 18 lbs. Compatible with VESA 75mm and 100mm mounts. Compatible with models HMASTS, HMASD, HPASD, HPADD, and HPATF. Available in two paint finishes, Silver (SVR) and Black (BLK). Plastic components ship in like color with specified paint finish. 	HPACSM	3.0 	0.3	\$248
	<p>Monitor Arm Counterweight</p> <ul style="list-style-type: none"> Optional counterweight for monitors as low as 5 lbs. Minimum weight for monitors without counterweight is 6.2 lbs. <ul style="list-style-type: none"> Available in Black only, no specification needed. Compatible with models HMASTS, HPASD, HMASD, HPADD, and HPATF. 	HPACW	3.0 	0.1	\$37

SIN 33721

HOW TO SPECIFY

<p>Select Model Number</p> <p>H M A S T S .</p>	<p>Select Finish</p> <p>SVR Silver BLK Black</p> <p>S V R</p>
--	--



MONITOR ARMS

DESCRIPTION

MODEL SHIP WEIGHT CUBE LIST PRICE

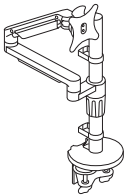

Post Mount with Single Dynamic Arm

- Arm has 360° rotation at base.
- Monitor mount rotates 180° and tilts +/-30°.
- Monitor can be rotated from landscape to portrait position.
- Arm extends up to 20".
- Arm has 17¾" of vertical adjustment.

⚠ Available in Silver (SVR) finish only.

⚠ Arms hold monitors from 6.2-18 lbs. Optional counterweight HPACW available to support monitors as low as 5 lbs. (see page 703).

HPASD 15.5 1.3 \$839

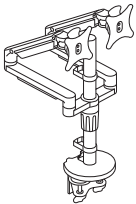

Post Mount with Dual Dynamic Arms

- Arms have 360° rotation at base.
- Monitor mount rotates 180° and tilts +/-30°.
- Monitor can be rotated from landscape to portrait position.
- Arms extend up to 20".
- Arms have 17¾" of vertical adjustment.

⚠ Available in Silver (SVR) finish only.

⚠ Arms hold monitors from 6.2-18 lbs. Optional counterweight HPACW available to support monitors as low as 5 lbs. (see page 703).

HPADD 19.5 1.3 \$1219

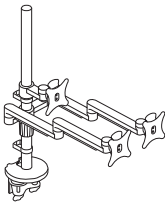

Post Mount with Triple Fixed Arms

- Features two fixed extended arms and one fixed center mount.
- Arms have 360° rotation at base.
- Monitor mount rotates 180° and tilts +/-30°.
- Monitor can be rotated from landscape to portrait position.
- Arms extend up to 20".
- Arms have 27½" of vertical adjustment.

⚠ Available in Silver (SVR) finish only.

⚠ Arms hold monitors from 6.2-18 lbs. Optional counterweight HPACW available to support monitors as low as 5 lbs. (see page 703).

HPATF 22.0 1.9 \$1395

HOW TO SPECIFY

Select Model Number

Select Finish

SVR Silver

HPASD.

SVR



CPU HOLDERS

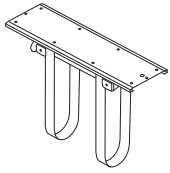

DESCRIPTION

360° Swivel CPU Holder with Adjustable Straps

- Supports CPUs 3¾" wide up to 64" perimeter and holds up to 75 lbs.
- 360° rotation.
- Ships complete and includes necessary mounting hardware and instruction sheet.

ⓘ Available in Black only, no specification needed.

MODEL	SHIP WEIGHT	CUBE	LIST PRICE
HCPU1	7	0.2	\$312

HOW TO SPECIFY



Select Model Number

H C P U 1

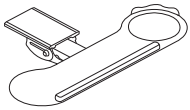

Icon Legend on page 19

KEYBOARD TRAYS

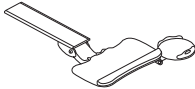
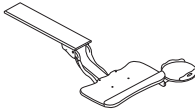
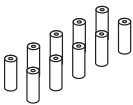
	DESCRIPTION	MODEL	SHIP WEIGHT	CUBE	LIST PRICE
	Short Track and Keyboard Platform <ul style="list-style-type: none"> Height adjustable total of 5$\frac{3}{4}$" (1$\frac{3}{4}$" above and 4" below). +10°, -20° of tilt adjustment. 360° rotation. 	HKTSHORT	10 	0.8	\$722
	Mid Track with Keyboard and Mouse Platform <ul style="list-style-type: none"> Height adjustable total of 8" (3" above and 5" below). +10°, -20° of tilt adjustment. 360° rotation. 	HKT MID	17	1.2	\$664
	Sit to Stand Long Track with Keyboard and Mouse <ul style="list-style-type: none"> Height adjustable total of 12$\frac{1}{2}$" (7$\frac{1}{2}$" above and 5" below). +10°, -20° of tilt adjustment. 360° rotation. 	HKT LONG	17	0.8	\$775
	Keyboard Spacer <ul style="list-style-type: none"> Used when attaching HKT MID or HKT LONG to Coordinate™ and Voi® or Systems Worksurface with an external channel. The kit includes ten cylinder spacers and ten screws. Spacers are $\frac{3}{4}$"W x 2$\frac{1}{8}$"H. Specify one kit per keyboard tray. 	HKBS	1	0.8	\$128

SIN 33721

NOTES:

-  Available in Black only, no specification needed.

HOW TO SPECIFY
 Select
Model Number

H K T M I D

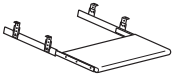
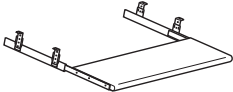

KEYBOARD TRAYS

	DESCRIPTION	MODEL	SHIP WEIGHT	CUBE	LIST PRICE BY LAMINATE GRADE	
					L1	L2
	Laminate Keyboard Platform <ul style="list-style-type: none"> Laminate Tray dimensions: 21½"W x 10"D x 1⅞" Thick. Minimum clearance for mounting: 22⅞"W x 17"D. Surface can be positioned 2", 2½", 3" or 3½" below bottom of worksurface. Will not fit on a 37" x 24" Corner worksurface. 	H4022	10	0.6	\$274	\$290
	Laminate Keyboard Platform with Extended Tray <ul style="list-style-type: none"> Laminate Tray dimensions: 30"W x 10"D x 1⅞" Thick. Minimum clearance for mounting: 32½"W x 17"D. Surface can be positioned 2", 2½", 3" or 3½" below bottom of worksurface. Will not fit on a 37" x 24" Corner worksurface. Ball-bearing slide; slide and brackets are Black. 	HE4022	12	0.7	\$387	\$403

HOW TO SPECIFY

Select Model Number <input type="text" value="H4022"/>	Select Laminate See page 702 <input type="text" value="H"/>
--	--

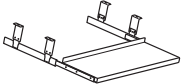
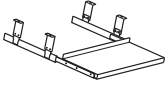
	DESCRIPTION	MODEL	SHIP WEIGHT	CUBE	LIST PRICE BY PAINT GRADE		
					P1	P2	P3
	Metal Keyboard Platforms 30"W Metal Keyboard and Mouse Tray <ul style="list-style-type: none"> Designed to hold keyboards and allow room for mouse pads. Tray dimensions: 30"W x 10"D. Minimum clearance for mounting: 32½"W x 15"D. 	H4028	11	1.5	\$198	\$209	\$217
OPEN MARKET							
	24"W Metal Keyboard Tray <ul style="list-style-type: none"> Designed to hold ONLY keyboards. Tray dimensions: 24"W x 10"D. Minimum clearance for mounting: 26½"W x 15"D. 	H4029	11	1.5	\$179	\$190	\$198
OPEN MARKET							

NOTES:

- Surface is positioned 3" below bottom of worksurface.
- Non-articulating, only movement is front-to-back. Does not tilt or swivel.

HOW TO SPECIFY

Select Model Number <input type="text" value="H4028"/>	Select Paint Color See page 702 <input type="text" value="P"/>
--	---



Icon Legend on page 19

CORNER SLEEVES

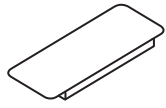

DESCRIPTION

Metal Corner Sleeves

22½"W Leading Edge x 9"D

- Fits 1/8" thick square edge detail.

MODEL	SHIP WEIGHT	CUBE	LIST PRICE BY PAINT GRADE		
			P1	P2	P3
H51204	10	1.5	\$217	\$225	\$232
H51206	10	1.5	\$217	\$228	\$235

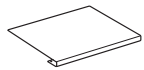

22½"W Leading Edge x 18"D

- Fits 1/8" thick square edge detail.

NOTES:

- Corner sleeve connects intersecting worksurfaces to create "corner desk" work areas.

Edge Detail



HOW TO SPECIFY

Select
Model Number

H 5 1 2 0 4 .

Select
Paint Color

See page 702

P



CENTER DRAWERS



Angled front

DESCRIPTION

Laminate Center Drawer

22"W x 15⁵/₈"D x 2¹/₂"H

- Ball-bearing slide suspension.
- 12" drawer extension (3/4).
- Inside drawer dimension for H1522: 18⁷/₈"W x 15¹/₂"D x 1¹/₂"H.
- Minimum clearance for mounting H1522: 22³/₄"W x 18¹/₂"D compatible with 72"W x 36"D, 66"W x 30"D, 60"W x 30"D Double Pedestal Desks, 72"W x 36"D, 66"W x 30"D Single Pedestal Desks, Bullet and P-Shaped Peninsulas, 72"W x 24"D, 66"W x 24"D, 60"W x 24"D Credenza w/Kneespace, 72"W x 24"D, 66"W x 24"D Single Pedestal Credenzas, 48"W x 24"D, 42"W x 24"D Returns.
- Designed for use with Concinnity™, Voi®, Valido® and 10500 Series™.
- Includes pencil tray.

NOTES: For 60"W x 30"D Modular Desk Shells with two 15⁵/₈"W Storage Pedestals or 60"W x 24"D Modular Credenza Shells with two 15⁵/₈"W Storage Pedestals, use center drawer H1522.

MODEL	SHIP WEIGHT	CUBE	L1 LIST PRICE	L2 LIST PRICE
H1522	11	1.1	\$252	\$268

HOW TO SPECIFY

<p>Select Model Number</p> <p>H 1 5 2 2 . H</p>	<p>Select Laminate</p> <p>See page 702</p> <p>H</p>
--	--



Icon Legend on page 19

CENTER DRAWERS

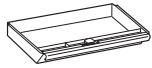

Angled front

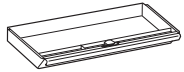

Angled front



DESCRIPTION

Metal Center Drawer w/Lock

- 19"W x 14³/₄"D x 3"H
- Ball-bearing slide suspension.
- 12" drawer extension (3/4).
- Inside drawer dimension: 19"W x 13"D x 2³/₈"H.
- Minimum clearance for mounting: 21³/₄"W x 19¹/₄"D.
- Core removable lock.

24³/₄"W x 14³/₄"D x 3"H

- Ball-bearing slide suspension.
- 12" drawer extension (3/4).
- Inside drawer dimension: 24¹/₂"W x 13"D x 2³/₈"H.
- Minimum clearance for mounting: 27³/₈"W x 19¹/₄"D.
- Core removable lock.

MODEL	SHIP WEIGHT	CUBE	LIST PRICE BY PAINT GRADE	
			P1	P2

HD2	9	1.0	\$377	\$388
------------	---	-----	--------------	--------------

HD8	12	1.2	\$377	\$388
------------	----	-----	--------------	--------------

DESCRIPTION

Polymer Center Drawer

- Material: ABS.
- Minimum clearance for mounting: 23"W x 16¹/₄"D x 2"H.
- Retracts on 16" ball-bearing slides.
- Can be used on worksurfaces with Coordinate™ Height Adjustable Bases as long as it is attached with spacer model HKBS.
- Can store up to 25 lbs.

Black finish only, no specification needed.

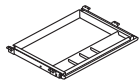

OPEN MARKET

MODEL	SHIP WEIGHT	CUBE	LIST PRICE
-------	-------------	------	------------

HCD1	7	0.5	\$160
-------------	---	-----	--------------

NOTES:

- All metal center drawers feature pencil trays with three compartments for storage.
- All metal center drawers feature core removable locks for greater personal and departmental security.

HOW TO SPECIFY

Select Model Number

Select Paint Color

See page 702

HD2

P



Icon Legend on page 19

DESKTOP RISER



DESCRIPTION

Portable Desktop Riser
31"D x 5"-16½"H x 35"W

NOTES: Available in White (WHT) finish. Desktop riser dimensions (without keyboard tray): 22"D x 5'-16½"H x 35"W. Keyboard tray dimensions: 9"D x 30"W. Max loading capacity is 33 lbs for the desktop riser surface and 4 lbs for the keyboard tray. Easily transition from seated to standing positions throughout the workday. Sits atop an existing desk to create sit-to-stand functionality by raising the computer. Includes keyboard tray and surface for computer monitors. **HON 5-Year Limited Warranty.**

⚠ Not intended for use on mobile workstations.

MODEL SHIP WEIGHT CUBE LIST PRICE

HBXRISER 54 4.1 \$830

HOW TO SPECIFY

Select Model Number

HBXRISER.

Select Finish

WHT White

WHT

CHAIR MATS

	DESCRIPTION	MODEL	SHIP WEIGHT	CUBE	LIST PRICE
	Lipped Chair Mat with Studs 48"W x 36"D	HCM3648LS ☺	8.8	0.6	\$123
	Lipped Chair Mat without Studs 60"W x 46"D 48"W x 36"D	HCM4660LN HCM3648LN ☺	13.2 8.3	0.5 0.3	\$205 \$123

- NOTES:**
- Available with studs for carpet and without studs for hard-surface floors.
 - Ships rolled.
 - **HON 5-Year Limited Warranty.**
- ⓘ Available in Clear finish only, no specification needed.



HOW TO SPECIFY

Select Model Number

H C M 3 6 4 8 L S



TASK LIGHTS

	DESCRIPTION	MODEL	SHIP WEIGHT	CUBE	LIST PRICE
	Articulating Desk Lamp Articulating Desk Lamp w/ Occupancy Sensor <ul style="list-style-type: none"> • Full-range dimming from 10% to 100%. • Designed for 50,000 hours of life. • Occupancy sensor is built into the head of the lamp and will automatically shut the lamp off after 6 minutes of undetected movement. • Base swivel is 180 degrees. • Uses only 5 watts of energy. • Light comes with a silver 9' 4" power cord. • Base diameter is 7.5". • 3500K Color Temperature. • 80 Color Rendering Index. • TAA Compliant. 	HLED1 HLED10C	1.2 1.2	6.5 6.5	\$516 \$627
	<p>! Available in Matte Silver finish only, no specification needed.</p>				
	Task Desk Lamp <ul style="list-style-type: none"> • Full-range dimming from 10% to 100%. • Designed for 50,000 hours of life. • Lamp is 15.83" tall. • Desk lamp does not articulate at base. The pivoting head provides custom positioning, as it can be twisted 360 degrees. • Uses only 5 watts of energy. • Light comes with a silver 9' 4" power cord. • Base diameter is 6.7". • 3500K Color Temperature. • 80 Color Rendering Index. • TAA Compliant. 	HLED2	0.7	3.0	\$448
	<p>! Available in Brushed Nickel finish only, no specification needed.</p>				

HOW TO SPECIFY

Select
Model Number

H L E D 1



TASK LIGHTS

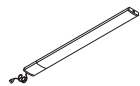

DESCRIPTION	MODEL	SHIP WEIGHT	CUBE	LIST PRICE
LED Task Lights				
17" LED Light with Power Supply (Single)	HLED17AS	1.2	0.05	\$540
31" LED Light with Power Supply (Single)	HLED31AS	1.5	0.09	\$723
17" LED Light with Power Supply for Daisy-chain (Starter)	HLED17A	1.0	0.05	\$591
31" LED Light with Power Supply for Daisy-chain (Starter)	HLED31A	1.4	0.09	\$793
17" LED Light with 8" Jumper Cord for Daisy-chain (Follower)	HLED17AUO	1.0	0.03	\$484
31" LED Light with 8" Jumper Cord for Daisy-chain (Follower)	HLED31AUO	1.0	0.05	\$646
Undercabinet Occupancy Sensor with 1" End to End Connector	HLEDOSA	0.2	0.01	\$118

NOTES: To use the daisy chain application, must start with model HLED17A or HLED31A. No finish specification required. Attaches magnetically to underside of overhead storage, or attaches with provided screws or double-sided tape. Occupancy sensor attaches to a single or starter LED light and will automatically turn the light off after no motion is detected for 30 minutes. Just like all the LED light models, the occupancy sensor features a soft-touch on/off switch. LED task lights have a lifetime of 50,000 hours and have a dimmer feature that allows the user to adjust the amount of light output.



DESCRIPTION	MODEL	SHIP WEIGHT	CUBE	LIST PRICE
Recessed Task Lights				
<ul style="list-style-type: none"> • Color: Black. • Slim profile design. • Mount to stack-on storage and wall mounted storage cabinets. • 9-foot black cord and switch off right rear corner. • Features LED strip. • Lights ordered after October 4, 2021 will feature new LED light strip. 				
18 ³ / ₈ "W x 3 ¹ / ₁₆ "D x 1 ¹ / ₈ "H	HH870924	5.0	0.40	\$293
Chicago code version (with fused plug)	HH870924CH	5.0	0.40	\$370
22 ⁷ / ₈ "W x 3 ¹ / ₁₆ "D x 1 ¹ / ₈ "H	HH870930	7.0	0.60	\$297
Chicago code version (with fused plug)	HH870930CH	7.0	0.60	\$386
34 ⁵ / ₈ "W x 3 ¹ / ₁₆ "D x 1 ¹ / ₈ "H	HH870942	10.0	0.90	\$321
Chicago code version (with fused plug)	HH870942CH	10.0	0.90	\$407
46 ¹ / ₂ "W x 3 ¹ / ₁₆ "D x 1 ¹ / ₈ "H	HH870960	12.0	1.10	\$348
Chicago code version (with fused plug)	HH870960CH	12.0	1.10	\$433

HOW TO SPECIFY

Select
Model Number

H H 8 7 0 9 2 4



PAPER MANAGEMENT & ORGANIZATIONAL TOOLS

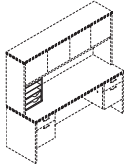

Not available in two-tone laminate

DESCRIPTION	MODEL	SHIP WEIGHT	CUBE	LIST PRICE BY LAMINATE GRADE	
				L1	L2

Vertical Paper Manager
 14⁷/₈"W x 10⁷/₈"D x 19³/₁₆"H
HLVPM1 27 2.8 **\$445** **\$456**

NOTES: Keeps papers, files, and books neatly organized and within easy reach from a seated position. Designed for desk, credenza, and return tops. Fits under stack-on storage models. Two pullout drawers and three fixed shelves. Not available in pattern laminate colors. Ships fully assembled.

⚠ Requires 19³/₄"H minimum of clear space between underside of overhead storage unit and worksurface.
SPECIFYING EXAMPLE: HLVPM1.N

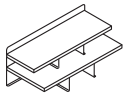

Not available in two-tone laminate



Desktop Storage Terrace
 26¹/₂"W x 12¹/₂"D x 10¹/₂"H
HLDST1 24 1.1 **\$416** **\$427**

NOTES: For use on the tops of 29¹/₂"H desks, credenzas, and returns. Features six storage sections plus top display shelf. Keeps work-in-process, priority files, loose pages, and mail neatly organized and in view. Mixed material design comprised of sturdy laminate shelves with metal back and support panels. Not available in two-tone laminate combination or pattern laminate colors. Choose from Platinum Metallic (T1), Black (P), and Charcoal (S) for the metal components. Sized to fit in stack-on and wall mount storage cabinets in 10500, Valido, Concinnity, 94000, and 38000 Series. Fits in Concinnity and Voi sliding door models, except for 48"W or smaller models. Specify: Model.Laminate.Paint

SPECIFYING EXAMPLE: HLDST1.N.T1

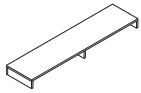

Layering Shelf
 72"W x 14¹/₂"D x 5¹/₂"H **HLSL1472LS** 50 4.6 **\$586** **\$597**
 60"W x 14¹/₂"D x 5¹/₂"H **HLSL1460LS** 39 1.3 **\$492** **\$503**

NOTES: Layering shelf works with lower credenzas to provide additional storage areas.

⚠ Layering Shelves cannot be stacked.
 ⚠ Cannot add a hutch on top of a layering shelf.

HOW TO SPECIFY

Select Model Number HLVP M1 . N	Select Laminate See page 702
---	--

PAPER MANAGEMENT & ORGANIZATIONAL TOOLS

GSA SIN 33721



Icon Legend on page 19

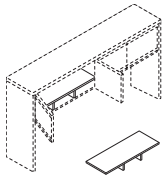

DESCRIPTION

Stacked Paper Management
32½"W x 12½"D x 4¼"H

MODEL SHIP WEIGHT CUBE LIST PRICE

HLVPM2 22 1.25 \$223

NOTES: Segments and organizes stack-on and wall mount storage compartments, as well as bookcase shelves. Unit can be used in Models H105327, H10534, H105322, H105321, H105382 and H105381.

- Available in Black finish only, no specification needed.
- In some cases, installation of Stacked Paper Management may require removing the stack-on or wall mount storage doors.

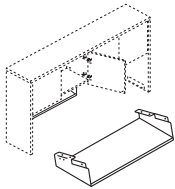

DESCRIPTION

Hanging Paper Shelf
28½"W x 11¼"D x 4¾"H

MODEL SHIP WEIGHT CUBE LIST PRICE BY PAINT GRADE

HHPS1 7 2.9 \$272 \$281 \$293

NOTES: Attaches quickly and easily (screws included). Maximizes worksurface space; de-clutters desktop while placing priority communications and active project folders within easy reach. Angled design allows contents to be distinguished at a glance. Mixed material styling features strong painted metal frame with a frosted shelf.

Attaches quickly and easily to laminate stack-on and wall mount storage models (except the 36"W Voi® overhead hutch with O-legs or panel mount brackets). Not for use with 38000 Series™ and Systems.

Specify: Model.Paint

SPECIFYING EXAMPLE: HHPS1.T1

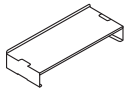

DESCRIPTION

Desktop Paper Shelf
28½"W x 11½"D x 5"H

HDPS1 7 2.9 \$272 \$281 \$293

NOTES: Desktop Paper Shelf and Storage Terrace include protective, non-slip pads on the base. Paper Shelf can stack two-high. Organizer shelf provides a place and space for work-in-process and piling to keep worksurfaces neat and tidy. Convenient, scalable design with interlocking side supports allow two units to be stacked and integrated. Durable painted metal frame with a frosted shelf; mixed material styling matches hanging paper shelf.

Can also be used inside select overhead storage, including the following stack-on with clearance and hinged door models: 10500 and Valido 36", 42", 66", 72", 78"W.

Specify: Model.Paint

SPECIFYING EXAMPLE: HDPS1.T1

HOW TO SPECIFY

Select Model Number

Select Paint Color

See page 702





HHPS1.

P

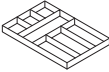
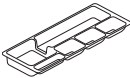
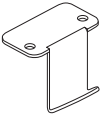

Icon Legend on page 19

PAPER MANAGEMENT & ORGANIZATIONAL TOOLS

	DESCRIPTION	MODEL	SHIP WEIGHT	CUBE	LIST PRICE BY PAINT GRADE		
					P1	P2	P3
	Storage Cube 12"W x 12"D SPECIFYING EXAMPLE: HLSL1212.P8S	HLSL1212	1	0.3	\$400	\$400	\$400
							
	Drawer Organizer 12"W x 14½"D x 1½"H SPECIFYING EXAMPLE: HSLDRWORG.P8F	HSLDRWORG	1	0.5	\$218	\$218	\$218
	DESCRIPTION	MODEL	SHIP WEIGHT	CUBE	LIST PRICE		
	Optional Pencil Tray ⓘ For use with mobile and freestanding pedestal models. ⓘ No specification required.	HV-UT1	0.5	0.1	\$94		
	Back Pack Hook (10 per carton) 12"W x 14½"D x 1½"H NOTES: Assembly: attaches to bottom of desk with (2) screws, included. ⓘ Available in Platinum Metallic finish only, no specification needed.	HCLA65	10.0 ⓘ	0.1	\$119		
OPEN MARKET							
							

HOW TO SPECIFY

Select Model Number HLSL1212	Select Paint Color See page 702 Only specify for models HLSL1212 and HSLDRWORG P8S
---------------------------------	---

PAPER MANAGEMENT & ORGANIZATIONAL TOOLS

GSA SIN 33721 EXCEPT AS NOTED



Icon Legend on page 19

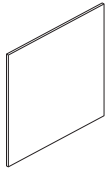

DESCRIPTION

Wall Mount Tackboard

36"W x 35¼"H
30"W x 35¼"H

36"W x 48⅝"H
30"W x 48⅝"H

MODEL

HNL3636TB
HNL3630TB

HNL4936TB
HNL4930TB

SHIP WEIGHT

20
16

27
22

CUBE

2.9
2.9

5.5
3.7

LIST PRICE

\$409
\$348

\$454
\$396

NOTES: When positioned above 29½"H floor-standing storage, the sizes align with overhead storage height options. Can be positioned side-by-side with corresponding wall mount markerboard sizes. Easy to install; includes mounting hardware. Attaches to wall with horizontally mounted, interlocking Z-clip brackets. For the space directly below stack-on and wall mount storage cabinets, use the 18"H tackboard models listed in the Desks section in the 2023 Workspaces Pricer.

SPECIFYING EXAMPLE: HNL3636TB.APN15

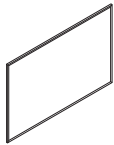

Markerboard

48"W x 31"H

NOTES: Wall mounted.

ⓘ No specification required.

HL4831MB

44

3.4

\$901

OPEN MARKET



HOW TO SPECIFY

Select Model Number

Select Fabric Color

See pages 25-26

H N L 3 6 3 6 T B .

A P N 1 1

INTERLINK IQ ELECTRICAL

Specification guide for IQ Electrical on Training tables

Determine table width, the type of power access being used (3" grommet or 4x8 pop-up) and the desired number per table (Columns 1, 2 or 3). The table will then identify the type and quantity of components needed per table along with the maximum table run. Note that this is in addition to the Power base in-feed which is needed for each run. For example, a 48"W table with two 3" power grommets per table will require (1) HQH5-3 harness and (1) HQH1-3 harness per table with a maximum run of four tables.

Top Width	POWER ONE (1) PER TABLE 3" ROUND POWER GROMMET		POWER TWO (2) PER TABLE 3" ROUND POWER GROMMETS		POWER ONE (1) PER TABLE 4x8 POP-UP PORT	
	Component	Quantity	Component	Quantity	Component	Quantity
36"	(1) HQH5-3	8 Table Run Maximum	N/A	N/A	(1) HQH5-P	8 Max Table Run
42"	(1) HQH5-3	8 Table Run Maximum	N/A	N/A	(1) HQH5-P	8 Max Table Run
48"	(1) HQH5-3	8 Table Run Maximum	(1) HQH5-3 (1) HQH1-3	4 Max Table Run	(1) HQH5-P	8 Max Table Run
54"	(1) HQH5-3	8 Table Run Maximum	(1) HQH5-3 (1) HQH1-3	4 Max Table Run	(1) HQH5-P	8 Max Table Run
60"	(1) HQH5-3	8 Table Run Maximum	(1) HQH5-3 (1) HQH1-3	4 Max Table Run	(1) HQH5-P	8 Max Table Run
66"	(1) HQH5-3 (1) HQTJ3	4 Table Run Maximum	(1) HQH5-3 (1) HQH1-3	4 Max Table Run	(1) HQH5-P (1) HQTJ3	4 Max Table Run
72"	(1) HQH5-3 (1) HQTJ3	4 Table Run Maximum	(1) HQH5-3 (1) HQH1-3	4 Max Table Run	(1) HQH5-P (1) HQTJ3	4 Max Table Run
84"	(1) HQH5-3 (1) HQTJ3	4 Table Run Maximum	(2) HQH5-3	4 Max Table Run	(1) HQH5-P (1) HQTJ3	4 Max Table Run
96"	(1) HQH5-3 (1) HQTJ3	4 Table Run Maximum	(2) HQH5-3	4 Max Table Run	(1) HQH5-P (1) HQTJ3	4 Max Table Run
Half-Round (all sizes)	(1) HQTJ3	2 Tables Maximum	N/A	N/A	(1) HQH5-P	2 Max Table Run
Trapezoid (all sizes)	(1) HQH5-3	8 Table Run Maximum	N/A	N/A	(1) HQH5-P	8 Max Table Run

NOTES:

- Interlink IQ Electrical is a pluggable, single circuit electrical system.
 - All electrical models include wire management clips and hardware.
 - Interlink IQ Electrical is non-sequential/non-directional.
 - Interlink IQ Electrical is UL Recognized as a Powered Table System and meets the requirements of UL 962 when paired with Motivate® or Huddle tables.
- ⓘ 40' maximum run, or no more than 8 units, whichever comes first. Interlink IQ system will automatically shut off if maximum requirements are exceeded. Maximum run is based upon electrical harness width, not table width.

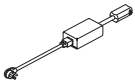
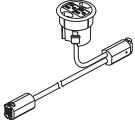
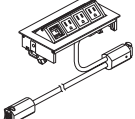
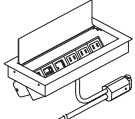
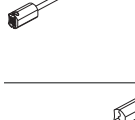
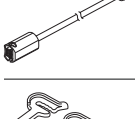
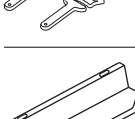
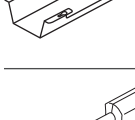
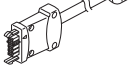
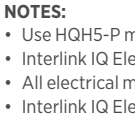
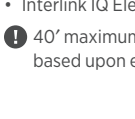

INTERLINK IQ ELECTRICAL

	DESCRIPTION	MODEL	SHIP WEIGHT	CUBE	LIST PRICE
	Power Base In-Feed <ul style="list-style-type: none"> 12 amp circuit breaker is built in to the Power Base In-Feed. Available in Black finish, no specification needed. 	HQB	2.0	0.2	\$676
	Power Harness – 1' Power Hub, 3" Round Grommet Mount <ul style="list-style-type: none"> Available in Black finish, no specification needed. 	HQH1-3	2.0	0.2	\$223
	Power Harness – 5' Power Hub, 3" Round Grommet Mount <ul style="list-style-type: none"> Available in Black finish, no specification needed. 	HQH5-3	2.0	0.2	\$249
	Power Harness – 5' with 4" x 8" Pop-Up Port (3 Power, 1 Blank) <ul style="list-style-type: none"> For use with tables G1 grommet. Specify paint. 	HQH5-P-3P1B	3.0	0.3	\$487
	Power Harness – 5' with 5" x 11" Flip-Top Port (3 Power, 3 Blank) <ul style="list-style-type: none"> For use with Preside® G2 grommet. Specify paint. 	HQH5-E-3P3B	5.0	0.2	\$512
	Power Harness – 5' with 5" x 11" Flip-Top Port (3 Power, 1 Extron Double Space) <ul style="list-style-type: none"> For use with Preside® G2 grommet. Specify paint. 	HQH5-E-3P1E	5.0	0.2	\$540
	Power Harness – 5' with 5" x 11" Flip-Top Port (3 Power, 2 USB A+C, 2 Blank) <ul style="list-style-type: none"> For use with Preside® G2 grommet. Specify paint. 	HQH5-E-3P1U2B	5.0	0.2	\$564
	Power Jumper – 3' <ul style="list-style-type: none"> Available in Black finish, no specification needed. 	HQJ3	2.0	0.2	\$141
	Ganging Hardware <ul style="list-style-type: none"> Includes two ganging links and two screws. No color designator when specifying. <i>Example: HMAGANG.</i> 	HMAGANG	1.0	0.1	\$135
	Cable Management Troughs 17"W – Single 17"W – 10-Pack <ul style="list-style-type: none"> Available in Graphite finish, no specification needed. NOTES: For additional information see page 727.	HCTROUGH17 HCTROUGH1710	2.7 14.0	0.5 0.5	\$94 \$841
	IQ 1.0 Backward Compatible Jumper 36" <ul style="list-style-type: none"> Available in Black finish, no specification needed. Use when connecting Interlink IQ 1.0 power harness (rectangle end) to Interlink IQ 2.0 (oval end) power harness. ! If using Interlink IQ 2.0 in-feed with Interlink IQ 1.0 power harness please contact Customer Support.	HQBCJ36	2.0	0.2	\$107

NOTES:

- Use HQH5-P models with G1 table top cutouts and HQH5-E models with G2 table top cutouts.
- Interlink IQ Electrical is a pluggable, single circuit electrical system.
- All electrical models include wire management clips and hardware.
- Interlink IQ Electrical is non-sequential/non-directional.
- Interlink IQ Electrical is UL Recognized as a Powered Table System and meets the requirements of UL 962 when paired with Motivate® or Huddle tables.
- !** 40' maximum run, or no more than 8 units, whichever comes first. Interlink IQ system will automatically shut off if maximum requirements are exceeded. Maximum run is based upon electrical harness width, not table width.

HOW TO SPECIFY

Select Model Number HQH5-E-3P3B	Select Paint Color FOG Fog SVR Silver BLK Black SVR
---	--

4-TRAC HARDWIRE ELECTRICAL SYSTEM

4-Trac Electrical System

The 4-Trac Electrical System is a UL-recognized Manufactured Wiring System that seamlessly passes power from one worksurface to another. This low-profile non-sequential electrical system allows tables to be “daisy-chained” together in any desired order and allows users to reconfigure quickly due to simple connectable/disconnectable links.

- Meets requirements of UL 183 and National Electric Code Article 604
- 4-Wires, 2-circuits, 20 Amps each (Circuit 1 and Circuit 2 only)
- 13 Duplex Receptacles per circuit, 26, 15 Amp Duplex receptacle per power in-feed
- Electrical system attaches directly to underside of worksurface with included brackets
- Up to twelve tables can be linked together

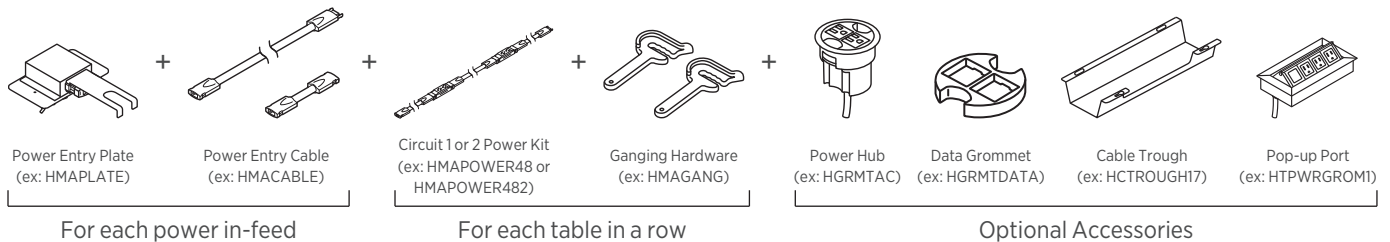



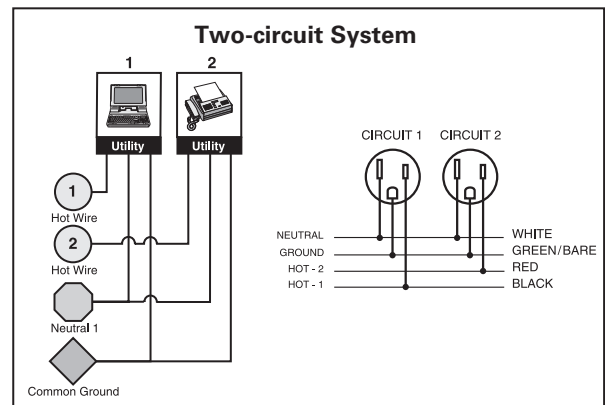
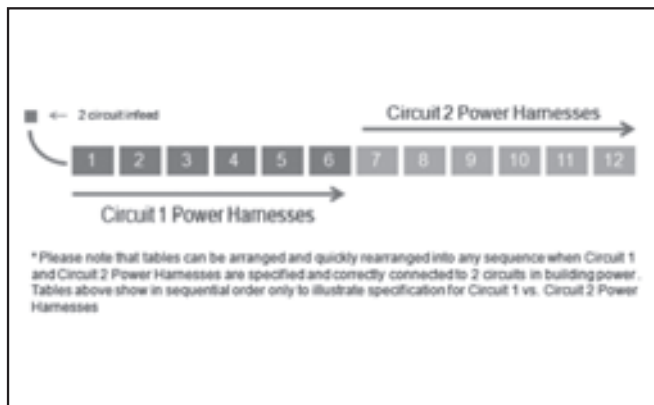

Steps for Electrical Specifications:

- Determine how many rows of tables are needed and order the following:
 - One HMAPLATE per row (or power in-feed)
 - One HMAPOWER48 per row (or power in-feed)
- Order one power harness per table in each row
 - For 1-6 tables in a row (see illustration 1)
 - Order Circuit 1 Power Harnesses (ex. If powering six 24x60 tables order six sets of HMAPOWER60)
 - For 7-12 tables in a row (see illustration 1)
 - Order Circuit 1 Power Harness for first six tables and Circuit 2 Power Harness for remaining tables (ex. If powering eight 24x60 tables, order six sets of HMAPOWER60 and two sets of HMAPOWER602)
- Order one set of ganging hardware per table (ex. HMAGANG)
- Determine which accessories are needed:
 - Power Hub model HGRMTAC — to access power at worksurface.
 - Data Grommet model HGRMTDATA — to access data at worksurface.
 - Wire Management strips model HBTMS — for vertical and horizontal wire management.

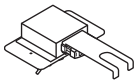
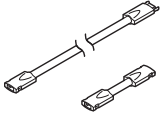
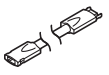

4-TRAC HARDWIRE ELECTRICAL SYSTEM

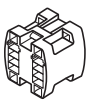
Icon Legend on page 19

	DESCRIPTION	MODEL	SHIP WEIGHT	CUBE	LIST PRICE
	Power Entry Plate	HMAPLATE	1.0	0.2	\$135
	Power Entry Cable • 6' power entry cable with male/female adapter. • Connects table to power entry plate.	HMACABLE	1.8	0.2	\$210
	Power Jumper Cable To connect tables front to front	HMAJUMP	0.5	0.3	\$72
	Circuit 1 Power Kit for 36" W Table	HMAPOWER36	1.5	0.3	\$380
	Circuit 1 Power Kit for 42" W Table	HMAPOWER42	1.8	0.3	\$386
	Circuit 1 Power Kit for 48" W Table	HMAPOWER48	1.8	0.3	\$388
	Circuit 1 Power Kit for 54" W Table	HMAPOWER54	2.0	0.3	\$394
	Circuit 1 Power Kit for 60" W Table	HMAPOWER60	2.0	0.3	\$397
	Circuit 1 Power Kit for 66" W Table	HMAPOWER66	2.2	0.3	\$404
	Circuit 1 Power Kit for 72" W Table	HMAPOWER72	2.2	0.3	\$407
	Circuit 1 Power Kit for 84" W Table	HMAPOWER84	2.4	0.3	\$422
	Circuit 1 Power Kit for 96" W Table	HMAPOWER96	2.6	0.3	\$436
	Circuit 2 Power Kit for 36" W Table	HMAPOWER362	1.5	0.3	\$380
	Circuit 2 Power Kit for 42" W Table	HMAPOWER422	1.8	0.3	\$386
	Circuit 2 Power Kit for 48" W Table	HMAPOWER482	1.8	0.3	\$388
	Circuit 2 Power Kit for 54" W Table	HMAPOWER542	2.0	0.3	\$394
	Circuit 2 Power Kit for 60" W Table	HMAPOWER602	2.0	0.3	\$397
	Circuit 2 Power Kit for 66" W Table	HMAPOWER662	2.2	0.3	\$404
	Circuit 2 Power Kit for 72" W Table	HMAPOWER722	2.2	0.3	\$407
	Circuit 2 Power Kit for 84" W Table	HMAPOWER842	2.4	0.3	\$422
	Circuit 2 Power Kit for 96" W Table	HMAPOWER962	2.6	0.3	\$436
	Electrical Connectors 4-Way Splitter  Available in Black (P) only. SPECIFYING EXAMPLE: HMASPLIT.P	HMASPLIT	0.9	0.1	\$67

NOTES:







- Each power kit includes two duplex receptacles and attaches to the underside of the worksurface with included brackets.
- Power Kits are compatible with various base types including nesting bases.
- Available in Black finish, no specification needed.

HOW TO SPECIFY

Select
Model Number

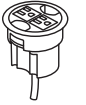
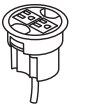
HMAPLATE

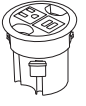
POWER & CABLE MANAGEMENT

	DESCRIPTION	MODEL	SHIP WEIGHT	CUBE	LIST PRICE
 <p>Black only SIN 33721</p>	<p>Black Field Installable Grommet with One Access Hole</p> <ul style="list-style-type: none"> Intended for use in tops and end panels to route/hide cords and facilitate reaching wall electrical outlets. Requires a 2½" diameter hole saw and drill for installation (not included). Grommet cap measures 3" diameter and includes a ¾" diameter cord access hole. Grommet sleeve measures 2½" O.D. x ¾" thick. Includes instructions to locate grommet position for desks, credenzas, returns and bridges. <p>! The grommet is not designed to be used with the following HON Series: 94000, 38000, Metro Classic or 34000.</p>	HFLDGRMT	0.1 Ⓢ	0.01	\$45
 <p>SIN 33721</p>	<p>Black Field Installable Grommet with Two Access Holes</p> <ul style="list-style-type: none"> Requires a 3" diameter hole saw and drill for installation (not included). Grommet outside dimensions measures 3½" diameter. Grommet sleeve measures 3" O.D. x 1" thick. Includes instructions to locate grommet position for desks, credenzas, returns and bridges. 	HFLDGRMT3	0.1 Ⓢ	0.3	\$45
 <p>OPEN MARKET</p>	<p>Platinum Field Installable Grommet with Two Access Holes</p> <ul style="list-style-type: none"> Requires a 3" diameter hole saw and drill for installation (not included). Outside dimension measures 3½" diameter. Sleeve hole in worksurface measures 3" O.D. x 1" thick. Includes instructions to locate grommet position for desks, credenzas, returns, and bridges. 	HFLDGRMT4	0.1	0.01	\$45
 <p>SIN 33721T</p>	<p>Power Hub, 3" Grommet Mount, 6' Cord</p> <ul style="list-style-type: none"> Fits in 3" round grommet holes. Two grounded AC power outlets. Includes 6' cord with three-prong plug. Field installed with Plug-and-play ease. <p>! Available in black only (no color designation so use .X - Specify: HGRMTAC.X).</p>	HGRMTAC	1.3	0.2	\$167
 <p>SIN 33721T</p> <p></p>	<p>3" Round Power Grommet - 2 Outlets, 10' Cord</p> <ul style="list-style-type: none"> Includes 10' cord with three-prong plug. Fits in 3" round grommet holes. Two grounded AC power outlets. Field installed with Plug-and-play ease. <p>NOTES: Power Modules will also work with standing-height applications for 10500 Series™ and Voi® desks. Optional Memory Control allows preset worksurface heights for consistency. Ships separately. Dynamic load capacity when worksurface is moving is 300 lbs.</p> <p>! Available in black finish only, no specification needed.</p>	HGRMTAC2	1.5	0.2	\$196
 <p>SIN 33721T</p>	<p>Power/USB Hub, 3" Grommet Mount</p> <ul style="list-style-type: none"> One grounded AC power outlet with 2 USB ports. UL Listed. <p>! Available in black only (no color designation so use .X - Specify: HGRMTUSB2.X).</p> <p>! Not compatible with Arrange® tables.</p>	HGRMTUSB2	1.3 Ⓢ	0.2	\$300
 <p>SIN 33721</p>	<p>Data Grommet</p> <p>Blank grommet kit that includes adapters for a variety of manufacturers jacks and couplers.</p> <ul style="list-style-type: none"> Fits in existing 3" round grommet housing. <p>! Available in black only. Specify P when ordering. Example: HGRMTDATA.P.</p>	HGRMTDATA	0.2	0.2	\$32

HOW TO SPECIFY

Select
Model Number

H F L D G R M T



Icon Legend on page 19

POWER

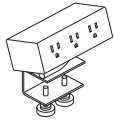

Model HPWRMOD3WC shown

DESCRIPTION

Dean Power Modules with Worksurface Clamp

- 3 Receptacles
- 2 Receptacles, 2 USB
- 2 Receptacles, 1 USB with Qi Wireless Charging Top
- 6' power cord with standard three-prong plug.
- Worksurface clamp models work on any top with a 4" overhang.
- UL Listed.

MODEL

- HPWRMOD3WC
- HPWRMOD2WC
- HPWRMOD4WC

SHIP WEIGHT

- 2.3
- 2.3
- 2.3

CUBE

- 0.2
- 0.2
- 0.2

LIST PRICE

- \$409
- \$652
- \$885

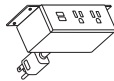

Model HPWRMOD2UWM shown

Dean Power Modules with Under-Worksurface Mounting Bracket

- 3 Receptacles
- 2 Receptacles, 2 USB
- 6' power cord with standard three-prong plug.
- Under-worksurface mounting bracket models work with any top that has a 5" x 5" square clearance.
- UL Listed.

- HPWRMOD3UWM
- HPWRMOD2UWM

- 2.3
- 2.3

- 0.2
- 0.2

- \$409
- \$652

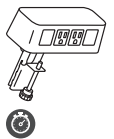

Power & Data Center

- 2 Receptacles 2 Data Accessory
- Standard with two receptacles and openings for two data ports.
- 6' power cord with standard three-prong plug.
- Fits on any worksurface with a 4" overhang.
- UL Listed.

HCOMDOME2

2.5

0.2

\$391

Color finish coordinates with HON's Loft. Specify LOFT when ordering. Example: HCOMDOME2.LOFT.

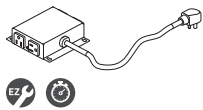

Under Worksurface Power Module — 4 Outlets, 10' Cord

- Includes 10' cord with three-prong plug.
- Fits in cable management troughs. See page 727.
- 4 outlets on side create easy access.

HPWRMOD2

1.5

0.2

\$528

NOTES: Power Modules will also work with standing-height applications for 10500 Series™ and Voi® desks.

Available in black finish only, no specification needed.

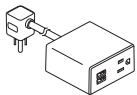

Miki Surface Sit Power Module

- Includes 6' cord with three-prong plug.
- 1 Receptacle, 2 USB
- Unit features non-slip grip on underside.

HSMPWR-1P-2U

2.0

0.6

\$200

OPEN MARKET

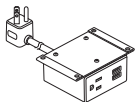

Miki Under-Worksurface Power Module

- Includes 6' cord with three-prong plug.
- 1 Receptacle, 2 USB

HUMPWR-1P-2U

2.0

0.6

\$230

OPEN MARKET



Vesta Mobile Power Station

- Includes 10' retractable cord with three-prong plug.
- 3 AC, 1 Dual USB-A, 1 USB-C at top
- 2 AC at base
- Specify Paint and Plastic.

HPWRMOB1

14.0

3.3

\$1317

SPECIFYING EXAMPLE: HPWRMOB1.BLK.STRM

OPEN MARKET

HOW TO SPECIFY

Select Model Number

HSMPWR-1P-2U

Select Plastic

Specify for Dean and Miki models

- STRM Storm
- SNW Snow

SNW

Select Model Number

HPWRMOB1

Select Exterior Paint Color

Specify for model HPWRMOB1 only

- FOG Fog
- STRM Storm
- BLK Black
- SNW Snow

BLK

Select Paint Color

Specify for model HPWRMOB1 only

- FOG Fog
- STRM Storm
- BLK Black
- SNW Snow

STRM

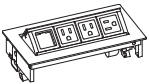
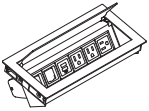
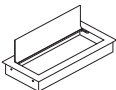

	DESCRIPTION	MODEL	SHIP WEIGHT	CUBE	LIST PRICE
	<p>MhoB 4" x 8" Pop-up Port</p> <ul style="list-style-type: none"> Specify G1 cutout in table top. Pop-up Port provides three power ports and one blank data receptacle. Sits flush with worksurface when closed. Includes 6' cord with three-prong plug. 	HTG1PWR-3P-1B	5	0.3	\$507
	<p>ElloaB 5" x 11" Flip-top Port</p> <ul style="list-style-type: none"> Specify G2 cutout in table top. Flip-top Port provides four power ports and two blank data receptacles. Conceals wires and allows power cords to be plugged in while in use. Includes 10' cord with three-prong circuit breaker plug. <p>NOTES: Two circuit breaker plugs do not fit into one duplex.</p>	HTG2PWR-4P-2B	5	0.3	\$747
	<p>ElloaB 5" x 11" Flip-top Port</p> <ul style="list-style-type: none"> Specify G2 cutout in table top. Flip-top Port provides one blank for Extron plate (HTPLATEVHAU) and three power ports. Extron AAP plates can be integrated into grommet to support changing technology. Conceals wires and allows power cords to be plugged in while in use. Includes 10' cord with three-prong plug. 	HTG2PWR-3P-1E	5	0.3	\$914
	<p>ElloaB 5" x 11" Flip-top Port</p> <ul style="list-style-type: none"> Specify G2 cutout in table top. Flip-top Port provides 3 Power, 1 USB A+C, and 2 Blank Data Ports. Conceals wires and allows power cords to be plugged in while in use. Includes 10' cord with three-prong plug. 	HTG2PWR-3P-2B-2U	5	0.3	\$1084
	<p>ElloaB 5" x 11" Flip-top Port</p> <ul style="list-style-type: none"> Specify G2 cutout in table top. Flip-top Port provides 3 Power, 1 USB A+C, and Qi wireless charging lid. Conceals wires and allows power cords to be plugged in while in use. Includes 10' cord with three-prong plug. 	HTG2PWR-3P-1U-W	5	0.3	\$1109
	Blank G1 Cutout Insert	HGROM1BLANK	2	0.2	\$195
	Blank G2 Cutout Insert	HGROM2BLANK	2	0.2	\$298
	! Grommets available in BLK, FOG, and SVR only.				

HOW TO SPECIFY

<p>Select Model Number</p> <p>H T G 2 P W R - 4 P - 2 B .</p>	<p>Select Paint Color</p> <p>SVR Silver BLK Black FOG Fog</p> <p>B L K</p>
--	--

POWER

OPEN MARKET



Icon Legend on page 19

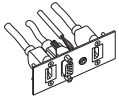

DESCRIPTION

Extron Plate (Double Space) — VGA, HDMI, HDMI, Audio

MODEL

HTPLATEVHAU

SHIP WEIGHT

1

CUBE

0.1

LIST PRICE

\$511

NOTES:

• 1 Double Space Plate can be used with HTG2PWR-3P-1E or HTPWRGROM4 Flip-top Port.

! Available in Black finish only, no specification needed.

WORKPLACE TOOLS

HOW TO SPECIFY

Select
Model Number

HTPLATEVHAU



Icon Legend on page 19

POWER & CABLE MANAGEMENT

	DESCRIPTION	MODEL	SHIP WEIGHT	CUBE	LIST PRICE
	Cable Management Troughs				
	17"W — Single	HCTROUGH17	2.7 Ⓔ	0.5	\$94
	17"W — 10-Pack	HCTROUGH1710	14.0 Ⓔ	0.5	\$841
	36"W — Single	HCTROUGH36	4.9 Ⓔ	0.9	\$155
	36"W — 10-Pack	HCTROUGH3610	30.0 Ⓔ	0.9	\$1415
	<ul style="list-style-type: none"> • Cable management troughs ship flat packed. • The troughs attach to underneath the worksurface with screws. • Cutouts in trough allow access to power without the need to detach from surface. 17"W = 1 cutout; 36"W = 2 cutouts. • Color: Graphite. • Material: Metal. • TAA Compliant. 				
 <p>OPEN MARKET</p>	O-Leg Cord Clips				
	Clips for 28½" Worksurface O-Legs — 8-Pack	HWMCLIPLG	0.8 Ⓔ	0.1	\$133
	Clips for Stack-on Storage, Hutch and Layering O-Legs — 4-Pack	HWMCLIPSM	0.5 Ⓔ	0.1	\$88
	<p>NOTES: Wire clips work with 7" Low Credenza O-leg and 29"H Support O-leg. Wire clips also work with the 50" and 65" Overhead O-leg supports.</p> <p>⚠ Available in frosted plastic material only.</p>				
 <p><i>Black only</i></p>	Cable Management Tray				
	24"	HJTRGH24	2.0 Ⓔ	0.3	\$99
	36"	HJTRGH36	3.0 Ⓔ	0.4	\$121
	⚠ Available in Black only.				
	Vertical Wire Management Vertebrae	HMPVWM28	3.0	0.3	\$294
	<p>NOTES: 30"H x 3¼"W x 1½"D. Ships unassembled.</p> <p>⚠ Clear finish. Specify "X" for finish option.</p> <p>SPECIFYING EXAMPLE: HMPVWM28.X</p>				

HOW TO SPECIFY

<p>Select Model Number</p> <p>H J T R G H 2 4</p>	<p>Select Paint Color</p> <p>P Black</p> <p>P</p>
--	--

CROSS REFERENCE INDEX

MODEL	PAGE	MODEL	PAGE	MODEL	PAGE	MODEL	PAGE
H10501	271	H105322	284	H105520	298	H105818L	292
H105012	271	H105322G	285	H105524	298	H10583R	278
H105014	272	H105322K	284	H105525R	298	H10584L	278
H10502	271	H105323	284	H105526L	298	H105851	165, 287
H10503	273	H105323G	285	H105527R	298	H105852	165, 287
H10504	272	H105323K	284	H105528L	298	H105853	165, 287
H10505	273	H105324	284	H105531	294	H105854	165, 287
H105062	271	H105324G	285	H105532	298	H105855	165, 287
H105064	272	H105324K	284	H105533	298	H105856	165, 287
H105076	273	H105327	284	H105534	298	H105857	165, 287
H105077	273	H105327G	285	H105535	298	H10585R	278
H10508	273	H105327K	284	H105581	257	H10586L	278
H105093	271	H10533	284	H105581X	257	H10587R	278
H105098	152, 257	H10533G	285	H105582	257	H105885R	278
H105099	152, 257	H10533K	284	H105582X	257	H10588L	278
H1050CST	670	H10534	284	H105583	257	H105890	274
H105102	293	H105349	164, 285	H105583X	257	H105891	274
H105104	293	H10534G	285	H105598	282	H105892	274
H105106	293	H10534K	284	H105599	282	H105893R	274
H105109	293	H10536	283	H10560	282	H105894L	274
H10511R	278	H105360	291	H10561	260	H105895R	274
H10512L	278	H105361	291	H10561X	260	H105896L	274
H10515R	278	H105362	291	H10563	293	H105897R	274
H10516	293	H105363	291	H10564	257	H105898L	274
H10516L	278	H105367	283	H10564X	257	H105899	274
H10517	293	H105368	283	H10565	279	H105900	275
H105201RE	280	H10537	283	H10566	279	H105901	275
H105202LE	280	H105380	288	H105663	259	H105902	275
H105203RE	280	H105380G	291	H105679	155, 273	H105903R	275
H105204LE	280	H105380K	288	H10568	260	H105904L	275
H105205RE	281	H105381	288	H10568X	260	H105905R	275
H105206LE	281	H105381G	291	H105680	260	H105906L	275
H105209E	280	H105381K	288	H105680X	260	H105907R	275
H10521E	280	H105382	288	H105681	260	H105908L	275
H10522E	280	H105382G	291	H105681X	260	H105909	275
H10523E	280	H105382K	288	H105684	260	H10592	256
H10524	272	H105383	288	H105684X	260	H10592X	256
H1052441LEP	262	H105383G	291	H105686	260	H10593	278
H10524LEP	262	H105383K	288	H105686X	260	H10594	256
H10524TEP	262	H105388	283	H105690	293	H10594X	256
H10524TSUPP	262	H105392	259	H105691	257	H10595	278
H10525RE	280	H105393	259	H105691X	257	H10596	256
H10526LE	280	H105397	259	H105692	257	H10596X	256
H10528	161, 281	H10541	257	H105692X	257	H105973R	275
H105290	294	H105410	258	H105698	282	H105974L	275
H105291	294	H105410X	258	H105699	282	H105975R	275
H105292	294	H105411	258	H10570	282	H105976L	275
H105293	297	H105411X	258	H10571	278	H10598	256
H105295R	297	H105412	258	H105720	299	H10598X	256
H105296L	297	H105412X	258	H105721	170, 299	H105B2460	261
H105297R	297	H105413	258	H105722	170, 299	H105B3060	261
H105298L	297	H105413X	258	H105724	299	H105B3066	261
H105299	297	H10541X	257	H105726	299	H105B3072	261
H10530	297	H10542	257	H105729	299	H105CT3020	277
H105301R	297	H10542X	257	H10573	278	H105CT3024	277
H105302L	297	H10543	279	H10578	256	H105CT3620	277
H1053041LEP	262	H10544	279	H10578X	256	H105CT3624	277
H10530LEP	262	H10545R	279	H10579	256	H105CTHAT3020	277
H10530TEP	262	H10546L	279	H10579X	256	H105CTHAT3024	277
H105310	294	H10547R	282	H105810	292	H105CTHAT3620L	277
H105319	286	H10548L	282	H105811	292	H105CTHAT3620R	277
H105321	284	H105491	282	H105815R	292	H105CTHAT3624L	277
H105321G	285	H105492	282	H105816L	292	H105CTHAT3624R	277
H105321K	284	H105493	282	H105817R	292	H105CTHAT6020L	277

CROSS REFERENCE INDEX

MODEL	PAGE	MODEL	PAGE	MODEL	PAGE	MODEL	PAGE
H105CTHAT6020R	277	H105R3048	261, 267	H115290	167	H11555	169
H105CTHAT6024L	277	H105R3060	261, 267	H115291	167	H115581	152
H105CTHAT6024R	277	H105R3066	261, 267	H115292	167	H115581X	152
H105CTHAT6620L	277	H105R3072	261, 267	H115293	168	H115582	152
H105CTHAT6620R	277	H105R3078	261	H115295R	168	H115582X	152
H105CTHAT6624L	277	H105R3084	261	H115296L	168	H115583	152
H105CTHAT6624R	277	H105ST122450L	294	H115297R	168	H115583X	152
H105CTHAT7220L	277	H105ST122450R	294	H115298L	168	H115598	162
H105CTHAT7220R	277	H105ST123050L	294	H115299	168	H115599	162
H105CTHAT7224L	277	H105ST123050R	294	H11530	168	H11560	162
H105CTHAT7224R	277	H105WMH30	289	H115301R	168	H11561	153
H105HLEG2428	264	H105WMH30C	289	H115302L	168	H11561X	153
H105HLEG2441	264	H105WMH36	289	H115321	163	H11563	167
H105HLEG3028	264	H105WMH36C	289	H115321G	164	H11564	152
H105HLEG3041	264	H105WMH42	289	H115321K	163	H11564X	152
H105LC3020BF	276	H105WMH42C	289	H115322	163	H11565	159
H105LC3020SF	276	H105WMH48	289	H115322G	164	H11566	159
H105LC3024BF	276	H105WMH48C	289	H115322K	163	H11568	153
H105LC3024SF	276	H105WMH48P	289	H115323	163	H115680	153
H105LC3620BF	276	H105WMH48PC	289	H115323G	164	H115680X	153
H105LC3620SF	276	H105WMH48PCG	290	H115323K	163	H115681	153
H105LC3624BF	276	H105WMH48PG	290	H115324	163	H115681X	153
H105LC3624SF	276	H105WMH60P	289	H115324G	164	H115684	153
H105LCHAT3020B	276	H105WMH60PC	289	H115324K	163	H115684X	153
H105LCHAT3020S	276	H105WMH60PCG	290	H115327	163	H115686	153
H105LCHAT3024S	276	H105WMH60PG	290	H115327G	164	H115686X	153
H105LCHAT3620B	276	H105WMH66	289	H115327K	163	H11568X	153
H105LCHAT3620S	276	H105WMH66C	289	H11533	163	H115690	167
H105LCHAT3624S	276	H105WMH66P	289	H11533G	164	H115691	152
H105LT182050BFL	295	H105WMH66PC	289	H11533K	163	H115691X	152
H105LT182050BFR	295	H105WMH66PCG	290	H11534	163	H115692	152
H105LT182050CBFL	295	H105WMH66PG	290	H11534G	164	H115692X	152
H105LT182050CBFR	295	H105WMH72P	289	H11534K	163	H115698	162
H105LT182050SBFL	295	H105WMH72PC	289	H115380	165	H115699	162
H105LT182050SBFR	295	H105WMH72PCG	290	H115380K	165	H11570	162
H105LT182450BFL	295	H105WMH72PG	290	H115381	165	H11571	158
H105LT182450BFR	295	H11501	154	H115381K	165	H115720	170
H105LT182450CBFL	295	H115012	154	H115382	165	H115724	170
H105LT182450CBFR	295	H115014	154	H115382K	165	H115726	170
H105LT182450SBFL	295	H11502	154	H115383	165	H11573	158
H105LT182450SBFR	295	H11503	155	H115383K	165	H11578	151
H105LT182450SCBFL	296	H11504	154	H11541	152	H11579	151
H105LT182450SCBFR	296	H11505	155	H11541X	152	H115811	166
H105LT242050BFL	295	H11508	155	H11542	152	H115815R	166
H105LT242050BFR	295	H115093	154	H11542X	152	H115816L	166
H105LT242050CBFL	295	H115102	167	H11543	159	H11583R	158
H105LT242050CBFR	295	H115104	167	H11544	159	H11584L	158
H105LT242050SBFL	295	H115106	167	H11545R	159	H11585R	158
H105LT242050SBFR	295	H115109	167	H11546L	159	H11586L	158
H105LT242450BFL	295	H11511R	158	H11547R	162	H11587R	158
H105LT242450BFR	295	H11512L	158	H11548L	162	H115885R	158
H105LT242450CBFL	295	H11515R	158	H115491	162	H11588L	158
H105LT242450CBFR	295	H11516	167	H115492	162	H115890	156
H105LT242450SBFL	295	H11516L	158	H115493	162	H115891	156
H105LT242450SBFR	295	H11517	167	H11552	169	H115892	156
H105R2430	261	H115201RE	160	H115520	169	H115893R	156
H105R2436	261	H115202LE	160	H115523	169	H115894L	156
H105R2442	261, 267	H115203RE	160	H115524	169	H115895R	156
H105R2448	261, 267	H115204LE	160	H115525R	169	H115896L	156
H105R2460	261, 267	H11521E	160	H115526L	169	H115897R	156
H105R2466	261, 267	H11522E	160	H115527R	169	H115898L	156
H105R2472	261, 267	H11523E	160	H115528L	169	H115899	156
H105R2478	261	H11525RE	160	H11553	169	H115900	157
H105R2484	261	H11526LE	160	H11554	169	H115901	157

CROSS REFERENCE INDEX

MODEL	PAGE	MODEL	PAGE	MODEL	PAGE	MODEL	PAGE
H115902	157	H36720(?)	573	H511596	580	H90055	69, 73, 165, 287
H115903R	157	H36723(?)	573	H512	666	H90056	69, 73, 165, 287
H115904L	157	H36820(?)	573	H51204	708	H90057	69, 73, 165, 287
H115905R	157	H36823(?)	573	H51206	708	H9170(?)	629
H115906L	157	H38155	351	H512C	666	H9173(?)	629
H115907R	157	H38170	351	H514	666	H9174(?)	629
H115908L	157	H38180	351	H514C	666	H9175(?)	629
H115909	157	H38210	353	H519495	341, 344, 670	H9180(?)	629
H11592	151	H38215R	351	H52	635	H9183(?)	629
H11593	158	H38216L	351	H52C	635	H9184(?)	629
H11594	151	H38217R	351	H54	635	H9185(?)	629
H11595	158	H38218L	351	H54C	635	H9185LS(?)	630
H11596	151	H38220	353	H672	578	H9185LSN(?)	630
H11598	151	H38251	351	H673	578	H9190(?)	629
H14917(?)	627	H38252L	351	H674	578	H9193(?)	629
H14923(?)	627	H38291R	351	H675	578	H9194(?)	629
H1522	112, 337, 709	H38292L	351	H682	578	H919430	595, 596, 667
H15923(?)	628	H38293R	351	H683	578	H919436	595, 596, 667
H1801	674	H38294L	351	H684	578	H919442	667
H1871	674	H384815	354	H685	578	H919448	595, 596
H18717(?)	627	H386015	354	H692	578	H919460	595, 596, 667
H1872	674	H386548N	341, 354	H693	578	H919466	667
H18723(?)	627	H386560N	341, 354	H694	578	H919472	595, 596, 667
H18730(?)	627	H386566N	341, 354	H695	578	H919491	667
H1874	674	H386572N	354	H772	576	H919492	667
H1875	674	H386615	354	H773	576	H919493	667
H1876	674	H387215	354	H774	576	H9195(?)	629
H1877	674	H38851	351	H775	576	H94210	336
H18817(?)	627	H38852	351	H775LS	577	H94211R	332
H18823(?)	627	H38853	351	H782	576	H94212L	332
H18830(?)	627	H38854	351	H783	576	H94215R	332
H19717(?)	627	H38855L	351	H784	576	H94216L	332
H19723(?)	627	H38856R	351	H785	576	H94220	336
H19730(?)	627	H38857L	351	H785LS	577	H94221	336
H19817(?)	627	H38858R	351	H792	576	H94222	336
H19823(?)	627	H38921	352	H793	576	H94223	336
H19830(?)	627	H38922	352	H794	576	H94224	336
H20040AG	670	H38923	352	H795	576	H94225	336
H212	664	H38925	352	H795LS	577	H94226	336
H212C	664	H38928	353	H80191	301	H94229	336
H214	664	H38931	352	H80192	301	H94234	334
H214C	664	H38932	352	H80193	301	H94234K	334
H215	664	H38933	352	H872	574	H94237	334
H215C	664	H38934	352	H873	574	H94237K	334
H312	665	H38935	352	H874	574	H94243	333
H312C	665	H38941E	353	H875	574	H94244	333
H314	665	H38942E	353	H875LS	575	H94245R	333
H314C	665	H38943R	352	H882	574	H94246L	333
H315	665	H38944L	352	H883	574	H94247R	333
H315C	665	H38945R	352	H884	574	H94248L	333
H32	635	H38946L	352	H885	574	H94251	332
H33720(?)	573	H38947R	352	H885LS	575	H94260	333
H33723(?)	573	H38948L	352	H892	574	H94270	333
H33820(?)	573	H38949R	352	H893	574	H94271	332
H33823(?)	573	H38950L	352	H894	574	H94276	332
H34	635	H38966E	353	H895	574	H94283R	332
H34002R	344	H38SHFDV	355, 532	H895LS	575	H94284L	332
H34251	344	H4022	707	H90034	335	H94285R	332
H34480	344	H4028	707	H90035	335	H94286L	332
H34834R	344	H4029	707	H90050	69, 73, 287	H94291	336
H34835L	344	H432	661	H90051	69, 73, 165, 287	H94430	336
H34962	344	H434	661	H90052	69, 73, 165, 287	H94435	336
H34973R	344	H482	661	H90053	69, 73, 165, 287	H94720	337
H34974L	344	H484	661	H90054	69, 73, 165, 287	H94721R	337

CROSS REFERENCE INDEX

MODEL	PAGE	MODEL	PAGE	MODEL	PAGE	MODEL	PAGE
H94722L	337	HBCKKIT24	552	HBV-P4272	565	HE4022	707
HAECBH	646	HBCKKIT24F	552	HBV-P6024	565	HEABAC	432
HAEHF	646	HBCKKIT30	552	HBV-P6030	565	HEBPLATE336	425, 534
HAELT	646	HBCKKIT30F	552	HBV-P6036	565	HEBPLATE342	425, 534
HAESC19	644	HBCKKIT36	552	HBV-P6042	565	HEBPLATE348	425, 534
HAESS	646	HBCKKIT36F	552	HBV-P6048	565	HEBPLATE360	425, 534
HAEST	646	HBCKIT24	552	HBV-P6060	565	HEBPLATE372	425, 534
HAPGBPI96NP	642	HBCKIT24F	552	HBV-P6072	565	HEC35P2N	429
HAPGBPI96NPTE	643	HBCKIT30	552	HBV-P7224	565	HEC35P3N	429
HAPGBPI99TFN	642	HBCKIT30F	552	HBV-P7230	565	HEC35PLN	429
HAPGBPI99TFNE	643	HBCKIT36	552	HBV-P7236	565	HEC35PSN	429
HAPGBPI99SNPT	642	HBCKIT36F	552	HBV-P7242	565	HEC35PTN	429
HAPGBPI99SNPTE	643	HBCKIT42	552	HBV-P7248	565	HEC35PXN	429
HAPGBP236NP	642	HBCKIT42F	552	HBV-P7260	565	HEC42P2N	429
HAPGBP236NPTE	643	HBCKIT48	552	HBV-PBS	566	HEC42P3N	429
HAPGBP239TFN	642	HBCKIT48F	552	HBV-PWB1	566	HEC42PLN	429
HAPGBP239TFNE	643	HBCKIT60	552	HBV-QC180	566	HEC42PSN	429
HAPGBS239TFN	642	HBCKIT60F	552	HBV-QC90	566	HEC42PTN	429
HAPGBS239TFNE	643	HBCKIT66	552	HBV-TBASE	566	HEC42PXN	429
HAPGBS239SNPT	642	HBCKIT66F	552	HBV-VSH24	566	HEC50P2N	429
HAPGBS239SNPTE	643	HBCKIT72	552	HBV-VSH30	566	HEC50P3N	429
HAPGCP199TPN	642	HBCKIT72F	552	HBV-VSH36	566	HEC50PLN	429
HAPGCP199TPNE	643	HBCONU	507	HBV-VSH42	566	HEC50PSN	429
HAPGCP239TPN	642	HBCSR1524P	551	HBV-VSH48	566	HEC50PTN	429
HAPGCP239TPNE	643	HBCSR1530P	551	HBV-VSH60	566	HEC50PXN	429
HAPGCS239TPN	642	HBCSR1536P	551	HBVWM	508	HEC57P2N	429
HAPGCS239TPNE	643	HBCSR1542P	551	HBWCT3624P	454, 546	HEC57P3N	429
HAPMAP196NFN	640	HBCSR1548P	551	HBWCT4224P	454, 546	HEC57PLN	429
HAPMAP196NFNE	641	HBCSR1560P	551	HBWCT4230P	454, 546	HEC57PSN	429
HAPMAP236NFN	640	HBCSR1566P	551	HBWCT4824P	454, 546	HEC57PTN	429
HAPMAP236NFNE	641	HBCSR1572P	551	HBWCT4830P	454, 546	HEC57PXN	429
HAPMBPI96NP	640	HBCSR2424P	551	HBWD2450P	550	HEC65P2N	429
HAPMBPI96NPTE	641	HBCSR3030P	551	HBWD3062P	550	HEC65P3N	429
HAPMBPI99TFN	640	HBCSR3636P	551	HBXRISER	711	HEC65PLN	429
HAPMBPI99TFNE	641	HBDMAUSB	703	HCI4	341, 344	HEC65PSN	429
HAPMBPI99SNPT	640	HBEAM48	506	HCD1	710	HEC65PTN	429
HAPMBPI99SNPTE	641	HBEAM60	506	HCLA65	561, 717	HEC65PXN	429
HAPMBP236NP	640	HBEAM72	506	HCM3648LN	712	HEC72P2N	429
HAPMBP236NPTE	641	HBENDCP	506	HCM3648LS	712	HEC72P3N	429
HAPMBP239TFN	640	HBEORH23	507	HCM4660LN	712	HEC72PLN	429
HAPMBP239TFNE	641	HBEORL23	507	HCNLEG29	556	HEC72PSN	429
HAPMBS239TFN	640	HBEORT23	507	HCOMDOME2	465, 539, 724	HEC72PTN	429
HAPMBS239TFNE	641	HBFAB	508	HCPU1	705	HEC72PXN	429
HAPMBS239SNPT	640	HBILNH23	507	HCRESCENTA2	302	HEC80P2N	429
HAPMBS239SNPTE	641	HBILNT23	507	HCRESCENTA3	302	HEC80P3N	429
HAPMCP199TPN	640	HBILNX23	507	HCRESCENTC2	302	HEC80PLN	429
HAPMCP199TPNE	641	HBLEG23	506	HCRESCENTC3	302	HEC80PSN	429
HAPMCP239TPN	640	HBLPBRIDGE	139	HCS3636P	553	HEC80PTN	429
HAPMCP239TPNE	641	HBLPCLASSIC	139	HCS4242P	553	HEC80PXN	429
HAPMCS239TPN	640	HBLPCONTEMP	139	HCTL181L	556	HECB01	552
HAPMCS239TPNE	641	HBMP2B	669	HCTL181R	556	HECB42	552
HARCHA2	171, 302	HBMP2F	669	HCTL182	556	HECC10	532
HARCHA3	171, 302	HBPPCK	508	HCTL241L	556	HECC15	532
HARCHC2	171, 302	HBPPEK	508	HCTL241R	556	HECPP	537
HARCHC3	171, 302	HBPPMK	508	HCTL242	556	HECPP156	537
HAS18	581	HBPPSK	508	HCTROUGH17	540, 720, 727	HECS1	430
HAS24	581	HBPRTCV	507	HCTROUGH1710	540, 720, 727	HECSL	430
HAUFHL15N	645	HBSMAUSB	703	HCTROUGH36	540, 727	HECSS	430
HAUFHL15NE	645	HBV-P4224	565	HCTROUGH3610	540, 727	HECST	430
HAUFHRI15N	645	HBV-P4230	565	HCWD2450P	550	HECSV	430
HAUFHRI15NE	645	HBV-P4236	565	HCWD3062P	550	HECSX	430
HAUFO15N	645	HBV-P4242	565	HD2	710	HECSY	430
HB9	580	HBV-P4248	565	HD8	710	HECVH07P	431
HB96PP	508	HBV-P4260	565	HDPS1	716	HECVH15P	431

CROSS REFERENCE INDEX

MODEL	PAGE	MODEL	PAGE	MODEL	PAGE	MODEL	PAGE
HECVH22P	431	HEOHRTA1560FD	530	HETP3536FP	422	HF24	668, 699
HECVH30P	431	HEOHRTA1572FD	530	HETP3542FP	422	HF246	668, 699
HEFEC35P	431	HEP35	537	HETP3548FP	422	HF27B	699
HEFEC42P	431	HEP65	537	HETP3560FP	422	HF27S	699
HEFEC50P	431	HEPDMK42P	424	HETP3572FP	422	HF50	668
HEFEC57P	431	HERECPCVR	464, 537	HETP4220FP	422	HF60	668
HEFEC65P	431	HESI520F	426	HETP4224FP	422	HF80	670
HEFEC72P	431	HESI520G	427	HETP4230FP	422	HFBRZPWM	597
HEFEC80P	431	HESI524F	426	HETP4236FP	422	HFLDGRMT	723
HEFGS0720	428	HESI524G	427	HETP4242FP	422	HFLDGRMT3	723
HEFGS0724	428	HESI530F	426	HETP4248FP	422	HFLDGRMT4	723
HEFGS0730	428	HESI530G	427	HETP4260FP	422	HFMBIN2	631
HEFGS0736	428	HESI536F	426	HETP4272FP	422	HFMBIN3	631
HEFGS0742	428	HESI536G	427	HETP5020DP	423	HFMBIN6	631
HEFGS0748	428	HESI542F	426	HETP5020FP	422	HFMSC182830RWB	631
HEFGS0754	428	HESI542G	427	HETP5024DP	423	HFMSC183930RWB	631
HEFGS0760	428	HESI548F	426	HETP5024FP	422	HFMSC185230RWB	631
HEFGS0766	428	HESI548G	427	HETP5030DP	423	HFMSC186430RWB	631
HEFGS0772	428	HESI560F	426	HETP5030FP	422	HFSC183640(?)	633
HEFGS1520	428	HESI560G	427	HETP5036DP	423	HFSC183640W	632
HEFGS1524	428	HESI572F	426	HETP5036FP	422	HFSC183664(?)	633
HEFGS1530	428	HESI572G	427	HETP5042DP	423	HFSC183664W	632
HEFGS1536	428	HES3020G	427	HETP5042FP	422	HGRMTAC	540, 723
HEFGS1542	428	HES3024G	427	HETP5048DP	423	HGRMTAC2	723
HEFGS1548	428	HES3030G	427	HETP5048FP	422	HGRMTDATA	723
HEFGS1554	428	HES3036G	427	HETP5060DP	423	HGRMTUSB2	540, 723
HEFGS1560	428	HES3042G	427	HETP5060FP	422	HGROM1BLANK	725
HEFGS1566	428	HES3048G	427	HETP5072DP	423	HGROM2BLANK	725
HEFGS1572	428	HES3060G	427	HETP5072FP	422	HH15042SD	393, 424
HEFTAC	432	HESDMK30	424	HETP6520DP	423	HH16542SD	393, 424
HEGFG0718	494	HESDMK36	424	HETP6520FP	422	HH18042SD	393, 424
HEGFG0721	494	HESDMK42	424	HETP6524DP	423	HH870070	508, 537
HEGFG0724	494	HESDMK48	424	HETP6524FP	422	HH870924	714
HEGFG0727	494	HESHRTA24	530	HETP6530DP	423	HH870924CH	714
HEGFG0730	494	HESHRTA30	530	HETP6530FP	422	HH870930	291, 714
HEGFG0733	494	HESHRTA36	530	HETP6536DP	423	HH870930CH	714
HEGFG0736	494	HESHRTA42	530	HETP6536FP	422	HH870942	291, 714
HEGFG0739	494	HESHRTA48	530	HETP6542DP	423	HH870942CH	714
HEGFG0742	494	HESHRTA60	530	HETP6542FP	422	HH870960	291, 335, 714
HEGFG0745	494	HESHRTA72	530	HETP6548DP	423	HH870960CH	335, 714
HEGFG0748	494	HETB2018	533	HETP6548FP	422	HH871024	463, 535
HEGFG0754	494	HETB2418	533	HETP6560DP	423	HH871024A	463, 535
HEGFG0757	494	HETB3018	533	HETP6560FP	422	HH871030	535
HEGFG0760	494	HETB3618	533	HETP6572DP	423	HH871030A	535
HEGFG0772	494	HETB4218	533	HETP6572FP	422	HH871036	535
HEGMC351	496	HETB4818	533	HEVHF07P	431	HH871036A	535
HEGMC352	496	HETB6018	533	HEVHF15P	431	HH871042	535
HEGMC421	496	HETB7218	533	HEVHF22P	431	HH871042A	535
HEGMC422	496	HETC20	425	HEVHF30P	431	HH871048	463, 535
HEGMC501	496	HETC24	425	HEVHG07P	428	HH871048A	463, 535
HEGMC502	496	HETC30	425	HEVHG15P	428	HH871060	463, 535
HEGMC571	496	HETC36	425	HEVHG22P	428	HH871060A	463, 535
HEGMC572	496	HETC42	425	HEVHG30P	428	HH871072	463, 535
HEGMC651	496	HETC48	425	HEWS35P	431	HH871124	535
HEGMC652	496	HETC60	425	HEWS42P	431	HH871124A	535
HEGMC721	496	HETC66	425	HEWS50P	431	HH871130	535
HEGMC722	496	HETC72	425	HEWS57P	431	HH871130A	535
HEGPEC	496	HETC78	425	HEWS65P	431	HH871136	535
HEGSFGA	496	HETC84	425	HEWS72P	431	HH871136A	535
HEOHRTA1524FD	530	HETC90	425	HEWS80P	431	HH871142	535
HEOHRTA1530FD	530	HETC96	425	HF22	670, 699	HH871142A	535
HEOHRTA1536FD	530	HETP3520FP	422	HF23B	699	HH871148	463, 535
HEOHRTA1542FD	530	HETP3524FP	422	HF23C	670, 699	HH871148A	463, 535
HEOHRTA1548FD	530	HETP3530FP	422	HF23S	596, 699	HH871160	463, 535

CROSS REFERENCE INDEX

MODEL	PAGE	MODEL	PAGE	MODEL	PAGE	MODEL	PAGE
HH871160A	463, 535	HHATB2S3LC	116	HHATW2894CT	117	HLCRPL5424WFH-PS	124
HH871172	463, 535	HHATB2S3LT	116	HHATW2946EM	456	HLCRPL5424WFH-US	124
HH871172A	463, 535	HHATB3S2LC	115, 197	HHATW2958EM	456	HLCRPL5424WFH	124
HH871224	535	HHATB3S2LT	115, 197	HHATW2970EM	456	HLCRPL5430WFH-PS	124
HH871224A	535	HHATB3S3LC	116, 197	HHATW3042CT	117	HLCRPL5430WFH-US	124
HH871230	535	HHATB3S3LT	116, 197	HHATW3048CT	117	HLCRPL5430WFH	124
HH871230A	535	HHATCC583422L	118	HHATW3054CT	117	HLCWFH-PS	125
HH871236	535	HHATCC583422R	118	HHATW3060CT	117	HLCWFH-US	125
HH871236A	535	HHATCC584622L	118	HHATW3066CT	117	HLDST1	715
HH871242	535	HHATCC584622R	118	HHATW3072CT	117	HLED1	713
HH871242A	535	HHATCC584628L	118	HHATW3078CT	117	HLED17A	291, 714
HH871248	463, 509, 535	HHATCC584628R	118	HHATW3084CT	117	HLED17AS	291, 335, 714
HH871248A	463, 509, 535	HHATCC603624L	118	HHATW3090CT	117	HLED17AUO	291, 714
HH871260	463, 509, 535	HHATCC603624R	118	HHATW3096CT	117	HLED10C	713
HH871260A	463, 509, 535	HHATCC604824L	118	HHEM620	540	HLED2	713
HH871272	463, 509, 535	HHATCC604824R	118	HHKDMK30	393	HLED31A	291, 714
HH871272A	463, 509, 535	HHATCC604830L	118	HHKDMK36	393	HLED31AS	291, 335, 714
HH871366	536	HHATCC604830R	118	HHKDMK42	393	HLED31AUO	291, 714
HH871366A	536	HHATCC703422L	118	HHKDMK48	393	HLEDOSA	291, 714
HH871400	464, 536	HHATCC703422R	118	HHMRK36	561	HLINEARA2	171, 302
HH871400A	464, 536	HHATCC704622L	118	HHMRK42	561	HLINEARA3	171, 302
HH871500	464, 536	HHATCC704622R	118	HHMRK48	561	HLINEARC2	171, 302
HH871501	464, 538	HHATCC704628L	118	HHN831118	556, 657	HLINEARC3	171, 302
HH871501A	464, 538	HHATCC704628R	118	HHN831124	367, 556	HLPLB3624	136
HH871502	464, 538	HHATCC723624L	118	HHN831130	367, 556	HLPLB4224	136
HH871502A	464, 538	HHATCC723624R	118	HHPMC6	410, 424	HLPLB4824	136
HH871503	464, 538	HHATCC724824L	118	HHPS1	716	HLPLBC3013B2	140
HH871503A	464, 538	HHATCC724824R	118	HHSWFTWR	509	HLPLBC3013B4	140
HH871504	464, 538	HHATCC724830L	118	HHT2DP	538	HLPLBC3013B5	140
HH871506	464, 538	HHATCC724830R	118	HHTADF3	509, 540	HLPLCL3020BF	142
HH871601	464, 509, 538	HHATM3S2LT	115, 197	HHTADF4	509, 540	HLPLCL3020S	142
HH871601A	509, 538	HHATM3S3LT	116	HHTADJ5	509, 540	HLPLCL3020TOP	142
HH871912	463, 509, 536	HHATW2240CT	117	HHTADJ6	509, 540	HLPLCL3620BF	142
HH871912A	509, 536	HHATW2246CT	117	HICG12	392, 424	HLPLCL3620S	142
HH871918	509, 536	HHATW2252CT	117	HJTRGH24	540, 727	HLPLCL3620TOP	142
HH871918A	509, 536	HHATW2258CT	117	HJTRGH36	540, 727	HLPLCL6020TOP	142
HH873500	536	HHATW2264CT	117	HKBS	706	HLPLCL6620TOP	142
HH873501	509, 538	HHATW2270CT	117	HKP2800	671	HLPLCL7220TOP	142
HH873501A	509, 538	HHATW2276CT	117	HKTLONG	706	HLPLCS30	137
HH873502	509, 538	HHATW2282CT	117	HKT MID	706	HLPLCS36	137
HH873502A	509, 538	HHATW2288CT	117	HKTSHORT	706	HLPLCS4824	136
HH873503	509, 538	HHATW2294CT	117	HLAM3348RR	76, 300	HLPLCS6024	136
HH873503A	509, 538	HHATW2346EM	456	HLAM3772RD	76, 300	HLPLCS6624	136
HH873504	509, 538	HHATW2358EM	456	HLAMMP6030	94, 270	HLPLCS7224	136
HH873506	509, 538	HHATW2370EM	456	HLAMMP7230	94, 270	HLPLCSEAT3020	142
HH879072	536	HHATW2442CT	117	HLAMSEAT3024	277	HLPLCSEAT3620	142
HH879072A	536	HHATW2448CT	117	HLAMSEAT3624	277	HLPLDH60	138
HH879168	536	HHATW2454CT	117	HLCPL29WFH-PS	125	HLPLDH66	138
HH879168A	536	HHATW2460CT	117	HLCPL29WFH-US	125	HLPLDH72	138
HH8988EBN	540	HHATW2466CT	117	HLCPL29WFH	125	HLPLDR12MB	138
HHABBT	120	HHATW2472CT	117	HLCR2442WFH	125	HLPLDR48GS	138
HHABCSTRPK	120	HHATW2478CT	117	HLCR2448WFH	125	HLPLDR48LM	138
HHABETA2S2L	119	HHATW2484CT	117	HLCR2454WFH	125	HLPLDR60GS	138
HHABG1GLIDE	120	HHATW2490CT	117	HLCR3048WFH	125	HLPLDR60LM	138
HHABGLIDE	120	HHATW2496CT	117	HLCR3054WFH	125	HLPLDR66GS	138
HHALGPT	497	HHATW2840CT	117	HLCRPL4224WFH-PS	124	HLPLDR66LM	138
HHALRECG	120, 497	HHATW2846CT	117	HLCRPL4224WFH-US	124	HLPLDR72GS	138
HHALRECL	120, 497	HHATW2852CT	117	HLCRPL4224WFH	124	HLPLDR72LM	138
HHALRECR	120, 497	HHATW2858CT	117	HLCRPL4824WFH-PS	124	HLPLDS4830	136
HHALRETG	120, 497	HHATW2864CT	117	HLCRPL4824WFH-US	124	HLPLDS6030	136
HHALRETL	120, 497	HHATW2870CT	117	HLCRPL4824WFH	124	HLPLDS6630	136
HHALRETR	120, 497	HHATW2876CT	117	HLCRPL4830WFH-PS	124	HLPLDS7230	136
HHATB2S2LC	115, 197	HHATW2882CT	117	HLCRPL4830WFH-US	124	HLPLDS7236	136
HHATB2S2LT	103, 115, 197, 268	HHATW2888CT	117	HLCRPL4830WFH	124	HLPLDS7236B	136

CROSS REFERENCE INDEX

MODEL	PAGE	MODEL	PAGE	MODEL	PAGE	MODEL	PAGE
HLPLFB24	141	HLSL1336B3	223	HLSL2060LD4	210	HLSL4014LM	95, 200
HLPLLEG24A	141	HLSL1336B4	223	HLSL2060LD4F	212	HLSL4028LM	95, 200
HLPLLEG24U	141	HLSL1436BH	216	HLSL2060LL2	210	HLSL42TW	206, 208
HLPLLEG30A	141	HLSL1436D	205	HLSL2060LL2F	213	HLSL4828O	100, 192, 265
HLPLLEG30U	141	HLSL1436S	205	HLSL2060LR2	210	HLSL4831MB	718
HLPLLF3620L2	140	HLSL1442D	205	HLSL2060LR2F	213	HLSL48TW	206, 208
HLPLLF3620L3	140	HLSL1442S	205	HLSL2060S4	210	HLSL4AM2	193
HLPLLF3620L4	140	HLSL1448D	205	HLSL2060S4F	213	HLSL500S	208
HLPL0S10	141	HLSL1448S	205	HLSL2072LD0	210	HLSL6028O	100, 192, 265
HLPL0S23	141	HLSL1460D	205	HLSL2072LD0F	212	HLSL60TW	206, 208
HLPLPEN6630E	137	HLSL1460LS	715	HLSL2072LD2	210	HLSL650S	208
HLPLPEN7236E	137	HLSL1460M	206	HLSL2072LD2F	212	HLSL66TW	206, 208
HLPLPHBF	139	HLSL1460S	205	HLSL2072LD4	210	HLSL7265TE	209
HLPLPMBBF	139	HLSL1466D	205	HLSL2072LD4F	212	HLSL72TW	206, 208
HLPLPMBF	139	HLSL1466M	206	HLSL2072LL2	210	HLSL78TW	206, 208
HLPLPMFF	139	HLSL1466S	205	HLSL2072LL2F	213	HLSLDRWORG	717
HLPLPSBBF	139	HLSL1472D	205	HLSL2072LR2	210	HLSLPBL	193, 554
HLPLPSEAT1520	139	HLSL1472DB	209	HLSL2072LR2F	213	HLSLPBR	193, 554
HLPLPSFF	139	HLSL1472LS	715	HLSL2072S4	210	HLSLPMSO42	207
HLPLRCPNDS7230	144	HLSL1472M	206	HLSL2072S4F	213	HLSLPMSO4	207
HLPLRCPNRS4225	144	HLSL1472MB	206	HLSL2070	192, 211	HLSLPMSOB	207
HLPLRCPNTPGS	144	HLSL1472S	205	HLSL207SL	192	HLSLR1330	208, 217
HLPLRCPNTPLM	144	HLSL1472SB	209	HLSL2428B	198	HLSLR1336	208, 217
HLPLRS3624	136	HLSL1512LSCL	217	HLSL2428E	193	HLSLR1345	208, 217
HLPLRS4224	136	HLSL1512LSCR	217	HLSL2428EBL	555	HLSLR2036	188
HLPLRS4824	136	HLSL1512LSO	217	HLSL2428EBR	555	HLSLR2042	188
HLPLRW4824	141	HLSL1530SOMB	112, 207	HLSL2428F	198	HLSLR2048	188
HLPLRW4830	141	HLSL1536SOMB	112, 207	HLSL2428O	100, 192, 265, 554	HLSLR2054	188
HLPLRW6024	141	HLSL154LSD	217	HLSL2428S	198	HLSLR2060	188
HLPLRW6030	141	HLSL154LSO	217	HLSL2428SL	100, 192, 266	HLSLR2066	188
HLPLRW6624	141	HLSL1760SOL	207	HLSL2430L	199	HLSLR2072	188
HLPLRW6630	141	HLSL1760SOR	207	HLSL2430MF	199	HLSLR2436	188
HLPLRW7224	141	HLSL1772SOL	207	HLSL2436L2	216	HLSLR2442	188
HLPLRW7230	141	HLSL1772SOR	207	HLSL2436L4	216	HLSLR2448	188, 196
HLPLSC3620	140	HLSL2016FP2	222	HLSL2436SC	216	HLSLR2448J	190
HLPLSL24	141	HLSL2016MP2	215	HLSL2441O	100, 194, 265, 559	HLSLR2454	188, 196
HLPLSL30	141	HLSL2016PH2	79, 215	HLSL2441S	195	HLSLR2460	188, 196
HLPLTACK48	138	HLSL2028B	198	HLSL2441SL	100, 194, 265, 559	HLSLR2460J	190
HLPLTACK60	138	HLSL2028E	193	HLSL2472LC	216	HLSLR2466	188, 196
HLPLTACK66	138	HLSL2028F	198	HLSL2470	100, 192, 211, 266	HLSLR2472	188, 196
HLPLTACK72	138	HLSL2028O	192, 554	HLSL247SL	192	HLSLR2472J	190
HLPLTBL120BASE	143	HLSL2028SL	192	HLSL240BC	199	HLSLR2484	188
HLPLTBL3672RCT	143	HLSL2030CH2	62, 79, 211, 215, 277	HLSL2814LM	95, 200	HLSLR3036	189
HLPLTBL36BASE	143	HLSL2030LD0	214	HLSL2828LM	95, 200	HLSLR3042	189
HLPLTBL36RND	143	HLSL2030LD0F	212	HLSL28AM2	193	HLSLR3048	189, 196
HLPLTBL4296RCT	143	HLSL2030LD1	214	HLSL28AW2	193	HLSLR3048J	190
HLPLTBL42BASE	143	HLSL2030LD1F	212	HLSL28P	59, 101, 193, 263, 556	HLSLR3054	189, 196
HLPLTBL42RND	143	HLSL2030LD2	214	HLSL3028B	198	HLSLR3060	189, 196
HLPLTBL48120RCT	143	HLSL2030LD2F	212	HLSL3028E	193	HLSLR3060J	190
HLPLTBL48BASE	143	HLSL2030MCO	215	HLSL3028EBL	555	HLSLR3066	189, 196
HLPLTBL48RND	143	HLSL2036CH2	62, 211, 277	HLSL3028EBR	555	HLSLR3072	189, 196
HLPLTBL72BASE	143	HLSL2036L2	216	HLSL3028F	198	HLSLR3072J	190
HLPLTBL96BASE	143	HLSL2036L4	216	HLSL3028O	100, 192, 265, 554	HLSLR3084	189
HLPLW1824	140	HLSL2036LDO	214	HLSL3028S	198	HLSLR3660	189
HLPLW2424	140	HLSL2036LD0F	212	HLSL3028SL	100, 192, 266	HLSLR3666	189
HLPLWMH48	138	HLSL2036LD1	214	HLSL3041O	100, 194, 265, 559	HLSLR3672	189
HLPLWMH60	138	HLSL2036LD1F	212	HLSL3041S	195	HLSLSB	208
HLPLWMH66	138	HLSL2036LD2	214	HLSL3041SL	100, 194, 265, 559	HLSLSPBL	194
HLPLWMH72	138	HLSL2036LD2F	212	HLSL3070	100, 192, 211, 266	HLSLSPBR	194
HLPLXS60	141	HLSL2036SC	216	HLSL307SL	192	HLSLW045L	219
HLPLXS66	141	HLSL2060LDO	210	HLSL300BC	199	HLSLW045LF	221
HLPLXS72	141	HLSL2060LD0F	212	HLSL3414LM	95, 200	HLSLW045R	219
HLSL1212	208, 717	HLSL2060LD2	210	HLSL3428LM	95, 200	HLSLW045RF	221
HLSL1336B2	223	HLSL2060LD2F	212	HLSL36TW	206, 208	HLSLW046L	219

CROSS REFERENCE INDEX

MODEL	PAGE	MODEL	PAGE	MODEL	PAGE	MODEL	PAGE
HLSLW046R	219	HMBPOST1	556	HMPLGP6050	462	HNL1566LL	70
HLSLW084L	221	HMBPOST2	92	HMPLM2426	462	HNL1566LO	70
HLSLW084LF	221	HMBTLEG24	102	HMPLM2434	462	HNL1566SD	71
HLSLW084R	221	HMP120EL4828	449	HMPLM3026	462	HNL1572FD	71
HLSLW084RF	221	HMP120EL6028	449	HMPLM3034	462	HNL1572FO	71
HLSLW085L	220	HMP120POST	449	HMPLM4826	462	HNL1572LD	70
HLSLW085LF	221	HMP120TROUGH36	451	HMPLM4834	462	HNL1572LL	70
HLSLW085R	220	HMP120TROUGH42	451	HMPLM6026	462	HNL1572LO	70
HLSLW085RF	221	HMP120TROUGH48	451	HMPLM6034	462	HNL1572SD	71
HLSLW086L	220	HMP120UB236	450	HMPPP125	465	HNL1578FD	71
HLSLW086R	220	HMP120UB242	450	HMPRELEL2428	448, 452	HNL1578FO	71
HLSLW1224L	195	HMP120UB248	450	HMPRREL2428	448, 452	HNL1578LD	70
HLSLW1224R	195	HMP144	463, 509	HMPSL2428	448	HNL1578LL	70
HLSLW1230L	195	HMP2460PK2	446	HMPSL3028	448	HNL1578LO	70
HLSLW1230R	195	HMP2460PK4	446	HMPSL4828	448	HNL1578SD	71
HLSLW445L	219	HMP2460PK6	446	HMPSL6028	448	HNL16XS	92
HLSLW445LF	221	HMP2460PK8	446	HMPSTROUGH48	451	HNL1772RT	77
HLSLW445R	219	HMP2472PK2	446	HMPSTROUGH60	451	HNL203021D2	62
HLSLW445RF	221	HMP2472PK4	446	HMPSTROUGH72	451	HNL2030MSFC	79
HLSLW446L	219	HMP2472PK6	446	HMPSTROUGH48	451	HNL203621D2	62
HLSLW446LP	219	HMP2472PK8	446	HMPSTROUGH60	451	HNL206021D4	62
HLSLW446R	219	HMP3060PK2	446	HMPSTROUGH72	451	HNL206021LD2	62
HLSLW446RP	219	HMP3060PK4	446	HMPUB148	450, 452	HNL206021RD2	62
HLSLW485L	220	HMP3060PK6	446	HMPUB160	450, 452	HNL207221D4	62
HLSLW485LF	221	HMP3060PK8	446	HMPUB172	450	HNL207221LD2	62
HLSLW485R	220	HMP3072PK2	446	HMPUB248	450	HNL207221RD2	62
HLSLW485RF	221	HMP3072PK4	446	HMPUB260	450	HNL2116MBBF	79
HLSLW486L	220	HMP3072PK6	446	HMPUB272	450	HNL2116MBF	79
HLSLW486R	220	HMP3072PK8	446	HMPVWM28	465, 539, 727	HNL2116MFF	79
HLSLZ5SC48	191	HMPEEK48	463, 509	HN899900	392, 424	HNL231028PBBF	107
HLSLZ5SC54	191, 261, 659	HMPEEK60	463, 509	HN899910	392, 424	HNL231028PFF	107
HLSLZ5SC60	92, 191, 261, 659	HMPEEK72	463, 509	HNL11SUPP	99	HNL231041PBFFF	109
HLSLZ5SC66	92, 191, 261, 659	HMPPEL2428	448	HNL122428BKE	108	HNL231628PBBF	107
HLSLZ5SC72	92, 191, 261, 659	HMPPEL3028	448	HNL123028BKE	108	HNL231628PFF	107
HLSLZ5SC78	92	HMPPEL4828	448	HNL123628BKE	108	HNL231641PBFFF	109
HLSLZ5SC84	92, 191, 261, 659	HMPPEL6028	448	HNL1530BK2	85	HNL231641PSBBF	109
HLVPM1	337, 715	HMPHA2460PK2	447	HNL1530BK3	85	HNL231828PBBF	107
HLVPM2	716	HMPHA2460PK4	447	HNL1530BK4	85	HNL231828PFF	107
HMACABLE	722	HMPHA2460PK6	447	HNL1530BK5	85	HNL233028PBK	108
HMAAGANG	720	HMPHA2460PK8	447	HNL1530BK6	85	HNL233028PLF	107
HMAJUMP	722	HMPHA2472PK2	447	HNL1530FD	71	HNL233028PSC	108
HMAPLATE	722	HMPHA2472PK4	447	HNL1530LD	70	HNL233028PSL	108
HMAPOWER36	722	HMPHA2472PK6	447	HNL1530LL	70	HNL233628PBK	108
HMAPOWER362	722	HMPHA2472PK8	447	HNL1536FD	71	HNL233628PLF	107
HMAPOWER42	722	HMPHA2S4C	455	HNL1536LD	70	HNL233628PSC	108
HMAPOWER422	722	HMPHA3060PK2	447	HNL1536LL	70	HNL233628PSL	108
HMAPOWER48	722	HMPHA3060PK4	447	HNL1542FD	71	HNL241850TLL	84
HMAPOWER482	722	HMPHA3060PK6	447	HNL1542LD	70	HNL241850TLR	84
HMAPOWER54	722	HMPHA3060PK8	447	HNL1542LL	70	HNL241865SFLL	81
HMAPOWER542	722	HMPHA3072PK2	447	HNL1548FD	71	HNL241865SFLR	81
HMAPOWER60	722	HMPHA3072PK4	447	HNL1548FO	71	HNL241865SFX	81
HMAPOWER602	722	HMPHA3072PK6	447	HNL1548LD	70	HNL241865WLL	83
HMAPOWER66	722	HMPHA3072PK8	447	HNL1548LL	70	HNL241865WLR	83
HMAPOWER662	722	HMPHASLID20	455	HNL1548LO	70	HNL241879WLL	83
HMAPOWER72	722	HMPHASLID48	455	HNL1548SD	71	HNL241879WLR	83
HMAPOWER722	722	HMPHASLID60	455	HNL1560FD	71	HNL242465TLL	84
HMAPOWER84	722	HMPHASLID72	455	HNL1560FO	71	HNL242465TLR	84
HMAPOWER842	722	HMPHATFWML	465, 539	HNL1560LD	70	HNL242479TLL	84
HMAPOWER96	722	HMPHATROUGH48	455	HNL1560LL	70	HNL242479TLR	84
HMAPOWER962	722	HMPHATROUGH60	455	HNL1560LO	70	HNL2424BK5CL	85
HMASD	703	HMPHATROUGH72	455	HNL1560SD	71	HNL2424BK5CR	85
HMASPLIT	722	HMPHAWTWML	465, 539	HNL1566FD	71	HNL243629SC	81
HMASTS	703	HMPJUMP	463	HNL1566FO	71	HNL243665SC	81
HMBPOST	102	HMPLGP4850	462	HNL1566LD	70	HNL243665SLL	82

CROSS REFERENCE INDEX

MODEL	PAGE	MODEL	PAGE	MODEL	PAGE	MODEL	PAGE
HNL243665WL	83	HNL2948LL	72	HNL3660FD	65	HNL4936BHxD	74
HNL243665WLBR	83	HNL2948SD	73	HNL3660LBT	89	HNL4936FD	68
HNL243665WRBL	83	HNL2960FD	72	HNL3660LD	65	HNL4936LD	67
HNL243679SC	81	HNL2960LD	72	HNL3660LL	65	HNL4936LL	67
HNL243679WL	83	HNL2960LL	72	HNL3660RBT	89	HNL4936TB	112, 718
HNL243679WLBR	83	HNL2960SD	73	HNL3660SD	66	HNL4942FD	68
HNL243679WRBL	83	HNL2966FD	72	HNL3660WT	88	HNL4942LD	67
HNL2436LD2	80	HNL2966LD	72	HNL3666FD	65	HNL4942LL	67
HNL2436LD3	80	HNL2966LL	72	HNL3666LBT	89	HNL4948FD	68
HNL2436LD4	80	HNL2966SD	73	HNL3666LD	65	HNL4948LD	67
HNL2442BF	64	HNL2972FD	72	HNL3666LL	65	HNL4948LL	67
HNL2442LP	63	HNL2972LD	72	HNL3666RBT	89	HNL4948SD	69
HNL2442RP	63	HNL2972LL	72	HNL3666SD	66	HNL4960FD	68
HNL2448BF	64	HNL2972SD	73	HNL3666WT	88	HNL4960LD	67
HNL2448LP	63	HNL2978FD	72	HNL3672BUEP	58	HNL4960LL	67
HNL2448RP	63	HNL2978LD	72	HNL3672DPBB	55	HNL4960SD	69
HNL24602ILH	105	HNL2978LL	72	HNL3672DPBBF	55	HNL4966FD	68
HNL24602IRH	105	HNL2978SD	73	HNL3672DPBR	55	HNL4966LD	67
HNL2460DPK	61	HNL301850TLL	84	HNL3672DPRB	55	HNL4966LL	67
HNL2460LBT	89	HNL301850TLR	84	HNL3672DPRBF	55	HNL4966SD	69
HNL2460RBT	89	HNL3060DPRF	55	HNL3672DPRR	55	HNL4972FD	68
HNL2460WT	88	HNL3060LBT	89	HNL3672FD	65	HNL4972LD	67
HNL2466DPK	61	HNL3060RBT	89	HNL3672LBT	89	HNL4972LL	67
HNL2466LBT	89	HNL3060WT	88	HNL3672LD	65	HNL4972SD	69
HNL2466RBT	89	HNL3066BUEP	58	HNL3672LL	65	HNL4978FD	68
HNL2466WT	88	HNL3066DPRF	55	HNL3672LPBB	56	HNL4978LD	67
HNL24722ILH	105	HNL3066LBT	89	HNL3672LPBBF	56	HNL4978LL	67
HNL24722IRH	105	HNL3066LPRF	57	HNL3672LPBR	56	HNL4978SD	69
HNL2472DPK	61	HNL3066RBT	89	HNL3672LPRB	57	HNL603054LCH	90
HNL2472DPS	61	HNL3066RPRF	57	HNL3672LPRBF	57	HNL603054RCH	90
HNL2472LBT	89	HNL3066WT	88	HNL3672LPRR	57	HNL603060LCH	90
HNL2472LLC	61	HNL3072BUEP	58	HNL3672LPT	90	HNL603060RCH	90
HNL2472LP	61	HNL3072LBT	89	HNL3672RBT	89	HNL603660LCH	90
HNL2472RBT	89	HNL3072LPT	90	HNL3672RPBB	56	HNL603660RCH	90
HNL2472RLC	61	HNL3072RBT	89	HNL3672RPBBF	56	HNL663054LCH	90
HNL2472RP	61	HNL3072RPT	90	HNL3672RPBR	56	HNL663054RCH	90
HNL2472WT	88	HNL3072WT	88	HNL3672RPRB	57	HNL663060LCH	90
HNL2478LBT	89	HNL3078LBT	89	HNL3672RPRBF	57	HNL663060RCH	90
HNL2478RBT	89	HNL3078RBT	89	HNL3672RPRR	57	HNL663660LCH	90
HNL2478WT	88	HNL3078WT	88	HNL3672RPT	90	HNL663660RCH	90
HNL2484LBT	89	HNL3084LBT	89	HNL3672SD	66	HNL723054LCH	90
HNL2484RBT	89	HNL3084RBT	89	HNL3672WT	88	HNL723054RCH	90
HNL2484WT	88	HNL3084WT	88	HNL3678FD	65	HNL723060LCH	90
HNL24SHR	105, 268	HNL30SHR	105, 268	HNL3678LBT	89	HNL723060RCH	90
HNL2814LM	95	HNL3414LM	95	HNL3678LD	65	HNL723660LCH	90
HNL28XS	92	HNL3605SSEP	66	HNL3678LL	65	HNL723660RCH	90
HNL291028PBBF	107	HNL3630BHLD	74	HNL3678RBT	89	HNL7872RLT	78
HNL291028PFF	107	HNL3630BHxD	74	HNL3678SD	66	HNL7872RT	77
HNL291041PBBFF	109	HNL3630TB	112, 718	HNL3678WT	88	HNL8472RLT	78
HNL291628PBBF	107	HNL3636BHFD	75	HNL3684LBT	89	HNL8472RT	77
HNL291628PFF	107	HNL3636BHLD	74	HNL3684RBT	89	HNLAB2SIL	104, 268
HNL291641PBBFF	109	HNL3636BHxD	74	HNL3684WT	88	HNLAB3SIL	104
HNL291641PSBBF	109	HNL3636CU	60	HNL36SHR	105, 268	HNLBU3048	88
HNL2930FD	72	HNL3636FD	65	HNL4014LM	95	HNLBU3060	88
HNL2930LD	72	HNL3636LD	65	HNL4272JLEP	58	HNLBU3066	88
HNL2930LL	72	HNL3636LL	65	HNL4272JREP	58	HNLBU3072	88
HNL2936FD	72	HNL3636TB	112, 718	HNL4872JLEP	58	HNLBU3078	88
HNL2936LD	72	HNL3642FD	65	HNL4872JREP	58	HNLBU3084	88
HNL2936LL	72	HNL3642LD	65	HNL4905SSEP	69	HNLBW3672	88
HNL2942FD	72	HNL3642LL	65	HNL4930BHLD	74	HNLBW3684	88
HNL2942LD	72	HNL3648FD	65	HNL4930BHxD	74	HNLCDShelf	112
HNL2942LL	72	HNL3648LD	65	HNL4930TB	112, 718	HNLECC367224L	91
HNL2948FD	72	HNL3648LL	65	HNL4936BHFD	75	HNLECC367224R	91
HNL2948LD	72	HNL3648SD	66	HNL4936BHLD	74	HNLECC487224L	91

CROSS REFERENCE INDEX

MODEL	PAGE	MODEL	PAGE	MODEL	PAGE	MODEL	PAGE
HNLE487224R	91	HNLRC2042V	87	HPD2PNBRK2L	557	HRVC15PX	394
HNLEP1128	97	HNLRC2048V	87	HPD2PNBRK2R	557	HRVC15PXF	394
HNLEP1141	97	HNLRC2430	86	HPMARKER1	700	HRVC22PFT	396
HNLEP2428L	96	HNLRC2430V	87	HPSEAT18ND	621, 670	HRVC22PFV	396
HNLEP2428R	96	HNLRC2436	86	HPSEAT24ND	621, 624, 628, 644, 670	HRVC22PFVF	396
HNLEP2441L	96	HNLRC2436V	87	HPULL2	595	HRVC22PL	394
HNLEP2441R	96	HNLRC2442	86	HPULL3	595	HRVC22PLF	394
HNLEP247L	98, 262	HNLRC2442V	87	HPWRMOB1	724	HRVC22PS	394
HNLEP247R	98, 262	HNLRC2448	86	HPWRMOD2	465, 724	HRVC22PSF	394
HNLEP3028L	96	HNLRC2448V	87	HPWRMOD2UWM	465, 539, 724	HRVC22PT	394
HNLEP3028R	96	HNLRC2454	86	HPWRMOD2WC	465, 539, 724	HRVC22PTF	394
HNLEP3041L	96	HNLRC2454V	87	HPWRMOD3UWM	465, 539, 724	HRVC22PX	394
HNLEP3041R	96	HNLRC2460	86	HPWRMOD3WC	465, 539, 724	HRVC22PXF	394
HNLEP307L	98, 262	HNLRC2460V	87	HPWRMOD4WC	724	HRVC30PF	396
HNLEP307R	98, 262	HNLRC2466	86	HQB	720	HRVC30PFF	396
HNLEP3628L	96	HNLRC2472	86	HQBCJ36	720	HRVC30PFT	396
HNLEP3628R	96	HNLRC2478	86	HQH1-3	720	HRVC30PFV	396
HNLLB1013	111	HNLRC2484	86	HQH5-3	720	HRVC30PFVF	396
HNLLB1018	111	HNLRC2490	86	HQH5-E-3PIE	720	HRVC30PL	394
HNLLB1613	111	HNLRC2496	86	HQH5-E-3PIU2B	720	HRVC30PLF	394
HNLLB1618	111	HNLRC3048	86	HQH5-E-3P3B	720	HRVC30PS	394
HNLLB1818	111	HNLRC3060	86	HQH5-P-3PIB	720	HRVC30PSF	394
HNLLB3018	111	HNLRC3066	86	HQJ3	720	HRVC30PT	394
HNLLB3618	111	HNLRC3072	86	HRABAB	410	HRVC30PTF	394
HNLLP2428L	98	HNLRC3078	86	HRFTAB	410	HRVC30PX	394
HNLLP2428R	98	HNLRC3084	86	HRVBPLATE336	391, 534	HRVC30PXF	394
HNLLP2441L	98	HNLRC3672	86	HRVBPLATE342	391, 534	HRVC35GP	495
HNLLP2441R	98	HNLRC3684	86	HRVBPLATE348	391, 534	HRVC35GPF	495
HNLLP3028L	98	HNLRR2823	104	HRVBPLATE360	391, 534	HRVC35PCE	396, 431, 558
HNLLP3028R	98	HNLRR3423	104	HRVBR1524	552	HRVC35PCM	396, 431, 558
HNLLP3041L	98	HNLRR4023	104	HRVBR1524F	552	HRVC35PF	396
HNLLP3041R	98	HNLRR4623	104	HRVBR1524P	552	HRVC35PFF	396
HNLMP3010	93	HNLTEP2428	99	HRVBR1524PF	552	HRVC35PL	394
HNLMP3028	93	HNLTEP3028	99	HRVBR1530	552	HRVC35PLF	394
HNLMP3610	93	HNLTEP3628	99	HRVBR1530F	552	HRVC35PS	394
HNLMP3628	93	HNPMBSW24	407, 561	HRVBR1530P	552	HRVC35PSF	394
HNLMP4210	93	HNPMBSW30	407, 561	HRVBR1530PF	552	HRVC35PT	394
HNLMP4228	93	HNPMBSW36	407, 561	HRVBR1536	552	HRVC35PTF	394
HNLMP4810	93	HNPMBSW42	407, 561	HRVBR1536F	552	HRVC35PX	394
HNLMP4828	93	HNPMBSW48	407, 561	HRVBR1536P	552	HRVC35PXF	394
HNLMP5410	93	HNPMBSW60	407, 561	HRVBR1536PF	552	HRVC35PY2	395
HNLMP5428	93	HOLEG12	554	HRVBR1542	552	HRVC35PY2F	395
HNLMP6010	93	HOLEG18	554	HRVBR1542F	552	HRVC35PY3	395
HNLMP6028	93	HOLEG24	554	HRVBR1548	552	HRVC35PY3F	395
HNLMP6610	93	HOLEG30	554	HRVBR1548F	552	HRVC42GP	495
HNLMP6628	93	HP3231	341	HRVBR1560	552	HRVC42GPF	495
HNLMP7210	93	HP3235R	340	HRVBR1560F	552	HRVC42PF	396
HNLMP7228	93	HP3236L	340	HRVBR1566	552	HRVC42PFF	396
HNLMP7810	93	HP3251R	340	HRVBR1566F	552	HRVC42PL	394
HNLMP7828	93	HP3261	340	HRVBR1572	552	HRVC42PLF	394
HNLMP8410	93	HP3262	340	HRVBR1572F	552	HRVC42PS	394
HNLMP8428	93	HP3265R	340	HRVC15FFV	396	HRVC42PSF	394
HNLMP9010	93	HP3266L	340	HRVC15FFVF	396	HRVC42PT	394
HNLMP9028	93	HP3276	340	HRVC15PF	396	HRVC42PTF	394
HNLMP9610	93	HPACSM	703	HRVC15PFF	396	HRVC42PX	394
HNLMP9628	93	HPACW	703	HRVC15PFT	396	HRVC42PXF	394
HNLPB1028	111	HPADD	704	HRVC15PFV	396	HRVC42PY2	395
HNLPB1041	111	HPASD	704	HRVC15PFVF	396	HRVC42PY2F	395
HNLPB1628	111	HPATF	704	HRVC15PL	394	HRVC42PY3	395
HNLPB1641	111	HPC180G	59, 161, 281	HRVC15PLF	394	HRVC42PY3F	395
HNLPB1828	111	HPC180W	59	HRVC15PS	394	HRVC50GP	495
HNLPT2416	110	HPC190X	58, 101, 263	HRVC15PSF	394	HRVC50GPF	495
HNLPT2418	110	HPC191X	58, 101, 263	HRVC15PT	394	HRVC50PF	396
HNLPT3016	110	HPCW1	621, 670	HRVC15PTF	394	HRVC50PFF	396

CROSS REFERENCE INDEX

MODEL	PAGE	MODEL	PAGE	MODEL	PAGE	MODEL	PAGE
HRVC50PL	394	HRVC80PSF	394	HRVFSB42	390	HRVG3542LG	482
HRVC50PLF	394	HRVC80PT	394	HRVFSB48	390	HRVG3545L	479
HRVC50PS	394	HRVC80PTF	394	HRVFSB60	390	HRVG3545LG	482
HRVC50PSF	394	HRVC80PX	394	HRVFSBW24	397	HRVG3548GGL	487
HRVC50PT	394	HRVC80PXF	394	HRVFSBW30	397	HRVG3548GGLG	488
HRVC50PTF	394	HRVCE	481, 484, 495	HRVFSBW36	397	HRVG3548GGR	485
HRVC50PX	394	HRVCLG24	366, 554	HRVFSBW42	397	HRVG3548GGRG	486
HRVC50PXF	394	HRVCLG30	366, 554	HRVFSBW48	397	HRVG3548GGT	489
HRVC50PY2	395	HRVCM	495	HRVFSBW60	397	HRVG3548GGTG	490
HRVC50PY2F	395	HRVD0742T	392	HRVG35111L	481	HRVG3548L	479
HRVC50PY3	395	HRVD9542P	392	HRVG35111LG	484	HRVG3548LG	482
HRVC50PY3F	395	HRVEP1129L	366, 554	HRVG35123L	481	HRVG3551L	479
HRVC57GP	495	HRVEP1129R	366, 554	HRVG35123LG	484	HRVG3551LG	482
HRVC57GPF	495	HRVEP2429L	366, 554	HRVG351824GGNS	491	HRVG3560GGL	487
HRVC57PF	396	HRVEP2429L	366, 554	HRVG351824GGNSG	492	HRVG3560GGLG	488
HRVC57PFF	396	HRVEP2429R	366, 554	HRVG351830GGNS	491	HRVG3560GGR	485
HRVC57PL	394	HRVEP3029L	366, 554	HRVG351830GGNSG	492	HRVG3560GGRG	486
HRVC57PLF	394	HRVEP3029R	366, 554	HRVG3518GGL	487	HRVG3560GGT	489
HRVC57PS	394	HRVF1524	390	HRVG3518GGLG	488	HRVG3560GGTG	490
HRVC57PSF	394	HRVF1530	390	HRVG3518GGR	485	HRVG3560L	479
HRVC57PT	394	HRVF1536	390	HRVG3518GGRG	486	HRVG3560LG	482
HRVC57PTF	394	HRVF1542	390	HRVG3518GGT	489	HRVG3560LG	482
HRVC57PX	394	HRVF1548	390	HRVG3518GGTG	490	HRVG3563L	479
HRVC57PXF	394	HRVF1560	390	HRVG352418GGNS	491	HRVG3563LG	482
HRVC57PY2	395	HRVF3024	390	HRVG352418GGNSG	492	HRVG3572GGT	489
HRVC57PY2F	395	HRVF3030	390	HRVG352430GGNS	492	HRVG3572GGTG	490
HRVC57PY3	395	HRVF3036	390	HRVG352430GGNSG	491	HRVG3575L	479
HRVC57PY3F	395	HRVF3042	390	HRVG352430GGNSG	492	HRVG3575LG	482
HRVC65GP	495	HRVF3048	390	HRVG3524GGL	487	HRVG3575LG	482
HRVC65GPF	495	HRVF3060	390	HRVG3524GGLG	488	HRVG3587L	481
HRVC65PF	396	HRVF3524P	387	HRVG3524GGR	485	HRVG3587LG	484
HRVC65PFF	396	HRVF3530P	387	HRVG3524GGRG	486	HRVG3599L	481
HRVC65PL	394	HRVF3536P	387	HRVG3524L	479	HRVG3599LG	484
HRVC65PLF	394	HRVF3542P	387	HRVG3524LG	482	HRVG42111L	481
HRVC65PS	394	HRVF3548P	387	HRVG3524L	482	HRVG42111LG	484
HRVC65PSF	394	HRVF3560P	387	HRVG3527L	479	HRVG42123L	481
HRVC65PT	394	HRVF4224P	387	HRVG3527LG	482	HRVG42123LG	484
HRVC65PTF	394	HRVF4230P	387	HRVG353018GGNS	491	HRVG421824GGNS	491
HRVC65PW	396	HRVF4236P	387	HRVG353018GGNSG	492	HRVG421824GGNSG	492
HRVC65PWF	396	HRVF4242P	387	HRVG353024GGNS	491	HRVG421830GGNS	491
HRVC65PX	394	HRVF4248P	387	HRVG353024GGNSG	492	HRVG421830GGNSG	492
HRVC65PXF	394	HRVF4260P	387	HRVG3530GGL	487	HRVG421830GGNSG	492
HRVC65PY2	395	HRVF5024P	387	HRVG3530GGLG	488	HRVG4218GGL	487
HRVC65PY2F	395	HRVF5030P	387	HRVG3530GGGR	485	HRVG4218GGLG	488
HRVC65PY3	395	HRVF5036P	387	HRVG3530GGRG	486	HRVG4218GGR	485
HRVC65PY3F	395	HRVF5042P	387	HRVG3530L	479	HRVG4218GGRG	486
HRVC7FFV	396	HRVF5048P	387	HRVG3530LG	482	HRVG4218GGT	489
HRVC7FFVF	396	HRVF5060P	387	HRVG3533L	479	HRVG4218GGTG	490
HRVC7PFT	396	HRVF5724P	387	HRVG3533LG	482	HRVG422418GGNS	491
HRVC7PFV	396	HRVF5730P	387	HRVG3536GGL	487	HRVG422418GGNSG	492
HRVC7PFFV	396	HRVF5736P	387	HRVG3536GGLG	488	HRVG422430GGNS	491
HRVC7PL	394	HRVF5742P	387	HRVG3536GGR	485	HRVG422430GGNSG	492
HRVC7PLF	394	HRVF5748P	387	HRVG3536GGRG	486	HRVG4224GGL	487
HRVC7PS	394	HRVF5760P	387	HRVG3536GGT	489	HRVG4224GGLG	488
HRVC7PSF	394	HRVF6524P	387	HRVG3536GGTG	490	HRVG4224GGR	485
HRVC7PT	394	HRVF6530P	387	HRVG3536L	479	HRVG4224GGRG	486
HRVC7PTF	394	HRVF6536P	387	HRVG3536LG	482	HRVG4224L	479
HRVC7PX	394	HRVF6542P	387	HRVG3539L	479	HRVG4224LG	482
HRVC7PXF	394	HRVF6548P	387	HRVG3539LG	482	HRVG4227L	479
HRVC80PF	396	HRVF6560P	387	HRVG3542GGL	487	HRVG4227LG	482
HRVC80PFF	396	HRVFFOOT	389	HRVG3542GGLG	488	HRVG423018GGNS	491
HRVC80PL	394	HRVFSB24	390	HRVG3542GGGR	486	HRVG423018GGNSG	492
HRVC80PLF	394	HRVFSB30	390	HRVG3542GGRG	486	HRVG423024GGNS	491
HRVC80PS	394	HRVFSB36	390	HRVG3542GGT	489	HRVG423024GGNSG	492
				HRVG3542GGTG	490	HRVG4230GGL	487
				HRVG3542L	479	HRVG4230GGLG	488
						HRVG4230GGR	485

CROSS REFERENCE INDEX

MODEL	PAGE	MODEL	PAGE	MODEL	PAGE	MODEL	PAGE
HRVG4230GGRG	486	HRVG5018GGRG	486	HRVG5060LG	483	HRVG5742GGTG	490
HRVG4230L	479	HRVG5018GGT	489	HRVG5063L	480	HRVG5742L	480
HRVG4230LG	482	HRVG5018GGTG	490	HRVG5063LG	483	HRVG5742LG	483
HRVG4233L	479	HRVG502418GGNS	491	HRVG5072GGT	489	HRVG5745L	480
HRVG4233LG	482	HRVG502418GGNSG	492	HRVG5072GGTG	490	HRVG5745LG	483
HRVG4236GGL	487	HRVG502430GGNS	491	HRVG5075L	480	HRVG5748GGL	487
HRVG4236GGLG	488	HRVG502430GGNSG	492	HRVG5075LG	483	HRVG5748GGLG	488
HRVG4236GGR	485	HRVG5024GGL	487	HRVG5087L	481	HRVG5748GGR	485
HRVG4236GGRG	486	HRVG5024GGLG	488	HRVG5087LG	484	HRVG5748GGRG	486
HRVG4236GGT	489	HRVG5024GGR	485	HRVG5099L	481	HRVG5748GGT	489
HRVG4236GGTG	490	HRVG5024GGRG	486	HRVG5099LG	484	HRVG5748GGTG	490
HRVG4236L	479	HRVG5024L	480	HRVG57111L	481	HRVG5748L	480
HRVG4236LG	482	HRVG5024LG	483	HRVG57111LG	484	HRVG5748LG	483
HRVG4239L	479	HRVG5027L	480	HRVG57123L	481	HRVG5751L	480
HRVG4239LG	482	HRVG5027LG	483	HRVG57123LG	484	HRVG5751LG	483
HRVG4242GGL	487	HRVG503018GGNS	491	HRVG571824GGNS	491	HRVG5760GGL	487
HRVG4242GGLG	488	HRVG503018GGNSG	492	HRVG571824GGNSG	492	HRVG5760GGLG	488
HRVG4242GGR	485	HRVG503024GGNS	491	HRVG571830GGNS	491	HRVG5760GGR	485
HRVG4242GGRG	486	HRVG503024GGNSG	492	HRVG571830GGNSG	492	HRVG5760GGRG	486
HRVG4242GGT	489	HRVG5030GGL	487	HRVG5718GGL	487	HRVG5760GGT	489
HRVG4242GGTG	490	HRVG5030GGLG	488	HRVG5718GGLG	488	HRVG5760GGTG	490
HRVG4242L	479	HRVG5030GGR	485	HRVG5718GGR	485	HRVG5760L	480
HRVG4242LG	482	HRVG5030GGRG	486	HRVG5718GGRG	486	HRVG5760LG	483
HRVG4245L	479	HRVG5030L	480	HRVG5718GGT	489	HRVG5763L	480
HRVG4245LG	482	HRVG5030LG	483	HRVG5718GGTG	490	HRVG5763LG	483
HRVG4248GGL	487	HRVG5033L	480	HRVG572418GGNS	491	HRVG5772GGT	489
HRVG4248GGLG	488	HRVG5033LG	483	HRVG572418GGNSG	492	HRVG5772GGTG	490
HRVG4248GGR	485	HRVG5036GGL	487	HRVG572430GGNS	491	HRVG5775L	480
HRVG4248GGRG	486	HRVG5036GGLG	488	HRVG572430GGNSG	492	HRVG5775LG	483
HRVG4248GGT	489	HRVG5036GGR	485	HRVG5724GGL	487	HRVG5787L	481
HRVG4248GGTG	490	HRVG5036GGRG	486	HRVG5724GGLG	488	HRVG5787LG	484
HRVG4248L	479	HRVG5036GGT	489	HRVG5724GGR	485	HRVG5799L	481
HRVG4248LG	482	HRVG5036GGTG	490	HRVG5724GGRG	486	HRVG5799LG	484
HRVG4251L	479	HRVG5036L	480	HRVG5724L	480	HRVGCKS	498
HRVG4251LG	482	HRVG5036LG	483	HRVG5724LG	483	HRVGFCH	498
HRVG4260GGL	487	HRVG5039L	480	HRVG5727L	480	HRVGLSK	495, 496
HRVG4260GGLG	488	HRVG5039LG	483	HRVG5727LG	483	HRVGMSK	495, 496
HRVG4260GGR	485	HRVG5042GGL	487	HRVG573018GGNS	491	HRVGPFI	498
HRVG4260GGRG	486	HRVG5042GGLG	488	HRVG573018GGNSG	492	HRVGPFI2	498
HRVG4260GGT	489	HRVG5042GGR	485	HRVG573024GGNS	491	HRVGR12	498
HRVG4260GGTG	490	HRVG5042GGRG	486	HRVG573024GGNSG	492	HRVGR18	498
HRVG4260L	479	HRVG5042GGT	489	HRVG5730GGL	487	HRVGR24	498
HRVG4260LG	482	HRVG5042GGTG	490	HRVG5730GGLG	488	HRVGR30	498
HRVG4263L	479	HRVG5042L	480	HRVG5730GGR	485	HRVGR36	498
HRVG4263LG	482	HRVG5042LG	483	HRVG5730GGRG	486	HRVGRAFI	498
HRVG4272GGT	489	HRVG5045L	480	HRVG5730L	480	HRVGRAFI2	498
HRVG4272GGTG	490	HRVG5045LG	483	HRVG5730LG	483	HRVGRAFI3	498
HRVG4275L	479	HRVG5048GGL	487	HRVG5733L	480	HRVGRBS	498
HRVG4275LG	482	HRVG5048GGLG	488	HRVG5733LG	483	HRVGRCH	498
HRVG4287L	481	HRVG5048GGR	485	HRVG5736GGL	487	HRVGRPS	498
HRVG4287LG	484	HRVG5048GGRG	486	HRVG5736GGLG	488	HRVGRPT1	498
HRVG4299L	481	HRVG5048GGT	489	HRVG5736GGR	485	HRVGRPT2	498
HRVG4299LG	484	HRVG5048GGTG	490	HRVG5736GGRG	486	HRVGRPT3	498
HRVG50111L	481	HRVG5048L	480	HRVG5736GGT	489	HRVGS7578	495, 496
HRVG50111LG	484	HRVG5048LG	483	HRVG5736GGTG	490	HRVGTGG	497
HRVG50123L	481	HRVG5051L	480	HRVG5736L	480	HRVGS35	495, 496
HRVG50123LG	484	HRVG5051LG	483	HRVG5736LG	483	HRVGS42	495, 496
HRVG501824GGNS	491	HRVG5060GGL	487	HRVG5739L	480	HRVGS50	495, 496
HRVG501824GGNSG	492	HRVG5060GGLG	488	HRVG5739LG	483	HRVGS55	495, 496
HRVG501830GGNS	491	HRVG5060GGR	485	HRVG5742GGL	487	HRVHM2030	499
HRVG501830GGNSG	492	HRVG5060GGRG	486	HRVG5742GGLG	488	HRVHM2630	499
HRVG5018GGL	487	HRVG5060GGT	489	HRVG5742GGR	485	HRVMI524	499
HRVG5018GGLG	488	HRVG5060GGTG	490	HRVG5742GGRG	486	HRVMI530	499
HRVG5018GGR	485	HRVG5060L	480	HRVG5742GGT	489	HRVM2236	499

CROSS REFERENCE INDEX

MODEL	PAGE	MODEL	PAGE	MODEL	PAGE	MODEL	PAGE
HRVM2248	499	HRVT0778F	405	HRVT1554FF	405	HRVT3042R	404
HRVM2260	499	HRVT0778FF	405	HRVT1560CK	410	HRVT3042T	398
HRVOH1530RM	529	HRVT0784F	405	HRVT1560E	400	HRVT3048CK	410
HRVOH1536RM	529	HRVT0784FF	405	HRVT1560F	405	HRVT3048E	400
HRVOH1542RM	529	HRVT0790F	405	HRVT1560FF	405	HRVT3048G	403
HRVOH1548RM	529	HRVT0790FF	405	HRVT1560G	403	HRVT3048HS3	402
HRVOH1560RM	529	HRVT0796F	405	HRVT1560HS3	402	HRVT3048M	408
HRVOH24FM	529	HRVT0796FF	405	HRVT1560M	408	HRVT3048P	406
HRVOH30FM	529	HRVT1524CK	410	HRVT1560PM	409	HRVT3048PM	409
HRVOH36FM	529	HRVT1524E	400	HRVT1560R	404	HRVT3048R	404
HRVOH42FM	529	HRVT1524F	405	HRVT1560T	398	HRVT3048T	398
HRVOH48FM	529	HRVT1524FF	405	HRVT1560W	407	HRVT3060CK	410
HRVOH60FM	529	HRVT1524G	403	HRVT1566F	405	HRVT3060E	400
HRVOH72FM	529	HRVT1524HS3	402	HRVT1566FF	405	HRVT3060G	403
HRVOMOD	397	HRVT1524M	408	HRVT1572F	405	HRVT3060HS3	402
HRVP24P	537	HRVT1524PM	409	HRVT1572FF	405	HRVT3060M	408
HRVP24PF	537	HRVT1524R	404	HRVT1578F	405	HRVT3060P	406
HRVP30P	537	HRVT1524T	398	HRVT1578FF	405	HRVT3060PM	409
HRVP30PF	537	HRVT1524W	407	HRVT1584F	405	HRVT3060R	404
HRVP36P	537	HRVT1530CK	410	HRVT1584FF	405	HRVT3060T	398
HRVP36PF	537	HRVT1530E	400	HRVT1590F	405	HRVT3724E	400
HRVP42P	537	HRVT1530F	405	HRVT1590FF	405	HRVT3724HS3	402
HRVP42PF	537	HRVT1530FF	405	HRVT1596F	405	HRVT3724T	398
HRVP48P	537	HRVT1530G	403	HRVT1596FF	405	HRVT3730E	400
HRVP48PF	537	HRVT1530HS3	402	HRVT2224T	398	HRVT3730HS3	402
HRVP60P	537	HRVT1530M	408	HRVT2230T	398	HRVT3730T	398
HRVP60PF	537	HRVT1530PM	409	HRVT2236T	398	HRVT3736E	400
HRVSH24	529	HRVT1530R	404	HRVT2242T	398	HRVT3736HS3	402
HRVSH30	529	HRVT1530T	398	HRVT2248T	398	HRVT3736T	398
HRVSH36	529	HRVT1530W	407	HRVT2260T	398	HRVT3742E	400
HRVSH42	529	HRVT1536CK	410	HRVT3024CK	410	HRVT3742HS3	402
HRVSH48	529	HRVT1536E	400	HRVT3024E	400	HRVT3742T	398
HRVSH60	529	HRVT1536F	405	HRVT3024G	403	HRVT3748E	400
HRVSH72	529	HRVT1536FF	405	HRVT3024HS3	402	HRVT3748HS3	402
HRVSS24	391	HRVT1536G	403	HRVT3024M	408	HRVT3748T	398
HRVSS30	391	HRVT1536HS3	402	HRVT3024P	406	HRVT3760E	400
HRVSS36	391	HRVT1536M	408	HRVT3024PM	409	HRVT3760HS3	402
HRVSS42	391	HRVT1536PM	409	HRVT3024R	404	HRVT3760T	398
HRVSS48	391	HRVT1536R	404	HRVT3024T	398	HRVT4524E	401
HRVSS60	391	HRVT1536T	398	HRVT3030CK	410	HRVT4524T	399
HRVT0724F	405	HRVT1536W	407	HRVT3030E	400	HRVT4530E	401
HRVT0724FF	405	HRVT1542CK	410	HRVT3030G	403	HRVT4530T	399
HRVT0724T	398, 406	HRVT1542E	400	HRVT3030HS3	402	HRVT4536E	401
HRVT0730F	405	HRVT1542F	405	HRVT3030M	408	HRVT4536T	399
HRVT0730FF	405	HRVT1542FF	405	HRVT3030P	406	HRVT4542E	401
HRVT0730T	398, 406	HRVT1542G	403	HRVT3030PM	409	HRVT4542T	399
HRVT0736F	405	HRVT1542HS3	402	HRVT3030R	404	HRVT4548E	401
HRVT0736FF	405	HRVT1542M	408	HRVT3030T	398	HRVT4548T	399
HRVT0736T	398, 406	HRVT1542PM	409	HRVT3036CK	410	HRVT4560E	401
HRVT0742F	405	HRVT1542R	404	HRVT3036E	400	HRVT4560T	399
HRVT0742FF	405	HRVT1542T	398	HRVT3036G	403	HRVT5224E	401
HRVT0742T	398, 406	HRVT1542W	407	HRVT3036HS3	402	HRVT5224T	399
HRVT0748F	405	HRVT1548CK	410	HRVT3036M	408	HRVT5230E	401
HRVT0748FF	405	HRVT1548E	400	HRVT3036P	406	HRVT5230T	399
HRVT0748T	398, 406	HRVT1548F	405	HRVT3036PM	409	HRVT5236E	401
HRVT0754F	405	HRVT1548FF	405	HRVT3036R	404	HRVT5236T	399
HRVT0754FF	405	HRVT1548G	403	HRVT3036T	398	HRVT5242E	401
HRVT0760F	405	HRVT1548HS3	402	HRVT3042CK	410	HRVT5242T	399
HRVT0760FF	405	HRVT1548M	408	HRVT3042E	400	HRVT5248E	401
HRVT0760T	398, 406	HRVT1548PM	409	HRVT3042G	403	HRVT5248T	399
HRVT0766F	405	HRVT1548R	404	HRVT3042HS3	402	HRVT5260E	401
HRVT0766FF	405	HRVT1548T	398	HRVT3042M	408	HRVT5260T	399
HRVT0772F	405	HRVT1548W	407	HRVT3042P	406	HRVT6024E	401
HRVT0772FF	405	HRVT1554F	405	HRVT3042PM	409	HRVT6024T	399

CROSS REFERENCE INDEX

MODEL	PAGE	MODEL	PAGE	MODEL	PAGE	MODEL	PAGE
HRVT6030E	401	HSCABD10	579, 597	HSCK36BF	596	HSCLP652418RLE	617
HRVT6030T	399	HSCACW25	596	HSCK36O	596	HSCLP652418RM	614
HRVT6036E	401	HSCACW35	596	HSCKTPS	430	HSCLP652418RME	616
HRVT6036T	399	HSCACW50	596	HSCLF501218LL	615	HSCM223018BFL	592.8
HRVT6042E	401	HSCAFD02	579, 597, 667	HSCLF501218LLE	617	HSCM223018BFM	592.7
HRVT6042T	399	HSCAFD10	579, 597, 667	HSCLF501218LM	614	HSCM223018BOL	592.8
HRVT6048E	401	HSCAHR12	596	HSCLF501218LME	616	HSCM223018BOM	592.7
HRVT6048T	399	HSCAHR15	595	HSCLF501218RL	615	HSCM223018O	592.7
HRVT6060E	401	HSCAPB	596	HSCLF501218RLE	617	HSCM223018OFL	592.8
HRVT6060T	399	HSCAUC1824	597	HSCLF501218RM	614	HSCM223018OFM	592.7
HRVTB11	499	HSCAUC1830	597	HSCLF501218RME	616	HSCM223618BFL	592.8
HRVTB1524	499	HSCAUC1836	597	HSCLF502418LL	615	HSCM223618BFM	592.7
HRVTB1530	499	HSCAWS6520	596	HSCLF502418LLE	617	HSCM223618BOL	592.8
HRVTB1536	499	HSCAWS6524	596	HSCLF502418LM	614	HSCM223618BOM	592.7
HRVTB1548	499	HSCAWS6530	596	HSCLF502418LME	616	HSCM223618BFOL	592.8
HRVTB1560	499	HSCF223018BFL	592	HSCLF502418RL	615	HSCM223618BFOM	592.7
HRVTB18	499	HSCF223018BFM	590	HSCLF502418RLE	617	HSCM223618O	592.7
HRVTB2224	499	HSCF223018BOL	592.6	HSCLF502418RM	614	HSCM223618OFL	592.8
HRVTB2230	499	HSCF223018BOM	592.3	HSCLF502418RME	616	HSCM223618OFM	592.7
HRVTB2236	499	HSCF223018LOHAT	592.2	HSCLF651218LL	615	HSCM223618RFOL	592.8
HRVTB2248	499	HSCF223018O	590	HSCLF651218LLE	617	HSCM223618RFOM	592.7
HRVTB2260	499	HSCF223018OFL	592.6	HSCLF651218LM	614	HSCP223018BFL	591
HRVTC24	388	HSCF223018OFM	592.3	HSCLF651218LME	616	HSCP223018BFM	589
HRVTC24F	388	HSCF223018ROHAT	592.2	HSCLF651218RL	615	HSCP223018BOL	592.5
HRVTC30	388	HSCF223618BFL	592	HSCLF651218RLE	617	HSCP223018BOM	592.4
HRVTC30F	388	HSCF223618BFM	590	HSCLF651218RM	614	HSCP223018LOHAT	592.1
HRVTC36	388	HSCF223618BOL	592.6	HSCLF651218RME	616	HSCP223018O	589
HRVTC36F	388	HSCF223618BOM	592.3	HSCLF652418LL	615	HSCP223018OFL	592.5
HRVTC42	388	HSCF223618BFOL	592.6	HSCLF652418LLE	617	HSCP223018OFM	592.4
HRVTC42F	388	HSCF223618BFOM	592.3	HSCLF652418LM	614	HSCP223018ROHAT	592.1
HRVTC48	388	HSCF223618LOHAT	592.2	HSCLF652418LME	616	HSCP223618BFL	591
HRVTC48F	388	HSCF223618O	590	HSCLF652418RL	615	HSCP223618BFM	589
HRVTC54	388	HSCF223618OFL	592.6	HSCLF652418RLE	617	HSCP223618BOL	592.5
HRVTC54F	388	HSCF223618OFM	592.3	HSCLF652418RM	614	HSCP223618BOM	592.4
HRVTC60	388	HSCF223618RFOL	592.6	HSCLF652418RME	616	HSCP223618BFOL	592.5
HRVTC60F	388	HSCF223618RFOM	592.3	HSCLP501218LL	615	HSCP223618BFOM	592.4
HRVTC66	388	HSCF223618ROHAT	592.2	HSCLP501218LLE	617	HSCP223618LOHAT	592.1
HRVTC66F	388	HSCF224818LBFL	592	HSCLP501218LM	614	HSCP223618O	589
HRVTC72	388	HSCF224818LBFLHAT	592.6	HSCLP501218LME	616	HSCP223618OFL	592.5
HRVTC72F	388	HSCF224818LBFOM	590	HSCLP501218RL	615	HSCP223618OFM	592.4
HRVTC78	388	HSCF224818LBFOMHAT	592.2	HSCLP501218RLE	617	HSCP223618RFOL	592.5
HRVTC78F	388	HSCF224818RBFOL	592	HSCLP501218RM	614	HSCP223618RFOM	592.4
HRVTC84	388	HSCF224818RBFOLHAT	592.6	HSCLP501218RME	616	HSCP223618ROHAT	592.1
HRVTC84F	388	HSCF224818RFOM	590	HSCLP502418LL	615	HSCP224818LBFL	591
HRVTC90	388	HSCF224818RFOMHAT	592.2	HSCLP502418LLE	617	HSCP224818LBFLHAT	592.5
HRVTC90F	388	HSCF226018LBFL	592	HSCLP502418LM	614	HSCP224818LBFOM	589
HRVTC96	388	HSCF226018LBFLHAT	592.6	HSCLP502418LME	616	HSCP224818LBFOMHAT	592.1
HRVTC96F	388	HSCF226018LBFOM	590	HSCLP502418RL	615	HSCP224818RBFOL	591
HRVTRAYM	408	HSCF226018LBFOMHAT	592.2	HSCLP502418RLE	617	HSCP224818RBFOLHAT	592.5
HRVUP24	532	HSCF226018RBFOL	592	HSCLP502418RM	614	HSCP224818RFOM	589
HRVUP30	532	HSCF226018RBFOLHAT	592.6	HSCLP502418RME	616	HSCP224818RFOMHAT	592.1
HRVUP36	532	HSCF226018RFOM	590	HSCLP651218LL	615	HSCP226018LBFL	591
HRVUP42	532	HSCF226018RFOMHAT	592.2	HSCLP651218LLE	617	HSCP226018LBFLHAT	592.5
HRVUP48	532	HSCF227218LBFL	592	HSCLP651218LM	614	HSCP226018LBFOM	589
HRVUP60	532	HSCF227218LBFLHAT	592.6	HSCLP651218LME	616	HSCP226018LBFOMHAT	592.1
HS30ABC	580	HSCF227218LBFOM	590	HSCLP651218RL	615	HSCP226018RBFOL	591
HS42ABC	580	HSCF227218LBFOMHAT	592.2	HSCLP651218RLE	617	HSCP226018RBFOLHAT	592.5
HS60ABC	580	HSCF227218RBFOL	592	HSCLP651218RM	614	HSCP226018RFOM	589
HS72ABC	580	HSCF227218RBFOLHAT	592.6	HSCLP651218RME	616	HSCP226018RFOMHAT	592.1
HS82ABC	580	HSCF227218RBFOM	590	HSCLP652418LL	615	HSCP227218LBFL	591
HSC1842	581	HSCF227218RBFOMHAT	592.2	HSCLP652418LLE	617	HSCP227218LBFLHAT	592.5
HSC1872	581	HSCK24BF	596	HSCLP652418LM	614	HSCP227218LBFOM	589
HSC2472	581	HSCK30BF	596	HSCLP652418LME	616	HSCP227218LBFOMHAT	592.1
HSCABD02	579, 597	HSCK30O	596	HSCLP652418RL	615	HSCP227218RBFOL	591

CROSS REFERENCE INDEX

MODEL	PAGE	MODEL	PAGE	MODEL	PAGE	MODEL	PAGE
HSCP227218RBFOLHAT	592.5	HSDMP489	369	HSISLAUT2PNB8418S7	655	HSLP283018FFM	594
HSCP227218RBFOM	589	HSDMP544	369	HSISLAUT2PYB4818S2	656	HSLP283618FFL	594
HSCP227218RBFOMHAT	592.1	HSDMP549	369	HSISLAUT2PYB4818S4	656	HSLP283618FFM	594
HSDBK29	368	HSDMP604	369	HSISLAUT2PYB4836S2	656	HSLRFID100C	618
HSDCDPA29L	368	HSDMP609	369	HSISLAUT2PYB4836S4	656	HSLRFID100S	618
HSDCDPA29R	368	HSDMP664	369	HSISLAUT2PYB6018S2	656	HSLRFID25C	618
HSDCMP3614	369	HSDMP669	369	HSISLAUT2PYB6018S5	656	HSLRFID25S	618
HSDCMP3629	369	HSDMP724	369	HSISLAUT2PYB6036S2	656	HSLRFID5C	618
HSDCMP4214	369	HSDMP729	369	HSISLAUT2PYB6036S5	656	HSLRFID5S	618
HSDCMP4229	369	HSDRK29	368	HSISLAUT2PYB7218S2	656	HSPMPWR-1P-2U	724
HSDCMP4814	369	HSDSL2429F	366	HSISLAUT2PYB7218S3	656	HSPAK15	620
HSDCMP4829	369	HSDSL29	367	HSISLAUT2PYB7218S6	656	HSPFF221518BFL	623
HSDCMP6014	369	HSDSL3029F	366	HSISLAUT2PYB7236S2	656	HSPFF221518BFM	620
HSDCMP6029	369	HSFCF283018BBFL	593	HSISLAUT2PYB7236S3	656	HSPFF221524BFL	623
HSDCMP7214	369	HSFCF283018BBFM	593	HSISLAUT2PYB7236S6	656	HSPFF221524BFM	620
HSDCMP7229	369	HSFCF283018OFL	592.6	HSISLAUT2PYB8418S2	656	HSPH181518BFL	622
HSDDL29	367	HSFCF283018OFM	592.3	HSISLAUT2PYB8418S7	656	HSPH181518BFM	619
HSDDPA29L	368	HSFCP283018BBFL	593	HSISLAUT2PYB8436S2	656	HSPH181524BFL	622
HSDDPA29R	368	HSFCP283018BBFM	593	HSISLAUT2PYB8436S7	656	HSPH181524BFM	619
HSDEP1129F	366	HSFCP283018OFL	592.5	HSISLAUTNPB2418S1	654	HSPH181530BFL	622
HSDEP2429F	366	HSFCP283018OFM	592.4	HSISLAUTNPB2436S1	654	HSPH181530BFM	619
HSDEP3029F	366	HSISLACB2P4842S2	658	HSISLAUTNPB3018S1	654	HSPM211518BFL	622
HSDG	367	HSISLACB2P4842S4	658	HSISLAUTNPB3036S1	654	HSPM211518BFM	619
HSDLF421218LL	615	HSISLACB2P6042S5	658	HSISLAUTNPB3618S1	654	HSPM211524BFL	622
HSDLF421218LLE	617	HSISLACB2P7242S3	658	HSISLAUTNPB3618S3	654	HSPM211524BFM	619
HSDLF421218LM	614	HSISLACB2P7242S6	658	HSISLAUTNPB3636S1	654	HSPM271518BBFL	622
HSDLF421218LME	616	HSISLACB2P8442S7	658	HSISLAUTNPB3636S3	654	HSPM271518BBFM	619
HSDLF421218RL	615	HSISLACENB1842	658	HSISLAUTNPB4218S1	654	HSPM271518FFL	622
HSDLF421218RLE	617	HSISLACESP3642	658, 659	HSISLAUTNPB4236S1	654	HSPM271518FFM	619
HSDLF421218RM	614	HSISLACEYB1842L	658	HSISLAUTNPB4818S1	654	HSPM271524BBFL	622
HSDLF421218RME	616	HSISLACEYB1842R	658	HSISLAUTNPB4818S2	654	HSPM271524BBFM	619
HSDLF651218LL	615	HSISLACEYB3642	658	HSISLAUTNPB4818S4	654	HSPM271524FFL	622
HSDLF651218LLE	617	HSISLACO3642	659	HSISLAUTNPB4836S1	654	HSPM271524FFM	619
HSDLF651218LM	614	HSISLAFB2P6042S2	658	HSISLAUTNPB4836S2	654	HSPM271530BBFL	622
HSDLF651218LME	616	HSISLAFB2P7242S2	658	HSISLAUTNPB4836S4	654	HSPM271530BBFM	619
HSDLF651218RL	615	HSISLAFB2P8442S2	658	HSISLAUTNPB6018S1	654	HSPM271530FFL	622
HSDLF651218RLE	617	HSISLAFENB1842	658	HSISLAUTNPB6018S2	654	HSPM271530FFM	619
HSDLF651218RM	614	HSISLAFESP3642	658, 659	HSISLAUTNPB6018S5	654	HSPRAY	700
HSDLF651218RME	616	HSISLAFEYB1842L	658	HSISLAUTNPB6036S1	654	HSPSF281518BBFL	623
HSDLP421218LL	615	HSISLAFEYB1842R	658	HSISLAUTNPB6036S2	654	HSPSF281518BBFM	620
HSDLP421218LLE	617	HSISLAFEYB3642	658	HSISLAUTNPB6036S5	654	HSPSF281518FFL	623
HSDLP421218LM	614	HSISLAF03642	659	HSISLAUTNPB7218S1	654	HSPSF281518FFM	620
HSDLP421218LME	616	HSISLAUTIPYB4836S2	657	HSISLAUTNPB7218S2	654	HSPSF281524BBFL	623
HSDLP421218RL	615	HSISLAUTIPYB4836S4	657	HSISLAUTNPB7218S3	654	HSPSF281524BBFM	620
HSDLP421218RLE	617	HSISLAUTIPYB6036S2	657	HSISLAUTNPB7218S6	654	HSPSF281524FFL	623
HSDLP421218RM	614	HSISLAUTIPYB6036S5	657	HSISLAUTNPB7236S1	654	HSPSF281524FFM	620
HSDLP421218RME	616	HSISLAUTIPYB7236S2	657	HSISLAUTNPB7236S2	654	HSPSF281530BBFL	623
HSDLP651218LL	615	HSISLAUTIPYB7236S3	657	HSISLAUTNPB7236S3	654	HSPSF281530BBFM	620
HSDLP651218LLE	617	HSISLAUTIPYB7236S6	657	HSISLAUTNPB7236S6	654	HSPSF281530FFL	623
HSDLP651218LM	614	HSISLAUTIPYB8436S2	657	HSISLAUTNPB8418S1	654	HSPSF281530FFM	620
HSDLP651218LME	616	HSISLAUTIPYB8436S7	657	HSISLAUTNPB8418S2	654	HSPSP281518BBFL	622
HSDLP651218RL	615	HSISLAUT2PNB2418S1	655	HSISLAUTNPB8418S7	654	HSPSP281518BBFM	619
HSDLP651218RLE	617	HSISLAUT2PNB3018S1	655	HSISLAUTNPB8436S1	654	HSPSP281518FFL	622
HSDLP651218RM	614	HSISLAUT2PNB3618S1	655	HSISLAUTNPB8436S2	654	HSPSP281518FFM	619
HSDLP651218RME	616	HSISLAUT2PNB3618S3	655	HSISLAUTNPB8436S7	654	HSPSP281524BBFL	622
HSDMP244	369	HSISLAUT2PNB4218S1	655	HSLACW50	595	HSPSP281524BBFM	619
HSDMP249	369	HSISLAUT2PNB4818S2	655	HSLACW57	595	HSPSP281524FFL	622
HSDMP304	369	HSISLAUT2PNB4818S4	655	HSLDIGMGR	618, 646	HSPSP281524FFM	619
HSDMP309	369	HSISLAUT2PNB6018S2	655	HSLDIGPRG	618, 646	HSPSP281530BBFL	622
HSDMP364	369	HSISLAUT2PNB6018S5	655	HSLF283018FFL	594	HSPSP281530BBFM	619
HSDMP369	369	HSISLAUT2PNB7218S2	655	HSLF283018FFM	594	HSPSP281530FFL	622
HSDMP424	369	HSISLAUT2PNB7218S3	655	HSLF283618FFL	594	HSPSP281530FFM	619
HSDMP429	369	HSISLAUT2PNB7218S6	655	HSLF283618FFM	594	HSQLF422418LL	615
HSDMP484	369	HSISLAUT2PNB8418S2	655	HSLP283018FFL	594	HSQLF422418LLE	617

CROSS REFERENCE INDEX

MODEL	PAGE	MODEL	PAGE	MODEL	PAGE	MODEL	PAGE
HSQLF422418LM	614	HSTF652424LFFM	602	HSTSF502424RFFM	603	HSWF421224LME	611
HSQLF422418LME	616	HSTF652424RBBFL	604	HSTSF651824LFFL	609	HSWF421224RL	612
HSQLF422418RL	615	HSTF652424RBBFM	602	HSTSF651824LFFM	607	HSWF421224RLE	613
HSQLF422418RLE	617	HSTF652424RFFL	604	HSTSF651824RFFL	609	HSWF421224RM	610
HSQLF422418RM	614	HSTF652424RFFM	602	HSTSF651824RFFM	607	HSWF421224RME	611
HSQLF422418RME	616	HSTP421824LFFL	608	HSTSF652424LBBFL	605	HSWF501218LL	612
HSQLF652418LL	615	HSTP421824LFFM	606	HSTSF652424LBBFM	603	HSWF501218LLE	613
HSQLF652418LLE	617	HSTP421824RFFL	608	HSTSF652424LFFL	605	HSWF501218LM	610
HSQLF652418LM	614	HSTP421824RFFM	606	HSTSF652424LFFM	603	HSWF501218LME	611
HSQLF652418LME	616	HSTP422424LBBFL	600	HSTSF652424RBBFL	605	HSWF501218RL	612
HSQLF652418RL	615	HSTP422424LBBFM	598	HSTSF652424RBBFM	603	HSWF501218RLE	613
HSQLF652418RLE	617	HSTP422424LFFL	600	HSTSF652424RFFL	605	HSWF501218RM	610
HSQLF652418RM	614	HSTP422424LFFM	598	HSTSF652424RFFM	603	HSWF501218RME	611
HSQLF652418RME	616	HSTP422424RBBFL	600	HSTSP421824LFFL	608	HSWF501224LL	612
HSQLP422418LL	615	HSTP422424RBBFM	598	HSTSP421824LFFM	606	HSWF501224LLE	613
HSQLP422418LLE	617	HSTP422424RFFL	600	HSTSP421824RFFL	608	HSWF501224LM	610
HSQLP422418LM	614	HSTP422424RFFM	598	HSTSP421824RFFM	606	HSWF501224LME	611
HSQLP422418LME	616	HSTP501824LFFL	608	HSTSP422424LBBFL	601	HSWF501224RL	612
HSQLP422418RL	615	HSTP501824LFFM	606	HSTSP422424LBBFM	599	HSWF501224RLE	613
HSQLP422418RLE	617	HSTP501824RFFL	608	HSTSP422424LFFL	601	HSWF501224RM	610
HSQLP422418RM	614	HSTP501824RFFM	606	HSTSP422424LFFM	599	HSWF501224RME	611
HSQLP422418RME	616	HSTP502424LBBFL	600	HSTSP422424RBBFL	601	HSWF651218LL	612
HSQLP652418LL	615	HSTP502424LBBFM	598	HSTSP422424RBBFM	599	HSWF651218LLE	613
HSQLP652418LLE	617	HSTP502424LFFL	600	HSTSP422424RFFL	601	HSWF651218LM	610
HSQLP652418LM	614	HSTP502424LFFM	598	HSTSP422424RFFM	599	HSWF651218LME	611
HSQLP652418LME	616	HSTP502424RBBFL	600	HSTSP501824LFFL	608	HSWF651218RL	612
HSQLP652418RL	615	HSTP502424RBBFM	598	HSTSP501824LFFM	606	HSWF651218RLE	613
HSQLP652418RLE	617	HSTP502424RFFL	600	HSTSP501824RFFL	608	HSWF651218RM	610
HSQLP652418RM	614	HSTP502424RFFM	598	HSTSP501824RFFM	606	HSWF651218RME	611
HSQLP652418RME	616	HSTP651824LFFL	608	HSTSP502424LBBFL	601	HSWF651224LL	612
HSTAKL	605	HSTP651824LFFM	606	HSTSP502424LBBFM	599	HSWF651224LLE	613
HSTAKR	605	HSTP651824RFFL	608	HSTSP502424LFFL	601	HSWF651224LM	610
HSTB2W1	92, 219, 266, 557	HSTP651824RFFM	606	HSTSP502424LFFM	599	HSWF651224LME	611
HSTF421824LFFL	609	HSTP652424LBBFL	600	HSTSP502424RBBFL	601	HSWF651224RL	612
HSTF421824LFFM	607	HSTP652424LBBFM	598	HSTSP502424RBBFM	599	HSWF651224RLE	613
HSTF421824RFFL	609	HSTP652424LFFL	600	HSTSP502424RFFL	601	HSWF651224RM	610
HSTF421824RFFM	607	HSTP652424LFFM	598	HSTSP502424RFFM	599	HSWF651224RME	611
HSTF422424LBBFL	604	HSTP652424RBBFL	600	HSTSP651824LFFL	608	HSWP421218LL	612
HSTF422424LBBFM	602	HSTP652424RBBFM	598	HSTSP651824LFFM	606	HSWP421218LLE	613
HSTF422424LFFL	604	HSTP652424RFFL	600	HSTSP651824RFFL	608	HSWP421218LM	610
HSTF422424LFFM	602	HSTP652424RFFM	598	HSTSP651824RFFM	606	HSWP421218LME	611
HSTF422424RBBFL	604	HSTSF421824LFFL	609	HSTSP651824RFFM	606	HSWP421218RL	612
HSTF422424RBBFM	602	HSTSF421824LFFM	607	HSTSP652424LBBFM	599	HSWP421218RLE	613
HSTF422424RFFL	604	HSTSF421824RFFL	609	HSTSP652424LFFL	601	HSWP421218RM	610
HSTF422424RFFM	602	HSTSF421824RFFM	607	HSTSP652424LFFM	599	HSWP421218RME	611
HSTF501824LFFL	609	HSTSF422424LBBFL	605	HSTSP652424RBBFL	601	HSWP421224LL	612
HSTF501824LFFM	607	HSTSF422424LBBFM	603	HSTSP652424RBBFM	599	HSWP421224LLE	613
HSTF501824RFFL	609	HSTSF422424LFFL	605	HSTSP652424RFFL	601	HSWP421224LM	610
HSTF501824RFFM	607	HSTSF422424LFFM	603	HSTSP652424RFFM	599	HSWP421224LME	611
HSTF502424LBBFL	604	HSTSF422424RBBFL	605	HSWEEPA2	302	HSWP421224RL	612
HSTF502424LBBFM	602	HSTSF422424RBBFM	603	HSWEEPA3	302	HSWP421224RLE	613
HSTF502424LFFL	604	HSTSF422424RFFL	605	HSWEEPC2	302	HSWP421224RM	610
HSTF502424LFFM	602	HSTSF422424RFFM	603	HSWEEPC3	302	HSWP421224RME	611
HSTF502424RBBFL	604	HSTSF501824LFFL	609	HSWF421218LL	612	HSWP501218LL	612
HSTF502424RBBFM	602	HSTSF501824LFFM	607	HSWF421218LLE	613	HSWP501218LLE	613
HSTF502424RFFL	604	HSTSF501824RFFL	609	HSWF421218LM	610	HSWP501218LM	610
HSTF502424RFFM	602	HSTSF501824RFFM	607	HSWF421218LME	611	HSWP501218LME	611
HSTF651824LFFL	609	HSTSF502424LBBFL	605	HSWF421218RL	612	HSWP501218RL	612
HSTF651824LFFM	607	HSTSF502424LBBFM	603	HSWF421218RLE	613	HSWP501218RLE	613
HSTF651824RFFL	609	HSTSF502424LFFL	605	HSWF421218RM	610	HSWP501218RM	610
HSTF651824RFFM	607	HSTSF502424LFFM	603	HSWF421218RME	611	HSWP501218RME	611
HSTF652424LBBFL	604	HSTSF502424RBBFL	605	HSWF421224LL	612	HSWP501224LL	612
HSTF652424LBBFM	602	HSTSF502424RBBFM	603	HSWF421224LLE	613	HSWP501224LLE	613
HSTF652424LFFL	604	HSTSF502424RFFL	605	HSWF421224LM	610	HSWP501224LM	610

CROSS REFERENCE INDEX

MODEL	PAGE	MODEL	PAGE	MODEL	PAGE	MODEL	PAGE
HSWP501224LME	611	HUSAFSM1348	694	HUSATPM2028	457, 696	HUSFABM3454	690
HSWP501224RL	612	HUSAFSM1352	694	HUSATPM2030	457, 696	HUSFABM3458	690
HSWP501224RLE	613	HUSAFSM1354	694	HUSATPM2036	457, 696	HUSFABM3460	690
HSWP501224RM	610	HUSAFSM1358	694	HUSAUPM1336	695	HUSFABM3464	690
HSWP501224RME	611	HUSAFSM1360	694	HUSAUPM1342	695	HUSFABM3466	690
HSWP651218LL	612	HUSAFSM1364	694	HUSAUPM1346	695	HUSFABM3470	690
HSWP651218LLE	613	HUSAFSM1366	694	HUSAUPM1348	695	HUSFABM3472	690
HSWP651218LM	610	HUSAFSM1370	694	HUSAUPM1352	695	HUSFEMP1342	459
HSWP651218LME	611	HUSAFSM1372	694	HUSAUPM1354	695	HUSFEMP1348	459
HSWP651218RL	612	HUSAFSM2020	694	HUSAUPM1358	695	HUSFEMP1354	459
HSWP651218RLE	613	HUSAFSM2022	694	HUSAUPM1360	695	HUSFEMP1360	459
HSWP651218RM	610	HUSAFSM2024	694	HUSAUPM1364	695	HUSFEMP1366	459
HSWP651218RME	611	HUSAFSM2028	694	HUSAUPM1366	695	HUSFEMP1372	459
HSWP651224LL	612	HUSAFSM2030	694	HUSAUPM1370	695	HUSFEMP2042	459
HSWP651224LLE	613	HUSAFSM2036	694	HUSAUPM1372	695	HUSFEMP2048	459
HSWP651224LM	610	HUSAFSM2042	694	HUSAUPM2036	695	HUSFEMP2054	459
HSWP651224LME	611	HUSAFSM2046	694	HUSAUPM2042	695	HUSFEMP2060	459
HSWP651224RL	612	HUSAFSM2048	694	HUSAUPM2046	695	HUSFEMP2066	459
HSWP651224RLE	613	HUSAFSM2052	694	HUSAUPM2048	695	HUSFEMP2072	459
HSWP651224RM	610	HUSAFSM2054	694	HUSAUPM2052	695	HUSFFSM1320	688
HSWP651224RME	611	HUSAFSM2058	694	HUSAUPM2054	695	HUSFFSM1322	688
HT48ND	356	HUSAFSM2060	694	HUSAUPM2058	695	HUSFFSM1324	688
HT60ND	356	HUSAFSM2064	694	HUSAUPM2060	695	HUSFFSM1328	688
HT66ND	356	HUSAFSM2066	694	HUSAUPM2064	695	HUSFFSM1330	688
HT72ND	356	HUSAFSM2070	694	HUSAUPM2066	695	HUSFFSM1336	688
HTCOL52	78, 170, 299, 337	HUSAFSM2072	694	HUSAUPM2070	695	HUSFFSM1342	688
HTG1PWR-3P-1B	725	HUSAGRV1348	511	HUSAUPM2072	695	HUSFFSM1346	688
HTG2PWR-3P-1E	725	HUSAGRV1360	511	HUSFABF2742	690	HUSFFSM1348	688
HTG2PWR-3P-1U-W	725	HUSAGRV1372	511	HUSFABF2746	690	HUSFFSM1352	688
HTG2PWR-3P-2B-2U	725	HUSALAT1320	695	HUSFABF2748	690	HUSFFSM1354	688
HTG2PWR-4P-2B	725	HUSALAT1322	695	HUSFABF2752	690	HUSFFSM1358	688
HTPLATEVHAU	726	HUSALAT1324	695	HUSFABF2754	690	HUSFFSM1360	688
HTWTH	531	HUSALAT1328	695	HUSFABF2758	690	HUSFFSM1364	688
HUMPWR-IP-2U	724	HUSALAT1330	695	HUSFABF2760	690	HUSFFSM1366	688
HUSAABF2746	696	HUSALAT1336	695	HUSFABF2764	690	HUSFFSM1370	688
HUSAABF2748	696	HUSALAT2020	695	HUSFABF2766	690	HUSFFSM1372	688
HUSAABF2752	696	HUSALAT2022	695	HUSFABF2770	690	HUSFFSM2020	688
HUSAABF2754	696	HUSALAT2024	695	HUSFABF2772	690	HUSFFSM2022	688
HUSAABF2758	696	HUSALAT2028	695	HUSFABF3442	690	HUSFFSM2024	688
HUSAABF2760	696	HUSALAT2030	695	HUSFABF3446	690	HUSFFSM2028	688
HUSAABF2764	696	HUSALAT2036	695	HUSFABF3448	690	HUSFFSM2030	688
HUSAABF2766	696	HUSAMOD1330	696	HUSFABF3452	690	HUSFFSM2036	688
HUSAABF2770	696	HUSAMOD1336	696	HUSFABF3454	690	HUSFFSM2042	688
HUSAABF2772	696	HUSAMOD1342	696	HUSFABF3458	690	HUSFFSM2046	688
HUSAEMP1342	460	HUSAMOD1348	696	HUSFABF3460	690	HUSFFSM2048	688
HUSAEMP1348	460	HUSAMOD1354	696	HUSFABF3464	690	HUSFFSM2052	688
HUSAEMP1354	460	HUSAMOD1360	696	HUSFABF3466	690	HUSFFSM2054	688
HUSAEMP1360	460	HUSAMOD1366	696	HUSFABF3470	690	HUSFFSM2058	688
HUSAEMP1366	460	HUSAMOD1372	696	HUSFABF3472	690	HUSFFSM2060	688
HUSAEMP1372	460	HUSASOS1322	696	HUSFABM2742	690	HUSFFSM2064	688
HUSAEMP2042	460	HUSASOS1328	696	HUSFABM2746	690	HUSFFSM2066	688
HUSAEMP2048	460	HUSASOS1334	696	HUSFABM2748	690	HUSFFSM2070	688
HUSAEMP2054	460	HUSASOS2022	696	HUSFABM2752	690	HUSFFSM2072	688
HUSAEMP2060	460	HUSASOS2028	696	HUSFABM2754	690	HUSFGRV1348	511
HUSAEMP2066	460	HUSASOS2034	696	HUSFABM2758	690	HUSFGRV1360	511
HUSAEMP2072	460	HUSATPM1320	457, 696	HUSFABM2760	690	HUSFGRV1372	511
HUSAFSM1320	694	HUSATPM1322	457, 696	HUSFABM2764	690	HUSFGRV2048	511
HUSAFSM1322	694	HUSATPM1324	457, 696	HUSFABM2766	690	HUSFGRV2060	511
HUSAFSM1324	694	HUSATPM1328	457, 696	HUSFABM2770	690	HUSFGRV2072	511
HUSAFSM1328	694	HUSATPM1330	457, 696	HUSFABM2772	690	HUSFLAT1320	689
HUSAFSM1330	694	HUSATPM1336	457, 696	HUSFABM3442	690	HUSFLAT1322	689
HUSAFSM1336	694	HUSATPM2020	457, 696	HUSFABM3446	690	HUSFLAT1324	689
HUSAFSM1342	694	HUSATPM2022	457, 696	HUSFABM3448	690	HUSFLAT1328	689
HUSAFSM1346	694	HUSATPM2024	457, 696	HUSFABM3452	690	HUSFLAT1330	689

CROSS REFERENCE INDEX

MODEL	PAGE	MODEL	PAGE	MODEL	PAGE	MODEL	PAGE
HUSFLAT1336	689	HUSGEMP2048	459	HUSGUPM2042	693	HUVABLS3024R	122
HUSFLAT2020	689	HUSGEMP2054	459	HUSGUPM2046	693	HUVABLS3030L	122
HUSFLAT2022	689	HUSGEMP2060	459	HUSGUPM2048	693	HUVABLS3030R	122
HUSFLAT2024	689	HUSGEMP2066	459	HUSGUPM2052	693	HUVABLS3624L	122
HUSFLAT2028	689	HUSGEMP2072	459	HUSGUPM2054	693	HUVABLS3624R	122
HUSFLAT2030	689	HUSGFSM1320	692	HUSGUPM2058	693	HUVABLS3630L	122
HUSFLAT2036	689	HUSGFSM1322	692	HUSGUPM2060	693	HUVABLS3630R	122
HUSFMOD1330	691	HUSGFSM1324	692	HUSGUPM2064	693	HUVAUS482413	122
HUSFMOD1336	691	HUSGFSM1328	692	HUSGUPM2066	693	HUVAUS482420	122
HUSFMOD1342	691	HUSGFSM1330	692	HUSGUPM2070	693	HUVAUS483013	122
HUSFMOD1348	691	HUSGFSM1336	692	HUSGUPM2072	693	HUVAUS483020	122
HUSFMOD1354	691	HUSGFSM1342	692	HUSLABF2746	697	HUVAUS602413	122
HUSFMOD1360	691	HUSGFSM1346	692	HUSLABF2748	697	HUVAUS602420	122
HUSFMOD1366	691	HUSGFSM1348	692	HUSLABF2752	697	HUVAUS603013	122
HUSFMOD1372	691	HUSGFSM1352	692	HUSLABF2754	697	HUVAUS603020	122
HUSFSOS1322	691	HUSGFSM1354	692	HUSLABF2758	697	HUVAUS722413	122
HUSFSOS1328	691	HUSGFSM1358	692	HUSLABF2760	697	HUVAUS722420	122
HUSFSOS1334	691	HUSGFSM1360	692	HUSLABF2764	697	HUVAUS723013	122
HUSFSOS2022	691	HUSGFSM1364	692	HUSLABF2766	697	HUVAUS723020	122
HUSFSOS2028	691	HUSGFSM1366	692	HUSLABF2770	697	HUVCFCT24	679
HUSFSOS2034	691	HUSGFSM1370	692	HUSLABF2772	697	HUVCFCT48	679
HUSFTPM1320	457, 691	HUSGFSM1372	692	HUSLGRV1348	512	HUVDPS1324	121
HUSFTPM1322	457, 691	HUSGFSM2020	692	HUSLGRV1360	512	HUVDPS1330	121
HUSFTPM1324	457, 691	HUSGFSM2022	692	HUSLGRV1372	512	HUVDPS2024	121
HUSFTPM1328	457, 691	HUSGFSM2024	692	HUSLMOD1330	697	HUVDPS2030	121
HUSFTPM1330	457, 691	HUSGFSM2028	692	HUSLMOD1336	697	HUVDRWT	678
HUSFTPM1336	457, 691	HUSGFSM2030	692	HUSLMOD1342	697	HUVDSAO1348	121
HUSFTPM2020	457, 691	HUSGFSM2036	692	HUSLMOD1348	697	HUVDSAO1360	121
HUSFTPM2022	457, 691	HUSGFSM2042	692	HUSLMOD1354	697	HUVDSAO1372	121
HUSFTPM2024	457, 691	HUSGFSM2046	692	HUSLMOD1360	697	HUVDSAO2048	121
HUSFTPM2028	457, 691	HUSGFSM2048	692	HUSLMOD1366	697	HUVDSAO2060	121
HUSFTPM2030	457, 691	HUSGFSM2052	692	HUSLMOD1372	697	HUVDSAO2072	121
HUSFTPM2036	457, 691	HUSGFSM2054	692	HUSMGRV2048	510	HUVDSHAB4813	122
HUSFUPM1336	689	HUSGFSM2058	692	HUSMGRV2060	510	HUVDSHAB4820	122
HUSFUPM1342	689	HUSGFSM2060	692	HUSMGRV2072	510	HUVDSHAB6013	122
HUSFUPM1346	689	HUSGFSM2064	692	HUSMSOS1320L	457, 698	HUVDSHAB6020	122
HUSFUPM1348	689	HUSGFSM2066	692	HUSMSOS1320R	457, 698	HUVDSHAB7213	122
HUSFUPM1352	689	HUSGFSM2070	692	HUSMSOS1326L	457, 698	HUVDSHAB7220	122
HUSFUPM1354	689	HUSGFSM2072	692	HUSMSOS1326R	457, 698	HUVDSSE1324	121
HUSFUPM1358	689	HUSGLAT1320	693	HUSMSOS2020L	457, 698	HUVDSSE1330	121
HUSFUPM1360	689	HUSGLAT1322	693	HUSMSOS2020R	457, 698	HUVDSSE2024	121
HUSFUPM1364	689	HUSGLAT1324	693	HUSMSOS2026L	457, 698	HUVDSSE2030	121
HUSFUPM1366	689	HUSGLAT1328	693	HUSMSOS2026R	457, 698	HUVDSM1324	121
HUSFUPM1370	689	HUSGLAT1330	693	HUSPEMP1342	460	HUVDSM1330	121
HUSFUPM1372	689	HUSGLAT1336	693	HUSPEMP1348	460	HUVDSM2024	121
HUSFUPM2036	689	HUSGLAT2020	693	HUSPEMP1354	460	HUVDSM2030	121
HUSFUPM2042	689	HUSGLAT2022	693	HUSPEMP1360	460	HUVFOWT	678
HUSFUPM2046	689	HUSGLAT2024	693	HUSPEMP1366	460	HUVHEWT	678
HUSFUPM2048	689	HUSGLAT2028	693	HUSPEMP1372	460	HUVLSWT	678
HUSFUPM2052	689	HUSGLAT2030	693	HUSPEMP2042	460	HUVMAWT	678
HUSFUPM2054	689	HUSGLAT2036	693	HUSPEMP2048	460	HUVMAWT24	679
HUSFUPM2058	689	HUSGUPM1336	693	HUSPEMP2054	460	HUVMAWT48	679
HUSFUPM2060	689	HUSGUPM1342	693	HUSPEMP2060	460	HUVMBHS48	679
HUSFUPM2064	689	HUSGUPM1346	693	HUSPEMP2066	460	HUVMBHS96	679
HUSFUPM2066	689	HUSGUPM1348	693	HUSPEMP2072	460	HUVMMFS55	680
HUSFUPM2070	689	HUSGUPM1352	693	HUSPGRV2048	510	HUVMMFS63	680
HUSFUPM2072	689	HUSGUPM1354	693	HUSPGRV2060	510	HUVPAWT	678
HUSGEMP1342	459	HUSGUPM1358	693	HUSPGRV2072	510	HUVREW	678
HUSGEMP1348	459	HUSGUPM1360	693	HUVAHS	679	HUVSLFS3254L	681
HUSGEMP1354	459	HUSGUPM1364	693	HUVABLS2424L	122	HUVSLFS3254LC	681
HUSGEMP1360	459	HUSGUPM1366	693	HUVABLS2424R	122	HUVSLFS3259L	681
HUSGEMP1366	459	HUSGUPM1370	693	HUVABLS2430L	122	HUVSLFS3259LC	681
HUSGEMP1372	459	HUSGUPM1372	693	HUVABLS2430R	122	HUVSLFS3267L	681
HUSGEMP2042	459	HUSGUPM2036	693	HUVABLS3024L	122	HUVSLFS3267LC	681

CROSS REFERENCE INDEX

MODEL	PAGE	MODEL	PAGE	MODEL	PAGE	MODEL	PAGE
HUVSLFS4054L	681	HWR1824P	541	HWV95BARP	548	HWWT2260F	236
HUVSLFS4054LC	681	HWR1830P	541	HWV95BBLP	547	HWWT3018F	237
HUVSLFS4059L	681	HWR1836P	541	HWV95BBRP	548	HWWT3018L	239
HUVSLFS4059LC	681	HWR1842P	541	HWWAC	244	HWWT3018P	241
HUVSLFS4067L	681	HWR1848P	541	HWWAH	244	HWWT3024F	237
HUVSLFS4067LC	681	HWR1854P	541	HWWAP	244	HWWT3024L	239
HUVSLFS4754L	681	HWR1860P	541	HWWAPH	244	HWWT3024P	241
HUVSLFS4754LC	681	HWR1866P	541	HWWARAIL18	243	HWWT3030F	237
HUVSLFS4759L	681	HWR1872P	541	HWWARAIL24	243	HWWT3030L	239
HUVSLFS4759LC	681	HWR2424P	541	HWWARAIL30	243	HWWT3030M	238
HUVSLFS4767L	681	HWR2430P	541	HWWARAIL36	243	HWWT3030P	241
HUVSLFS4767LC	681	HWR2436P	541	HWWARAIL42	243	HWWT3036F	237
HUVSSWT	678	HWR2436PN	453	HWWARAIL48	243	HWWT3036L	239
HUVSTAHS	679	HWR2442P	541	HWWARAIL54	243	HWWT3036M	238
HUVSTAHS	679	HWR2448P	541	HWWARAIL60	243	HWWT3036P	241
HUVSTAHS	679	HWR2448PN	453	HWWASB	244	HWWT3036V	240
HUVSTBHS	679	HWR2454P	541	HWWASHELF18	243	HWWT3042F	237
HUVSTBHS	679	HWR2460P	541	HWWASHELF24	243	HWWT3042V	240
HUVSTBHS	679	HWR2460PN	453	HWWASHELF30	243	HWWT3048F	237
HUVTOWT	678	HWR2466P	541	HWWASHELF36	243	HWWT3048V	240
HUVTOWT24	679	HWR2472P	541	HWWAST	244	HWWT3054F	237
HUVTOWT48	679	HWR2472PN	453	HWWATS	244	HWWT3060F	237
HUVTRWT	678	HWR2484P	541	HWWT1518F	236	HWWT3718F	237
HUVVWWT	678	HWR3024P	542	HWWT1518L	239	HWWT3718L	239
HV-UT1	560, 671, 717	HWR3030P	542	HWWT1518P	241	HWWT3724F	237
HVFB20R	560	HWR3036P	542	HWWT1524F	236	HWWT3724L	239
HVFB23R	560	HWR3042P	542	HWWT1524L	239	HWWT3730F	237
HVFF20R	560	HWR3048P	542	HWWT1524P	241	HWWT3730L	239
HVFF23R	560	HWR3048PN	453	HWWT1524T	242	HWWT3730M	238
HVPWLBK24	92, 266	HWR3054P	542	HWWT1530F	236	HWWT3736F	237
HVPWLBK30	92, 266	HWR3060P	542	HWWT1530L	239	HWWT3736L	239
HWC3624P	544	HWR3060PN	453	HWWT1530M	238	HWWT3736M	238
HWC4224P	544	HWR3066P	542	HWWT1530P	241	HWWT3736V	240
HWC4230P	544	HWR3072P	542	HWWT1530T	242	HWWT3742F	237
HWC4824P	544	HWR3072PN	453	HWWT1536F	236	HWWT3742M	238
HWC4830P	544	HWR3084P	542	HWWT1536L	239	HWWT3742V	240
HWC72	581	HWSA2	556	HWWT1536M	238	HWWT3748F	237
HWCS3624P	545	HWSB2	556	HWWT1536P	241	HWWT3748M	238
HWCS4224P	545	HWSR24	557	HWWT1536T	242	HWWT3748V	240
HWCS4230P	545	HWSR30	557	HWWT1542F	236	HWWT3754F	237
HWCS4824P	545	HWSR36	557	HWWT1542T	242	HWWT3754M	238
HWCS4830P	545	HWSR42	557	HWWT1548F	236	HWWT3754V	240
HWD244830P	543	HWSR48	557	HWWT1548T	242	HWWT3760F	237
HWD245430P	543	HWV73AALP	547	HWWT1554F	236	HWWT3760M	238
HWD246030P	543	HWV73AARP	548	HWWT1554T	242	HWWT4518F	237
HWD246630P	543	HWV73BALP	547	HWWT1560F	236	HWWT4518L	239
HWD247230P	543	HWV73BARP	548	HWWT1560T	242	HWWT4524F	237
HWD304824P	543	HWV75AALP	547	HWWT2218F	236	HWWT4524L	239
HWD305424P	543	HWV75AARP	548	HWWT2218L	239	HWWT4530F	237
HWD306024P	543	HWV75ABLP	547	HWWT2218P	241	HWWT4530L	239
HWD306624P	543	HWV75ABRP	548	HWWT2224F	236	HWWT4530M	238
HWD307224P	543	HWV75BALP	547	HWWT2224L	239	HWWT4536F	237
HWJ58ABLP	549	HWV75BARP	548	HWWT2224P	241	HWWT4536L	239
HWJ58ABRP	549	HWV75BBLP	547	HWWT2230F	236	HWWT4536M	238
HWJ59ABLP	549	HWV75BBRP	548	HWWT2230L	239	HWWT4536V	240
HWJ59ABRP	549	HWV93AALP	547	HWWT2230M	238	HWWT4542F	237
HWMCLIPLG	265, 727	HWV93AARP	548	HWWT2230P	241	HWWT4542M	238
HWMCLIPSM	727	HWV93BALP	547	HWWT2236F	236	HWWT4542V	240
HWP2460P	549	HWV93BARP	548	HWWT2236L	239	HWWT4548F	237
HWP2466P	549	HWV95AALP	547	HWWT2236M	238	HWWT4548M	238
HWP2472P	549	HWV95AARP	548	HWWT2236P	241	HWWT4548V	240
HWP3060P	549	HWV95ABLP	547	HWWT2242F	236	HWWT4554F	237
HWP3066P	549	HWV95ABRP	548	HWWT2248F	236	HWWT4554M	238
HWP3072P	549	HWV95BALP	547	HWWT2254F	236	HWWT4554V	240

CROSS REFERENCE INDEX

MODEL	PAGE	MODEL	PAGE	MODEL	PAGE	MODEL	PAGE
HWWT4560F	237	HWWT730P	241	HWWT754F	236	SPLH-ABND-GALGLSS.M482177	493
HWWT4560M	238	HWWT730T	242	HWWT754T	242	SPLH-ABND-GALGLSS.M482178	493
HWWT718F	236	HWWT736F	236	HWWT760F	236	SPLH-ABND-GALGLSS.M482179	493
HWWT718L	239	HWWT736L	239	HWWT760T	242	SPLH-ABND-GALGLSS.M482180	493
HWWT718P	241	HWWT736P	241	SPLH-ABND-GALGLSS.M482171	493	SPLH-ABND-GALGLSS.M482181	493
HWWT724F	236	HWWT736T	242	SPLH-ABND-GALGLSS.M482172	493	SPLH-ABND-GALGLSS.M482182	493
HWWT724L	239	HWWT742F	236	SPLH-ABND-GALGLSS.M482173	493	SPLH-ABND-GALGLSS.M482183	493
HWWT724P	241	HWWT742T	242	SPLH-ABND-GALGLSS.M482174	493	SPLH-ABND-GALGLSS.M540464	493
HWWT724T	242	HWWT748F	236	SPLH-ABND-GALGLSS.M482175	493	SPLH-ABND-GALGLSS.M540465	493
HWWT730F	236	HWWT748T	242	SPLH-ABND-GALGLSS.M482176	493	SPLH-ABND-GALGLSS.M541046	493
HWWT730L	239						

NOTES

NOTES

INFORMATION ON ORDERING PARTS

When parts are needed to repair HON products, the following guidelines should be followed to expedite the process.

1. Warranty orders are submitted on HON Ready via the Quick Claim tool.
2. There are no discounts applied to parts. Pricing quoted is the net value. Parts pricing is subject to change without notice.
3. For a part not covered by warranty applicable shipping charges will apply.
4. All keys are \$6.00 each plus a shipping and handling fee of \$3.00 per shipping location.
5. Parts may be paid for with an approved credit card. Approved Cards: MasterCard, VISA and American Express.
6. Payment terms for invoiced parts are Net 30 days.
7. Due to short leadtimes on parts, no changes will be accepted after the order has been placed.
8. When placing a **warranty** parts order:

If the product is under warranty, the product serial number must be provided. Most finished goods products have a serial number placed on them at the factory. The label containing the serial number is located:

Vertical Files — right side of the uppermost drawer

Lateral Files — left side of the uppermost drawer or shelf

Desk Towers — outside of top drawer

Desks, Credenzas, & Returns — on the outside, kneespace side of the top drawer. Fully extend the drawer to find it.

Desks, Credenzas, Corner Units, Bridges, Peninsulas & Returns without drawers — underside of top

Tables and Stands — underside of the top

Table Trucks — underside of side rail

Cabinets & Bookcases — left inner side of the case

Modular Component Top and Backs — underside of top

Modular End Panels — top inside surface

Reception Stations — top inside surface of back panel

Organizers — top inside surface of left end panel near back panel

Vertical Paper Manager — back panel inside surface near top

Pedestals — bottom drawer right side exterior

Seating — underside of the seat

Panels — underside of the top cap

Hutches, Storage Units, Overhead Storage — underside of the shelf

Hanging Bookshelves — underside of shelf

NOTE: Removal of the serial number tag from the product voids the warranty.

An important note regarding Product Serial Numbers:

HON desks, tables, chairs, files and systems components are tagged with a serial number. This number helps us identify *when and where your product was made*, and to identify and correct the root causes for the problem. **NEITHER THE DEALER NOR THE CONSUMER SHOULD REMOVE THIS TAG UNDER ANY CIRCUMSTANCES.** To do so immediately voids your Warranty coverage for that particular item *and prevents us from further identifying it.* Instead, please transcribe the number and call your Dealer.