

PRICING EFFECTIVE FEBRUARY 2024

SEATING & OCCASIONAL TABLES

Price & Specification Guide

PDF updated May 6, 2024

Gunlocke®

ORDERING OPTION CODES

MAPLE WOOD FINISHES

- A. Natural/Clear Maple 800
- B. Ebony Maple 555
- C. Harvest Maple 856
- D. Beigewood 878
- E. Field Elm 599
- F. Belair 934

*All Finish options are also available with FSC

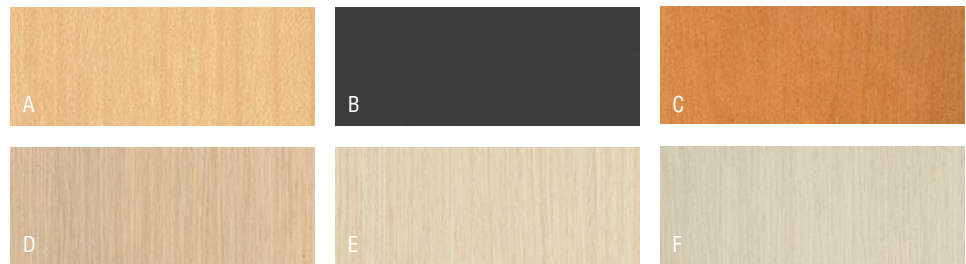

CHERRY WOOD FINISHES

- A. Natural Cherry 222
- B. Light Cherry 701
- C. Cinnamon Cherry 260
- D. Burnished Cherry 777
- E. Medium Red Cherry 512
- F. Lowell Ash 394
- G. Shaker Cherry 774

*All Finish options are also available with FSC



WALNUT WOOD FINISHES

- A. Nutmeg Walnut 629
- B. Light Walnut 601
- C. Sumatra Walnut 693
- D. Skyline Walnut 625
- E. Pinnacle Walnut 679
- F. Florence Walnut 579

*All Finish options are also available with FSC

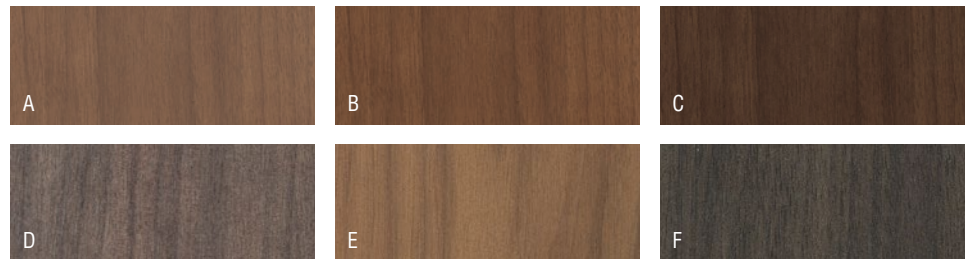

OAK WOOD FINISHES

- A. Natural/Clear Oak 300
- B. Light Rift Oak 301
- C. Dark Rift Oak 331
- D. Phantom Ecu 912
- E. Portico Teak 150
- F. Silver Oak 100
- G. Fawn Cypress 108

*All Finish options are also available with FSC



LAMINATES (AVAILABLE ON LIV SEATING AND CALM OCCASIONAL TABLES)

WOODGRAIN

- | | |
|---------------------|------|
| A. Lowell Ash | LLA1 |
| B. Natural Recon | LNR1 |
| C. Phantom Ecru | LPE1 |
| D. Portico Teak | LPT1 |
| E. Skyline Walnut | LSW1 |
| F. Beigewood | LWBE |
| G. Field Elm | LWFE |
| H. Pinnacle Walnut | PINC |
| I. Fawn Cypress | LFC1 |
| J. Natural Maple | LWD |
| K. Harvest Maple | C |
| L. Shaker Cherry | LW7C |
| M. Biltmore Cherry | COGN |
| N. Florence Walnut | LFW1 |
| O. Kingswood Walnut | LK11 |
| P. NeoWalnut | LNU1 |
| Q. Veranda Teak | LVT1 |

SOLID

- | | |
|-------------------------|------|
| R. Designer White 15051 | LDW1 |
| S. Loft | LM11 |
| T. Flint | LM16 |
| U. Black | P |



PAINT FINISHES

- | | |
|-------------------|-----|
| A. Designer White | PJW |
| B. Chrome | PC |
| C. Silver | PR6 |
| D. Titanium | P8T |
| E. Solar Black | P8X |
| F. Black | P71 |
| G. Pyrite | PJE |
| H. Matte Gold | P8G |
| I. Bullseye | PJF |
| J. Regatta | P8M |

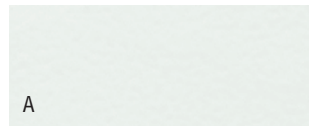

Product Reference
Products in Numerical Order 2-3
Abridged Picture Index 4-5

General Information
GSA Terms And Conditions 6
Conditions of Sale 7
Warranty 8
Shipping Instructions 9

Special Finish and Laser Backs 10

Standard Textile and COM Overview 11-12

COM | COL Guidelines / Ordering 13-14

Cut Yardage | Requirements 15

Flammability | ACT Performance 16

Fabric Matrix 18-21

PRODUCTS

Guest Seating 23-39
Product Specifications 24-25
Bank of England™ 26
Calia 27-28
Camille 29-30
Genesee Guest 31-32
Lily™ 33
Metta 34-35
Savor™ 36-37
Tia™ Guest 38-39

Multipurpose Seating 41-61
Product Specifications 42
Convo® Barstool 43-46
LIV Guest 47-48
LIV Stool 49-50
Multi® 51-54
Multi® Stool 55
Multi® Bariatric 56-57
Tia™ Barstool 58-59
Trillia™ Barstool 60-61

Swivel Seating 63-79
Swivel Seating Product Specifications 64-67
Avoca™ 68-69
Genesee 70-72
Geneva 73-74
Olla Executive 75-78
Washington Series 79

Lounge Seating 81-171
Product Specifications 82
Calm Lounge Ordering Option Codes 84-85
Calm 86-104
Ciji 105-165
Iris 166-171

Occasional Tables 173-180
Briefing 174
Calm 175-177
Cylinder 178
Cube 179
Letchworth 180



PRODUCTS IN NUMERICAL ORDER

Seating
02/24

product	page	product	page	product	page
ACPUNDER-EU Calm	104	GK1105-1W Ciji	109	GK1133 Ciji	163
ACPUNDER-EU-HW Calm	104	GK1105-2A Ciji	118	GK1137 Ciji	163
GABTRT17H2454-WW Letchworth	180	GK1105-2W Ciji	117	GK1139 Ciji	164
GABTRT17H3636-WW Letchworth	180	GK1105-3A Ciji	126	GK1143 Ciji	164
GABTRT17H4242-WW Letchworth	180	GK1105-3W Ciji	125	GK1145R Ciji	164
GABTRT21H2424-WW Letchworth	180	GK1107-1A Ciji	112	GK1155 Ciji	165
GAGB17-198 Calm	104	GK1107-1W Ciji	111	GK1157 Ciji	165
GBGB17-131 Calm	100	GK1107-2A Ciji	120	GK1159 Ciji	165
GBGB17-142 Calm	101	GK1107-2W Ciji	119	GK1161 Ciji	165
GBGB17-153 Calm	102	GK1107-3A Ciji	128	GK1163 Ciji	165
GGCA14-011 Lily	33	GK1107-3W Ciji	127	GK2800 Olla	75
GGCAL17-011 Calia	27	GK1109A Ciji	154	GK2802 Olla	76
GGCAL17-021 Calia	28	GK1109W Ciji	153	GK2804 Olla	75
GGHB17-071 Tia	38	GK1111-1A Ciji	130	GK2806 Olla	76
GGHB17-081 Tia	39	GK1111-1W Ciji	129	GK2808 Olla	77
GGJA14-011 Savor	36	GK1111-2A Ciji	138	GK2810 Olla	78
GGJA14-021 Savor	36	GK1111-2W Ciji	137	GK2812 Olla	77
GGJA14-031 Savor	37	GK1111-3A Ciji	146	GK2814 Olla	78
GGLIV19-011 Liv	47	GK1111-3W Ciji	145	GK3006N Washington	79
GGLIV19-012 Liv	47	GK1113-1A Ciji	132	GK8907 Molti	51
GGLIV19-013 Liv	47	GK1113-1W Ciji	131	GK9901P Molti	52
GGLIV19-014 Liv	47	GK1113-2A Ciji	140	GK9901W Molti	53
GGLIV19-021 Liv	48	GK1113-2W Ciji	139	GK9903N Molti	51
GGLIV19-022 Liv	48	GK1113-3A Ciji	148	GK9905P Molti	54
GGLIV19-023 Liv	48	GK1113-3W Ciji	147	GK9905W Molti	54
GGLIV19-024 Liv	48	GK1115-1A Ciji	134	GK9907N Molti	54
GGLIV19-SVL1 Liv	42	GK1115-1W Ciji	133	GK9923N Molti	55
GGLIV19-SVL2 Liv	42	GK1115-2A Ciji	142	GK9947 BOE	26
GGRA16-111 Genesee	31	GK1115-2W Ciji	141	GK9947US BOE	26
GGRA16-121 Genesee	31	GK1115-3A Ciji	150	GK9961P Molti	56
GGRA16-141 Genesee	32	GK1115-3W Ciji	149	GK9961W Molti	57
GGWA16-011 Metta	34	GK1117-1A Ciji	136	GK21001 Camille	29
GGWA16-021 Metta	35	GK1117-1W Ciji	135	GK21003 Camille	29
GK1101-1A Ciji	106	GK1117-2A Ciji	144	GK21003-021 Camille	30
GK1101-1W Ciji	105	GK1117-2W Ciji	143	GLGB17-011 Calm	86
GK1101-2A Ciji	114	GK1117-3A Ciji	152	GLGB17-021 Calm	87
GK1101-2W Ciji	113	GK1117-3W Ciji	151	GLGB17-031 Calm	88
GK1101-3A Ciji	122	GK1119A Ciji	156	GLGB17-041 Calm	89
GK1101-3W Ciji	121	GK1119W Ciji	155	GLGB17-052 Calm	90
GK1103-1A Ciji	108	GK1121-1A Ciji	158	GLGB17-062 Calm	91
GK1103-1W Ciji	107	GK1121-1W Ciji	157	GLGB17-072 Calm	92
GK1103-2A Ciji	116	GK1121-2A Ciji	160	GLGB17-082 Calm	93
GK1103-2W Ciji	115	GK1121-2W Ciji	159	GLGB17-093 Calm	94
GK1103-3A Ciji	124	GK1121-3A Ciji	162	GLGB17-103 Calm	95
GK1103-3W Ciji	123	GK1121-3W Ciji	161	GLGB17-113 Calm	96
GK1105-1A Ciji	110	GK1131 Ciji	163	GLGB17-123 Calm	97

product	page	product	page	product	page
GLGB17-161 Calm	98	GMQA16-021 Trillia	61	GTGB17-2424H24-S Calm	177
GLGB17-171 Calm	99	GMQA16-041 Trillia	60	GTGB17-2424H24-W Calm	177
GLGB17-181 Calm	103	GMQA16-051 Trillia	61	GTGB17-3225H17-F Calm	175
GLIRS17-011 Iris	166	GMQA16-071 Trillia	60	GTGB17-3225H17-G Calm	175
GLIRS17-021 Iris	167	GMQA16-081 Trillia	61	GTGB17-3225H17-L Calm	175
GLIRS17-031 Iris	166	GNTOCB1824 Tables	179	GTGB17-3225H17-S Calm	175
GLIRS17-041 Iris	168	GNTOCB2420 Tables	179	GTGB17-3225H17-W Calm	175
GLIRS17-051 Iris	169	GNTOCB2424 Tables	179	GTGB17-3232H17-F Calm	175
GLIRS17-061 Iris	170	GNTOCB3616 Tables	179	GTGB17-3232H17-G Calm	175
GLIRS17-071 Iris	169	GNTOCY1820 Tables	178	GTGB17-3232H17-L Calm	175
GLIRS17-081 Iris	171	GNTOCY1824 Tables	178	GTGB17-3232H17-S Calm	175
GM2ETRD18H24-L Briefing	174	GNTOCY2420 Tables	178	GTGB17-3232H17-W Calm	175
GM2ETRD18H24-S Briefing	174	GNTOCY2424 Tables	178	GTGB17-3250H17-F Calm	175
GM2ETRD18H24-W Briefing	174	GNTOCY3616 Tables	178	GTGB17-3250H17-G Calm	175
GM2LTRD18H24-L Briefing	174	GSGNV17-011 Geneva	73	GTGB17-3250H17-L Calm	175
GM2LTRD18H24-S Briefing	174	GSGNV17-031 Geneva	74	GTGB17-3250H17-S Calm	175
GM2LTRD18H24-W Briefing	174	GSGNV17-051 Geneva	73	GTGB17-3250H17-W Calm	175
GM2NTRD18H19-L Briefing	174	GSGNV17-071 Geneva	74		
GM2NTRD18H19-S Briefing	174	GSHA15-011 Avoca	68		
GM2NTRD18H19-W Briefing	174	GSHA15-021 Avoca	68		
GM2NTRD30H15-L Briefing	174	GSHA15-031 Avoca	69		
GM2NTRD30H15-S Briefing	174	GSHA15-041 Avoca	69		
GM2NTRD30H15-W Briefing	174	GSRA16-011 Genesee	70		
GM2NTRS1824H17-L Briefing	174	GSRA16-021 Genesee	70		
GM2NTRS1824H17-S Briefing	174	GSRA16-031 Genesee	71		
GM2NTRS1824H17-W Briefing	174	GSRA16-041 Genesee	71		
GMBTRT17H2454-WW Letchworth	180	GSRA16-051 Genesee	72		
GMBTRT17H3636-WW Letchworth	180	GSRA16-061 Genesee	72		
GMBTRT17H4242-WW Letchworth	180	GTGB17-1218H26-F Calm	177		
GMBTRT21H2424-WW Letchworth	180	GTGB17-1218H26-G Calm	177		
GMBTRT36H2060-WW Letchworth	180	GTGB17-1218H26-L Calm	177		
GMHB17-011 Tia	58	GTGB17-1218H26-S Calm	177		
GMHB17-041 Tia	59	GTGB17-1218H26-W Calm	177		
GMLA15-011 Convo	43	GTGB17-1632H17-F Calm	176		
GMLA15-021 Convo	45	GTGB17-1632H17-G Calm	176		
GMLA15-041 Convo	44	GTGB17-1632H17-L Calm	176		
GMLA15-051 Convo	46	GTGB17-1632H17-S Calm	176		
GMLIV19-031 Liv	49	GTGB17-1632H17-W Calm	176		
GMLIV19-032 Liv	49	GTGB17-1650H17-F Calm	176		
GMLIV19-033 Liv	49	GTGB17-1650H17-G Calm	176		
GMLIV19-034 Liv	49	GTGB17-1650H17-L Calm	176		
GMLIV19-041 Liv	50	GTGB17-1650H17-S Calm	176		
GMLIV19-042 Liv	50	GTGB17-1650H17-W Calm	176		
GMLIV19-043 Liv	50	GTGB17-2424H24-F Calm	177		
GMLIV19-044 Liv	50	GTGB17-2424H24-G Calm	177		
GMQA16-011 Trillia	60	GTGB17-2424H24-L Calm	177		

GUEST SEATING

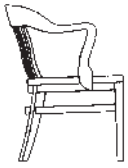

GK9947
Bank of England (pg. 26)

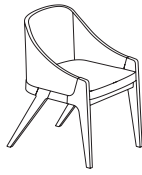

GGCAL17-011
Calia (pg. 27)

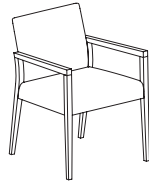

GK21001
Camille (pg. 29)



GGRA16-141
Genesee (pg. 32)

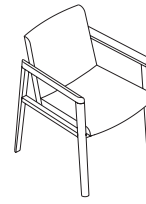

GGCA14-011
Lily (pg. 33)



GGLIV19-023
LIV (pg. 48)



GGWA16-011
Metta (pg. 34)

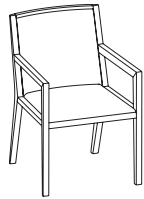

GGJA14-011
Savor (pg. 36)



GGHB17-071
Tia (pg. 38)

MULTIPURPOSE SEATING



GMLA15-011
Convo Barstool
(pg. 43)



GGLIV19-013
LIV Stacker
(pg. 47)



GGLIV19-043
LIV Stool
(pg. 50)



GK9901P
Molti (pg. 52)

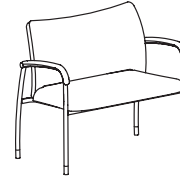

GK9961P
Multi Bariatric
(pg. 56)



GK9923N
Multi Stool (pg. 55)

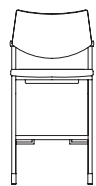

GMHB17-011
Tia Barstool (pg. 58)



GMQA16-011
Trillia Barstool (pg. 60)

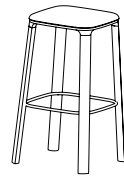

SWIVEL SEATING



GSHA15-031
Avoca (pg. 69)



GSR16-031
Genesee (pg. 71)



GSGNV17-011
Geneva (pg. 73)



GK2800
Olla (pg. 75)



GK3006N
Washington (pg. 79)

LOUNGE SEATING

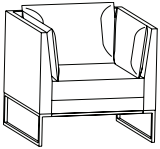

GLGB17-011
Calm (pg. 86)

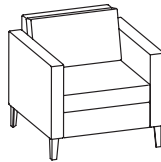

GK1111-1W
Ciji (pg. 129)



GLIRS17-011
Iris (pg. 166)

OCCASIONAL TABLES

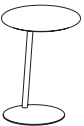

GM2LTRD18H24
Briefing (pg. 174)



GTGB17-3225H17
Calm (pg. 175)

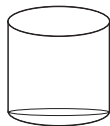

GNTOCY1820
Cylinder (pg. 178)

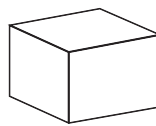

GNTOCB1824
Cube (pg. 179)

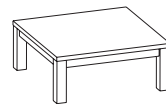

GABTRT21H2424-WW
Letchworth (pg. 180)

GSA/FEDERAL CONTRACT INFORMATION:

Model numbers identified with the following verbiage “When purchased separately without a configurable TAA compliant end product, not on GSA contract” is to mean that these configurable parts or components:

- Have no functionality or capability without being integrated into an end product; and
- Are considered Open Market if purchased without a configurable TAA compliant end product.

ITEMS ON GSA CONTRACT

Please note, in order to verify if an item is on GSA Contract or is “Open Market,” please use Compass quoting which is updated in real time with all GSA contract changes. If you need additional assistance, please contact your local sales representative.

INTRODUCTION

The Gunlocke Company is dedicated to providing the finest possible products and service. This price list reflects that commitment. Included is a current listing of our seating models.

Casegoods are presented in a separate price lists. Contact your Gunlocke Customer Services Representative for more information. (800) 828-6300

Designed for easy use, each page of this price list provides all information required to order a product correctly. Should additional information be needed, contact your Gunlocke Customer Service representative.

PRICING

Prices shown covers standard products. Any changes or alterations, other than those listed, will be subject to an additional charge. Prices include cartoning and freight. Contact the Gunlocke Tailored Solutions at gunts@gunlocke.com to request custom quotes. Authorization and pricing must be secured in advance for orders or contracts calling for large quantities, indefinite quantities, or extended delivery dates.

ORDERING

Orders submitted electronically will receive priority service and shorter overall lead times. You can submit your orders electronically via traditional EDI (Electronic Data Interchange), by e-commerce at Gunlocke.com using your XML and SIF files.

Orders in the amount of \$75,000 list or larger will require a XML or SIF file to be e-mailed to our order entry department at gunlockeoe@gunlocke.com.

Orders under \$75,000 list do not require an XML or SIF file and can be e-mailed to our order entry department at gunlockeoe@gunlocke.com, faxed to 585-728-8350, or mailed to:

The Gunlocke Company
Attn: Order Entry
One Gunlocke Drive
Wayland, New York 14572

ORDER CHANGES

Gunlocke is not required to accept changes in orders after confirmation. Reasonable changes are subject to additional charges for labor, material and administrative costs.

Order changes of acknowledgment may result in re-scheduling of product.

ACKNOWLEDGMENT

Each order will be acknowledged by Gunlocke. Customers should check each acknowledgment for accuracy and immediately notify Gunlocke of any discrepancies.

This printed acknowledgment is the final agreement between The Gunlocke Company and the customer, superseding all previous communications regarding the order.

SPECIFICATION CHANGES

Gunlocke reserves the right to change specifications for the improvement of products at any time, without notice.

RETURNED MERCHANDISE

No merchandise may be returned without prior authorization.

SHOWROOMS

For all showroom locations and tour information, please reference the showrooms page online at: www.gunlocke.com/inspiration/showrooms

CANCELLATIONS

Cancellations of orders cannot be accepted since every order is manufactured according to customer's specifications.

STORAGE

If delivery cannot be made and products are ready, Gunlocke will transfer products to a storage facility of the customers choice and products will be invoiced at this time. The customer is responsible for storage charges as well and assumes and bears all risks associated with the storage of that product.

TERMS

Net 30 days from date of invoice. A service charge of eighteen percent (18%) per year or .0004931 per day, compounded monthly, will be added to balance due beyond the thirtieth day. Products are shipped **FOB factory, freight prepaid and allowed.**

Title passes to purchaser and Gunlocke's responsibility ceases when shipment is accepted for transportation by a carrier. A full explanation of all payment terms is found on order and invoice forms.

12 YEAR WARRANTY

Subject to the limitations set forth below. The Gunlocke Company warrants to the original purchaser all product in this price list to be free from defects in material and workmanship for a twelve year period from the date of shipment.

This **12-year warranty** applies to all products sold and installed by a Gunlocke authorized agent for normal commercial single shift service. Gunlocke will repair, or at its option, replace defective merchandise, free of charge. The following components not manufactured by Gunlocke have the following warranties:

- **High wear components** Such as casters and glides are warranted for five years after date of shipment to original owner.
- **Seating control mechanisms** are warranted for five years after date of shipment to original owner.
- **Fabric and leather** are warranted for three years if single-shift and normal use after shipment to original owner.

Any non-standard material selected by the customer is not warranted. Neither does this warranty apply to damage resulting from accident, alteration, or misuse, as well as damage from normal wear and tear such as dents, nicks, scratches, fading and improper maintenance. That is, Gunlocke's warranty is only valid if products are given proper use and care. Gunlocke assumes no responsibility for product damages resulting from improper installation or user modification.

WOOD FURNITURE

Wood owes its inherent beauty to variations in color, grain, and texture, and therefore, these variations are not considered defects. There may be minor variations from one piece of furniture to the next even though they are finished at the same time. Exposure to light and the aging process will cause a darkening of natural wood products. Light finishes on wood products do not mask the natural characteristics of wood.

The Gunlocke Company does not guarantee the exact matching of grain, pattern, and color. Gunlocke offers 800 a natural maple finish on maple, 222 a natural cherry on maple, 701 a light cherry finish on cherry or maple, 629 nutmeg walnut on walnut or maple, and 601 light walnut on walnut or maple. These finishes do not cover any of the natural characteristics of the wood, including nature's colorations, pitch pockets, and the variations of steambent wood. Merchandise will not be replaced because of these natural variations.

It is expressly understood and agreed that the buyer's sole and exclusive remedy for any and all losses or damages resulting from nonconforming goods, or from any other cause, shall be repair or replacement of defective parts, and that Gunlocke shall not be liable for damages or injury to persons or property, nor for replacement of the entire commercial unit, if repair or replacement of defective parts can reasonably render the unit conforming.

All warranty claims must be submitted in writing by the original owner via our website.

Owner may be required to produce the invoice or other evidence to establish that a claim is within the warranty period.

As stated and illustrated on the website, serial numbers are required to process a warranty claim. No person, firm, or corporation is authorized to assume for Gunlocke any liability in connection with the sale or installation of Gunlocke products except as stated above.

All other warranties, expressed or implied, are excluded. Gunlocke shall not be liable for incidental or consequential damages of any sort.

Within the Continental USA, all orders above \$20,000 list are shipped FOB factory, freight prepaid and allowed. All orders less than \$20,000 list will be subject to a \$200 net freight charge. Products shipped to Alaska and Hawaii FOB factory, freight prepaid and allowed to port of embarkation. Customer is responsible for freight charges from port of embarkation to final destination.

An anticipated shipping date is indicated on the order acknowledgment. Gunlocke cannot accept responsibility for shipping delays caused by outside sources or unforeseen problems. Delay of shipments requested by customers must be approved by Gunlocke. Any resultant storage charges will be charged to the customer.

Gunlocke may await completion of the entire order and ship all at once or may make partial shipments from time to time at its sole discretion unless the customer requests in writing that partial shipments are needed and Gunlocke approves the specific shipping schedule. Additional charges may apply.

Gunlocke is not liable for any delay or failure to deliver or perform due to strikes, lock-outs, or other labor or transportation difficulties, delay of sources or supply, accidents, fires, acts of God, or any other causes of like or unlike nature beyond the control of Gunlocke.

LIABILITY

Gunlocke products and their packaging are tendered to a transportation company only after passing rigid quality control inspection. At that time, title to the product is passed to the purchaser. However the transportation company assumes all liability from acceptance of shipment through its delivery. That is, Gunlocke's liability ceases at the time of shipment.

FILING OF CLAIMS

All claims for damage or loss must be submitted via our website within 15 days after receipt of merchandise. Do not return freight damaged merchandise to Gunlocke. Follow the steps below to expedite processing and resolution of claims.

For Visible Damage

1. Make damage notation on delivery receipt and have driver sign. Do not reject or refuse the shipment.
2. Immediately contact Gunlocke Traffic Department at 585-728-8268.
3. Hold damaged carton and all interior packing for carrier's inspection. These materials will be needed to substantiate the claim.

For Concealed Damage

1. Open cartons within 15 days of receipt and inspect.
2. Follow steps 2, and 3 as listed under Visible Damage.
3. Do not remove product from delivered destination.

For Loss

1. Be sure loss notation is made on delivery receipt and have driver sign.
2. Contact Gunlocke Traffic Department at 585-728-8268.

Should transportation company seek to limit its liability on concealed, loss, or damage claims, please contact Gunlocke's traffic department. After a thorough investigation of the claim, the traffic department will provide you with guidance in corresponding with the carrier.

Returned merchandise, regardless of delivery method, will not be accepted unless specifically authorized by Gunlocke.

For Damage or Loss of Parcel Post or UPS Shipment

Notify the Gunlocke traffic department immediately at 585-728-8268.

NORMAL DELIVERY

All normal ground transportation by Gunlocke will be made on a dock-to-dock basis. The Gunlocke traffic department will determine the recommended method of shipment according to the ship to destination. If the delivery on a shipment takes longer than 3 hours to be unloaded, an additional charge will be billed at \$100/hour. Gunlocke reserves the absolute right to determine the method of shipping unless special delivery instructions have been previously approved.

SHIPPING INSTRUCTIONS

Gunlocke will make every effort in honoring delivery requests as stated on orders. However, the Company shall have no liability for failure to deliver, perform or delay in delivery due to any cause outside the control of Gunlocke. The Company assumes no liability for costs incurred due to delayed or late deliveries.

If a guaranteed delivery time is needed please call Gunlocke Traffic Department at 585-728-8268 for a quote as additional charges will apply. Weekend or after hours deliveries are subject to additional charges.

WEEKEND DELIVERY

A \$500 charge will apply on weekend delivery after 3:00 PM Friday through Sunday evenings.

DROP SHIP / JOB SITE DELIVERY

Orders under \$50,000 list will incur a \$125 charge for ship to locations other than a designated dealer warehouse.

INSIDE DELIVERY

Inside delivery must be noted on order. A minimum \$100 charge will apply.

SPECIAL DELIVERY

Please contact the Gunlocke traffic department for special delivery services such as inside delivery, weekend or after hour deliveries, reconsignment or other special needs. These are billable services.

Gunlocke will make every effort in honoring delivery requests as stated on orders. However, the Company shall have no liability for failure to deliver, perform or delay in delivery due to any cause outside the control of Gunlocke. The Company assumes no liability for costs incurred due to delayed or late deliveries.

DOCK RESTRICTIONS

Gunlocke trailers are 53' x 102"; when attached to truck cab the total length is 75'. If delivery dock will not accommodate trucks of this size, the Gunlocke traffic department must be contacted prior to shipping. Alternate arrangements can be made; additional charges may apply.

SPECIAL FINISHES

- Submit a color sample block (minimum size 3" x 3") to Gunlocke Order Entry so that a finish formulation can be developed to match the special finish and color.
- Review the approval sample provided by Gunlocke.
- Written approval and sign off is required for Gunlocke Customer Service.
- Once written approval and sign off is received, the special finish order will be acknowledged.

All seating purchase orders:

- **10% list** upcharge per unit to base model receiving special finish.
- **\$250 net formulation fee** for special finish.

This procedure and cost apply to new and previously formulated special finishes. Special finish orders may receive additional lead time.

FSC OPTION

For FSC Certified Product add "FSC" to beginning of wood finish option code.

Example: FSC260.

Only models that have wood finish option can be ordered as FSC Certified Product.

UPCHARGES

- 5% list upcharge per unit to base model

MULTIPLE FABRICS PRICING

When multiple fabrics per chair are requested, the chair is priced at the highest grade price.

ETCHED AND LASER CUT BACKS

Eligible Models:

All Multi Seating with Wood Backs

Minimum order quantity: 5 Units

There shall be an initial setup fee of **\$250 (NET)** with a **\$100** List up-charge per unit. All standard finishes may be specified with backs. For new designs please submit artwork* to Customer Service for review and approval. Once the artwork is accepted, an actual sample will be produced and sent for approval.

*Please allow 3-5 business days upon receipt of the artwork for the sample to be completed.

All artwork must be clean and sharp image. Gunlocke can only accept mailed original artwork. Artwork must be black and white, bold and have crisp lines to be processed. Contact Order Entry for complete order and approval process. (800) 828-6300.

GUNLOCKE STANDARD TEXTILE OFFERING AND COM PROGRAM OVERVIEW

Customers purchasing Gunlocke seating can choose coverings from the standard fabric/leather offering or fabrics can be specified outside of the Gunlocke standard fabric offering through a simpler, hassle-free COM process.

Standard Fabric/Leather Partnership Program – select from any one of the Gunlocke standard fabrics or leather offerings listed on the website from the following textile partners: HBF, Maharam, Momentum, Ultrafabrics or Camira. For the most current standard fabric and leather offering, please visit the website at Gunlocke.com.

HBF
TEXTILES

maharam

Ultrafabrics

camira

COM Program – COM coverings can easily be specified and applied your seating products. Gunlocke offers two different processes for the COM program which are outlined below. The Gunlocke To Supply COM process is managed by Gunlocke and Dealer to Supply COM process is managed by the dealer.

- **Gunlocke To Supply (GTS) COM Program** – this is a process for fabrics that are not included in the standard Gunlocke offering. Gunlocke will manage the COM process with the textile supplier and will coordinate with the dealer to approve, grade/price and procure the fabric.

GTS Guidelines:

1. Select the fabric you wish to use and check the Gunlocke COM Tool on Gunlocke.com to determine if the fabric you have chosen has already been tested and approved on the product you are interested in. The COM supplier's name, fabric pattern name, and color name will be needed to search for approved fabrics.
 - 2a. If your fabric is listed as an approved fabric, you may place your order directly with Gunlocke Customer Service. Please use the fabric code (e.g., S216426XP) noted in the COM Tool on your order in the place of the standard fabric code.
 - 2b. If the fabric has not previously been tested, you must enter a COM request. Your name, company name and email will be prepopulated fields. The secondary email, project name, and bid/contract number are optional information. However, it's best to include any bid/contract information to ensure the code is set up correctly. The supplier, pattern, and color will show a list by clicking in the box and entering the first letter of the name and these are free form text boxes. Once that information is entered click add. (Multiple series can be added to the same request if they are the same supplier, pattern, and color.) Then click submit. An email will be sent to the to the requestor stating the COM Request was successfully submitted. Up to four emails could be received: Testing materials requested, in testing, and final approval/denial. It's rare actual test yardage is required. Testing is mainly done by reviewing the attributes of the fabric. The testing process takes 24-48 hours.
 3. If approved, the final email will include the GTS fabric option code and price grade. Written COM price quotes hold pricing for 90 days after issue date.
- **Dealer to Supply – COM or COL Program** – this is also a process for fabrics/leathers that are not included in the standard Gunlocke offering. The main difference is that the dealer will manage the COM process themselves and will procure the fabric from textile supplier and send to Gunlocke to upholster on the product.

COM/COL Guidelines:

1. Select the fabric you wish to use and check the Gunlocke COM Tool on Gunlocke.com to determine if the fabric you have chosen has already been tested and approved on the product you are interested in. The COM supplier's name, fabric pattern name, and color name will be needed to search for approved fabrics.
2. If your fabric is listed as approved, please reference the upholstery requirements listed in the pricer.
3. If the fabric has not previously been tested, you must enter a COM request. Your name, company name and email will be prepopulated fields. The secondary email, project name, and bid/contract number are optional information. However, it's best to include any bid/contract information to ensure the code is set up correctly. The supplier, pattern, and color will show a list by clicking in the box and entering the first letter of the name and these are free form text boxes. Once that information is entered click add. (Multiple series can be added to the same request if they are the same supplier, pattern, and color.) Then click submit. An email will be sent to the to the requestor stating the COM Request was successfully submitted. Up to four emails could be received: Testing materials requested, in testing, and final approval/denial. It's rare actual test yardage is required. Testing is mainly done by reviewing the attributes of the fabric. The testing process takes 24-48 hours.
4. If approved, the final email will include the Dealer to Supply fabric option code and the COM or COL price grade. Written COM price quotes hold pricing for 90 days after issue date.
5. The dealer is responsible for sending the COM fabric to Gunlocke. Fabric must be marked with "COM – Dealer to Supply", dealer name, order number and seating model #. COM textile should be shipped to the address below the same time as the order submission and reference tracking information on order, to prevent production delays.

HNI Textile Distribution Center - Dealer PO Number
Attn: COM Production Yardage
301 Mulberry Ave.
Dock Doors 20-22
Muscatine, IA 52761
6. All COM "Dealer to Supply" orders will be charged grade 4 pricing. Dealers will pay for the COM fabric separately.
7. All COM fabric must be sent on a fabric roll.
8. Once the COM fabric is received, the order will be scheduled in production and acknowledged with a ship date.

Specific to DTS orders - the customer should send only the amount needed for the order. Fabric should arrive no sooner than 4 weeks in advance of order placement. Excess yardage, or yardage not attached to an order will be disposed of at Gunlocke's discretion.

Any canceled orders are subject to cancellation charges up to the full value of the Gunlocke product canceled. Gunlocke will determine the actual cancellation charge at the time the cancellation is requested.

COM | CUSTOMER'S OWN MATERIAL

1. Gunlocke cannot be held responsible for performance, color accuracy, or weaving of COM materials. All responsibility for COM shipments is between the purchaser and the textile source.
2. Gunlocke assumes no responsibility for the flame retardance of any COM. Customers are solely responsible for making sure that COM shipments comply with all applicable codes and regulations.
3. Gunlocke reserves the right to reject fabrics or leathers we deem unsuitable for upholstery. When this occurs, the customer will be notified in writing with an explanation of the problem. Gunlocke cannot be held responsible for any unsatisfactory results in the application of a COM/COL, and a written release from the customer will be required before the order is processed.
4. Please contact Gunlocke Customer Service if you are planning on having any fabric applied in a non-standard technique. (I.E. using the back side as the face), or have special requirements.
5. Fabric alterations such as laminated backing or fire coding may result in differences in upholstery appearance or stiffness.

YARDAGE REQUIREMENTS

Yardages shown in price list are for non-directional fabric based on 54" wide plain fabric (no repeat pattern). A chart is provided on page 14 to assist in determining the additional COM yardage requirements. Please add the indicated percentage to the yardage shown beside the style number in the price list. This guide will accurately cover most COM orders, but there will be instances due to unusual repeats or designs that additional yardage may be required. **Gunlocke will not be held responsible for any additional COM that may be required. Please contact Customer Service for quotations on fabric requirements.**

SELF-DECK PLATFORMS

Self-covered platforms in COM are available at no upcharge. Allow additional yardage in the following amounts for 54" material:

One seat sofa	1 yd.
Two seat sofa	1.5 yds.
Three seat sofa	2 yds.

FABRIC APPLICATION

Cutting direction is based on the fabric width and the way the fabric is cut from the roll and applied to Gunlocke products. There are two cutting directions: Vertical (cut-right) or Horizontal (railroaded). Gunlocke reserves the right to railroad (or apply the fabric according to the weave) whenever possible to avoid seams in large upholstered areas and/or single cushions units. If a fabric is questionable, a cutting of adequate size allowing full repeats must be sent to Customer Service for approval.

COL | CUSTOMER'S OWN LEATHER

Customer's leather must meet standards set by Gunlocke. All hides must be #1 quality, bear no greater than three defects, and yield a minimum of 45 usable square feet per hide. Imperfections that penetrate the hide, brands, large marks, burns, excessive healed over scars and scratches, and excessive fat wrinkles are considered defects.

COL SPECIFICATIONS

Leather footage requirements listed in the price list refer to usable leather square footage that meet the standards described above. Calf hides must be at least 30 square feet of clean and usable matching hides. When specifying calf hides, add 30% to footage requirements. **Gunlocke will not be held responsible for any additional COL that may be required.**

LEATHER SEAT PUDDLING

Leather is a natural material which has elasticity and will form according to usage. For example as a leather seat "breaks in" (similar to leather shoes) stretching may occur. This is an inherent quality of natural leather and is not considered a defect.

LEATHER LOGOS

Leather is a natural material which has elasticity. The degree of stretching occurring in the upholstery process varies by model and may reduce the visual depth of the logo detail.

EMBROIDERED LOGOS

Certain logo geometry may limit threads per inch on embroidered logos. **Logos on Fabric and Leather have a three year warranty see page 8.**

FOR SAMPLE CONTACT:

gunts@gunlocke.com

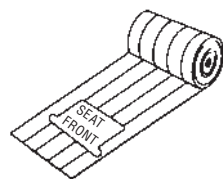

Vertical or Cut-Right

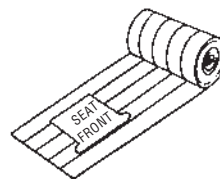

Horizontal or Railroaded

COM | COL ORDERING PROCESS

1. COM material must be approved by Gunlocke for applicability and yardage requirements before acceptance of an order.

Please send large memo sample to COM for approval.

Additional yardage may be required to determine acceptance for upholstery.

2. COM | COL sample must reference the supplier's company name, pattern, color and number order.

3. Application instructions must accompany order. In absence of these instructions, Gunlocke will determine best method of upholstery.

4. All COM | COL must be shipped pre-paid to Gunlocke with package side marked with:

- Dealer Name
- Dealer purchase order number
- Gunlocke seating pattern number

**HNI Textile Distribution Center -
Dealer PO Number
Attn: COM Production Yardage
301 Mulberry Ave.
Dock Doors 20-22
Muscatine, IA 52761**

NOTE

COM and COL orders cannot be scheduled for production or acknowledged as to ship date until COM has been received and approved by Gunlocke. Gunlocke will not warrant application and upholstery technique

PLEASE REFER TO YOUR FABRIC SWATCH CARD FOR HORIZONTAL AND VERTICAL REPEAT REQUIREMENTS.

Fabric Width	Plain Fabric	2"-10" Repeat	11"-20" Repeat	21"-25" Repeat	26"-30" Repeat	31"-37" Repeat	38"-45" Repeat	46"-52" Repeat
54"	0%	10%	15%	20%	25%	30%	35%	40%
52"	15%	20%	25%	30%	35%	40%	45%	50%
50"	25%	30%	35%	40%	45%	50%	55%	60%
48"	35%	40%	45%	50%	55%	60%	65%	70%
45"	45%	50%	55%	60%	65%	70%	75%	80%

Fabric Width	Plain Fabric	2"-10" Repeat	11"-20" Repeat	21"-25" Repeat	26"-30" Repeat	31"-37" Repeat	38"-45" Repeat	46"-52" Repeat
36"	60%	65%	70%	75%	80%	85%	90%	95%

Depending upon the pattern repeat, it may be necessary to cut the fabric vertical (cut-right). This will require 15% additional fabric.

To calculate the correct yardage with repeats (horizontal and vertical), add the horizontal repeat to the vertical repeat for total yardage required.

When calculating repeat, round up to nearest .5 yard.

For example:

A fabric width of 54" with a 8" vertical repeat (requires 10%) + a 20" horizontal repeat (requires 15%) = total additional yardage equals 25%.

Therefore, if the chair requires 2 yards of fabric, multiply 2 by 125% (or 2 x 1.25). Then 2.5 yards will be yardage required.

CUT YARDAGE PROGRAM

All Gunlocke Branded textiles and leathers are available on a cut yardage basis.

PRICING

For pricing information, please contact customer support at guncks@gunlocke.com or call 800-828-6300. Please have fabric pattern and color available. Pricing provided will not include shipping charges, storage or insurance charges, sales and other taxes.

ORDERING

Order all fabrics by name and pattern number. All cut-yardage orders will be cut and shipped to the nearest one-eighth yard. Minimum order quantity is one yard. Leathers are sold by the square foot to the closest whole or half hide. When an exact match is necessary, please submit a cutting with order; slight variations in shade cannot be avoided.

ACKNOWLEDGMENT

All orders will be confirmed by Gunlocke in writing. The order acknowledgment is the final expression of the agreement between the customer and Gunlocke and supersedes all prior verbal and written statements regarding the order. The acknowledgment can be modified only in writing with reconfirmation signed by Gunlocke.

CANCELLATIONS

Orders may not be canceled or returned by the customer without the written consent of The Gunlocke Company and are subject to a cancellation or restocking charge of 35% of the total amount of the order.

CREDIT TERMS FOR CUT YARDAGE PROGRAM

Credit may be established upon Gunlocke's written acceptance of satisfactory references. Gunlocke may cancel or change credit terms at its discretion and may request advance payment at any time. All prepaid orders must include shipping and handling charges and tax where applicable. If local taxes are not applied on prepaid orders, customer must complete a resale certificate indicating their tax I.D. number.

**FLAMMABILITY GUIDELINES
UPHOLSTERY COVERS**

Gunlocke makes every effort to ship high quality product, free of defects in material and workmanship. Great care is taken in selecting only first quality upholstery materials from reputable suppliers.

Upholstery material is warranted for 3 years against unusual wear or deterioration; there is no warranty against fading, normal wear, or customer-induced cuts and tears.

Leather is a natural material. There may be minor variation in markings such as growth wrinkles, healed scars, and grain patterns. Also, subtle variations in the tanning and dyeing process can be seen from one hide to another.

Combinations of Upholstery Covers

Contact Tailored Solutions (gunts@gunlocke.com) for assistance with pricing of fabric, vinyl, leather or upholstery combinations.

SPECIAL TREATMENT/ FLAMMABILITY

Technical Bulletin #133 is a flammability regulation that may be required or requested for certain areas or applications. Most standard Gunlocke fabrics, when used in combination with proper components, can meet the requirements of the composite test for California technical bulletin #133. The composite test requires the use of a full-scale mock-up/sample that in all respects (including fabrics, filling materials, combustible decorative parts and furniture style) reflects the construction of the actual furniture required for a specific area or application.

While Gunlocke has tested several model/upholstery combinations for TB133, not all possible combinations have been tested or certified. Please contact Customer Service to determine if the specific model/upholstery combination you are working with has been tested or if a new test is required. In addition, all COM fabrics must be evaluated on an individual basis and may also require testing. Testing is available as follows:

Specific model & upholstery

- Fire barrier is available as a special treatment. If required, please contact Gunlocke Tailored Solutions to quote as a special: gunts@gunlocke.com.
- Please check with Customer Service to verify testing has been completed with your model and fabric selection.
- Cost of testing a chair is \$850 NET, plus the cost of chair and fabric.
- Additional lead-time for testing for CAL 133.
- Additional lead-time for fire barrier cloth is 3-4 weeks.

*Note that specification of the fire barrier cloth does not in itself provide certification. Testing must be completed and pass for the specific model/upholstery combination to obtain a certificate. Once testing is completed, Gunlocke will provide a certification letter specific to the sample tested for CAL 133.

Special Flammability Code Requirements

Please inquire for pricing and lead time.

ACT PERFORMANCE GUIDELINES

Explanation of ACT Icons

All Gunlocke fabrics conform to the Association of Contract Fabrics Guidelines.

FIRE RETARDANCY



Flammability testing determines a fabric's resistance to burning.

Application	Passes
Upholstery	California 117-2013
Panels and Upholstered Walls	ASTM E 84 (unadhered method)

COLORFASTNESS TO WET AND DRY CROCKING



Colorfastness to wet and dry crocking refers to the rubbing off of color from the fabric onto clothing, hands or other materials and can occur under wet or dry conditions.

Application	Passes
Upholstery AATCC 8-1974	Dry Crocking, Class 4 minimum Wet Crocking, Class 3 minimum
Panels and Upholstered Walls	AATCC 8-1974 Class 3 minimum

COLORFASTNESS TO LIGHT



Colorfastness to light is the degree to which fabric will retain its color when exposed to light.

Application	Passes
Upholstery	AATCC 16-A-1974 or AATCC 16-E-1976 Class 4 minimum at 40 hours
Panels and Upholstered Walls	AATCC 16-A-1974 or AATCC 16-E-1976 Class 4 minimum at 40 hours

PHYSICAL PROPERTIES



Three physical property tests include: brush pill test to determine a fabric's pilling. Breaking/tensile strength is the ability of a fabric to withstand tension without breaking or tearing. Seam slippage is the pulling apart of fabrics at the seams.

Application	Passes
Upholstery	Brush pill ASTM D3511, 3-4 minimum Breaking strength ASTM DF-D1682-64 (1975) 50 lbs. minimum in warp and weft Seam slippage ASTM D3597-D434-75 25 lbs. minimum in warp and weft

ABRASION



Abrasion is the ability of a fabric to withstand damage from wear and rubbing. There is a general contract specification as well as a heavy duty specification.

Application	Passes
General Contract Upholstery	ASTM 3597 modified #10 cotton duck) 15,000 double rubs Wyzenbeek Method
Heavy Duty Upholstery	ASTM 3597 modified (#10 cotton duck) 30,000 double rubs Wyzenbeek method or ASTM D4966 (with 21 oz.weight) 40,000 rubs Martindale method



FABRIC MATRIX

FABRIC TABLES
Silea Tackboards

• Available upholstery option
RR: railroaded, F/FR: Fire compliant model

Supplier	Pattern Name	Pattern Code	New Grade	FABRIC TABLES Silea Tackboards						
				Tack	Tack A	Tack B	Tack C	Tack D	Tack E	Tack F
HBF Textiles	Blink	1048	4							
HBF Textiles	Look-See	1044	4							
HBF Textiles	Walkabout	1046	4							
HBF Textiles	Against the Grain	SHBFAGG	5	•			•	•	•	
HBF Textiles	Caddy Corner	1016	5							
HBF Textiles	Checkmate	1043	5							
HBF Textiles	Pebbled	SHBFPEB	5							
HBF Textiles	Picnic Plaid	1029	5							
HBF Textiles	Upbeat	1036	5							
HBF Textiles	Zippy	1045	5							
HBF Textiles	Poppy	1047	6							
HBF Textiles	Crew Cut	SHBFCRW	7	•			•	•	•	
HBF Textiles	Happy Camper	1028	7							
HBF Textiles	Honest	SHBFHON	7							
HBF Textiles	Roundabout	1005	7							
HBF Textiles	Dashing	1008	8							
HBF Textiles	Fourfold	SHBFFOU	8	•			•	•	•	
HBF Textiles	Modern Tweed	SHBFMOD	8							
HBF Textiles	Sherpa	1031	8							
HBF Textiles	All Terrain	1027	9							
HBF Textiles	Comfort Zone	905	9							
HBF Textiles	Crafted Felt	1017	9							
HBF Textiles	Curtain Wall	1023	9							
HBF Textiles	Madam Dottie	1001	9							
HBF Textiles	Scribble XS	982	9							
HBF Textiles	Uptown	1039	9							
HBF Textiles	Wabi Sabi	SHBFWAB	9							
HBF Textiles	Color Code	998	10							
HBF Textiles	Digital Bloom 2.0	1050	10							
HBF Textiles	Equation	SHBFEQU	10	•			•	•	•	
HBF Textiles	Folded Lines	973	10							
HBF Textiles	Remember	SHBFREM	10							
HBF Textiles	Roy's Cords	1025	10							
HBF Textiles	Soft Angles 2.0	1051	10							
HBF Textiles	Upscale	1040	10							
HBF Textiles	Air Mail	1006	11							
HBF Textiles	Argyle Boucle	978	11							
HBF Textiles	Brushed Canvas	SHBFBCV	11							
HBF Textiles	Cloud	SHBFCLD	11							
HBF Textiles	Complex	964	12							
HBF Textiles	Abito	SHBFABI	12							
HBF Textiles	Beetle	SHBFABI	12	•			•	•	•	
HBF Textiles	Belgian Meadow	SHBFBLM	12	•			•	•	•	
HBF Textiles	Crosstweed	991	12							
HBF Textiles	Cutout	SHBFCUT	12							
HBF Textiles	Dot Grid	975	12							
HBF Textiles	Dot Structure	SHBFDOT	12							
HBF Textiles	Glint	SHBFGLT	12	•			•	•	•	
HBF Textiles	Grateful Grid	1015	12							
HBF Textiles	Heartfelt	SHBFHTF	12	•	•	•	•	•	•	•
HBF Textiles	Lava Rock	993	12							
HBF Textiles	Merci Boucle	SHBFMER	12							
HBF Textiles	Moving Blanket	SHBFMOV	12							
HBF Textiles	Sable Island	SHBFSAB	12							

FABRIC TABLES
Silea Tackboards

• Available upholstery option
RR: railroaded, F/FR: Fire compliant model

Supplier	Pattern Name	Pattern Code	New Grade	FABRIC TABLES Silea Tackboards						
				Tack	Tack A	Tack B	Tack C	Tack D	Tack E	Tack F
				No Restriction	66"W & 77"W Railroad Cut Only	77"W Railroad Cut Only	66"W & 77"W Pattern Cut Only	77"W Pattern Cut Only	No Pattern Cut	No Railroad Cut
HBF Textiles	Sir Stripe A Lot	1004	12							
HBF Textiles	Sweater Weather	1030	12							
HBF Textiles	Twist	SHBFTWS	12							
HBF Textiles	Upstart	1042	12							
HBF Textiles	Cherished Knit	954	13							
HBF Textiles	Enriched Boucle	1021	13							
HBF Textiles	Foundation	SHBFFND	13							
HBF Textiles	Moving Forward	1014	13							
HBF Textiles	Night Earth	1013	13							
HBF Textiles	Pepper Blend	995	13							
HBF Textiles	Quill	1011	13							
HBF Textiles	Scribble XL	983	13							
HBF Textiles	Sister Solid	1003	13							
HBF Textiles	Afghan	SHBFAFG	14	•	•	•	•	•	•	•
HBF Textiles	Smart	SHBFSMT	14							
HBF Textiles	Velvet Mix	977	14							
HBF Textiles	Hipster	SHBFHPT	15	•			•	•	•	
HBF Textiles	Landscape Blur	1024	15							
HBF Textiles	Poodle	1009	16							
HBF Textiles	Sweater	SHBFSWE	16							
HBF Textiles	Woven Memory	1019	16							
HBF Textiles	Crafted Cloud	1018	19							
HBF Textiles	Knitwork	SHBFKNI	21							
HBF Textiles	Bunny	1012	23							
HBF Textiles	Eccentric	966	23							
HBF Textiles	Eccentric	SHBFECC	23							
HBF Textiles	Wild West	717	L2							
HBF Textiles	Aviator	K08	L3							
HBF Textiles	Freeway	K03	L3							
HBF Textiles	Modern Patina	716	L3							
HBF Textiles	Persuede	718	L3							
HBF Textiles	Vivace II	K07	L3							
HBF Textiles	Upper Crust	K05	L5							
HBF Textiles	Voyage	K09	L5							

FABRIC MATRIX

FABRIC TABLES

• Available upholstery option

RR: railroaded, F/FR: Fire compliant model

Supplier	Pattern Name	Pattern Code	New Grade	Liv	Iris	Swivel 2	Lounge 2	Side 1	Side 2	Callia
HBF Textiles	Taylor	TAY	2		•	•	•	•	•	•
HBF Textiles	Blink	1048	4			•	•	•	•	•
HBF Textiles	Look-See	1044	4	•	•	•	•	•	•	•
HBF Textiles	Walkabout	1046	4	•	•	•	•	•	•	•
HBF Textiles	Against the Grain	SHBFAGG	5	•	•	•	•	•	•	•
HBF Textiles	Caddy Corner	1016	5	•	•	•	•	•	•	•
HBF Textiles	Checkmate	1043	5	•	•	•	•	•	•	•
HBF Textiles	Pebbled	SHBFPEB	5	•		•	•	•	•	
HBF Textiles	Picnic Plaid	1029	5	•		•	•	•	•	
HBF Textiles	Upbeat	1036	5	•		•	•	•	•	•
HBF Textiles	Zippy	1045	5	•	•	•	•	•	•	•
HBF Textiles	Poppy	1047	6	•	•	•	•	•	•	•
HBF Textiles	Crew Cut	SHBFCRW	7		•	•	•	•	•	•
HBF Textiles	Happy Camper	1028	7	•		•	•	•	•	•
HBF Textiles	Honest	SHBFHON	7	•	•	•	•	•	•	•
HBF Textiles	Roundabout	1005	7	•		•	•	•	•	
HBF Textiles	Dashing	1008	8	•	•	•	•	•	•	•
HBF Textiles	Fourfold	SHBFFOU	8	•		•	•	•	•	
HBF Textiles	Modern Tweed	SHBFMOD	8			•	•	•	•	
HBF Textiles	Sherpa	1031	8		•	•	•	•	•	•
HBF Textiles	All Terrain	1027	9	•		•	•	•	•	•
HBF Textiles	Comfort Zone	905	9		•	•	•	•	•	•
HBF Textiles	Crafted Felt	1017	9	•	•	•	•	•	•	•
HBF Textiles	Curtain Wall	1023	9	•		•	•	•	•	•
HBF Textiles	Madam Dottie	1001	9	•	•	•	•	•	•	•
HBF Textiles	Scribble XS	982	9	•		•	•	•	•	
HBF Textiles	Uptown	1039	9	•		•	•	•	•	•
HBF Textiles	Wabi Sabi	SHBFWAB	9	•				•	•	
HBF Textiles	Color Code	998	10	•		•	•	•	•	
HBF Textiles	Digital Bloom 2.0	1050	10	•		•	•	•	•	•
HBF Textiles	Equation	SHBFEQU	10	•	•	•	•	•	•	•
HBF Textiles	Folded Lines	973	10	•	•	•	•	•	•	•
HBF Textiles	Remember	SHBFREM	10	•		•	•	•	•	
HBF Textiles	Roy's Cords	1025	10			•	•	•	•	
HBF Textiles	Soft Angles 2.0	1051	10	•	•	•	•	•	•	•
HBF Textiles	Upscale	1040	10	•	•	•	•	•	•	•
HBF Textiles	Air Mail	1006	11	•		•	•	•	•	•
HBF Textiles	Argyle Boucle	978	11	•	•	•	•	•	•	•
HBF Textiles	Brushed Canvas	SHBFBCV	11	•		•	•	•	•	•
HBF Textiles	Cloud	SHBFCLD	11	•		•		•	•	
HBF Textiles	Complex	964	12	•	•	•	•	•	•	•
HBF Textiles	Abito	SHBFABI	12	•	•	•	•	•	•	•
HBF Textiles	Beetle	SHBFABI	12	•	•	•	•	•	•	•
HBF Textiles	Belgian Meadow	SHBFBLM	12	•	•	•	•	•	•	•
HBF Textiles	Crosstweed	991	12	•	•	•	•	•	•	•
HBF Textiles	Cutout	SHBFCUT	12	•		•	•	•	•	•
HBF Textiles	Dot Grid	975	12	•		•	•	•	•	
HBF Textiles	Dot Structure	SHBFDOT	12	•	•	•	•	•	•	•
HBF Textiles	Glint	SHBFGLT	12	•	•	•	•	•	•	•
HBF Textiles	Grateful Grid	1015	12	•	•	•	•	•	•	•
HBF Textiles	Heartfelt	SHBFHTF	12	•	•	•	•	•	•	•
HBF Textiles	Lava Rock	993	12	•	•	•	•	•	•	•
HBF Textiles	Merci Boucle	SHBFMER	12		•	•	•	•	•	•
HBF Textiles	Moving Blanket	SHBFMOV	12	•		•	•	•	•	•

FABRIC TABLES

- Available upholstery option
- RR: railroaded, F/FR: Fire compliant model

Supplier	Pattern Name	Pattern Code	New Grade	Liv	Iris	Swivel 2	Lounge 2	Side 1	Side 2	Callia
HBF Textiles	Sable Island	SHBFSAB	12	•		•	•	•	•	
HBF Textiles	Sir Stripe A Lot	1004	12	•		•	•	•	•	
HBF Textiles	Sweater Weather	1030	12	•	•	•	•	•	•	•
HBF Textiles	Twist	SHBFTWS	12		•	•	•	•	•	•
HBF Textiles	Upstart	1042	12	•	•	•	•	•	•	•
HBF Textiles	Cherished Knit	954	13	•	•	•	•	•	•	•
HBF Textiles	Enriched Boucle	1021	13	•	•	•	•	•	•	•
HBF Textiles	Foundation	SHBFFND	13			•	•		•	
HBF Textiles	Moving Forward	1014	13	•	•	•	•	•	•	•
HBF Textiles	Night Earth	1013	13	•	•	•	•	•	•	•
HBF Textiles	Pepper Blend	995	13	•	•	•	•	•	•	•
HBF Textiles	Quill	1011	13	•	•	•	•	•	•	•
HBF Textiles	Scribble XL	983	13	•		•	•	•	•	
HBF Textiles	Sister Solid	1003	13	•	•	•	•	•	•	•
HBF Textiles	Afghan	SHBFAFG	14			•	•	•	•	•
HBF Textiles	Smart	SHBFSMT	14			•	•	•	•	
HBF Textiles	Velvet Mix	977	14	•		•	•	•	•	•
HBF Textiles	Hipster	SHBFHPT	15	•	•	•	•	•	•	•
HBF Textiles	Landscape Blur	1024	15	•		•	•	•	•	
HBF Textiles	Poodle	1009	16	•	•	•	•	•	•	•
HBF Textiles	Sweater	SHBFSWE	16			•	•	•	•	•
HBF Textiles	Woven Memory	1019	16	•		•	•	•	•	•
HBF Textiles	Crafted Cloud	1018	19			•	•	•	•	•
HBF Textiles	Knitwork	SHBFKNI	21		•	•	•	•	•	•
HBF Textiles	Bunny	1012	23		•	•	•	•	•	•
HBF Textiles	Eccentric	966	23		•	•	•	•	•	•
HBF Textiles	Eccentric	SHBFEC	23							
HNI Textiles	Strasburg	STB	L1	•	•	•	•	•	•	•
HBF Textiles	Wild West	717	L2	•		•	•	•	•	
HBF Textiles	Aviator	K08	L3	•	•	•	•	•	•	•
HBF Textiles	Freeway	K03	L3	•	•	•	•	•	•	•
HBF Textiles	Modern Patina	716	L3	•		•	•	•	•	
HBF Textiles	Persuede	718	L3	•		•	•	•	•	
HBF Textiles	Vivace II	K07	L3	•	•	•	•	•	•	•
HBF Textiles	Upper Crust	K05	L5		•	•	•	•	•	•
HBF Textiles	Voyage	K09	L5	•	•	•	•	•	•	•

Guest Seating 23-39
 Product Specifications 24-25
 Bank of England™ 26
 Calia 27-28
 Camille 29-30
 Genesee Guest 31-32
 Lily™ 33
 Metta 34-35
 Savor™ 36-37
 Tia™ Guest 38-39

GUEST SEATING

Product Specifications

BANK OF ENGLAND™

Frame:

Construction: Hardwood frame joined by double dowels, corner blocks.

Available hardwoods: Maple

Seat: Foam filled over sheet webbed frame, upholstered.

Back: Steambent hardwood back.

Arm: Steambent hardwood arms.

Glides: Nickel-plated steel.

BIFMA Rating:

Chairs: ANSI/BIFMA X5.1 2011
(253lb Weight Rating)

CALIA

Frame:

Construction: Hardwood frame joined by mortise and tenon, corner blocks. Steambent back rail

Available hardwoods: Maple, Ash

Seat: Foam filled over sheet-webbed seat foundation, upholstered.

Back: High resiliency foam overmolded onto rigid urethane bucket, wrapped in 1/2" foam on inside back.

Glides: Nickel-plated steel

BIFMA Rating:

ANSI/BIFMA X5.1 2017
(275lb Weight Rating)

CAMILLE

Frame:

Construction: Hardwood frame joined by double dowels, mortise and tenon, and corner blocks.

Available hardwoods: Maple

Seat: Foam filled over strip-webbed seat foundation, upholstered.

Back: Foam filled over flexible foundation, upholstered.

Glides: Nickel-plated steel.

BIFMA Rating:

ANSI/BIFMA X5.1 2017
(275lb Weight Rating)

GENESEE

Seat: High resiliency foam overmolded onto rigid urethane bucket, wrapped in 1/2" foam with additional 1/2" high resiliency foam topper.

Back: High resiliency foam overmolded onto rigid urethane bucket, wrapped in 1/2" foam.

Arm:

Polished aluminum: Polished cast aluminum.

Control:

Swivel tilt: Swivel tilt with tilt lockout, polished low-profile control.

Base: Four star, die cast polished aluminum.

Glides: 1 3/4" nylon cap glides.

Upholstery: Top-stitch around edges of bucket.

BIFMA Rating:

ANSI/BIFMA X5.1 2017
(300lb Weight Rating)

LILY™

Frame:

Construction: Hardwood frame joined by mortise and tenon, corner blocks.

Available hardwoods: Maple, Ash

Seat: Foam filled over sheet webbed vent plywood foundation, upholstered.

Back: Foam filled over strip-webbed seat foundation, upholstered.

Glides: Nickel-plated steel.

BIFMA Rating:

ANSI/BIFMA X5.1 2011
(253lb Weight Rating)

METTA

Frame: 3/4" polished chrome steel tubing, with 1/2" solid rod cross members.

Seat & Back:

Fully Upholstered: Rigid fiberglass reinforced urethane with overmolded foam, wrapped in 1/4" dacron. 1/4" upholstery grade plywood outer.

Wood Outers: Rigid fiberglass reinforced urethane with overmolded foam, wrapped in 1/4" dacron. 1/4" qtr cut or rift cut plywood outer.

Arm Cap: 13" flexible vinyl molded piece, undermounted with double-sided tape. Wrapped in J" high density foam.

Glides: Push-fit low density polyethylene; heavy-duty round plastic inserts

Shipping: Product ships 1 to a box. Does not stack.

BIFMA Rating:

ANSI/BIFMA X5.1 2011
(253lb Weight Rating)

SAVOR™

Frame:

Construction: Steambent back posts, hardwood frame joined by mortise and tenon, corner blocks.

Available hardwoods: Maple, Ash

Seat: Foam filled over sheet-webbed plywood seat foundation, upholstered.

Back: Foam filled over strip-webbed seat foundation, upholstered.

Glides: Nickel-plated steel.

BIFMA Rating:

ANSI/BIFMA X5.1 2017
(275lb Weight Rating)

TIA™ GUEST

Frame:

Construction: Hardwood frame joined by mortise and tenon, and corner blocks.

Available hardwoods: Maple, Ash

Seat & Back: ¹³/₁₆" thick plywood bucket, consisting of 13 cross-plyies of ¹/₁₆" thick #3 grade southern hardwood.

Glides: Nickel-plated steel.

BIFMA Rating:

ANSI/BIFMA X5.1 2017
(275lb Weight Rating)

model number	fabric grades								dimensions	W	D	H
GK9947US Arm, upholstered seat	1	5,267	10	5,419	19	5,614	L1	5,428	Overall	23 1/2"	22 3/4"	31 3/8"
	2	5,282	11	5,436	20	5,636	L2	5,569	Seat		16 3/4"	17 3/8"
	3	5,295	12	5,454	21	5,660	L3	5,738	Arm			27 3/4"
	COM/4	5,309	13	5,477	22	5,683	L4	5,878	Between arms	19"		
	5	5,327	14	5,500	23	5,727	L5	6,019	Upholstery Requirements: GK9947US			
	6	5,346	15	5,523	24	5,773			Fabric yards		0.7	
	7	5,363	16	5,546	25	5,819			Leather feet ²		11.9	
	8	5,382	17	5,568	26	5,864			Shipping weight		32 lbs.	
	9	5,400	18	5,591	27	5,909			Cube		13.9	
	GK9947 Wood seat	5,084 All Wood										

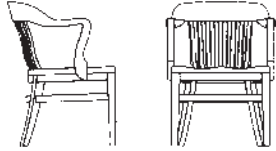

TO ORDER PLEASE SPECIFY THE FOLLOWING:

<input type="text"/>	<input type="text"/>	<input type="text"/>	<input type="text"/>
MODEL NUMBER	FINISH	FLAMMABILITY RATING	UPHOLSTERY (model GK9947US only)
	Cherry finishes on Maple Walnut finishes on Maple Maple finishes on Maple Oak finishes on Maple Light Rift Oak 301 not available on Maple. Please refer to the Bank of England™ product page on www.gunlocke.com for standard finish options.	U CTB117	Please refer to list of available upholstery and leather selections on www.gunlocke.com

Example

GK9947US.215.U.DOL728			
GK9947US	215	U	DOL728
MODEL NUMBER	FINISH	FLAMMABILITY	UPHOLSTERY

model number	fabric grades								dimensions	W	D	H
GGCAL17-011 Single Upholstery	1	2,973	10	3,490	19	4,160	L1	3,525	Overall	21"	24"	31 3/8"
	2	3,021	11	3,551	20	4,237	L2	4,007	Seat	19"	18 3/8"	18"
	3	3,067	12	3,614	21	4,316	L3	4,585	Upholstery Requirements: GGCAL17-011			
	COM/4	3,115	13	3,691	22	4,393	L4	5,066	Fabric yards	2.4		
	5	3,177	14	3,770	23	4,549	L5	5,550	Leather feet ²	40.8		
	6	3,239	15	3,848	24	4,705			Shipping weight	27 lbs.		
	7	3,302	16	3,926	25	4,861			Cube	13.2		
	8	3,364	17	4,003	26	5,017						
	9	3,427	18	4,082	27	5,174						

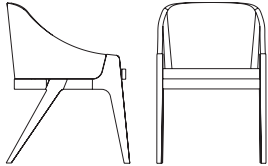

TO ORDER PLEASE SPECIFY THE FOLLOWING:

MODEL NUMBER	SPECIES & FINISH	FLAMMABILITY RATING	UPHOLSTERY

These seating models are available in the following hardwoods: **U CTB117**

Maple **NE**
Ash **QA**

Please refer to the Calia product page on www.gunlocke.com for standard finish options.

Cherry finishes on Maple or Ash
Maple finishes on Maple or Ash
Walnut finishes on Maple or Ash
Oak finishes on Maple or Ash

Natural Cherry 222, Clear Maple 800, Clear Oak 300 and Fawn Cypress 108 not available on Ash.

Light Rift Oak 301 not available on Maple.

Please refer to list of available upholstery and leather selections on www.gunlocke.com

Example

GGCAL17-011.NE.U.DOL728
 GGCAL17-011 NE U DOL728
 MODEL NUMBER SPECIES & FINISH FLAMMABILITY UPHOLSTERY

CALIA

Guest | Dual Upholstery

Seating
02/24

model number fabric grades

GGCAL17-021 **1** 3,026

Dual upholstery

dimensions	W	D	H
Overall	21"	24"	31 ³ / ₈ "
Seat	19"	18 ³ / ₈ "	18"

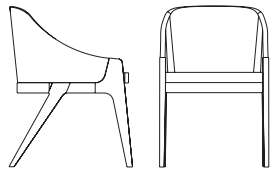

Upholstery Requirements: GGCAL17-021

	Dual Upholstery	
Fabric yards	Inner 1.7	Outer 1.0
Leather feet ²	Inner 28.9	Outer 17.0
Shipping weight	27 lbs.	
Cube	13.2	

Inner	1		10		19		L1	
		366	841	391				
	2 34	11 409	20 896	L2	732			
	3 67	12 455	21 951	L3	1,142			
	COM/4 101	13 509	22 1,007	L4	1,484			
	5 145	14 565	23 1,117	L5	1,826			
	6 189	15 620	24 1,227					
	7 233	16 674	25 1,338					
	8 278	17 731	26 1,449					
	9 321	18 785	27 1,559					

To calculate price of chair with different fabric for Seat and Back; start with Grade 1 price, add appropriate grade price located in second row for Seat, and last add appropriate grade price located in third row for Back to the sum of the Grade 1 and Seat price.

Example: Grade 1 \$3,026 + grade 4 fabric seat \$101 + grade 2 fabric back \$20 = \$3,147

Outer	1		10		19		L1	
		216	495	230				
	2 20	11 242	20 528	L2	431			
	3 41	12 267	21 560	L3	672			
	COM/4 59	13 299	22 593	L4	873			
	5 85	14 332	23 658	L5	1,075			
	6 111	15 365	24 723					
	7 137	16 397	25 788					
	8 164	17 430	26 852					
	9 190	18 462	27 917					

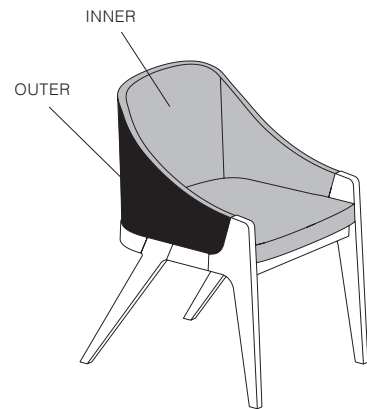

TO ORDER PLEASE SPECIFY THE FOLLOWING:

MODEL NUMBER	SPECIES & FINISH	FLAMMABILITY RATING	INNER UPHOLSTERY	OUTER UPHOLSTERY

These seating models are available in the following hardwoods:

Maple **NE**
Ash **QA**

Please refer to the Calia product page on www.gunlocke.com for standard finish options.

Cherry finishes on Maple or Ash
Maple finishes on Maple or Ash
Walnut finishes on Maple or Ash
Oak finishes on Maple or Ash

Natural Cherry 222, Clear Maple 800, Clear Oak 300 and Fawn Cypress 108 not available on Ash.

Light Rift Oak 301 not available on Maple.

U CTB117

Please refer to list of available upholstery and leather selections on www.gunlocke.com

Please refer to list of available upholstery and leather selections on www.gunlocke.com

Example

GGCAL17-021.U.DOL728.DOL728

GGCAL17-021	NE	U	DOL728	SPNN04
MODEL NUMBER	SPECIES & FINISH	FLAMMABILITY UPHOLSTERY	INNER UPHOLSTERY	OUTER UPHOLSTERY

model number	fabric grades								dimensions	W	D	H
GK21001 Open arm, upholstered seat and full back, curved leg	1	1,507	10	1,852	19	2,299	L1	1,875	Overall	22 1/2"	24"	32"
	2	1,539	11	1,893	20	2,350	L2	2,197	Seat		18 1/2"	18 3/4"
	3	1,571	12	1,935	21	2,403	L3	2,583	Arm			25 3/4"
	COM/4	1,601	13	1,986	22	2,454	L4	2,903	Between arms	20"		
	5	1,642	14	2,038	23	2,559	L5	3,225	Upholstery Requirements: GK21001			
	6	1,685	15	2,090	24	2,662			Fabric yards			1.6
	7	1,727	16	2,142	25	2,766			Leather feet ²			27.2
	8	1,768	17	2,193	26	2,870			Shipping weight			23.5 lbs.
	9	1,810	18	2,247	27	2,974			Cube			13.9

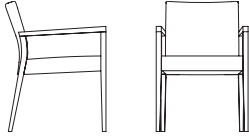

GK21003 Open arm, upholstered seat and half upholstered back, straight leg	1	1,549	10	1,850	19	2,242	L1	1,871
	2	1,577	11	1,886	20	2,288	L2	2,152
	3	1,605	12	1,922	21	2,332	L3	2,490
	COM/4	1,632	13	1,969	22	2,379	L4	2,771
	5	1,668	14	2,014	23	2,469	L5	3,052
	6	1,705	15	2,059	24	2,560		
	7	1,741	16	2,105	25	2,652		
	8	1,778	17	2,151	26	2,742		
	9	1,814	18	2,195	27	2,833		

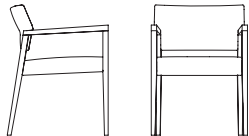

Overall	22 1/2"	25"	30 1/2"
Seat		17 3/4"	18 1/2"
Arm			25 3/4"
Between arms	20"		
Upholstery Requirements: GK21003			
Fabric yards			1.4
Leather feet ²			23.8
Shipping weight			23.6 lbs.
Cube			13.0

TO ORDER PLEASE SPECIFY THE FOLLOWING:

. . .

MODEL NUMBER	FINISH	FLAMMABILITY RATING	UPHOLSTERY
	Cherry finishes on Maple Walnut finishes on Maple Maple finishes on Maple Oak finishes on Maple <i>Light Rift Oak 301 not available on Maple.</i> Please refer to the Camille product page on www.gunlocke.com for standard finish options.	U CTB117	Please refer to list of available upholstery and leather selections on www.gunlocke.com

Example

GK21001.215.U.DOL728			
GK21001	215	U	DOL728
MODEL NUMBER	FINISH	FLAMMABILITY	UPHOLSTERY

CAMILLE

Guest | Dual Upholstery

Seating
02/24

model number fabric grades dimensions W D H

GK21003-021

Open arm, upholstered seat and half upholstered back, straight leg

1 1,579

Overall	22 1/2"	25"	30 1/2"
Seat		17 3/4"	18 1/2"
Arm			25 3/4"
Between arms	20"		

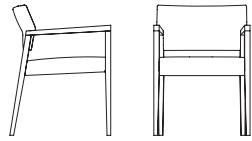

Upholstery Requirements: GK21003-021

	Dual Upholstery	
Fabric yards	Seat 0.9	Back .5
Leather feet ²	Seat 15.3	Back 8.5
Shipping weight	23.6 lbs.	
Cube	13.0	

Seat

1	10	216	19	495	L1	230	
2	20	11	242	20	528	L2	431
3	41	12	267	21	560	L3	672
COM/4	59	13	299	22	593	L4	873
5	85	14	332	23	658	L5	1,075
6	111	15	365	24	723		
7	137	16	397	25	788		
8	164	17	430	26	852		
9	190	18	462	27	917		

To calculate price of chair with different fabric for Seat and Back; start with Grade 1 price, add appropriate grade price located in second row for Seat, and last add appropriate grade price located in third row for Back to the sum of the Grade 1 and Seat price.

Example: Grade 1 \$1,579 + grade 4 fabric seat \$59 + grade 2 fabric back \$11 = \$1,649

Back

1	10	109	19	248	L1	116	
2	11	11	121	20	264	L2	217
3	20	12	134	21	281	L3	336
COM/4	30	13	150	22	296	L4	436
5	44	14	167	23	329	L5	538
6	56	15	183	24	361		
7	70	16	199	25	394		
8	82	17	216	26	427		
9	95	18	232	27	459		

TO ORDER PLEASE SPECIFY THE FOLLOWING:

<input type="text"/>	<input type="text"/>	<input type="text"/>	<input type="text"/>	<input type="text"/>
MODEL NUMBER	FINISH	FLAMMABILITY RATING	SEAT UPHOLSTERY	BACK UPHOLSTERY
	Cherry finishes on Maple Walnut finishes on Maple Maple finishes on Maple Oak finishes on Maple Please refer to the Camille product page on www.gunlocke.com for standard finish options.	U CTB117	Please refer to list of available upholstery and leather selections on www.gunlocke.com	Please refer to list of available upholstery and leather selections on www.gunlocke.com

Example

GK21003-021.215.U.DOL728.SPNN04
 GK21003-021 215 U DOL728 SPNN04
 MODEL NUMBER FINISH FLAMMABILITY SEAT UPHOLSTERY BACK UPHOLSTERY

model number	fabric grades								dimensions	W	D	H
GGRA16-111 Guest, High Back Armless	1	2,605	10	3,057	19	3,644	L1	3,088	Overall	21 3/4"	28"	39 1/8"
	2	2,647	11	3,111	20	3,712	L2	3,510	Seat	21"	19 1/2"	18"
	3	2,688	12	3,165	21	3,781	L3	4,017	Upholstery Requirements: GGRA16-111			
	COM/4	2,728	13	3,234	22	3,848	L4	4,437	Fabric yards	1.6		
	5	2,784	14	3,302	23	3,985	L5	4,859	Leather feet ²	27.2		
	6	2,838	15	3,371	24	4,122			Shipping weight	44 lbs.		
	7	2,892	16	3,439	25	4,258			Cube	18.3		
	8	2,947	17	3,507	26	4,395						
	9	3,002	18	3,575	27	4,531						

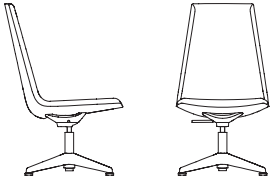

GGRA16-121 Guest, Mid Back Armless	1	2,450	10	2,816	19	3,291	L1	2,841	Overall	21 3/4"	26 1/2"	32 3/8"
	2	2,484	11	2,859	20	3,346	L2	3,182	Seat		18 5/8"	18"
	3	2,517	12	2,905	21	3,401	L3	3,592	Upholstery Requirements: GGRA16-121			
	COM/4	2,551	13	2,959	22	3,457	L4	3,934	Fabric yards	1.5		
	5	2,595	14	3,015	23	3,567	L5	4,276	Leather feet ²	25.5		
	6	2,639	15	3,070	24	3,677			Shipping weight	42 lbs.		
	7	2,683	16	3,124	25	3,788			Cube	14.5		
	8	2,728	17	3,181	26	3,899						
	9	2,771	18	3,235	27	4,009						

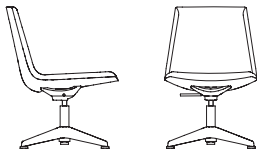

TO ORDER PLEASE SPECIFY THE FOLLOWING:

. .

MODEL NUMBER

FLAMMABILITY RATING

UPHOLSTERY

U CTB117

Please refer to list of available upholstery and leather selections on www.gunlocke.com

NOTE: Genesee Guest comes standard with a 4-star polished aluminum base, return-to-center cylinder, at a fixed seat height of 18", and with 1 3/4" nylon cap glides.

Example

GGRA16-111.U.DOL728

GGRA16-111 U DOL728
MODEL NUMBER FLAMMABILITY UPHOLSTERY

GENESEE GUEST

Polished Arms

Seating
02/24

model number	fabric grades				dimensions	W	D	H				
GGRA16-141 Guest, Mid Back Polished Arms	1	2,538	10	2,904	19	3,379	L1	2,929	Overall	23 1/2"	26 1/2"	32 3/8"
	2	2,572	11	2,947	20	3,434	L2	3,270	Seat		19 1/4"	18"
	3	2,605	12	2,993	21	3,489	L3	3,680	Arm			24 1/2"
	COM/4	2,639	13	3,047	22	3,545	L4	4,022	Between arms	21"		
	5	2,683	14	3,103	23	3,655	L5	4,364				
	6	2,727	15	3,158	24	3,765						
	7	2,771	16	3,212	25	3,876						
	8	2,816	17	3,269	26	3,987						
	9	2,859	18	3,323	27	4,097						
										Upholstery Requirements: GGRA16-141		
									Fabric yards		1.5	
									Leather feet ²		25.5	
									Shipping weight		47 lbs.	
									Cube		15.6	



TO ORDER PLEASE SPECIFY THE FOLLOWING:

. .

MODEL NUMBER

FLAMMABILITY RATING

UPHOLSTERY

U CTB117

Please refer to list of available upholstery and leather selections on www.gunlocke.com

NOTE: Genesee Guest comes standard with a 4-star polished aluminum base, return-to-center cylinder, at a fixed seat height of 18", and with 1 3/4" nylon cap glides.

Example

GGRA16-141.U.DOL728

GGRA16-141 U DOL728
MODEL NUMBER FLAMMABILITY UPHOLSTERY

model number	fabric grades								dimensions	W	D	H
GGCA14-011 Open arm, upholstered seat and back	1	2,026	10	2,371	19	2,818	L1	2,394	Overall	21 1/2"	23 1/2"	33"
	2	2,058	11	2,412	20	2,869	L2	2,716	Seat		18 1/2"	17"
	3	2,090	12	2,454	21	2,922	L3	3,102	Arm			25 3/4"
	COM/4	2,120	13	2,505	22	2,973	L4	3,422	Between arms	19 1/4"		
	5	2,161	14	2,557	23	3,078	L5	3,744	Upholstery Requirements: GGCA14-011			
	6	2,204	15	2,609	24	3,181			Fabric yards			1.6
	7	2,246	16	2,661	25	3,285			Leather feet ²			27.2
	8	2,287	17	2,712	26	3,389			Shipping weight			25 lbs.
	9	2,329	18	2,766	27	3,493			Cube			14.6

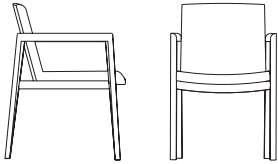

TO ORDER PLEASE SPECIFY THE FOLLOWING:

--	--	--	--	--

MODEL NUMBER **SPECIES & FINISH** **STITCH DETAIL** **FLAMMABILITY RATING** **UPHOLSTERY**

These seating models are available in the following hardwoods:

Maple **NE**
Ash **QA**

Please refer to the Lily™ product page on www.gunlocke.com for standard finish options.

Cherry finishes on Maple
Maple finishes on Maple
Cherry finishes on Ash
Walnut finishes on Ash
Oak finishes on Ash

Natural Cherry 222, Ebony Maple 555, Clear Oak 300 and Fawn Cypress 108 not available on Ash.

Sumatra Walnut 629 and Light Rift Oak 301 not available on Maple.

Not required **NR**
Stitch detail
SD +\$91

U CTB117

Please refer to list of available upholstery and leather selections on www.gunlocke.com

Example

GGCA14-011.NE800.SD.U.DOL728				
GGCA14-011	NE800	SD	U	DOL728
MODEL NUMBER	SPECIES & FINISH	STITCH DETAIL	FLAMMABILITY	UPHOLSTERY

METTA

Fully Upholstered

Seating
02/24

model number	fabric grades	dimensions	W	D	H
--------------	---------------	------------	---	---	---

GGWA16-011
Fully upholstered

1 2,069

Overall	21 1/8"	25 7/16"	33 9/16"
Seat		18 5/8"	18 11/16"
Arm			25 3/4"
Between arms	18 7/8"		

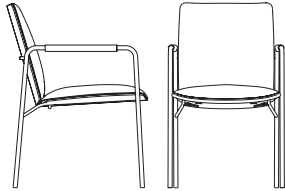

Upholstery Requirements: GGWA16-011

	Dual Upholstery	
Fabric yards	Inners 1.3	Outers 0.1
Leather feet ²	Inners 22.1	Outers 1.4
Shipping weight	30 lbs.	
Cube	14.4	

Inners and Arms

1	10	280	19	643	L1	298
2	27	11	314	20	L2	560
3	52	12	348	21	L3	873
COM/4	78	13	390	22	L4	1,135
5	111	14	432	23	L5	1,396
6	145	15	473	24		
7	179	16	517	25		
8	212	17	559	26		
9	246	18	601	27		

To calculate price of chair with different fabric for Seat and Back; start with Grade 1 price, add appropriate grade price located in second row for Seat, and last add appropriate grade price located in third row for Back to the sum of the Grade 1 and Seat price.

Example: Grade 1 \$2,069 + grade 4 fabric seat \$78 + grade 2 fabric back \$17 = \$2,164

Outers

1	10	173	19	396	L1	184
2	17	11	193	20	L2	346
3	32	12	215	21	L3	538
COM/4	48	13	240	22	L4	698
5	68	14	266	23	L5	860
6	90	15	292	24		
7	110	16	319	25		
8	131	17	345	26		
9	152	18	370	27		

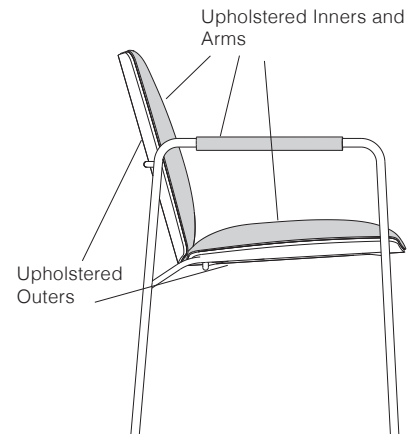

TO ORDER PLEASE SPECIFY THE FOLLOWING:

<input type="text"/>	<input type="text"/>	<input type="text"/>	<input type="text"/>
----------------------	----------------------	----------------------	----------------------

MODEL NUMBER

FLAMMABILITY RATING

INNERS & ARMS UPHOLSTERY

OUTERS UPHOLSTERY

U CTB117

Please refer to list of available upholstery and leather selections on www.gunlocke.com

Please refer to list of available upholstery and leather selections on www.gunlocke.com

Example

GGWA16-011.U.DOL728.SPNN04

GGWA16-011	U	DOL728	SPNN04
MODEL NUMBER	FLAMMABILITY	INNERS & ARMS UPHOLSTERY	OUTERS UPHOLSTERY

model number	fabric grades								dimensions	W	D	H
GGWA16-021 Wood shell	1	2,358	10	2,638	19	3,001	L1	2,656	Overall	21 1/8"	25 3/4"	33 9/16"
	2	2,385	11	2,672	20	3,043	L2	2,918	Seat		18 5/8"	18 11/16"
	3	2,410	12	2,706	21	3,086	L3	3,231	Arm			25 3/4"
	COM/4	2,436	13	2,748	22	3,128	L4	3,493	Between arms	18 7/8"		
	5	2,469	14	2,790	23	3,212	L5	3,754				
	6	2,503	15	2,831	24	3,297						
	7	2,537	16	2,875	25	3,381						
	8	2,570	17	2,917	26	3,466						
	9	2,604	18	2,959	27	3,550						

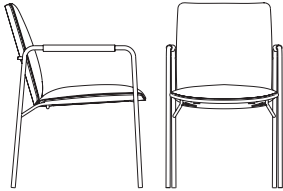

Upholstery Requirements: GGWA16-021

Fabric yards	1.3
Leather feet ²	22.1
Shipping weight	13 lbs.
Cube	14.4

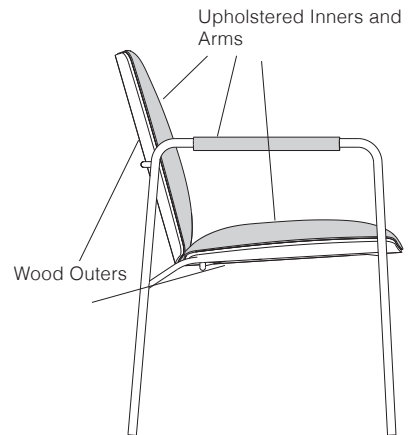

TO ORDER PLEASE SPECIFY THE FOLLOWING:

. . .

MODEL NUMBER **OUTERS FINISH** **FLAMMABILITY RATING** **INNERS & ARMS UPHOLSTERY**

Walnut finishes on Walnut
Cherry finishes on Cherry
Maple finishes on Maple
Oak finishes on Oak

Walnut, Cherry, and Maple shells are quarter cut; Oak shells are rift cut.

Please refer to the Metta product page on www.gunlocke.com for standard finish options.

U CTB117

Please refer to list of available upholstery and leather selections on www.gunlocke.com

Example

GGWA16-021.215.U.DOL728

GGWA16-021 215 U DOL728
MODEL NUMBER **OUTERS FINISH** **FLAMMABILITY** **INNERS & ARMS UPHOLSTERY**

model number	fabric grades								dimensions	W	D	H
GGJA14-011 Open arm, upholstered seat and back wood top rail	1	1,850	10	2,151	19	2,543	L1	2,172	Overall	22 1/2"	23 1/2"	33"
	2	1,878	11	2,187	20	2,589	L2	2,453	Seat	19 1/2"	18"	18 1/2"
	3	1,906	12	2,223	21	2,633	L3	2,791	Arm	25 1/2"		
	COM/4	1,933	13	2,270	22	2,680	L4	3,072	Between arms	19 1/2"		
	5	1,969	14	2,315	23	2,770	L5	3,353	Upholstery Requirements: GGJA14-011			
	6	2,006	15	2,360	24	2,861			Fabric yards	1.4		
	7	2,042	16	2,406	25	2,953			Leather feet ²	23.8		
	8	2,079	17	2,452	26	3,043			Shipping weight	25 lbs.		
	9	2,115	18	2,496	27	3,134			Cube	14.6		

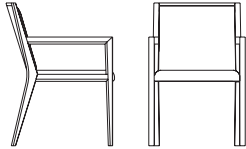

GGJA14-021 Open arm, upholstered seat and back upholstered top rail	1	1,816	10	2,117	19	2,509	L1	2,138
	2	1,844	11	2,153	20	2,555	L2	2,419
	3	1,872	12	2,189	21	2,599	L3	2,757
	COM/4	1,899	13	2,236	22	2,646	L4	3,038
	5	1,935	14	2,281	23	2,736	L5	3,319
	6	1,972	15	2,326	24	2,827		
	7	2,008	16	2,372	25	2,919		
	8	2,045	17	2,418	26	3,009		
	9	2,081	18	2,462	27	3,100		

Overall	22 1/2"	23 1/2"	33"
Seat	19 1/2"	18"	18 1/2"
Arm	26"		
Between arms	19 1/2"		
Upholstery Requirements: GGJA14-021			
Fabric yards	1.4		
Leather feet ²	23.8		
Shipping weight	25 lbs.		
Cube	14.6		

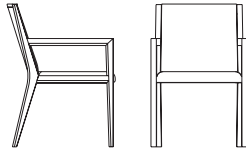

TO ORDER PLEASE SPECIFY THE FOLLOWING:

. . .

MODEL NUMBER **SPECIES & FINISH** **FLAMMABILITY RATING** **UPHOLSTERY**

These seating models are available in the following hardwoods:

Maple **NE**
Ash **QA**

Please refer to the Savor™ product page on www.gunlocke.com for standard finish options.

Cherry finishes on Maple
Maple finishes on Maple
Cherry finishes on Ash
Walnut finishes on Ash
Oak finishes on Ash

Natural Cherry 222, Ebony Maple 555, Clear Oak 300 and Fawn Cypress 108 not available on Ash.

Sumatra Walnut 629 and Light Rift Oak 301 not available on Maple.

U **CTB117**

Please refer to list of available upholstery and leather selections on www.gunlocke.com

Example

GGJA14-011	NE800	U	DOL728
MODEL NUMBER	SPECIES & FINISH	FLAMMABILITY	UPHOLSTERY

model number fabric grades dimensions W D H

GGJA14-031 1 1,884
Open arm,
upholstered seat and back,
wood top rail

Overall	22 1/2"	23 1/2"	33"
Seat	19"	18"	18 1/2"
Arm			25 1/2"
Between arms	19 1/2"		

Upholstery Requirements: GGJA14-031

	Dual Upholstery	
Fabric yards	Seat 0.8	Back 0.8
Leather feet ²	Seat 13.6	Back 13.6
Shipping weight	25 lbs.	
Cube	14.6	

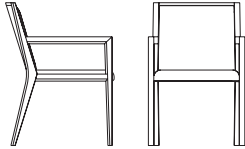

Seat	1	10	216	19	495	L1	230	
	2	20	11	242	20	528	L2	431
	3	41	12	267	21	560	L3	672
	COM/4	59	13	299	22	593	L4	873
	5	85	14	332	23	658	L5	1,075
	6	111	15	365	24	723		
	7	137	16	397	25	788		
	8	164	17	430	26	852		
	9	190	18	462	27	917		

To calculate price of chair with different fabric for Seat and Back; start with Grade 1 price, add appropriate grade price located in second row for Seat, and last add appropriate grade price located in third row for Back to the sum of the Grade 1 and Seat price.

Example: Grade 1 \$1,884 + grade 4 fabric seat \$59 + grade 2 fabric back \$17 = \$1,960

Back	1	10	173	19	396	L1	184	
	2	17	11	193	20	422	L2	346
	3	32	12	215	21	448	L3	538
	COM/4	48	13	240	22	473	L4	698
	5	68	14	266	23	527	L5	860
	6	90	15	292	24	578		
	7	110	16	319	25	630		
	8	131	17	345	26	682		
	9	152	18	370	27	734		

TO ORDER PLEASE SPECIFY THE FOLLOWING:

. . . .

MODEL NUMBER SPECIES & FINISH FLAMMABILITY RATING SEAT UPHOLSTERY BACK UPHOLSTERY

These seating models are available in the following hardwoods:

Maple **NE**
Ash **QA**

Please refer to the Savor product page on www.gunlocke.com for standard finish options.

Cherry finishes on Maple
Maple finishes on Maple
Cherry finishes on Ash
Walnut finishes on Ash
Oak finishes on Ash

Natural Cherry 222, Ebony Maple 555, Clear Oak 300 and Fawn Cypress 108 not available on Ash.

Sumatra Walnut 629 and Light Rift Oak 301 not available on Maple.

U CTB117

Please refer to list of available upholstery and leather selections on www.gunlocke.com

Please refer to list of available upholstery and leather selections on www.gunlocke.com

Example

GGJA14-031	NE800	U	DOL728	SPNN04
MODEL NUMBER	SPECIES & FINISH	FLAMMABILITY UPHOLSTERY	INNER UPHOLSTERY	OUTER UPHOLSTERY

TIA™ GUEST

Single Upholstery

Seating
02/24

model number	fabric grades								dimensions	W	D	H
GGHB17-071 Single upholstery, armless	1	1,422	10	1,680	19	2,016	L1	1,699	Overall	19"	21 1/2"	32 1/8"
	2	1,446	11	1,712	20	2,055	L2	1,940	Seat	18 1/2"	16 3/4"	18 3/8"
	3	1,470	12	1,743	21	2,093	L3	2,228	Upholstery Requirements: GGH17-071			
	COM/4	1,494	13	1,782	22	2,132	L4	2,469	Fabric yards	1.2		
	5	1,524	14	1,820	23	2,211	L5	2,711	Leather feet ²	20.4		
	6	1,555	15	1,860	24	2,289			Shipping weight	23 lbs.		
	7	1,587	16	1,899	25	2,367			Cube	10.9		
	8	1,618	17	1,939	26	2,444						
	9	1,649	18	1,977	27	2,524						

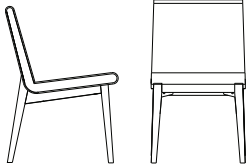

TO ORDER PLEASE SPECIFY THE FOLLOWING:

MODEL NUMBER	FINISH	FLAMMABILITY RATING	UPHOLSTERY

These seating models are available in the following hardwoods:

Maple **NE**
Ash **QA**

Please refer to the Tia product page on www.gunlocke.com for standard finish options.

Cherry finishes on Maple or Ash
Walnut finishes on Maple or Ash
Maple finishes on Maple or Ash
Oak finishes on Maple or Ash

*Natural Cherry 222, Clear Maple 800, Clear Oak 300 and Fawn Cypress 108 not available on Ash.
 Light Rift Oak 301 not available on Maple.*

U CTB117

Please refer to list of available upholstery and leather selections on www.gunlocke.com

Example

GGHB17-071.QA629.U.DOL728			
GGHB17-071	QA629	U	DOL728
MODEL NUMBER	FINISH	FLAMMABILITY	UPHOLSTERY

model number fabric grades dimensions W D H

GGHB17-081
Dual upholstery,
armless

1 1,448

Overall	19"	21 1/2"	32 1/8"
Seat	18 1/2"	16 3/4"	18 3/8"

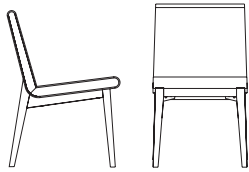

Upholstery Requirements: GGHB17-081

	Dual Upholstery	
Fabric yards	Seat 1.1	Back 1.2
Leather feet ²	Seat 18.7	Back 20.4
Shipping weight	23 lbs.	
Cube	10.9	

Seat	1	10	236	19	544	L1	254	
	2	22	11	266	20	580	L2	473
	3	44	12	294	21	616	L3	740
	COM/4	65	13	330	22	652	L4	960
	5	94	14	366	23	723	L5	1,181
	6	122	15	402	24	795		
	7	152	16	436	25	867		
	8	180	17	472	26	938		
	9	209	18	508	27	1,009		

To calculate price of chair with different fabric for Seat and Back; start with Grade 1 price, add appropriate grade price located in second row for Seat, and last add appropriate grade price located in third row for Back to the sum of the Grade 1 and Seat price.

Example: Grade 1 \$1,448 + grade 4 fabric seat \$65 + grade 2 fabric back \$24 = \$1,537

Back	1	10	258	19	594	L1	277	
	2	24	11	290	20	633	L2	518
	3	48	12	321	21	671	L3	806
	COM/4	72	13	360	22	710	L4	1,047
	5	102	14	398	23	789	L5	1,289
	6	133	15	438	24	867		
	7	165	16	477	25	945		
	8	196	17	517	26	1,022		
	9	227	18	555	27	1,102		

Note: When Tia Guest chair is upholstered in multiple fabrics, there is an added angled seam along the side boxings to accommodate seat and back as two choices of upholstery.

TO ORDER PLEASE SPECIFY THE FOLLOWING:

. . . .

MODEL NUMBER FINISH FLAMMABILITY RATING SEAT UPHOLSTERY BACK UPHOLSTERY

These seating models are available in the following hardwoods:
Maple **NE**
Ash **QA**
Please refer to the Tia product page on www.gunlocke.com for standard finish options.

Cherry finishes on Maple or Ash
Walnut finishes on Maple or Ash
Maple finishes on Maple or Ash
Oak finishes on Maple or Ash
Natural Cherry 222, Clear Maple 800, Clear Oak 300 and Fawn Cypress 108 not available on Ash.
Light Rift Oak 301 not available on Maple.

U CTB117

Please refer to list of available upholstery and leather selections on www.gunlocke.com

Please refer to list of available upholstery and leather selections on www.gunlocke.com

Example

GGHB17-081.QA629.U.DOL728.SPNN04				
GGHB17-081	QA629	U	DOL728	SPNN04
MODEL NUMBER	FINISH	FLAMMABILITY	SEAT UPHOLSTERY	BACK UPHOLSTERY

Multipurpose Seating 41-61
Product Specifications. 42
Convo® Barstool 43-46
LIV Guest. 47-48
LIV Stool. 49-50
Multi®. 51-54
Multi® Stool 55
Multi® Bariatric. 56-57
Tia™ Barstool. 58-59
Trillia™ Barstool 60-61

MULTIPURPOSE SEATING

Product Specifications

CONVO™

Frame:

Round tubular steel offered in Polished Stainless as well as powder-coats Silver, Black, and Bronze.

Upholstered Seat:

Seat Pan: Rigid fiberglass reinforced urethane pan provides structure to support user load, wrapped in 1/4" dacron.

Top Cushion: High resilient foam overmolded onto rigid fiberglass reinforced urethane pan, wrapped in 1/4" dacron.

Wood Seat:

Consists of 2"x2" solid ash hardwood blocks, glued and contoured to shape.

Glides: Push-fit low density polyethylene; heavy-duty round plastic inserts.

Shipping: Product ships 1 to a box.

BIFMA Rating:

ANSI/BIFMA X5.1 2011
(253lb Weight Rating)

LIV GUEST & STOOL

Frame: Round tubular steel available in 9 powder coat colors (Silver, Black, Designer White, Matte Gold, Pyrite Bronze, Titanium, Solar Black, Regatta Blue, Bullseye Red) or polished chrome.

Laminate Seat: Bent plywood with laminate layer inside and out

Wood Bucket: Bent plywood with quartered cut ash inside and out

Glides: Black Domed Nylon Glide or polished Toggle glide with white nylon and option to purchase nickel or felt caps.

Toggle Glide Caps - 4 pack

Nickel: GGLIV19-SVL1 \$71.00

Felt: GGLIV19-SVL2 \$72.00

Nylon glides are recommended for hard surfaces, commercial carpet and damp environments. Nickel-plated glides are recommended for carpet. Felt glides are recommended for wood, tile or high-sheen floor surfaces.

Stacking: 5 chairs high limit.

See GK8907. Page 51

Shipping: Product ships 1 to a box except armless versions which stacks 2 to a box.

BIFMA Rating:

ANSI/BIFMA X5.1 2017
(275lb Weight Rating)

MULTI GUEST, STOOL & TANDEM

Frame: Round tubular steel.

Seat: Foam filled over contoured plastic, upholstered.

Upholstered Back: PVC Foam filled over plywood, upholstered. Triple stitched.

Wood Back: Bent plywood.

Laser Backs: A laser cut logo or insignia is available on wood back.

LSR: Laser Back Chair. See pg. 10 for directions.

Moderne Arm: Textured polypropylene or RF bent plywood.

Glides: Plastic.

Boot: Flexible textured polyvinyl chloride 2 1/2" high. (glide models only) Black boot on black frame. Grey boot on silver frame.

Casters: 1 1/2" dual wheel hooded; black. Optional.

Shipping: Product ships 2 to a box.

Stacking: 5 chairs high limit or 4 chairs with casters. See GK8907. Page 51

BIFMA Rating:

ANSI/BIFMA X5.1 2017 w/ additional requirements (300lb Weight Rating)

NOTE:

Space required for a stack of chairs 5-high with cart.

W	D	H
26"	38"	51"

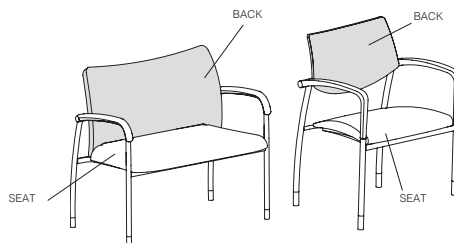

MULTI BARIATRIC

Frame: Round tubular steel.

Seat: Foam filled over reinforced upholstery-grade hardwood seat frame. Sheet webbing Interior for added user comfort. 3 degree seat angle.

Upholstered Back: Foam filled over plywood, upholstered. Triple stitched.

Modern Arms: Textured polypropylene or RF bent plywood.

Glides: Plastic.

Boot: Flexible textured polyvinyl chloride 2 1/2" high (glide models only). Black boot on black frame. Grey boot on silver frame.

Gore Protection: Waterproof moisture barrier, anti-microbial, and stain resistant.

Shipping: Product ships 1 to a box.

BIFMA Rating:

ANSI/BIFMA X5.1 2011 w/ additional requirements (600lb Weight Rating)

TRILLIA™ BARSTOOLS

Wood Seat: Consists of 2" wide solid ash hardwood blocks, glued and contoured to shape.

Upholstered Seat: High resilient foam overmolded onto vacuum-formed ABS plastic. Double needle stitch detail optional.

Legs: Solid ash hardwood.

Footrest: 1/2" solid bar footrest, polished stainless steel.

Glides: Nickel-plated steel.

Shipping: Product ships 1 to a box.

BIFMA Rating:

ANSI/BIFMA X5.1 2011
(253lb Weight Rating)

TIA™ BARSTOOLS

Frame:

Construction: Hardwood frame joined by mortise and tenon, and corner blocks.

Available hardwoods: Maple, Ash

Seat & Back: 13/16" thick plywood bucket, consisting of 13 cross-plyies of 1/16" thick #3 grade southern hardwood.

Footrest: 16 ga steel footrest, available in: polished, brushed, black or white.

Glides: Nickel-plated steel.

Shipping: Product ships 1 to a box.

BIFMA Rating:

ANSI/BIFMA X5.1 2017
(275lb Weight Rating)

model number	fabric grades	dimensions	W	D	H
GMLA15-011 Upholstered	1 1,404	Overall	16 1/4"	16"	30 1/2"
		Seat	16 1/4"	16"	

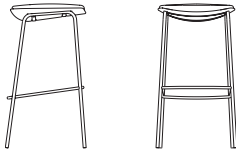

Upholstery Requirements: GMLA15-011

Dual Upholstery	
Fabric yards	Cushion 0.7 Bottom 0.7
Leather feet ²	Cushion 11.9 Bottom 11.9
Shipping weight	28 lbs.
Cube	7.1

Top Cushion

1	10	152	19	347	L1	161	
2	15	11	169	20	369	L2	302
3	28	12	187	21	393	L3	471
COM/4	42	13	210	22	416	L4	611
5	60	14	233	23	460	L5	752
6	79	15	256	24	506		
7	96	16	279	25	552		
8	115	17	301	26	597		
9	133	18	324	27	642		

To calculate price of stool with different fabric for Top Cushion and Bottom Seat Pan, start with Grade 1 price, add appropriate grade price located in second row for Top Cushion, and last add appropriate grade price located in third row for Bottom Seat Pan to the sum of the Grade 1 and Top Cushion price.

Example: Grade 1 \$1,404 + grade 4 fabric Top Cushion \$42 + grade 2 fabric Bottom Seat Pan \$15 = \$1,461

Bottom Seat Pan

1	10	152	19	347	L1	161	
2	15	11	169	20	369	L2	302
3	28	12	187	21	393	L3	471
COM/4	42	13	210	22	416	L4	611
5	60	14	233	23	460	L5	752
6	79	15	256	24	506		
7	96	16	279	25	552		
8	115	17	301	26	597		
9	133	18	324	27	642		



TO ORDER PLEASE SPECIFY THE FOLLOWING:

<input type="text"/>	<input type="text"/>	<input type="text"/>	<input type="text"/>	<input type="text"/>
MODEL NUMBER	FRAME	FLAMMABILITY RATING	TOP CUSHION UPHOLSTERY	BOTTOM SEAT PAN UPHOLSTERY
	This seating model is available with the following frame options. Please specify by adding suffix to model number. P71 Black PR6 Silver PJE Pyrite	U CTB117	Select upholstery for the top cushion. Please refer to list of available upholstery and leather selections on www.gunlocke.com	Select upholstery for the bottom seat pan. Please refer to list of available upholstery and leather selections on www.gunlocke.com

Example

GMLA15-011.P71.U.DOL728.SPNN04

MODEL NUMBER	FRAME	FLAMMABILITY RATING	TOP CUSHION UPHOLSTERY	BOTTOM SEAT PAN UPHOLSTERY
GMLA15-011	P71	U	DOL728	SPNN04

CONVO® BARSTOOL

Seating

02/24

Counter Height | Upholstered

model number	fabric grades	dimensions	W	D	H
GMLA15-041 Upholstered	1 1,404	Overall	16 1/4"	16"	26 1/4"
		Seat	16 1/4"	16"	

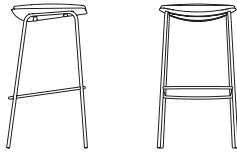

Upholstery Requirements: GMLA15-041

Dual Upholstery	
Fabric yards	Cushion 0.7 Bottom 0.7
Leather feet ²	Cushion 11.9 Bottom 11.9
Shipping weight	28 lbs.
Cube	7.1

Top Cushion

1	10	152	19	347	L1	161
2	15	11	169	20	369	L2 302
3	28	12	187	21	393	L3 471
COM/4	42	13	210	22	416	L4 611
5	60	14	233	23	460	L5 752
6	79	15	256	24	506	
7	96	16	279	25	552	
8	115	17	301	26	597	
9	133	18	324	27	642	

To calculate price of stool with different fabric for Top Cushion and Bottom Seat Pan, start with Grade 1 price, add appropriate grade price located in second row for Top Cushion, and last add appropriate grade price located in third row for Bottom Seat Pan to the sum of the Grade 1 and Top Cushion price.

Example: Grade 1 \$1,404 + grade 4 fabric Top Cushion \$42 + grade 2 fabric Bottom Seat Pan \$15 = \$1,461

Bottom Seat Pan

1	10	152	19	347	L1	161
2	15	11	169	20	369	L2 302
3	28	12	187	21	393	L3 471
COM/4	42	13	210	22	416	L4 611
5	60	14	233	23	460	L5 752
6	79	15	256	24	506	
7	96	16	279	25	552	
8	115	17	301	26	597	
9	133	18	324	27	642	



Note: Footrest for Counter Height Convo is 8 1/2" high off the floor.

TO ORDER PLEASE SPECIFY THE FOLLOWING:

<input type="text"/>	<input type="text"/>	<input type="text"/>	<input type="text"/>	<input type="text"/>
MODEL NUMBER	FRAME	FLAMMABILITY RATING	TOP CUSHION UPHOLSTERY	BOTTOM SEAT PAN UPHOLSTERY
	This seating model is available with the following frame options. Please specify by adding suffix to model number. P71 Black PR6 Silver PJE Pyrite	U CTB117	Select upholstery for the top cushion. Please refer to list of available upholstery and leather selections on www.gunlocke.com	Select upholstery for the bottom seat pan. Please refer to list of available upholstery and leather selections on www.gunlocke.com

Example

GMLA15-041.P71.U.DOL728.SPNN04				
GMLA15-041	P71	U	DOL728	SPNN04
MODEL NUMBER	FRAME	FLAMMABILITY RATING	TOP CUSHION UPHOLSTERY	BOTTOM SEAT PAN UPHOLSTERY

model number	list		dimensions	W	D	H
GMLA15-021	2,195	All Wood	Overall	16 1/4"	16"	30 1/2"
Solid Ash Wood Seat			Seat	16 1/4"	16"	

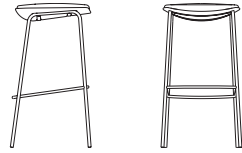

Shipping weight	28 lbs.
Cube	7.1

Note: Footrest for Bar Height Convo is 12 3/4" high off the floor.

TO ORDER PLEASE SPECIFY THE FOLLOWING:

--	--	--	--

MODEL NUMBER **FRAME** **SPECIES & FINISH**

This seating model is available with the following frame options.
Please specify by adding suffix to model number.
P71 Black
PR6 Silver
PJE Pyrite

This seating model is available with the following hardwood option:
Ash QA
Please refer to the Convo™ product page on www.gunlocke.com for standard finish options.
Cherry finishes on Ash
Walnut finishes on Ash
Oak finishes on Ash
Natural Oak 300 not available on Ash.

Example

GMLA15-021.P71.QA601		
GMLA15-021	P71	QA601
MODEL NUMBER	FRAME	SPECIES & FINISH

CONVO® BARSTOOL

Counter Height | Wood Seat

Seating
02/24

model number	list		dimensions	W	D	H
GMLA15-051	2,195	All Wood	Overall	16 1/4"	16"	26 1/8"
Solid Ash Wood Seat			Seat	16 1/4"	16"	

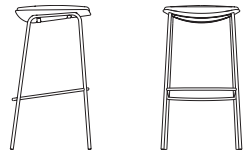

Shipping weight	28 lbs.
Cube	7.1

Note: Footrest for Counter Height Convo is 8 1/2" high off the floor.

TO ORDER PLEASE SPECIFY THE FOLLOWING:

MODEL NUMBER	FRAME	SPECIES & FINISH	

This seating model is available with the following frame options.
Please specify by adding suffix to model number.
P71 Black
PR6 Silver
PJE Pyrite

This seating model is available with the following hardwood option:
Ash QA
Please refer to the Convo™ product page on www.gunlocke.com for standard finish options.
Cherry finishes on Ash
Walnut finishes on Ash
Oak finishes on Ash
Natural Oak 300 not available on Ash.

Example

GMLA15-051.P71.QA601		
GMLA15-051	P71	QA601
MODEL NUMBER	FRAME	SPECIES & FINISH

model number	list	dimensions	W	D	H
GGLIV19-011 Wood Seat	1,384	Overall	21"	22.5"	32.5"
		Seat	19"	17"	17.25"
		Shipping weight			18.5 lbs.
		Cube			12.8

GGLIV19-012
Laminate Seat

967



model number	fabric grades	dimensions	W	D	H
GGLIV19-013 Upholstered Seat	1 1,262 10 1,478 19 1,757 L1 1,492	Overall	21"	22.5"	32.5"
	2 1,282 11 1,504 20 1,790 L2 1,693	Seat	19"	17"	17.25



3 1,303 12 1,529 21 1,822 L3 1,934
COM/4 1,321 13 1,561 22 1,855 L4 2,135
5 1,347 14 1,594 23 1,920 L5 2,337
6 1,373 15 1,627 24 1,985
7 1,399 16 1,659 25 2,050
8 1,426 17 1,692 26 2,114
9 1,452 18 1,724 27 2,179

Upholstery Requirements: GGLIV19-013

Fabric yards	1
Leather feet ²	17
Shipping weight	19.3 lbs.
Cube	12.8

GGLIV19-014
Upholstered Seat
w/Channel Stitch

1 1,455 10 1,713 19 2,049 L1 1,732
2 1,479 11 1,745 20 2,088 L2 1,973
3 1,503 12 1,776 21 2,126 L3 2,261
COM/4 1,527 13 1,815 22 2,165 L4 2,502
5 1,557 14 1,853 23 2,244 L5 2,744
6 1,588 15 1,893 24 2,322
7 1,620 16 1,932 25 2,400
8 1,651 17 1,972 26 2,477
9 1,682 18 2,010 27 2,557

Upholstery Requirements: GGLIV19-014

Overall	21"	22.5"	32.5"
Seat	19"	17"	17.25
Fabric yards	1		
Leather feet ²	17		
Shipping weight	19.3 lbs.		
Cube	12.8		

TO ORDER PLEASE SPECIFY THE FOLLOWING:

MODEL NUMBER	FSC	FRAME	GLIDE	GLWOOD	LAMINATE	FABRIC	FLAMMABILITY RATING
	No FSC X FSC Certified F +86	Polished Chrome PC +113 Black P71 Designer White PJW Matte Gold P8G Silver PR6 Pyrite PJE Solar Black P8X Titanium P8T Bullseye PJF Regatta P8M	Standard Black Nylon STD Swivel Glide w/ Nylon SVL0 +19 <i>Toggle Glide Option Pack page 42.</i>	Only on model GGLIV19-011 Cherry finishes on Quartered Ash Walnut finishes on Quartered Ash Maple finishes on Quartered Ash Oak finishes on Quartered Ash	Only on model GGLIV19-012 L1 and L2 Woodgrain Laminates +113	Only on models GGLIV19-013 and GGLIV19-014 Please refer to list of available upholstery and leather selections on www.gunlocke.com	U CTB117

Example

GGLIV19-013.X.PC.STD.DOL728.U

MODEL NUMBER	FSC	FRAME	GLIDE	FABRIC	FLAMMABILITY
GGLIV19-013	X	PC	STD	DOL728	U

model number	list	dimensions	W	D	H
GGLIV19-021 Wood Seat	1,603	Overall	20.5"	22.5"	32.5"
		Seat	19"	17"	17.25"
GGLIV19-022 Laminate Seat	1,183	Shipping weight	23.5 lbs.		
		Cube	12.5		

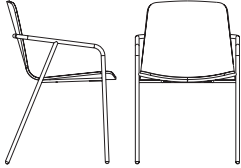

model number	fabric grades					dimensions	W	D	H
GGLIV19-023 Upholstered Seat	1	1,511	10	1,727	19	2,006	L1	1,741	
	2	1,531	11	1,753	20	2,039	L2	1,942	
	3	1,552	12	1,778	21	2,071	L3	2,183	
	COM/4	1,570	13	1,810	22	2,104	L4	2,384	
	5	1,596	14	1,843	23	2,169	L5	2,586	
	6	1,622	15	1,876	24	2,234			
	7	1,648	16	1,908	25	2,299			
	8	1,675	17	1,941	26	2,363			
	9	1,701	18	1,973	27	2,428			



Overall	21"	22.5"	32.5"
Seat	19"	17"	17.25"

Upholstery Requirements: GGLIV19-023

Fabric yards	1
Leather feet ²	17
Shipping weight	24.3 lbs.
Cube	12.5

GGLIV19-024 Upholstered Seat w/Channel Stitch	1	1,705	10	1,963	19	2,299	L1	1,982
	2	1,729	11	1,995	20	2,338	L2	2,223
	3	1,753	12	2,026	21	2,376	L3	2,511
	COM/4	1,777	13	2,065	22	2,415	L4	2,752
	5	1,807	14	2,103	23	2,494	L5	2,994
	6	1,838	15	2,143	24	2,572		
	7	1,870	16	2,182	25	2,650		
	8	1,901	17	2,222	26	2,727		
	9	1,932	18	2,260	27	2,807		



Overall	21"	22.5"	32.5"
Seat	19"	17"	17.25"

Upholstery Requirements: GGLIV19-024

Fabric yards	1
Leather feet ²	17
Shipping weight	24.3 lbs.
Cube	12.5

TO ORDER PLEASE SPECIFY THE FOLLOWING:

MODEL NUMBER	FSC	FRAME	GLIDE	GLWOOD	LAMINATE	FABRIC	FLAMMABILITY RATING
	No FSC X FSC Certified F +86	Polished Chrome PC +113 Black P71 Designer White PJW Matte Gold P8G Silver PR6 Pyrite PJE Solar Black P8X Titanium P8T Bullseye PJF Regatta P8M	Standard Black Nylon STD Swivel Glide w/ Nylon SVL0 +19 <i>Toggle Glide Option Pack page 42.</i>	Only on model GGLIV19-021 Cherry finishes on Quartered Ash Walnut finishes on Quartered Ash Maple finishes on Quartered Ash Oak finishes on Quartered Ash	Only on model GGLIV19-022 L1 and L2 Woodgrain Laminates +113	Only on models GGLIV19-023 and GGLIV19-024 Please refer to list of available upholstery and leather selections on www.gunlocke.com	U CTB117

Example

GGLIV19-023.X.PC.STD.DOL728.U

MODEL NUMBER	FSC	FRAME	GLIDE	FABRIC	FLAMMABILITY
GGLIV19-023	X	PC	STD	DOL728	U

model number	list	dimensions	W	D	HM
GMLIV19-031 Wood Seat	1,718	Overall	19"	20.5"	32.5"
		Seat	18"	16"	24.5"
GMLIV19-032 Laminate Seat	1,301	Shipping weight	23.6 lbs.		
		Cube	12.5		

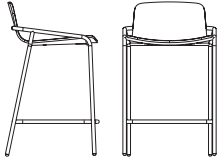

model number	fabric grades					dimensions	W	D	H			
GMLIV19-033 Upholstered Seat	1	1,627	10	1,843	19	2,122	L1	1,857	Overall	19"	20.5"	32.5"
	2	1,647	11	1,869	20	2,155	L2	2,058	Seat	18"	16"	24.5"
	3	1,668	12	1,894	21	2,187	L3	2,299	Upholstery Requirements: GMLIV19-033			
	COM/4	1,686	13	1,926	22	2,220	L4	2,500	Fabric yards	1		
	5	1,712	14	1,959	23	2,285	L5	2,702	Leather feet ²	17		
	6	1,738	15	1,992	24	2,350			Shipping weight	24.4 lbs.		
	7	1,764	16	2,024	25	2,415			Cube	12.5		
	8	1,791	17	2,057	26	2,479						
	9	1,817	18	2,089	27	2,544						

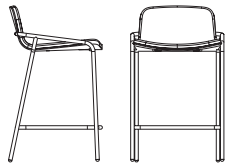

model number	fabric grades					dimensions	W	D	H			
GMLIV19-034 Upholstered Seat w/Channel Stitch	1	1,820	10	2,078	19	2,414	L1	2,097	Overall	19"	20.5"	32.5"
	2	1,844	11	2,110	20	2,453	L2	2,338	Seat	18"	16"	24.5"
	3	1,868	12	2,141	21	2,491	L3	2,626	Upholstery Requirements: GMLIV19-034			
	COM/4	1,892	13	2,180	22	2,530	L4	2,867	Fabric yards	1		
	5	1,922	14	2,218	23	2,609	L5	3,109	Leather feet ²	17		
	6	1,953	15	2,258	24	2,687			Shipping weight	24.4 lbs.		
	7	1,985	16	2,297	25	2,765			Cube	12.5		
	8	2,016	17	2,337	26	2,842						
	9	2,047	18	2,375	27	2,922						

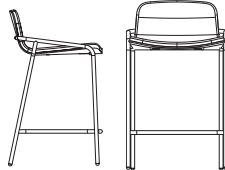

TO ORDER PLEASE SPECIFY THE FOLLOWING:

MODEL NUMBER	FSC	FRAME	GLIDE	GLWOOD	LAMINATE	FABRIC	FLAMMABILITY RATING
	No FSC X FSC Certified F +86	Polished Chrome PC +113 Black P71 Designer White PJW Matte Gold P8G Silver PR6 Pyrite PJE Solar Black P8X Titanium P8T Bullseye PJF Regatta P8M	Standard Black Nylon STD Swivel Glide w/ Nylon SVL0 +19 <i>Toggle Glide Option Pack page 42.</i>	Only on model GGLIV19-031 Cherry finishes on Quartered Ash Walnut finishes on Quartered Ash Maple finishes on Quartered Ash Oak finishes on Quartered Ash	Only on model GGLIV19-032 L1 and L2 Woodgrain Laminates +113	Only on models GGLIV19-033 and GGLIV19-034 Please refer to list of available upholstery and leather selections on www.gunlocke.com	U CTB117

Example

GGLIV19-033.X.PC.STD.DOL728.U

MODEL NUMBER	FSC	FRAME	GLIDE	FABRIC	FLAMMABILITY
GGLIV19-033	X	PC	STD	DOL728	U

LIV

Bar Height Stool

Seating
02/24

model number	list	dimensions	W	D	H
GMLIV19-041 Wood Seat	1,764	Overall	19"	20.5"	37.5"
		Seat	18"	16"	28.5"
GMLIV19-042 Laminate Seat	1,346	Shipping weight	24.6 lbs.		
		Cube	14		

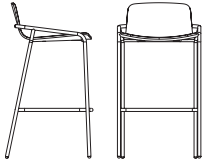

model number	fabric grades					dimensions	W	D	H			
GMLIV19-043 Upholstered Seat	1	1,673	10	1,889	19	2,168	L1	1,903	Overall	19"	20.5"	37.5"
	2	1,693	11	1,915	20	2,201	L2	2,104	Seat	18"	16"	28.5"
	3	1,714	12	1,940	21	2,233	L3	2,345	Upholstery Requirements: GMLIV19-043			
	COM/4	1,732	13	1,972	22	2,266	L4	2,546	Fabric yards	1		
	5	1,758	14	2,005	23	2,331	L5	2,748	Leather feet ²	17		
	6	1,784	15	2,038	24	2,396			Shipping weight	25.4 lbs.		
	7	1,810	16	2,070	25	2,461			Cube	14		
	8	1,837	17	2,103	26	2,525						
	9	1,863	18	2,135	27	2,590						

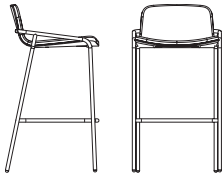

GMLIV19-044 Upholstered Seat w/Channel Stitch	1	1,867	10	2,125	19	2,461	L1	2,144	Overall	19"	20.5"	37.5"
	2	1,891	11	2,157	20	2,500	L2	2,385	Seat	18"	16"	28.5"
	3	1,915	12	2,188	21	2,538	L3	2,673	Upholstery Requirements: GMLIV19-044			
	COM/4	1,939	13	2,227	22	2,577	L4	2,914	Fabric yards	1		
	5	1,969	14	2,265	23	2,656	L5	3,156	Leather feet ²	17		
	6	2,000	15	2,305	24	2,734			Shipping weight	25.4 lbs.		
	7	2,032	16	2,344	25	2,812			Cube	14		
	8	2,063	17	2,384	26	2,889						
	9	2,094	18	2,422	27	2,969						

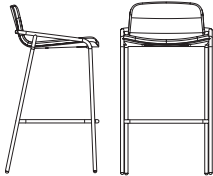

TO ORDER PLEASE SPECIFY THE FOLLOWING:

MODEL NUMBER	FSC	FRAME	GLIDE	GLWOOD	LAMINATE	FABRIC	FLAMMABILITY RATING
	No FSC X FSC Certified F +86	Polished Chrome PC +113 Black P71 Designer White PJW Matte Gold P8G Silver PR6 Pyrite PJE Solar Black P8X Titanium P8T Bullseye PJF Regatta P8M	Standard Black Nylon STD Swivel Glide w/ Nylon SVL0 +19 <i>Toggle Glide Option Pack page 42.</i>	Only on model GGLIV19-041 Cherry finishes on Quartered Ash Walnut finishes on Quartered Ash Maple finishes on Quartered Ash Oak finishes on Quartered Ash	Only on model GGLIV19-042 L1 and L2 Woodgrain Laminates +113	Only on models GGLIV19-043 and GGLIV19-044 Please refer to list of available upholstery and leather selections on www.gunlocke.com	U CTB117

Example

GGLIV19-043.X.PC.STD.DOL728.U							
GGLIV19-043	X	PC	STD	DOL728	U		
MODEL NUMBER	FSC	FRAME	GLIDE	FABRIC	FLAMMABILITY		

model number fabric grades dimensions W D H

GK9903N
Armless,
upholstered

1 946

Overall	20 3/4"	23"	33"
Seat		18"	18"
Arm			
Between Arms			

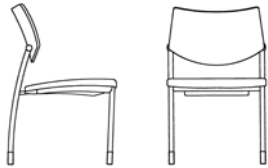

Upholstery Requirements: GK9903N

	Dual Upholstery	
Fabric yards	Seat 0.8	Back 0.5
Leather feet ²	Seat 13.6	Back 8.5
Shipping weight	35 lbs.	
Cube	17.8	

Seat

1	10	173	19	396	L1	184
2	17	11	193	20	L2	346
3	32	12	215	21	L3	538
COM/4	48	13	240	22	L4	698
5	68	14	266	23	L5	860
6	90	15	292	24		
7	110	16	319	25		
8	131	17	345	26		
9	152	18	370	27		

To calculate price of chair with different fabric for Seat and Back; start with Grade 1 price, add appropriate grade price located in second row for Seat, and last add appropriate grade price located in third row for Back to the sum of the Grade 1 and Seat price.

Example: Grade 1 \$946 + grade 4 fabric Seat/Back \$48 + grade 2 fabric Arms \$11 = \$1,005

Back

1	10	109	19	248	L1	116
2	11	11	121	20	L2	217
3	20	12	134	21	L3	336
COM/4	30	13	150	22	L4	436
5	44	14	167	23	L5	538
6	56	15	183	24		
7	70	16	199	25		
8	82	17	216	26		
9	95	18	232	27		

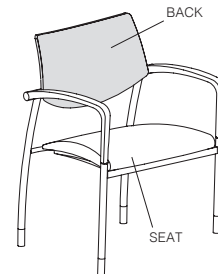

GK8907
Cart



655
Holds 5 stacked chairs. Metal cart available in black finish only. (Use with Multi or LIV chairs)

Overall	25 3/4"	25 7/8"	7 1/2"
Shipping weight	16 lbs.		
Cube	20.6		

TO ORDER PLEASE SPECIFY THE FOLLOWING:

<input type="text"/>	<input type="text"/>	<input type="text"/>	<input type="text"/>	<input type="text"/>	<input type="text"/>
MODEL NUMBER	FRAME	GANGING	FLAMMABILITY RATING	SEAT UPHOLSTERY	BACK UPHOLSTERY

This seating model is available with the following frame options. Please specify by adding suffix to model number.

NEW FINISHES

- P71 Black
- PR6 Silver
- P71C Black with Casters (+\$186)
- PR6C Silver with Casters (+\$186)

Ganging device on leg available. Please specify by adding suffix to model number.

- G Ganging device +\$34
- GN No Ganging

U CTB117

Select upholstery for the seat.
Please refer to list of available upholstery and leather selections on www.gunlocke.com

Select upholstery for the back.
Please refer to list of available upholstery and leather selections on www.gunlocke.com

Example

GK9903N.P71.GN.U.DOL728.SPNN04

GK9903N	P71	GN	U	DOL728	SPNN04
MODEL NUMBER	FRAME	GANGING	FLAMMABILITY RATING	SEAT UPHOLSTERY	BACK UPHOLSTERY

model number	fabric grades	dimensions	W	D	H
--------------	---------------	------------	---	---	---

GK9901P
Plastic Moderne Arm,
upholstered

1 1,104

Overall	24 1/2"	23"	33"
Seat		18"	18"
Arm			26 1/4"
Between Arms	20 3/4"		

Upholstery Requirements: GK9901P

	Dual Upholstery	
Fabric yards	Seat 0.8	Back 0.5
Leather feet ²	Seat 13.6	Back 8.5
Shipping weight	36 lbs.	
Cube	17.8	

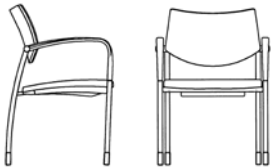

Seat	1	10	173	19	396	L1	184	
	2	17	11	193	20	422	L2	346
	3	32	12	215	21	448	L3	538
	COM/4	48	13	240	22	473	L4	698
	5	68	14	266	23	527	L5	860
	6	90	15	292	24	578		
	7	110	16	319	25	630		
	8	131	17	345	26	682		
	9	152	18	370	27	734		

To calculate price of chair with different fabric for Seat and Back; start with Grade 1 price, add appropriate grade price located in second row for Seat, and last add appropriate grade price located in third row for Back to the sum of the Grade 1 and Seat price.

Example: Grade 1 \$1,104 + grade 4 fabric Seat/Back \$48 + grade 2 fabric Arms \$11 = \$1,163

Back	1	10	109	19	248	L1	116	
	2	11	11	121	20	264	L2	217
	3	20	12	134	21	281	L3	336
	COM/4	30	13	150	22	296	L4	436
	5	44	14	167	23	329	L5	538
	6	56	15	183	24	361		
	7	70	16	199	25	394		
	8	82	17	216	26	427		
	9	95	18	232	27	459		

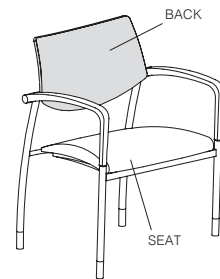

TO ORDER PLEASE SPECIFY THE FOLLOWING:

<input type="text"/>	<input type="text"/>	<input type="text"/>	<input type="text"/>	<input type="text"/>	<input type="text"/>
MODEL NUMBER	FRAME	GANGING	FLAMMABILITY RATING	SEAT UPHOLSTERY	BACK UPHOLSTERY
	This seating model is available with the following frame options. Please specify by adding suffix to model number. NEW FINISHES P71 Black PR6 Silver P71C Black with Casters (+\$186) PR6C Silver with Casters (+\$186)	Ganging device on leg available. Please specify by adding suffix to model number. G Ganging device +\$34 GN No Ganging	U CTB117	Select upholstery for the seat. Please refer to list of available upholstery and leather selections on www.gunlocke.com	Select upholstery for the back. Please refer to list of available upholstery and leather selections on www.gunlocke.com

Example

GK9901P.P71.GN.U.DOL728.SPNN04					
GK9901P	P71	GN	U	DOL728	SPNN04
MODEL NUMBER	FRAME	GANGING	FLAMMABILITY RATING	SEAT UPHOLSTERY	BACK UPHOLSTERY

Wood Moderne Arm, Upholstered

model number	fabric grades
GK9901W Wood Moderne Arm, upholstered	1 1,405

dimensions	W	D	H
Overall	24 1/2"	23"	33"
Seat		18"	18"
Arm			26 1/4"
Between Arms	20 3/4"		

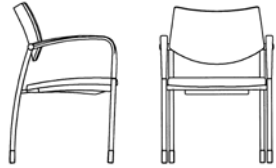

Upholstery Requirements: GK9901W

	Dual Upholstery	
Fabric yards	Seat 0.8	Back 0.5
Leather feet ²	Seat 13.6	Back 8.5
Shipping weight	36 lbs.	
Cube	17.8	

Seat	1	10	173	19	396	L1	184	
	2	17	11	193	20	422	L2	346
	3	32	12	215	21	448	L3	538
	COM/4	48	13	240	22	473	L4	698
	5	68	14	266	23	527	L5	860
	6	90	15	292	24	578		
	7	110	16	319	25	630		
	8	131	17	345	26	682		
	9	152	18	370	27	734		

To calculate price of chair with different fabric for Seat and Back; start with Grade 1 price, add appropriate grade price located in second row for Seat, and last add appropriate grade price located in third row for Back to the sum of the Grade 1 and Seat price.

Example: Grade 1 \$1,405 + grade 4 fabric Seat/Back \$48 + grade 2 fabric Arms \$11 = \$1,464

Back	1	10	109	19	248	L1	116	
	2	11	11	121	20	264	L2	217
	3	20	12	134	21	281	L3	336
	COM/4	30	13	150	22	296	L4	436
	5	44	14	167	23	329	L5	538
	6	56	15	183	24	361		
	7	70	16	199	25	394		
	8	82	17	216	26	427		
	9	95	18	232	27	459		

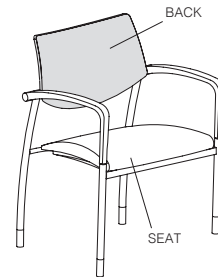

TO ORDER PLEASE SPECIFY THE FOLLOWING:

<input type="text"/>	<input type="text"/>	<input type="text"/>	<input type="text"/>	<input type="text"/>	<input type="text"/>	<input type="text"/>
MODEL NUMBER	FRAME	FINISH	GANGING	FLAMMABILITY RATING	SEAT UPHOLSTERY	BACK UPHOLSTERY
<p>This seating model is available with the following frame options. Please specify by adding suffix to model number.</p> <p>NEW FINISHES</p> <p>P71 Black</p> <p>PR6 Silver</p> <p>P71C Black with Casters (+\$186)</p> <p>PR6C Silver with Casters (+\$186)</p>		<p>Cherry finishes on Maple</p> <p>Walnut finishes on Maple</p> <p>Maple finishes on Maple</p> <p>Oak finishes on Maple</p> <p>Please refer to the Multi® product page on www.gunlocke.com for standard finish options.</p>	<p>Ganging device on leg available. Please specify by adding suffix to model number.</p> <p>G Ganging device +\$34</p> <p>GN No Ganging</p>	<p>U CTB117</p>	<p>Select upholstery for the seat.</p> <p>Please refer to list of available upholstery and leather selections on www.gunlocke.com</p>	<p>Select upholstery for the back.</p> <p>Please refer to list of available upholstery and leather selections on www.gunlocke.com</p>

Example

GK9901W.P71.GN.U.DOL728.SPNN04						
GK9901W	P71	215	GN	U	DOL728	SPNN04
MODEL NUMBER	FRAME	FINISH	GANGING RATING	FLAMMABILITY UPHOLSTERY	SEAT UPHOLSTERY	BACK

MULTI®

Wood Back

model number	fabric grades								dimensions	W	D	H
GK9907N Armless, upholstered seat, wood back	1	1,180	10	1,353	19	1,576	L1	1,364	Overall	20 3/4"	23"	33"
	2	1,197	11	1,373	20	1,602	L2	1,526	Seat		18"	18"
	3	1,212	12	1,395	21	1,628	L3	1,718	Upholstery Requirements: GK9907N			
	COM/4	1,228	13	1,420	22	1,653	L4	1,878	Fabric yards	0.8		
	5	1,248	14	1,446	23	1,707	L5	2,040	Leather feet ²	13.6		
	6	1,270	15	1,472	24	1,758			Shipping weight	35 lbs.		
	7	1,290	16	1,499	25	1,810			Cube	17.8		
	8	1,311	17	1,525	26	1,862						
	9	1,332	18	1,550	27	1,914						

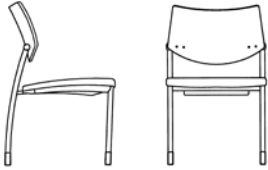

GK9905P Plastic Moderne Arm, upholstered seat, wood back	1	1,338	10	1,511	19	1,734	L1	1,522
	2	1,355	11	1,531	20	1,760	L2	1,684
	3	1,370	12	1,553	21	1,786	L3	1,876
	COM/4	1,386	13	1,578	22	1,811	L4	2,036
	5	1,406	14	1,604	23	1,865	L5	2,198
	6	1,428	15	1,630	24	1,916		
	7	1,448	16	1,657	25	1,968		
	8	1,469	17	1,683	26	2,020		
	9	1,490	18	1,708	27	2,072		

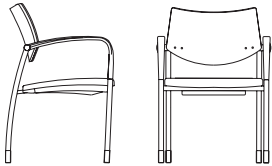

Overall	24 1/2"	23"	33"
Seat		18"	18"
Arm			26 1/4"
Between arms	20 3/4"		

Upholstery Requirements: GK9905P

Fabric yards	0.8
Leather feet ²	13.6
Shipping weight	36 lbs.
Cube	17.8

GK9905W Wood Moderne Arm, upholstered seat, wood back	1	1,626	10	1,799	19	2,022	L1	1,810
	2	1,643	11	1,819	20	2,048	L2	1,972
	3	1,658	12	1,841	21	2,074	L3	2,164
	COM/4	1,674	13	1,866	22	2,099	L4	2,324
	5	1,694	14	1,892	23	2,153	L5	2,486
	6	1,716	15	1,918	24	2,204		
	7	1,736	16	1,945	25	2,256		
	8	1,757	17	1,971	26	2,308		
	9	1,778	18	1,996	27	2,360		

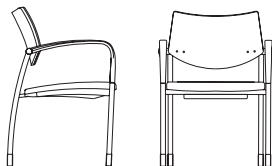

Overall	24 1/2"	23"	33"
Seat		18"	18"
Arm			26 1/4"
Between arms	20 3/4"		

Upholstery Requirements: GK9905W

Fabric yards	0.8
Leather feet ²	13.6
Shipping weight	36 lbs.
Cube	17.8

TO ORDER PLEASE SPECIFY THE FOLLOWING:

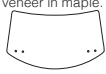
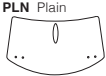
<input type="text"/>	<input type="text"/>	<input type="text"/>	<input type="text"/>	<input type="text"/>	<input type="text"/>	<input type="text"/>
MODEL NUMBER	FRAME	FINISH	BACK	GANGING	FLAMMABILITY RATING	SEAT UPHOLSTERY
<p>This seating model is available with the following frame options. Please specify by adding suffix to model number.</p> <p>NEW FINISHES</p> <p>P71 Black</p> <p>PR6 Silver</p> <p>P71C Black with Casters (+\$186)</p> <p>PR6C Silver with Casters (+\$186)</p>		<p>Cherry finishes on Maple</p> <p>Walnut finishes on Maple</p> <p>Maple finishes on Maple</p> <p>Oak finishes on Maple</p> <p>Please refer to the Multi® product page on www.gunlocke.com for standard finish options.</p>	<p>Back is formed of molded plywood with face veneer in maple.</p>  <p>PLN Plain</p>  <p>TDP Teardrop +\$113</p>	<p>Ganging device on leg available. Please specify by adding suffix to model number.</p> <p>G Ganging device +\$34</p> <p>GN No Ganging</p>	<p>U CTB117</p>	<p>Select upholstery for the back.</p> <p>Please refer to list of available upholstery and leather selections on www.gunlocke.com</p>

Example

GK9905N.P71.215.PLN.GN.U.DOL728

GK9905N	P71	215	PLN	U	DOL728
MODEL NUMBER	FRAME	FINISH	BACK	FLAMMABILITY RATING	SEAT UPHOLSTERY

model number	fabric grades	dimensions	W	D	H
GK9923N Armless, upholstered	1 1,279	Overall	24 1/2"	23"	43"
		Seat		18"	28"
		Arm			37"
		Between arms			
		Seat to Foot Rung			17"

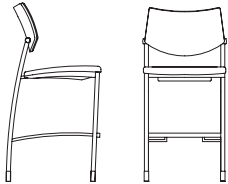

Upholstery Requirements: GK9923N

	Dual Upholstery	
Fabric yards	Seat 0.8	Back 0.5
Leather feet ²	Seat 13.6	Back 8.5
Shipping weight	40 lbs.	
Cube	19.1	

Seat	1	10	173	19	396	L1	184	
	2	17	11	193	20	422	L2	346
	3	32	12	215	21	448	L3	538
	COM/4	48	13	240	22	473	L4	698
	5	68	14	266	23	527	L5	860
	6	90	15	292	24	578		
	7	110	16	319	25	630		
	8	131	17	345	26	682		
	9	152	18	370	27	734		

To calculate price of chair with different fabric for Seat and Back; start with Grade 1 price, add appropriate grade price located in second row for Seat, and last add appropriate grade price located in third row for Back to the sum of the Grade 1 and Seat price.

Example: Grade 1 \$1,279 + grade 4 fabric Seat/back \$48 + grade 2 fabric Arms \$11 = \$1,338

Back	1	10	109	19	248	L1	116	
	2	11	11	121	20	264	L2	217
	3	20	12	134	21	281	L3	336
	COM/4	30	13	150	22	296	L4	436
	5	44	14	167	23	329	L5	538
	6	56	15	183	24	361		
	7	70	16	199	25	394		
	8	82	17	216	26	427		
	9	95	18	232	27	459		

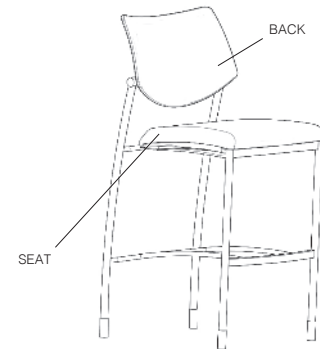

TO ORDER PLEASE SPECIFY THE FOLLOWING:

<input type="text"/>	<input type="text"/>	<input type="text"/>	<input type="text"/>	<input type="text"/>
MODEL NUMBER	FRAME	FLAMMABILITY RATING	SEAT UPHOLSTERY	BACK UPHOLSTERY
	This seating models are available with the following frame options. Please specify by adding suffix to model number. P71 Black PR6 Silver	U CTB117	Select upholstery for the seat. Please refer to list of available upholstery and leather selections on www.gunlocke.com	Select upholstery for the back. Please refer to list of available upholstery and leather selections on www.gunlocke.com

Example

GK9923N.P71.U.DOL728.SPNN04				
GK9923N	P71	U	DOL728	SPNN04
MODEL NUMBER	FRAME	FLAMMABILITY RATING	SEAT UPHOLSTERY	BACK UPHOLSTERY

model number fabric grades dimensions W D H

GK9961P
Plastic Moderne Arm,
upholstered

1 3,462

Overall	36 1/2"	26 1/4"	33 1/2"
Seat		19"	19"
Arm			27 1/4"
Between arms	33 1/4"		

Upholstery Requirements: GK9961P

	Dual Upholstery	
Fabric yards	Seat 0.9	Back 1.3
Leather feet ²	Seat 15.3	Back 22.1
Shipping weight	60 lbs.	
Cube	32.6	

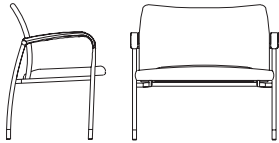

Seat	1	10	194	19	445	L1	208	
	2	19	11	218	20	474	L2	389
	3	36	12	242	21	504	L3	605
	COM/4	54	13	270	22	533	L4	785
	5	78	14	299	23	592	L5	967
	6	101	15	329	24	650		
	7	123	16	358	25	708		
	8	147	17	387	26	768		
	9	170	18	417	27	827		

To calculate price of chair with different fabric for Seat and Back; start with Grade 1 price, add appropriate grade price located in second row for Seat, and last add appropriate grade price located in third row for Back to the sum of the Grade 1 and Seat price.

Example: Grade 1 \$3,462 + grade 4 fabric Seat/back \$54 + grade 2 fabric Arms \$27 = \$3,543

Back	1	10	280	19	643	L1	298	
	2	27	11	314	20	685	L2	560
	3	52	12	348	21	728	L3	873
	COM/4	78	13	390	22	770	L4	1,135
	5	111	14	432	23	854	L5	1,396
	6	145	15	473	24	939		
	7	179	16	517	25	1,023		
	8	212	17	559	26	1,108		
	9	246	18	601	27	1,192		

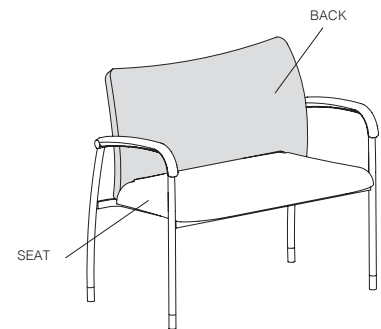

TO ORDER PLEASE SPECIFY THE FOLLOWING:

<input type="text"/>	<input type="text"/>	<input type="text"/>	<input type="text"/>	<input type="text"/>	<input type="text"/>	<input type="text"/>
MODEL NUMBER	FRAME	GANGING	FLAMMABILITY RATING	GORE BARRIER	SEAT UPHOLSTERY	BACK UPHOLSTERY
	P71 Black PR6 Silver	Ganging device on leg available. Please specify by adding suffix to model number. G Ganging device +\$34 GN No Ganging	U CTB117	GBN No Gore	Select upholstery for the seat. Please refer to list of available upholstery and leather selections on www.gunlocke.com	Select upholstery for the back. Please refer to list of available upholstery and leather selections on www.gunlocke.com

Example

GK9961P.P71.GN.U.GBN.DOL728.SPNN04

GK9961P	P71	GN	U	GBN	DOL728	SPNN04
MODEL NUMBER	FRAME	GANGING	FLAMMABILITY RATING	GORE BARRIER	SEAT UPHOLSTERY	BACK UPHOLSTERY

model number fabric grades

GK9961W 1 3,763
Wood Moderne Arm,
upholstered

dimensions W D H

Overall	36 1/2"	26 1/4"	33 1/2"
Seat		19"	19"
Arm			27 1/4"
Between arms	33 1/4"		

Upholstery Requirements: GK9961W

	Dual Upholstery	
Fabric yards	Seat 0.9	Back 1.3
Leather feet ²	Seat 15.3	Back 22.1
Shipping weight	60 lbs.	
Cube	32.6	

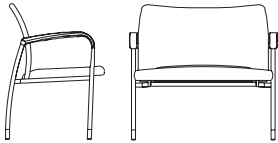

Seat

1	10	194	19	445	L1	208	
2	19	11	218	20	474	L2	389
3	36	12	242	21	504	L3	605
COM/4	54	13	270	22	533	L4	785
5	78	14	299	23	592	L5	967
6	101	15	329	24	650		
7	123	16	358	25	708		
8	147	17	387	26	768		
9	170	18	417	27	827		

To calculate price of chair with different fabric for Seat and Back; start with Grade 1 price, add appropriate grade price located in second row for Seat, and last add appropriate grade price located in third row for Back to the sum of the Grade 1 and Seat price.

Example: Grade 1 \$3,763 + grade 4 fabric Seat/back \$54 + grade 2 fabric Arms \$27 = \$3,844

Back

1	10	280	19	643	L1	298	
2	27	11	314	20	685	L2	560
3	52	12	348	21	728	L3	873
COM/4	78	13	390	22	770	L4	1,135
5	111	14	432	23	854	L5	1,396
6	145	15	473	24	939		
7	179	16	517	25	1,023		
8	212	17	559	26	1,108		
9	246	18	601	27	1,192		

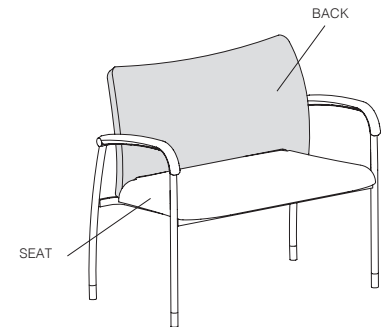

TO ORDER PLEASE SPECIFY THE FOLLOWING:

<input type="text"/>	<input type="text"/>	<input type="text"/>	<input type="text"/>	<input type="text"/>	<input type="text"/>	<input type="text"/>	<input type="text"/>
MODEL NUMBER	FRAME	FINISH	GANGING	FLAMMABILITY RATING	GORE BARRIER	SEAT UPHOLSTERY	BACK UPHOLSTERY
	P71 Black PR6 Silver	Cherry finishes on Maple Walnut finishes on Maple Maple finishes on Maple Oak finishes on Maple Please refer to the Multi® product page on www.gunlocke.com for standard finish options.	Ganging device on leg available. Please specify by adding suffix to model number. G Ganging device +\$34 GN No Ganging	U CTB117	GBN No Gore	Select upholstery for the seat. Please refer to list of available upholstery and leather selections on www.gunlocke.com	Select upholstery for the back. Please refer to list of available upholstery and leather selections on www.gunlocke.com

Example

GK9961W.P71.215.GN.U.GBN.DOL728.SPNN04

GK9961W	P71	215	GN	U	GBN	DOL728	SPNN04
MODEL NUMBER	FRAME	FINISH	GANGING	FLAMMABILITY RATING	GORE BARRIER	SEAT UPHOLSTERY	BACK UPHOLSTERY

TIA™ BARSTOOL

Bar Height | Single Upholstery

Seating
02/24

model number	fabric grades							dimensions	W	D	H	
GMHB17-011 Bar height, single upholstery	1	1,760	10	1,996	19	2,304	L1	2,014	Overall	19"	21 1/2"	40 5/8"
	2	1,782	11	2,026	20	2,340	L2	2,233	Seat	18 1/2"	16 3/4"	30 1/2"
	3	1,804	12	2,054	21	2,376	L3	2,500	Upholstery Requirements: GMHB17-011			
	COM/4	1,825	13	2,090	22	2,412	L4	2,720	Fabric yards	1.1		
	5	1,854	14	2,126	23	2,483	L5	2,941	Leather feet²	18.7		
	6	1,882	15	2,162	24	2,555			Shipping weight	31 lbs.		
	7	1,912	16	2,196	25	2,627			Cube	13.6		
	8	1,940	17	2,232	26	2,698			Note: Footrest for bar height Tia™ is 12 1/8" high off the floor.			
	9	1,969	18	2,268	27	2,769						



TO ORDER PLEASE SPECIFY THE FOLLOWING:

<input type="text"/>	<input type="text"/>	<input type="text"/>	<input type="text"/>	<input type="text"/>
MODEL NUMBER	FOOTREST COLOR	FINISH	FLAMMABILITY RATING	UPHOLSTERY

Polished Stainless **PS +\$57**
 Brushed Stainless **BS +\$57**
 Black Powder Coat **BK**
 White Powder Coat **WH**

These seating models are available in the following hardwoods:
 Maple **NE**
 Ash **QA**
 Please refer to the Tia product page on www.gunlocke.com for standard finish options.

U CTB117

Please refer to list of available upholstery and leather selections on www.gunlocke.com

Cherry finishes on Maple or Ash
Walnut finishes on Maple or Ash
Maple finishes on Maple or Ash
Oak finishes on Maple or Ash
Natural Cherry 222, Clear Maple 800, Clear Oak 300 and Fawn Cypress 108 not available on Ash.
Light Rift Oak 301 not available on Maple.

Example

GMHB17-011.PS.QA629.U.DOL728
 GMHB17-011 PS QA629 U DOL728
MODEL NUMBER FOOTREST COLOR FINISH FLAMMABILITY UPHOLSTERY

model number	fabric grades							dimensions	W	D	H	
GMHB17-041 Counter height, single upholstery	1	1,760	10	1,996	19	2,304	L1	2,014	Overall	19"	21 1/2"	36 3/8"
	2	1,782	11	2,026	20	2,340	L2	2,233	Seat	18 1/2"	16 3/4"	26 1/4"
	3	1,804	12	2,054	21	2,376	L3	2,500	Upholstery Requirements: GMHB17-041			
	COM/4	1,825	13	2,090	22	2,412	L4	2,720	Fabric yards	1.1		
	5	1,854	14	2,126	23	2,483	L5	2,941	Leather feet²	18.7		
	6	1,882	15	2,162	24	2,555			Shipping weight	30 lbs.		
	7	1,912	16	2,196	25	2,627			Cube	12.3		
	8	1,940	17	2,232	26	2,698			Note: Footrest for counter height Tia™ is 7 7/8" high off the floor.			
	9	1,969	18	2,268	27	2,769						



TO ORDER PLEASE SPECIFY THE FOLLOWING:

<input type="text"/>	<input type="text"/>	<input type="text"/>	<input type="text"/>	<input type="text"/>
MODEL NUMBER	FOOTREST COLOR	FINISH	FLAMMABILITY RATING	UPHOLSTERY

- Polished Stainless **PS +\$57**
- Brushed Stainless **BS +\$57**
- Black Powder Coat **BK**
- White Powder Coat **WH**

These seating models are available in the following hardwoods:
Maple **NE**
Ash **QA**

Please refer to the Tia product page on www.gunlocke.com for standard finish options.

Cherry finishes on Maple or Ash
Walnut finishes on Maple or Ash
Maple finishes on Maple or Ash
Oak finishes on Maple or Ash

*Natural Cherry 222, Clear Maple 800, Clear Oak 300 and Fawn Cypress 108 not available on Ash.
Light Rift Oak 301 not available on Maple.*

U CTB117

Please refer to list of available upholstery and leather selections on www.gunlocke.com

Example

GMHB17-041.PS.QA629.U.DOL728				
GMHB17-041	PS	QA629	U	DOL728
MODEL NUMBER	FOOTREST COLOR	FINISH	FLAMMABILITY	UPHOLSTERY

TRILLIA™ BARSTOOL

Upholstered Seat

Seating
02/24

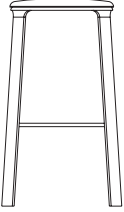
model number	fabric grades						dimensions	W	D	H		
GMQA16-011 Bar height, upholstered seat pad 	1	2,055	10	2,185	19	2,352	L1	2,195	Overall	17 5/8"	17 5/8"	30 H"
	2	2,067	11	2,201	20	2,372	L2	2,314	Seat	17 5/8"	17 5/8"	
	3	2,079	12	2,215	21	2,391	L3	2,459	Upholstery Requirements: GMQA16-011			
	COM/4	2,091	13	2,236	22	2,411	L4	2,579	Fabric yards	Seat pad	0.6	
	5	2,107	14	2,254	23	2,450	L5	2,699	Leather feet ²	Seat pad	10.2	
	6	2,122	15	2,275	24	2,489			Shipping weight	15 lbs.		
	7	2,138	16	2,294	25	2,527			Cube	8.3		
	8	2,153	17	2,313	26	2,566			Note: Footrest for Bar Height Trillia™ is 12" high off the floor.			
	9	2,170	18	2,334	27	2,607						

GMQA16-041 Counter height, upholstered seat pad 	1	2,055	10	2,185	19	2,352	L1	2,195	Overall	17 1/8"	17 1/8"	26 H"
	2	2,067	11	2,201	20	2,372	L2	2,314	Seat	17 1/8"	17 1/8"	
	3	2,079	12	2,215	21	2,391	L3	2,459	Upholstery Requirements: GMQA16-041			
	COM/4	2,091	13	2,236	22	2,411	L4	2,579	Fabric yards	Seat pad	0.6	
	5	2,107	14	2,254	23	2,450	L5	2,699	Leather feet ²	Seat pad	10.2	
	6	2,122	15	2,275	24	2,489			Shipping weight	14 lbs.		
	7	2,138	16	2,294	25	2,527			Cube	7.2		
	8	2,153	17	2,313	26	2,566			Note: Footrest for Counter Height Trillia™ is 7 3/4" high off the floor.			
	9	2,170	18	2,334	27	2,607						

GMQA16-071 Standard height, upholstered seat pad 	1	1,787	10	1,917	19	2,084	L1	1,927	Overall	16 1/4"	16 1/4"	19 3/8"
	2	1,799	11	1,933	20	2,104	L2	2,046	Seat	16 1/4"	16 1/4"	
	3	1,811	12	1,947	21	2,123	L3	2,191	Upholstery Requirements: GMQA16-071			
	COM/4	1,823	13	1,968	22	2,143	L4	2,311	Fabric yards	Seat pad	0.6	
	5	1,839	14	1,986	23	2,182	L5	2,431	Leather feet ²	Seat pad	10.2	
	6	1,854	15	2,007	24	2,221			Shipping weight	14 lbs.		
	7	1,870	16	2,026	25	2,259			Cube	4.8		
	8	1,885	17	2,045	26	2,298			Note: Footrest for Standard Height Trillia™ is 2 1/2" high off the floor.			
	9	1,902	18	2,066	27	2,339						

TO ORDER PLEASE SPECIFY THE FOLLOWING:

<input type="text"/>	<input type="text"/>	<input type="text"/>	<input type="text"/>	<input type="text"/>
MODEL NUMBER	SPECIES & FINISH	STITCH DETAIL	FLAMMABILITY RATING	UPHOLSTERY

These seating models are available in the following hardwoods:

Ash **QA**

Please refer to the Trillia product page on www.gunlocke.com for standard finish options.

Cherry finishes on Ash

Walnut finishes on Ash

Oak finishes on Ash

Natural Cherry 222, Ebony Maple 555, Clear Oak 300 and Fawn Cypress 108 not available on Ash.

Not Required **NR**
Stitch Detail **SD +\$91**

U CTB117

Please refer to list of available upholstery and leather selections on www.gunlocke.com

Example

GMQA16-011.QA601.SD.U.DOL728

GMQA16-011	QA601	SD	U	DOL728
MODEL NUMBER	FINISH	STITCH DETAIL	FLAMMABILITY	UPHOLSTERY

model number	list	dimensions	W	D	H
GMQA16-021 Bar height, wood seat	1,944	Overall	17 5/8"	17 5/8"	29 5/8"
		Seat	17 5/8"	17 5/8"	
		Shipping weight			13 lbs.
		Cube			8.1
		Note: Footrest for Bar Height Trillia™ is 12" high off the floor.			

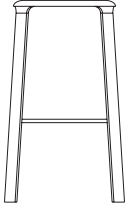

GMQA16-051 Counter height, wood seat	1,944	Overall	17 1/8"	17 1/8"	25 3/8"
		Seat	17 1/8"	17 1/8"	
		Shipping weight			12 lbs.
		Cube			7.0
		Note: Footrest for Counter Height Trillia™ is 7 3/4" high off the floor.			

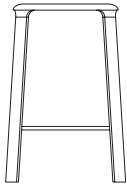

GMQA16-081 Standard height, wood seat	1,676	Overall	16 1/4"	16 1/4"	18 H"
		Seat	16 1/4"	16 1/4"	
		Shipping weight			12 lbs.
		Cube			4.6
		Note: Footrest for Standard Height Trillia™ is 2 1/2" high off the floor.			

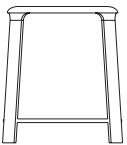

TO ORDER PLEASE SPECIFY THE FOLLOWING:

.

MODEL NUMBER **SPECIES & FINISH**

These seating models are available in the following hardwoods:

Ash **QA**

Please refer to the Trillia product page on www.gunlocke.com for standard finish options.

Cherry finishes on Ash

Walnut finishes on Ash

Oak finishes on Ash

Natural Cherry 222, Ebony Maple 555, Clear Oak 300 and Fawn Cypress 108 not available on Ash.

Example

GMQA16-021.QA601

GMQA16-021

QA601

MODEL NUMBER

FINISH

Swivel Seating 63-79
Swivel Seating Product Specifications 64-67
Avoca™ 68-69
Genesee 70-72
Geneva 73-74
Olla Executive 75-78
Washington Series 79

SWIVEL SEATING

Product Specifications

Seating
02/24

AVOCA™

Seat: High resilient foam overmolded onto rigid urethane pan, wrapped in 1/2" foam with additional 1/2" high resiliency foam topper.

Back: High resilient foam overmolded onto rigid urethane pan, wrapped in 1/4" foam with additional 1/2" high resiliency foam topper

Arm:

Full Urethane: Self-skinning urethane foam over steel structure.

Full Polished: Polished cast aluminum.

Polished with Urethane Insert: Polished cast aluminum with self-skinning urethane foam pad.

Control: Swivel-tilt with lockout. Or, premium Synchro-tilt with lockout, tilt tension, pneumatic height adjustment, and 3" range of seat depth adjustment.

Base: Black nylon plastic or die-cast polished aluminum 5 star.

Caster: Soft or Hard. Premium casters with chrome finish are optional.

Upholstery: French-stitch around edges, channel stitching optional.

BIFMA Rating:

ANSI/BIFMA X5.1 2017
(300lb Weight Rating)

GENESEE

Seat: High resiliency foam overmolded onto rigid urethane bucket, wrapped in 1/2" foam with additional 1/2" high resiliency foam topper.

Back: High resiliency foam overmolded onto rigid urethane bucket, wrapped in 1/2" foam.

Arm:

Polished aluminum: Polished cast aluminum.

Upholstered: Polished cast aluminum with routed upholstery groove, covered in J" high density foam, upholstery wrapped with welt cord to cover staples.

Control: Black mid-tilt control, tension adjustment, tilt lockout.

Base: Five-star, die-cast polished aluminum.

Casters: Soft or hard. Premium casters with chrome finish optional.

Upholstery: Top-stitch around edges of bucket.

BIFMA Rating:

ANSI/BIFMA X5.1 2017
(300lb Weight Rating)

GENEVA

Frame: Curved plywood

Seat and Back: Dacron over dual density cut foam.

Arm:

Full Urethane: Self-skinning urethane foam over steel structure

Polished with Urethane Insert: Polished cast aluminum with self-skinning urethane foam pad.

Control: Black mid-tilt control, tension adjustment, tilt lockout.

Base: Black nylon plastic or die-cast polished aluminum star.

Casters: Soft or hard.

BIFMA Rating:

ANSI/BIFMA X5.1 2017
(300lb Weight Rating)

OLLA SWIVEL

Seat and Back: Furniture-grade curved plywood covered with high-resiliency molded foam.

Seat and Back Wood Decor: Maple or Cherry Veneer over molded formed plywood (GK2804/GK2806).

Metal J-Bar Cover: Black, silver or polished aluminum.

Arm:

Adjustable Arm: Arm height range 4", Forward/Back 2", Width Adjustment 1". Arms available in black only.

Upholstered Arm: Cut foam over furniture-grade plywood.

Urethane Arm: Textured urethane.

Control: Synchronized tilt mechanism control, 5-position lock out, tension control and pneumatic height adjustment. The synchronized tilt ratio is 2.3 to 1 degree.

Seat Depth Adjustment: 2" range with 6 evenly spaced lockable positions.

Tilt Lock: 5 incremental positions. Back tilt travel 21 degrees rearward to a fully reclined position.

Base: 5-star base, die-cast aluminum. Available in black, silver and polished aluminum.

Casters: Soft or hard.

Upholstery: The back and seat upholstery is French-stitched.

BIFMA Rating:

ANSI/BIFMA X5.1 2017 w/ additional requirements (300lb Weight Rating, Adjustable Arms test to 275lbs)

WASHINGTON

Frame: Hardwood joined by Double dowels, corner blocked.

Seat: Spring seat platform with foam and cotton filling. Upholstered. Cushion material is fabricated foam and dacron filled. Welted.

Back: Foam, cotton, and dacron filled over spring foundation. Upholstered. Welted.

Arms: Upholstered over dacron and foam.

Swivel base: Five leg, with brass capped detail. Manual lift.

Casters: 2" Bronze Ball.

BIFMA Rating:

ANSI/BIFMA X5.1 2015 w/ additional requirements (400lb Weight Rating)

SWIVEL SEATING

Product Specifications

SWIVEL ERGONOMICS

Dual Point Synchro Tilt

In Synchronous tilt, the backrest and seat pan of a chair reclines at a different ratio (usually 2:1) as you lean back. For every 10 degrees of recline in the backrest for example, the seat pan only tilts back 5 degrees

Single Point Mid Tilt

Mid tilt employs a basic tilt mechanism that's located in the center or back of the seat to tilt the seat pan and backrest in tandem. The angle of the front of the seat increases at the same rate as the backrest.

Single Point Knee Tilt

With a Knee tilt, the pivoting point is located near the very front of the seat, resulting in a wide angle tilt that still keeps the front of the seat relatively level. Knee tilt combines some qualities of synchro and mid tilting. With the pivoting point near the front of the seat, your feet remain on the ground even with a larger recline in the seat pan and backrest.

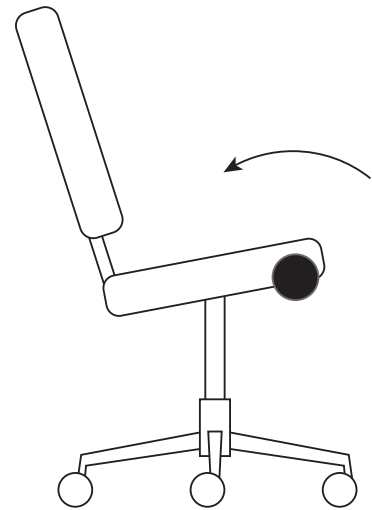
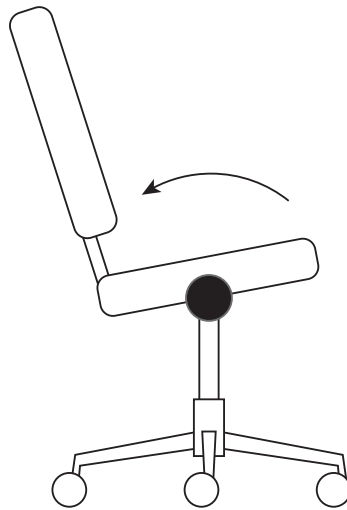
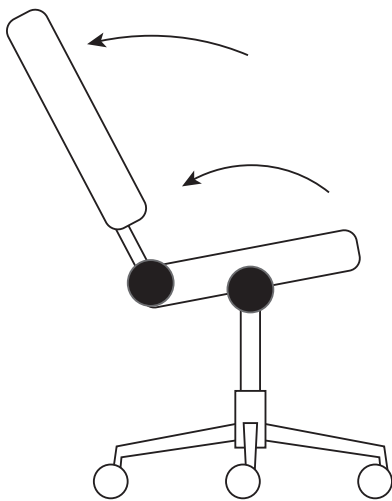

CONTROL HOW TO'S

Mid-Tilt and Knee Tilt Mechanism

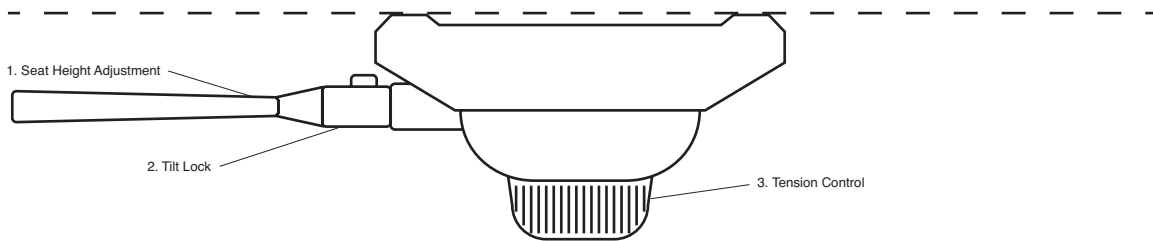

1. SEAT HEIGHT ADJUSTMENT

Slightly lift body weight off seat and pull up on paddle to increase or decrease height. Release lever to lock into desired height.

2. TILT LOCK

Push handle in towards center of control. This will lock the position of the tilt. Pull handle out to allow for free tilting.

3. TENSION CONTROL

Decrease tension by rotating the knob left. Increase tension by rotating the knob right.

Synchro-Tilt Mechanism

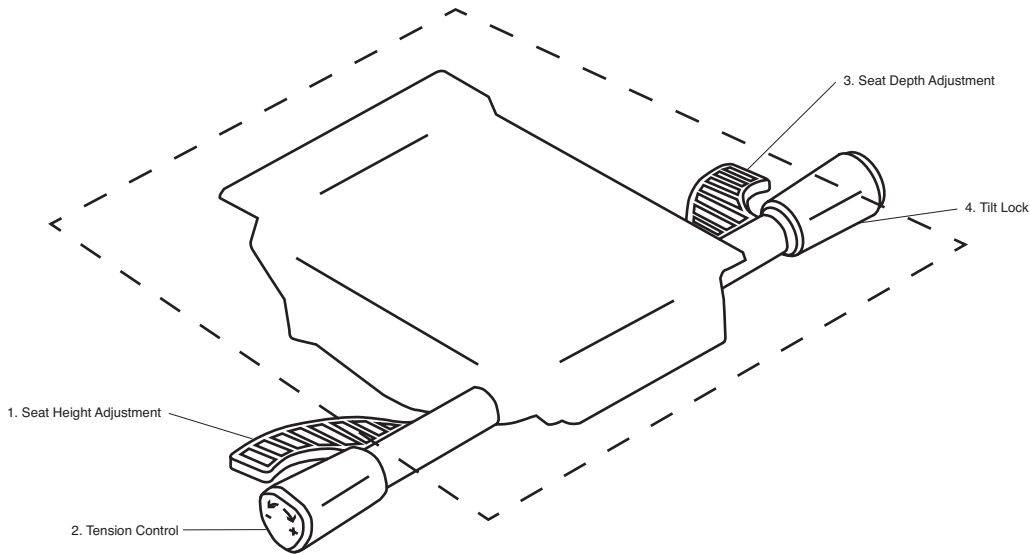

1. SEAT HEIGHT ADJUSTMENT

Slightly lift body weight off seat and pull up on paddle to increase height, or remain seated and pull up on paddle to decrease height. Release paddle to lock into desired height.

2. TENSION CONTROL

Extend Tension Control knob out to adjust. Increase tension by rotating the knob forward. Decrease tension by rotating the knob rearward. Push tension control knob in to original position when finished adjusting tension.

3. SEAT DEPTH ADJUSTMENT

Pull up on lever while seated and slide forward or rearward to desired depth. Release paddle handle to engage.

4. TILT LOCK

Lean back fully back in chair, then rotate handle forward to engage lockout. Rotate handle forward, then lean back into the chair to release the tilt lock feature.

Manual Mechanism

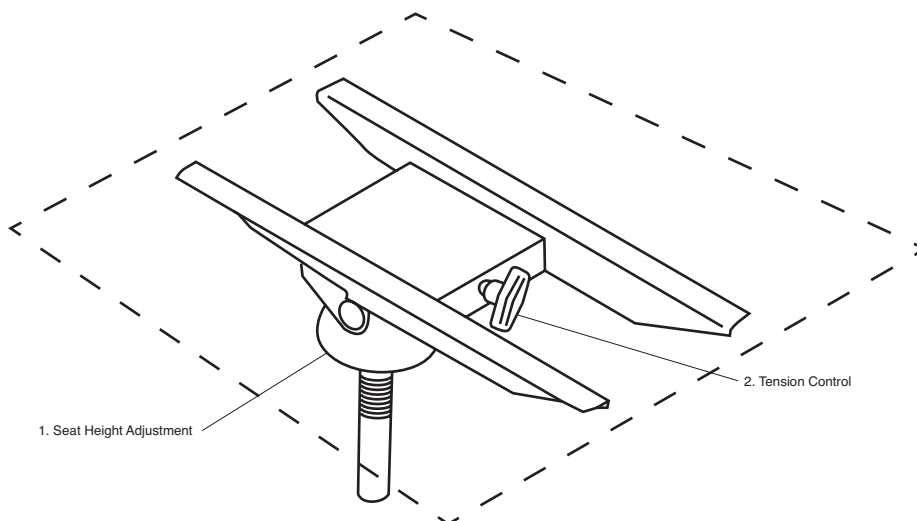

1. SEAT HEIGHT ADJUSTMENT

Slightly lift body weight off seat and rotate bell. Rotating to the right will lower the seat. Rotating to the left will raise seat.

2. TENSION CONTROL

Increase tension by rotating the knob to the right. Decrease tension by rotating the knob left.

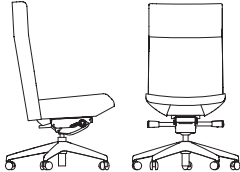
model number	fabric grades						dimensions	W	D	H		
GSHA15-011 High back, armless 	1	2,123	10	2,531	19	3,063	L1	2,559	Overall	26 11/16"	25 3/4"	40 11/16"
	2	2,161	11	2,581	20	3,125	L2	2,941	Seat	19-20"	19"	16 1/2 - 20 1/2"
	3	2,198	12	2,630	21	3,186	L3	3,400	Upholstery Requirements: GSHA15-011			
	COM/4	2,235	13	2,692	22	3,248	L4	3,781	Fabric yards	1.9		
	5	2,284	14	2,754	23	3,371	L5	4,163	Leather feet ²	32.3		
	6	2,334	15	2,816	24	3,494			Shipping weight	52 lbs.		
	7	2,383	16	2,877	25	3,618			Cube	21.6		
	8	2,432	17	2,939	26	3,742						
	9	2,482	18	3,001	27	3,865						

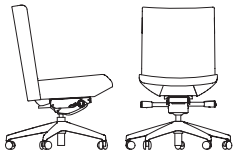
GSHA15-021 Mid back, armless 	1	1,957	10	2,302	19	2,749	L1	2,325	Overall	26 11/16"	25 3/4"	35 11/16"
	2	1,989	11	2,343	20	2,800	L2	2,647	Seat	19-20"	19"	16 1/2 - 20 1/2"
	3	2,021	12	2,385	21	2,853	L3	3,033	Upholstery Requirements: GSHA15-021			
	COM/4	2,051	13	2,436	22	2,904	L4	3,353	Fabric yards	1.6		
	5	2,092	14	2,488	23	3,009	L5	3,675	Leather feet ²	27.2		
	6	2,135	15	2,540	24	3,112			Shipping weight	51 lbs.		
	7	2,177	16	2,592	25	3,216			Cube	19.1		
	8	2,218	17	2,643	26	3,320						
	9	2,260	18	2,697	27	3,424						

Horizontal Channel Stitch Example:



High Back version shown; Mid Back version has channel stitching down entire back.

TO ORDER PLEASE SPECIFY THE FOLLOWING:

MODEL NUMBER	BASE	CASTER	CONTROL	STITCH DETAIL	FLAMMABILITY RATING	UPHOLSTERY
	These seating models are available with the following base option. BBL Black base BAL Polished Aluminum +\$113	CH2 Hard CS2 Soft +\$62 CHC2 Chrome, hard +\$96	P Swivel tilt SKP Synchro-Tilt, seat slider, pneumatic lift with lockout +\$142	NR Not required SD Horizontal Channel Stitch Detail \$142 NOTE: Avoca High Back comes standard with a single horizontal French stitch across the back when the Stitch Not Required (NR) option is chosen.	U CTB117	Please refer to list of available upholstery and leather selections on www.gunlocke.com

Example

GSHA15-011.BBL.CH2.P.NR.U.DOL728						
GSHA15-011	BBL	CH2	P	NR	U	DOL728
MODEL NUMBER	BASE	CASTER	CONTROL	STITCH DETAIL	FLAMMABILITY	UPHOLSTERY

model number	fabric grades								dimensions	W	D	H
GSHA15-031 High back with arms 	1	2,215	10	2,623	19	3,155	L1	2,651	Overall	26 11/16"	25 3/4"	40 11/16"
	2	2,253	11	2,673	20	3,217	L2	3,033	Seat	19-20"	19"	16 1/2" - 20 1/2"
	3	2,290	12	2,722	21	3,278	L3	3,492	Arm			24 7/8" - 28 7/8"
	COM/4	2,327	13	2,784	22	3,340	L4	3,873	Between arms	19 3/4"		
	5	2,376	14	2,846	23	3,463	L5	4,255	Upholstery Requirements: GSHA15-031			
	6	2,426	15	2,908	24	3,586			Fabric yards		1.9	
	7	2,475	16	2,969	25	3,710			Leather feet²		32.3	
	8	2,524	17	3,031	26	3,834			Shipping weight		56 lbs.	
	9	2,574	18	3,093	27	3,957			Cube		21.6	

GSHA15-041 Mid back with arms 	1	2,046	10	2,391	19	2,838	L1	2,414	Overall	26 11/16"	25 3/4"	35 11/16"
	2	2,078	11	2,432	20	2,889	L2	2,736	Seat	19-20"	19"	16 1/2" - 20 1/2"
	3	2,110	12	2,474	21	2,942	L3	3,122	Arm			24 7/8" - 28 7/8"
	COM/4	2,140	13	2,525	22	2,993	L4	3,442	Between arms	19 3/4"		
	5	2,181	14	2,577	23	3,098	L5	3,764	Upholstery Requirements: GSHA15-041			
	6	2,224	15	2,629	24	3,201			Fabric yards		1.6	
	7	2,266	16	2,681	25	3,305			Leather feet²		27.2	
	8	2,307	17	2,732	26	3,409			Shipping weight		55 lbs.	
	9	2,349	18	2,786	27	3,513			Cube		19.	

Horizontal Channel Stitch Example:



High Back version shown; Mid Back version has channel stitching down entire back.

TO ORDER PLEASE SPECIFY THE FOLLOWING:

MODEL NUMBER	ARM	BASE	CASTER	CONTROL	STITCH DETAIL	FLAMMABILITY RATING	UPHOLSTERY
	<p>These seating models are available with the following arm options.</p> <p>ABL Black Urethane Arm APA Full Polished Aluminum +\$169 API Polished Aluminum with Urethane Arm Cap +\$169</p>	<p>These seating models are available with the following base option.</p> <p>BBL Black base BAL Polished Aluminum +\$113</p>	<p>CH2 Hard CS2 Soft +\$62 CHC2 Chrome, hard +\$96</p>	<p>P Swivel tilt SKP Synchro-Tilt, seat slider, pneumatic lift with lockout +\$142</p>	<p>NR Not required SD Horizontal Channel Stitch Detail \$142 NOTE: Avoca High Back comes standard with a single horizontal French stitch across the back when the Stitch Not Required (NR) option is chosen.</p>	<p>U CTB117</p>	<p>Please refer to list of available upholstery and leather selections on www.gunlocke.com</p>

Example

GSHA15-031.ABL.BBL.CH2.P.NR.U.DOL728

MODEL NUMBER	ARM	BASE	CASTER	CONTROL	STITCH DETAIL	FLAMMABILITY	UPHOLSTERY
GSHA15-031	ABL	BBL	CH2	P	NR	U	DOL728

GENESEE

Armless

Seating
02/24

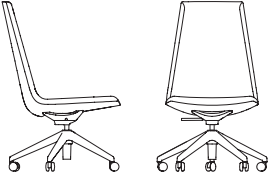
model number	fabric grades								dimensions	W	D	H
GSRA16-011 Swivel, High Back Armless 	1	2,704	10	3,156	19	3,743	L1	3,187	Overall	25 3/4"	28"	38 1/8" - 41 5/8"
	2	2,746	11	3,210	20	3,811	L2	3,609	Seat	21"	19 1/4"	17" - 20 1/2"
	3	2,787	12	3,264	21	3,880	L3	4,116	Upholstery Requirements: GSRA16-011			
	COM/4	2,827	13	3,333	22	3,947	L4	4,536	Fabric yards	1.6		
	5	2,883	14	3,401	23	4,084	L5	4,958	Leather feet ²	27.2		
	6	2,937	15	3,470	24	4,221			Shipping weight	44 lbs.		
	7	2,991	16	3,538	25	4,357			Cube	21.2		
	8	3,046	17	3,606	26	4,494						
	9	3,101	18	3,674	27	4,630						

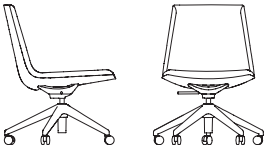
GSRA16-021 Swivel, Mid Back Armless 	1	2,543	10	2,909	19	3,384	L1	2,934	Overall	25 3/4"	26 1/2"	31 3/8" - 34 7/8"
	2	2,577	11	2,952	20	3,439	L2	3,275	Seat	21"	19 1/4"	17" - 20 1/2"
	3	2,610	12	2,998	21	3,494	L3	3,685	Upholstery Requirements: GSRA16-021			
	COM/4	2,644	13	3,052	22	3,550	L4	4,027	Fabric yards	1.5		
	5	2,688	14	3,108	23	3,660	L5	4,369	Leather feet ²	25.5		
	6	2,732	15	3,163	24	3,770			Shipping weight	42 lbs.		
	7	2,776	16	3,217	25	3,881			Cube	16.9		
	8	2,821	17	3,274	26	3,992						
	9	2,864	18	3,328	27	4,102						

TO ORDER PLEASE SPECIFY THE FOLLOWING:

<input type="text"/>	<input type="text"/>	<input type="text"/>	<input type="text"/>	<input type="text"/>
MODEL NUMBER	CASTER	CONTROL	FLAMMABILITY RATING	UPHOLSTERY
	CH2 Hard CS2 Soft +\$62 CHC2 Chrome, hard +\$96	P Low-profile, polished swivel-tilt, pneumatic lift. MP Black, mid tilt, pneumatic lift with lockout.	U CTB117	Please refer to list of available upholstery and leather selections on www.gunlocke.com

Example

GSRA16-011.CH2.P.U.DOL728				
GSRA16-011	CH2	P	U	DOL728
MODEL NUMBER	CASTER	CONTROL	FLAMMABILITY	UPHOLSTERY

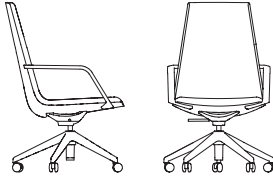
model number	fabric grades								dimensions	W	D	H
GSRA16-031 Swivel, High Back Polished Arms 	1	2,799	10	3,251	19	3,838	L1	3,282	Overall	27 1/2"	28"	38 1/8" - 41 5/8"
	2	2,841	11	3,305	20	3,906	L2	3,704	Seat	21"	19 1/4"	17" - 20 1/2"
	3	2,882	12	3,359	21	3,975	L3	4,211	Arm			23 1/2" - 27"
	COM/4	2,922	13	3,428	22	4,042	L4	4,631	Between arms	21"		
	5	2,978	14	3,496	23	4,179	L5	5,053	Upholstery Requirements: GSRA16-031			
	6	3,032	15	3,565	24	4,316			Fabric yards			1.6
	7	3,086	16	3,633	25	4,452			Leather feet ²			27.2
	8	3,141	17	3,701	26	4,589			Shipping weight			49 lbs.
	9	3,196	18	3,769	27	4,725			Cube			22.5

GSRA16-041 Swivel, Mid Back Polished Arms 	1	2,636	10	3,002	19	3,477	L1	3,027	Overall	27 1/2"	26 1/2"	31 3/8" - 34 7/8"
	2	2,670	11	3,045	20	3,532	L2	3,368	Seat	21"	19 1/4"	17" - 20 1/2"
	3	2,703	12	3,091	21	3,587	L3	3,778	Arm			23 1/2" - 27"
	COM/4	2,737	13	3,145	22	3,643	L4	4,120	Between arms	21"		
	5	2,781	14	3,201	23	3,753	L5	4,462	Upholstery Requirements: GSRA16-041			
	6	2,825	15	3,256	24	3,863			Fabric yards			1.5
	7	2,869	16	3,310	25	3,974			Leather feet ²			25.5
	8	2,914	17	3,367	26	4,085			Shipping weight			47 lbs.
	9	2,957	18	3,421	27	4,195			Cube			17.9

TO ORDER PLEASE SPECIFY THE FOLLOWING:

<input type="text"/>	<input type="text"/>	<input type="text"/>	<input type="text"/>	<input type="text"/>
MODEL NUMBER	CASTER	CONTROL	FLAMMABILITY RATING	UPHOLSTERY
	CH2 Hard CS2 Soft +\$62 CHC2 Chrome, hard +\$96	P Low-profile, polished swivel-tilt, pneumatic lift. MP Black, mid tilt, pneumatic lift with lockout.	U CTB117	Please refer to list of available upholstery and leather selections on www.gunlocke.com

Example

GSRA16-031.CH2.P.U.DOL728
 GSRA16-031 CH2 P U DOL728
 MODEL NUMBER CASTER CONTROL FLAMMABILITY UPHOLSTERY

GENESEE

Upholstered Arms

Seating
02/24

model number	fabric grades								dimensions	W	D	H
GSRA16-051 Swivel, High Back Upholstered Arms	1	2,936	10	3,408	19	4,024	L1	3,441	Overall	27 3/4"	28"	38 1/8" - 41 5/8"
	2	2,980	11	3,466	20	4,095	L2	3,883	Seat	21"	19 1/4"	17" - 20 1/2"
	3	3,022	12	3,523	21	4,166	L3	4,414	Arm			23 5/8" - 27 1/8"
	COM/4	3,066	13	3,595	22	4,238	L4	4,855	Between arms	20 3/4"		
	5	3,123	14	3,667	23	4,381	L5	5,298				
	6	3,181	15	3,738	24	4,525						
	7	3,237	16	3,809	25	4,667						
	8	3,294	17	3,881	26	4,811						
	9	3,352	18	3,952	27	4,953						

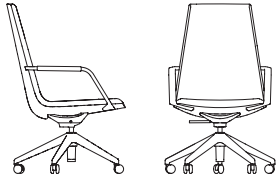

Upholstery Requirements: GSRA16-051

Fabric yards	1.9
Leather feet ²	32.3
Shipping weight	49 lbs.
Cube	22.7

GSRA16-061 Swivel, Mid Back Upholstered Arms	1	2,772	10	3,180	19	3,712	L1	3,208	Overall	27 3/4"	26 1/2"	31 3/8" - 34 7/8"
	2	2,810	11	3,230	20	3,774	L2	3,590	Seat	21"	19 1/4"	17" - 20 1/2"
	3	2,847	12	3,279	21	3,835	L3	4,049	Arm			23 5/8" - 27 1/8"
	COM/4	2,884	13	3,341	22	3,897	L4	4,430	Between arms	20 3/4"		
	5	2,933	14	3,403	23	4,020	L5	4,812				
	6	2,983	15	3,465	24	4,143						
	7	3,032	16	3,526	25	4,267						
	8	3,081	17	3,588	26	4,391						
	9	3,131	18	3,650	27	4,514						

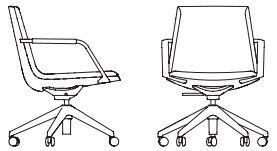

Upholstery Requirements: GSRA16-061

Fabric yards	1.6
Leather feet ²	27.2
Shipping weight	47 lbs.
Cube	18

TO ORDER PLEASE SPECIFY THE FOLLOWING:

<input type="text"/>	<input type="text"/>	<input type="text"/>	<input type="text"/>	<input type="text"/>
MODEL NUMBER	CASTER	CONTROL	FLAMMABILITY RATING	UPHOLSTERY
	CH2 Hard CS2 Soft +\$62 CHC2 Chrome, hard +\$96	P Low-profile, polished swivel-tilt, pneumatic lift. MP Black, mid tilt, pneumatic lift with lockout.	U CTB117	Please refer to list of available upholstery and leather selections on www.gunlocke.com

Example

GSRA16-051.CH2.P.215.U.DOL728
 GSRA16-051 CH2 P U DOL728
 MODEL NUMBER CASTER CONTROL FLAMMABILITY UPHOLSTERY

model number	fabric grades								dimensions	W	D	H
GSGNV17-011 High Back, Pillow Single Uph	1	2,230	10	2,747	19	3,417	L1	2,782	Overall	27 1/4"	27"	42-46"
	2	2,278	11	2,808	20	3,494	L2	3,264	Seat	20"	18"	16 1/2" - 20 1/2"
	3	2,324	12	2,871	21	3,573	L3	3,842	Arm			23" - 27"
	COM/4	2,372	13	2,948	22	3,650	L4	4,323	Between arms	21"		
	5	2,434	14	3,027	23	3,806	L5	4,807	Upholstery Requirements: GSGNV17-011			
	6	2,496	15	3,105	24	3,962			Fabric yards			2.4
	7	2,559	16	3,183	25	4,118			Leather feet ²			40.8
	8	2,621	17	3,260	26	4,274			Shipping weight			45 lbs.
	9	2,684	18	3,339	27	4,431			Cube			24.6

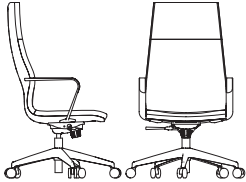

GSGNV17-051 Mid Back, Pillow Single Uph	1	2,046	10	2,476	19	3,035	L1	2,505
	2	2,087	11	2,528	20	3,100	L2	2,907
	3	2,125	12	2,580	21	3,165	L3	3,390
	COM/4	2,164	13	2,645	22	3,230	L4	3,791
	5	2,216	14	2,711	23	3,360	L5	4,194
	6	2,268	15	2,775	24	3,490		
	7	2,319	16	2,840	25	3,620		
	8	2,372	17	2,904	26	3,750		
	9	2,425	18	2,969	27	3,880		



Overall	27 1/4"	26 1/2"	33" - 37"
Seat	20"	18"	16 1/2" - 20 1/2"
Arm		23" - 27"	
Between arms	21"		
Upholstery Requirements: GSGNV17-051			
Fabric yards			2
Leather feet ²			34
Shipping weight			40 lbs.
Cube			19.5

TO ORDER PLEASE SPECIFY THE FOLLOWING:

<input type="text"/>	<input type="text"/>	<input type="text"/>	<input type="text"/>	<input type="text"/>	<input type="text"/>	<input type="text"/>
MODEL NUMBER	ARM	BASE	CONTROL	CASTER	FLAMMABILITY RATING	UPHOLSTERY
	ABL Full Urethane Arms API Polished with urethane insert +\$169	These seating models are available with the following base option. BBL Black base BAL Polished Aluminum +\$113	MP Black, mid tilt, pneumatic lift with lockout.	CH2 Hard CS2 Soft +\$62	U CTB17	Please refer to list of available upholstery and leather selections on www.gunlocke.com

Example

GSGNV17-011.ABL.BBL.MP.CH2.U.DOL728
 GSGNV17-011 ABL BBL MP CH2 U DOL728
 MODEL NUMBER ARM BASE CONTROL CASTER FLAMMABILITY UPHOLSTERY

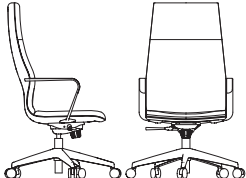
model number	fabric grades						dimensions	W	D	H
GSGNV17-031 High Back, Tight Single Uph	1	2,262	10	2,692	19	3,251	L1	2,721	Overall	27 1/4" 27" 42" -46"
	2	2,303	11	2,744	20	3,316	L2	3,123	Seat	20" 18" 16 1/2" - 20 1/2"
	3	2,341	12	2,796	21	3,381	L3	3,606	Arm	23" - 27"
	COM/4	2,380	13	2,861	22	3,446	L4	4,007	Between arms	21"
	5	2,432	14	2,927	23	3,576	L5	4,410	Upholstery Requirements: GSGNV17-031	
	6	2,484	15	2,991	24	3,706			Fabric yards	2
	7	2,535	16	3,056	25	3,836			Leather feet ²	34
	8	2,588	17	3,120	26	3,966			Shipping weight	45 lbs.
	9	2,641	18	3,185	27	4,096			Cube	24.6
										

GSGNV17-071 Mid Back, Tight Single Uph	1	2,075	10	2,483	19	3,015	L1	2,511	Overall	27 1/4" 26 1/2" 33" - 37"
	2	2,113	11	2,533	20	3,077	L2	2,893	Seat	20" 18" 16 1/2" - 20 1/2"
	3	2,150	12	2,582	21	3,138	L3	3,352	Arm	23" - 27"
	COM/4	2,187	13	2,644	22	3,200	L4	3,733	Between arms	21"
	5	2,236	14	2,706	23	3,323	L5	4,115	Upholstery Requirements: GSGNV17-071	
	6	2,286	15	2,768	24	3,446			Fabric yards	1.9
	7	2,335	16	2,829	25	3,570			Leather feet ²	32.3
	8	2,384	17	2,891	26	3,694			Shipping weight	40 lbs.
	9	2,434	18	2,953	27	3,817			Cube	19.5
										

TO ORDER PLEASE SPECIFY THE FOLLOWING:

MODEL NUMBER	ARM	BASE	CONTROL	CASTER	FLAMMABILITY RATING	FABRIC

- | | | | | | |
|---|---|--|---|------------------------|--|
| <p>ABL Full Urethane Arms</p> <p>API Polished with urethane insert
+\$169</p> | <p>These seating models are available with the following base option.</p> <p>BBL Black base</p> <p>BAL Polished Aluminum
+\$113</p> | <p>MP Black, mid tilt, pneumatic lift with lockout.</p> | <p>CH2 Hard</p> <p>CS2 Soft +\$62</p> | <p>U CTB117</p> | <p>Please refer to list of available upholstery and leather selections on www.gunlocke.com</p> |
|---|---|--|---|------------------------|--|

Example

GSGNV17-031.ABL.BBL.MP.CH2.U.DOL728

GSGNV17-031	ABL	BBL	MP	CH2	U	DOL728
MODEL NUMBER	ARM	BASE	CONTROL	CASTER	FLAMMABILITY	UPHOLSTERY

model number	fabric grades						dimensions	W	D	H		
GK2800 High back, fully upholstered, fixed arms	1	3,567	10	4,019	19	4,606	L1	4,050	Overall	26 1/2"	23 1/2"	43 1/2" - 47 1/2"
	2	3,609	11	4,073	20	4,674	L2	4,472	Seat		18 1/2"	17 3/4" - 21 1/2"
	3	3,650	12	4,127	21	4,743	L3	4,979	Arm			27 15/16"
	COM/4	3,690	13	4,196	22	4,810	L4	5,399	Between arms	19 1/2"		
	5	3,746	14	4,264	23	4,947	L5	5,821	Upholstery Requirements: GK2800			
	6	3,800	15	4,333	24	5,084			Fabric yards			2.1
	7	3,854	16	4,401	25	5,220			Leather feet ²			35.7
	8	3,909	17	4,469	26	5,357			Shipping weight			58 lb.
	9	3,964	18	4,537	27	5,493			Cube			24

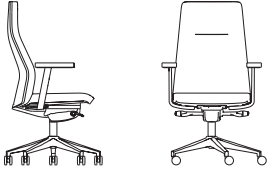

GK2804 High back, with Wood Décor, fixed arms	1	4,500	10	4,952	19	5,539	L1	4,983	Overall	26 1/2"	23 1/2"	43 1/2" - 47 1/2"
	2	4,542	11	5,006	20	5,607	L2	5,405	Seat		18"	17 3/4" - 21 3/4"
	3	4,583	12	5,060	21	5,676	L3	5,912	Arm			27 15/16"
	COM/4	4,623	13	5,129	22	5,743	L4	6,332	Between arms	19 1/2"		
	5	4,679	14	5,197	23	5,880	L5	6,754	Upholstery Requirements: GK2804			
	6	4,733	15	5,266	24	6,017			Fabric yards			2.1
	7	4,787	16	5,334	25	6,153			Leather feet ²			35.7
	8	4,842	17	5,402	26	6,290			Shipping weight			61 lb.
	9	4,897	18	5,470	27	6,426			Cube			24



TO ORDER PLEASE SPECIFY THE FOLLOWING:

MODEL NUMBER	METAL FINISH	CASTER	SEAT DEPTH ADJUSTMENT	ARM CAP	WOOD DECOR FINISH	FLAMMABILITY RATING	UPHOLSTERY
	Specified finish applies to Base, and Metal J-bar cover. Metal J-Bar cover located on back of wood décor (models GK2812 and GK2814). Adjustable Arm is available in Black only. BBL Black BSL Silver BAL Polished Aluminum +\$394	CH2 Hard CS2 Soft +\$62	These seating models are available with the following seat depth adjustment option. Please specify by adding suffix to model number. NSDA No Seat Depth-Adjustment SDA Seat Depth Adjustment +\$74	Please specify by adding suffix to model number. ARMUPH Upholstered Arm +\$197 ARMU Urethane Arm	Note: Required for GK2804 only Cherry finishes on Maple Walnut finishes on Maple Maple finishes on Maple Oak finishes on Maple Please refer to the Olla product page on www.gunlocke.com for standard finish options. <i>Natural Cherry 222 not available on Cherry.</i>	U CTB117	Please refer to list of available upholstery and leather selections on www.gunlocke.com

Example

GK2804.BAL.CH2.SDA.ARMUPH.NC701.U.DOL728

MODEL NUMBER	METAL FINISH	CASTER	SEAT DEPTH ADJUSTMENT	ARM CAP	WOOD DECOR FINISH	FLAMMABILITY	UPHOLSTERY
GK2804	BAL	CH2	SDA	ARMUPH	NC701	U	DOL728

OLLA EXECUTIVE

Conference | Fixed Arm | Mid Back

Seating
02/24

model number	fabric grades						dimensions	W	D	H
GK2802 Mid-back, fully upholstered, fixed arms	1	3,309	10	3,696	19	4,199	L1	3,724	Overall	26 1/2" 23 1/2" 39"- 43"
	2	3,345	11	3,743	20	4,257	L2	4,085	Seat	18" 17 3/4"- 21 3/4"
	3	3,381	12	3,789	21	4,316	L3	4,518	Arm	27 15/16"
	COM/4	3,416	13	3,848	22	4,375	L4	4,879	Between arms	19 1/2"
	5	3,462	14	3,906	23	4,492	L5	5,241		
	6	3,508	15	3,966	24	4,609				
	7	3,556	16	4,024	25	4,726				
	8	3,603	17	4,082	26	4,842				
	9	3,649	18	4,141	27	4,960				



Upholstery Requirements: GK2802

Fabric yards	1.8
Leather feet ²	30.6
Shipping weight	57 lb.
Cube	24

GK2806 Mid-back, with Wood Décor, fixed arms	1	4,171	10	4,558	19	5,061	L1	4,586
	2	4,207	11	4,605	20	5,119	L2	4,947
	3	4,243	12	4,651	21	5,178	L3	5,380
	COM/4	4,278	13	4,710	22	5,237	L4	5,741
	5	4,324	14	4,768	23	5,354	L5	6,103
	6	4,370	15	4,828	24	5,471		
	7	4,418	16	4,886	25	5,588		
	8	4,465	17	4,944	26	5,704		
	9	4,511	18	5,003	27	5,822		



Overall	26 1/2"	23 1/2"	39"- 43"
Seat	18"	17 3/4"- 21 3/4"	
Arm		27 15/16"	
Between arms	19 1/2"		

Upholstery Requirements: GK2806

Fabric yards	1.8
Leather feet ²	30.6
Shipping weight	60 lb.
Cube	24

TO ORDER PLEASE SPECIFY THE FOLLOWING:

MODEL NUMBER	METAL FINISH	CASTER	SEAT DEPTH ADJUSTMENT	ARM CAP	WOOD DECOR FINISH	FLAMMABILITY RATING	UPHOLSTERY
	Specified finish applies to Base, and Metal J-bar cover. Metal J-Bar cover located on back of wood décor (models GK2812 and GK2814). Adjustable Arm is available in Black only. BBL Black BSL Silver BAL Polished Aluminum +\$394	CH2 Hard CS2 Soft +\$62	These seating models are available with the following seat depth adjustment option. Please specify by adding suffix to model number. NSDA No Seat Depth Adjustment SDA Seat Depth Adjustment +\$74	Please specify by adding suffix to model number. ARMUPH Upholstered Arm +\$197 ARMU Urethane Arm	Note: Required for GK2806 only Cherry finishes on Maple Walnut finishes on Maple Maple finishes on Maple Oak finishes on Maple Please refer to the Olla product page on www.gunlocke.com for standard finish options. <i>Natural Cherry 222 not available on Cherry.</i>	U CTB117	Please refer to list of available upholstery and leather selections on www.gunlocke.com

Example

GK2806.BAL.CH2.SDA.ARMUPH.NC701.U.DOL728

MODEL NUMBER	METAL FINISH	CASTER	SEAT DEPTH ADJUSTMENT	ARM CAP	WOOD DECOR FINISH	FLAMMABILITY	UPHOLSTERY
GK2806	BAL	CH2	SDA	ARMUPH	NC701	U	DOL728

model number	fabric grades						dimensions	W	D	H		
GK2808 High back, fully upholstered, adjustable arms	1	3,567	10	4,019	19	4,606	L1	4,050	Overall	26 1/2"	23 1/2"	43 1/2" - 47 1/2"
	2	3,609	11	4,073	20	4,674	L2	4,472	Seat		18 1/2"	17 3/4" - 21 3/4"
	3	3,650	12	4,127	21	4,743	L3	4,979	Arm			25 1/2" - 29 1/2"
	COM/4	3,690	13	4,196	22	4,810	L4	5,399	Between arms	19 1/2"		
	5	3,746	14	4,264	23	4,947	L5	5,821	Upholstery Requirements: GK2808			
	6	3,800	15	4,333	24	5,084			Fabric yards		2.1	
	7	3,854	16	4,401	25	5,220			Leather feet ²		35.7	
	8	3,909	17	4,469	26	5,357			Shipping weight		57 lb.	
	9	3,964	18	4,537	27	5,493			Cube		24	



GK2812 High back, with Wood Décor, adjustable arms	1	4,500	10	4,952	19	5,539	L1	4,983	Overall	26 1/2"	23 1/2"	43 1/2" - 47 1/2"
	2	4,542	11	5,006	20	5,607	L2	5,405	Seat		18"	17 3/4" - 21 3/4"
	3	4,583	12	5,060	21	5,676	L3	5,912	Arm			25 1/2" - 29 1/2"
	COM/4	4,623	13	5,129	22	5,743	L4	6,332	Between arms	19 1/2"		
	5	4,679	14	5,197	23	5,880	L5	6,754	Upholstery Requirements: GK2812			
	6	4,733	15	5,266	24	6,017			Fabric yards		2.1	
	7	4,787	16	5,334	25	6,153			Leather feet ²		35.7	
	8	4,842	17	5,402	26	6,290			Shipping weight		60 lb.	
	9	4,897	18	5,470	27	6,426			Cube		24	

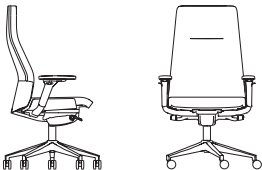

TO ORDER PLEASE SPECIFY THE FOLLOWING:

MODEL NUMBER	METAL FINISH	CASTER	SEAT DEPTH ADJUSTMENT	ARM CAP	WOOD DECOR FINISH	FLAMMABILITY RATING	UPHOLSTERY
	Specified finish applies to Base, and Metal J-bar cover. Metal J-Bar cover located on back of wood décor (models GK2812 and GK2814). Adjustable Arm is available in Black only. BBL Black BSL Silver BAL Polished Aluminum +\$394	CH2 Hard CS2 Soft +\$62	These seating models are available with the following seat depth adjustment option. Please specify by adding suffix to model number. NSDA No Seat Depth-Adjustment SDA Seat Depth Adjustment +\$74	Please specify by adding suffix to model number. ARMUPH Upholstered Arm +\$197 ARMU Urethane Arm	Note: Required for GK2812 only Cherry finishes on Maple Walnut finishes on Maple Maple finishes on Maple Oak finishes on Maple Please refer to the Olla product page on www.gunlocke.com for standard finish options. <i>Natural Cherry 222 not available on Cherry.</i>	U CTB117	Please refer to list of available upholstery and leather selections on www.gunlocke.com

Example

GK2812.BAL.CH2.SDA.ARMUPH.NC701.U.DOL728

MODEL NUMBER	METAL FINISH	CASTER	SEAT DEPTH ADJUSTMENT	ARM CAP	WOOD DECOR FINISH	FLAMMABILITY	UPHOLSTERY
GK2812	BAL	CH2	SDA	ARMUPH	NC701	U	DOL728

OLLA EXECUTIVE

Manager | Adjustable Arm | Mid Back

Seating
02/24

model number	fabric grades							dimensions	W	D	H	
GK2810 Mid-back, fully upholstered, adjustable arms	1	3,309	10	3,696	19	4,199	L1	3,724	Overall	26 1/2"	23 1/2"	39"- 43"
	2	3,345	11	3,743	20	4,257	L2	4,085	Seat		18"	17 3/4"- 21 3/4"
	3	3,381	12	3,789	21	4,316	L3	4,518	Arm			25 1/2"- 29 1/2"
	COM/4	3,416	13	3,848	22	4,375	L4	4,879	Between arms	19 1/2"		
	5	3,462	14	3,906	23	4,492	L5	5,241	Upholstery Requirements: GK2810			
	6	3,508	15	3,966	24	4,609			Fabric yards			1.8
	7	3,556	16	4,024	25	4,726			Leather feet ²			30.6
	8	3,603	17	4,082	26	4,842			Shipping weight			56 lb.
	9	3,649	18	4,141	27	4,960			Cube			24



GK2814 with Wood Décor, adjustable arms	1	4,171	10	4,558	19	5,061	L1	4,586	Overall	26 1/2"	23 1/2"	39"- 43"
	2	4,207	11	4,605	20	5,119	L2	4,947	Seat		18"	17 3/4"- 21 3/4"
	3	4,243	12	4,651	21	5,178	L3	5,380	Arm			25 1/2"- 29 1/2"
	COM/4	4,278	13	4,710	22	5,237	L4	5,741	Between arms	19 1/2"		
	5	4,324	14	4,768	23	5,354	L5	6,103	Upholstery Requirements: GK2814			
	6	4,370	15	4,828	24	5,471			Fabric yards			1.8
	7	4,418	16	4,886	25	5,588			Leather feet ²			30.6
	8	4,465	17	4,944	26	5,704			Shipping weight			59 lb.
	9	4,511	18	5,003	27	5,822			Cube			24



TO ORDER PLEASE SPECIFY THE FOLLOWING:

MODEL NUMBER	METAL FINISH	CASTER	SEAT DEPTH ADJUSTMENT	ARM CAP	WOOD DECOR FINISH	FLAMMABILITY RATING	UPHOLSTERY
	Specified finish applies to Base, and Metal J-bar cover. Metal J-Bar cover located on back of wood décor (models GK2812 and GK2814). Adjustable Arm is available in Black only. BBL Black BSL Silver BAL Polished Aluminum +\$394	CH2 Hard CS2 Soft +\$62	These seating models are available with the following seat depth adjustment option. Please specify by adding suffix to model number. NSDA No Seat Depth-Adjustment SDA Seat Depth Adjustment +\$74	Please specify by adding suffix to model number. ARMUPH Upholstered Arm +\$197 ARMU Urethane Arm	Note: Required for GK2814 only Cherry finishes on Maple Walnut finishes on Maple Maple finishes on Maple Oak finishes on Maple Please refer to the Olla product page on www.gunlocke.com for standard finish options. <i>Natural Cherry 222 not available on Cherry.</i>	U CTB117	Please refer to list of available upholstery and leather selections on www.gunlocke.com

Example

GK2814.BAL.CH2.SDA.ARMUPH.NC701.U.DOL728

MODEL NUMBER	METAL FINISH	CASTER	SEAT DEPTH ADJUSTMENT	ARM CAP	WOOD DECOR FINISH	FLAMMABILITY	UPHOLSTERY
GK2814	BAL	CH2	SDA	ARMUPH	NC701	U	DOL728

model number	fabric grades								dimensions	W	D	H
GK3006N Swivel	1	9,560	10	10,505	19	11,735	L1	10,570	Overall	28"	35"	45" - 47 1/2"
	2	9,646	11	10,619	20	11,877	L2	11,454	Seat		18 1/2"	19 1/2" - 22"
	3	9,733	12	10,733	21	12,021	L3	12,515	Arm			29 1/2" - 32"
	COM/4	9,818	13	10,877	22	12,163	L4	13,398	Between arms	20"		
	5	9,932	14	11,019	23	12,450	L5	14,282	Upholstery Requirements: GK3006N			
	6	10,047	15	11,163	24	12,736			Fabric yards		4.4	
	7	10,162	16	11,305	25	13,021			Leather feet ²		74.8	
	8	10,276	17	11,448	26	13,308			Shipping weight		95 lbs.	
	9	10,391	18	11,592	27	13,594			Cube		38.6	

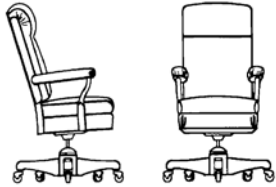

TO ORDER PLEASE SPECIFY THE FOLLOWING:

MODEL NUMBER	NAIL TRIM	FINISH	FLAMMABILITY RATING	UPHOLSTERY

Standard nail trim is available in two varieties. Please specify by adding suffix to model number.
NABR
Antique brass

Cherry finishes on Maple
Walnut finishes on Maple
Oak finishes on Maple
Maple finishes on Maple
Please refer to the Washington Series product page on www.gunlocke.com for standard finish options.

U CTB117

Please refer to list of available upholstery and leather selections on www.gunlocke.com

Example

GK3006N.NABR.215.U.DOL728				
GK3006N	NABR	215	U	DOL728
MODEL NUMBER	NAIL TRIM	FINISH	FLAMMABILITY	UPHOLSTERY

Lounge Seating81-171
Product Specifications. 82
Calm Lounge Ordering Option Codes. 84-85
Calm 86-104
Ciji 105-165
Iris 166-171

LOUNGE SEATING

Product Specifications

CALM

Frame: $\frac{3}{4}$ " x $\frac{3}{4}$ " steel legs with $\frac{3}{4}$ " x 2" cross rails, provides consistent $\frac{3}{4}$ " reveal on all sides.

Deck Frame: Constructed of $\frac{3}{4}$ " upholstery-grade plywood, assembled with box joint joinery using corner blocks, glue and fasteners.

Seat: Plywood seat frame foundation with stretched sheetwebbing suspension, covered with a 1" crown patch, and dual-layer 4 $\frac{1}{4}$ " foam and dacron.

Back: 2"D top surface tapers to 6 $\frac{1}{2}$ "D lumbar thickness for back support structure.

Back Pillows: 5" thick molded foam pillows, with tapered edges, wrapped in dacron. Has black velour panel on lower section of back surface, with HBF Heart-felt back panel used for attachment.

Note: Corner units must be used for modular turns when back support is needed – features two 5" pillows.

Arms: 2"W top surface tapers to 3 $\frac{1}{2}$ "W at bottom of arm.

Arm Pillows: 3" thick molded foam pillows with tapered edges, wrapped in dacron. Has black velour panel at lower section of back surface, with HBF Heart-felt back panel used for attachment.

Ganging Bracket: Black powder coated steel bracket, with slots to mount into 4 t-nuts (order bracket separately).

Glides: $\frac{1}{2}$ " adjustable, threaded steel and nylon leveling glides.

BIFMA Rating:

ANSI/BIFMA X5.4 2020
(275lb Weight Rating)

CIJI

Frame: Upholstery-grade plywood built, box joint construction (using corner blocks, glue and fasteners).

Seat & Back Cushions: Dacron and dual-layer foam over plywood base with flexible foundation, upholstered.

Wood Legs: Tapered, three-sided solid maple. Nickel-plated steel glide $\frac{5}{8}$ " diameter.

Metal Legs: Anodized extruded aluminum. Nickel-plated steel glide $\frac{3}{4}$ " diameter.

Stitch Detail Option: Quilted, single stitch. Available on plain fabrics only.

Ganging Bracket: Plastic male-female alligator clip, 2 pair per unit. (Order separately).

Note: Specify configuration of seating of seating as if you were seated.

Replacement arm can be installed left or right. The replacement seat is for single seat.

Order multiple units for two and three seat lounges and benches.

BIFMA Rating:

ANSI/BIFMA X5.4 2020
(275lb Weight Rating)

IRIS

Lounge Bucket: Fiberglass-reinforced rigid urethane, with overmolded foam and $\frac{1}{2}$ " foam topper, wrapped in dacron. Outside edges wrapped in high-resiliency foam.

Headrest: Fiberglass-reinforced rigid urethane, with overmolded foam, wrapped in dacron. Contains two pocketed steel rods to secure headrest to lounge bucket. Outside edge wrapped in high-resiliency foam.

Wood Legs: Four turned maple or ash hardwood legs, secured into steel assembly with mortise-and-tenon leg attachment. Legs mechanically fastened into steel assembly, inset into rigid urethane bucket. Wood legs taper narrower from top to bottom.

Glides: Nickel-plated steel.

Metal Lounge Base: Four-star metal base, standard with return-to-center cylinder, at a fixed seat height. Comes with low-profile swivel tilt control, with tilt lockout.

Metal Ottoman Base: Four-star metal base, standard with fixed post, at a fixed seat height.

BIFMA Rating:

ANSI/BIFMA X5.4 2020
(275lb Weight Rating)

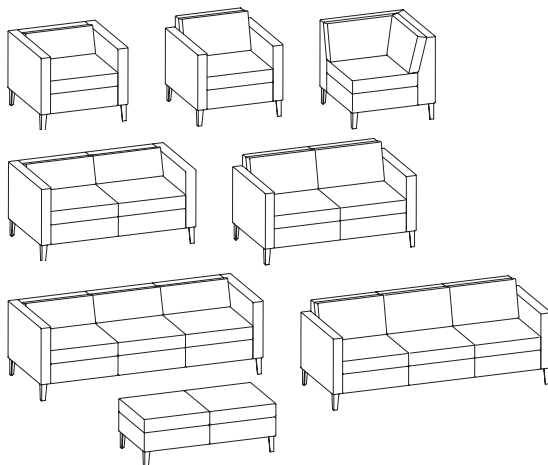

WOOD FINISH

SELECT VENEERS

NATURAL CHERRY

Cinnamon Cherry	NC260
Lowell Ash	NC394
Medium Red Cherry	NC512
Light Cherry	NC701
Shaker Cherry	NC774
Burnished Cherry	NC777

NATURAL PLAIN SLICED MAPLE

Natural Maple	NE800
Harvest Maple	NE856

NATURAL WALNUT

Light Walnut	NT601
Skyline Walnut	NT625
Nutmeg Walnut	NT629
Pinnacle Walnut	NT679
Sumatra Walnut	NT693
Ebony Walnut	NT555
Florence Walnut	NT579

VENEER 1 (SELECT)

STRATAWOOD CHERRY

Cinnamon/Biltmore	SC260
Lowell Ash	SC394
Clear	SC700
Light	SC701
Shaker	SC774
Burnished	SC777

STRATAWOOD MAPLE

Clear Maple	SE800
Harvest	SE856
Phantom Ecrú	SE912
(Use OP TopFin Only)	
Beigewood	SE878
Field Elm	SE599
Belair	SE934

STRATAWOOD WALNUT

Light	ST601
Skyline	ST625
Pinnacle	ST679
Sumatra	ST693
Florence Walnut	ST579

STRATAWOOD OAK

Clear	SF300
Dark	SF331

STRATAWOOD SILVER OAK

Clear	SB100
Portico Teak	SB150

STRATAWOOD WASHED WALNUT

Clear	SW600
Smoked Onyx	SW697
Smoked Grey	SW612

PREMIER VENEERS

NATURAL QUARTER CUT WALNUT

Light Walnut	QT601
Skyline Walnut	QT625
Nutmeg Walnut	QT629
Pinnacle Walnut	QT679
Sumatra Walnut	QT693
Ebony Walnut	QT555
Florence Walnut	QT579

NATURAL RIFT CUT OAK

Light Rift Cut Oak	RF301
Dark Rift Cut Oak	RF331
Phantom Ecrú	RF912
Fawn Cypress	RF108

UV TOP FINISH

Worksurfaces feature two low emitting UV finish options that enhance the beauty of natural wood and ensures the depth, clarity, color consistency and durability throughout the life of the product

Full-Fill Cleartech (upcharge)	FF
Open Pore Low Sheen	OP

Finish options are subject to change. For new finish information, visit us online www.gunlocke.com/finishsystem

LAMINATE

SELECT LAMINATES

SOLID – Grade 1

Designer White 15051	LDW1
Loft – Grey Cloud	LM11
Charcoal/Flint	LM16

WOODGRAIN – Grade 1

Natural Maple	LWD
Harvest Maple	C
Shaker Cherry	LW7C
Biltmore Cherry	COGN
Pinnacle Walnut	PINC
Florence Walnut	LFW1
Kingswood Walnut	LKI1
Neo Walnut	LNV1

WOODGRAIN – GRADE 2

Fawn Cypress	LFC1
Lowell Ash	LLA1
Natural Recon	LNR1
Phantom Ecu	LPE1
Portico Teak	LPT1
Skyline Walnut	LSW1
Veranda Teak	LVT1

GLASS (12mm soft etched)

Ice White -Designer White	GWH
Black	GBK
Muslin	GML

SOLID SURFACE (12mm solid)

Designer White	SDW4
Frosty White	SFW3
Night Stars	SNS5
Masoned Concrete	SMC2
Monte Amiata	SMA1

Finish options are subject to change. For new finish information, visit us online www.gunlocke.com/finishsystem

CALM

One Seat Lounge with Arms

Seating
02/24

model number	fabric grades	dimensions	W	D	H
GLGB17-011	1 4,342	Overall	32"	32"	30"
One seat, with arms		Seat	18"	21"	17"
		Arm			30"
		Between arms	18" - 21"		

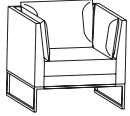

Upholstery Requirements: GLGB17-011

	Dual Upholstery	
Fabric yds	Cushion 4	Frame 5
Leather ft ²	Cushion 100	Frame 125
Shipping weight	95 lbs.	
Cube	23.4	

Cushion	1	10	833	19	1,919	L1	1,404
	2	76	11	935	20	2,045	L2 2,552
	3	152	12	1,035	21	2,172	L3 3,929
	COM/4	227	13	1,161	22	2,297	L4 5,077
	5	329	14	1,288	23	2,550	L5 6,223
	6	430	15	1,414	24	2,803	
	7	530	16	1,541	25	3,055	
	8	632	17	1,666	26	3,308	
	9	733	18	1,792	27	3,559	

To calculate price of lounge with different fabric for cushion and frame; start with Grade 1 price, add appropriate grade price located in second row for cushion, and last add appropriate grade price located in third row for frame to the sum of the Grade 1 and cushion price.

Example: Grade 1 \$4,342 + grade 4 fabric cushion \$227 + grade 2 fabric frame \$95 = \$4,664

Frame	1	10	1,041	19	2,398	L1	1,756
	2	95	11	1,168	20	2,557	L2 3,190
	3	190	12	1,294	21	2,714	L3 4,911
	COM/4	285	13	1,452	22	2,872	L4 6,345
	5	410	14	1,609	23	3,188	L5 7,780
	6	537	15	1,767	24	3,503	
	7	663	16	1,925	25	3,819	
	8	790	17	2,083	26	4,134	
	9	915	18	2,240	27	4,450	

Select upholstery for everything else other than the seat and back cushions (the outside back, arms, sides, seat frame). You can specify the same fabric as the cushions or select other fabric.

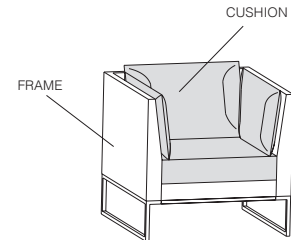

TO ORDER PLEASE SPECIFY THE FOLLOWING:

<input type="text"/>	<input type="text"/>	<input type="text"/>	<input type="text"/>	<input type="text"/>
MODEL NUMBER	FRAME COLOR	FLAMMABILITY RATING	CUSHION UPHOLSTERY	FRAME UPHOLSTERY
	Polished Chrome Brushed Chrome Steel Black Designer White Matte Gold Silver Solar Black Titanium Bullseye Regatta	PC +\$137 BS +\$137 P71 PJW P8G PR6 P8X P8T PJF P8M	U CTB117	Please refer to list of available upholstery and leather selections on www.gunlocke.com

Example

GLGB17-011.PC.U.DOL728.SPNN04				
GLGB17-011	PC	U	DOL728	SPNN04
MODEL NUMBER	FRAME COLOR	FLAMMABILITY	CUSHION UPHOLSTERY	FRAME UPHOLSTERY

model number	fabric grades	dimensions	W	D	H
GLGB17-021	1 3,692	Overall	25"	32"	30"
One seat, armless		Seat	25"	21"	17"



Upholstery Requirements: GLGB17-021

Dual Upholstery	
Fabric yds	Cushion 2.2 Frame 2.8
Leather ft ²	Cushion 55 Frame 70
Shipping weight	130 lbs.
Cube	18.7

Cushion

1	10	458	19	1,056	L1	773	
2	42	11	514	20	1,125	L2	1,404
3	83	12	569	21	1,194	L3	2,161
COM/4	126	13	639	22	1,264	L4	2,792
5	181	14	709	23	1,402	L5	3,423
6	237	15	778	24	1,542		
7	292	16	847	25	1,680		
8	347	17	917	26	1,820		
9	403	18	986	27	1,958		

To calculate price of lounge with different fabric for cushion and frame; start with Grade 1 price, add appropriate grade price located in second row for cushion, and last add appropriate grade price located in third row for frame to the sum of the Grade 1 and cushion price.

Example: Grade 1 \$3,692 + grade 4 fabric cushion \$126 + grade 2 fabric frame \$54 = \$3,872

Select upholstery for everything else other than the seat and back cushions (the outside back, arms, sides, seat frame). You can specify the same fabric as the cushions or select other fabric.

Frame

1	10	584	19	1,343	L1	984	
2	54	11	654	20	1,432	L2	1,787
3	106	12	725	21	1,520	L3	2,751
COM/4	160	13	814	22	1,608	L4	3,554
5	230	14	902	23	1,785	L5	4,357
6	301	15	990	24	1,961		
7	371	16	1,079	25	2,138		
8	442	17	1,167	26	2,316		
9	513	18	1,255	27	2,492		

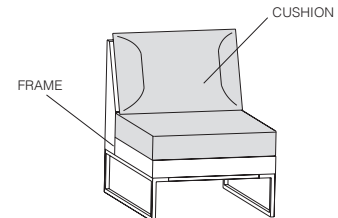

TO ORDER PLEASE SPECIFY THE FOLLOWING:

<input type="text"/>	<input type="text"/>	<input type="text"/>	<input type="text"/>	<input type="text"/>
MODEL NUMBER	FRAME COLOR	FLAMMABILITY RATING	CUSHION UPHOLSTERY	FRAME UPHOLSTERY
	Polished Chrome Brushed Chrome Steel Black Designer White Matte Gold Silver Solar Black Titanium Bullseye Regatta	PC +\$137 BS +\$137 P71 PJW P8G PR6 P8X P8T PJF P8M	U CTB117	Please refer to list of available upholstery and leather selections on www.gunlocke.com

Example

GLGB17-021.PC.U.DOL728.SPNN04

GLGB17-021	PC	U	DOL728	SPNN04
MODEL NUMBER	FRAME COLOR	FLAMMABILITY	CUSHION UPHOLSTERY	FRAME UPHOLSTERY

CALM

One Seat Lounge, Arm Left

Seating
02/24

model number	fabric grades	dimensions	W	D	H
GLGB17-031	1 4,016	Overall	28 1/2"	32"	30"
One seat, arm left		Seat	21 1/2"	21"	17"
		Arm			30"



Upholstery Requirements: GLGB17-031

	Dual Upholstery	
Fabric yds	Cushion 3	Frame 3.5
Leather ft ²	Cushion 75	Frame 87.5
Shipping weight	140 lbs.	
Cube	21.1	

Cushion

1	10	625	19	1,439	L1	1,053	
2	57	11	701	20	1,534	L2	1,915
3	114	12	777	21	1,629	L3	2,947
COM/4	171	13	871	22	1,724	L4	3,808
5	247	14	966	23	1,912	L5	4,668
6	322	15	1,061	24	2,102		
7	398	16	1,155	25	2,292		
8	474	17	1,250	26	2,480		
9	550	18	1,344	27	2,670		

To calculate price of lounge with different fabric for cushion and frame; start with Grade 1 price, add appropriate grade price located in second row for cushion, and last add appropriate grade price located in third row for frame to the sum of the Grade 1 and cushion price.

Example: Grade 1 \$4,016 + grade 4 fabric cushion \$171 + grade 2 fabric frame \$67 = \$4,254

Select upholstery for everything else other than the seat and back cushions (the outside back, arms, sides, seat frame). You can specify the same fabric as the cushions or select other fabric.

Frame

1	10	730	19	1,679	L1	1,229	
2	67	11	818	20	1,789	L2	2,233
3	133	12	906	21	1,900	L3	3,438
COM/4	199	13	1,016	22	2,010	L4	4,442
5	287	14	1,126	23	2,232	L5	5,446
6	375	15	1,238	24	2,452		
7	465	16	1,348	25	2,673		
8	553	17	1,458	26	2,893		
9	641	18	1,569	27	3,115		

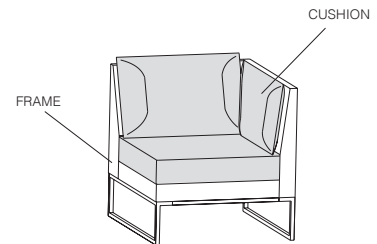

TO ORDER PLEASE SPECIFY THE FOLLOWING:

<input type="text"/>	<input type="text"/>	<input type="text"/>	<input type="text"/>	<input type="text"/>
MODEL NUMBER	FRAME COLOR	FLAMMABILITY RATING	CUSHION UPHOLSTERY	FRAME UPHOLSTERY
	Polished Chrome Brushed Chrome Steel Black Designer White Matte Gold Silver Solar Black Titanium Bullseye Regatta	PC +\$137 BS +\$137 P71 PJW P8G PR6 P8X P8T PJF P8M	U CTB117 Please refer to list of available upholstery and leather selections on www.gunlocke.com	Please refer to list of available upholstery and leather selections on www.gunlocke.com

Example

GLGB17-031.PC.U.DOL728.SPNN04				
GLGB17-031	PC	U	DOL728	SPNN04
MODEL NUMBER	FRAME COLOR	FLAMMABILITY	CUSHION UPHOLSTERY	FRAME UPHOLSTERY

model number	fabric grades	dimensions	W	D	H
GLGB17-041	1 4,016	Overall	28 1/2"	32"	30"
One seat, arm right		Seat	21 1/2"	21"	17"
		Arm			30"

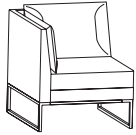

Upholstery Requirements: GLGB17-041

	Dual Upholstery	
Fabric yds	Cushion 3	Frame 3.5
Leather ft ²	Cushion 75	Frame 87.5
Shipping weight	140 lbs.	
Cube	21.1	

Cushion

1	10	625	19	1,439	L1	1,053	
2	57	11	701	20	1,534	L2	1,915
3	114	12	777	21	1,629	L3	2,947
COM/4	171	13	871	22	1,724	L4	3,808
5	247	14	966	23	1,912	L5	4,668
6	322	15	1,061	24	2,102		
7	398	16	1,155	25	2,292		
8	474	17	1,250	26	2,480		
9	550	18	1,344	27	2,670		

To calculate price of lounge with different fabric for cushion and frame; start with Grade 1 price, add appropriate grade price located in second row for cushion, and last add appropriate grade price located in third row for frame to the sum of the Grade 1 and cushion price.

Example: Grade 1 \$4,016 + grade 4 fabric cushion \$171 + grade 2 fabric frame \$67 = \$4,254

Frame

1	10	730	19	1,679	L1	1,229	
2	67	11	818	20	1,789	L2	2,233
3	133	12	906	21	1,900	L3	3,438
COM/4	199	13	1,016	22	2,010	L4	4,442
5	287	14	1,126	23	2,232	L5	5,446
6	375	15	1,238	24	2,452		
7	465	16	1,348	25	2,673		
8	553	17	1,458	26	2,893		
9	641	18	1,569	27	3,115		

Select upholstery for everything else other than the seat and back cushions (the outside back, arms, sides, seat frame). You can specify the same fabric as the cushions or select other fabric.

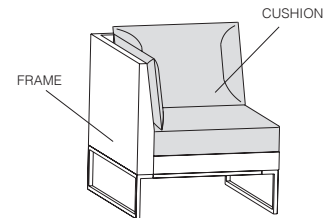

TO ORDER PLEASE SPECIFY THE FOLLOWING:

<input type="text"/>	<input type="text"/>	<input type="text"/>	<input type="text"/>	<input type="text"/>
MODEL NUMBER	FRAME COLOR	FLAMMABILITY RATING	CUSHION UPHOLSTERY	FRAME UPHOLSTERY
	Polished Chrome Brushed Chrome Steel Black Designer White Matte Gold Silver Solar Black Titanium Bullseye Regatta	PC +\$137 BS +\$137 P71 PJW P8G PR6 P8X P8T PJF P8M	U CTB117	Please refer to list of available upholstery and leather selections on www.gunlocke.com
				Please refer to list of available upholstery and leather selections on www.gunlocke.com

Example

GLGB17-041.PC.U.DOL728.SPNN04				
GLGB17-041	PC	U	DOL728	SPNN04
MODEL NUMBER	FRAME COLOR	FLAMMABILITY	CUSHION UPHOLSTERY	FRAME UPHOLSTERY

CALM

Two Seat Lounge with Arms

Seating
02/24

model number	fabric grades	dimensions	W	D	H
GLGB17-052	1 5,950	Overall	57"	32"	30"
Two seat, with arms		Seat	43"	21"	17"
		Arm			30"
		Between arms	43" - 46"		

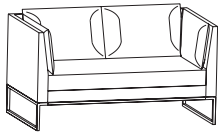

Upholstery Requirements: GLGB17-052

	Dual Upholstery	
Fabric yds	Cushion 6	Frame 6.5
Leather ft ²	Cushion 150	Frame 162.5
Shipping weight	190 lbs.	
Cube	40.1	

Cushion	1	10	1,250	19	2,878	L1	2,107	
	2	114	11	1,401	20	3,068	L2	3,829
	3	227	12	1,553	21	3,256	L3	5,893
	COM/4	342	13	1,742	22	3,446	L4	7,614
	5	493	14	1,932	23	3,824	L5	9,335
	6	645	15	2,121	24	4,204		
	7	795	16	2,310	25	4,582		
	8	947	17	2,500	26	4,961		
	9	1,098	18	2,688	27	5,339		

To calculate price of lounge with different fabric for cushion and frame; start with Grade 1 price, add appropriate grade price located in second row for cushion, and last add appropriate grade price located in third row for frame to the sum of the Grade 1 and cushion price.

Example: Grade 1 \$5,950 + grade 4 fabric cushion \$342 + grade 2 fabric frame \$124 = \$6,416

Select upholstery for everything else other than the seat and back cushions (the outside back, arms, sides, seat frame). You can specify the same fabric as the cushions or select other fabric.

Frame	1	10	1,354	19	3,118	L1	2,283	
	2	124	11	1,518	20	3,323	L2	4,147
	3	247	12	1,682	21	3,528	L3	6,385
	COM/4	370	13	1,887	22	3,733	L4	8,249
	5	534	14	2,092	23	4,144	L5	10,114
	6	698	15	2,297	24	4,553		
	7	862	16	2,503	25	4,963		
	8	1,026	17	2,708	26	5,374		
	9	1,190	18	2,913	27	5,784		

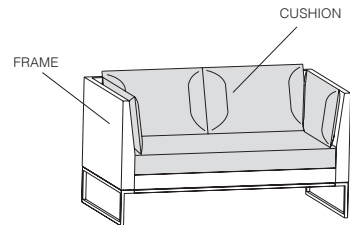

TO ORDER PLEASE SPECIFY THE FOLLOWING:

MODEL NUMBER	FRAME COLOR	FLAMMABILITY RATING	CUSHION UPHOLSTERY	FRAME UPHOLSTERY
<input type="text"/>	<input type="text"/>	<input type="text"/>	<input type="text"/>	<input type="text"/>
	Polished Chrome Brushed Chrome Steel Black Designer White Matte Gold Silver Solar Black Titanium Bullseye Regatta	PC +\$164 BS +\$164 P71 PJW P8G PR6 P8X P8T PJF P8M	U CTB117 Please refer to list of available upholstery and leather selections on www.gunlocke.com	Please refer to list of available upholstery and leather selections on www.gunlocke.com

Example

GLGB17-052	PC	U	DOL728	SPNNO4
MODEL NUMBER	FRAME COLOR	FLAMMABILITY	CUSHION UPHOLSTERY	FRAME UPHOLSTERY

model number	fabric grades	dimensions	W	D	H
GLGB17-062	1 5,057	Overall	50"	32"	30"
Two seat, armless		Seat	50"	21"	17"

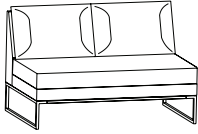

Upholstery Requirements: GLGB17-062

Dual Upholstery	
Fabric yds	Cushion 4.2 Frame 3.8
Leather ft ²	Cushion 105 Frame 95
Shipping weight	170 lbs.
Cube	35.4

Cushion

1	10	875	19	2,015	L1	1,475
2	80	11	981	20	L2	2,680
3	160	12	1,087	21	L3	4,125
COM/4	239	13	1,220	22	L4	5,331
5	345	14	1,352	23	L5	6,535
6	451	15	1,485	24		
7	557	16	1,617	25		
8	663	17	1,750	26		
9	769	18	1,882	27		

To calculate price of lounge with different fabric for cushion and frame; start with Grade 1 price, add appropriate grade price located in second row for cushion, and last add appropriate grade price located in third row for frame to the sum of the Grade 1 and cushion price.

Example: Grade 1 \$5,057 + grade 4 fabric cushion \$239 + grade 2 fabric frame \$72 = \$5,368

Select upholstery for everything else other than the seat and back cushions (the outside back, arms, sides, seat frame). You can specify the same fabric as the cushions or select other fabric.

Frame

1	10	792	19	1,823	L1	1,335
2	72	11	888	20	L2	2,425
3	144	12	984	21	L3	3,733
COM/4	216	13	1,104	22	L4	4,823
5	312	14	1,223	23	L5	5,913
6	408	15	1,343	24		
7	504	16	1,463	25		
8	600	17	1,583	26		
9	696	18	1,703	27		

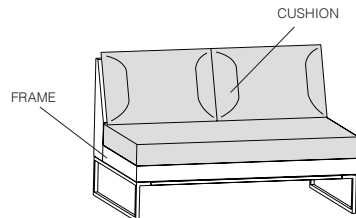

TO ORDER PLEASE SPECIFY THE FOLLOWING:

MODEL NUMBER	FRAME COLOR	FLAMMABILITY RATING	CUSHION UPHOLSTERY	FRAME UPHOLSTERY
	Polished Chrome Brushed Chrome Steel Black Designer White Matte Gold Silver Solar Black Titanium Bullseye Regatta	PC +\$164 BS +\$164 P71 PJW P8G PR6 P8X P8T PJF P8M	U CTB117 Please refer to list of available upholstery and leather selections on www.gunlocke.com	Please refer to list of available upholstery and leather selections on www.gunlocke.com

Example

GLGB17-062.PC.U.DOL728.SPNN04

GLGB17-062	PC	U	DOL728	SPNN04
MODEL NUMBER	FRAME COLOR	FLAMMABILITY	CUSHION UPHOLSTERY	FRAME UPHOLSTERY

CALM

Two Seat Lounge, Arm Left

Seating
02/24

model number	fabric grades	dimensions	W	D	H
GLGB17-072	1 5,504	Overall	53 1/2"	32"	30"
Two seat, arm left		Seat	46 1/2"	19 1/4"	17 "
		Arm			30"

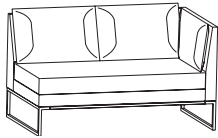

Upholstery Requirements: GLGB17-072

	Dual Upholstery	
Fabric yds	Cushion 5	Frame 4.75
Leather ft ²	Cushion 125	Frame 118.8
Shipping weight	180 lbs.	
Cube	37.8	

Cushion	1	10	1,041	19	2,398	L1	1,756	
	2	95	11	1,168	20	2,557	L2	3,190
	3	190	12	1,294	21	2,714	L3	4,911
	COM/4	285	13	1,452	22	2,872	L4	6,345
	5	410	14	1,609	23	3,188	L5	7,780
	6	537	15	1,767	24	3,503		
	7	663	16	1,925	25	3,819		
	8	790	17	2,083	26	4,134		
	9	915	18	2,240	27	4,450		

To calculate price of lounge with different fabric for cushion and frame; start with Grade 1 price, add appropriate grade price located in second row for cushion, and last add appropriate grade price located in third row for frame to the sum of the Grade 1 and cushion price.

Example: Grade 1 \$5,504 + grade 4 fabric cushion \$285 + grade 2 fabric frame \$91 = \$5,880

Select upholstery for everything else other than the seat and back cushions (the outside back, arms, sides, seat frame). You can specify the same fabric as the cushions or select other fabric.

Frame	1	10	1,000	19	2,303	L1	1,686	
	2	91	11	1,121	20	2,454	L2	3,062
	3	183	12	1,242	21	2,606	L3	4,715
	COM/4	273	13	1,394	22	2,757	L4	6,091
	5	394	14	1,545	23	3,060	L5	7,468
	6	515	15	1,697	24	3,363		
	7	637	16	1,848	25	3,666		
	8	758	17	2,000	26	3,968		
	9	879	18	2,151	27	4,271		

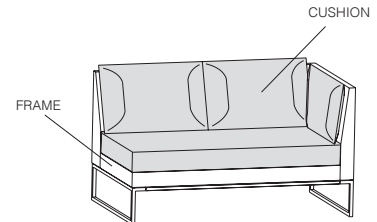

TO ORDER PLEASE SPECIFY THE FOLLOWING:

<input type="text"/>	<input type="text"/>	<input type="text"/>	<input type="text"/>	<input type="text"/>
MODEL NUMBER	FRAME COLOR	FLAMMABILITY RATING	CUSHION UPHOLSTERY	FRAME UPHOLSTERY
	Polished Chrome Brushed Chrome Steel Black Designer White Matte Gold Silver Solar Black Titanium Bullseye Regatta	PC +\$164 BS +\$164 P71 P1JW P8G PR6 P8X P8T P1JF P8M	U CTB117	Please refer to list of available upholstery and leather selections on www.gunlocke.com

Example

GLGB17-072.PC.U.DOL728.SPNN04				
GLGB17-072	PC	U	DOL728	SPNN04
MODEL NUMBER	FRAME COLOR	FLAMMABILITY	CUSHION UPHOLSTERY	FRAME UPHOLSTERY

model number	fabric grades	dimensions	W	D	H
GLGB17-082	1 5,504	Overall	53 1/2"	32"	30"
Two seat, arm right		Seat	46 1/2"	21"	17"
		Arm			30"

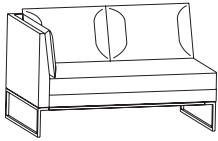

Upholstery Requirements: GLGB17-082

	Dual Upholstery	
Fabric yds	Cushion 5	Frame 4.75
Leather ft ²	Cushion 125	Frame 118.75
Shipping weight	180 lbs.	
Cube	37.8	

Cushion	1	10	1,041	19	2,398	L1	1,756	
	2	95	11	1,168	20	2,557	L2	3,190
	3	190	12	1,294	21	2,714	L3	4,911
	COM/4	285	13	1,452	22	2,872	L4	6,345
	5	410	14	1,609	23	3,188	L5	7,780
	6	537	15	1,767	24	3,503		
	7	663	16	1,925	25	3,819		
	8	790	17	2,083	26	4,134		
	9	915	18	2,240	27	4,450		

To calculate price of lounge with different fabric for cushion and frame; start with Grade 1 price, add appropriate grade price located in second row for cushion, and last add appropriate grade price located in third row for frame to the sum of the Grade 1 and cushion price.

Example: Grade 1 \$5,504 + grade 4 fabric cushion \$285 + grade 2 fabric frame \$91 = \$5,880

Frame	1	10	1,000	19	2,303	L1	1,686	
	2	91	11	1,121	20	2,454	L2	3,062
	3	183	12	1,242	21	2,606	L3	4,715
	COM/4	273	13	1,394	22	2,757	L4	6,091
	5	394	14	1,545	23	3,060	L5	7,468
	6	515	15	1,697	24	3,363		
	7	637	16	1,848	25	3,666		
	8	758	17	2,000	26	3,968		
	9	879	18	2,151	27	4,271		

Select upholstery for everything else other than the seat and back cushions (the outside back, arms, sides, seat frame). You can specify the same fabric as the cushions or select other fabric.

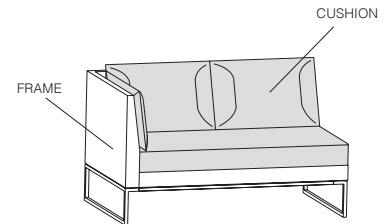

TO ORDER PLEASE SPECIFY THE FOLLOWING:

<input type="text"/>	<input type="text"/>	<input type="text"/>	<input type="text"/>	<input type="text"/>
MODEL NUMBER	FRAME COLOR	FLAMMABILITY RATING	CUSHION UPHOLSTERY	FRAME UPHOLSTERY
	Polished Chrome Brushed Chrome Steel Black Designer White Matte Gold Silver Solar Black Titanium Bullseye Regatta	PC +\$164 BS +\$164 P71 PJW P8G PR6 P8X P8T PJF P8M	U CTB117 Please refer to list of available upholstery and leather selections on www.gunlocke.com	Please refer to list of available upholstery and leather selections on www.gunlocke.com

Example

GLGB17-082.PC.U.DOL728.SPNN04				
GLGB17-082	PC	U	DOL728	SPNN04
MODEL NUMBER	FRAME COLOR	FLAMMABILITY	CUSHION UPHOLSTERY	FRAME UPHOLSTERY

model number	fabric grades	dimensions	W	D	H
GLGB17-103	1 6,350	Overall	75"	32"	30"
Three seat, armless		Seat	75"	21"	17"

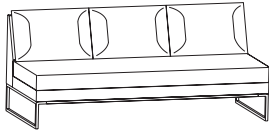

Upholstery Requirements: GLGB17-103

	Dual Upholstery	
Fabric yds	Cushion 6.3	Frame 5.3
Leather ft ²	Cushion 156.3	Frame 131.5
Shipping weight	280 lbs.	
Cube	52.1	

Cushion

1	10	1,313	19	3,022	L1	2,212	
2	119	11	1,472	20	3,220	L2	4,019
3	239	12	1,630	21	3,420	L3	6,188
COM/4	358	13	1,830	22	3,618	L4	7,996
5	517	14	2,028	23	4,016	L5	9,802
6	676	15	2,227	24	4,414		
7	835	16	2,426	25	4,811		
8	995	17	2,624	26	5,209		
9	1,154	18	2,824	27	5,606		

To calculate price of lounge with different fabric for cushion and frame; start with Grade 1 price, add appropriate grade price located in second row for cushion, and last add appropriate grade price located in third row for frame to the sum of the Grade 1 and cushion price.

Example: Grade 1 \$6,350 + grade 4 fabric cushion \$358 + grade 2 fabric frame \$101 = \$6,809

Select upholstery for everything else other than the seat and back cushions (the outside back, arms, sides, seat frame). You can specify the same fabric as the cushions or select other fabric.

Frame

1	10	1,105	19	2,542	L1	1,861	
2	101	11	1,238	20	2,709	L2	3,382
3	201	12	1,372	21	2,877	L3	5,206
COM/4	301	13	1,538	22	3,044	L4	6,726
5	435	14	1,706	23	3,378	L5	8,246
6	569	15	1,873	24	3,713		
7	702	16	2,041	25	4,048		
8	837	17	2,208	26	4,382		
9	971	18	2,376	27	4,716		

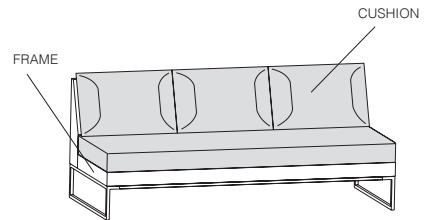

TO ORDER PLEASE SPECIFY THE FOLLOWING:

<input type="text"/>	<input type="text"/>	<input type="text"/>	<input type="text"/>	<input type="text"/>
MODEL NUMBER	FRAME COLOR	FLAMMABILITY RATING	CUSHION UPHOLSTERY	FRAME UPHOLSTERY
	Polished Chrome Brushed Chrome Steel Black Designer White Matte Gold Silver Solar Black Titanium Bullseye Regatta	PC +\$218 BS +\$218 P71 PJW P8G PR6 P8X P8T PJF P8M	U CTB117	Please refer to list of available upholstery and leather selections on www.gunlocke.com
				Please refer to list of available upholstery and leather selections on www.gunlocke.com

Example

GLGB17-103.PC.U.DOL728.SPNN04				
GLGB17-103	PC	U	DOL728	SPNN04
MODEL NUMBER	FRAME COLOR	FLAMMABILITY	CUSHION UPHOLSTERY	FRAME UPHOLSTERY

CALM

Three Seat Lounge, Arm Left

Seating
02/24

model number	fabric grades	dimensions	W	D	H
GLGB17-113	1 6,908	Overall	78 1/2"	32"	30"
Three seat, arm left		Seat	71 1/2"	21"	17"
		Arm			30"



Upholstery Requirements: GLGB17-113

	Dual Upholstery	
Fabric yds	Cushion 7	Frame 6.75
Leather ft ²	Cushion 75	Frame 168.8
Shipping weight	290 lbs.	
Cube	54.5	

Cushion	1	10	1,458	19	3,358	L1	2,458	
	2	133	11	1,634	20	3,579	L2	4,466
	3	265	12	1,812	21	3,799	L3	6,875
	COM/4	398	13	2,032	22	4,020	L4	8,883
	5	575	14	2,254	23	4,462	L5	10,892
	6	752	15	2,474	24	4,903		
	7	928	16	2,695	25	5,346		
	8	1,105	17	2,916	26	5,787		
	9	1,281	18	3,136	27	6,229		

To calculate price of lounge with different fabric for cushion and frame; start with Grade 1 price, add appropriate grade price located in second row for cushion, and last add appropriate grade price located in third row for frame to the sum of the Grade 1 and cushion price.

Example: Grade 1 \$6,908 + grade 4 fabric cushion \$398 + grade 2 fabric frame \$129 = \$7,435

Select upholstery for everything else other than the seat and back cushions (the outside back, arms, sides, seat frame). You can specify the same fabric as the cushions or select other fabric.

Frame	1	10	1,416	19	3,262	L1	2,388	
	2	129	11	1,589	20	3,477	L2	4,339
	3	258	12	1,760	21	3,691	L3	6,679
	COM/4	386	13	1,974	22	3,906	L4	8,630
	5	559	14	2,189	23	4,334	L5	10,580
	6	730	15	2,404	24	4,764		
	7	902	16	2,618	25	5,193		
	8	1,073	17	2,832	26	5,622		
	9	1,245	18	3,047	27	6,051		

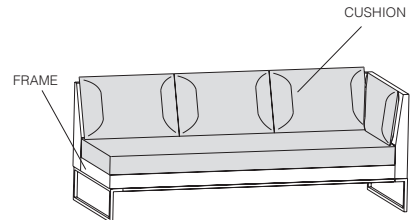

TO ORDER PLEASE SPECIFY THE FOLLOWING:

<input type="text"/>	<input type="text"/>	<input type="text"/>	<input type="text"/>	<input type="text"/>
MODEL NUMBER	FRAME COLOR	FLAMMABILITY RATING	CUSHION UPHOLSTERY	FRAME UPHOLSTERY
	Polished Chrome Brushed Chrome Steel Black Designer White Matte Gold Silver Solar Black Titanium Bullseye Regatta	PC +\$218 BS +\$218 P71 PJW P8G PR6 P8X P8T PJF P8M	U CTB117	Please refer to list of available upholstery and leather selections on www.gunlocke.com

Example

GLGB17-113.PC.U.DOL728.SPNN04				
GLGB17-113	PC	U	DOL728	SPNN04
MODEL NUMBER	FRAME COLOR	FLAMMABILITY	CUSHION UPHOLSTERY	FRAME UPHOLSTERY

model number	fabric grades	dimensions	W	D	H
GLGB17-123	1 6,908	Overall	78 1/2"	32"	30"
Three seat, arm right		Seat	71 1/2"	21"	17"
		Arm			30"

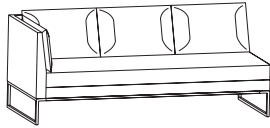

Upholstery Requirements: GLGB17-123

	Dual Upholstery	
Fabric yds	Cushion 7	Frame 6.75
Leather ft ²	Cushion 75	Frame 168.8
Shipping weight	290 lbs.	
Cube	54.5	

Cushion	1	10	1,458	19	3,358	L1	2,458	
	2	133	11	1,634	20	3,579	L2	4,466
	3	265	12	1,812	21	3,799	L3	6,875
	COM/4	398	13	2,032	22	4,020	L4	8,883
	5	575	14	2,254	23	4,462	L5	10,892
	6	752	15	2,474	24	4,903		
	7	928	16	2,695	25	5,346		
	8	1,105	17	2,916	26	5,787		
	9	1,281	18	3,136	27	6,229		

To calculate price of lounge with different fabric for cushion and frame; start with Grade 1 price, add appropriate grade price located in second row for cushion, and last add appropriate grade price located in third row for frame to the sum of the Grade 1 and cushion price.

Example: Grade 1 \$6,908 + grade 4 fabric cushion \$398 + grade 2 fabric frame \$129 = \$7,435

Select upholstery for everything else other than the seat and back cushions (the outside back, arms, sides, seat frame). You can specify the same fabric as the cushions or select other fabric.

Frame	1	10	1,416	19	3,262	L1	2,388	
	2	129	11	1,589	20	3,477	L2	4,339
	3	258	12	1,760	21	3,691	L3	6,679
	COM/4	386	13	1,974	22	3,906	L4	8,630
	5	559	14	2,189	23	4,334	L5	10,580
	6	730	15	2,404	24	4,764		
	7	902	16	2,618	25	5,193		
	8	1,073	17	2,832	26	5,622		
	9	1,245	18	3,047	27	6,051		

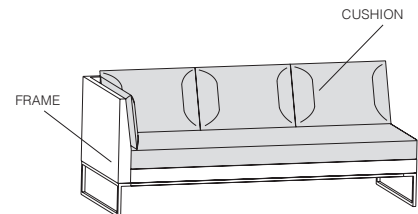

TO ORDER PLEASE SPECIFY THE FOLLOWING:

. . . .

MODEL NUMBER	FRAME COLOR	FLAMMABILITY RATING	CUSHION UPHOLSTERY	FRAME UPHOLSTERY
	Polished Chrome	PC +\$218	U	CTB117
	Brushed Chrome Steel	BS +\$218		
	Black	P71		
	Designer White	PJW		
	Matte Gold	P8G		
	Silver	PR6		
	Solar Black	P8X		
	Titanium	P8T		
	Bullseye	PJF		
	Regatta	P8M		
			Please refer to list of available upholstery and leather selections on www.gunlocke.com	Please refer to list of available upholstery and leather selections on www.gunlocke.com

Example

GLGB17-123.PC.U.DOL728.SPNN04

GLGB17-123	PC	U	DOL728	SPNN04
MODEL NUMBER	FRAME COLOR	FLAMMABILITY	CUSHION UPHOLSTERY	FRAME UPHOLSTERY

CALM

Left Corner

model number	fabric grades	dimensions	W	D	H
GLGB17-161 Left corner	1 4,560	Overall	32"	32"	30"
		Seat	21"	21"	17"

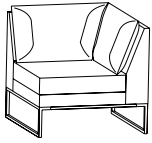

Upholstery Requirements: GLGB17-161

	Dual Upholstery	
Fabric yds	Cushion 3	Frame 3.5
Leather ft ²	Cushion 75	Frame 87.5
Shipping weight	145 lbs.	
Cube	23.4	

Cushion

1	10	625	19	1,439	L1	1,053	
2	57	11	701	20	1,534	L2	1,915
3	114	12	777	21	1,629	L3	2,947
COM/4	171	13	871	22	1,724	L4	3,808
5	247	14	966	23	1,912	L5	4,668
6	322	15	1,061	24	2,102		
7	398	16	1,155	25	2,292		
8	474	17	1,250	26	2,480		
9	550	18	1,344	27	2,670		

To calculate price of lounge with different fabric for cushion and frame; start with Grade 1 price, add appropriate grade price located in second row for cushion, and last add appropriate grade price located in third row for frame to the sum of the Grade 1 and cushion price.

Example: Grade 1 \$4,560 + grade 4 fabric cushion \$171 + grade 2 fabric frame \$67 = \$4,798

Select upholstery for everything else other than the seat and back cushions (the outside back, arms, sides, seat frame). You can specify the same fabric as the cushions or select other fabric.

Frame

1	10	730	19	1,679	L1	1,229	
2	67	11	818	20	1,789	L2	2,233
3	133	12	906	21	1,900	L3	3,438
COM/4	199	13	1,016	22	2,010	L4	4,442
5	287	14	1,126	23	2,232	L5	5,446
6	375	15	1,238	24	2,452		
7	465	16	1,348	25	2,673		
8	553	17	1,458	26	2,893		
9	641	18	1,569	27	3,115		

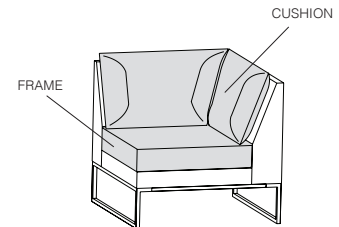

TO ORDER PLEASE SPECIFY THE FOLLOWING:

<input type="text"/>	<input type="text"/>	<input type="text"/>	<input type="text"/>	<input type="text"/>
MODEL NUMBER	FRAME COLOR	FLAMMABILITY RATING	CUSHION UPHOLSTERY	FRAME UPHOLSTERY

Polished Chrome	PC +\$137	U CTB117
Brushed Chrome Steel	BS +\$137	
Black	P71	
Designer White	PJW	
Matte Gold	P8G	
Silver	PR6	
Solar Black	P8X	
Titanium	P8T	
Bullseye	PJF	
Regatta	P8M	

Please refer to list of available upholstery and leather selections on www.gunlocke.com

Please refer to list of available upholstery and leather selections on www.gunlocke.com

NOTE: Corner units **MUST** be used when creating a modular turn where backrests are needed. This aligns the depths between the two "backed" units, and keeps the consistent 5" pillow thickness for the modular turn.

Example

GLGB17-161.PC.U.DOL728.SPNN04				
GLGB17-161	PC	U	DOL728	SPNN04
MODEL NUMBER	FRAME COLOR	FLAMMABILITY	CUSHION UPHOLSTERY	FRAME UPHOLSTERY

model number	fabric grades	dimensions	W	D	H
GLGB17-171 Right corner	1 4,560	Overall	32"	32"	30"
		Seat	21"	21"	17"

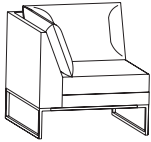

Upholstery Requirements: GLGB17-171

	Dual Upholstery	
Fabric yds	Cushion 3	Frame 3.5
Leather ft ²	Cushion 75	Frame 87.5
Shipping weight	145 lbs.	
Cube	23.4	

Cushion

1	10	625	19	1,439	L1	1,053	
2	57	11	701	20	1,534	L2	1,915
3	114	12	777	21	1,629	L3	2,947
COM/4	171	13	871	22	1,724	L4	3,808
5	247	14	966	23	1,912	L5	4,668
6	322	15	1,061	24	2,102		
7	398	16	1,155	25	2,292		
8	474	17	1,250	26	2,480		
9	550	18	1,344	27	2,670		

To calculate price of lounge with different fabric for cushion and frame; start with Grade 1 price, add appropriate grade price located in second row for cushion, and last add appropriate grade price located in third row for frame to the sum of the Grade 1 and cushion price.

Example: Grade 1 \$4,560 + grade 4 fabric cushion \$171 + grade 2 fabric frame \$67 = \$4,798

Frame

1	10	730	19	1,679	L1	1,229	
2	67	11	818	20	1,789	L2	2,233
3	133	12	906	21	1,900	L3	3,438
COM/4	199	13	1,016	22	2,010	L4	4,442
5	287	14	1,126	23	2,232	L5	5,446
6	375	15	1,238	24	2,452		
7	465	16	1,348	25	2,673		
8	553	17	1,458	26	2,893		
9	641	18	1,569	27	3,115		

Select upholstery for everything else other than the seat and back cushions (the outside back, arms, sides, seat frame). You can specify the same fabric as the cushions or select other fabric.

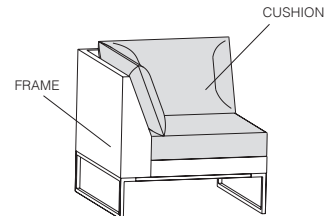

TO ORDER PLEASE SPECIFY THE FOLLOWING:

MODEL NUMBER	FRAME COLOR	FLAMMABILITY RATING	CUSHION UPHOLSTERY	FRAME UPHOLSTERY
<input type="text"/>	<input type="text"/>	<input type="text"/>	<input type="text"/>	<input type="text"/>
	Polished Chrome PC +\$137 Brushed Chrome Steel BS +\$137 Black P71 Designer White PJW Matte Gold P8G Silver PR6 Solar Black P8X Titanium P8T Bullseye PJF Regatta P8M	U CTB117	Please refer to list of available upholstery and leather selections on www.gunlocke.com	Please refer to list of available upholstery and leather selections on www.gunlocke.com

NOTE: Corner units MUST be used when creating a modular turn where backrests are needed. This aligns the depths between the two "backed" units, and keeps the consistent 5" pillow thickness for the modular turn.

Example

GLGB17-171.PC.U.DOL728.SPNN04				
GLGB17-171	PC	U	DOL728	SPNN04
MODEL NUMBER	FRAME COLOR	FLAMMABILITY	CUSHION UPHOLSTERY	FRAME UPHOLSTERY

CALM

One Seat Bench

Seating
02/24

model number fabric grades dimensions W D H

GBGB17-131
One seat bench

1 2,824

Overall 25" 32" 17"

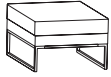

Upholstery Requirements: GLGB17-131

Dual Upholstery		
Fabric yds	Cushion 1	Frame 1.3
Leather ft ²	Cushion 25	Frame 32.5
Shipping weight	90 lbs.	
Cube	11.3	

Cushion

1	10	209	19	480	L1	351
2	19	11	234	20	512	L2 638
3	39	12	259	21	543	L3 983
COM/4	57	13	290	22	575	L4 1,269
5	82	14	322	23	638	L5 1,556
6	107	15	354	24	701	
7	133	16	385	25	765	
8	159	17	417	26	827	
9	184	18	448	27	890	

To calculate price of lounge with different fabric for cushion and frame; start with Grade 1 price, add appropriate grade price located in second row for cushion, and last add appropriate grade price located in third row for frame to the sum of the Grade 1 and cushion price.

Example: Grade 1 \$2,824 + grade 4 fabric cushion \$57 + grade 2 fabric frame \$26 = \$2,907

Select upholstery for everything else other than the seat and back cushions (the outside back, arms, sides, seat frame). You can specify the same fabric as the cushions or select other fabric.

Frame

1	10	271	19	624	L1	457
2	26	11	304	20	665	L2 830
3	50	12	337	21	706	L3 1,277
COM/4	75	13	378	22	747	L4 1,650
5	107	14	419	23	829	L5 2,024
6	140	15	459	24	911	
7	173	16	501	25	993	
8	205	17	542	26	1,075	
9	238	18	583	27	1,157	

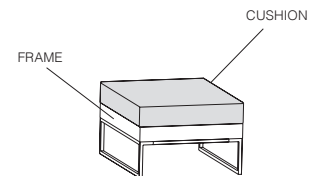

TO ORDER PLEASE SPECIFY THE FOLLOWING:

<input type="text"/>	<input type="text"/>	<input type="text"/>	<input type="text"/>	<input type="text"/>
MODEL NUMBER	FRAME COLOR	FLAMMABILITY RATING	CUSHION UPHOLSTERY	FRAME UPHOLSTERY
	Polished Chrome Brushed Chrome Steel Black Designer White Matte Gold Silver Solar Black Titanium Bullseye Regatta	PC +\$137 BS +\$137 P71 PJW P8G PR6 P8X P8T PJF P8M	U CTB117	Please refer to list of available upholstery and leather selections on www.gunlocke.com
				Please refer to list of available upholstery and leather selections on www.gunlocke.com

Example

GBGB17-131.PC.U.DOL728.SPNN04

GBGB17-131	PC	U	DOL728	SPNN04
MODEL NUMBER	FRAME COLOR	FLAMMABILITY	CUSHION UPHOLSTERY	FRAME UPHOLSTERY

model number fabric grades dimensions W D H

GBGB17-142 1 3,866
Two seat bench

Overall 50" 32" 17"



Upholstery Requirements: GLGB17-142

	Dual Upholstery	
Fabric yds	Cushion 2.5	Frame 1.2
Leather ft ²	Cushion 62.5	Frame 30
Shipping weight	135 lbs.	
Cube	21.5	

Cushion

1	10	522	19	1,199	L1	878	
2	47	11	585	20	1,278	L2	1,595
3	95	12	647	21	1,358	L3	2,456
COM/4	142	13	726	22	1,436	L4	3,173
5	205	14	805	23	1,594	L5	3,890
6	269	15	884	24	1,752		
7	332	16	963	25	1,909		
8	395	17	1,041	26	2,067		
9	458	18	1,121	27	2,225		

To calculate price of lounge with different fabric for cushion and frame; start with Grade 1 price, add appropriate grade price located in second row for cushion, and last add appropriate grade price located in third row for frame to the sum of the Grade 1 and cushion price.

Example: Grade 1 \$3,866 + grade 4 fabric cushion \$142 + grade 2 fabric frame \$23 = \$4,031

Select upholstery for everything else other than the seat and back cushions (the outside back, arms, sides, seat frame). You can specify the same fabric as the cushions or select other fabric.

Frame

1	10	250	19	576	L1	422	
2	23	11	281	20	614	L2	766
3	46	12	311	21	651	L3	1,179
COM/4	69	13	349	22	689	L4	1,523
5	99	14	386	23	766	L5	1,868
6	129	15	425	24	841		
7	160	16	463	25	917		
8	190	17	501	26	992		
9	220	18	538	27	1,069		

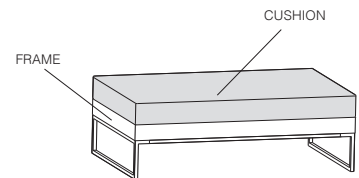

TO ORDER PLEASE SPECIFY THE FOLLOWING:

<input type="text"/>	<input type="text"/>	<input type="text"/>	<input type="text"/>	<input type="text"/>
MODEL NUMBER	FRAME COLOR	FLAMMABILITY RATING	CUSHION UPHOLSTERY	FRAME UPHOLSTERY
	Polished Chrome Brushed Chrome Steel Black Designer White Matte Gold Silver Solar Black Titanium Bullseye Regatta	PC +\$164 BS +\$164 P71 PJW P8G PR6 P8X P8T PJF P8M	U CTB117 Please refer to list of available upholstery and leather selections on www.gunlocke.com	Please refer to list of available upholstery and leather selections on www.gunlocke.com

Example

GLGB17-142.PC.U.DOL728.SPNN04
 GLGB17-142 PC U DOL728 SPNN04
 MODEL NUMBER FRAME COLOR FLAMMABILITY CUSHION UPHOLSTERY FRAME UPHOLSTERY

CALM

Three Seat Bench

Seating
02/24

model number fabric grades dimensions W D H

GBGB17-153
Three seat bench

1 4,855

Overall 75" 32" 17"



Upholstery Requirements: GLGB17-153

	Dual Upholstery	
Fabric yds	Cushion 4	Frame 1.5
Leather ft ²	Cushion 100	Frame 37.5
Shipping weight	180 lbs.	
Cube	31.6	

Cushion

1	10	833	19	1,919	L1	1,404	
2	76	11	935	20	2,045	L2	2,552
3	152	12	1,035	21	2,172	L3	3,929
COM/4	227	13	1,161	22	2,297	L4	5,077
5	329	14	1,288	23	2,550	L5	6,223
6	430	15	1,414	24	2,803		
7	530	16	1,541	25	3,055		
8	632	17	1,666	26	3,308		
9	733	18	1,792	27	3,559		

To calculate price of lounge with different fabric for cushion and frame; start with Grade 1 price, add appropriate grade price located in second row for cushion, and last add appropriate grade price located in third row for frame to the sum of the Grade 1 and cushion price.

Example: Grade 1 \$4,855 + grade 4 fabric cushion \$227 + grade 2 fabric frame \$29 = \$5,111

Select upholstery for everything else other than the seat and back cushions (the outside back, arms, sides, seat frame). You can specify the same fabric as the cushions or select other fabric.

Frame

1	10	313	19	720	L1	527	
2	29	11	350	20	767	L2	958
3	57	12	389	21	815	L3	1,474
COM/4	86	13	435	22	862	L4	1,904
5	124	14	483	23	956	L5	2,334
6	162	15	530	24	1,051		
7	199	16	578	25	1,146		
8	237	17	625	26	1,241		
9	275	18	673	27	1,335		

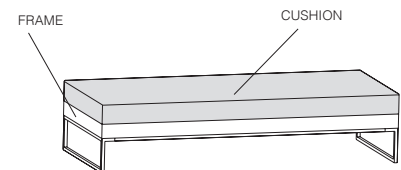

TO ORDER PLEASE SPECIFY THE FOLLOWING:

<input type="text"/>	<input type="text"/>	<input type="text"/>	<input type="text"/>	<input type="text"/>
MODEL NUMBER	FRAME COLOR	FLAMMABILITY RATING	CUSHION UPHOLSTERY	FRAME UPHOLSTERY
	Polished Chrome PC +\$218 Brushed Chrome Steel BS +\$218 Black P71 Designer White PJW Matte Gold P8G Silver PR6 Solar Black P8X Titanium P8T Bullseye PJF Regatta P8M	U CTB117	Please refer to list of available upholstery and leather selections on www.gunlocke.com	Please refer to list of available upholstery and leather selections on www.gunlocke.com

Example

GBGB17-153.PC.U.DOL728.SPNN04
 GBGB17-153 PC U DOL728 SPNN04
 MODEL NUMBER FRAME COLOR FLAMMABILITY CUSHION UPHOLSTERY FRAME UPHOLSTERY

model number fabric grades dimensions W D H

GLGB17-181 **1** 2,961
Ottoman

Overall 32" 32" 17"

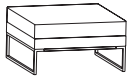

Upholstery Requirements: GLGB17-181

	Dual Upholstery	
Fabric yds	Cushion 1	Frame 1.25
Leather ft ²	Cushion 25	Frame 31.25
Shipping weight	100 lbs.	
Cube	14.2	

Cushion

1	10	209	19	480	L1	351
2	19	11	234	20	512	L2 638
3	39	12	259	21	543	L3 983
COM/4	57	13	290	22	575	L4 1,269
5	82	14	322	23	638	L5 1,556
6	107	15	354	24	701	
7	133	16	385	25	765	
8	159	17	417	26	827	
9	184	18	448	27	890	

To calculate price of lounge with different fabric for cushion and frame; start with Grade 1 price, add appropriate grade price located in second row for cushion, and last add appropriate grade price located in third row for frame to the sum of the Grade 1 and cushion price.

Example: Grade 1 \$2,961 + grade 4 fabric cushion \$57 + grade 2 fabric frame \$24 = \$3,042

Frame

1	10	261	19	600	L1	440
2	24	11	293	20	639	L2 798
3	47	12	324	21	678	L3 1,228
COM/4	71	13	363	22	719	L4 1,586
5	103	14	403	23	797	L5 1,945
6	135	15	442	24	876	
7	166	16	481	25	955	
8	198	17	522	26	1,034	
9	229	18	561	27	1,112	

Select upholstery for everything else other than the seat and back cushions (the outside back, arms, sides, seat frame). You can specify the same fabric as the cushions or select other fabric.

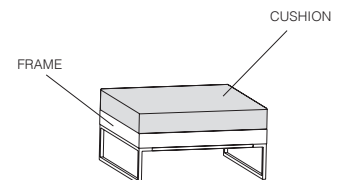

TO ORDER PLEASE SPECIFY THE FOLLOWING:

. . . .
MODEL NUMBER **FRAME COLOR** **FLAMMABILITY RATING** **CUSHION UPHOLSTERY** **FRAME UPHOLSTERY**

- Polished Chrome **PC +\$137**
- Brushed Chrome Steel **BS +\$137**
- Black **P71**
- Designer White **PJW**
- Matte Gold **P8G**
- Silver **PR6**
- Solar Black **P8X**
- Titanium **P8T**
- Bullseye **PJF**
- Regatta **P8M**

U CTB117

Please refer to list of available upholstery and leather selections on www.gunlocke.com

Please refer to list of available upholstery and leather selections on www.gunlocke.com

NOTE: Ottoman to be used in line with lounge units, to create a 32"D x 32"W seating surface..

Example

GLGB17-181.PC.U.DOL728.DOL728
 GLGB17-181 PC U DOL728 SPNN04
 MODEL NUMBER FRAME COLOR FLAMMABILITY CUSHION UPHOLSTERY FRAME UPHOLSTERY

model number	list	dimensions	W	D	H
--------------	------	------------	---	---	---

GAGB17-198
Ganging bracket

161

14.5" 4" 1.5"



- **Note:** No options are selected for ganging bracket model (GAGB17-198).
- One ganging bracket shipped per GAGB17-198 model ordered.
- Lounge units gang together with one ganging bracket per ganged position.

ACPUNDER-EU
Standard Plug

426

5.5" 3" 2"



- **Note:** Power unit mounts at left or right hand side of lounge units only. Positions are predetermined at mounting points into lounge frame (see example below).

ACPUNDER-EU-HW
Hardwired

426

5.5" 3" 2"



- **Note:** Power unit mounts at left or right hand side of lounge units only. Positions are predetermined at mounting points into lounge frame (see example below).

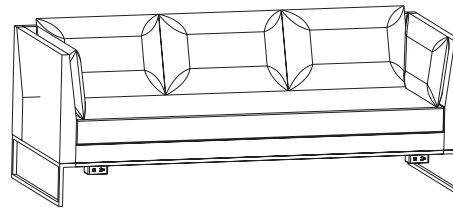
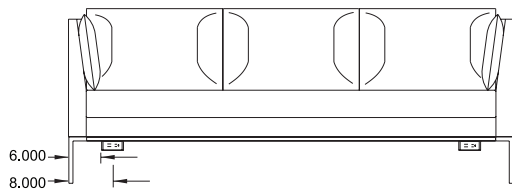

- **Note:** Power unit can be mounted directly into lounge unit frames. Edge of power unit is 6" from outside of lounge, or 8" to center of power unit from outside of lounge. Includes wire clips to attach plug cord to underside of lounge.

TO ORDER PLEASE SPECIFY THE FOLLOWING:

--	--

MODEL NUMBER **POWER COLOR**

Option available for
ACPUNDER-EU and
ACPUNDER-EU-HW models only.

White **WH**
Black **BK**
Silver **SV**

Example

ACPUNDER-EU.WH
ACPUNDER-EU WH
MODEL NUMBER **POWER COLOR**

Seating
02/24

CIJI SINGLE SEAT

Low Back, with Arms, Wood Legs

model number	fabric grades
GK1101-1W	1 3,779

Low back, with arms,
Wood legs

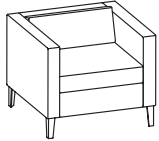

dimensions	W	D	H
Overall	31 3/4"	31 1/2"	27 7/8"
Seat	24"	21"	17 1/4"
Arm			26 7/8"
Between arms	24"		

Upholstery Requirements: GK1101-1W

	Dual Upholstery	
Fabric yds	Cushions 1.5	Frame 3.8
Leather ft ²	Cushions 34.5	Frame 87.4
Shipping weight	97 lbs.	
Cube	28.0	

Cushion	1	10	323	19	742	L1	494	
	2	30	11	361	20	791	L2	902
	3	59	12	401	21	840	L3	1,391
	COM/4	89	13	449	22	888	L4	1,799
	5	128	14	498	23	985	L5	2,206
	6	167	15	546	24	1,083		
	7	205	16	596	25	1,181		
	8	245	17	644	26	1,279		
	9	284	18	694	27	1,376		

To calculate price of lounge with different fabric for cushion and frame; start with Grade 1 price, add appropriate grade price located in second row for cushion, and last add appropriate grade price located in third row for frame to the sum of the Grade 1 and cushion price.

Example: Grade 1 \$3,779 + grade 4 fabric cushion \$89 + grade 2 fabric frame \$75 = \$3,943

Select upholstery for everything else other than the seat and back cushions (the outside back, arms, sides, seat frame). You can specify the same fabric as the cushions or select other fabric.

Frame	1	10	816	19	1,878	L1	1,250	
	2	75	11	915	20	2,002	L2	2,282
	3	149	12	1,014	21	2,125	L3	3,522
	COM/4	223	13	1,138	22	2,249	L4	4,555
	5	322	14	1,260	23	2,495	L5	5,587
	6	421	15	1,384	24	2,742		
	7	520	16	1,507	25	2,990		
	8	618	17	1,631	26	3,237		
	9	717	18	1,755	27	3,484		

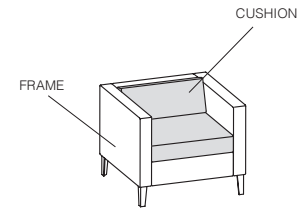

TO ORDER PLEASE SPECIFY THE FOLLOWING:

<input type="text"/>	<input type="text"/>	<input type="text"/>	<input type="text"/>	<input type="text"/>	<input type="text"/>
MODEL NUMBER	WOOD FINISH	STITCH DETAIL	FLAMMABILITY RATING	CUSHION UPHOLSTERY	FRAME UPHOLSTERY
	Cherry finishes on Maple Walnut finishes on Maple Maple finishes on Maple Oak finishes on Maple <i>Light Rift Oak 301 not available on Maple.</i>	None NR Stitch detail SD +\$197	U CTB117	Please refer to list of available upholstery and leather selections on www.gunlocke.com	Please refer to list of available upholstery and leather selections on www.gunlocke.com

Example

GK1101-1W.777.NR.U.DOL728.SPNN04					
GK1101-1W	777	NR	U	DOL728	SPNN04
MODEL NUMBER	WOOD FINISH	STITCH DETAIL	FLAMMABILITY	CUSHION UPHOLSTERY	FRAME UPHOLSTERY

Please refer to the Ciji product page on www.gunlocke.com for standard finish options.

CIJI SINGLE SEAT

Low Back, with Arms, Aluminum Legs

Seating
02/24

model number	fabric grades	dimensions	W	D	H
--------------	---------------	------------	---	---	---

GK1101-1A
Low back, with arms,
Aluminum legs

1 4,063

Overall	31 3/4"	31 1/2"	27 7/8"
Seat	24"	21"	17 1/4"
Arm			26 7/8"
Between arms	24"		

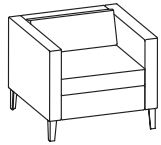

Upholstery Requirements: GK1101-1A

	Dual Upholstery	
Fabric yds	Cushions 1.5	Frame 3.8
Leather ft ²	Cushions 34.5	Frame 87.4
Shipping weight	97 lbs.	
Cube	28.0	

Cushion

1	10	323	19	742	L1	494
2	30	11	361	20	L2	902
3	59	12	401	21	L3	1,391
COM/4	89	13	449	22	L4	1,799
5	128	14	498	23	L5	2,206
6	167	15	546	24		1,083
7	205	16	596	25		1,181
8	245	17	644	26		1,279
9	284	18	694	27		1,376

To calculate price of lounge with different fabric for cushion and frame; start with Grade 1 price, add appropriate grade price located in second row for cushion, and last add appropriate grade price located in third row for frame to the sum of the Grade 1 and cushion price.

Example: Grade 1 \$4,063 + grade 4 fabric cushion \$89 + grade 2 fabric frame \$75 = \$4,227

Select upholstery for everything else other than the seat and back cushions (the outside back, arms, sides, seat frame). You can specify the same fabric as the cushions or select other fabric.

Frame

1	10	816	19	1,878	L1	1,250
2	75	11	915	2,002	L2	2,282
3	149	12	1,014	2,125	L3	3,522
COM/4	223	13	1,138	2,249	L4	4,555
5	322	14	1,260	2,495	L5	5,587
6	421	15	1,384	2,742		
7	520	16	1,507	2,990		
8	618	17	1,631	3,237		
9	717	18	1,755	3,484		

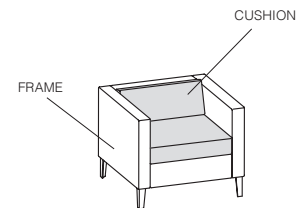

TO ORDER PLEASE SPECIFY THE FOLLOWING:

<input type="text"/>	<input type="text"/>	<input type="text"/>	<input type="text"/>	<input type="text"/>
MODEL NUMBER	STITCH DETAIL	FLAMMABILITY RATING	CUSHION UPHOLSTERY	FRAME UPHOLSTERY
	None NR Stitch detail SD +\$197	U CTB117	Please refer to list of available upholstery and leather selections on www.gunlocke.com	Please refer to list of available upholstery and leather selections on www.gunlocke.com

Example

GK1101-1A.NR.U.DOL728.SPNN04

GK1101-1A	NR	U	DOL728	SPNN04
MODEL NUMBER	STITCH	FLAMMABILITY DETAIL	CUSHION UPHOLSTERY	FRAME UPHOLSTERY

Please refer to the Ciji product page on www.gunlocke.com for standard finish options.

Seating
02/24

CIJI SINGLE SEAT

Low Back, Armless, Wood Legs

model number

fabric grades

dimensions

W

D

H

GK1103-1W

Low back, armless
Wood legs

1 2,897

Overall	24 5/8"	31 1/2"	27 7/8"
Seat	24"	21"	17 1/4"

Upholstery Requirements: GK1103-1W

	Dual Upholstery	
Fabric yds	Cushions 1.5	Frame 1.5
Leather ft ²	Cushions 34.5	Frame 34.5
Shipping weight	77 lbs.	
Cube	28.0	



Cushion

1	10	323	19	742	L1	494
2	30	11	361	20	L2	902
3	59	12	401	21	L3	1,391
COM/4	89	13	449	22	L4	1,799
5	128	14	498	23	L5	2,206
6	167	15	546	24		1,083
7	205	16	596	25		1,181
8	245	17	644	26		1,279
9	284	18	694	27		1,376

To calculate price of lounge with different fabric for cushion and frame; start with Grade 1 price, add appropriate grade price located in second row for cushion, and last add appropriate grade price located in third row for frame to the sum of the Grade 1 and cushion price.

Example: Grade 1 \$2,897 + grade 4 fabric cushion \$89 + grade 2 fabric frame \$30 = \$3,016

Select upholstery for everything else other than the seat and back cushions (the outside back, arms, sides, seat frame). You can specify the same fabric as the cushions or select other fabric.

Frame

1	10	323	19	742	L1	494
2	30	11	361	20	L2	902
3	59	12	401	21	L3	1,391
COM/4	89	13	449	22	L4	1,799
5	128	14	498	23	L5	2,206
6	167	15	546	24		1,083
7	205	16	596	25		1,181
8	245	17	644	26		1,279
9	284	18	694	27		1,376

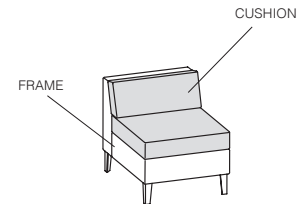

TO ORDER PLEASE SPECIFY THE FOLLOWING:

.

MODEL NUMBER

WOOD FINISH

Cherry finishes on Maple
Walnut finishes on Maple
Maple finishes on Maple
Oak finishes on Maple
Light Rift Oak 301 not available on Maple.

STITCH DETAIL

None **NR**
Stitch detail
SD +\$197

FLAMMABILITY RATING

U CTB117

CUSHION UPHOLSTERY

Please refer to list of available upholstery and leather selections on www.gunlocke.com

FRAME UPHOLSTERY

Please refer to list of available upholstery and leather selections on www.gunlocke.com

Example

GK1103-1W.777.NR.U.DOL728.SPNN04

GK1103-1W	777	NR	U	DOL728	SPNN04
MODEL NUMBER	WOOD FINISH	STITCH DETAIL	FLAMMABILITY	CUSHION UPHOLSTERY	FRAME UPHOLSTERY

Please refer to the Ciji product page on www.gunlocke.com for standard finish options.

Seating
02/24

CIJI SINGLE SEAT

Low Back, Arm Left, Wood Legs

model number fabric grades dimensions W D H

GK1105-1W

Low back, arm left.
Wood legs

1 3,561

Overall	28 1/8"	31 1/2"	27 1/8"
Seat	24"	21"	17 1/4"
Arm			26 1/8"
Between arms			



Upholstery Requirements: GK1105-1W

	Dual Upholstery	
Fabric yds	Cushions 1.5	Frame 2.8
Leather ft ²	Cushions 34.5	Frame 64.4
Shipping weight		87 lbs.
Cube		28.0

Cushion

1	10	323	19	742	L1	494
2	30	11	361	20	L2	902
3	59	12	401	21	L3	1,391
COM/4	89	13	449	22	L4	1,799
5	128	14	498	23	L5	2,206
6	167	15	546	24		1,083
7	205	16	596	25		1,181
8	245	17	644	26		1,279
9	284	18	694	27		1,376

To calculate price of lounge with different fabric for cushion and frame; start with Grade 1 price, add appropriate grade price located in second row for cushion, and last add appropriate grade price located in third row for frame to the sum of the Grade 1 and cushion price.

Example: Grade 1 \$3,561 + grade 4 fabric cushion \$89 + grade 2 fabric frame \$56 = \$3,706

Frame

1	10	602	19	1,384	L1	920
2	56	11	674	20	L2	1,681
3	110	12	747	21	L3	2,595
COM/4	165	13	839	22	L4	3,357
5	237	14	930	23	L5	4,118
6	311	15	1,020	24		2,020
7	383	16	1,112	25		2,203
8	456	17	1,203	26		2,386
9	529	18	1,293	27		2,567

Select upholstery for everything else other than the seat and back cushions (the outside back, arms, sides, seat frame). You can specify the same fabric as the cushions or select other fabric.

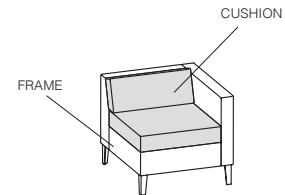

TO ORDER PLEASE SPECIFY THE FOLLOWING:

.

MODEL NUMBER

WOOD FINISH

Cherry finishes on Maple
Walnut finishes on Maple
Maple finishes on Maple
Oak finishes on Maple
Light Rift Oak 301 not available on Maple.

STITCH DETAIL

None **NR**
Stitch detail **SD** +\$197

FLAMMABILITY RATING

U CTB117

CUSHION UPHOLSTERY

Please refer to list of available upholstery and leather selections on www.gunlocke.com

FRAME UPHOLSTERY

Please refer to list of available upholstery and leather selections on www.gunlocke.com

Example

GK1105-1W.777.NR.U.DOL728.SPNN04

GK1105-1W	777	NR	U	DOL728	SPNN04
MODEL NUMBER	WOOD FINISH	STITCH DETAIL	FLAMMABILITY	CUSHION UPHOLSTERY	FRAME UPHOLSTERY

Please refer to the Ciji product page on www.gunlocke.com for standard finish options.

model number fabric grades dimensions W D H

GK1107-1W

Low back, arm right
Wood legs

1 3,561

Overall	28 1/8"	31 1/2"	27 7/8"
Seat	24"	21"	17 1/4"
Arm			26 7/8"
Between arms			

Upholstery Requirements: GK1107-1W

	Dual Upholstery	
Fabric yds	Cushions 1.5	Frame 2.8
Leather ft ²	Cushions 34.5	Frame 64.4
Shipping weight		87 lbs.
Cube		28.0



Cushion

1	10	323	19	742	L1	494
2	30	11	361	20	L2	902
3	59	12	401	21	L3	1,391
COM/4	89	13	449	22	L4	1,799
5	128	14	498	23	L5	2,206
6	167	15	546	24		1,083
7	205	16	596	25		1,181
8	245	17	644	26		1,279
9	284	18	694	27		1,376

To calculate price of lounge with different fabric for cushion and frame; start with Grade 1 price, add appropriate grade price located in second row for cushion, and last add appropriate grade price located in third row for frame to the sum of the Grade 1 and cushion price.

Example: Grade 1 \$3,561 + grade 4 fabric cushion \$89 + grade 2 fabric frame \$56 = \$3,706

Select upholstery for everything else other than the seat and back cushions (the outside back, arms, sides, seat frame). You can specify the same fabric as the cushions or select other fabric.

Frame

1	10	602	19	1,384	L1	920
2	56	11	674	20	L2	1,681
3	110	12	747	21	L3	2,595
COM/4	165	13	839	22	L4	3,357
5	237	14	930	23	L5	4,118
6	311	15	1,020	24		2,020
7	383	16	1,112	25		2,203
8	456	17	1,203	26		2,386
9	529	18	1,293	27		2,567

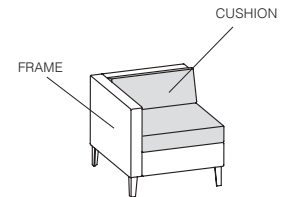

TO ORDER PLEASE SPECIFY THE FOLLOWING:

.

MODEL NUMBER	WOOD FINISH	STITCH DETAIL	FLAMMABILITY RATING	CUSHION UPHOLSTERY	FRAME UPHOLSTERY
	Cherry finishes on Maple Walnut finishes on Maple Maple finishes on Maple Oak finishes on Maple <i>Light Rift Oak 301 not available on Maple.</i>	None NR Stitch detail SD +\$197	U CTB117	Please refer to list of available upholstery and leather selections on www.gunlocke.com	Please refer to list of available upholstery and leather selections on www.gunlocke.com

Example

GK1107-1W.777.NR.U.DOL728.SPNN04

GK1107-1W	777	NR	U	DOL728	SPNN04
MODEL NUMBER	WOOD FINISH	STITCH DETAIL	FLAMMABILITY	CUSHION UPHOLSTERY	FRAME UPHOLSTERY

Please refer to the Ciji product page on www.gunlocke.com for standard finish options.

CIJI SINGLE SEAT

Low Back, Arm Right, Aluminum Legs

Seating
02/24

model number	fabric grades	dimensions	W	D	H
--------------	---------------	------------	---	---	---

GK1107-1A
Low back, arm right
Aluminum legs

1 3,844

Overall	28 1/8"	31 1/2"	27 7/8"
Seat	24"	21"	17 1/4"
Arm			26 7/8"
Between arms			



Upholstery Requirements: GK1107-1A

	Dual Upholstery	
Fabric yds	Cushions 1.5	Frame 2.8
Leather ft ²	Cushions 34.5	Frame 64.4
Shipping weight	87 lbs.	
Cube	28.0	

Cushion

1	10	323	19	742	L1	494
2	30	11	361	20	L2	902
3	59	12	401	21	L3	1,391
COM/4	89	13	449	22	L4	1,799
5	128	14	498	23	L5	2,206
6	167	15	546	24		
7	205	16	596	25		
8	245	17	644	26		
9	284	18	694	27		

To calculate price of lounge with different fabric for cushion and frame; start with Grade 1 price, add appropriate grade price located in second row for cushion, and last add appropriate grade price located in third row for frame to the sum of the Grade 1 and cushion price.

Example: Grade 1 \$3,844 + grade 4 fabric cushion \$89 + grade 2 fabric frame \$56 = \$3,989

Select upholstery for everything else other than the seat and back cushions (the outside back, arms, sides, seat frame). You can specify the same fabric as the cushions or select other fabric.

Frame

1	10	602	19	1,384	L1	920
2	56	11	674	20	L2	1,681
3	110	12	747	21	L3	2,595
COM/4	165	13	839	22	L4	3,357
5	237	14	930	23	L5	4,118
6	311	15	1,020	24		
7	383	16	1,112	25		
8	456	17	1,203	26		
9	529	18	1,293	27		

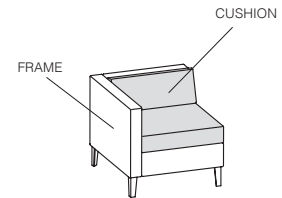

TO ORDER PLEASE SPECIFY THE FOLLOWING:

<input type="text"/>	<input type="text"/>	<input type="text"/>	<input type="text"/>	<input type="text"/>
MODEL NUMBER	STITCH DETAIL	FLAMMABILITY RATING	CUSHION UPHOLSTERY	FRAME UPHOLSTERY
	None NR Stitch detail SD +\$197	U CTB117	Please refer to list of available upholstery and leather selections on www.gunlocke.com	Please refer to list of available upholstery and leather selections on www.gunlocke.com

Example

GK1107-1A.NR.U.DOL728.SPNN04

GK1107-1A	NR	U	DOL728	SPNN04
MODEL NUMBER	STITCH	FLAMMABILITY DETAIL	CUSHION UPHOLSTERY	FRAME UPHOLSTERY

Please refer to the Ciji product page on www.gunlocke.com for standard finish options.

Seating
02/24

CIJI TWO SEAT

Low Back, with Arms. Wood Legs

model number	fabric grades
GK1101-2W	1 5,294

Low back, with arms
Wood legs

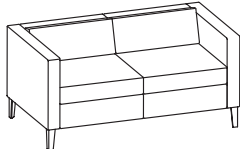

dimensions	W	D	H
Overall	56 1/4"	31 1/2"	27 1/8"
Seat	48 1/2"	21"	17 1/4"
Arm			26 1/8"
Between arms	48 1/2"		

Upholstery Requirements: GK1101-2W

	Dual Upholstery
Fabric yds	Cushions 2.9 Frame 5.2
Leather ft ²	Cushions 66.7 Frame 119.6
Shipping weight	119 lbs.
Cube	35

Cushion

1	10	623	19	1,433	L1	954	
2	57	11	698	20	1,528	L2	1,742
3	115	12	773	21	1,622	L3	2,688
COM/4	170	13	868	22	1,716	L4	3,476
5	246	14	963	23	1,905	L5	4,264
6	321	15	1,056	24	2,093		
7	397	16	1,151	25	2,282		
8	472	17	1,245	26	2,469		
9	547	18	1,339	27	2,659		

To calculate price of lounge with different fabric for cushion and frame; start with Grade 1 price, add appropriate grade price located in second row for cushion, and last add appropriate grade price located in third row for frame to the sum of the Grade 1 and cushion price.

Example: Grade 1 \$5,294 + grade 4 fabric cushion \$170 + grade 2 fabric frame \$102 = \$5,566

Select upholstery for everything else other than the seat and back cushions (the outside back, arms, sides, seat frame). You can specify the same fabric as the cushions or select other fabric.

Frame

1	10	1,116	19	2,569	L1	1,709	
2	102	11	1,252	20	2,739	L2	3,123
3	204	12	1,387	21	2,908	L3	4,819
COM/4	305	13	1,556	22	3,077	L4	6,232
5	440	14	1,725	23	3,415	L5	7,645
6	576	15	1,894	24	3,753		
7	710	16	2,063	25	4,091		
8	846	17	2,231	26	4,428		
9	981	18	2,400	27	4,767		

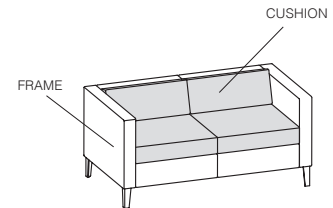

TO ORDER PLEASE SPECIFY THE FOLLOWING:

<input type="text"/>	<input type="text"/>	<input type="text"/>	<input type="text"/>	<input type="text"/>	<input type="text"/>
MODEL NUMBER	WOOD FINISH	STITCH DETAIL	FLAMMABILITY RATING	CUSHION UPHOLSTERY	FRAME UPHOLSTERY
	Cherry finishes on Maple Walnut finishes on Maple Maple finishes on Maple Oak finishes on Maple <i>Light Rift Oak 301 not available on Maple.</i>	None NR Stitch detail SD +\$197	U CTB117	Please refer to list of available upholstery and leather selections on www.gunlocke.com	Please refer to list of available upholstery and leather selections on www.gunlocke.com

Example

GK1101-2W.777.NR.U.DOL728.SPNN04					
GK1101-2W	777	NR	U	DOL728	SPNN04
MODEL NUMBER	WOOD FINISH	STITCH DETAIL	FLAMMABILITY	CUSHION UPHOLSTERY	FRAME UPHOLSTERY

Please refer to the Ciji product page on www.gunlocke.com for standard finish options.

CIJI TWO SEAT

Low Back, with Arms, Aluminum Legs

Seating
02/24

model number	fabric grades	dimensions	W	D	H
--------------	---------------	------------	---	---	---

GK1101-2A
Low back, with arms,
Aluminum Legs

1 5,577

Overall	56 1/4"	31 1/2"	27 1/8"
Seat	48 1/2"	21"	17 1/4"
Arm			26 1/8"
Between arms	48 1/2"		

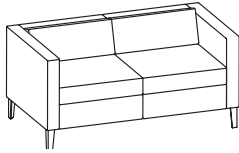

Upholstery Requirements: GK1101-2A

	Dual Upholstery
Fabric yds	Cushions 2.9 Frame 5.2
Leather ft ²	Cushions 66.7 Frame 119.6
Shipping weight	119 lbs.
Cube	35

Cushion

1	10	623	19	1,433	L1	954	
2	57	11	698	20	1,528	L2	1,742
3	115	12	773	21	1,622	L3	2,688
COM/4	170	13	868	22	1,716	L4	3,476
5	246	14	963	23	1,905	L5	4,264
6	321	15	1,056	24	2,093		
7	397	16	1,151	25	2,282		
8	472	17	1,245	26	2,469		
9	547	18	1,339	27	2,659		

To calculate price of lounge with different fabric for cushion and frame; start with Grade 1 price, add appropriate grade price located in second row for cushion, and last add appropriate grade price located in third row for frame to the sum of the Grade 1 and cushion price.

Example: Grade 1 \$5,577 + grade 4 fabric cushion \$170 + grade 2 fabric frame \$102 = \$5,849

Frame

1	10	1,116	19	2,569	L1	1,709	
2	102	11	1,252	20	2,739	L2	3,123
3	204	12	1,387	21	2,908	L3	4,819
COM/4	305	13	1,556	22	3,077	L4	6,232
5	440	14	1,725	23	3,415	L5	7,645
6	576	15	1,894	24	3,753		
7	710	16	2,063	25	4,091		
8	846	17	2,231	26	4,428		
9	981	18	2,400	27	4,767		

Select upholstery for everything else other than the seat and back cushions (the outside back, arms, sides, seat frame). You can specify the same fabric as the cushions or select other fabric.

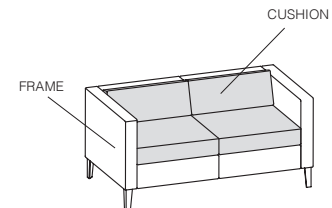

TO ORDER PLEASE SPECIFY THE FOLLOWING:

<input type="text"/>	<input type="text"/>	<input type="text"/>	<input type="text"/>	<input type="text"/>
MODEL NUMBER	STITCH DETAIL	FLAMMABILITY RATING	CUSHION UPHOLSTERY	FRAME UPHOLSTERY
	None NR Stitch detail SD +\$197	U CTB117	Please refer to list of available upholstery and leather selections on www.gunlocke.com	Please refer to list of available upholstery and leather selections on www.gunlocke.com

Example

GK1101-2A.NR.U.DOL728.SPNN04

GK1101-2A	NR	U	DOL728	SPNN04
MODEL NUMBER	STITCH	FLAMMABILITY DETAIL	CUSHION UPHOLSTERY	FRAME UPHOLSTERY

Please refer to the Ciji product page on www.gunlocke.com for standard finish options.

model number	fabric grades
GK1103-2W	1 4,370

Low back, armless,
Wood legs

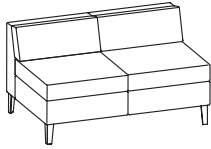

dimensions	W	D	H
Overall	49 1/8"	31 1/2"	27 7/8"
Seat	48 1/2"	21"	17 1/4"

Upholstery Requirements: GK1103-2W

	Dual Upholstery	
Fabric yds	Cushions 2.9	Frame 2.3
Leather ft ²	Cushions 66.7	Frame 52.9
Shipping weight	99 lbs.	
Cube	35	

Cushion	1	10	623	19	1,433	L1	954	
	2	57	11	698	20	1,528	L2	1,742
	3	115	12	773	21	1,622	L3	2,688
	COM/4	170	13	868	22	1,716	L4	3,476
	5	246	14	963	23	1,905	L5	4,264
	6	321	15	1,056	24	2,093		
	7	397	16	1,151	25	2,282		
	8	472	17	1,245	26	2,469		
	9	547	18	1,339	27	2,659		

To calculate price of lounge with different fabric for cushion and frame; start with Grade 1 price, add appropriate grade price located in second row for cushion, and last add appropriate grade price located in third row for frame to the sum of the Grade 1 and cushion price.

Example: Grade 1 \$4,370 + grade 4 fabric cushion \$170 + grade 2 fabric frame \$46 = \$4,586

Select upholstery for everything else other than the seat and back cushions (the outside back, arms, sides, seat frame). You can specify the same fabric as the cushions or select other fabric.

Frame	1	10	494	19	1,138	L1	757	
	2	46	11	555	20	1,213	L2	1,382
	3	91	12	614	21	1,287	L3	2,132
	COM/4	135	13	690	22	1,362	L4	2,757
	5	195	14	764	23	1,512	L5	3,383
	6	255	15	839	24	1,661		
	7	316	16	913	25	1,809		
	8	374	17	988	26	1,959		
	9	434	18	1,062	27	2,110		

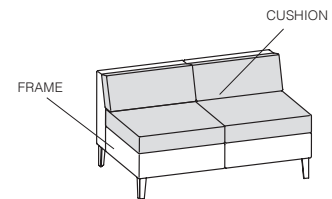

TO ORDER PLEASE SPECIFY THE FOLLOWING:

.

MODEL NUMBER	WOOD FINISH	STITCH DETAIL	FLAMMABILITY RATING	CUSHION UPHOLSTERY	FRAME UPHOLSTERY
	Cherry finishes on Maple Walnut finishes on Maple Maple finishes on Maple Oak finishes on Maple <i>Light Rift Oak 301 not available on Maple.</i>	None NR Stitch detail SD +\$197	U CTB117	Please refer to list of available upholstery and leather selections on www.gunlocke.com	Please refer to list of available upholstery and leather selections on www.gunlocke.com

Example

GK1103-2W.777.NR.U.DOL728.SPNO4					
GK1103-2W	777	NR	U	DOL728	SPNO4
MODEL NUMBER	WOOD FINISH	STITCH DETAIL	FLAMMABILITY	CUSHION UPHOLSTERY	FRAME UPHOLSTERY

Please refer to the Ciji product page on www.gunlocke.com for standard finish options.

model number	fabric grades	dimensions	W	D	H
--------------	---------------	------------	---	---	---

GK1105-2W
Low back, arm left,
Wood legs

1 5,076

Overall	52 5/8"	31 1/2"	27 7/8"
Seat	48 1/2"	21"	17 1/4"
Arm			26 7/8"
Between arms			

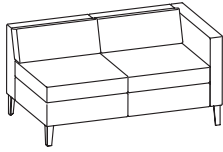

Upholstery Requirements: GK1105-2W

	Dual Upholstery	
Fabric yds	Cushions 2.9	Frame 3.8
Leather ft ²	Cushions 66.7	Frame 87.4
Shipping weight		109 lbs.
Cube		35

Cushion

1	10	623	19	1,433	L1	954	
2	57	11	698	20	1,528	L2	1,742
3	115	12	773	21	1,622	L3	2,688
COM/4	170	13	868	22	1,716	L4	3,476
5	246	14	963	23	1,905	L5	4,264
6	321	15	1,056	24	2,093		
7	397	16	1,151	25	2,282		
8	472	17	1,245	26	2,469		
9	547	18	1,339	27	2,659		

To calculate price of lounge with different fabric for cushion and frame; start with Grade 1 price, add appropriate grade price located in second row for cushion, and last add appropriate grade price located in third row for frame to the sum of the Grade 1 and cushion price.

Example: Grade 1 \$5,076 + grade 4 fabric cushion \$170 + grade 2 fabric frame \$75 = \$5,321

Frame

1	10	816	19	1,878	L1	1,250	
2	75	11	915	20	2,002	L2	2,282
3	149	12	1,014	21	2,125	L3	3,522
COM/4	223	13	1,138	22	2,249	L4	4,555
5	322	14	1,260	23	2,495	L5	5,587
6	421	15	1,384	24	2,742		
7	520	16	1,507	25	2,990		
8	618	17	1,631	26	3,237		
9	717	18	1,755	27	3,484		

Select upholstery for everything else other than the seat and back cushions (the outside back, arms, sides, seat frame). You can specify the same fabric as the cushions or select other fabric.

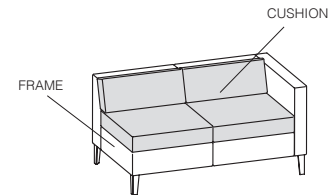

TO ORDER PLEASE SPECIFY THE FOLLOWING:

.

MODEL NUMBER	WOOD FINISH	STITCH DETAIL	FLAMMABILITY RATING	CUSHION UPHOLSTERY	FRAME UPHOLSTERY
	Cherry finishes on Maple Walnut finishes on Maple Maple finishes on Maple Oak finishes on Maple <i>Light Rift Oak 301 not available on Maple.</i>	None NR Stitch detail SD +\$197	U CTB117	Please refer to list of available upholstery and leather selections on www.gunlocke.com	Please refer to list of available upholstery and leather selections on www.gunlocke.com

Example

GK1105-2W.777.NR.U.DOL728.SPNN04

GK1105-2W	777	NR	U	DOL728	SPNN04
MODEL NUMBER	WOOD FINISH	STITCH DETAIL	FLAMMABILITY	CUSHION UPHOLSTERY	FRAME UPHOLSTERY

Please refer to the Ciji product page on www.gunlocke.com for standard finish options.

CIJI TWO SEAT

Low Back, Arm Left, Aluminum Legs

Seating
02/24

model number fabric grades dimensions W D H

GK1105-2A 1 5,362
Low back, arm left,
Aluminum legs

Overall	52 5/8"	31 1/2"	27 7/8"
Seat	48 1/2"	21"	17 1/4"
Arm			26 7/8"
Between arms			

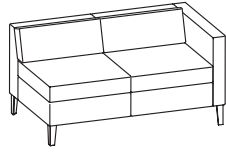

Upholstery Requirements: GK1105-2A

	Dual Upholstery	
Fabric yds	Cushions 2.9	Frame 3.8
Leather ft ²	Cushions 66.7	Frame 87.4
Shipping weight	109 lbs.	
Cube	35	

Cushion

1	10	623	19	1,433	L1	954	
2	57	11	698	20	1,528	L2	1,742
3	115	12	773	21	1,622	L3	2,688
COM/4	170	13	868	22	1,716	L4	3,476
5	246	14	963	23	1,905	L5	4,264
6	321	15	1,056	24	2,093		
7	397	16	1,151	25	2,282		
8	472	17	1,245	26	2,469		
9	547	18	1,339	27	2,659		

To calculate price of lounge with different fabric for cushion and frame; start with Grade 1 price, add appropriate grade price located in second row for cushion, and last add appropriate grade price located in third row for frame to the sum of the Grade 1 and cushion price.

Example: Grade 1 \$5,362 + grade 4 fabric cushion \$170 + grade 2 fabric frame \$75 = \$5,607

Frame

1	10	816	19	1,878	L1	1,250	
2	75	11	915	20	2,002	L2	2,282
3	149	12	1,014	21	2,125	L3	3,522
COM/4	223	13	1,138	22	2,249	L4	4,555
5	322	14	1,260	23	2,495	L5	5,587
6	421	15	1,384	24	2,742		
7	520	16	1,507	25	2,990		
8	618	17	1,631	26	3,237		
9	717	18	1,755	27	3,484		

Select upholstery for everything else other than the seat and back cushions (the outside back, arms, sides, seat frame). You can specify the same fabric as the cushions or select other fabric.

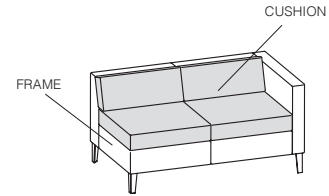

TO ORDER PLEASE SPECIFY THE FOLLOWING:

<input type="text"/>	<input type="text"/>	<input type="text"/>	<input type="text"/>	<input type="text"/>
MODEL NUMBER	STITCH DETAIL	FLAMMABILITY RATING	CUSHION UPHOLSTERY	FRAME UPHOLSTERY
	None NR Stitch detail SD +\$197	U CTB117	Please refer to list of available upholstery and leather selections on www.gunlocke.com	Please refer to list of available upholstery and leather selections on www.gunlocke.com

Example

GK1105-2A.NR.U.DOL728.SPNN04
GK1105-2A NR U DOL728 SPNN04
MODEL NUMBER STITCH FLAMMABILITY CUSHION FRAME
DETAIL RATING UPHOLSTERY UPHOLSTERY

Please refer to the Ciji product page on www.gunlocke.com for standard finish options.

Seating
02/24

CIJI TWO SEAT

Low Back, Arm Right, Wood Legs

model number fabric grades
GK1107-2W **1** 5,076

Low back, arm right,
Wood legs

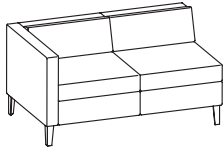

dimensions	W	D	H
Overall	52 5/8"	31 1/2"	27 7/8"
Seat	48 1/2"	21"	17 1/4"
Arm			26 7/8"
Between arms			

Upholstery Requirements: GK1107-2W

	Dual Upholstery	
Fabric yds	Cushions 2.9	Frame 3.8
Leather ft ²	Cushions 66.7	Frame 87.4
Shipping weight	109 lbs.	
Cube	35	

Cushion

1	10	623	19	1,433	L1	954	
2	57	11	698	20	1,528	L2	1,742
3	115	12	773	21	1,622	L3	2,688
COM/4	170	13	868	22	1,716	L4	3,476
5	246	14	963	23	1,905	L5	4,264
6	321	15	1,056	24	2,093		
7	397	16	1,151	25	2,282		
8	472	17	1,245	26	2,469		
9	547	18	1,339	27	2,659		

To calculate price of lounge with different fabric for cushion and frame; start with Grade 1 price, add appropriate grade price located in second row for cushion, and last add appropriate grade price located in third row for frame to the sum of the Grade 1 and cushion price.

Example: Grade 1 \$5,076 + grade 4 fabric cushion \$170 + grade 2 fabric frame \$75 = \$5,321

Select upholstery for everything else other than the seat and back cushions (the outside back, arms, sides, seat frame). You can specify the same fabric as the cushions or select other fabric.

Frame

1	10	816	19	1,878	L1	1,250	
2	75	11	915	20	2,002	L2	2,282
3	149	12	1,014	21	2,125	L3	3,522
COM/4	223	13	1,138	22	2,249	L4	4,555
5	322	14	1,260	23	2,495	L5	5,587
6	421	15	1,384	24	2,742		
7	520	16	1,507	25	2,990		
8	618	17	1,631	26	3,237		
9	717	18	1,755	27	3,484		

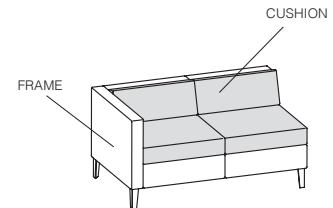

TO ORDER PLEASE SPECIFY THE FOLLOWING:

<input type="text"/>	<input type="text"/>	<input type="text"/>	<input type="text"/>	<input type="text"/>	<input type="text"/>
MODEL NUMBER	WOOD FINISH	STITCH DETAIL	FLAMMABILITY RATING	CUSHION UPHOLSTERY	FRAME UPHOLSTERY
	Cherry finishes on Maple Walnut finishes on Maple Maple finishes on Maple Oak finishes on Maple <i>Light Rift Oak 301 not available on Maple.</i>	None NR Stitch detail SD +\$197	U CTB117	Please refer to list of available upholstery and leather selections on www.gunlocke.com	Please refer to list of available upholstery and leather selections on www.gunlocke.com

Example

GK1107-2W.777.NR.U.DOL728.SPNN04
 GK1107-2W 777 NR U DOL728 SPNN04
 MODEL NUMBER WOOD FINISH STITCH DETAIL FLAMMABILITY CUSHION UPHOLSTERY FRAME UPHOLSTERY

Please refer to the Ciji product page on www.gunlocke.com for standard finish options.

CIJI TWO SEAT

Low Back, Arm Right, Aluminum Legs

Seating
02/24

model number	fabric grades	dimensions	W	D	H
--------------	---------------	------------	---	---	---

GK1107-2A
Low back, arm right
Aluminum legs

1 5,362

Overall	52 5/8"	31 1/2"	27 7/8"
Seat	48 1/2"	21"	17 1/4"
Arm			26 7/8"
Between arms			



Upholstery Requirements: GK1107-2A

	Dual Upholstery	
Fabric yds	Cushions 2.9	Frame 3.8
Leather ft ²	Cushions 66.7	Frame 87.4
Shipping weight	109 lbs.	
Cube	35	

Cushion

1	10	623	19	1,433	L1	954	
2	57	11	698	20	1,528	L2	1,742
3	115	12	773	21	1,622	L3	2,688
COM/4	170	13	868	22	1,716	L4	3,476
5	246	14	963	23	1,905	L5	4,264
6	321	15	1,056	24	2,093		
7	397	16	1,151	25	2,282		
8	472	17	1,245	26	2,469		
9	547	18	1,339	27	2,659		

To calculate price of lounge with different fabric for cushion and frame; start with Grade 1 price, add appropriate grade price located in second row for cushion, and last add appropriate grade price located in third row for frame to the sum of the Grade 1 and cushion price.

Example: Grade 1 \$5,362 + grade 4 fabric cushion \$170 + grade 2 fabric frame \$75 = \$5,607

Select upholstery for everything else other than the seat and back cushions (the outside back, arms, sides, seat frame). You can specify the same fabric as the cushions or select other fabric.

Frame

1	10	816	19	1,878	L1	1,250	
2	75	11	915	20	2,002	L2	2,282
3	149	12	1,014	21	2,125	L3	3,522
COM/4	223	13	1,138	22	2,249	L4	4,555
5	322	14	1,260	23	2,495	L5	5,587
6	421	15	1,384	24	2,742		
7	520	16	1,507	25	2,990		
8	618	17	1,631	26	3,237		
9	717	18	1,755	27	3,484		

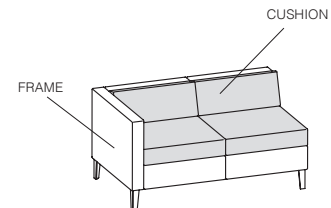

TO ORDER PLEASE SPECIFY THE FOLLOWING:

<input type="text"/>	<input type="text"/>	<input type="text"/>	<input type="text"/>	<input type="text"/>
MODEL NUMBER	STITCH DETAIL	FLAMMABILITY RATING	CUSHION UPHOLSTERY	FRAME UPHOLSTERY
	None NR Stitch detail SD +\$197	U CTB117	Please refer to list of available upholstery and leather selections on www.gunlocke.com	Please refer to list of available upholstery and leather selections on www.gunlocke.com

Example

GK1107-2A.NR.U.DOL728.SPNN04

GK1107-2A	NR	U	DOL728	SPNN04
MODEL NUMBER	STITCH	FLAMMABILITY DETAIL	CUSHION UPHOLSTERY	FRAME UPHOLSTERY

Please refer to the Ciji product page on www.gunlocke.com for standard finish options.

Seating
02/24

CIJI THREE SEAT

Low Back, with Arms, Wood Legs

model number fabric grades
GK1101-3W **1** 6,745

Low back, with arms,
Wood legs

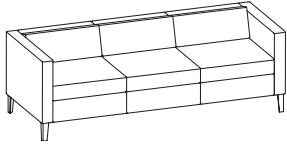

dimensions	W	D	H
Overall	80 3/4"	31 1/2"	27 7/8"
Seat	73"	21"	17 1/4"
Arm			26 7/8"
Between arms	73"		

Upholstery Requirements: GK1101-3W

	Dual Upholstery	
Fabric yds	Cushions 4.4	Frame 5.9
Leather ft ²	Cushions 101.2	Frame 135.7
Shipping weight	181 lbs.	
Cube	78.5	

Cushion

1	10	945	19	2,175	L1	1,447
2	86	11	1,059	20	L2	2,642
3	173	12	1,173	21	L3	4,077
COM/4	258	13	1,317	22	L4	5,273
5	372	14	1,459	23	L5	6,470
6	487	15	1,603	24		
7	602	16	1,745	25		
8	716	17	1,888	26		
9	831	18	2,032	27		

To calculate price of lounge with different fabric for cushion and frame; start with Grade 1 price, add appropriate grade price located in second row for cushion, and last add appropriate grade price located in third row for frame to the sum of the Grade 1 and cushion price.

Example: Grade 1 \$6,745 + grade 4 fabric cushion \$258 + grade 2 fabric frame \$116 = \$7,119

Frame

1	10	1,266	19	2,915	L1	1,940
2	116	11	1,420	20	L2	3,543
3	231	12	1,572	21	L3	5,468
COM/4	346	13	1,765	22	L4	7,070
5	499	14	1,956	23	L5	8,675
6	654	15	2,149	24		
7	806	16	2,341	25		
8	959	17	2,531	26		
9	1,114	18	2,724	27		

Select upholstery for everything else other than the seat and back cushions (the outside back, arms, sides, seat frame). You can specify the same fabric as the cushions or select other fabric.

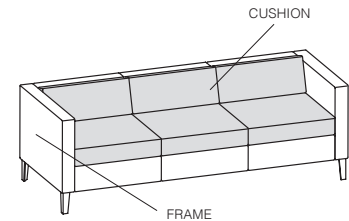

TO ORDER PLEASE SPECIFY THE FOLLOWING:

<input type="text"/>	<input type="text"/>	<input type="text"/>	<input type="text"/>	<input type="text"/>	<input type="text"/>
MODEL NUMBER	WOOD FINISH	STITCH DETAIL	FLAMMABILITY RATING	CUSHION UPHOLSTERY	FRAME UPHOLSTERY
	Cherry finishes on Maple Walnut finishes on Maple Maple finishes on Maple Oak finishes on Maple <i>Light Rift Oak 301 not available on Maple.</i>	None NR Stitch detail SD +\$197	U CTB117	Please refer to list of available upholstery and leather selections on www.gunlocke.com	Please refer to list of available upholstery and leather selections on www.gunlocke.com

Example

GK1101-3W.777.NR.U.DOL728.SPNN04
 GK1101-3W 777 NR U DOL728 SPNN04
 MODEL NUMBER WOOD FINISH STITCH DETAIL FLAMMABILITY CUSHION UPHOLSTERY FRAME UPHOLSTERY

Please refer to the Ciji product page on www.gunlocke.com for standard finish options.

CIJI THREE SEAT

Low Back, with Arms, Aluminum Legs

Seating
02/24

model number	fabric grades	dimensions	W	D	H
GK1101-3A Low back, with arms, Aluminum legs	1 7,027	Overall	80 3/4"	31 1/2"	27 7/8"
		Seat	73"	21"	17 1/4"
		Arm			26 7/8"
		Between arms	73"		

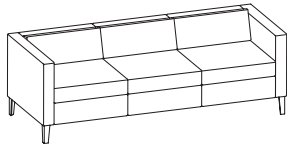

Upholstery Requirements: GK1101-3A

	Dual Upholstery	
Fabric yds	Cushions 4.4	Frame 5.9
Leather ft ²	Cushions 101.2	Frame 135.7
Shipping weight	181 lbs.	
Cube	78.5	

Cushion	1	10	945	19	2,175	L1	1,447
	2	86	11	1,059	20	2,317	L2 2,642
	3	173	12	1,173	21	2,461	L3 4,077
	COM/4	258	13	1,317	22	2,603	L4 5,273
	5	372	14	1,459	23	2,890	L5 6,470
	6	487	15	1,603	24	3,176	
	7	602	16	1,745	25	3,461	
	8	716	17	1,888	26	3,748	
	9	831	18	2,032	27	4,034	

To calculate price of lounge with different fabric for cushion and frame; start with Grade 1 price, add appropriate grade price located in second row for cushion, and last add appropriate grade price located in third row for frame to the sum of the Grade 1 and cushion price.

Example: Grade 1 \$7,027 + grade 4 fabric cushion \$258 + grade 2 fabric frame \$116 = \$7,401

Frame	1	10	1,266	19	2,915	L1	1,940
	2	116	11	1,420	20	3,108	L2 3,543
	3	231	12	1,572	21	3,300	L3 5,468
	COM/4	346	13	1,765	22	3,490	L4 7,070
	5	499	14	1,956	23	3,874	L5 8,675
	6	654	15	2,149	24	4,259	
	7	806	16	2,341	25	4,641	
	8	959	17	2,531	26	5,025	
	9	1,114	18	2,724	27	5,408	

Select upholstery for everything else other than the seat and back cushions (the outside back, arms, sides, seat frame). You can specify the same fabric as the cushions or select other fabric.

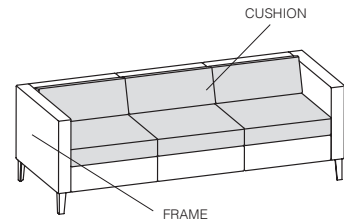

TO ORDER PLEASE SPECIFY THE FOLLOWING:

<input type="text"/>	<input type="text"/>	<input type="text"/>	<input type="text"/>	<input type="text"/>
MODEL NUMBER	STITCH DETAIL	FLAMMABILITY RATING	CUSHION UPHOLSTERY	FRAME UPHOLSTERY
	None NR Stitch detail SD +\$197	U CTB117	Please refer to list of available upholstery and leather selections on www.gunlocke.com	Please refer to list of available upholstery and leather selections on www.gunlocke.com

Example

GK1101-3A.NR.U.DOL728.SPNN04				
GK1101-3A	NR	U	DOL728	SPNN04
MODEL NUMBER	STITCH	FLAMMABILITY DETAIL	CUSHION UPHOLSTERY	FRAME UPHOLSTERY

Please refer to the Ciji product page on www.gunlocke.com for standard finish options.

model number fabric grades dimensions W D H

GK1103-3W
Low back, armless,
Wood legs

Overall	73 5/8"	31 1/2"	27 7/8"
Seat	73"	21"	17 1/4"

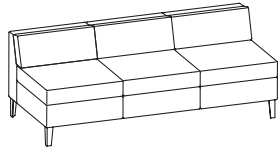

Upholstery Requirements: GK1103-3W

	Dual Upholstery	
Fabric yds	Cushions 4.4	Frame 3.2
Leather ft ²	Cushions 101.2	Frame 73.6
Shipping weight	161 lbs.	
Cube	78.5	

Cushion

1	10	945	19	2,175	L1	1,447
2	86	11	1,059	20	L2	2,642
3	173	12	1,173	21	L3	4,077
COM/4	258	13	1,317	22	L4	5,273
5	372	14	1,459	23	L5	6,470
6	487	15	1,603	24		
7	602	16	1,745	25		
8	716	17	1,888	26		
9	831	18	2,032	27		

To calculate price of lounge with different fabric for cushion and frame; start with Grade 1 price, add appropriate grade price located in second row for cushion, and last add appropriate grade price located in third row for frame to the sum of the Grade 1 and cushion price.

Example: Grade 1 \$5,619 + grade 4 fabric cushion \$258 + grade 2 fabric frame \$64 = \$5,941

Select upholstery for everything else other than the seat and back cushions (the outside back, arms, sides, seat frame). You can specify the same fabric as the cushions or select other fabric.

Frame

1	10	686	19	1,582	L1	1,052
2	64	11	770	20	L2	1,921
3	125	12	854	21	L3	2,966
COM/4	189	13	957	22	L4	3,836
5	271	14	1,062	23	L5	4,706
6	355	15	1,165	24		
7	438	16	1,269	25		
8	521	17	1,375	26		
9	604	18	1,478	27		

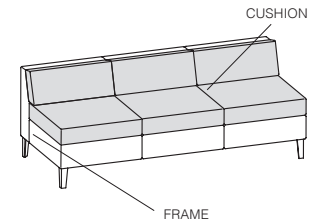

TO ORDER PLEASE SPECIFY THE FOLLOWING:

.

MODEL NUMBER	WOOD FINISH	STITCH DETAIL	FLAMMABILITY RATING	CUSHION UPHOLSTERY	FRAME UPHOLSTERY
	Cherry finishes on Maple Walnut finishes on Maple Maple finishes on Maple Oak finishes on Maple <i>Light Rift Oak 301 not available on Maple.</i>	None NR Stitch detail SD +\$197	U CTB117	Please refer to list of available upholstery and leather selections on www.gunlocke.com	Please refer to list of available upholstery and leather selections on www.gunlocke.com

Example

GK1103-3W.777.NR.U.DOL728.SPNO4					
GK1103-3W	777	NR	U	DOL728	SPNO4
MODEL NUMBER	WOOD FINISH	STITCH DETAIL	FLAMMABILITY	CUSHION UPHOLSTERY	FRAME UPHOLSTERY

Please refer to the Ciji product page on www.gunlocke.com for standard finish options.

CIJI THREE SEAT

Low Back, Armless, Aluminum Legs

Seating
02/24

model number fabric grades dimensions W D H

GK1103-3A
Low back, armless,
Aluminum legs

1 5,905

Overall	73 5/8"	31 1/2"	27 7/8"
Seat	73"	21"	17 1/4"

Upholstery Requirements: GK1103-3A

	Dual Upholstery	
Fabric yds	Cushions 4.4	Frame 3.2
Leather ft ²	Cushions 101.2	Frame 73.6
Shipping weight	161 lbs.	
Cube	78.5	

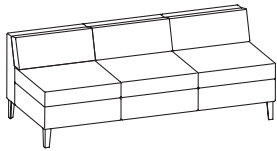

Cushion

1	10	945	19	2,175	L1	1,447
2	86	11	1,059	20	L2	2,642
3	173	12	1,173	21	L3	4,077
COM/4	258	13	1,317	22	L4	5,273
5	372	14	1,459	23	L5	6,470
6	487	15	1,603	24		
7	602	16	1,745	25		
8	716	17	1,888	26		
9	831	18	2,032	27		

To calculate price of lounge with different fabric for cushion and frame; start with Grade 1 price, add appropriate grade price located in second row for cushion, and last add appropriate grade price located in third row for frame to the sum of the Grade 1 and cushion price.

Example: Grade 1 \$5,905 + grade 4 fabric cushion \$258 + grade 2 fabric frame \$64 = \$6,227

Select upholstery for everything else other than the seat and back cushions (the outside back, arms, sides, seat frame). You can specify the same fabric as the cushions or select other fabric.

Frame

1	10	686	19	1,582	L1	1,052
2	64	11	770	20	L2	1,921
3	125	12	854	21	L3	2,966
COM/4	189	13	957	22	L4	3,836
5	271	14	1,062	23	L5	4,706
6	355	15	1,165	24		
7	438	16	1,269	25		
8	521	17	1,375	26		
9	604	18	1,478	27		

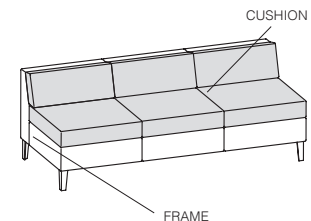

TO ORDER PLEASE SPECIFY THE FOLLOWING:

<input type="text"/>	<input type="text"/>	<input type="text"/>	<input type="text"/>	<input type="text"/>
MODEL NUMBER	STITCH DETAIL	FLAMMABILITY RATING	CUSHION UPHOLSTERY	FRAME UPHOLSTERY
	None NR Stitch detail SD +\$197	U CTB117	Please refer to list of available upholstery and leather selections on www.gunlocke.com	Please refer to list of available upholstery and leather selections on www.gunlocke.com

Example

GK1103-3A.NR.U.DOL728.SPNN04
GK1103-3A NR U DOL728 SPNN04
MODEL NUMBER STITCH FLAMMABILITY CUSHION FRAME
DETAIL RATING UPHOLSTERY UPHOLSTERY

Please refer to the Ciji product page on www.gunlocke.com for standard finish options.

Seating
02/24

CIJI THREE SEAT
Low Back, Arm Left, Wood Legs

model number fabric grades dimensions W D H

GK1105-3W **1** 6,501
Low back, arm left,
Wood legs

Overall	77 1/8"	31 1/2"	27 7/8"
Seat	73"	21"	17 1/4"
Arm			26 7/8"
Between arms			

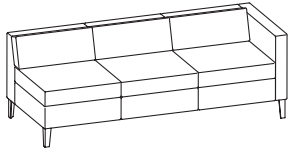

Upholstery Requirements: GK1105-3W

	Dual Upholstery	
Fabric yds	Cushions 4.4	Frame 5.2
Leather ft ²	Cushions 101.2	Frame 119.6
Shipping weight		171 lbs.
Cube		78.5

Cushion	1	10	945	19	2,175	L1	1,447	
	2	86	11	1,059	20	2,317	L2	2,642
	3	173	12	1,173	21	2,461	L3	4,077
	COM/4	258	13	1,317	22	2,603	L4	5,273
	5	372	14	1,459	23	2,890	L5	6,470
	6	487	15	1,603	24	3,176		
	7	602	16	1,745	25	3,461		
	8	716	17	1,888	26	3,748		
	9	831	18	2,032	27	4,034		

To calculate price of lounge with different fabric for cushion and frame; start with Grade 1 price, add appropriate grade price located in second row for cushion, and last add appropriate grade price located in third row for frame to the sum of the Grade 1 and cushion price.

Example: Grade 1 \$6,501 + grade 4 fabric cushion \$258 + grade 2 fabric frame \$102 = \$6,861

Select upholstery for everything else other than the seat and back cushions (the outside back, arms, sides, seat frame). You can specify the same fabric as the cushions or select other fabric.

Frame	1	10	1,116	19	2,569	L1	1,709	
	2	102	11	1,252	20	2,739	L2	3,123
	3	204	12	1,387	21	2,908	L3	4,819
	COM/4	305	13	1,556	22	3,077	L4	6,232
	5	440	14	1,725	23	3,415	L5	7,645
	6	576	15	1,894	24	3,753		
	7	710	16	2,063	25	4,091		
	8	846	17	2,231	26	4,428		
	9	981	18	2,400	27	4,767		

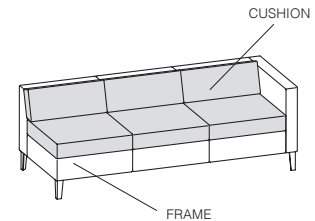

TO ORDER PLEASE SPECIFY THE FOLLOWING:

<input type="text"/>	<input type="text"/>	<input type="text"/>	<input type="text"/>	<input type="text"/>	<input type="text"/>
MODEL NUMBER	WOOD FINISH	STITCH DETAIL	FLAMMABILITY RATING	CUSHION UPHOLSTERY	FRAME UPHOLSTERY
	Cherry finishes on Maple Walnut finishes on Maple Maple finishes on Maple Oak finishes on Maple <i>Light Rift Oak 301 not available on Maple.</i>	None NR Stitch detail SD +\$197	U CTB117	Please refer to list of available upholstery and leather selections on www.gunlocke.com	Please refer to list of available upholstery and leather selections on www.gunlocke.com

Example

GK1105-3W.777.NR.U.DOL728.SPNN04
 GK1105-3W 777 NR U DOL728 SPNN04
 MODEL NUMBER WOOD FINISH STITCH DETAIL FLAMMABILITY CUSHION UPHOLSTERY FRAME UPHOLSTERY

Please refer to the Ciji product page on www.gunlocke.com for standard finish options.

CIJI THREE SEAT

Low Back, Arm Left, Aluminum Legs

Seating
02/24

model number fabric grades dimensions W D H

GK1105-3A **1** 6,786
Low back, arm left,
Aluminum legs

Overall	77 1/8"	31 1/2"	27 7/8"
Seat	73"	21"	17 1/4"
Arm			26 7/8"
Between arms			

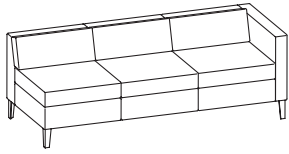

Upholstery Requirements: GK1105-3A

	Dual Upholstery	
Fabric yds	Cushions 4.4	Frame 5.2
Leather ft ²	Cushions 101.2	Frame 119.6
Shipping weight		171 lbs.
Cube		78.5

Cushion	1	10	945	19	2,175	L1	1,447	
	2	86	11	1,059	20	2,317	L2	2,642
	3	173	12	1,173	21	2,461	L3	4,077
	COM/4	258	13	1,317	22	2,603	L4	5,273
	5	372	14	1,459	23	2,890	L5	6,470
	6	487	15	1,603	24	3,176		
	7	602	16	1,745	25	3,461		
	8	716	17	1,888	26	3,748		
	9	831	18	2,032	27	4,034		

To calculate price of lounge with different fabric for cushion and frame; start with Grade 1 price, add appropriate grade price located in second row for cushion, and last add appropriate grade price located in third row for frame to the sum of the Grade 1 and cushion price.

Example: Grade 1 \$6,786 + grade 4 fabric cushion \$258 + grade 2 fabric frame \$102 = \$7,146

Frame	1	10	1,116	19	2,569	L1	1,709	
	2	102	11	1,252	20	2,739	L2	3,123
	3	204	12	1,387	21	2,908	L3	4,819
	COM/4	305	13	1,556	22	3,077	L4	6,232
	5	440	14	1,725	23	3,415	L5	7,645
	6	576	15	1,894	24	3,753		
	7	710	16	2,063	25	4,091		
	8	846	17	2,231	26	4,428		
	9	981	18	2,400	27	4,767		

Select upholstery for everything else other than the seat and back cushions (the outside back, arms, sides, seat frame). You can specify the same fabric as the cushions or select other fabric.

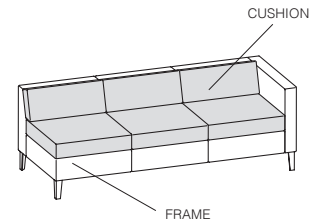

TO ORDER PLEASE SPECIFY THE FOLLOWING:

<input type="text"/>	<input type="text"/>	<input type="text"/>	<input type="text"/>	<input type="text"/>
MODEL NUMBER	STITCH DETAIL	FLAMMABILITY RATING	CUSHION UPHOLSTERY	FRAME UPHOLSTERY
	None NR Stitch detail SD +\$197	U CTB117	Please refer to list of available upholstery and leather selections on www.gunlocke.com	Please refer to list of available upholstery and leather selections on www.gunlocke.com

Example

GK1105-3A.NR.U.DOL728.SPNN04
GK1105-3A NR U DOL728 SPNN04
MODEL NUMBER STITCH FLAMMABILITY CUSHION FRAME
DETAIL RATING UPHOLSTERY UPHOLSTERY

Please refer to the Ciji product page on www.gunlocke.com for standard finish options.

Seating
02/24

CIJI THREE SEAT

Low Back, Arm Right, Wood Legs

model number fabric grades
GK1107-3W **1** 6,501

Low back, arm right,
Wood legs

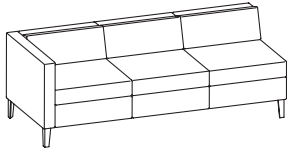

dimensions	W	D	H
Overall	77 1/8"	31 1/2"	27 7/8"
Seat	73"	21"	17 1/4"
Arm			26 7/8"
Between arms			

Upholstery Requirements: GK1107-3W

	Dual Upholstery	
Fabric yds	Cushions 4.4	Frame 5.2
Leather ft²	Cushions 101.2	Frame 119.6
Shipping weight		171 lbs.
Cube		78.5

Cushion

1	10	945	19	2,175	L1	1,447
2	86	11	1,059	20	L2	2,642
3	173	12	1,173	21	L3	4,077
COM/4	258	13	1,317	22	L4	5,273
5	372	14	1,459	23	L5	6,470
6	487	15	1,603	24		
7	602	16	1,745	25		
8	716	17	1,888	26		
9	831	18	2,032	27		

To calculate price of lounge with different fabric for cushion and frame; start with Grade 1 price, add appropriate grade price located in second row for cushion, and last add appropriate grade price located in third row for frame to the sum of the Grade 1 and cushion price.

Example: Grade 1 \$6,501 + grade 4 fabric cushion \$258 + grade 2 fabric frame \$102 = \$6,861

Frame

1	10	1,116	19	2,569	L1	1,709
2	102	11	1,252	20	L2	3,123
3	204	12	1,387	21	L3	4,819
COM/4	305	13	1,556	22	L4	6,232
5	440	14	1,725	23	L5	7,645
6	576	15	1,894	24		
7	710	16	2,063	25		
8	846	17	2,231	26		
9	981	18	2,400	27		

Select upholstery for everything else other than the seat and back cushions (the outside back, arms, sides, seat frame). You can specify the same fabric as the cushions or select other fabric.

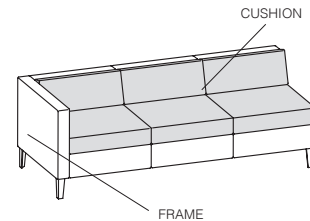

TO ORDER PLEASE SPECIFY THE FOLLOWING:

.

MODEL NUMBER	WOOD FINISH	STITCH DETAIL	FLAMMABILITY RATING	CUSHION UPHOLSTERY	FRAME UPHOLSTERY
	Cherry finishes on Maple Walnut finishes on Maple Maple finishes on Maple Oak finishes on Maple <i>Light Rift Oak 301 not available on Maple.</i>	None NR Stitch detail SD +\$197	U CTB117	Please refer to list of available upholstery and leather selections on www.gunlocke.com	Please refer to list of available upholstery and leather selections on www.gunlocke.com

Example

GK1107-3W.777.NR.U.DOL728.SPNN04

GK1107-3W	777	NR	U	DOL728	SPNN04
MODEL NUMBER	WOOD FINISH	STITCH DETAIL	FLAMMABILITY	CUSHION UPHOLSTERY	FRAME UPHOLSTERY

Please refer to the Ciji product page on www.gunlocke.com for standard finish options.

CIJI THREE SEAT

Low Back, Arm Right, Aluminum Legs

Seating
02/24

model number fabric grades dimensions W D H

GK1107-3A **1** 6,786
Low back, arm right,
Aluminum legs

Overall	77 1/8"	31 1/2"	27 7/8"
Seat	73"	21"	17 1/4"
Arm			26 7/8"
Between arms			

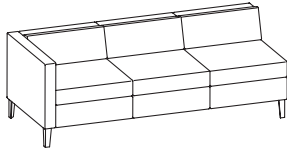

Upholstery Requirements: GK1107-3A

	Dual Upholstery	
Fabric yds	Cushions 4.4	Frame 5.2
Leather ft ²	Cushions 101.2	Frame 119.6
Shipping weight		171 lbs.
Cube		78.5

Cushion	1	10	945	19	2,175	L1	1,447	
	2	86	11	1,059	20	2,317	L2	2,642
	3	173	12	1,173	21	2,461	L3	4,077
	COM/4	258	13	1,317	22	2,603	L4	5,273
	5	372	14	1,459	23	2,890	L5	6,470
	6	487	15	1,603	24	3,176		
	7	602	16	1,745	25	3,461		
	8	716	17	1,888	26	3,748		
	9	831	18	2,032	27	4,034		

To calculate price of lounge with different fabric for cushion and frame; start with Grade 1 price, add appropriate grade price located in second row for cushion, and last add appropriate grade price located in third row for frame to the sum of the Grade 1 and cushion price.

Example: Grade 1 \$6,786 + grade 4 fabric cushion \$258 + grade 2 fabric frame \$102 = \$7,146

Frame	1	10	1,116	19	2,569	L1	1,709	
	2	102	11	1,252	20	2,739	L2	3,123
	3	204	12	1,387	21	2,908	L3	4,819
	COM/4	305	13	1,556	22	3,077	L4	6,232
	5	440	14	1,725	23	3,415	L5	7,645
	6	576	15	1,894	24	3,753		
	7	710	16	2,063	25	4,091		
	8	846	17	2,231	26	4,428		
	9	981	18	2,400	27	4,767		

Select upholstery for everything else other than the seat and back cushions (the outside back, arms, sides, seat frame). You can specify the same fabric as the cushions or select other fabric.

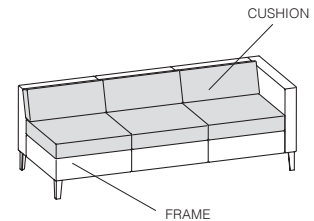

TO ORDER PLEASE SPECIFY THE FOLLOWING:

<input type="text"/>	<input type="text"/>	<input type="text"/>	<input type="text"/>	<input type="text"/>
MODEL NUMBER	STITCH DETAIL	FLAMMABILITY RATING	CUSHION UPHOLSTERY	FRAME UPHOLSTERY
	None NR Stitch detail SD +\$197	U CTB117	Please refer to list of available upholstery and leather selections on www.gunlocke.com	Please refer to list of available upholstery and leather selections on www.gunlocke.com

Example

GK1107-3A.NR.U.DOL728.SPNN04
GK1107-3A NR U DOL728 SPNN04
MODEL NUMBER STITCH FLAMMABILITY CUSHION FRAME
DETAIL RATING UPHOLSTERY UPHOLSTERY

Please refer to the Ciji product page on www.gunlocke.com for standard finish options.

Seating
02/24

CIJI SINGLE SEAT

Mid Back, with Arms, Wood Legs

model number

fabric grades

dimensions

W

D

H

GK1111-1W

Mid back, with arms,
Wood legs

1 3,843

Overall	31 3/4"	31 1/2"	32 1/8"
Seat	24"	21"	17 1/4"
Arm			26 7/8"
Between arms	24"		

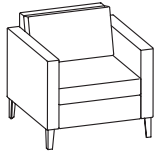

Upholstery Requirements: GK1111-1W

	Dual Upholstery	
Fabric yds	Cushions 1.5	Frame 3.8
Leather ft ²	Cushions 34.5	Frame 87.4
Shipping weight		102 lbs.
Cube		28.0

Cushion

1	10	323	19	742	L1	494
2	30	11	361	20	L2	902
3	59	12	401	21	L3	1,391
COM/4	89	13	449	22	L4	1,799
5	128	14	498	23	L5	2,206
6	167	15	546	24		1,083
7	205	16	596	25		1,181
8	245	17	644	26		1,279
9	284	18	694	27		1,376

To calculate price of lounge with different fabric for cushion and frame; start with Grade 1 price, add appropriate grade price located in second row for cushion, and last add appropriate grade price located in third row for frame to the sum of the Grade 1 and cushion price.

Example: Grade 1 \$3,843 + grade 4 fabric cushion \$89 + grade 2 fabric frame \$75 = \$4,007

Select upholstery for everything else other than the seat and back cushions (the outside back, arms, sides, seat frame). You can specify the same fabric as the cushions or select other fabric.

Frame

1	10	816	19	1,878	L1	1,250
2	75	11	915	20	L2	2,282
3	149	12	1,014	21	L3	3,522
COM/4	223	13	1,138	22	L4	4,555
5	322	14	1,260	23	L5	5,587
6	421	15	1,384	24		2,742
7	520	16	1,507	25		2,990
8	618	17	1,631	26		3,237
9	717	18	1,755	27		3,484

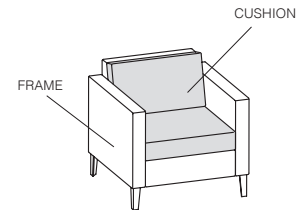

TO ORDER PLEASE SPECIFY THE FOLLOWING:

.

MODEL NUMBER

WOOD FINISH

Cherry finishes on Maple
Walnut finishes on Maple
Maple finishes on Maple
Oak finishes on Maple
Light Rift Oak 301 not available on Maple.

STITCH DETAIL

None NR
Stitch detail
SD +\$197

FLAMMABILITY RATING

U CTB117

CUSHION UPHOLSTERY

Please refer to list of available upholstery and leather selections on www.gunlocke.com

FRAME UPHOLSTERY

Please refer to list of available upholstery and leather selections on www.gunlocke.com

Example

GK1111-1W.777.NR.U.DOL728.SPNO4

GK1111-1W	777	NR	U	DOL728	SPNO4
MODEL NUMBER	WOOD FINISH	STITCH DETAIL	FLAMMABILITY	CUSHION UPHOLSTERY	FRAME UPHOLSTERY

Please refer to the Ciji product page on www.gunlocke.com for standard finish options.

CIJI SINGLE SEAT

Mid Back, with Arms, Aluminum Legs

Seating
02/24

model number	fabric grades	dimensions	W	D	H
--------------	---------------	------------	---	---	---

GK1111-1A
Mid back, with arms,
Aluminum legs

1 4,125

Overall	31 3/4"	31 1/2"	32 1/8"
Seat	24"	21"	17 1/4"
Arm			26 7/8"
Between arms	24"		

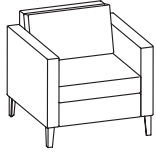

Upholstery Requirements: GK1111-1A

	Dual Upholstery	
Fabric yds	Cushions 1.5	Frame 3.8
Leather ft ²	Cushions 34.5	Frame 87.4
Shipping weight	102 lbs.	
Cube	28.0	

Cushion

1	10	323	19	742	L1	494
2	30	11	361	20	L2	902
3	59	12	401	21	L3	1,391
COM/4	89	13	449	22	L4	1,799
5	128	14	498	23	L5	2,206
6	167	15	546	24		1,083
7	205	16	596	25		1,181
8	245	17	644	26		1,279
9	284	18	694	27		1,376

To calculate price of lounge with different fabric for cushion and frame; start with Grade 1 price, add appropriate grade price located in second row for cushion, and last add appropriate grade price located in third row for frame to the sum of the Grade 1 and cushion price.

Example: Grade 1 \$4,125 + grade 4 fabric cushion \$89 + grade 2 fabric frame \$75 = \$4,289

Select upholstery for everything else other than the seat and back cushions (the outside back, arms, sides, seat frame). You can specify the same fabric as the cushions or select other fabric.

Frame

1	10	816	19	1,878	L1	1,250
2	75	11	915	20	L2	2,282
3	149	12	1,014	21	L3	3,522
COM/4	223	13	1,138	22	L4	4,555
5	322	14	1,260	23	L5	5,587
6	421	15	1,384	24		2,742
7	520	16	1,507	25		2,990
8	618	17	1,631	26		3,237
9	717	18	1,755	27		3,484

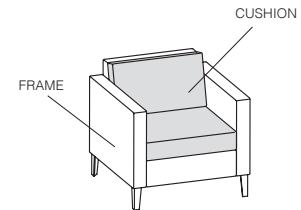

TO ORDER PLEASE SPECIFY THE FOLLOWING:

<input type="text"/>	<input type="text"/>	<input type="text"/>	<input type="text"/>	<input type="text"/>
MODEL NUMBER	STITCH DETAIL	FLAMMABILITY RATING	CUSHION UPHOLSTERY	FRAME UPHOLSTERY
	None NR Stitch detail SD +\$197	U CTB117	Please refer to list of available upholstery and leather selections on www.gunlocke.com	Please refer to list of available upholstery and leather selections on www.gunlocke.com

Example

GK1111-1A.NR.U.DOL728.SPNN04

GK1111-1A	NR	U	DOL728	SPNN04
MODEL NUMBER	STITCH	FLAMMABILITY DETAIL	CUSHION UPHOLSTERY	FRAME UPHOLSTERY

Please refer to the Ciji product page on www.gunlocke.com for standard finish options.

model number	fabric grades	dimensions	W	D	H
GK1113-1W Mid back, armless, Wood Legs	1 2,943	Overall	24 5/8"	31 1/2"	32 1/8"
		Seat	24"	21"	17 1/4"



Upholstery Requirements: GK1113-1W

	Dual Upholstery	
Fabric yds	Cushions 1.5	Frame 1.5
Leather ft ²	Cushions 34.5	Frame 34.5
Shipping weight	82 lbs.	
Cube	28.0	

Cushion	1	10	323	19	742	L1	494	
	2	30	11	361	20	791	L2	902
	3	59	12	401	21	840	L3	1,391
	COM/4	89	13	449	22	888	L4	1,799
	5	128	14	498	23	985	L5	2,206
	6	167	15	546	24	1,083		
	7	205	16	596	25	1,181		
	8	245	17	644	26	1,279		
	9	284	18	694	27	1,376		

To calculate price of lounge with different fabric for cushion and frame; start with Grade 1 price, add appropriate grade price located in second row for cushion, and last add appropriate grade price located in third row for frame to the sum of the Grade 1 and cushion price.

Example: Grade 1 \$2,943 + grade 4 fabric cushion \$89 + grade 2 fabric frame \$30 = \$3,062

Select upholstery for everything else other than the seat and back cushions (the outside back, arms, sides, seat frame). You can specify the same fabric as the cushions or select other fabric.

Frame	1	10	323	19	742	L1	494	
	2	30	11	361	20	791	L2	902
	3	59	12	401	21	840	L3	1,391
	COM/4	89	13	449	22	888	L4	1,799
	5	128	14	498	23	985	L5	2,206
	6	167	15	546	24	1,083		
	7	205	16	596	25	1,181		
	8	245	17	644	26	1,279		
	9	284	18	694	27	1,376		

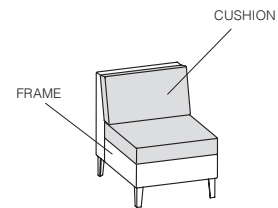

TO ORDER PLEASE SPECIFY THE FOLLOWING:

<input type="text"/>	<input type="text"/>	<input type="text"/>	<input type="text"/>	<input type="text"/>	<input type="text"/>
MODEL NUMBER	WOOD FINISH	STITCH DETAIL	FLAMMABILITY RATING	CUSHION UPHOLSTERY	FRAME UPHOLSTERY
	Cherry finishes on Maple Walnut finishes on Maple Maple finishes on Maple Oak finishes on Maple <i>Light Rift Oak 301 not available on Maple.</i>	None NR Stitch detail SD +\$197	U CTB117	Please refer to list of available upholstery and leather selections on www.gunlocke.com	Please refer to list of available upholstery and leather selections on www.gunlocke.com

Example

GK1113-1W.777.NR.U.DOL728.SPNN04					
GK1113-1W	777	NR	U	DOL728	SPNN04
MODEL NUMBER	WOOD FINISH	STITCH DETAIL	FLAMMABILITY	CUSHION UPHOLSTERY	FRAME UPHOLSTERY

Please refer to the Ciji product page on www.gunlocke.com for standard finish options.

CIJI SINGLE SEAT

Mid Back, Armless, Aluminum Legs

Seating
02/24

model number fabric grades dimensions W D H

GK1113-1A
Mid back, armless,
Aluminum Legs

1 3,229

Overall	24 5/8"	31 1/2"	32 1/8"
Seat	24"	21"	17 1/4"

Upholstery Requirements: GK1113-1A

	Dual Upholstery	
Fabric yds	Cushions 1.5	Frame 1.5
Leather ft ²	Cushions 34.5	Frame 34.5
Shipping weight	82 lbs.	
Cube	28.0	



Cushion

1	10	323	19	742	L1	494
2	30	11	361	20	L2	902
3	59	12	401	21	L3	1,391
COM/4	89	13	449	22	L4	1,799
5	128	14	498	23	L5	2,206
6	167	15	546	24		1,083
7	205	16	596	25		1,181
8	245	17	644	26		1,279
9	284	18	694	27		1,376

To calculate price of lounge with different fabric for cushion and frame; start with Grade 1 price, add appropriate grade price located in second row for cushion, and last add appropriate grade price located in third row for frame to the sum of the Grade 1 and cushion price.

Example: Grade 1 \$3,229 + grade 4 fabric cushion \$89 + grade 2 fabric frame \$30 = \$3,348

Select upholstery for everything else other than the seat and back cushions (the outside back, arms, sides, seat frame). You can specify the same fabric as the cushions or select other fabric.

Frame

1	10	323	19	742	L1	494
2	30	11	361	20	L2	902
3	59	12	401	21	L3	1,391
COM/4	89	13	449	22	L4	1,799
5	128	14	498	23	L5	2,206
6	167	15	546	24		1,083
7	205	16	596	25		1,181
8	245	17	644	26		1,279
9	284	18	694	27		1,376

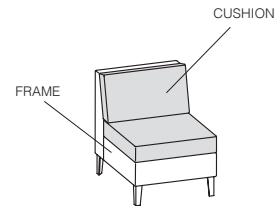

TO ORDER PLEASE SPECIFY THE FOLLOWING:

<input type="text"/>	<input type="text"/>	<input type="text"/>	<input type="text"/>	<input type="text"/>
MODEL NUMBER	STITCH DETAIL	FLAMMABILITY RATING	CUSHION UPHOLSTERY	FRAME UPHOLSTERY
	None NR Stitch detail SD +\$197	U CTB117	Please refer to list of available upholstery and leather selections on www.gunlocke.com	Please refer to list of available upholstery and leather selections on www.gunlocke.com

Example

GK1113-1A.NR.U.DOL728.SPNN04
GK1113-1A NR U DOL728 SPNN04
MODEL NUMBER STITCH FLAMMABILITY CUSHION FRAME
DETAIL RATING UPHOLSTERY UPHOLSTERY

Please refer to the Ciji product page on www.gunlocke.com for standard finish options.

Seating
02/24

CIJI SINGLE SEAT

Mid Back, Arm Left, Wood Legs

model number

fabric grades

dimensions

W

D

H

GK1115-1W

Mid back, arm left,
Wood legs

1 3,619

Overall 28 1/8" 31 1/2" 32 1/8"

Seat 24" 21" 17 1/4"

Arm 26 7/8"

Between arms



Upholstery Requirements: GK1115-1W

	Dual Upholstery	
Fabric yds	Cushions 1.5	Frame 3
Leather ft ²	Cushions 34.5	Frame 57.5
Shipping weight	92 lbs.	
Cube	28.0	

Cushion

1	10	323	19	742	L1	494
2	30	11	361	20	L2	902
3	59	12	401	21	L3	1,391
COM/4	89	13	449	22	L4	1,799
5	128	14	498	23	L5	2,206
6	167	15	546	24		1,083
7	205	16	596	25		1,181
8	245	17	644	26		1,279
9	284	18	694	27		1,376

To calculate price of lounge with different fabric for cushion and frame; start with Grade 1 price, add appropriate grade price located in second row for cushion, and last add appropriate grade price located in third row for frame to the sum of the Grade 1 and cushion price.

Example: Grade 1 \$3,619 + grade 4 fabric cushion \$89 + grade 2 fabric frame \$59 = \$3,767

Select upholstery for everything else other than the seat and back cushions (the outside back, arms, sides, seat frame). You can specify the same fabric as the cushions or select other fabric.

Frame

1	10	644	19	1,483	L1	987
2	59	11	723	20	L2	1,802
3	118	12	801	21	L3	2,780
COM/4	177	13	898	22	L4	3,596
5	255	14	995	23	L5	4,411
6	332	15	1,093	24		2,166
7	410	16	1,190	25		2,361
8	489	17	1,288	26		2,555
9	567	18	1,385	27		2,751

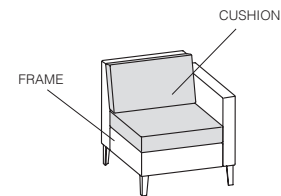

TO ORDER PLEASE SPECIFY THE FOLLOWING:

<input type="text"/>	<input type="text"/>	<input type="text"/>	<input type="text"/>	<input type="text"/>	<input type="text"/>
MODEL NUMBER	WOOD FINISH	STITCH DETAIL	FLAMMABILITY RATING	CUSHION UPHOLSTERY	FRAME UPHOLSTERY
	Cherry finishes on Maple Walnut finishes on Maple Maple finishes on Maple Oak finishes on Maple <i>Light Rift Oak 301 not available on Maple.</i>	None NR Stitch detail SD +\$197	U CTB117	Please refer to list of available upholstery and leather selections on www.gunlocke.com	Please refer to list of available upholstery and leather selections on www.gunlocke.com

Example

GK1115-1W.777.NR.U.DOL728.SPNO4					
GK1115-1W	777	NR	U	DOL728	SPNO4
MODEL NUMBER	WOOD FINISH	STITCH DETAIL	FLAMMABILITY	CUSHION UPHOLSTERY	FRAME UPHOLSTERY

Please refer to the Ciji product page on www.gunlocke.com for standard finish options.

Seating
02/24

CIJI SINGLE SEAT

Mid Back, Arm Right, Wood Legs

model number fabric grades dimensions W D H

GK1117-1W

Mid back, arm right,
Wood legs

1 3,619

Overall	28 1/8"	31 1/2"	32 1/8"
Seat	24"	21"	17 1/4"
Arm			26 7/8"
Between arms			

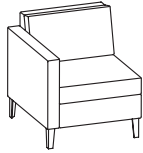

Upholstery Requirements: GK1117-1W

	Dual Upholstery	
Fabric yds	Cushions 1.5	Frame 3
Leather ft ²	Cushions 34.5	Frame 69
Shipping weight		92 lbs.
Cube		28.0

Cushion

1	10	323	19	742	L1	494
2	30	11	361	20	L2	902
3	59	12	401	21	L3	1,391
COM/4	89	13	449	22	L4	1,799
5	128	14	498	23	L5	2,206
6	167	15	546	24		1,083
7	205	16	596	25		1,181
8	245	17	644	26		1,279
9	284	18	694	27		1,376

To calculate price of lounge with different fabric for cushion and frame; start with Grade 1 price, add appropriate grade price located in second row for cushion, and last add appropriate grade price located in third row for frame to the sum of the Grade 1 and cushion price.

Example: Grade 1 \$3,619 + grade 4 fabric cushion \$89 + grade 2 fabric frame \$59 = \$3,767

Select upholstery for everything else other than the seat and back cushions (the outside back, arms, sides, seat frame). You can specify the same fabric as the cushions or select other fabric.

Frame

1	10	644	19	1,483	L1	987
2	59	11	723	20	L2	1,802
3	118	12	801	21	L3	2,780
COM/4	177	13	898	22	L4	3,596
5	255	14	995	23	L5	4,411
6	332	15	1,093	24		2,166
7	410	16	1,190	25		2,361
8	489	17	1,288	26		2,555
9	567	18	1,385	27		2,751

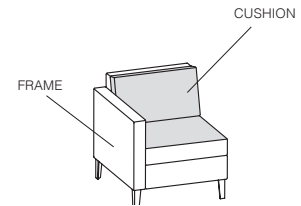

TO ORDER PLEASE SPECIFY THE FOLLOWING:

<input type="text"/>	<input type="text"/>	<input type="text"/>	<input type="text"/>	<input type="text"/>	<input type="text"/>
MODEL NUMBER	WOOD FINISH	STITCH DETAIL	FLAMMABILITY RATING	CUSHION UPHOLSTERY	FRAME UPHOLSTERY
	Cherry finishes on Maple Walnut finishes on Maple Maple finishes on Maple Oak finishes on Maple <i>Light Rift Oak 301 not available on Maple.</i>	None NR Stitch detail SD +\$197	U CTB117	Please refer to list of available upholstery and leather selections on www.gunlocke.com	Please refer to list of available upholstery and leather selections on www.gunlocke.com

Example

GK1117-1W.777.NR.U.DOL728.SPNO4
 GK1117-1W 777 NR U DOL728 SPNO4
 MODEL NUMBER WOOD FINISH STITCH DETAIL FLAMMABILITY CUSHION UPHOLSTERY FRAME UPHOLSTERY

Please refer to the Ciji product page on www.gunlocke.com for standard finish options.

CIJI SINGLE SEAT

Mid Back, Arm Left, Aluminum Legs

Seating
02/24

model number	fabric grades	dimensions	W	D	H
--------------	---------------	------------	---	---	---

GK1117-1A
Mid back, arm left,
Aluminum legs

1 3,903

Overall	28 1/8"	31 1/2"	32 1/8"
Seat	24"	21"	17 1/4"
Arm			26 7/8"
Between arms			



Upholstery Requirements: GK1117-1A

	Dual Upholstery	
Fabric yds	Cushions 1.5	Frame 3
Leather ft ²	Cushions 34.5	Frame 57.5
Shipping weight	92 lbs.	
Cube	28.0	

Cushion

1	10	323	19	742	L1	494
2	30	11	361	20	L2	902
3	59	12	401	21	L3	1,391
COM/4	89	13	449	22	L4	1,799
5	128	14	498	23	L5	2,206
6	167	15	546	24		
7	205	16	596	25		
8	245	17	644	26		
9	284	18	694	27		

To calculate price of lounge with different fabric for cushion and frame; start with Grade 1 price, add appropriate grade price located in second row for cushion, and last add appropriate grade price located in third row for frame to the sum of the Grade 1 and cushion price.

Example: Grade 1 \$3,903 + grade 4 fabric cushion \$89 + grade 2 fabric frame \$59 = \$4,051

Frame

1	10	644	19	1,483	L1	987
2	59	11	723	20	L2	1,802
3	118	12	801	21	L3	2,780
COM/4	177	13	898	22	L4	3,596
5	255	14	995	23	L5	4,411
6	332	15	1,093	24		
7	410	16	1,190	25		
8	489	17	1,288	26		
9	567	18	1,385	27		

Select upholstery for everything else other than the seat and back cushions (the outside back, arms, sides, seat frame). You can specify the same fabric as the cushions or select other fabric.

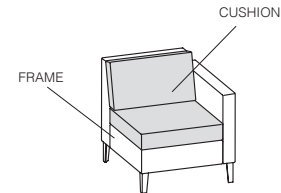

TO ORDER PLEASE SPECIFY THE FOLLOWING:

<input type="text"/>	<input type="text"/>	<input type="text"/>	<input type="text"/>	<input type="text"/>
MODEL NUMBER	STITCH DETAIL	FLAMMABILITY RATING	CUSHION UPHOLSTERY	FRAME UPHOLSTERY
	None NR Stitch detail SD +\$197	U CTB117	Please refer to list of available upholstery and leather selections on www.gunlocke.com	Please refer to list of available upholstery and leather selections on www.gunlocke.com

Example

GK1117-1A.NR.U.DOL728.SPNN04

GK1117-1A	NR	U	DOL728	SPNN04
MODEL NUMBER	STITCH	FLAMMABILITY DETAIL	CUSHION UPHOLSTERY	FRAME UPHOLSTERY

Please refer to the Ciji product page on www.gunlocke.com for standard finish options.

model number fabric grades
GK1111-2W 1 5,384

Mid back, with arms,
Wood legs

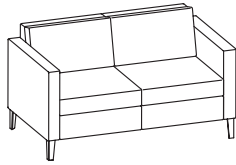

dimensions	W	D	H
Overall	56 1/4"	31 1/2"	32 1/8"
Seat	48 1/2"	21"	17 1/4"
Arm			26 7/8"
Between arms	48 1/2"		

Upholstery Requirements: GK1111-2W

	Dual Upholstery
Fabric yds	Cushions 2.9 Frame 5.3
Leather ft ²	Cushions 66.7 Frame 121.9
Shipping weight	127 lbs.
Cube	35

Cushion

1	10	623	19	1,433	L1	954	
2	57	11	698	20	1,528	L2	1,742
3	115	12	773	21	1,622	L3	2,688
COM/4	170	13	868	22	1,716	L4	3,476
5	246	14	963	23	1,905	L5	4,264
6	321	15	1,056	24	2,093		
7	397	16	1,151	25	2,282		
8	472	17	1,245	26	2,469		
9	547	18	1,339	27	2,659		

To calculate price of lounge with different fabric for cushion and frame; start with Grade 1 price, add appropriate grade price located in second row for cushion, and last add appropriate grade price located in third row for frame to the sum of the Grade 1 and cushion price.

Example: Grade 1 \$5,384 + grade 4 fabric cushion \$170 + grade 2 fabric frame \$105 = \$5,659

Select upholstery for everything else other than the seat and back cushions (the outside back, arms, sides, seat frame). You can specify the same fabric as the cushions or select other fabric.

Frame

1	10	1,139	19	2,619	L1	1,742	
2	105	11	1,276	20	2,791	L2	3,183
3	208	12	1,414	21	2,964	L3	4,912
COM/4	311	13	1,585	22	3,136	L4	6,353
5	449	14	1,758	23	3,480	L5	7,792
6	587	15	1,930	24	3,825		
7	724	16	2,103	25	4,170		
8	863	17	2,275	26	4,514		
9	1,001	18	2,448	27	4,858		

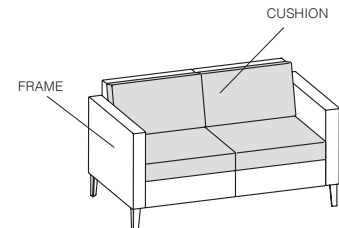

TO ORDER PLEASE SPECIFY THE FOLLOWING:

<input type="text"/>	<input type="text"/>	<input type="text"/>	<input type="text"/>	<input type="text"/>	<input type="text"/>
MODEL NUMBER	WOOD FINISH	STITCH DETAIL	FLAMMABILITY RATING	CUSHION UPHOLSTERY	FRAME UPHOLSTERY

Cherry finishes on Maple
Walnut finishes on Maple
Maple finishes on Maple
Oak finishes on Maple
Light Rift Oak 301 not available on Maple.

None NR
Stitch detail
SD +\$197

U CTB117

Please refer to list of available upholstery and leather selections on www.gunlocke.com

Please refer to list of available upholstery and leather selections on www.gunlocke.com

Example

GK1111-2W.777.NR.U.DOL728.SPNO4
GK1111-2W 777 NR U DOL728 SPNO4
MODEL NUMBER WOOD FINISH STITCH DETAIL FLAMMABILITY UPHOLSTERY CUSHION UPHOLSTERY FRAME REQUEST

Please refer to the Ciji product page on www.gunlocke.com for standard finish options.

model number	fabric grades	dimensions	W	D	H
--------------	---------------	------------	---	---	---

GK1113-2W

Mid back, armless,
Wood Legs

1 4,444

Overall	49 1/8"	31 1/2"	32 1/8"
Seat	48 1/2"	21"	17 1/4"

Upholstery Requirements: GK1113-2W

	Dual Upholstery	
Fabric yds	Cushions 2.9	Frame 2.5
Leather ft ²	Cushions 66.7	Frame 57.5
Shipping weight	107 lbs.	
Cube	35	

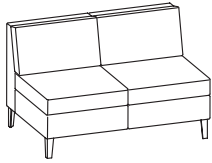

Cushion

1	10	623	19	1,433	L1	954	
2	57	11	698	20	1,528	L2	1,742
3	115	12	773	21	1,622	L3	2,688
COM/4	170	13	868	22	1,716	L4	3,476
5	246	14	963	23	1,905	L5	4,264
6	321	15	1,056	24	2,093		
7	397	16	1,151	25	2,282		
8	472	17	1,245	26	2,469		
9	547	18	1,339	27	2,659		

To calculate price of lounge with different fabric for cushion and frame; start with Grade 1 price, add appropriate grade price located in second row for cushion, and last add appropriate grade price located in third row for frame to the sum of the Grade 1 and cushion price.

Example: Grade 1 \$4,444 + grade 4 fabric cushion \$170 + grade 2 fabric frame \$49 = \$4,663

Select upholstery for everything else other than the seat and back cushions (the outside back, arms, sides, seat frame). You can specify the same fabric as the cushions or select other fabric.

Frame

1	10	538	19	1,235	L1	822	
2	49	11	603	20	1,317	L2	1,502
3	98	12	667	21	1,399	L3	2,317
COM/4	147	13	748	22	1,480	L4	2,997
5	212	14	830	23	1,642	L5	3,677
6	278	15	911	24	1,805		
7	342	16	992	25	1,967		
8	407	17	1,073	26	2,130		
9	472	18	1,155	27	2,292		

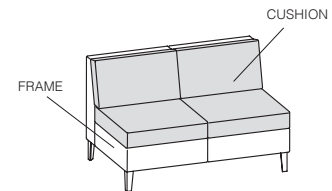

TO ORDER PLEASE SPECIFY THE FOLLOWING:

.

MODEL NUMBER

WOOD FINISH

STITCH DETAIL

FLAMMABILITY RATING

CUSHION UPHOLSTERY

FRAME UPHOLSTERY

Cherry finishes on Maple
Walnut finishes on Maple
Maple finishes on Maple
Oak finishes on Maple
Light Rift Oak 301 not available on Maple.

None NR
Stitch detail
SD +\$197

U CTB117

Please refer to list of available upholstery and leather selections on www.gunlocke.com

Please refer to list of available upholstery and leather selections on www.gunlocke.com

Example

GK1113-2W.777.NR.U.DOL728.SPNO4

GK1113-2W	777	NR	U	DOL728	SPNO4
MODEL NUMBER	WOOD FINISH	STITCH DETAIL	FLAMMABILITY UPHOLSTERY	CUSHION UPHOLSTERY	FRAME REQUEST

Please refer to the Ciji product page on www.gunlocke.com for standard finish options.

CIJI TWO SEAT

Mid Back, Armless, Aluminum Legs

Seating
02/24

model number	fabric grades	dimensions	W	D	H
GK1113-2A	1 4,727	Overall	49 1/8"	31 1/2"	32 1/8"
Mid back, armless, Aluminum Legs		Seat	48 1/2"	21"	17 1/4"

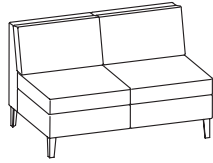

Upholstery Requirements: GK1113-2A

Dual Upholstery	
Fabric yds	Cushions 2.9 Frame 2.5
Leather ft ²	Cushions 66.7 Frame 57.5
Shipping weight	107 lbs.
Cube	35

Cushion	1	10	623	19	1,433	L1	954
	2	57	11	698	20	L2	1,742
	3	115	12	773	21	L3	2,688
	COM/4	170	13	868	22	L4	3,476
	5	246	14	963	23	L5	4,264
	6	321	15	1,056	24		
	7	397	16	1,151	25		
	8	472	17	1,245	26		
	9	547	18	1,339	27		

To calculate price of lounge with different fabric for cushion and frame; start with Grade 1 price, add appropriate grade price located in second row for cushion, and last add appropriate grade price located in third row for frame to the sum of the Grade 1 and cushion price.

Example: Grade 1 \$4,727 + grade 4 fabric cushion \$170 + grade 2 fabric frame \$49 = \$4,946

Frame	1	10	538	19	1,235	L1	822
	2	49	11	603	20	L2	1,502
	3	98	12	667	21	L3	2,317
	COM/4	147	13	748	22	L4	2,997
	5	212	14	830	23	L5	3,677
	6	278	15	911	24		
	7	342	16	992	25		
	8	407	17	1,073	26		
	9	472	18	1,155	27		

Select upholstery for everything else other than the seat and back cushions (the outside back, arms, sides, seat frame). You can specify the same fabric as the cushions or select other fabric.

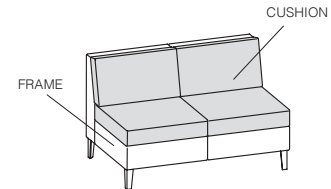

TO ORDER PLEASE SPECIFY THE FOLLOWING:

<input type="text"/>	<input type="text"/>	<input type="text"/>	<input type="text"/>	<input type="text"/>
MODEL NUMBER	STITCH DETAIL	FLAMMABILITY RATING	CUSHION UPHOLSTERY	FRAME UPHOLSTERY
	None NR Stitch detail SD +\$197	U CTB117	Please refer to list of available upholstery and leather selections on www.gunlocke.com	Please refer to list of available upholstery and leather selections on www.gunlocke.com

Example

GK1113-2A.NR.U.DOL728.SPNN04				
GK1113-2A	NR	U	DOL728	SPNN04
MODEL NUMBER	STITCH	FLAMMABILITY DETAIL	CUSHION UPHOLSTERY	FRAME UPHOLSTERY

Please refer to the Ciji product page on www.gunlocke.com for standard finish options.

model number	fabric grades
GK1115-2W	1 5,162

Mid back, arm left,
Wood Legs

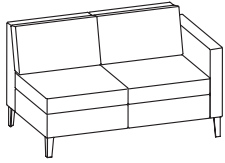

dimensions	W	D	H
Overall	52 5/8"	31 1/2"	32 1/8"
Seat	48 1/2"	21"	17 1/4"
Arm			26 7/8"
Between arms			

Upholstery Requirements: GK1115-2W

	Dual Upholstery	
Fabric yds	Cushions 2.9	Frame 3.8
Leather ft ²	Cushions 66.7	Frame 87.4
Shipping weight		117 lbs.
Cube		35

Cushion

1	10	623	19	1,433	L1	954	
2	57	11	698	20	1,528	L2	1,742
3	115	12	773	21	1,622	L3	2,688
COM/4	170	13	868	22	1,716	L4	3,476
5	246	14	963	23	1,905	L5	4,264
6	321	15	1,056	24	2,093		
7	397	16	1,151	25	2,282		
8	472	17	1,245	26	2,469		
9	547	18	1,339	27	2,659		

To calculate price of lounge with different fabric for cushion and frame; start with Grade 1 price, add appropriate grade price located in second row for cushion, and last add appropriate grade price located in third row for frame to the sum of the Grade 1 and cushion price.

Example: Grade 1 \$5,162 + grade 4 fabric cushion \$170 + grade 2 fabric frame \$75 = \$5,407

Select upholstery for everything else other than the seat and back cushions (the outside back, arms, sides, seat frame). You can specify the same fabric as the cushions or select other fabric.

Frame

1	10	816	19	1,878	L1	1,250	
2	75	11	915	20	2,002	L2	2,282
3	149	12	1,014	21	2,125	L3	3,522
COM/4	223	13	1,138	22	2,249	L4	4,555
5	322	14	1,260	23	2,495	L5	5,587
6	421	15	1,384	24	2,742		
7	520	16	1,507	25	2,990		
8	618	17	1,631	26	3,237		
9	717	18	1,755	27	3,484		

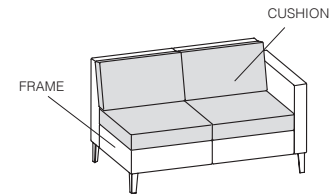

TO ORDER PLEASE SPECIFY THE FOLLOWING:

--	--	--	--	--	--

MODEL NUMBER	WOOD FINISH	STITCH DETAIL	FLAMMABILITY RATING	CUSHION UPHOLSTERY	FRAME UPHOLSTERY
---------------------	--------------------	----------------------	----------------------------	---------------------------	-------------------------

Cherry finishes on Maple
Walnut finishes on Maple
Maple finishes on Maple
Oak finishes on Maple
Light Rift Oak 301 not available on Maple.

None NR
Stitch detail
SD +\$197

U CTB117

Please refer to list of available upholstery and leather selections on www.gunlocke.com

Please refer to list of available upholstery and leather selections on www.gunlocke.com

Example

GK1115-2W.777.NR.U.DOL728.SPNN04					
GK1115-2W	777	NR	U	DOL728	SPNN04
MODEL NUMBER	WOOD FINISH	STITCH DETAIL	FLAMMABILITY UPHOLSTERY	CUSHION UPHOLSTERY	FRAME REQUEST

Please refer to the Ciji product page on www.gunlocke.com for standard finish options.

CIJI TWO SEAT

Mid Back, Arm Left, Aluminum Legs

Seating
02/24

model number	fabric grades	dimensions	W	D	H
--------------	---------------	------------	---	---	---

GK1115-2A
Mid back, arm left,
Aluminum Legs

1 5,447

Overall	52 5/8"	31 1/2"	32 1/8"
Seat	48 1/2"	21"	17 1/4"
Arm			26 7/8"
Between arms			

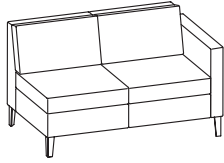

Upholstery Requirements: GK1115-2A

	Dual Upholstery	
Fabric yds	Cushions 2.9	Frame 3.8
Leather ft ²	Cushions 66.7	Frame 87.4
Shipping weight		117 lbs.
Cube		35

Cushion

1	10	623	19	1,433	L1	954	
2	57	11	698	20	1,528	L2	1,742
3	115	12	773	21	1,622	L3	2,688
COM/4	170	13	868	22	1,716	L4	3,476
5	246	14	963	23	1,905	L5	4,264
6	321	15	1,056	24	2,093		
7	397	16	1,151	25	2,282		
8	472	17	1,245	26	2,469		
9	547	18	1,339	27	2,659		

To calculate price of lounge with different fabric for cushion and frame; start with Grade 1 price, add appropriate grade price located in second row for cushion, and last add appropriate grade price located in third row for frame to the sum of the Grade 1 and cushion price.

Example: Grade 1 \$5,447 + grade 4 fabric cushion \$170 + grade 2 fabric frame \$75 = \$5,692

Select upholstery for everything else other than the seat and back cushions (the outside back, arms, sides, seat frame). You can specify the same fabric as the cushions or select other fabric.

Frame

1	10	816	19	1,878	L1	1,250	
2	75	11	915	20	2,002	L2	2,282
3	149	12	1,014	21	2,125	L3	3,522
COM/4	223	13	1,138	22	2,249	L4	4,555
5	322	14	1,260	23	2,495	L5	5,587
6	421	15	1,384	24	2,742		
7	520	16	1,507	25	2,990		
8	618	17	1,631	26	3,237		
9	717	18	1,755	27	3,484		

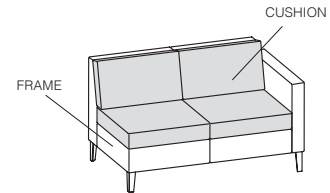

TO ORDER PLEASE SPECIFY THE FOLLOWING:

<input type="text"/>	<input type="text"/>	<input type="text"/>	<input type="text"/>	<input type="text"/>
MODEL NUMBER	STITCH DETAIL	FLAMMABILITY RATING	CUSHION UPHOLSTERY	FRAME UPHOLSTERY
	None NR Stitch detail SD +\$197	U CTB117	Please refer to list of available upholstery and leather selections on www.gunlocke.com	Please refer to list of available upholstery and leather selections on www.gunlocke.com

Example

GK1115-2A.NR.U.DOL728.SPNN04				
GK1115-2A	NR	U	DOL728	SPNN04
MODEL NUMBER	STITCH	FLAMMABILITY DETAIL	CUSHION UPHOLSTERY	FRAME UPHOLSTERY

Please refer to the Ciji product page on www.gunlocke.com for standard finish options.

model number	fabric grades
GK1117-2W	1 5,162

Mid back, arm right,
Wood Legs

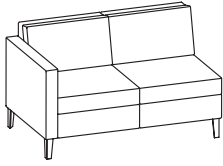

dimensions	W	D	H
Overall	52 5/8"	31 1/2"	32 1/8"
Seat	48 1/2"	21"	17 1/4"
Arm			26 7/8"
Between arms			

Upholstery Requirements: GK1117-2W

	Dual Upholstery	
Fabric yds	Cushions 2.9	Frame 3.8
Leather ft ²	Cushions 66.7	Frame 87.4
Shipping weight		117 lbs.
Cube		35

Cushion

1	10	623	19	1,433	L1	954	
2	57	11	698	20	1,528	L2	1,742
3	115	12	773	21	1,622	L3	2,688
COM/4	170	13	868	22	1,716	L4	3,476
5	246	14	963	23	1,905	L5	4,264
6	321	15	1,056	24	2,093		
7	397	16	1,151	25	2,282		
8	472	17	1,245	26	2,469		
9	547	18	1,339	27	2,659		

To calculate price of lounge with different fabric for cushion and frame; start with Grade 1 price, add appropriate grade price located in second row for cushion, and last add appropriate grade price located in third row for frame to the sum of the Grade 1 and cushion price.

Example: Grade 1 \$5,162 + grade 4 fabric cushion \$170 + grade 2 fabric frame \$75 = \$5,407

Select upholstery for everything else other than the seat and back cushions (the outside back, arms, sides, seat frame). You can specify the same fabric as the cushions or select other fabric.

Frame

1	10	816	19	1,878	L1	1,250	
2	75	11	915	20	2,002	L2	2,282
3	149	12	1,014	21	2,125	L3	3,522
COM/4	223	13	1,138	22	2,249	L4	4,555
5	322	14	1,260	23	2,495	L5	5,587
6	421	15	1,384	24	2,742		
7	520	16	1,507	25	2,990		
8	618	17	1,631	26	3,237		
9	717	18	1,755	27	3,484		

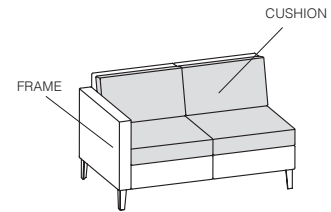

TO ORDER PLEASE SPECIFY THE FOLLOWING:

--	--	--	--	--	--

MODEL NUMBER	WOOD FINISH	STITCH DETAIL	FLAMMABILITY RATING	CUSHION UPHOLSTERY	FRAME UPHOLSTERY
	Cherry finishes on Maple Walnut finishes on Maple Maple finishes on Maple Oak finishes on Maple <i>Light Rift Oak 301 not available on Maple.</i>	None NR Stitch detail SD +\$197	U CTB117	Please refer to list of available upholstery and leather selections on www.gunlocke.com	Please refer to list of available upholstery and leather selections on www.gunlocke.com

Example

GK1117-2W.777.NR.U.DOL728.SPNO4					
GK1117-2W	777	NR	U	DOL728	SPNO4
MODEL NUMBER	WOOD FINISH	STITCH DETAIL	FLAMMABILITY UPHOLSTERY	CUSHION UPHOLSTERY	FRAME REQUEST

Please refer to the Ciji product page on www.gunlocke.com for standard finish options.

CIJI TWO SEAT

Mid Back, Arm Right, Aluminum Legs

Seating
02/24

model number	fabric grades	dimensions	W	D	H
--------------	---------------	------------	---	---	---

GK1117-2A
Mid back, arm right,
Aluminum Legs

1 5,447

Overall	52 5/8"	31 1/2"	32 1/8"
Seat	48 1/2"	21"	17 1/4"
Arm			26 7/8"
Between arms			

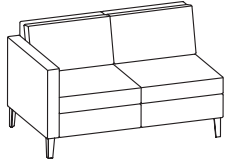

Upholstery Requirements: GK1117-2A

	Dual Upholstery	
Fabric yds	Cushions 2.9	Frame 3.8
Leather ft ²	Cushions 66.7	Frame 87.4
Shipping weight		117 lbs.
Cube		35

Cushion

1	10	623	19	1,433	L1	954	
2	57	11	698	20	1,528	L2	1,742
3	115	12	773	21	1,622	L3	2,688
COM/4	170	13	868	22	1,716	L4	3,476
5	246	14	963	23	1,905	L5	4,264
6	321	15	1,056	24	2,093		
7	397	16	1,151	25	2,282		
8	472	17	1,245	26	2,469		
9	547	18	1,339	27	2,659		

To calculate price of lounge with different fabric for cushion and frame; start with Grade 1 price, add appropriate grade price located in second row for cushion, and last add appropriate grade price located in third row for frame to the sum of the Grade 1 and cushion price.

Example: Grade 1 \$5,447 + grade 4 fabric cushion \$170 + grade 2 fabric frame \$75 = \$5,692

Select upholstery for everything else other than the seat and back cushions (the outside back, arms, sides, seat frame). You can specify the same fabric as the cushions or select other fabric.

Frame

1	10	816	19	1,878	L1	1,250	
2	75	11	915	20	2,002	L2	2,282
3	149	12	1,014	21	2,125	L3	3,522
COM/4	223	13	1,138	22	2,249	L4	4,555
5	322	14	1,260	23	2,495	L5	5,587
6	421	15	1,384	24	2,742		
7	520	16	1,507	25	2,990		
8	618	17	1,631	26	3,237		
9	717	18	1,755	27	3,484		

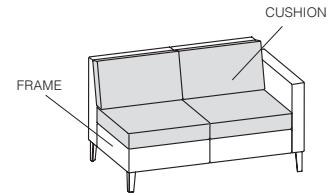

TO ORDER PLEASE SPECIFY THE FOLLOWING:

<input type="text"/>	<input type="text"/>	<input type="text"/>	<input type="text"/>	<input type="text"/>
MODEL NUMBER	STITCH DETAIL	FLAMMABILITY RATING	CUSHION UPHOLSTERY	FRAME UPHOLSTERY
	None NR Stitch detail SD +\$197	U CTB117	Please refer to list of available upholstery and leather selections on www.gunlocke.com	Please refer to list of available upholstery and leather selections on www.gunlocke.com

Example

GK1117-2A.NR.U.DOL728.SPNN04

GK1117-2A	NR	U	DOL728	SPNN04
MODEL NUMBER	STITCH	FLAMMABILITY DETAIL	CUSHION UPHOLSTERY	FRAME UPHOLSTERY

Please refer to the Ciji product page on www.gunlocke.com for standard finish options.

Seating
02/24

CIJI THREE SEAT

Mid Back, with Arms, Wood Legs

model number fabric grades
GK1111-3W **1** 6,855

Mid back, with arms.
Wood legs

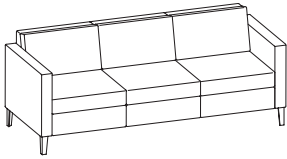

dimensions	W	D	H
Overall	80 3/4"	31 1/2"	32 1/8"
Seat	73"	21"	17 1/4"
Arm			26 7/8"
Between arms	73"		

Upholstery Requirements: GK1111-3W

	Dual Upholstery	
Fabric yds	Cushions 4.4	Frame 5.9
Leather ft ²	Cushions 101.2	Frame 135.7
Shipping weight		188 lbs.
Cube		78.5

Cushion

1	10	945	19	2,175	L1	1,447
2	86	11	1,059	20	L2	2,642
3	173	12	1,173	21	L3	4,077
COM/4	258	13	1,317	22	L4	5,273
5	372	14	1,459	23	L5	6,470
6	487	15	1,603	24		
7	602	16	1,745	25		
8	716	17	1,888	26		
9	831	18	2,032	27		

To calculate price of lounge with different fabric for cushion and frame; start with Grade 1 price, add appropriate grade price located in second row for cushion, and last add appropriate grade price located in third row for frame to the sum of the Grade 1 and cushion price.

Example: Grade 1 \$6,855 + grade 4 fabric cushion \$258 + grade 2 fabric frame \$116 = \$7,229

Select upholstery for everything else other than the seat and back cushions (the outside back, arms, sides, seat frame). You can specify the same fabric as the cushions or select other fabric.

Frame

1	10	1,266	19	2,915	L1	1,940
2	116	11	1,420	20	L2	3,543
3	231	12	1,572	21	L3	5,468
COM/4	346	13	1,765	22	L4	7,070
5	499	14	1,956	23	L5	8,675
6	654	15	2,149	24		
7	806	16	2,341	25		
8	959	17	2,531	26		
9	1,114	18	2,724	27		

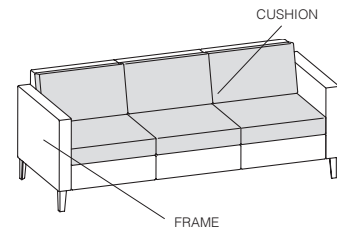

TO ORDER PLEASE SPECIFY THE FOLLOWING:

<input type="text"/>	<input type="text"/>	<input type="text"/>	<input type="text"/>	<input type="text"/>	<input type="text"/>
MODEL NUMBER	WOOD FINISH	STITCH DETAIL	FLAMMABILITY RATING	CUSHION UPHOLSTERY	FRAME UPHOLSTERY
	Cherry finishes on Maple Walnut finishes on Maple Maple finishes on Maple Oak finishes on Maple <i>Light Rift Oak 301 not available on Maple.</i>	None NR Stitch detail SD +\$197	U CTB117	Please refer to list of available upholstery and leather selections on www.gunlocke.com	Please refer to list of available upholstery and leather selections on www.gunlocke.com

Example

GK1111-3W.777.NR.U.DOL728.SPNN04
 GK1111-3W 777 NR U DOL728 SPNN04
 MODEL NUMBER WOOD FINISH STITCH DETAIL FLAMMABILITY UPHOLSTERY CUSHION UPHOLSTERY FRAME REQUEST

Please refer to the Ciji product page on www.gunlocke.com for standard finish options.

CIJI THREE SEAT

Mid Back, with Arms, Aluminum Legs

Seating
02/24

model number fabric grades dimensions W D H

GK1111-3A
Mid back, with arms,
Aluminum legs

1 7,141

Overall	80 3/4"	31 1/2"	32 1/8"
Seat	73"	21"	17 1/4"
Arm			26 7/8"
Between arms	73"		

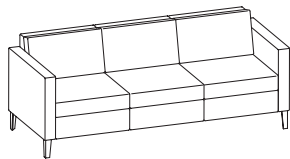

Upholstery Requirements: GK1111-3A

	Dual Upholstery	
Fabric yds	Cushions 4.4	Frame 5.9
Leather ft ²	Cushions 101.2	Frame 135.7
Shipping weight		188 lbs.
Cube		78.5

Cushion

1	10	945	19	2,175	L1	1,447
2	86	11	1,059	20	L2	2,642
3	173	12	1,173	21	L3	4,077
COM/4	258	13	1,317	22	L4	5,273
5	372	14	1,459	23	L5	6,470
6	487	15	1,603	24		
7	602	16	1,745	25		
8	716	17	1,888	26		
9	831	18	2,032	27		

To calculate price of lounge with different fabric for cushion and frame; start with Grade 1 price, add appropriate grade price located in second row for cushion, and last add appropriate grade price located in third row for frame to the sum of the Grade 1 and cushion price.

Example: Grade 1 \$7,141 + grade 4 fabric cushion \$258 + grade 2 fabric frame \$116 = \$7,515

Select upholstery for everything else other than the seat and back cushions (the outside back, arms, sides, seat frame). You can specify the same fabric as the cushions or select other fabric.

Frame

1	10	1,266	19	2,915	L1	1,940
2	116	11	1,420	20	L2	3,543
3	231	12	1,572	21	L3	5,468
COM/4	346	13	1,765	22	L4	7,070
5	499	14	1,956	23	L5	8,675
6	654	15	2,149	24		
7	806	16	2,341	25		
8	959	17	2,531	26		
9	1,114	18	2,724	27		

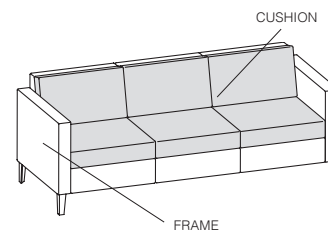

TO ORDER PLEASE SPECIFY THE FOLLOWING:

<input type="text"/>	<input type="text"/>	<input type="text"/>	<input type="text"/>	<input type="text"/>
MODEL NUMBER	STITCH DETAIL	FLAMMABILITY RATING	CUSHION UPHOLSTERY	FRAME UPHOLSTERY
	None NR Stitch detail SD +\$197	U CTB117	Please refer to list of available upholstery and leather selections on www.gunlocke.com	Please refer to list of available upholstery and leather selections on www.gunlocke.com

Example

GK1111-3A.NR.U.DOL728.SPNN04
GK1111-3A NR U DOL728 SPNN04
MODEL NUMBER STITCH FLAMMABILITY CUSHION FRAME
DETAIL RATING UPHOLSTERY UPHOLSTERY

Please refer to the Ciji product page on www.gunlocke.com for standard finish options.

model number fabric grades dimensions W D H

GK1113-3W

Mid back, armless,
Wood Legs

1 5,717

Overall	73 5/8"	31 1/2"	32 1/8"
Seat	73"	21"	17 1/4"

Upholstery Requirements: GK1113-3W

	Dual Upholstery	
Fabric yds	Cushions 4.4	Frame 3.3
Leather ft ²	Cushions 101.2	Frame 75.9
Shipping weight	168 lbs.	
Cube	78.5	

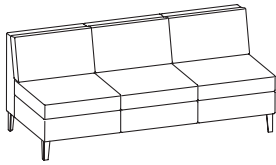

Cushion

1	10	945	19	2,175	L1	1,447
2	86	11	1,059	20	L2	2,642
3	173	12	1,173	21	L3	4,077
COM/4	258	13	1,317	22	L4	5,273
5	372	14	1,459	23	L5	6,470
6	487	15	1,603	24		
7	602	16	1,745	25		
8	716	17	1,888	26		
9	831	18	2,032	27		

To calculate price of lounge with different fabric for cushion and frame; start with Grade 1 price, add appropriate grade price located in second row for cushion, and last add appropriate grade price located in third row for frame to the sum of the Grade 1 and cushion price.

Example: Grade 1 \$5,717 + grade 4 fabric cushion \$258 + grade 2 fabric frame \$65 = \$6,040

Select upholstery for everything else other than the seat and back cushions (the outside back, arms, sides, seat frame). You can specify the same fabric as the cushions or select other fabric.

Frame

1	10	708	19	1,631	L1	1,085
2	65	11	795	20	L2	1,982
3	130	12	880	21	L3	3,059
COM/4	194	13	988	22	L4	3,955
5	280	14	1,094	23	L5	4,852
6	366	15	1,203	24		
7	452	16	1,309	25		
8	538	17	1,417	26		
9	623	18	1,524	27		

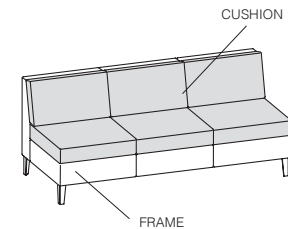

TO ORDER PLEASE SPECIFY THE FOLLOWING:

.

MODEL NUMBER	WOOD FINISH	STITCH DETAIL	FLAMMABILITY RATING	CUSHION UPHOLSTERY	FRAME UPHOLSTERY
	Cherry finishes on Maple Walnut finishes on Maple Maple finishes on Maple Oak finishes on Maple <i>Light Rift Oak 301 not available on Maple.</i>	None NR Stitch detail SD +\$197	U CTB117	Please refer to list of available upholstery and leather selections on www.gunlocke.com	Please refer to list of available upholstery and leather selections on www.gunlocke.com

Example

GK1113-3W.777.NR.U.DOL728.SPNO4

GK1113-3W	777	NR	U	DOL728	SPNO4
MODEL NUMBER	WOOD FINISH	STITCH DETAIL	FLAMMABILITY UPHOLSTERY	CUSHION UPHOLSTERY	FRAME REQUEST

Please refer to the Ciji product page on www.gunlocke.com for standard finish options.

CIJI THREE SEAT

Mid Back, Armless, Aluminum Legs

Seating
02/24

model number	fabric grades	dimensions	W	D	H
GK1113-3A	1 6,001	Overall	73 5/8"	31 1/2"	32 1/8"
Mid back, armless, Aluminum Legs		Seat	73"	21"	17 1/4"

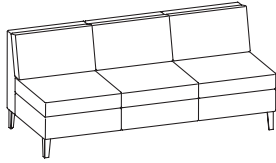

Upholstery Requirements: GK1113-3A

	Dual Upholstery	
Fabric yds	Cushions 4.4	Frame 3.3
Leather ft ²	Cushions 101.2	Frame 75.9
Shipping weight	168 lbs.	
Cube	78.5	

Cushion	1	10	945	19	2,175	L1	1,447	
	2	86	11	1,059	20	2,317	L2	2,642
	3	173	12	1,173	21	2,461	L3	4,077
	COM/4	258	13	1,317	22	2,603	L4	5,273
	5	372	14	1,459	23	2,890	L5	6,470
	6	487	15	1,603	24	3,176		
	7	602	16	1,745	25	3,461		
	8	716	17	1,888	26	3,748		
	9	831	18	2,032	27	4,034		

To calculate price of lounge with different fabric for cushion and frame; start with Grade 1 price, add appropriate grade price located in second row for cushion, and last add appropriate grade price located in third row for frame to the sum of the Grade 1 and cushion price.

Example: Grade 1 \$6,001 + grade 4 fabric cushion \$258 + grade 2 fabric frame \$65 = \$6,324

Select upholstery for everything else other than the seat and back cushions (the outside back, arms, sides, seat frame). You can specify the same fabric as the cushions or select other fabric.

Frame	1	10	708	19	1,631	L1	1,085	
	2	65	11	795	20	1,739	L2	1,982
	3	130	12	880	21	1,845	L3	3,059
	COM/4	194	13	988	22	1,953	L4	3,955
	5	280	14	1,094	23	2,168	L5	4,852
	6	366	15	1,203	24	2,382		
	7	452	16	1,309	25	2,597		
	8	538	17	1,417	26	2,811		
	9	623	18	1,524	27	3,026		

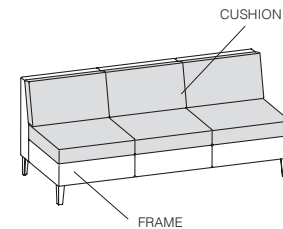

TO ORDER PLEASE SPECIFY THE FOLLOWING:

<input type="text"/>	<input type="text"/>	<input type="text"/>	<input type="text"/>	<input type="text"/>
MODEL NUMBER	STITCH DETAIL	FLAMMABILITY RATING	CUSHION UPHOLSTERY	FRAME UPHOLSTERY
	None NR Stitch detail SD +\$197	U CTB117	Please refer to list of available upholstery and leather selections on www.gunlocke.com	Please refer to list of available upholstery and leather selections on www.gunlocke.com

Example

GK1113-3A.NR.U.DOL728.SPNN04				
GK1113-3A	NR	U	DOL728	SPNN04
MODEL NUMBER	STITCH	FLAMMABILITY DETAIL	CUSHION UPHOLSTERY	FRAME UPHOLSTERY

Please refer to the Ciji product page on www.gunlocke.com for standard finish options.

Seating
02/24

CIJI THREE SEAT
Mid Back, Arm Left, Wood Legs

model number fabric grades dimensions W D H

GK1115-3W **1** 6,614
Mid back, arm left,
Wood legs

Overall	77 1/8"	31 1/2"	32 1/8"
Seat	73"	21"	17 1/4"
Arm			26 7/8"
Between arms			

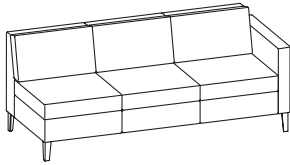

Upholstery Requirements: GK1115-3W

	Dual Upholstery	
Fabric yds	Cushions 4.4	Frame 5.3
Leather ft ²	Cushions 101.2	Frame 121.9
Shipping weight		178 lbs.
Cube		78.5

Cushion	1	10	945	19	2,175	L1	1,447	
	2	86	11	1,059	20	2,317	L2	2,642
	3	173	12	1,173	21	2,461	L3	4,077
	COM/4	258	13	1,317	22	2,603	L4	5,273
	5	372	14	1,459	23	2,890	L5	6,470
	6	487	15	1,603	24	3,176		
	7	602	16	1,745	25	3,461		
	8	716	17	1,888	26	3,748		
	9	831	18	2,032	27	4,034		

To calculate price of lounge with different fabric for cushion and frame; start with Grade 1 price, add appropriate grade price located in second row for cushion, and last add appropriate grade price located in third row for frame to the sum of the Grade 1 and cushion price.

Example: Grade 1 \$6,614 + grade 4 fabric cushion \$258 + grade 2 fabric frame \$105 = \$6,977

Frame	1	10	1,139	19	2,619	L1	1,742	
	2	105	11	1,276	20	2,791	L2	3,183
	3	208	12	1,414	21	2,964	L3	4,912
	COM/4	311	13	1,585	22	3,136	L4	6,353
	5	449	14	1,758	23	3,480	L5	7,792
	6	587	15	1,930	24	3,825		
	7	724	16	2,103	25	4,170		
	8	863	17	2,275	26	4,514		
	9	1,001	18	2,448	27	4,858		

Select upholstery for everything else other than the seat and back cushions (the outside back, arms, sides, seat frame). You can specify the same fabric as the cushions or select other fabric.

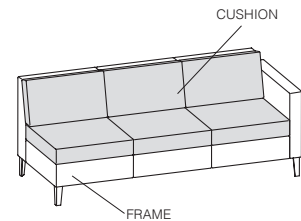

TO ORDER PLEASE SPECIFY THE FOLLOWING:

<input type="text"/>	<input type="text"/>	<input type="text"/>	<input type="text"/>	<input type="text"/>	<input type="text"/>
MODEL NUMBER	WOOD FINISH	STITCH DETAIL	FLAMMABILITY RATING	CUSHION UPHOLSTERY	FRAME UPHOLSTERY
	Cherry finishes on Maple Walnut finishes on Maple Maple finishes on Maple Oak finishes on Maple <i>Light Rift Oak 301 not available on Maple.</i>	None NR Stitch detail SD +\$197	U CTB117	Please refer to list of available upholstery and leather selections on www.gunlocke.com	Please refer to list of available upholstery and leather selections on www.gunlocke.com

Example

GK1115-3W.777.NR.U.DOL728.SPNO4					
GK1115-3W	777	NR	U	DOL728	SPNO4
MODEL NUMBER	WOOD FINISH	STITCH DETAIL	FLAMMABILITY UPHOLSTERY	CUSHION UPHOLSTERY	FRAME REQUEST

Please refer to the Ciji product page on www.gunlocke.com for standard finish options.

CIJI THREE SEAT

Mid Back, Arm Left, Aluminum Legs

Seating
02/24

model number	fabric grades	dimensions	W	D	H
--------------	---------------	------------	---	---	---

GK1115-3A
Mid back, arm left,
Aluminum legs

1 6,899

Overall	77 1/8"	31 1/2"	32 1/8"
Seat	73"	21"	17 1/4"
Arm			26 7/8"
Between arms			

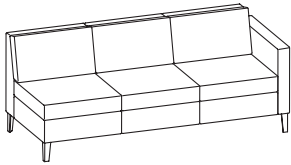

Upholstery Requirements: GK1115-3A

	Dual Upholstery
Fabric yds	Cushions 4.4 Frame 5.3
Leather ft ²	Cushions 101.2 Frame 121.9
Shipping weight	178 lbs.
Cube	78.5

Cushion	1	10	945	19	2,175	L1	1,447
	2	86	11	1,059	20	2,317	L2 2,642
	3	173	12	1,173	21	2,461	L3 4,077
	COM/4	258	13	1,317	22	2,603	L4 5,273
	5	372	14	1,459	23	2,890	L5 6,470
	6	487	15	1,603	24	3,176	
	7	602	16	1,745	25	3,461	
	8	716	17	1,888	26	3,748	
	9	831	18	2,032	27	4,034	

To calculate price of lounge with different fabric for cushion and frame; start with Grade 1 price, add appropriate grade price located in second row for cushion, and last add appropriate grade price located in third row for frame to the sum of the Grade 1 and cushion price.

Example: Grade 1 \$6,899 + grade 4 fabric cushion \$258 + grade 2 fabric frame \$105 = \$7,262

Frame	1	10	1,139	19	2,619	L1	1,742
	2	105	11	1,276	20	2,791	L2 3,183
	3	208	12	1,414	21	2,964	L3 4,912
	COM/4	311	13	1,585	22	3,136	L4 6,353
	5	449	14	1,758	23	3,480	L5 7,792
	6	587	15	1,930	24	3,825	
	7	724	16	2,103	25	4,170	
	8	863	17	2,275	26	4,514	
	9	1,001	18	2,448	27	4,858	

Select upholstery for everything else other than the seat and back cushions (the outside back, arms, sides, seat frame). You can specify the same fabric as the cushions or select other fabric.

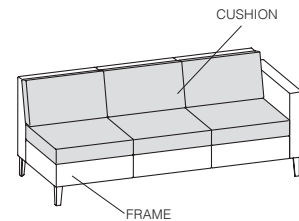

TO ORDER PLEASE SPECIFY THE FOLLOWING:

<input type="text"/>	<input type="text"/>	<input type="text"/>	<input type="text"/>	<input type="text"/>
MODEL NUMBER	STITCH DETAIL	FLAMMABILITY RATING	CUSHION UPHOLSTERY	FRAME UPHOLSTERY
	None NR Stitch detail SD +\$197	U CTB117	Please refer to list of available upholstery and leather selections on www.gunlocke.com	Please refer to list of available upholstery and leather selections on www.gunlocke.com

Example

GK1115-3A.NR.U.DOL728.SPNN04				
GK1115-3A	NR	U	DOL728	SPNN04
MODEL NUMBER	STITCH	FLAMMABILITY DETAIL	CUSHION UPHOLSTERY	FRAME UPHOLSTERY

Please refer to the Ciji product page on www.gunlocke.com for standard finish options.

Seating
02/24

CIJI THREE SEAT

Mid Back, Arm Right, Wood Legs

model number fabric grades
GK1117-3W **1** 6,614

Mid back, arm right,
Wood legs

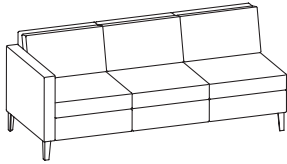

dimensions	W	D	H
Overall	77 1/8"	31 1/2"	32 1/8"
Seat	73"	21"	17 1/4"
Arm			26 7/8"
Between arms			

Upholstery Requirements: GK1117-3W

	Dual Upholstery	
Fabric yds	Cushions 4.4	Frame 5.3
Leather ft ²	Cushions 101.2	Frame 121.9
Shipping weight		178 lbs.
Cube		78.5

Cushion

1	10	945	19	2,175	L1	1,447
2	86	11	1,059	20	L2	2,642
3	173	12	1,173	21	L3	4,077
COM/4	258	13	1,317	22	L4	5,273
5	372	14	1,459	23	L5	6,470
6	487	15	1,603	24		
7	602	16	1,745	25		
8	716	17	1,888	26		
9	831	18	2,032	27		

To calculate price of lounge with different fabric for cushion and frame; start with Grade 1 price, add appropriate grade price located in second row for cushion, and last add appropriate grade price located in third row for frame to the sum of the Grade 1 and cushion price.

Example: Grade 1 \$6,614 + grade 4 fabric cushion \$258 + grade 2 fabric frame \$105 = \$6,977

Select upholstery for everything else other than the seat and back cushions (the outside back, arms, sides, seat frame). You can specify the same fabric as the cushions or select other fabric.

Frame

1	10	1,139	19	2,619	L1	1,742
2	105	11	1,276	20	L2	3,183
3	208	12	1,414	21	L3	4,912
COM/4	311	13	1,585	22	L4	6,353
5	449	14	1,758	23	L5	7,792
6	587	15	1,930	24		
7	724	16	2,103	25		
8	863	17	2,275	26		
9	1,001	18	2,448	27		

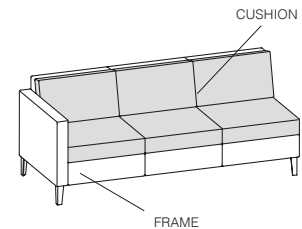

TO ORDER PLEASE SPECIFY THE FOLLOWING:

.

MODEL NUMBER	WOOD FINISH	STITCH DETAIL	FLAMMABILITY RATING	CUSHION UPHOLSTERY	FRAME UPHOLSTERY
	Cherry finishes on Maple Walnut finishes on Maple Maple finishes on Maple Oak finishes on Maple <i>Light Rift Oak 301 not available on Maple.</i>	None NR Stitch detail SD +\$197	U CTB117	Please refer to list of available upholstery and leather selections on www.gunlocke.com	Please refer to list of available upholstery and leather selections on www.gunlocke.com

Example

GK1117-3W.777.NR.U.DOL728.SPNNO4

GK1117-3W	777	NR	U	DOL728	SPNNO4
MODEL NUMBER	WOOD FINISH	STITCH DETAIL	FLAMMABILITY UPHOLSTERY	CUSHION UPHOLSTERY	FRAME REQUEST

Please refer to the Ciji product page on www.gunlocke.com for standard finish options.

CIJI THREE SEAT

Mid Back, Arm Right, Aluminum Legs

Seating
02/24

model number	fabric grades	dimensions	W	D	H
--------------	---------------	------------	---	---	---

GK1117-3A

Mid back, arm right,
Aluminum legs

1 6,899

Overall	77 1/8"	31 1/2"	32 1/8"
Seat	73"	21"	17 1/4"
Arm			26 7/8"
Between arms			

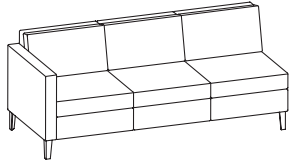

Upholstery Requirements: GK1117-3A

	Dual Upholstery		
Fabric yds	Cushions 4.4	Frame 5.3	
Leather ft ²	Cushions 101.2	Frame 121.9	
Shipping weight			178 lbs.
Cube			78.5

Cushion

1	10	945	19	2,175	L1	1,447
2	86	11	1,059	20	L2	2,642
3	173	12	1,173	21	L3	4,077
COM/4	258	13	1,317	22	L4	5,273
5	372	14	1,459	23	L5	6,470
6	487	15	1,603	24		
7	602	16	1,745	25		
8	716	17	1,888	26		
9	831	18	2,032	27		

To calculate price of lounge with different fabric for cushion and frame; start with Grade 1 price, add appropriate grade price located in second row for cushion, and last add appropriate grade price located in third row for frame to the sum of the Grade 1 and cushion price.

Example: Grade 1 \$6,899 + grade 4 fabric cushion \$258 + grade 2 fabric frame \$105 = \$7,262

Frame

1	10	1,139	19	2,619	L1	1,742
2	105	11	1,276	20	L2	3,183
3	208	12	1,414	21	L3	4,912
COM/4	311	13	1,585	22	L4	6,353
5	449	14	1,758	23	L5	7,792
6	587	15	1,930	24		
7	724	16	2,103	25		
8	863	17	2,275	26		
9	1,001	18	2,448	27		

Select upholstery for everything else other than the seat and back cushions (the outside back, arms, sides, seat frame). You can specify the same fabric as the cushions or select other fabric.

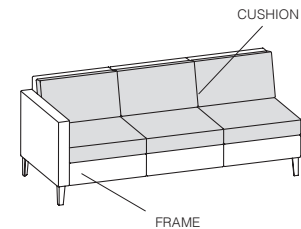

TO ORDER PLEASE SPECIFY THE FOLLOWING:

<input type="text"/>	<input type="text"/>	<input type="text"/>	<input type="text"/>	<input type="text"/>
MODEL NUMBER	STITCH DETAIL	FLAMMABILITY RATING	CUSHION UPHOLSTERY	FRAME UPHOLSTERY
	None NR Stitch detail SD +\$197	U CTB117	Please refer to list of available upholstery and leather selections on www.gunlocke.com	Please refer to list of available upholstery and leather selections on www.gunlocke.com

Example

GK1117-3A.NR.U.DOL728.SPNN04

GK1117-3A	NR	U	DOL728	SPNN04
MODEL NUMBER	STITCH	FLAMMABILITY DETAIL	CUSHION UPHOLSTERY	FRAME UPHOLSTERY

Please refer to the Ciji product page on www.gunlocke.com for standard finish options.

model number fabric grades dimensions W D H

GK1109W
Low back,
Wood Legs

1 3,974

Overall 31 3/4" 31 1/4" 27 7/8"
Seat 20 3/4" 20 3/4" 17 1/4"

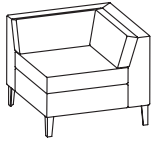

Upholstery Requirements: GK1109W

	Dual Upholstery	
Fabric yds	Cushions 2.7	Frame 2.4
Leather ft ²	Cushions 62.1	Frame 55.2
Shipping weight	93 lbs.	
Cube	28	

Cushion

1	10	580	19	1,334	L1	888
2	54	11	650	20	1,422	L2 1,622
3	107	12	720	21	1,509	L3 2,502
COM/4	159	13	808	22	1,597	L4 3,237
5	229	14	896	23	1,774	L5 3,971
6	299	15	983	24	1,949	
7	369	16	1,072	25	2,124	
8	440	17	1,159	26	2,300	
9	509	18	1,247	27	2,476	

To calculate price of lounge with different fabric for cushion and frame; start with Grade 1 price, add appropriate grade price located in second row for cushion, and last add appropriate grade price located in third row for frame to the sum of the Grade 1 and cushion price.

Example: Grade 1 \$3,974 + grade 4 fabric cushion \$159 + grade 2 fabric frame \$48 = \$4,181

Select upholstery for everything else other than the seat and back cushions (the outside back, arms, sides, seat frame). You can specify the same fabric as the cushions or select other fabric.

Frame

1	10	517	19	1,187	L1	789
2	48	11	578	20	1,264	L2 1,441
3	94	12	641	21	1,343	L3 2,225
COM/4	142	13	718	22	1,420	L4 2,877
5	204	14	797	23	1,576	L5 3,529
6	266	15	875	24	1,732	
7	329	16	953	25	1,888	
8	391	17	1,030	26	2,044	
9	454	18	1,109	27	2,201	

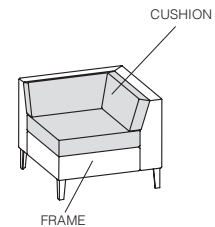

TO ORDER PLEASE SPECIFY THE FOLLOWING:

.

MODEL NUMBER	WOOD FINISH	STITCH DETAIL	FLAMMABILITY RATING	CUSHION UPHOLSTERY	FRAME UPHOLSTERY
	Cherry finishes on Maple Walnut finishes on Maple Maple finishes on Maple Oak finishes on Maple <i>Light Rift Oak 301 not available on Maple.</i>	None NR Stitch detail SD +\$197	U CTB117	Please refer to list of available upholstery and leather selections on www.gunlocke.com	Please refer to list of available upholstery and leather selections on www.gunlocke.com

Example

GK1109W.777.NR.U.DOL728.SPNN04
 GK1109W 777 NR U DOL728 SPNN04
 MODEL NUMBER WOOD FINISH STITCH DETAIL FLAMMABILITY UPHOLSTERY CUSHION UPHOLSTERY FRAME REQUEST

Please refer to the Ciji product page on www.gunlocke.com for standard finish options.

CIJI CORNER UNIT

Low Back, Aluminum Legs

Seating
02/24

model number	fabric grades	dimensions	W	D	H
--------------	---------------	------------	---	---	---

GK1109A
Low back,
Aluminum Legs

1 4,257

Overall	31 3/4"	31 1/4"	27 7/8"
Seat	20 3/4"	20 3/4"	17 1/4"



Upholstery Requirements: GK1109A

	Dual Upholstery	
Fabric yds	Cushions 2.7	Frame 2.4
Leather ft ²	Cushions 62.1	Frame 55.2
Shipping weight	93 lbs.	
Cube	28	

Cushion

1	10	580	19	1,334	L1	888	
2	54	11	650	20	1,422	L2	1,622
3	107	12	720	21	1,509	L3	2,502
COM/4	159	13	808	22	1,597	L4	3,237
5	229	14	896	23	1,774	L5	3,971
6	299	15	983	24	1,949		
7	369	16	1,072	25	2,124		
8	440	17	1,159	26	2,300		
9	509	18	1,247	27	2,476		

To calculate price of lounge with different fabric for cushion and frame; start with Grade 1 price, add appropriate grade price located in second row for cushion, and last add appropriate grade price located in third row for frame to the sum of the Grade 1 and cushion price.

Example: Grade 1 \$4,257 + grade 4 fabric cushion \$159 + grade 2 fabric frame \$48 = \$4,464

Select upholstery for everything else other than the seat and back cushions (the outside back, arms, sides, seat frame). You can specify the same fabric as the cushions or select other fabric.

Frame

1	10	517	19	1,187	L1	789	
2	48	11	578	20	1,264	L2	1,441
3	94	12	641	21	1,343	L3	2,225
COM/4	142	13	718	22	1,420	L4	2,877
5	204	14	797	23	1,576	L5	3,529
6	266	15	875	24	1,732		
7	329	16	953	25	1,888		
8	391	17	1,030	26	2,044		
9	454	18	1,109	27	2,201		

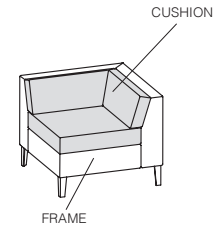

TO ORDER PLEASE SPECIFY THE FOLLOWING:

<input type="text"/>	<input type="text"/>	<input type="text"/>	<input type="text"/>	<input type="text"/>
MODEL NUMBER	STITCH DETAIL	FLAMMABILITY RATING	CUSHION UPHOLSTERY	FRAME UPHOLSTERY
	None NR Stitch detail SD +\$197	U CTB117	Please refer to list of available upholstery and leather selections on www.gunlocke.com	Please refer to list of available upholstery and leather selections on www.gunlocke.com

Example

GK1109A.NR.U.DOL728.SPNN04

GK1109A	NR	U	DOL728	SPNN04
MODEL NUMBER	STITCH	FLAMMABILITY DETAIL	CUSHION UPHOLSTERY	FRAME UPHOLSTERY

Please refer to the Ciji product page on www.gunlocke.com for standard finish options.

model number fabric grades dimensions W D H

GK1119W
Mid back,
Wood legs

1 4,042

Overall	31 3/4"	31 1/2"	32 1/8"
Seat	20 3/4"	20 3/4"	17 1/4"

Upholstery Requirements: GK1119W

	Dual Upholstery	
Fabric yds	Cushions 2.7	Frame 2.5
Leather ft ²	Cushions 62.1	Frame 57.5
Shipping weight	97 lbs.	
Cube	28	



Cushion

1	10	580	19	1,334	L1	888
2	54	11	650	20	1,422	L2 1,622
3	107	12	720	21	1,509	L3 2,502
COM/4	159	13	808	22	1,597	L4 3,237
5	229	14	896	23	1,774	L5 3,971
6	299	15	983	24	1,949	
7	369	16	1,072	25	2,124	
8	440	17	1,159	26	2,300	
9	509	18	1,247	27	2,476	

To calculate price of lounge with different fabric for cushion and frame; start with Grade 1 price, add appropriate grade price located in second row for cushion, and last add appropriate grade price located in third row for frame to the sum of the Grade 1 and cushion price.

Example: Grade 1 \$4,042 + grade 4 fabric cushion \$159 + grade 2 fabric frame \$49 = \$4,250

Select upholstery for everything else other than the seat and back cushions (the outside back, arms, sides, seat frame). You can specify the same fabric as the cushions or select other fabric.

Frame

1	10	538	19	1,235	L1	822
2	49	11	603	20	1,317	L2 1,502
3	98	12	667	21	1,399	L3 2,317
COM/4	147	13	748	22	1,480	L4 2,997
5	212	14	830	23	1,642	L5 3,677
6	278	15	911	24	1,805	
7	342	16	992	25	1,967	
8	407	17	1,073	26	2,130	
9	472	18	1,155	27	2,292	

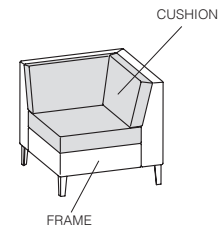

TO ORDER PLEASE SPECIFY THE FOLLOWING:

.

MODEL NUMBER	WOOD FINISH	STITCH DETAIL	FLAMMABILITY RATING	CUSHION UPHOLSTERY	FRAME UPHOLSTERY
	Cherry finishes on Maple Walnut finishes on Maple Maple finishes on Maple Oak finishes on Maple <i>Light Rift Oak 301 not available on Maple.</i>	None NR Stitch detail SD +\$197	U CTB117	Please refer to list of available upholstery and leather selections on www.gunlocke.com	Please refer to list of available upholstery and leather selections on www.gunlocke.com

Example

GK1119W.777.NR.U.DOL728.SPNN04
 GK1119W 777 NR U DOL728 SPNN04
 MODEL NUMBER WOOD FINISH STITCH DETAIL FLAMMABILITY UPHOLSTERY CUSHION UPHOLSTERY FRAME REQUEST

Please refer to the Ciji product page on www.gunlocke.com for standard finish options.

model number	fabric grades
GK1121-1W	1 2,169

Single seat,
Wood legs

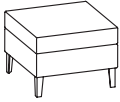

dimensions	W	D	H
Overall	24 5/8"	24 3/4"	17 1/4"
Seat	24 5/8"	24 3/4"	17 1/4"

Upholstery Requirements: GK1121-1W

	Dual Upholstery	
Fabric yds	Cushions 1.2	Frame 1.3
Leather ft ²	Cushions 27.6	Frame 29.9
Shipping weight	64 lbs.	
Cube	28	

Cushion

1	10	258	19	594	L1	395
2	24	11	290	20	L2	721
3	48	12	321	21	L3	1,113
COM/4	72	13	360	22	L4	1,439
5	102	14	398	23	L5	1,765
6	133	15	438	24		
7	165	16	477	25		
8	196	17	517	26		1,022
9	227	18	555	27		1,102

To calculate price of lounge with different fabric for cushion and frame; start with Grade 1 price, add appropriate grade price located in second row for cushion, and last add appropriate grade price located in third row for frame to the sum of the Grade 1 and cushion price.

Example: Grade 1 \$2,169 + grade 4 fabric cushion \$72 + grade 2 fabric frame \$27 = \$2,268

Frame

1	10	280	19	643	L1	428
2	27	11	314	20	L2	781
3	52	12	348	21	L3	1,206
COM/4	78	13	390	22	L4	1,559
5	111	14	432	23	L5	1,912
6	145	15	473	24		
7	179	16	517	25		1,023
8	212	17	559	26		1,108
9	246	18	601	27		1,192

Select upholstery for everything else other than the seat and back cushions (the outside back, arms, sides, seat frame). You can specify the same fabric as the cushions or select other fabric.

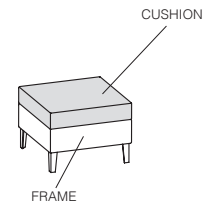

TO ORDER PLEASE SPECIFY THE FOLLOWING:

<input type="text"/>	<input type="text"/>	<input type="text"/>	<input type="text"/>	<input type="text"/>	<input type="text"/>
MODEL NUMBER	WOOD FINISH	STITCH DETAIL	FLAMMABILITY RATING	CUSHION UPHOLSTERY	FRAME UPHOLSTERY
	Cherry finishes on Maple Walnut finishes on Maple Maple finishes on Maple Oak finishes on Maple <i>Light Rift Oak 301 not available on Maple.</i>	None NR Stitch detail SD +\$197	U CTB117	Please refer to list of available upholstery and leather selections on www.gunlocke.com	Please refer to list of available upholstery and leather selections on www.gunlocke.com

Example

GK1121-1W.777.NR.U.DOL728.SPNN04
GK1121-1W 777 NR U DOL728 SPNN04
MODEL NUMBER WOOD FINISH STITCH DETAIL FLAMMABILITY UPHOLSTERY CUSHION UPHOLSTERY FRAME REQUEST

Please refer to the Ciji product page on www.gunlocke.com for standard finish options.

CIJI BENCH

Single Seat, Aluminum Legs

Seating
02/24

model number	fabric grades	dimensions	W	D	H
GK1121-1A Single seat, Aluminum legs	1 2,451	Overall	24 5/8"	24 3/4"	17 1/4"
		Seat	24 5/8"	24 3/4"	17 1/4"

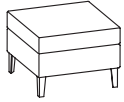

Upholstery Requirements: GK1121-1A

Dual Upholstery	
Fabric yds	Cushions 1.2 Frame 1.3
Leather ft ²	Cushions 27.6 Frame 29.9
Shipping weight	64 lbs.
Cube	28

Cushion

1	10	258	19	594	L1	395
2	24	11	290	20	L2	721
3	48	12	321	21	L3	1,113
COM/4	72	13	360	22	L4	1,439
5	102	14	398	23	L5	1,765
6	133	15	438	24		
7	165	16	477	25		
8	196	17	517	26		1,022
9	227	18	555	27		1,102

To calculate price of lounge with different fabric for cushion and frame; start with Grade 1 price, add appropriate grade price located in second row for cushion, and last add appropriate grade price located in third row for frame to the sum of the Grade 1 and cushion price.

Example: Grade 1 \$2,451 + grade 4 fabric cushion \$72 + grade 2 fabric frame \$27 = \$2,550

Frame

1	10	280	19	643	L1	428
2	27	11	314	20	L2	781
3	52	12	348	21	L3	1,206
COM/4	78	13	390	22	L4	1,559
5	111	14	432	23	L5	1,912
6	145	15	473	24		
7	179	16	517	25		1,023
8	212	17	559	26		1,108
9	246	18	601	27		1,192

Select upholstery for everything else other than the seat and back cushions (the outside back, arms, sides, seat frame). You can specify the same fabric as the cushions or select other fabric.

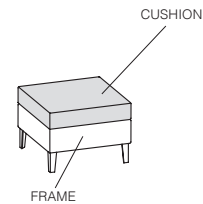

TO ORDER PLEASE SPECIFY THE FOLLOWING:

<input type="text"/>	<input type="text"/>	<input type="text"/>	<input type="text"/>	<input type="text"/>
MODEL NUMBER	STITCH DETAIL	FLAMMABILITY RATING	CUSHION UPHOLSTERY	FRAME UPHOLSTERY
	None NR Stitch detail SD +\$197	U CTB117	Please refer to list of available upholstery and leather selections on www. gunlocke.com	Please refer to list of available upholstery and leather selections on www. gunlocke.com

Example

GK1121-1A.NR.U.DOL728.SPNN04				
GK1121-1A	NR	U	DOL728	SPNN04
MODEL NUMBER	STITCH	FLAMMABILITY DETAIL	CUSHION UPHOLSTERY	FRAME UPHOLSTERY

Please refer to the Ciji product page on www.gunlocke.com for standard finish options.

model number	fabric grades
GK1121-2W	1 3,014

Two seat,
Wood legs

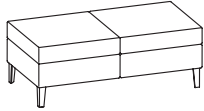

dimensions	W	D	H
Overall	49 1/8"	24 3/4"	17 1/4"
Seat	49 1/8"	24 3/4"	17 1/4"

Upholstery Requirements: GK1121-2W

	Dual Upholstery	
Fabric yds	Cushions 1.5	Frame 1.9
Leather ft ²	Cushions 34.5	Frame 43.7
Shipping weight	74 lbs.	
Cube	35	

Cushion

1	10	323	19	742	L1	494
2	30	11	361	20	L2	902
3	59	12	401	21	L3	1,391
COM/4	89	13	449	22	L4	1,799
5	128	14	498	23	L5	2,206
6	167	15	546	24		1,083
7	205	16	596	25		1,181
8	245	17	644	26		1,279
9	284	18	694	27		1,376

To calculate price of lounge with different fabric for cushion and frame; start with Grade 1 price, add appropriate grade price located in second row for cushion, and last add appropriate grade price located in third row for frame to the sum of the Grade 1 and cushion price.

Example: Grade 1 \$3,014 + grade 4 fabric cushion \$89 + grade 2 fabric frame \$38 = \$3,141

Select upholstery for everything else other than the seat and back cushions (the outside back, arms, sides, seat frame). You can specify the same fabric as the cushions or select other fabric.

Frame

1	10	408	19	940	L1	626
2	38	11	458	20	L2	1,142
3	75	12	507	21	L3	1,762
COM/4	112	13	569	22	L4	2,278
5	161	14	631	23	L5	2,794
6	211	15	693	24		1,371
7	260	16	754	25		1,495
8	309	17	816	26		1,619
9	359	18	878	27		1,742

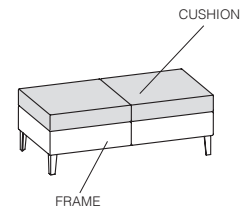

TO ORDER PLEASE SPECIFY THE FOLLOWING:

<input type="text"/>	<input type="text"/>	<input type="text"/>	<input type="text"/>	<input type="text"/>	<input type="text"/>
----------------------	----------------------	----------------------	----------------------	----------------------	----------------------

MODEL NUMBER	WOOD FINISH	STITCH DETAIL	FLAMMABILITY RATING	CUSHION UPHOLSTERY	FRAME UPHOLSTERY
	Cherry finishes on Maple Walnut finishes on Maple Maple finishes on Maple Oak finishes on Maple <i>Light Rift Oak 301 not available on Maple.</i>	None NR Stitch detail SD +\$197	U CTB117	Please refer to list of available upholstery and leather selections on www.gunlocke.com	Please refer to list of available upholstery and leather selections on www.gunlocke.com

Example

GK1121-2W.777.NR.U.DOL728.SPNN04					
GK1121-2W	777	NR	U	DOL728	SPNN04
MODEL NUMBER	WOOD FINISH	STITCH DETAIL	FLAMMABILITY UPHOLSTERY	CUSHION UPHOLSTERY	FRAME REQUEST

Please refer to the Ciji product page on www.gunlocke.com for standard finish options.

CIJI BENCH

Two Seat, Aluminum Legs

Seating
02/24

model number	fabric grades	dimensions	W	D	H
GK1121-2A	1 3,297	Overall	49 1/8"	24 3/4"	17 1/4"
Two seat, Aluminum legs		Seat	49 1/8"	24 3/4"	17 1/4"

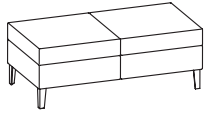

Upholstery Requirements: GK1121-2A

	Dual Upholstery	
Fabric yds	Cushions 1.5	Frame 1.9
Leather ft ²	Cushions 34.5	Frame 43.7
Shipping weight	74 lbs.	
Cube	35	

Cushion

1	10	323	19	742	L1	494	
2	30	11	361	20	791	L2	902
3	59	12	401	21	840	L3	1,391
COM/4	89	13	449	22	888	L4	1,799
5	128	14	498	23	985	L5	2,206
6	167	15	546	24	1,083		
7	205	16	596	25	1,181		
8	245	17	644	26	1,279		
9	284	18	694	27	1,376		

To calculate price of lounge with different fabric for cushion and frame; start with Grade 1 price, add appropriate grade price located in second row for cushion, and last add appropriate grade price located in third row for frame to the sum of the Grade 1 and cushion price.

Example: Grade 1 \$3,297 + grade 4 fabric cushion \$89 + grade 2 fabric frame \$38 = \$3,424

Select upholstery for everything else other than the seat and back cushions (the outside back, arms, sides, seat frame). You can specify the same fabric as the cushions or select other fabric.

Frame

1	10	408	19	940	L1	626	
2	38	11	458	20	1,002	L2	1,142
3	75	12	507	21	1,063	L3	1,762
COM/4	112	13	569	22	1,125	L4	2,278
5	161	14	631	23	1,248	L5	2,794
6	211	15	693	24	1,371		
7	260	16	754	25	1,495		
8	309	17	816	26	1,619		
9	359	18	878	27	1,742		

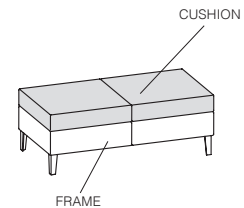

TO ORDER PLEASE SPECIFY THE FOLLOWING:

<input type="text"/>	<input type="text"/>	<input type="text"/>	<input type="text"/>	<input type="text"/>
MODEL NUMBER	STITCH DETAIL	FLAMMABILITY RATING	CUSHION UPHOLSTERY	FRAME UPHOLSTERY
	None NR Stitch detail SD +\$197	U CTB117	Please refer to list of available upholstery and leather selections on www.gunlocke.com	Please refer to list of available upholstery and leather selections on www.gunlocke.com

Example

GK1121-2A.NR.U.DOL728.SPNN04				
GK1121-2A	NR	U	DOL728	SPNN04
MODEL NUMBER	STITCH	FLAMMABILITY DETAIL	CUSHION UPHOLSTERY	FRAME UPHOLSTERY

Please refer to the Ciji product page on www.gunlocke.com for standard finish options.

model number	fabric grades	dimensions	W	D	H
GK1121-3W Three seat, Wood legs	1 3,876	Overall	73 5/8"	24 3/4"	17 1/4"
		Seat	73 5/8"	24 3/4"	17 1/4"

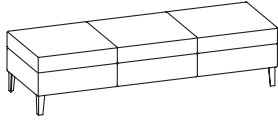

Upholstery Requirements: GK1121-3W

	Dual Upholstery	
Fabric yds	Cushions 2.8	Frame 1.9
Leather ft ²	Cushions 64.4	Frame 43.7
Shipping weight	125 lbs.	
Cube	78.5	

Cushion	1	10	602	19	1,384	L1	920	
	2	56	11	674	20	1,475	L2	1,681
	3	110	12	747	21	1,566	L3	2,595
	COM/4	165	13	839	22	1,657	L4	3,357
	5	237	14	930	23	1,839	L5	4,118
	6	311	15	1,020	24	2,020		
	7	383	16	1,112	25	2,203		
	8	456	17	1,203	26	2,386		
	9	529	18	1,293	27	2,567		

To calculate price of lounge with different fabric for cushion and frame; start with Grade 1 price, add appropriate grade price located in second row for cushion, and last add appropriate grade price located in third row for frame to the sum of the Grade 1 and cushion price.

Example: Grade 1 \$3,876 + grade 4 fabric cushion \$165 + grade 2 fabric frame \$38 = \$4,079

Select upholstery for everything else other than the seat and back cushions (the outside back, arms, sides, seat frame). You can specify the same fabric as the cushions or select other fabric.

Frame	1	10	408	19	940	L1	626	
	2	38	11	458	20	1,002	L2	1,142
	3	75	12	507	21	1,063	L3	1,762
	COM/4	112	13	569	22	1,125	L4	2,278
	5	161	14	631	23	1,248	L5	2,794
	6	211	15	693	24	1,371		
	7	260	16	754	25	1,495		
	8	309	17	816	26	1,619		
	9	359	18	878	27	1,742		

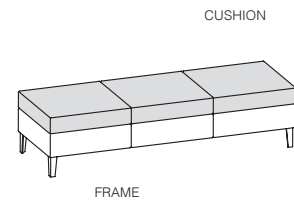

TO ORDER PLEASE SPECIFY THE FOLLOWING:

<input type="text"/>	<input type="text"/>	<input type="text"/>	<input type="text"/>	<input type="text"/>	<input type="text"/>
MODEL NUMBER	WOOD FINISH	STITCH DETAIL	FLAMMABILITY RATING	CUSHION UPHOLSTERY	FRAME UPHOLSTERY
	Cherry finishes on Maple Walnut finishes on Maple Maple finishes on Maple Oak finishes on Maple <i>Light Rift Oak 301 not available on Maple.</i>	None NR Stitch detail SD +\$197	U CTB117	Please refer to list of available upholstery and leather selections on www.gunlocke.com	Please refer to list of available upholstery and leather selections on www.gunlocke.com

Example

GK1121-3W.777.NR.U.DOL728.SPNO4					
GK1121-3W	777	NR	U	DOL728	SPNO4
MODEL NUMBER	WOOD FINISH	STITCH DETAIL	FLAMMABILITY UPHOLSTERY	CUSHION UPHOLSTERY	FRAME REQUEST

Please refer to the Ciji product page on www.gunlocke.com for standard finish options.

CIJI BENCH

Three Seat, Aluminum Legs

Seating
02/24

model number	fabric grades	dimensions	W	D	H
GK1121-3A Three seat, Aluminum legs	1 4,160	Overall	73 5/8"	24 3/4"	17 1/4"
		Seat	73 5/8"	24 3/4"	17 1/4"

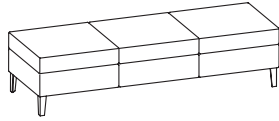

Upholstery Requirements: GK1121-3A

	Dual Upholstery	
Fabric yds	Cushions 2.8	Frame 1.9
Leather ft ²	Cushions 64.4	Frame 43.7
Shipping weight	125 lbs.	
Cube	78.5	

Cushion	1	10	602	19	1,384	L1	920	
	2	56	11	674	20	1,475	L2	1,681
	3	110	12	747	21	1,566	L3	2,595
	COM/4	165	13	839	22	1,657	L4	3,357
	5	237	14	930	23	1,839	L5	4,118
	6	311	15	1,020	24	2,020		
	7	383	16	1,112	25	2,203		
	8	456	17	1,203	26	2,386		
	9	529	18	1,293	27	2,567		

To calculate price of lounge with different fabric for cushion and frame; start with Grade 1 price, add appropriate grade price located in second row for cushion, and last add appropriate grade price located in third row for frame to the sum of the Grade 1 and cushion price.

Example: Grade 1 \$4,160 + grade 4 fabric cushion \$165 + grade 2 fabric frame \$38 = \$4,363

Select upholstery for everything else other than the seat and back cushions (the outside back, arms, sides, seat frame). You can specify the same fabric as the cushions or select other fabric.

Frame	1	10	408	19	940	L1	626	
	2	38	11	458	20	1,002	L2	1,142
	3	75	12	507	21	1,063	L3	1,762
	COM/4	112	13	569	22	1,125	L4	2,278
	5	161	14	631	23	1,248	L5	2,794
	6	211	15	693	24	1,371		
	7	260	16	754	25	1,495		
	8	309	17	816	26	1,619		
	9	359	18	878	27	1,742		

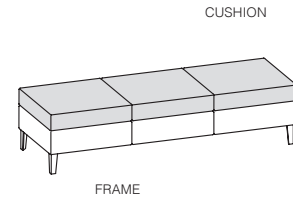

TO ORDER PLEASE SPECIFY THE FOLLOWING:

<input type="text"/>	<input type="text"/>	<input type="text"/>	<input type="text"/>	<input type="text"/>
MODEL NUMBER	STITCH DETAIL	FLAMMABILITY RATING	CUSHION UPHOLSTERY	FRAME UPHOLSTERY
	None NR Stitch detail SD +\$197	U CTB117	Please refer to list of available upholstery and leather selections on www.gunlocke.com	Please refer to list of available upholstery and leather selections on www.gunlocke.com

Example

GK1121-3A.NR.U.DOL728.SPNN04
 GK1121-3A NR U DOL728 SPNN04
 MODEL NUMBER STITCH FLAMMABILITY RATING CUSHION UPHOLSTERY FRAME UPHOLSTERY

Please refer to the Ciji product page on www.gunlocke.com for standard finish options.

Seating
02/24

CIJI REPLACEMENT PARTS

Back Cushions

model number	fabric grades								dimensions	W	D	H
GK1131 Replacement back cushion for low back lounge	1	583	10	906	19	1,325	L1	1,077	Overall	24 5/8"	4"	11"
	2	613	11	944	20	1,374	L2	1,485	Upholstery Fabric yds	1.5		
	3	642	12	984	21	1,423	L3	1,974	Leather ft ²	34.5		
	COM/4	672	13	1,032	22	1,471	L4	2,382				
	5	711	14	1,081	23	1,568	L5	2,789				
	6	750	15	1,129	24	1,666						
	7	788	16	1,179	25	1,764						
	8	828	17	1,227	26	1,862						
	9	867	18	1,277	27	1,959						

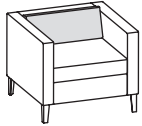

GK1133 Replacement back cushion for low back corner unit	1	1,092	10	1,415	19	1,834	L1	1,586	Overall	27 1/4"	4"	11"
	2	1,122	11	1,453	20	1,883	L2	1,994	Upholstery Fabric yds	1.5		
	3	1,151	12	1,493	21	1,932	L3	2,483	Leather ft ²	34.5		
	COM/4	1,181	13	1,541	22	1,980	L4	2,891				
	5	1,220	14	1,590	23	2,077	L5	3,298				
	6	1,259	15	1,638	24	2,175						
	7	1,297	16	1,688	25	2,273						
	8	1,337	17	1,736	26	2,371						
	9	1,376	18	1,786	27	2,468						

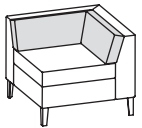

GK1137 Replacement back cushion for mid back lounge	1	583	10	906	19	1,325	L1	1,077	Overall	24 5/8"	4"	15"
	2	613	11	944	20	1,374	L2	1,485	Upholstery Fabric yds	1.5		
	3	642	12	984	21	1,423	L3	1,974	Leather ft ²	34.5		
	COM/4	672	13	1,032	22	1,471	L4	2,382				
	5	711	14	1,081	23	1,568	L5	2,789				
	6	750	15	1,129	24	1,666						
	7	788	16	1,179	25	1,764						
	8	828	17	1,227	26	1,862						
	9	867	18	1,277	27	1,959						

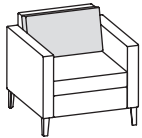

TO ORDER PLEASE SPECIFY THE FOLLOWING:

. . .

MODEL NUMBER

STITCH DETAIL

FLAMMABILITY RATING

CUSHIONS UPHOLSTERY

None **NR**
Stitch detail **SD +\$197**

U CTB117

Please refer to list of available upholstery and leather selections on www.gunlocke.com

Example

GK1131.NR.U.DOL728

GK1131 NR U DOL728
MODEL NUMBER STITCH DETAIL FLAMMABILITY CUSHION UPHOLSTERY

CIJI REPLACEMENT PARTS

Seating
02/24

Cushions and Arms

model number	fabric grades								dimensions	W	D	H
GK1139 Replacement back cushions for mid back corner unit	1	1,092	10	1,415	19	1,834	L1	1,586	Overall	24 5/8"	4"	15"
	2	1,122	11	1,453	20	1,883	L2	1,994	Upholstery Fabric yds	1.5		
	3	1,151	12	1,493	21	1,932	L3	2,483	Leather ft ²	34.5		
	COM/4	1,181	13	1,541	22	1,980	L4	2,891				
	5	1,220	14	1,590	23	2,077	L5	3,298				
	6	1,259	15	1,638	24	2,175						
	7	1,297	16	1,688	25	2,273						
	8	1,337	17	1,736	26	2,371						
	9	1,376	18	1,786	27	2,468						



GK1143 Replacement seat cushion	1	801	10	1,124	19	1,543	L1	1,295	Overall	24 5/8"	24 5/8"	5"
	2	831	11	1,162	20	1,592	L2	1,703	Upholstery Fabric yds	1.5		
	3	860	12	1,202	21	1,641	L3	2,192	Leather ft ²	34.5		
	COM/4	890	13	1,250	22	1,689	L4	2,600				
	5	929	14	1,299	23	1,786	L5	3,007				
	6	968	15	1,347	24	1,884						
	7	1,006	16	1,397	25	1,982						
	8	1,046	17	1,445	26	2,080						
	9	1,085	18	1,495	27	2,177						

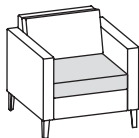

GK1145R Replacement arm right or left	1	872	10	1,366	19	2,010	L1	1,629	Overall	31"	3 1/2"	20 7/8"
	2	918	11	1,427	20	2,085	L2	2,254	Upholstery Fabric yds	2.3		
	3	963	12	1,486	21	2,159	L3	3,004	Leather ft ²	52.9		
	COM/4	1,007	13	1,562	22	2,234	L4	3,629				
	5	1,067	14	1,636	23	2,384	L5	4,255				
	6	1,127	15	1,711	24	2,533						
	7	1,188	16	1,785	25	2,681						
	8	1,246	17	1,860	26	2,831						
	9	1,306	18	1,934	27	2,982						

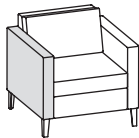

TO ORDER PLEASE SPECIFY THE FOLLOWING:

. . .

MODEL NUMBER

STITCH DETAIL

FLAMMABILITY RATING

CUSHIONS UPHOLSTERY

None **NR**
Stitch detail **SD +\$197**

U CTB117

Please refer to list of available upholstery and leather selections on www.gunlocke.com

Option not available for GK1145R or GK1145L

Example

GK1139.NR.U.DOL728

GK1139 NR U DOL728
MODEL NUMBER STITCH DETAIL FLAMMABILITY CUSHION UPHOLSTERY

model number	list	dimensions	W	D	H
GK1155 Replacement wood leg	367		3 1/2	3 1/2	6
					
GK1157 Replacement aluminum leg	239		3 1/2	3 1/2	6
					
GK1159 Plate for joining 3 lounge units	149		6 3/4"	2 5/8"	2 3/4"
 <ul style="list-style-type: none"> • Used to span the corner formed by the intersection of two armless lounges with a corner unit when assembled in L-shape. This bracket replaces three leg units with one in permanent L-setups 					
GK1161 Power module	588		1 7/8"	5"	5/8"
 <ul style="list-style-type: none"> • 15 amp, 72" cord 					
GK1163 Ganging bracket, set of two	178				
					

TO ORDER PLEASE SPECIFY THE FOLLOWING:

.

MODEL NUMBER WOOD FINISH

Option available for GK1155 only.
Cherry finishes on Maple
Walnut finishes on Maple
Maple finishes on Maple
Oak finishes on Maple
Light Rift Oak 301 not available on Maple.
 Please refer to the Ciji product page on www.gunlocke.com for standard finish options.

Example

GK1155.215
 GK1155 215
 MODEL NUMBER WOOD FINISH

IRIS

Single Upholstery, Metal Base

model number	fabric grades							dimensions	W	D	H	
GLIRS17-011 Single upholstery lounge, return-to-center metal base	1	4,482	10	5,084	19	5,866	L1	5,125	Overall	29 5/8"	27 1/2"	34 3/4"
	2	4,538	11	5,156	20	5,957	L2	5,688	Seat	22"	19 3/4"	17 5/8"
	3	4,592	12	5,229	21	6,048	L3	6,362	Upholstery Requirements: GLIRS17-011			
	COM/4	4,647	13	5,321	22	6,139	L4	6,925	Fabric yards	2.8		
	5	4,719	14	5,412	23	6,321	L5	7,487	Leather feet ²	47.6		
	6	4,793	15	5,502	24	6,502			Shipping weight	45 lbs.		
	7	4,865	16	5,594	25	6,685			Cube	21.7		
	8	4,938	17	5,685	26	6,868			Note: Lounge 4-star metal base comes standard at a fixed height with return-to-center base.			
	9	5,011	18	5,775	27	7,049						



GLIRS17-031 Single upholstery ottoman, fixed metal base	1	1,811	10	2,091	19	2,454	L1	2,109	Overall	21 3/4"	17 3/4"	15 1/4"
	2	1,838	11	2,125	20	2,496	L2	2,371	Upholstery Requirements: GLIRS17-031			
	3	1,863	12	2,159	21	2,539	L3	2,684	Fabric yards	1.3		
	COM/4	1,889	13	2,201	22	2,581	L4	2,946	Leather feet ²	22.1		
	5	1,922	14	2,243	23	2,665	L5	3,207	Shipping weight	20 lbs.		
	6	1,956	15	2,284	24	2,750			Cube	5.4		
	7	1,990	16	2,328	25	2,834			Note: Ottoman metal base comes standard at a fixed height with fixed base.			
	8	2,023	17	2,370	26	2,919						
	9	2,057	18	2,412	27	3,003						



TO ORDER PLEASE SPECIFY THE FOLLOWING:

<input type="text"/>	<input type="text"/>	<input type="text"/>	<input type="text"/>
MODEL NUMBER	BASE COLOR	FLAMMABILITY RATING	UPHOLSTERY
	Polished Aluminum BAL	U CTB117	Please refer to list of available upholstery and leather selections on www.gunlocke.com

Example

GLIRS17-011.BAL.U.DOL728			
GLIRS17-011	BAL	U	DOL728
MODEL NUMBER	BASE COLOR	FLAMMABILITY	UPHOLSTERY

Dual Upholstery Lounge, Metal Base

model number	fabric grades
GLIRS17-021	1 4,570

Dual upholstery lounge,
return-to-center metal base



dimensions	W	D	H
Overall	29 5/8"	27 1/2"	34 1"
Seat	22"	19 3/4"	17 5/8"

Upholstery Requirements: GLIRS17-021

	Dual Upholstery	
Fabric yds	Inside 1.8	Outside 1.2
Leather ft ²	Inside 30.6	Outside 20.4
Shipping weight	45 lbs.	
Cube	21.7	

Note: Lounge 4-star metal base comes standard at a fixed height with return-to-center base.

Inside	1	10	387	19	890	L1	415	
	2	36	11	434	20	948	L2	776
	3	72	12	480	21	1,007	L3	1,209
	COM/4	107	13	539	22	1,066	L4	1,570
	5	153	14	597	23	1,183	L5	1,932
	6	199	15	657	24	1,300		
	7	247	16	715	25	1,417		
	8	294	17	773	26	1,533		
	9	340	18	832	27	1,651		

To calculate price of lounge with different fabric for Inside and Outside, start with Grade 1 price, add appropriate grade price located in second row for Inside, and last add appropriate grade price located in third row for arms to the sum of the Grade 1 and Inside/Outside price.

Example: Grade 1 \$4,570 + grade 4 fabric Inside \$107 + grade 2 fabric Outside \$24 = \$4,701

Outside	1	10	258	19	594	L1	277	
	2	24	11	290	20	633	L2	518
	3	48	12	321	21	671	L3	806
	COM/4	72	13	360	22	710	L4	1,047
	5	102	14	398	23	789	L5	1,289
	6	133	15	438	24	867		
	7	165	16	477	25	945		
	8	196	17	517	26	1,022		
	9	227	18	555	27	1,102		

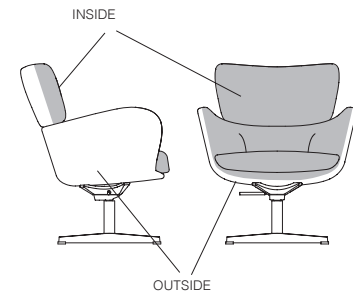

TO ORDER PLEASE SPECIFY THE FOLLOWING:

<input type="text"/>	<input type="text"/>	<input type="text"/>	<input type="text"/>	<input type="text"/>
MODEL NUMBER	BASE COLOR	FLAMMABILITY RATING	INSIDE UPHOLSTERY	OUTSIDE UPHOLSTERY
	Polished Aluminum BAL	U CTB117	Please refer to list of available upholstery and leather selections on www.gunlocke.com	Please refer to list of available upholstery and leather selections on www.gunlocke.com

Example

GLIRS17-021.BAL.U.DOL728.SPNN04				
MODEL NUMBER	BASE COLOR	FLAMMABILITY	INSIDE UPHOLSTERY	OUTSIDE UPHOLSTERY
GLIRS17-021	BAL	U	DOL728	SPNN04

IRIS

Dual Upholstery Ottoman, Metal Base

Seating
02/24

model number	fabric grades	dimensions	W	D	H
GLIRS17-041	1 1,843	Overall	21 3/4"	17 3/4"	15 1/4"

GLIRS17-041
Dual upholstery ottoman,
fixed metal base



Upholstery Requirements: GLIRS17-041

Dual Upholstery	
Fabric yds	Top 0.6 Bottom 1
Leather ft ²	Top 10.2 Bottom 17
Shipping weight	20 lbs.
Cube	5.4

Note: Ottoman metal base comes standard at a fixed height with return-to-center base.

Top

1	10	130	19	297	L1	140
2	12	11	146	20	L2	259
3	24	12	160	21	L3	404
COM/4	36	13	181	22	L4	524
5	52	14	199	23	L5	644
6	67	15	220	24		
7	83	16	239	25		
8	98	17	258	26		
9	115	18	279	27		

To calculate price of lounge with different fabric for Inside and Outside, start with Grade 1 price, add appropriate grade price located in second row for Top, and last add appropriate grade price located in third row for Bottom to the sum of the Grade 1, Top/Bottom price.

Example: Grade 1 \$1,843 + grade 4 fabric Top \$36 + grade 2 fabric Bottom \$20 = \$1,899

Bottom

1	10	216	19	495	L1	230
2	20	11	242	20	L2	431
3	41	12	267	21	L3	672
COM/4	59	13	299	22	L4	873
5	85	14	332	23	L5	1,075
6	111	15	365	24		
7	137	16	397	25		
8	164	17	430	26		
9	190	18	462	27		

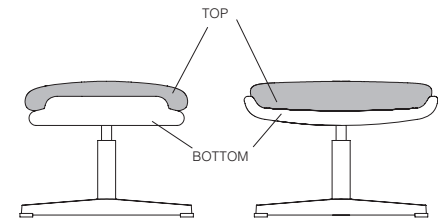



TO ORDER PLEASE SPECIFY THE FOLLOWING:

<input type="text"/>	<input type="text"/>	<input type="text"/>	<input type="text"/>	<input type="text"/>
MODEL NUMBER	BASE COLOR	FLAMMABILITY RATING	TOP UPHOLSTERY	BOTTOM UPHOLSTERY
	Polished Aluminum BAL	U CTB117	Please refer to list of available upholstery and leather selections on www.gunlocke.com	Please refer to list of available upholstery and leather selections on www.gunlocke.com

Example

GLIRS17-041.BAL.U.DOL728.SPNN04				
GLIRS17-041	BAL	U	DOL728	SPNN04
MODEL NUMBER	BASE COLOR	FLAMMABILITY	TOP UPHOLSTERY	BOTTOM UPHOLSTERY

model number	fabric grades								dimensions	W	D	H
GLIRS17-051 Single upholstery lounge, wood legs 	1	4,570	10	5,172	19	5,954	L1	5,213	Overall	29 5/8"	27 1/2"	34 3/4"
	2	4,626	11	5,244	20	6,045	L2	5,776	Seat	22"	19 3/4"	18 3/4"
	3	4,680	12	5,317	21	6,136	L3	6,450	Upholstery Requirements: GLIRS17-051			
	COM/4	4,735	13	5,409	22	6,227	L4	7,013	Fabric yards	2.8		
	5	4,807	14	5,500	23	6,409	L5	7,575	Leather feet ²	47.6		
	6	4,881	15	5,590	24	6,590			Shipping weight	45 lbs.		
	7	4,953	16	5,682	25	6,773			Cube	21.7		
	8	5,026	17	5,773	26	6,956						
	9	5,099	18	5,863	27	7,137						

GLIRS17-071 Single upholstery ottoman, wood legs 	1	1,843	10	2,123	19	2,486	L1	2,141	Overall	21 3/4"	17 3/4"	15 1/4"
	2	1,870	11	2,157	20	2,528	L2	2,403	Upholstery Requirements: GLIRS17-071			
	3	1,895	12	2,191	21	2,571	L3	2,716	Fabric yards	1.3		
	COM/4	1,921	13	2,233	22	2,613	L4	2,978	Leather feet ²	22.1		
	5	1,954	14	2,275	23	2,697	L5	3,239	Shipping weight	20 lbs.		
	6	1,988	15	2,316	24	2,782			Cube	5.4		
	7	2,022	16	2,360	25	2,866						
	8	2,055	17	2,402	26	2,951						
	9	2,089	18	2,444	27	3,035						

TO ORDER PLEASE SPECIFY THE FOLLOWING:

<input type="text"/>	<input type="text"/>	<input type="text"/>	<input type="text"/>
MODEL NUMBER	FINISH	FLAMMABILITY RATING	UPHOLSTERY

These seating models are available in the following hardwoods:

Maple **NE**
Ash **QA**

Please refer to the Tia product page on www.gunlocke.com for standard finish options.

Cherry finishes on Maple or Ash
Walnut finishes on Maple or Ash
Maple finishes on Maple or Ash
Oak finishes on Maple or Ash

Natural Cherry 222, Clear Maple 800, Clear Oak 300 and Fawn Cypress 108 not available on Ash.

Light Rift Oak 301 not available on Maple.

U CTB117

Please refer to list of available upholstery and leather selections on www.gunlocke.com

Example

GLIRS17-051.QA629.U.DOL728
GLIRS17-051 QA629 U DOL728
MODEL NUMBER FINISH FLAMMABILITY UPHOLSTERY

IRIS

Dual Upholstery Lounge, Wood Legs

Seating
02/24

model number	fabric grades
GLIRS17-061	1 4,657

Dual upholstery lounge,
wood legs



dimensions	W	D	H
Overall	32"	32"	30"
Seat	22"	19 3/4"	18 3/4"

Upholstery Requirements: GLIRS17-061

	Dual Upholstery	
Fabric yds	Inside 1.8	Outside 1.2
Leather ft ²	Inside 30.6	Outside 20.4
Shipping weight	45 lbs.	
Cube	21.7	

Inside

1	10	387	19	890	L1	415	
2	36	11	434	20	948	L2	776
3	72	12	480	21	1,007	L3	1,209
COM/4	107	13	539	22	1,066	L4	1,570
5	153	14	597	23	1,183	L5	1,932
6	199	15	657	24	1,300		
7	247	16	715	25	1,417		
8	294	17	773	26	1,533		
9	340	18	832	27	1,651		

To calculate price of lounge with different fabric for Inside and Outside, start with Grade 1 price, add appropriate grade price located in second row for Inside, and last add appropriate grade price located in third row for arms to the sum of the Grade 1 and Inside/Outside price.

Example: Grade 1 \$4,657 + grade 4 fabric Inside \$107 + grade 2 fabric Outside \$24 = \$4,788

Outside

1	10	258	19	594	L1	277	
2	24	11	290	20	633	L2	518
3	48	12	321	21	671	L3	806
COM/4	72	13	360	22	710	L4	1,047
5	102	14	398	23	789	L5	1,289
6	133	15	438	24	867		
7	165	16	477	25	945		
8	196	17	517	26	1,022		
9	227	18	555	27	1,102		

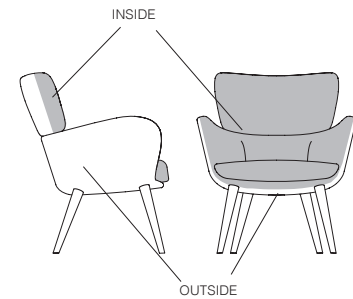

TO ORDER PLEASE SPECIFY THE FOLLOWING:

<input type="text"/>	<input type="text"/>	<input type="text"/>	<input type="text"/>	<input type="text"/>
MODEL NUMBER	FINISH	FLAMMABILITY RATING	INSIDE UPHOLSTERY	OUTSIDE UPHOLSTERY

These seating models are available in the following hardwoods:

Maple **NE**
Ash **QA**

Please refer to the Tia product page on www.gunlocke.com for standard finish options.

Cherry finishes on Maple or Ash
Walnut finishes on Maple or Ash
Maple finishes on Maple or Ash
Oak finishes on Maple or Ash

Natural Cherry 222, Clear Maple 800, Clear Oak 300 and Fawn Cypress 108 not available on Ash.

Light Rift Oak 301 not available on Maple.

U CTB117

Please refer to list of available upholstery and leather selections on www.gunlocke.com

Please refer to list of available upholstery and leather selections on www.gunlocke.com

Example

GLIRS17-061.QA629.U.DOL728.SPNN04

GLIRS17-061	QA629	U	DOL728	SPNN04
MODEL NUMBER	FINISH	FLAMMABILITY	INSIDE UPHOLSTERY	OUTSIDE UPHOLSTERY

model number	fabric grades	dimensions	W	D	H
--------------	---------------	------------	---	---	---

GLIRS17-081
Dual upholstery ottoman,
wood legs

1 1,879

Overall 21 3/4" 17 3/4" 15 1/4"

Upholstery Requirements: GLIRS17-081

	Dual Upholstery	
Fabric yds	Top 0.6	Bottom 1
Leather ft ²	Top 10.2	Bottom 17
Shipping weight	20 lbs.	
Cube	5.4	



Top

1	10	130	19	297	L1	140	
2	12	11	146	20	317	L2	259
3	24	12	160	21	336	L3	404
COM/4	36	13	181	22	356	L4	524
5	52	14	199	23	395	L5	644
6	67	15	220	24	434		
7	83	16	239	25	472		
8	98	17	258	26	511		
9	115	18	279	27	552		

To calculate price of lounge with different fabric for Inside and Outside, start with Grade 1 price, add appropriate grade price located in second row for Top, and last add appropriate grade price located in third row for Bottom to the sum of the Grade 1, Top/Bottom price.

Example: Grade 1 \$1,879 + grade 4 fabric Top \$36 + grade 2 fabric Bottom \$20 = \$1,935

Bottom

1	10	216	19	495	L1	230	
2	20	11	242	20	528	L2	431
3	41	12	267	21	560	L3	672
COM/4	59	13	299	22	593	L4	873
5	85	14	332	23	658	L5	1,075
6	111	15	365	24	723		
7	137	16	397	25	788		
8	164	17	430	26	852		
9	190	18	462	27	917		

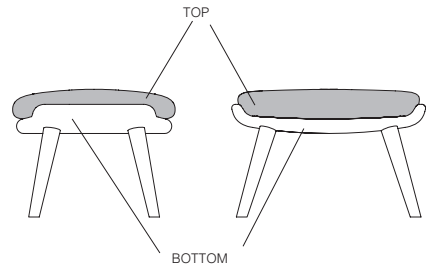

TO ORDER PLEASE SPECIFY THE FOLLOWING:

. . . .

MODEL NUMBER **FINISH** **FLAMMABILITY RATING** **TOP UPHOLSTERY** **BOTTOM UPHOLSTERY**

These seating models are available in the following hardwoods:
Maple **NE**
Ash **QA**

Please refer to the Tia product page on www.gunlocke.com for standard finish options.

Cherry finishes on Maple or Ash
Walnut finishes on Maple or Ash
Maple finishes on Maple or Ash
Oak finishes on Maple or Ash

Natural Cherry 222, Clear Maple 800, Clear Oak 300 and Fawn Cypress 108 not available on Ash.
Light Rift Oak 301 not available on Maple.

U CTB117

Please refer to list of available upholstery and leather selections on www.gunlocke.com

Please refer to list of available upholstery and leather selections on www.gunlocke.com

Example





GLIRS17-081.QA629.U.DOL728.SPNN04

GLIRS17-081	QA629	U	DOL728	SPNN04
MODEL NUMBER	FINISH	FLAMMABILITY	TOP UPHOLSTERY	BOTTOM UPHOLSTERY

Occasional Tables.....	173-180
Briefing	174
Calm	175-177
Cylinder.....	178
Cube	179
Letchworth	180

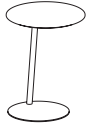
BRIEFING OCCASIONAL TABLES

Seating
02/24

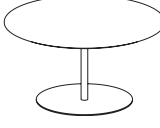
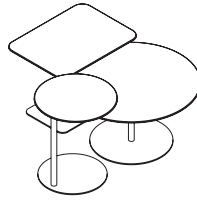
	D	W	H	model number + type	veneer 1	veneer 2	veneer 3	laminated	solid surface
LAPTOP TABLE 24H 	18	18	24 1/2	GM2LTRD18H24- []	2,086	2,295	2,504	2,052	2,556
	<ul style="list-style-type: none"> • Top size 18" Dia. • Disc size 14" Dia. 								
END TABLE 24H 	18	18	24 1/2	GM2ETRD18H24- []	2,086	2,295	2,504	2,053	2,558
	<ul style="list-style-type: none"> • Top size 18" Dia. • Disc size 14" Dia. 								
NESTING TABLE 19H 	18	18	19 1/2	GM2NTRD18H19- []	2,086	2,295	2,504	2,052	2,556
	<ul style="list-style-type: none"> • Top size 18" Dia. • Disc size 14" Dia. 								
NESTING TABLE 17H 	18	24	17 1/2	GM2NTRS1824H17- []	2,574	2,832	3,089	2,575	3,104
	<ul style="list-style-type: none"> • Top size 18" x 24" • Disc size 12" x 18" 								
NESTING TABLE 15H 	30	30	15 1/2	GM2NTRD30H15- []	2,901	3,192	3,482	2,858	3,471
	<ul style="list-style-type: none"> • Top size 30" Dia. • Disc size 18" Dia. 								
					Nested tables can be grouped together to create a collection with varying heights.				

PRODUCT INFO

Top thickness:

Wood 3/4"

Laminate 3/4"

Glass 1/2"

Solid Surface 1/2"

Top includes inserts for connection to base.

Tops include a knife edge standard.

 Units shipped as separate packages and require field assembly.

TO ORDER PLEASE SPECIFY THE FOLLOWING:

WOOD

1. MODEL NUMBER + W

2. FSC

3. FINISH

4. TOP FINISH

5. HARDWARE OPTION

- P71** Black
- PR6** Silver
- P8G** Matte Gold
- PJE** Pyrite
- PJW** Designer White
- P8X** Solar Black
- P8T** Titanium
- PJF** Bullseye
- P8M** Regatta
- PC** Polished Chrome (add \$225)

LAMINATE

1. MODEL NUMBER + L

2. FSC

3. FINISH

4. HARDWARE OPTION

- P71** Black
- PR6** Silver
- P8G** Matte Gold
- PJE** Pyrite
- PJW** Designer White
- P8X** Solar Black
- P8T** Titanium
- PJF** Bullseye
- P8M** Regatta
- PC** Polished Chrome (add \$225)

SOLID SURFACE

1. MODEL NUMBER + S

2. FINISH

3. HARDWARE OPTION

- P71** Black
- PR6** Silver
- P8G** Matte Gold
- PJE** Pyrite
- PJW** Designer White
- P8X** Solar Black
- P8T** Titanium
- PJF** Bullseye
- P8M** Regatta
- PC** Polished Chrome (add \$225)

Example

GM2LTRD18H24-W.X.NC260.OP.P71

GM2LTRD18H24-W	X	NC260	OP	P71
MODEL NUMBER + TYPE	FSC	FINISH	TOP FINISH	HARDWARE OPTION

32" Depth Occasional Tables

	D	W	H	model number + type	veneer 2	veneer 3	laminated	solid surface	glass	field-installed top
32"D x 25"W Occasional table	32	25	17	GTGB17-3225H17- <input type="checkbox"/>	3,107	3,413	2,641	4,738	4,037	2,952
				Shipping wgt	45 lb	45 lb	45 lb	55 lb	55 lb	35 lb
				Cubes	11.3	11.3	11.3	11.3	11.3	11.1

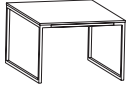

32"D x 32"W Occasional table	32	32	17	GTGB17-3232H17- <input type="checkbox"/>	3,373	3,704	2,865	5,144	4,384	3,204
				Shipping wgt	50 lb	50 lb	50 lb	60 lb	60 lb	40 lb
				Cubes	14.2	14.2	14.2	14.2	14.2	13.8



32"D x 50"W Occasional table	32	50	17	GTGB17-3250H17- <input type="checkbox"/>	3,904	4,287	3,317	5,952	5,076	3,709
				Shipping wgt	55 lb	55 lb	55 lb	65 lb	65 lb	45 lb
				Cubes	21.5	21.5	21.5	21.5	21.5	20.9



Note: 32"D occasional tables can be used in-line with lounge units, but are freestanding and do not gang.

TO ORDER PLEASE SPECIFY THE FOLLOWING:

. . .

MODEL NUMBER + TYPE	FRAME COLOR	TOP MATERIAL	TOP FINISH (WOOD TOPS ONLY)
Note: Type must be specified as part of model number. Wood Veneer W Laminate L Solid Surface S Glass G Field-Installed Top F	Polished Chrome \$113 - 32x25 \$142 - 32x32 \$169 - 32x50 Brushed Chrome Steel \$113 - 32x25 \$142 - 32x32 \$169 - 32x50 Black Designer White Matte Gold Silver Solar Black Titanium Bullseye Regatta	PC BS P71 PJW P8G PR6 P8X P8T PJF P8M	Note: Wood and laminate tops are 1 1/8" thick, rabbeted and inset to leave 1/2" thick edge detail. solid surface and glass tops are 12mm thick, with an inset 3/4" MDF subtop. Field-installed tops receive an inset 3/4" MDF subtop. Wood, laminate, solid surfaces and glass tops all have 1/16" overhang per side. See page 84-85 for required option codes.

Example



GTGB17-3225H17-W.PC.NC215.OP



GTGB17-3225H17-W	PC	NC215	OP
MODEL NUMBER	FRAME COLOR	TOP MATERIAL	TOP FINISH

CALM

16" Depth Occasional Tables





Seating
02/24

	D	W	H	model number + type	veneer 2	veneer 3	laminare	solid surface	glass	field-installed top
16"D x 32"W Occasional table	16	32	17	GTGB17-1632H17- 	2,841	3,120	2,414	4,331	3,690	2,698
				Shipping wgt	35 lb	35 lb	35 lb	45 lb	45 lb	25 lb
				Cubes	7.7	7.7	7.7	7.7	7.7	7.5

16"D x 50"W Occasional table	16	50	17	GTGB17-1650H17- 	3,107	3,413	2,641	4,738	4,037	2,952
				Shipping wgt	40 lb	40 lb	40 lb	50 lb	50 lb	30 lb
				Cubes	11.7	11.7	11.7	11.7	11.7	11.4

Note: 16"D x 32"W occasional table can be used in-line with lounge units, but are freestanding and do not gang.

TO ORDER PLEASE SPECIFY THE FOLLOWING:

MODEL NUMBER + TYPE	FRAME COLOR	TOP MATERIAL	TOP FINISH (WOOD TOPS ONLY)
			
Note: Type must be specified as part of model number. Wood Veneer W Laminate L Solid Surface S Glass G Field-Installed Top F	Polished Chrome PC \$113 - 16x32 \$142 - 16x50 Brushed Chrome Steel BS \$113 - 16x32 \$142 - 16x50 Black P71 Designer White PJW Matte Gold P8G Silver PR6 Solar Black P8X Titanium P8T Bullseye PJF Regatta P8M	See page 84-85 for required option codes.	

Note: Wood and laminate tops are 1 1/8" thick, rabbeted and inset to leave 1/2" thick edge detail. solid surface and glass tops are 12mm thick, with an inset 3/4" MDF subtop. Field-installed tops receive an inset 3/4" MDF subtop. Wood, laminate, solid surfaces and glass tops all have 1/16" overhang per side.

Example

GTGB17-1632H17-W.PC.NC215.OP			
GTGB17-1632H17-W	PC	NC215	OP
MODEL NUMBER	FRAME COLOR	TOP MATERIAL	TOP FINISH

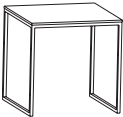
	D	W	H	model number + type	veneer 2	veneer 3	laminate	solid surface	glass	field-installed top
12"D x 18"W Laptop table	12	18	26	GTGB17-1218H26- <input type="checkbox"/>	1,951	2,143	1,659	2,975	2,538	1,853
				Shipping wgt	15 lb	15 lb	15 lb	20 lb	20 lb	10 lb
				Cubes	5.3	5.3	5.3	5.3	5.3	5.2
24"D x 24"W Side table	24	24	24	GTGB17-2424H24- <input type="checkbox"/>	3,283	3,606	2,791	5,007	4,268	3,120
				Shipping wgt	25 lb	25 lb	25 lb	30 lb	30 lb	20 lb
				Cubes	11.4	11.4	11.4	11.4	11.4	11.2

TO ORDER PLEASE SPECIFY THE FOLLOWING:

. . .

MODEL NUMBER + TYPE

FRAME COLOR

TOP MATERIAL

TOP FINISH (WOOD TOPS ONLY)

Note:

Type must be specified as part of model number.
Wood Veneer **W**
Laminate **L**
Solid Surface **S**
Glass **G**
Field-Installed Top **F**

Polished Chrome **PC +\$85**
Brushed Chrome Steel **BS +\$85**
Black **P71**
Designer White **PJW**
Matte Gold **P8G**
Silver **PR6**
Solar Black **P8X**
Titanium **P8T**
Bullseye **PJF**
Regatta **P8M**

See page 84-85 for required option codes.

Note: Wood and laminate tops are 1 1/8" thick, rabbeted and inset to leave 1/2" thick edge detail. solid surface and glass tops are 12mm thick, with an inset 3/4" MDF subtop. Field-installed tops receive an inset 3/4" MDF subtop. Wood, laminate, solid surfaces and glass tops all have 1/16" overhang per side.

Example

GTGB17-1218H26-W.PC.NC215.OP

GTGB17-1218H26-W PC NC215 OP
MODEL NUMBER FRAME COLOR TOP MATERIAL TOP FINISH

CYLINDER OCCASIONAL TABLES

Seating
02/24

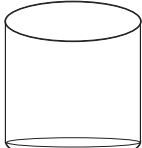
	diameter	H	model number	veneer 2
CYLINDER TABLES 	18	20	GNTOCY1820	2,309
	18	24	GNTOCY1824	2,390
	24	20	GNTOCY2420	2,980
	24	24	GNTOCY2424	3,111
	36	16	GNTOCY3616	3,852

SUNBURST PATTERN OPTION

TOP VIEW

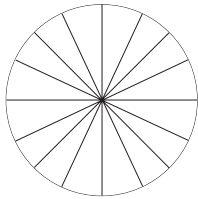

PRODUCT INFO

TO ORDER PLEASE SPECIFY THE FOLLOWING:

<input type="text"/>	<input type="text"/>	<input type="text"/>
MODEL NUMBER	SPECIES & FINISH	VENEER PATTERN

Select veneers:
Cherry
Maple

Standard veneer pattern **NP**
Sunburst pattern **SV (+\$347)**

Please refer to Gunlocke.com
for standard finish options.

Example

GNTOCY1820.NC260.NP

GNTOCY1820	NC260	NP
MODEL NUMBER	FINISH	VENEER PATTERN

	D	W	H	model number	veneer 2
CUBE TABLES	18	18	24	GNTOCB1824	2,861
	24	24	20	GNTOCB2420	3,005
	24	24	24	GNTOCB2424	3,074
	36	36	16	GNTOCB3616	3,852

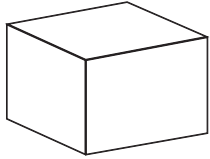

TOP VIEW

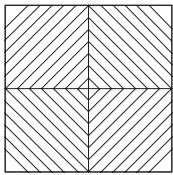

DIAMOND
VENEER OPTION

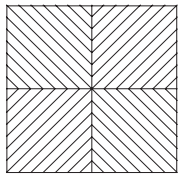

REVERSE
DIAMOND
VENEER OPTION

PRODUCT INFO

TO ORDER PLEASE SPECIFY THE FOLLOWING:

. .

MODEL NUMBER **SPECIES & FINISH** **VENEER PATTERN**

Select veneers:

Cherry
Maple

Standard veneer pattern
Diamond pattern
Reverse diamond

NP
DV (+\$347)
RD (+\$357)

Please refer to Gunlocke.com
for standard finish options.

Example

GNTOCB1824.NC260.NP

GNTOCB1824	NC260	NP
MODEL NUMBER	FINISH	VENEER PATTERN

LETCHWORTH OCCASIONAL TABLES

Seating
02/24

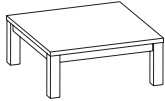
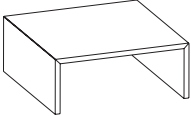
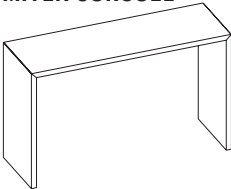
	D	W	H	model number	veneer 2	veneer 3	veneer 4
PARSONS OCCASIONAL 	24	24	21	GABTRT21H2424-WW	2,394	2,636	2,754
	36	36	17	GABTRT17H3636-WW	2,704	2,975	3,111
	42	42	17	GABTRT17H4242-WW	3,014	3,317	3,468
	24	54	17	GABTRT17H2454-WW	2,928	3,222	3,369
MITER OCCASIONAL 	24	24	21	GMBTRT21H2424-WW	6,806	7,488	7,828
	36	36	17	GMBTRT17H3636-WW	2,704	2,975	3,111
	42	42	17	GMBTRT17H4242-WW	3,014	3,317	3,468
	24	54	17	GMBTRT17H2454-WW	2,928	3,222	3,369
MITER CONSOLE 	20	60	36	GMBTRT36H2060-WW	3,372	3,688	3,849

PRODUCT INFO

Tables are shipped in one complete piece and cannot be disassembled. Confirm elevator/doors/hallways for clearance.

TO ORDER PLEASE SPECIFY THE FOLLOWING:

1. MODEL NUMBER
2. FINISH
3. TOP FINISH

See inside front cover for required option codes

Example

GABTRT21H2424-WW.NT629.OP
 GABTRT21H2424-WW NT629 OP
 MODEL NUMBER FINISH TOP FINISH

THIS PAGE INTENTIONALLY LEFT BLANK

Gunlocke®

One Gunlocke Drive
Wayland, NY 14572
800 828 6300

GUNLOCKE.COM

FORM #G1064.A2 (5/24)