

PRICING EFFECTIVE FEBRUARY 2024

# SILEA

---

*Price & Specification Guide*

---

PDF updated May 6, 2024

Gunlocke®

# VENEER 1

## STRATAWOOD FLAT CUT CHERRY

- A. Cinnamon/Biltmore\* EC260
  - B. Lowell Ash\* EC394
  - C. Medium Red\* EC512
  - D. Light\* EC701
  - E. Shaker\* EC774
  - F. Burnished\* EC777
  - G. Clear\* EC700
- (\*Use OP TopFin Only)

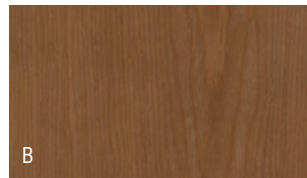

## STRATAWOOD FLAT CUT WALNUT

- H. Florence\* ET579
  - I. Light\* ET601
  - J. Skyline\* ET625
  - K. Nutmeg\* ET629
  - L. Pinnacle\* ET679
  - M. Sumatra\* ET693
  - N. Ebony\* ET509
  - O. Clear\* ET600
- (\*Use OP TopFin Only)

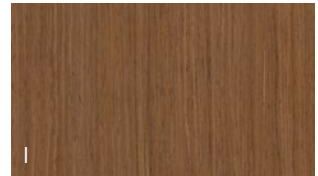
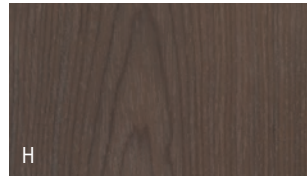
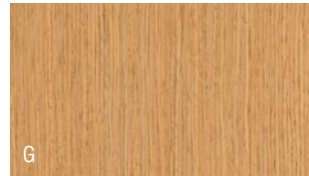

## STRATAWOOD RIFT CUT OAK

- P. Light\* EF301
  - Q. Dark\* EF331
  - R. Phantom Ecu\* EF912
  - S. Fawn Cypress\* EF108
  - T. Clear\* EF300
- (\*Use OP TopFin Only)

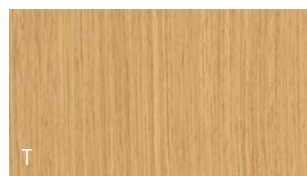
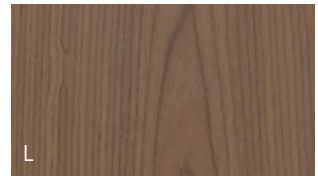
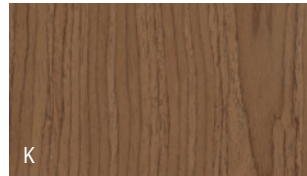
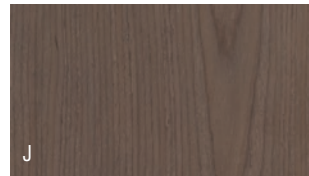

## VENEER 2

---

### NATURAL FC CHERRY

A. Cinnamon/Biltmore	NC260
B. Lowell Ash	NC394
C. Medium Red	NC512
D. Light	NC701
E. Shaker	NC774
F. Burnished	NC777

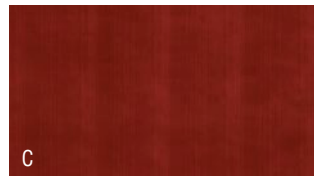
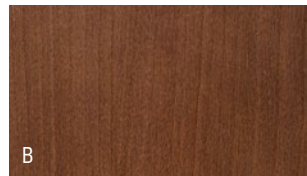
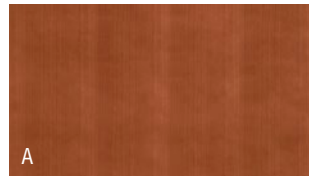

### NATURAL FC MAPLE

G. Natural	NE800
H. Harvest	NE856



### NATURAL FC WALNUT

I. Florence	NT579
J. Light	NT601
K. Skyline	NT625
L. Nutmeg	NT629
M. Pinnacle	NT679
N. Sumatra	NT693
O. Ebony	NT509

(Use OP TopFin Only)

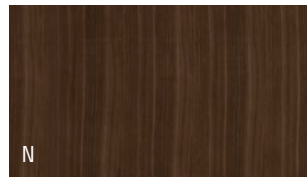
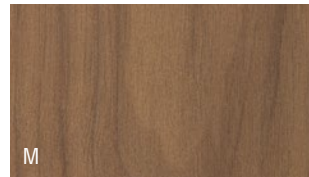
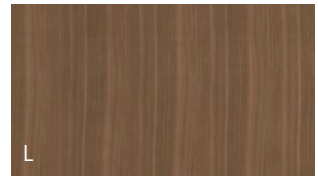
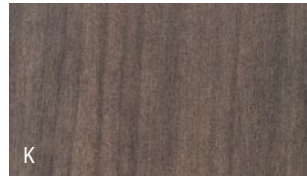
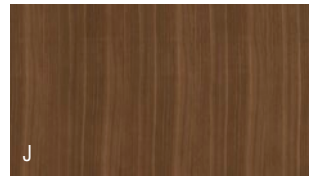
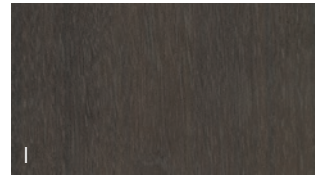

## VENEER 2

### STRATAWOOD CHERRY

	Vertical	Horizontal
A. Cinnamon/Biltmore	SC260	HSC260
B. Lowell Ash	SC394	HSC394
C. Clear	SC700	HSC700
D. Light	SC701	HSC701
E. Shaker	SC774	HSC774
F. Burnished	SC777	HSC777



### STRATAWOOD MAPLE

G. Belair	SE934	HSE934
H. Beigewood	SE878	HSE878
I. Field Elm	SE599	HSE599
J. Clear Maple	SE800	HSE800
K. Harvest	SE856	HSE856
L. Phantom Ecru (Use OP TopFin Only)	SE912	HSE912



### STRATAWOOD WALNUT

M. Florence	ST579	HST579
N. Light	ST601	HST601
O. Skyline	ST625	HST625
P. Pinnacle	ST679	HST679
Q. Sumatra	ST693	HST693



### STRATAWOOD OAK

R. Clear	SF300	HSF300
S. Dark	SF331	HSF331



### STRATAWOOD SILVER OAK

T. Clear	SB100	HSB100
U. Portico Teak	SB150	HSB150

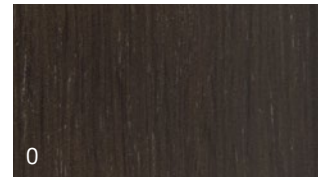
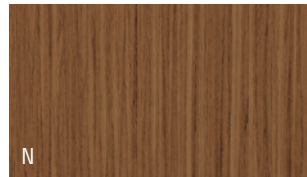

### STRATAWOOD WASHED WALNUT

V. Clear	SW600
W. Smoked Onyx	SW697
X. Smoked Grey	SW612

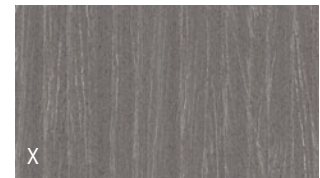
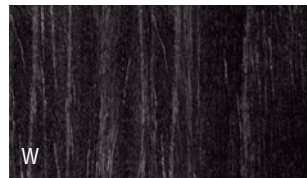
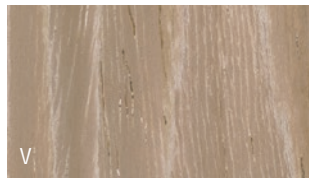
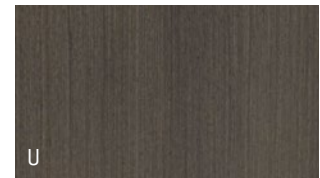
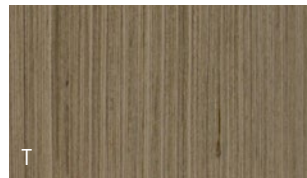
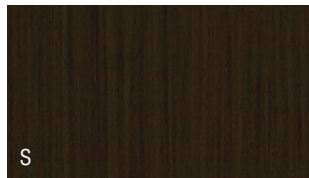
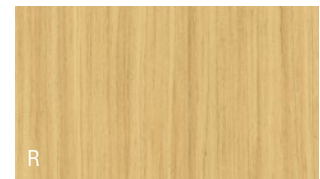
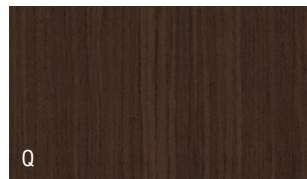
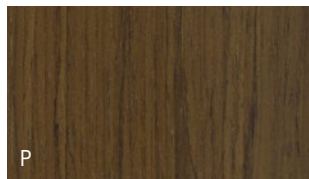

## VENEER 3

### NATURAL QC WALNUT

A. Florence	QT579
B. Light	QT601
C. Skyline	QT625
D. Nutmeg	QT629
E. Pinnacle	QT679
F. Sumatra	QT693
G. Ebony	QT509
(Use OP TopFin Only)	

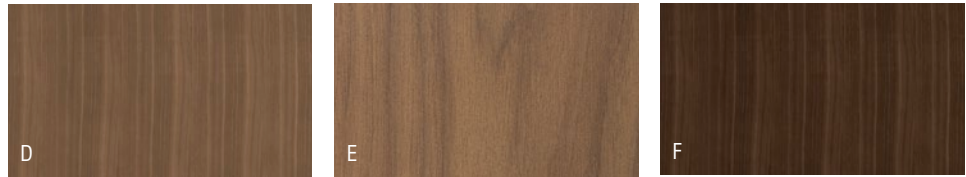
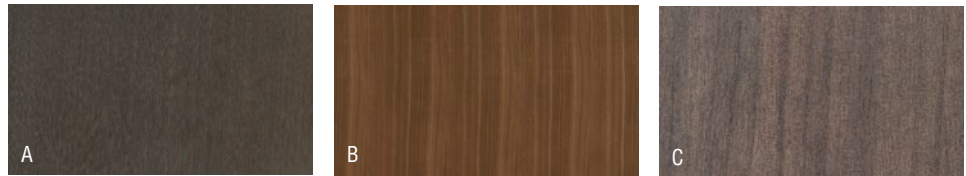

### NATURAL RIFT CUT OAK

H. Light	RF301
I. Dark	RF331
J. Phantom Ecrú	RF912
(Use OP TopFin Only)	
K. Fawn Cypress	RF108

## LAMINATES

### WOODGRAIN

A. Lowell Ash	LLA1
B. Natural Recon	LNR1
C. Phantom Ecrú	LPE1
D. Portico Teak	LPT1
E. Skyline Walnut	LSW1
F. Beigewood	LWBE
G. Field Elm	LWFE
H. Pinnacle Walnut	PINC
I. Fawn Cypress	LFC1
J. Natural Maple	LWD
K. Harvest Maple	C
L. Shaker Cherry	LW7C
M. Biltmore Cherry	COGN
N. Florence Walnut	LFW1
O. Kingswood Walnut	LKI1
P. NeoWalnut	LNU1
Q. Veranda Teak	LVT1

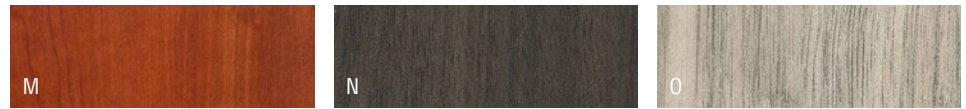

### SOLID

R. Designer White 15051	LDW1
S. Loft	LM11
T. Flint	LM16
U. Black	P

## GLASS

- |  |      |
|--|------|
| A. Ice White                                   | GWH2 |
| B. Black                                       | GBK2 |
| C. Muslin                                      | GML2 |
| D. Flint                                       | GFL2 |
| E. Loft  | GLO2 |
| F. Beige                                       | GBG2 |
| G. Clear Ribbed Glass<br>(For Panel Legs Only) | RB   |



## SOLID SURFACE

- |                     |      |
|---------------------|------|
| A. Designer White   | SDW4 |
| B. Frosty White     | SFW3 |
| C. Night Stars      | SNS5 |
| D. Masoned Concrete | SMC2 |
| E. Monte Amiata     | SMA1 |

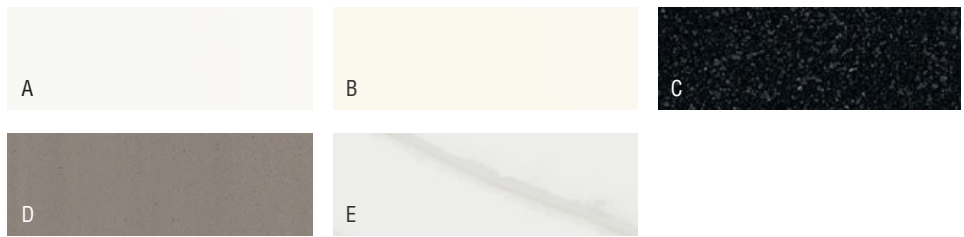

## METAL

- |                   |     |
|-------------------|-----|
| A. Black          | P71 |
| B. Silver         | PR6 |
| C. Matte Gold     | P8G |
| D. Pyrite         | PJE |
| E. Designer White | PJW |

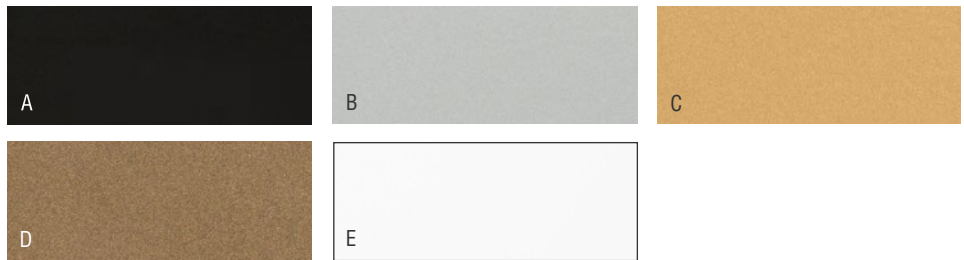

General Information		Modular Casegoods	147-218
Conditions of Sale...	2	Desk Worksurface	148-151
GSA Terms & Conditions...	3	Desk Pedestals	152-153
Warranty...	5	Desk Legs	154-158
Delivery Information...	6	Desk   Runoff Modesty Panel	159-164
Reference	7-9	24 & 30 Depth Worksurfaces	165-168
Pulls   Pull Locations	10-11	24 & 30 Depth Pedestals	169-198
Locks & Keying	12-13	Modular End Panel	199
Product Reference	15-48	Modular L Supports	200
Statement of Line	16-23	Support & Ped Backs	201-211
Features + Advantages	24-25	Layers W/ Laptop Drawer	212
Technical Specs	26-28	Round Tops	213
Filing Reference	29-30	Guitar Pick Top	214
Height Reference	31	Layers Box & Brackets	215-217
Wire Management	32	Modular Pedestal Cushion	218
Grommets	33	Cantilever Height Adjustable Desks and	
Details	34	Smart Storage	219-233
Height Adjustability	35	Cantilever Height Adjustable Desks	220-223
Storage	36	Smart Pedestals	224-225
Surface Mount Cabinets	37	Accessory Trays and Bins For Smart Pedestals	226
Dimensions	38-47	False Pedestals	227
Grain Direction Specification	48	Smart Closets	228-229
Unitized Casegoods	49-76	Smart Lockers	230-231
Double Pedestal Desk	50	Smart Pedestal Power Units For Grommet Cutout	232
Single Pedestal Desk	51-52	Solidwood Desktop Accessories	233
Runoff Desks	53	Storage	235-265
Layers Runoff W/ Layers Box / Laptop Drawer	54-55	Bookcases	236
Double Pedestal Credenza	56	Bookcase / Closet	237
Single Pedestal Credenza	57	Lateral Files	238-239
Full Bank Credenza	58-59	Closets	240-244
Returns	60	Storage Box / Utility Cabinet	245-257
Rectangular Table Desk & Extensions	61-63	Side Access Storage Locker	258-261
Runoffs	64	Mobile Pedestal	262-263
Rectangular Runoff	65	Storage External Tops	264-265
Layers Rectangular Runoff W/ Layers Box /		Wall Mount	267-302
Laptop Drawer	66-67	Cabinets	268-277
Ellipse Table Desk	68	Wall Mount Wall Overhead	278-279
Layers Ellipse Runoff W/ Layers Box	69	Tackboard in Tackzone	280-283
Arc Boat Table Desk	70	Tackboard to Top of Overhead	284-289
Layers Arc Boat Runoff W/Layers Box	71	Glass Whiteboard from Floor	290
Sightline Runoff	72	Wall Mount Wall in Tackzone	291-294
Layers Sightline Runoff W/ Layers Box /		Magnetic Wood to Top of Overhead	295-299
Laptop Drawer	73-74	Shelving for Wall Mount Wall	300-301
Layers Cockpit Runoff W/ Layers Box	75	Floating Shelves	302
Media Top	76	Surface Mount	303-316
Height Adjustable	77-121	Cabinets	304-308
Height Adjustable Split-Top Desks	78-81	Towers	309-314
Freestanding Desk / Extension	82-87	Tackboard	315
Credenza	88-91	External Tops	316
Bridge	92-93	Workwall	317-322
Return	94-97	Workwalls	318-319
L Shape Height Adjustable Spec Tips	98	Workwall Tackboard	320
L Shape Height Adjustable	99-114	Lounge Level Media Unit	321-322
Shroud for T-Base	115	Accessories	323-338
Layers Bookcase	116	LED Tasklighting	324
Height Adjustable Base	117	Trough Accessories	325-326
Height Adjustable Tops	118	Personal Corner	327
Wall Mount Cantilever Bracket	119	Drawer Filing Rails & Reinforcement Bars	328
Mixed Material Telescoping Height Adjustable	120	Magnets	329
Replacement Height Adjustable Keypads	121	Counterweights	330
Welcome Desk	123-146	Wire Manager	331
Working with Welcome Desks	124-127	Center Drawer	332
Welcome Desk Typical	128-129	Pencil Tray	333
Advanced Height Adjustable Welcome Desk	130-133	Grommet	334
Advanced Fixed Height Welcome Desk	134-135	Power Unit	335-337
Fixed Height Welcome Desk	136-137	3" Dia Field Installed Grommet	338
Welcome Desk Shell	138-139	Grade Fabric Pricing	340-343
Welcome Desk Bridge	140	Weights + Cubes	344-382
Welcome Desk Returns	141		
Welcome Desk Credenzas	142		
Waterfall Transaction Tops	143		
Transaction Tops	144		
Welcome Desk Tackboard	145		
In/Out Storage Unit	146		

**INTRODUCTION**

The Gunlocke Company is dedicated to providing the finest products and service possible. This price list reflects that commitment. Included is a current listing of our casegood models.

Seating and Lounge are presented in a separate price list. Contact your Gunlocke Customer Services Representative for more information, (800) 828-6300.

Designed for easy use, each page of this price list, and the inside front cover fold out provide all information required to order a product correctly. Should additional information be needed, contact your Gunlocke customer service representative.

**PRICING**

Prices shown cover standard product specifications. Any changes or alterations, other than those listed, will be subject to an additional charge. Prices include cartoning and freight. Authorization and pricing must be secured in advance for orders or contracts calling for large quantities, indefinite quantities, or extended delivery dates. Prices are subject to change without notice; the most current prices are published on <http://www.gunlocke.com>.

**ACKNOWLEDGEMENT**

Each order will be acknowledged by Gunlocke. Customers should check each acknowledgment for accuracy and immediately notify Gunlocke of any discrepancies. The printed acknowledgment is the final agreement between The Gunlocke Company and the customer, superseding all previous communications regarding the order.

**SPECIFICATION CHANGES**

Gunlocke reserves the right to change specifications for the improvement of products at any time, without notice.

**ORDER CHANGES**

Gunlocke is not required to accept changes in orders after confirmation. Reasonable changes are subject to additional charges for labor, material and administrative costs.

Order changes of acknowledgment may result in re-scheduling of product.

**RETURNED MERCHANDISE**

No merchandise may be returned without prior authorization.

**SHOWROOMS**

For all showroom locations and tour information, please reference the showrooms page online at: [www.gunlocke.com/inspiration/showrooms](http://www.gunlocke.com/inspiration/showrooms)

**CANCELLATIONS**

Cancellation of orders cannot be accepted since every order is manufactured according to customer specifications.

**STORAGE**

If delivery cannot be made and products are ready, Gunlocke will transfer products to a storage facility and products will be invoiced at that time. The customer is responsible for storage charges and assumes and bears all risks associated with the storage of that product.

**TERMS**

Net 30 days from date of invoice. A service charge of eighteen percent (18%) per year or .0004931% per day, compounded monthly, will be added to balance due beyond the thirtieth day. Products are shipped FOB factory, freight prepaid and allowed. Title passes to purchaser and Gunlocke's responsibility ceases when shipment is accepted for transportation by a carrier. A full explanation of all payment terms is found on order and invoice forms.

**ORDERING**

To expedite order entry and to assure proper service, email or fax all orders directly to:

**The Gunlocke Company**

Attn: Order Entry  
One Gunlocke Drive  
Wayland, New York 14572

585-728-5111  
585-728-8350 FAX  
800-828-6300  
[www.gunlocke.com](http://www.gunlocke.com)

Gunlocke will not be responsible for duplicate orders if purchase orders are left unmarked.



## ORDERING INFORMATION

**1a. Intended use:** The furniture on this schedule is intended for use by Government executives (or equivalent military rank) in the Executive, Judicial and Legislative Branches of the Federal Government. To help customers make a good purchasing decision based on their needs and budget, GSA has established four grades of furniture. Grade (1) includes furniture that tends to be the most expensive on this schedule, grade (2) furniture tends to be more moderately priced and grades (3) and (4) furniture tend to be affordably priced when compared to grades (1) and (2). Some pieces of furniture on this schedule may be significantly higher in price than GSA Traditional and Contemporary Executive Special Order Program furniture. The ordering agency or service is responsible for determining furniture appropriate for use in its offices which will fit within its budget and comply with applicable Federal or internal agency procurement regulations. Please see reverse for GSA terms and conditions.

## GSA/FEDERAL CONTRACT INFORMATION:

Model numbers identified with the following verbiage "When purchased separately without a configurable TAA compliant end product, not on GSA contract" is to mean that these configurable parts or components:

- Have no functionality or capability without being integrated into an end product; and
- Are considered Open Market if purchased without a configurable TAA compliant end product.

**Grade 1** All exposed solid parts such as top rims, base rails etc. (except decorative accents and inlays) shall be the same species as the face veneer. Top and bottom edges of drawer fronts shall be solid wood in the same species as the face veneers. Drawer sides and backs shall be solid wood.

**Grade 2** Exposed wood panel trim and trim on tops shall be the same wood species as the face veneer on the top. Some or all other exposed solid parts, such as base rails can be an alternative wood species (such as poplar or gum) different from the face veneers. Exposed, finished engineered wood core material such as MDF is acceptable only for the edges of drawer fronts. Drawer sides shall be solid wood or veneer core plywood/laminated construction. Silea is grade 2.

**Grade 3** Most or all exposed solid parts can be an alternative wood species (such as poplar or gum), different from the face veneers. Exposed, finished engineered wood core material such as MDF is acceptable only for the edges of drawer fronts. Drawer sides shall be solid wood or veneer core plywood/laminated construction. Credentials, and all tables are grade 3.

**Grade 4** Most or all exposed solid parts can be an alternative wood species (such as poplar or gum), different from the face veneers. Exposed, finished engineered wood core material such as MDF is acceptable only for the edges of drawer fronts. Drawer sides shall be composite wood material construction such as MDF. Trio is grade 4.

## ITEMS ON GSA CONTRACT

Please note, in order to verify if an item is on GSA Contract or is "Open Market," please use Compass quoting which is updated in real time with all GSA contract changes. If you need additional assistance, please contact your local sales representative.



## 12 YEAR WARRANTY

Subject to the limitations set forth below. The Gunlocke Company warrants to the original purchaser all product in this price list to be free from defects in material and workmanship for a twelve year period from the date of shipment. This 12-year warranty applies to all products sold and installed by a Gunlocke authorized agent for normal commercial single shift service. Gunlocke will repair, or at its option, replace defective merchandise, free of charge. The following components not manufactured by Gunlocke have the following warranties:

- **High wear components** such as casters and glides are warranted for five years after date of shipment to original owner.
- **Electrical components** are warranted 10 years from date of manufacture with exception of lamps and ballasts which are not warranted. This includes Fluorescent Tasklights.
- **LED tasklights** are warranted for 3 years from date of shipment to original owner.
- **Drawer suspensions** are warranted for lifetime of product after shipment to original owner.
- **Personal corners** including covering (leather) are warranted for three years of single shift and normal use after shipment to original owner.
- **Height adjustable electrical components** are warranted for 7 years of single shift and normal use after shipment to original owner.

Any non-standard material selected by the customer is not warranted. Neither does this warranty apply to damage resulting from accident, alteration, or misuse, as well as damage from normal wear and tear such as dents, nicks, scratches, fading and improper maintenance. That is, Gunlocke's warranty is only valid if products are given proper use and care. Gunlocke assumes no responsibility for product damages resulting from improper installation or user modification.

## WOOD FURNITURE

Wood owes its inherent beauty to variations in color, grain, and texture, and therefore, these variations are not considered defects. There may be minor variations from one piece of furniture to the next even though they are finished at the same time. Exposure to light and the aging process will cause a darkening of natural wood products. Light finishes on wood products do not mask the natural characteristics of wood. The Gunlocke Company does not guarantee the exact matching of grain, pattern, and color.

These finishes do not cover any of the natural characteristics of the wood, including nature's colorations, pitch pockets, and the variations of steam-bent wood. Merchandise will not be replaced because of these natural variations.

It is expressly understood and agreed that the buyer's sole and exclusive remedy for any and all losses or damages resulting from nonconforming goods, or from any other cause, shall be repair or replacement of defective parts, and that Gunlocke shall not be liable for damages or injury to persons or property, nor for replacement of the entire commercial unit, if repair or replacement of defective parts can reasonably render the unit conforming.

All warranty claims must be made in writing by the original owner. Owner may be required to produce the invoice or other evidence to establish that a claim is within the warranty period. Warranty claims may be submitted on the Gunlocke website.

As stated and illustrated on the website, serial numbers are required to process a warranty claim. No person, firm or corporation is authorized to assume for Gunlocke any liability in connection with the sale or installation of Gunlocke products except as stated above.

All other warranties, expressed or implied, are excluded. Gunlocke shall not be liable for incidental or consequential damages of any sort.

Within the Continental USA, all orders above \$20,000 list are shipped FOB factory, freight prepaid and allowed. All orders less than \$20,000 list will be subject to a \$200 net freight charge. Products shipped to Alaska and Hawaii FOB factory, freight prepaid and allowed to port of embarkation. Customer is responsible for freight charges from port of embarkation to final destination.

An anticipated shipping date is indicated on the order acknowledgment. Gunlocke cannot accept responsibility for shipping delays caused by outside sources or unforeseen problems. Delay of shipments requested by customers must be approved by Gunlocke. Any resultant storage charges will be charged to the customer.

Gunlocke may await completion of the entire order and ship all at once or may make partial shipments from time to time at its sole discretion unless the customer requests in writing that partial shipments are needed and Gunlocke approves the specific shipping schedule. Additional charges may apply.

Gunlocke is not liable for any delay or failure to deliver or perform due to strikes, lock-outs, or other labor or transportation difficulties, delay of sources or supply, accidents, fires, acts of God, or any other causes of like or unlike nature beyond the control of Gunlocke.

### LIABILITY

Gunlocke products and their packaging are tendered to a transportation company only after passing rigid quality control inspection. At that time, title to the product is passed to the purchaser. However the transportation company assumes all liability from acceptance of shipment through its delivery. That is, Gunlocke's liability ceases at the time of shipment.

### FILING OF CLAIMS

All claims for damage or loss must be submitted via our website within 15 days after receipt of merchandise. Do not return freight damaged merchandise to Gunlocke. Follow the steps below to expedite processing and resolution of claims.

### For Visible Damage

1. Make damage notation on delivery receipt and have driver sign. Do not reject or refuse the shipment.
2. Immediately contact Gunlocke Traffic Department at 585-728-8268.
3. Hold damaged carton and all interior packing for carrier's inspection. These materials will be needed to substantiate the claim.

### For Concealed Damage

1. Open cartons within 15 days of receipt and inspect.
2. Follow steps 2, and 3 as listed under Visible Damage.
3. Do not remove product from delivered destination.

### For Loss

1. Be sure loss notation is made on delivery receipt and have driver sign.
2. Contact Gunlocke Distribution at 585-728-8268.

Should transportation company seek to limit its liability on concealed, loss, or damage claims, please contact Gunlocke's traffic department. After a thorough investigation of the claim, the traffic department will provide you with guidance in corresponding with the carrier.

Returned merchandise, regardless of delivery method, will not be accepted unless specifically authorized by Gunlocke.

### For Damage or Loss of Parcel Post or UPS Shipment

Notify Gunlocke distribution immediately at 585-728-8268.

### NORMAL DELIVERY

All normal ground transportation by Gunlocke will be made on a dock-to-dock basis. The Gunlocke traffic department will determine the recommended method of shipment according to the ship to destination. If the delivery on a shipment takes longer than 2 hours to be unloaded, an additional charge will be billed at \$60/hour at 15 minute increments. Gunlocke reserves the absolute right to determine the method of shipping unless special delivery instructions have been previously approved.

**Gunlocke will make every effort in honoring delivery requests as stated on orders. However, the Company shall have no liability for failure to deliver, perform or delay in delivery due to any cause outside the control of Gunlocke. The Company assumes no liability for costs incurred due to delayed or late deliveries.**

If a guaranteed delivery time is needed please call Gunlocke Traffic Department at 585-728-8268 for a quote as additional charges will apply. Weekend or after hours deliveries are subject to additional charges.

### WEEKEND DELIVERY

A \$500 charge will apply on weekend delivery after 3:00 PM Friday through Sunday evenings.

### DROP SHIP / JOB SITE DELIVERY

Orders under \$50,000 list will incur a \$125 charge for ship to locations other than a designated dealer warehouse.

### INSIDE DELIVERY

Inside delivery must be noted on order. A minimum \$100 charge will apply.

### SPECIAL DELIVERY

Please contact the Gunlocke traffic department for special delivery services such as inside delivery, weekend or after hour deliveries, reconsignment or other special needs. These are billable services.

**Gunlocke will make every effort in honoring delivery requests as stated on orders. However, the Company shall have no liability for failure to deliver, perform or delay in delivery due to any cause outside the control of Gunlocke. The Company assumes no liability for costs incurred due to delayed or late deliveries.**

### DOCK RESTRICTIONS

Gunlocke trailers are 53' x 102"; when attached to truck cab the total length is 75'. If delivery dock will not accommodate trucks of this sizes, the Gunlocke traffic department must be contacted prior to shipping. Alternate arrangements can be made; additional charges may apply.

## veneers

---

All exposed wood surfaces utilize flat cut, rift cut, or straight grain Stratawood (FSC reconstituted veneer), flat cut Cherry, Maple, Walnut veneers, quarter cut Walnut, or Rift Oak veneers. Stratawood veneer is made from rapidly renewable wood veneer, which provides a repeatable grain pattern. Stratawood veneers are available in flat cut Cherry, flat cut Walnut, or Rift Oak at veneer 1 pricing and in straight grain Cherry, Maple, Walnut, Oak, Silver Oak, or Washed Walnut at veneer 2 pricing. Veneers can be specified in vertical or horizontal orientation. All veneers are carefully selected and matched to assure balance and consistency.

## Specialty Finishes

---

- Submit a color sample block (minimum size 3" x 3") to Gunlocke so that a finish formulation can be developed to match the special finish and color.
- Review the approval sample provided by Gunlocke.
- Written approval and sign off is required for Gunlocke Customer Service.
- Once written approval and sign off is received, the special finish order will be acknowledged.

**Note:** See our Website at [Gunlocke.com](http://Gunlocke.com) for special finish request forms.

### All Casegoods & Tables Purchase Orders:

- 10% list upcharge per wood unit to specified veneer option receiving special finish.
- \$250 net formulation fee for special finish.

### veneer 1

---

**Stratawood Flat Cut Cherry**

---

**Stratawood Flat Cut Walnut**

---

**Stratawood Rift Cut Oak**

---

### veneer 2

---

**Natural Flat Cut Cherry**

---

**Natural Flat Cut Maple**

---

**Natural Flat Cut Walnut**

---

**Stratawood Straight Grain Cherry**

---

**Stratawood Straight Grain Maple**

---

**Stratawood Straight Grain Walnut**

---

**Stratawood Straight Grain Oak**

---

**Stratawood Straight Grain Silver Oak**

---

**Stratawood Flat Cut Washed Walnut**

---

### veneer 3

---

**Natural Quarter Cut Walnut**

---

**Natural Rift Cut Oak**

---

# REFERENCE

## Materials & finishes

Silea

02/24

The plastic laminate offering includes 11 woodgrain and 3 solid laminate options from Wilsonart. Laminate tops are high-pressure laminate (HPL), and chassis/storage components are thermally fused laminate (TFL). Laminate edgebands are 2mm thick and are color matched to the laminate option chosen.

Laminates	Description	Option Code	Supplier Name	Supplier Code	Edgeband	Gunlocke Finish Match*
<b>WOODGRAIN</b>	Lowell Ash	<b>LLA1</b>	Wilsonart	7994-12	ABS	NC394
	Natural Recon	<b>LNR1</b>	Wilsonart	7996-12	ABS	RF301
	Phantom Ecru	<b>LPE1</b>	Wilsonart	8212-12	ABS	RF912
	Portico Teak	<b>LPT1</b>	Wilsonart	8210K-12	ABS	SB150
	Skyline Walnut	<b>LSW1</b>	Wilsonart	7964K-12	ABS	QT625
	Field Elm	<b>LWFE</b>	Wilsonart	7999-38	ABS	SE599
	Beigewood	<b>LWBE</b>	Wilsonart	7850-60	ABS	SE878
	Pinnacle Walnut	<b>PINC</b>	Wilsonart	7992-38	ABS	NT679
	Fawn Cypress	<b>LFC1</b>	Wilsonart	8208K-12	ABS	N/A
	Natural Maple	<b>LWD</b>	Wilsonart	11021-38	ABS	NE800
	Harvest Maple	<b>C</b>	Wilsonart	7953-38	ABS	NE856
	Shaker Cherry	<b>LW7C</b>	Wilsonart	7935K-07	ABS	NC774
	Biltmore Cherry	<b>COGN</b>	Wilsonart	7924K-07	ABS	NC260
	Veranda Teak	<b>LVT1</b>	Wilsonart	8209K-12	ABS	SB100
	Kingswood Walnut	<b>LK11</b>	Wilsonart	8218-38	ABS	N/A
	Florence Walnut	<b>LFW1</b>	Wilsonart	7993-38	ABS	N/A
Neo Walnut	<b>LNU1</b>	Wilsonart	7991-38	ABS	N/A	
<b>SOLID</b>	Designer White 15051	<b>LDW1</b>	Wilsonart	15051-60	ABS	WPSW
	Loft	<b>LM11</b>	Wilsonart	15034-60	ABS	WPLF
	Flint	<b>LM16</b>	Wilsonart	10592-38	ABS	WPFT
	Black	<b>P</b>	Wilsonart	1595-60	ABS	N/A
<b>GLASS</b>	Ice White	<b>GWH2</b>				
	Black	<b>GBK2</b>				
	Muslin	<b>GML2</b>				
	Flint	<b>GFL2</b>				
	Loft	<b>GLO2</b>				
	Beige	<b>GBG2</b>				
	Clear Ribbed Glass (For Panel Legs Only)	<b>RB</b>				
<b>SOLID SURFACE</b>	Designer White	<b>SDW4</b>				
	Frosty White	<b>SFW3</b>				
	Night Stars	<b>SNS5</b>				
	Masoned Concrete	<b>SMC2</b>				
	Monte Amiata	<b>SMA1</b>				

\* See cross reference above for Gunlocke wood finish match. Although these are good matches, they are not exact matches due to grain pattern and sheen variation from laminate to veneer. They coordinate throughout a floorplate, but we recommend they not be utilized in the same office.

**Note:** Gunlocke does not guarantee an exact finish match to the plastic laminates listed above.

**EDGE DETAIL**

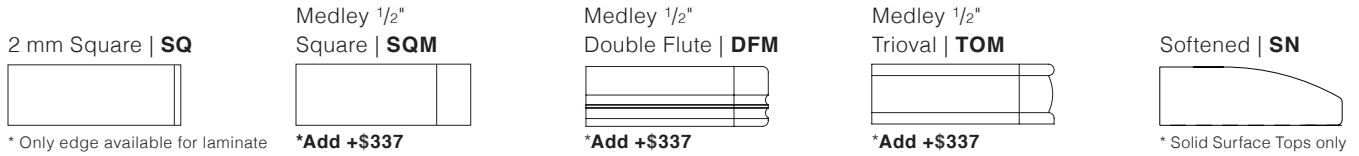

**FSC CERTIFIED**

Standard - No FSC	<b>X</b>
FSC Certified (5% upcharge)	<b>F</b>

**FSC TACKBOARD**

FSC Mixed Credit (Upcharge – See Tack & Cushion Pricing)	<b>FSC</b>
FSC Not Required	<b>NR</b>

**TOP GRAIN DIRECTION**

Long Grain	<b>VLG</b>
Short Grain	<b>VST</b>

• Laminate tops optional grain up to 60", above 60" tops are long grain standard.

**DRAWERS**

Vinyl Wrapped, with Soft Close suspension	<b>VW</b>
---	-----------

**BACK PANEL**

No Back Panel	<b>BN</b>
Back Panel Included	<b>BY</b>

**POWER UNIT COLOR**

Black	<b>BK</b>
Silver	<b>SV</b>
White	<b>WH</b>

**POWER UNIT COLOR (For Lounge Level Media)**

Black Std Plug	<b>BKSP</b>
Black Hardwire	<b>BKHW</b>
Silver Std Plug	<b>SVSP</b>
Silver Hardwire	<b>SVHW</b>
White Std Plug	<b>WHSP</b>
White Hardwire	<b>WHHW</b>

**GLASS COLOR**

Ice White	<b>GWH2</b>
Black	<b>GBK2</b>
Muslin	<b>GML2</b>
Flint	<b>GFL2</b>
Loft	<b>GLO2</b>
Beige	<b>GBG2</b>
Clear Ribbed (panel leg insert only)	<b>RB</b>

**LOCKS**

Locks Yes, Random Matte Silver Keying (Factory Installed)	<b>LYSTD</b> (Add +\$158)
Locks Yes, Omit Lock Core (Field Installed)	<b>LYOMT</b> (Add +\$158)
Locks No	<b>LN</b>

**KEYING**

Random Matte Silver Keying (Factory Installed)	<b>STD</b>
Omit Lock Core (Field Installed)	<b>OMT</b>

**HARDWARE COLOR**

Black	<b>P71</b>
Silver	<b>PR6</b>
Matte Gold	<b>P8G</b>
Pyrite	<b>PJE</b>
Designer White	<b>PJW</b>

**HEIGHT ADJUSTABLE BASE COLOR (METAL T BASES)**

Black (P71)	<b>BK</b>
Silver (PR6)	<b>SV</b>
Designer White (PJW)	<b>PJW</b>

**MAGNETIC ACCESSORY**

White	<b>AWH</b>
Black	<b>ABK</b>
Muslin	<b>AML</b>

**PERSONAL CORNER**

Leather	White	<b>CWH</b>
	Black	<b>CBL</b>
	Chocolate	<b>CCH</b>
Vinyl	White	<b>VWH</b>
	Black	<b>VBL</b>
	Chocolate	<b>VCH</b>

**CUSHION UPHOLSTERY**

Fabric	<b>COM-G27</b>
Leather	<b>COL-L5</b>



**TASKLIGHT CORD GROMMET (For Surface Mount Cabinets)**

Grommet Included	<b>WY</b>
Grommet No	<b>WN</b>

**MODESTY PANEL**

Modesty No	<b>MN</b>
Modesty Yes	<b>MY</b>

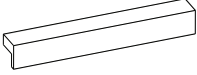
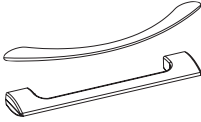
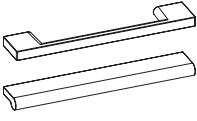
## METAL PULL

Silea Black (P71)	<b>PP71</b>		<b>SILEA</b>
Silea Silver (PR6)	<b>PPR6</b>		
Silea Matte Gold (P8G)	<b>PP8G</b>		
Silea Pyrite (PJE)	<b>PPJE</b>		
Silea Designer White (PJW)	<b>PPJW</b>		
Medley Arch Black (P71)	<b>HARB</b>		<b>MEDLEY ARCH</b>
Medley Arch Silver (PR6)	<b>HARS</b>		<b>MEDLEY ARETTE</b>
Medley Arette Black (P71)	<b>HATB</b>		
Medley Arette Silver (PR6)	<b>HATS</b>		
Trio Linear Black (P71)	<b>HLEB</b>		<b>TRIO LINEAR</b>
Trio Linear Silver (PR6)	<b>HLES</b>		<b>TRIO BAR</b>
Trio Bar Black (P71)	<b>HBRB</b>		
Trio Bar Silver (PR6)	<b>HBRS</b>		
Modern Black (P71)	<b>MP71</b>		<b>MODERN</b>
Modern Silver (PR6)	<b>MPR6</b>		
Modern Matte Gold (P8G)	<b>MP8G</b>		
Modern Pyrite (PJE)	<b>MPJE</b>		
Modern Designer White (PJW)	<b>MPJW</b>		

Integral pulls are available as a standard option in wood only.

## INTEGRAL PULL

Integral Pull /Touch Latch Doors **FPW**  
(add \$225 per unit)

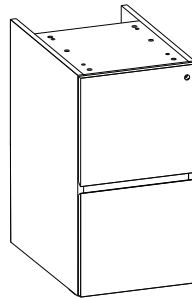

The Silea style metal pull is available in 5 metal finish colors - Silver, Black, Pyrite, Matte Gold, and Designer White. Pulls have the ability to be placed left, right or center with the same drawer front and pull hardware. Pulls are 6" less than the drawer front size with the exception of a 9" pedestal which comes with a 9" pull. Note: This applies to the Silea style pull only. This does not apply to the Arch, Arette, Linear, Bar, or Modern pulls.

CENTERED

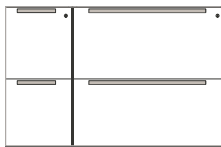

CONTINUOUS



LEFT ALIGNED

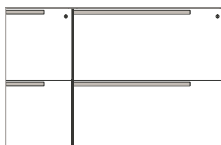

RIGHT ALIGNED

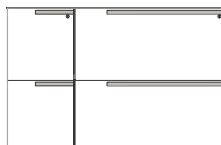

### Choice.

The Silea pull enables you to select drawer pull orientation at the time of installation. Maximum flexibility.



CLOSET LOCATIONS

PEDESTAL LOCATIONS

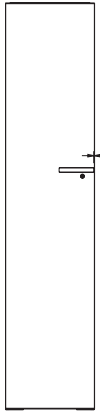

SILEA

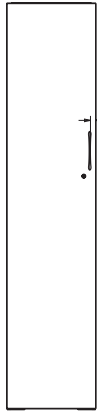

ARCH

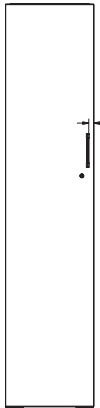

ARETTE

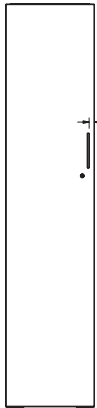

LINEAR

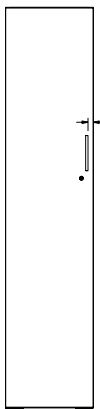

BAR

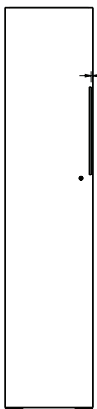

MODERN

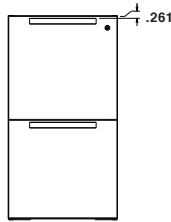

SILEA

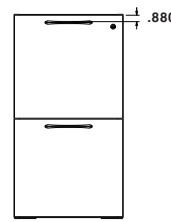

ARCH

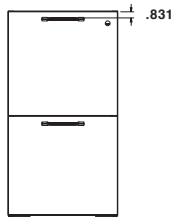

ARETTE

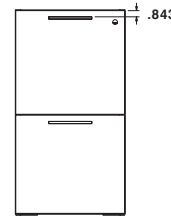

LINEAR

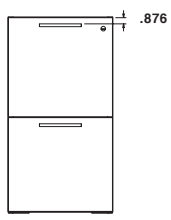

BAR

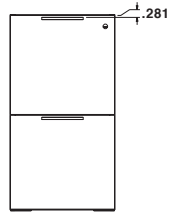

MODERN

Locks are standard on all below worksurface storage units. Closets and overhead storage are optional locking.

## STANDARD OPTIONS

---

- **Random Keying:** Key(s) arbitrarily assigned and installed at the factory. Factory installed locks are silver.

**Note:** When the random option is selected, some units may be shipped with the same key number.

- **Omit Lock Core:** The factory will omit lock cores. Removable lock core kits with specific key numbers must be ordered to facilitate keying alike in the field. A lock program must be specified. Field installed locks are available in Matte Silver, Black, Pyrite, Matte Gold, and Designer White.

## KEYING

---

Random Matte Silver Keying (Factory Installed)

**STD**

Omit Lock Core (Field Installed)

**OMT**

(If option is chosen, a field installed lock program must be specified)

## LOCK PROGRAM (FIELD INSTALLED ONLY)

---

Random Keying

**X**

Specified Keying

**X101 - X225**

Sequential Keying

**SEQ/101 - SEQ/225**

## KEYING COLOR (FIELD INSTALLED ONLY)

---

Matte Silver

**MTS**

Black

**BLK**

Matte Gold

**MGD**

Pyrite

**PYT**

Designer White

**PJW**

### REPLACING LOCK CORES

- Lock must be in the unlocked position.
- Insert core removal key and pull core straight out.
- Insert new core with core removable key, hold core into lock and withdraw core removal key.
- Retain original core for future use.

For field installed locks, the "Omit Lock Core" option must be chosen. Then, specify lock model based on total quantity of lock cores within each office. To ensure ease of ordering for a variety of situations, lock cores can be specified in 3 ways – Random, Specified or Sequential.

LOCKING MODELS	DESCRIPTION	LIST
GLKFE1	1 core, 2 keys	\$17
GLKFE2	2 core, 2 keys	\$22
GLKFE3	3 core, 2 keys	\$27
GLKFE4	4 core, 2 keys	\$31
GLKFE5	5 core, 2 keys	\$36

**Note:** When purchased separately without a configurable TAA compliant end product, not on GSA contract.

**Note:** One core removal key minimum per order. One additional core removal key per 25 lock cores will be shipped.

### MASTER KEY

One key available to authorized dealers **GLKMSTR \$10**

**Note:** When purchased separately without a configurable TAA compliant end product, not on GSA contract.

**KEY NUMBERS 101-225 ARE AVAILABLE.**  
Orders without key numbers will be specified at random.

### RANDOM KEYING (FIELD INSTALLED)

The Random Keying option is provided for instances where there are multiple orders or phases to a project and the offices need to be keyed alike but the key numbering is not required. With the random keying option, key numbers are not specified. However, the core kits will be in sequential order from a random starting point.

### SPECIFIED KEYING (FIELD INSTALLED)

The Specified Keying option is provided for instances where there is a specific key number desired for all of the cores ordered.

### SEQUENTIAL KEYING (FIELD INSTALLED)

The Sequential Keying option is provided for instances when there are multiple orders or phases to a project and it is imperative that key numbers are not duplicated.

### RANDOM KEYING EXAMPLE

- There are 18 offices which have 3 black locks that need to be keyed alike, but the key number is not important.

Model String:

**GLKFE3. BLK. X. 18**  
*Model Color Program # of Offices*

### SPECIFIED KEYING EXAMPLE

- There are 6 offices which have 2 silver locks that need to be keyed alike with the key number 202.

Model String:

**GLKFE2. MTS. X202. 6**  
*Model Color Program # of Offices*

### SEQUENTIAL KEYING EXAMPLE

- A multiple phase project has 100 offices - 60 in the first phase with 4 locks, 40 in the second phase with 3 locks. No key number can be duplicated.

Model String (First Phase):

**GLKFE4. PYT. SEQ/101. 60**

Model String (Second Phase)

**GLKFE3. PYT. SEQ/161. 40**  
*Model Color Program # of Offices*



Product Reference... 15-48  
Statement of Line... 16-23  
Features + Advantages... 24-25  
Technical Specs... 26-28  
Filing Reference... 29-30  
Height Reference... 31  
Wire Management... 32  
Grommets... 33  
Details... 34  
Height Adjustability... 35  
Storage... 36  
Surface Mount Cabinets... 37  
Dimensions... 38-47  
Grain Direction Specification... 48

# STATEMENT OF LINE

Unitized

Silea

02/24

**DOUBLE PEDESTAL DESK**  
15" ped

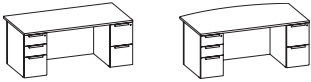

**SINGLE PEDESTAL DESK**  
15" ped

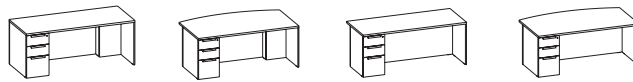

**SINGLE PEDESTAL CREDENZA**  
9" ped

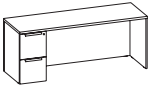

30" ped

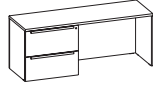

**DOUBLE PEDESTAL CREDENZA**

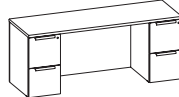

**RETURNS**

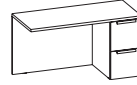

**RUNOFF DESK**  
15" ped (LH & RH)

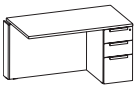

**RUNOFF DESK**  
9" ped (LH & RH)

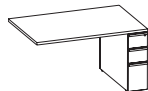

**LAYERS RUNOFF DESK**  
9" ped (LH & RH)

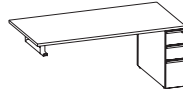

**LAYERS RUNOFF DESK W/  
LAPTOP DRAWER (LH & RH)**

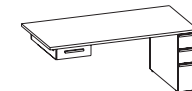

**RECTANGULAR TABLE DESK**

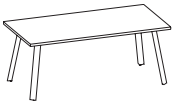

**RECTANGULAR EXTENSION**  
(LH & RH)

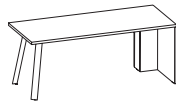

**RACETRACK EXTENSION**  
(LH & RH)



**d SHAPE EXTENSION**



**b SHAPE EXTENSION**

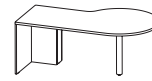

**LAYERS RECTANGULAR RUNOFF**

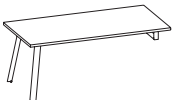

**LAYERS RECTANGULAR RUNOFF W/LAPTOP DRAWER (LH & RH)**

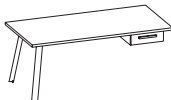

**SIGHTLINE RUNOFF**

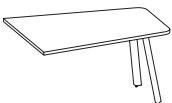

**LAYERS SIGHTLINE RUNOFF**

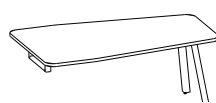

**LAYERS SIGHTLINE RUNOFF W/LAPTOP DRAWER (LH & RH)**

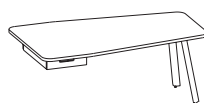

**LAYERS COCKPIT RUNOFF (LH & RH)**

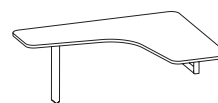

**MEDIA TOP**



**ELLIPSE TABLE DESK**

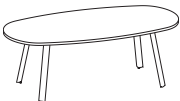

**LAYERS ELLIPSE RUNOFF**

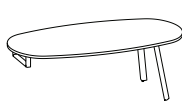

**ARC BOAT TABLE DESK**



**LAYERS ARC BOAT RUNOFF**

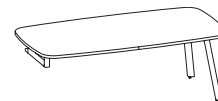

**FULL BANK CREDENZA**

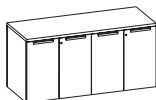
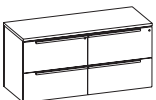

HEIGHT ADJUSTABLE

CREDENZA W/ END PANELS

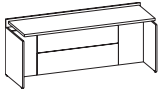

CREDENZA DOUBLE PEDESTAL

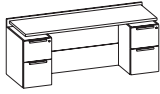

CREDENZA SINGLE PEDESTAL (LH & RH)

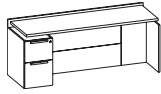

BRIDGE W/ WALL ACCESS PANEL

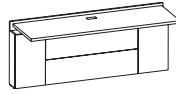

RETURN W/ END PANEL (LH & RH)

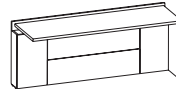

RETURN W/ PEDESTAL (LH & RH)

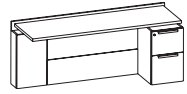

FREESTANDING DESK W/ FULL MODESTY

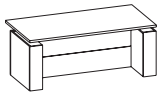

EXT DESK W/ FULL MODESTY (LH & RH)

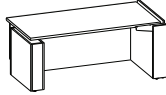

EXT DSK W/ TELESCOPING BASE (LH & RH)

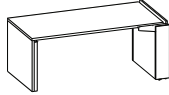

FREESTANDING DESK W/ HALF MODESTY

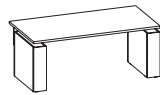

EXT DESK W/ HALF MODESTY (LH & RH)

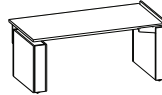

WORKSURFACE FOR T-BASE



SHROUD FOR T-BASE

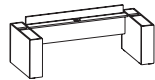

LAYERS BOOKCASE FOR T-BASE



T-BASE



WORKWALL

WALL MOUNTED WORKWALL (3H) (LH & RH)  
(Wood only)

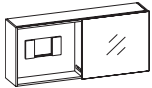

FREESTANDING WORKWALL (5 1/2 H) (LH & RH)  
(Wood only)

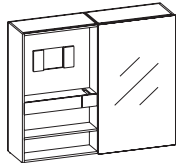

LOUNGE LEVEL MEDIA UNIT  
(Wood only)

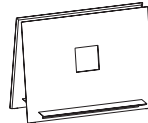

LOUNGE LEVEL MEDIA UNIT  
Whiteboard

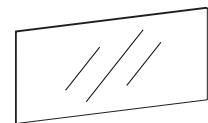

# STATEMENT OF LINE

Modular

Silea

02/24

## DESK & RUNOFF WORKSURFACE

30 & 36D

Rectangular



Bow



Racetrack



b shape



d shape



24D TOP

Standard or Trough



## DOUBLE PEDESTAL FULL MODESTY

9" peds

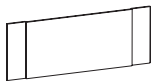

15" peds

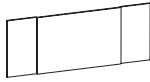

## SINGLE PEDESTAL FULL MODESTY

(LH & RH)

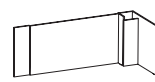

## DESK MODESTY PANEL

10" Height



## DESK MODESTY PANEL

Full Height



## PEDESTALS 24D Standard Height, Standard or Trough Top



(LH & RH)



(LH & RH))



## PEDESTALS 24D Standard or Trough Top



(LH & RH)

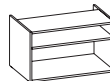

## DESK PEDESTALS

9" ped



(LH & RH)



## END PANEL

(Full back, no trough)



## L SUPPORTS

(LH & RH)



## SUPPORT PANELS

Standard & Layers

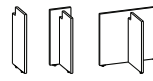

## PEDESTAL BACKS

Standard & Layers

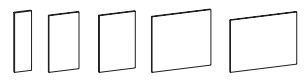

## MODESTY & WALL ACCESS PANEL

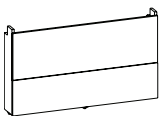

## ROUND TOP



## GUITAR PICK TOP





---

**CANTILEVER HEIGHT ADJUSTABLE RECTANGULAR DESKS**

**LEFT & RIGHT HAND**

36" Depth - Left Hand

42" Depth - Left Hand

36" Depth - Right Hand

42" Depth - Right Hand

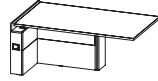
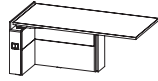
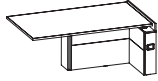
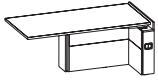

---

**CANTILEVER HEIGHT ADJUSTABLE SIGHTLINE DESKS**

42" Depth - Left Hand

42" Depth - Right Hand

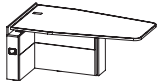
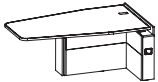

---

**SMART PEDESTALS**

Single Unit

Double Unit

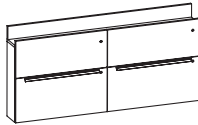

---

**SMART PEDESTAL ACCESSORY TRAYS AND BINS**

Large Tray

Large Bin

Small Tray

Small Bin

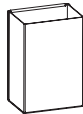
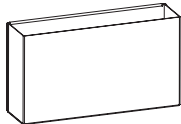

---

**FALSE PEDESTALS**

For Fixed Desk or Fixed Return

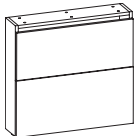

**SMART CLOSETS**

18" Wide

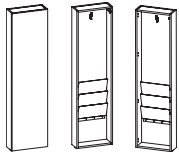

30" Wide Side Access

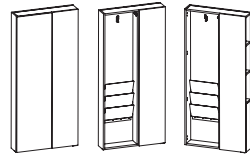

18" Wide w/ Glass Doors



30" Wide Side Access w/ Glass Doors

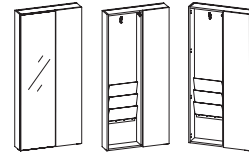

**SMART LOCKERS**

24" Wide

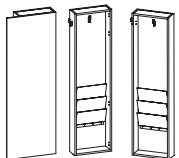

36" Wide Side Access

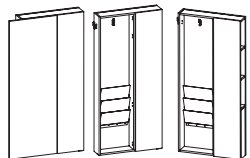

24" Wide w/ Glass Doors

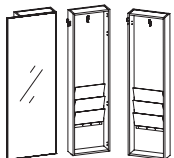

36" Wide Side Access w/ Glass Doors



**SMART PEDESTAL GROMMET ACCESSORIES**

HQ Power w/ Wireless Charging

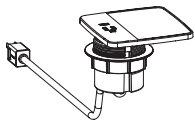

Bezel Mount Power

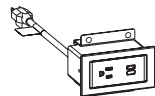

**SOLIDWOOD DESKTOP ACCESSORIES**

Pencil Tray



Pencil Cup

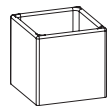

**REPLACEMENT HEIGHT ADJUSTABLE KEYPAD ACCESSORIES**

Basic Up/Down Keypad



Memory Preset Keypad



Paddle Keypad



Foot Control Keypad



Bluetooth App Control



BOOKCASE - 2H, 3H, 4H, 5H, 6H

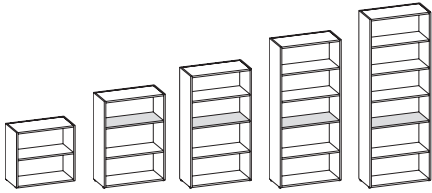

BOOKCASE W/ COAT HOOK  
BACK (LH & RH)

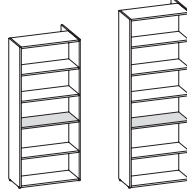

1/2 OPEN BOOKCASE  
1/2 CLOSET W/ DOOR  
(LH & RH)

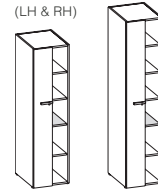

LATERAL FILE - 2H WITH TOP  
3H, 4H, 5H, 6H

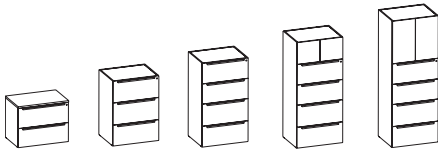

CLOSET  
5H & 6H

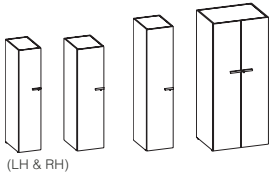

CLOSET W/ GLASS  
DOOR (LH & RH)  
5H & 6H

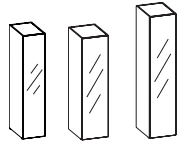

STORAGE BOX  
5H & 6H

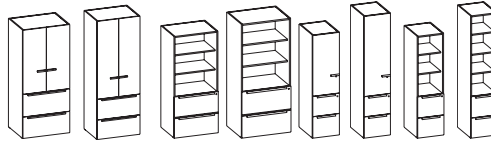

STORAGE CABINET



UTILITY CABINET  
(LH & RH) 5H & 6H

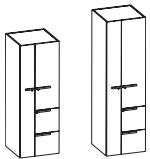

SIDE ACCESS  
STORAGE LOCKER  
Standard & Layers Height  
(LH & RH)

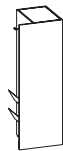

SIDE ACCESS STORAGE  
LOCKER W/GLASS DOOR  
Standard & Layers Height  
(LH & RH)



EXTERNAL STORAGE TOP



MOBILE PEDESTAL  
W/ TOP



# STATEMENT OF LINE

Wall Mount

Silea

02/24

**CABINET W/ HINGED DOORS**  
(1H)

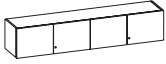

**CABINET W/ HINGED GLASS DOORS**  
(1H)  
(Wood only)

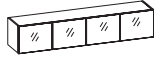

**CABINET W/ NO DOORS**  
(1H)

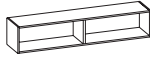

**CABINET W/ HINGED DOORS**  
(2H)

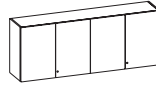

**CABINET W/ HINGED GLASS DOORS**  
(2H)  
(Wood only)

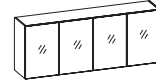

**CABINET W/ NO DOORS**  
(2H)

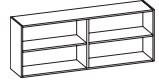

**CABINET W/ SLIDING DOORS** (1H)



**CABINET W/ SLIDING GLASS DOORS** (1H)  
(Wood only)



**CABINET W/ SLIDING DOORS** (2H)

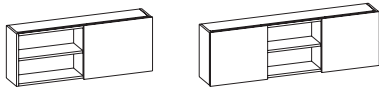

**CABINET W/ SLIDING GLASS DOORS** (2H)  
(Wood only)

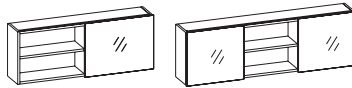

**WALL OVERHEAD SHELF TRACK BOTTOM**  
(1H)



**WALL OVERHEAD SHELF TRACK BOTTOM & CENTER**  
(2H)



**TACK ZONE W/ CENTER TRACK**  
(1H)



**LAYERS TACK ZONE W/ CENTER TRACK**



**TACK ZONE**  
(Wood, Glass & Fabric)

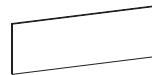

**8D & 12D SHELF CLIP INTO WALL W/TRACK**



**FLOATING SHELF**



**EXTERNAL TOP**



CABINET W/ HINGED DOORS (1H)

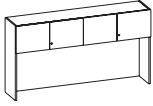

CABINET W/ HINGED GLASS DOORS (1H)  
(Wood only)

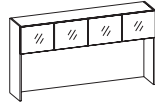

CABINET W/ NO DOORS (1H)

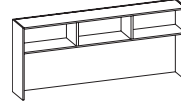

CABINET W/ HINGED DOORS (2H)  
(Wood only)

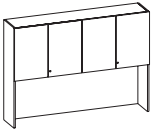

CABINET W/ HINGED GLASS DOORS (2H)  
(Wood only)

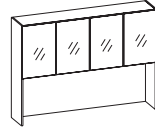

TOWER W/ HINGED DOORS (1H)

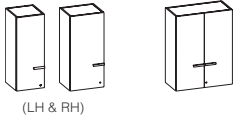

TOWER W/ HINGED DOORS (2H)

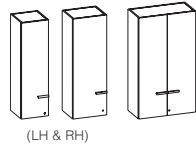

TOWER W/ NO DOORS (1H)

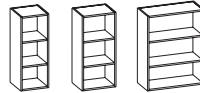

TOWER W/ NO DOORS (2H)

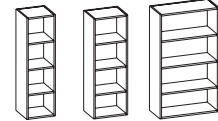

TOWER W/ GLASS DOORS (1H)  
(Wood only)

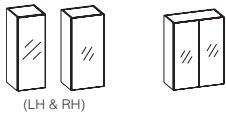

TOWER W/ GLASS DOORS (2H)  
(Wood only)

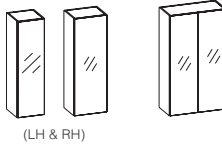

EXTERNAL SURFACE MOUNT  
TOP



ATTRIBUTE	FEATURE	ADVANTAGE
<b>STYLE/DESIGN</b>	Refined Aesthetic Range	<ul style="list-style-type: none"> <li>• Application solutions for solo, team and community spaces</li> <li>• Empowers design choice through a flexible aesthetic range</li> <li>• Complete integration of components and functionality options</li> <li>• Curated and compatible materials and finish options embrace diverse styling options</li> <li>• Attention to detail</li> <li>• High level of space customization &amp; functionality</li> <li>• Variety of metal pull options, along with integral pull on wood</li> <li>• Interchangeability of materials provide design flexibility</li> </ul>
	Hand Selected Veneer	<ul style="list-style-type: none"> <li>• Quarter cut walnut</li> <li>• Flat cut cherry, maple and walnut</li> <li>• Rift cut oak</li> <li>• Stratawood veneer (horizontal or vertical orientation)</li> </ul>
	Mixed Material Solutions	<ul style="list-style-type: none"> <li>• 11 woodgrain laminates</li> <li>• 3 solid laminates</li> <li>• 6 back painted glass options</li> <li>• 5 solid surface options</li> <li>• 5 metal finish colors</li> </ul>
<b>SCALABILITY</b>	Size & Scale	<ul style="list-style-type: none"> <li>• Flexibility in material options and components allow for a variety of product planning solutions to meet customer requirements</li> <li>• Standard height and layers height</li> <li>• Application versatility from enclosed spaces to team collaborative settings to community gathering areas</li> </ul>
	Aesthetic Cost	
<b>FUNCTIONALITY</b>	Unlimited Outcomes	<ul style="list-style-type: none"> <li>• High-performance workplaces driven by integration, agility, choice, and aesthetic options.</li> </ul>
	Integrated Height Adjustability Solutions	<ul style="list-style-type: none"> <li>• Mixed material, full modesty and half modesty desks &amp; extensions</li> <li>• Sit to stand bridges, returns and credenzas</li> <li>• Shrouded height adjustable t-bases</li> <li>• Layers application sit to stand solutions</li> </ul>
	Soft Close Suspensions & Hardware	<ul style="list-style-type: none"> <li>• Soft close drawers and hinges on all materials</li> </ul>
	Magnetic Tack zone	<ul style="list-style-type: none"> <li>• Back painted glass, wood tack zones provide a magnetic surface for posting papers and magnetic accessories</li> </ul>
	Personal Corner	<ul style="list-style-type: none"> <li>• Creates an ergonomic corner for use</li> </ul>
	Collaborative Worksurface Shapes	<ul style="list-style-type: none"> <li>• Media, sightline and guitar pick tops provide collaborative solutions in the private office or open areas</li> <li>• Integration of private office components that enable effective meeting spaces</li> </ul>
	Workwall Solutions	<ul style="list-style-type: none"> <li>• Progressive meeting office option that allows for collaboration and personalized space</li> <li>• Fits in private office applications or can be pulled into open areas</li> </ul>
<b>TECHNOLOGY INTEGRATION</b>	Wire Management Trough	<ul style="list-style-type: none"> <li>• Continuous trough with non-handed pedestals</li> <li>• Easy access to power and data</li> <li>• Clean, simple wire management</li> <li>• Use of clip-in accessories</li> </ul>
	Grommets	<ul style="list-style-type: none"> <li>• Rectangular grommets in desks and credenzas</li> <li>• Three grommet positions - closed, small opening for cords, larger opening for monitor arms</li> <li>• Cutout can utilize a power unit to bring technology to the surface</li> </ul>
	Wall Access Panels	<ul style="list-style-type: none"> <li>• Hinged wall access panels provide simple, clean wire management and access to cords</li> </ul>

ATTRIBUTE	FEATURE	ADVANTAGE
<b>TECHNOLOGY INTEGRATION</b>	Laptop Drawer	<ul style="list-style-type: none"> <li>Incorporated into layers applications under runoff worksurfaces to provide technology storage and power to the user and guest</li> </ul>
	Lighting	<ul style="list-style-type: none"> <li>Optional high-efficiency LED task lighting</li> <li>Low energy usage</li> </ul>
	Wire Management Trough	<ul style="list-style-type: none"> <li>Continuous trough with non-handed pedestals</li> <li>Easy access to power and data</li> <li>Clean, simple wire management</li> <li>Use of clip-in accessories</li> </ul>
	Grommets	<ul style="list-style-type: none"> <li>Rectangular grommets in desks and credenzas</li> <li>Three grommet positions - closed, small opening for cords, larger opening for monitor arm</li> <li>Cutout can utilize a power unit to bring power to the surface</li> </ul>
	Wall Access Panels	<ul style="list-style-type: none"> <li>Hinged wall access panels provide simple, clean wire management and access to cords</li> </ul>
	Laptop Tray	<ul style="list-style-type: none"> <li>Incorporated into layers applications under runoff worksurfaces to provide technology storage and power to the user and guest</li> </ul>
<b>STORAGE</b>	Lighting	<ul style="list-style-type: none"> <li>Optional high-efficiency LED task lighting</li> <li>Low energy usage</li> </ul>
	Storage Locker	<ul style="list-style-type: none"> <li>Provides side access shelving for easy access for the user</li> <li>Hidden coat hook and personal storage</li> <li>Door available in wood and laminate</li> <li>Back Painted Glass doors serve as a whiteboard with a kickstand for collaborative meetings</li> </ul>
	Wall Mount and Surface Mount Overheads	<ul style="list-style-type: none"> <li>Hinged and sliding doors</li> <li>Wood models have back painted glass door option</li> <li>Mix of open and closed storage</li> </ul>
<b>SUSTAINABILITY</b>	Hidden Accessory Drawers	<ul style="list-style-type: none"> <li>Provides clean lines and fewer fronts</li> <li>Maximize space usage in drawers</li> </ul>
	Designed for the Environment	<ul style="list-style-type: none"> <li>FSC certified products available</li> <li>FSC reconstituted veneer</li> <li>SCS Indoor Advantage™ Gold Certification</li> <li>High percentage of recycled content - greater than 43%</li> <li>BIFMA level® 3 certified</li> <li>Contribution to LEED V4 and WELL V1</li> <li>Energy Efficient LED Task lighting</li> </ul>
<b>DURABILITY</b>	Gunlocke Craftsmanship	<ul style="list-style-type: none"> <li>High attention to detail, fit, finish and refinement across all material options</li> </ul>
<b>PRICE/VALUE</b>	Budget Flexibility	<ul style="list-style-type: none"> <li>Range of basic to premium options and materiality choice provides a broad price range to accommodate solutions without sacrificing design or functionality</li> </ul>
	Value	<ul style="list-style-type: none"> <li>12-year warranty</li> <li>Quality/value built into product throughout the manufacturing process</li> </ul>

### VENEERS

All exposed wood surfaces utilize flat cut, rift cut, or straight grain Stratawood (FSC reconstituted veneer), flat cut Cherry, Maple, Walnut veneers, quarter cut Walnut, or Rift Oak veneers. Stratawood veneer is made from rapidly renewable wood veneer, which provides a repeatable grain pattern. Stratawood veneers are available in flat cut Cherry, flat cut Walnut, or Rift Oak at veneer 1 pricing and in straight grain Cherry, Maple, Walnut, Oak, Silver Oak, or Washed Walnut at veneer 2 pricing. Veneers can be specified in vertical or horizontal orientation. All veneers are carefully selected and matched to assure balance and consistency.

### VENEER TOPS

Wood veneer tops feature 3-ply construction and are comprised of a premium 1.125" thick substrate. Tops are available with a square edge profile and are constructed of 45 lb. density particleboard. Tops are faced with premium veneer and backed with a polymer resin impregnated moisture resistant material. Rectangular tops utilize 2mm solid wood edgebands that are species matched except for Rift Cut Oak which is paired with solid ash hardwoods. Non-rectangular tops utilize matching 1mm edgebands that are doubled up for added durability, creating a total thickness of 2mm.

### LAMINATE

The standard laminate offering includes solid and woodgrain laminates from Wilsonart. Laminate tops feature a high pressure laminate (HPL), a balanced 3-ply construction and are comprised of a 1.125" thick substrate. Tops are available with a square edge and are made with 45 lb. density particleboard. Laminate tops have a 2mm matching vinyl edgeband on all sides. Chassis and storage components feature a thermally fused laminate (TFL).

For complete technical specifications, visit [www.wilsonart.com](http://www.wilsonart.com).

### SOLID SURFACE TOPS

Solid surface tops with plywood subtops are a total of 1.25" thick. Tops are constructed with 0.5" solid surface material applied to premium 0.75" plywood with a built up softened edge detail. Solid surface has a matte finish.

### BACK PAINTED GLASS

Back painted glass is captured by an extruded aluminum mitered frame. The frame is low profile, allowing only a 0.063" visible frame around the perimeter of the glass from the front view. Aluminum frames are powder coated to match the color of the glass option chosen. Back painted glass is 4mm thick and whiteboard applications include a steel backer for use with magnets – 6 magnets are included with each whiteboard. Back painted glass has a clear glossy finish for use as a writable surface and can be used with dry-erase markers. Whiteboards are mounted to the wall with a z-bracket connection.

### CHASSIS & PEDESTAL CONSTRUCTION

All chassis are constructed with a mixture of 3/4" thick balanced 3-ply panels and 3/4" thick panels. Panels are securely fastened together using cam-lock fasteners and dowels. Steel glide plates are attached to single end panels with screws. End panels are pre-bored to accept the stem of the glide. The threaded steel glide plate provides a durable connection from glide to end panel.

Each unit is equipped with a minimum of four adjustable glides.

### OVERHEAD CABINET CONSTRUCTION

All cabinets are constructed with a mixture of 0.75" thick balanced 3-ply panels and 0.75" thick MDF panels. Wood panels are securely attached with hidden fasteners and dowels, and are securely adhered with PVAc-dispersion adhesive. All laminate panels are securely fastened together

using cam-lock fasteners and dowels.

All surface mount cabinets connect to worksurface with double-sided adhesive tape.

Wall mount cabinets are mounted to the wall with a spade and "z" bracket attachment method. Spade brackets are securely mounted through the back of wall mount cabinets. All units ship with a steel z bracket. This bracket is mounted to the wall by field installers. Installers are responsible for selecting and supplying appropriate fasteners for wall conditions.

### GLIDES

Glides provide 1.125" of vertical leveling adjustment. Glide bottom is durable non-rust nylon.

### TACKBOARDS

Tackboards are constructed of 0.875" thick material comprised of a 0.125" thick hardboard glued in between a layer of 0.375" thick pressboard on each side. The fabric is precisely aligned and fitted to the tackboard and adhered to the rigid hardboard with staples.

### DRAWERS

All drawers are constructed of four sides and a bottom, which are attached to a drawer front with screws for easy removal. Drawer fronts feature matched veneer within each pedestal set. The drawer side material is 3-ply 12mm vinyl wrapped particleboard and are miterfold construction. The bottom material is a 3-ply substrate consisting of vinyl wrapped high density fiberboard core.

### SUSPENSIONS

Suspensions utilize cold rolled steel, zinc plated, high-grade drawer suspensions. Box drawers are full extension, featuring precision steel ball bearings for a smoother, quieter range of motion and are load rated for 120 lbs. File drawers are full extension, featuring precision steel ball bearings



for increased weight capacity and are load rated for 120 lbs. Lateral file suspensions are load rated for 150 lbs. and include an anti-tip mechanism that prevents both drawers from being opened at the same time. All suspensions are soft close and are warranted for the lifetime of the product.

### HINGES

Doors with metal pulls include a 105° hinge with an integrated soft-close mechanism. Doors with touch latch utilize a 110° hinge. Hinges are fully adjustable.

### FILING

The file hanging system is an integral part of the drawer. A highly durable black plastic extrusion is securely fastened into a rout on the top of the drawer. The plastic extrusion was designed to promote optimum filing capacity within the drawer while providing a durable, reliable and maintenance free filing system. (See filing capability section for technical information on drawer dimensions).

### LOCKS

Locks are standard on all desks, credenzas, returns, modular pedestals, and storage units. Locks are optional on closets and overhead cabinets. Each pedestal is independently locked.

Keying is available either random (factory installed), or omit (field installed).

When "Random Keying" is chosen, the factory will assign key(s) arbitrarily. Factory installed lock cores will be matte silver.

When "Omit Lock Core" is chosen, the factory will omit lock cores and locks will be field installed. A keying program must be chosen - Random, Specified, or Sequential - to specify keys. Field installed locks will be available in matte silver, black, pyrite, and matte gold.

### WIRE MANAGEMENT

Wire management capabilities include optional worksurface grommets that can house cords, a monitor arm, or be replaced with a power unit to bring technology to the worksurface. Cavities in the back of pedestals, removable panels, and wall access panels can be used for cord concealment and management.

Under worksurface wire managers (Model # ACWM) are sold separately to conceal wires between pedestals. These units house and manage wires horizontally around a station.

Continuous aluminum wire management troughs provide seamless integration of technology in the credenza. Modular trough tops come with 2 end caps to close off the open-end condition. Clip-in wire management accessories are provided to assist with technology ease and organization. Troughs, end caps and clip-in accessories are available in 5 metal finish colors – silver, black, pyrite, matte gold, and designer white.

### POWER

Power units are available in three sizes and are offered as surface mount, under worksurface mount, and clamp mount units. Available in black, white or silver, power units incorporate a combination of power, USB power, and data integration. Each enclosure is rated for 15 amp, 125 volt. Units can be specified with 10' standard plug or 6' hardwire conduit option. Unit is field installed. UL Listed. USB charging ports are 2.1 amps per port. For information on each model, reference the "Power Units" page in the price book.

### MAGNETIC ACCESSORIES

Magnetic accessories include imbedded magnets and can be positioned anywhere on magnetic tackzones and back painted glass tackzones/whiteboards. The accessories provide quick access to files, pencils, and other work utensils.

### PERSONAL CORNER & DESKPADS

Personal corners can be used between two perpendicular worksurfaces to create an ergonomic corner for user. Deskpads are used in-line. All units are wrapped in leather or vinyl. The bottom surface has a felt lining to protect the worksurface. The chassis is made from 10-gauge aluminum. Personal corners are 36W x 12.5D. Deskpads are 36W x 18D. Units are designed to fit over 1 1/8" worksurfaces.

### LIGHTING

LED lighting provides high efficiency, low energy lighting with a long life. All LED lights are encased in a silver aluminum extrusion and include a built-in switch to turn the light on/off with a dimming feature. Lights are field installed. All units include a standard plug.

- Low profile strip light 0.625"H x 0.75"D
- Power: 2.92W / Foot
- LED's per meter: 120
- Color Temp: 3000K
- Certification: UL Listed
- GSA and TAA compliant

### HEIGHT ADJUSTABLE

Height adjustable components include:

- Qty (2) height adjustable lifting columns
- Qty (1) control box
- Qty (5) keypad options from basic to premium
- Qty (2) cables connecting lifting columns to control box
- Qty (1) standard plug power cable to connect control box to power source

Lifting columns are rated for 225 lbs. dynamic load per column and are connected to tops using steel support brackets. Height range is 29" to 42.5". Each control box is powered by 120V / 60Hz. 2 lifting columns may draw approximately 1.5 amps total maximum under full load. Standby power is 0.1W.

### WORKWALLS

WorkWalls include wall mounted, wall mounted with wall access panels, stack on, and freestanding versions. Incorporating both a collaborative side and personal side, WorkWalls utilize a back painted glass sliding door that can serve as a whiteboard and be secured with a digital lock. The digital lock incorporates a keypad and smartphone app, along with 2 standard USB ports for emergency power jump and battery charging.

### FINISH

Natural veneer is subject to nature's quality control. Each species will exhibit differences in grain pattern and tone. This is to be expected and, in fact, contributes to the beauty and individuality of each product. Flat Cut veneers emphasize the variations of wood by exhibiting cathedrals in the grain pattern. Quarter Cut and Rift Cut veneers are a premium cut that maintains variations in the grain but without cathedral patterns. Stratawood is a natural, FSC®-certified reconstituted veneer that is designed to exhibit a consistent grain pattern and is available in either a straight grain or cathedral pattern.

Our proprietary wood finish system utilizes a combination of topcoats engineered for the various applications found in the furniture industry. It is exceptionally clear and durable, and allows the beauty of wood to show through. The durability, depth, clarity, and beauty of our wood finishes meet the high expectations of our customers, and meet or exceed indoor air quality (IAQ) standards. All colors and species are not available on all products. Please refer to front cover of price lists for availability of finishes.

### CLEANING CLARETECH™ FINISH

Dust with a damp cloth. Remove fingerprints or soiling with mild solution; 3 parts water with small amount of mild dish detergent. Apply solution with spray bottle, wipe clean and dry with soft cloth. Note: Do not use furniture polishes containing oil, wax, or silicone, which can produce an oily film or haze.

### CLEANING LAMINATE

Dust with a damp cloth. Remove fingerprints or soiling with mild solution; 3 parts water with small amount of mild dish detergent. Apply solution with spray bottle, wipe clean and dry with soft cloth. Note: Do not use furniture polishes containing oil, wax, or silicone, which can produce an oily film or haze.

For specific cleaning instructions on Wilsonart laminates, please visit [www.wilsonart.com](http://www.wilsonart.com).

### CLEANING GLASS

Dust with a damp cloth. Remove fingerprints or soiling with mild solution; 3 parts water with small amount of mild dish detergent. Apply solution with spray bottle, wipe clean and dry with soft cloth.

### CLEANING SOLID SURFACE

Using a damp sponge or cloth, use warm soapy water, an ammonia-based household cleaner, or a dedicated countertop cleaner to clean solid surface. Rub over area using small circular motions, from the front to the back, then side to side, overlapping the circles until the entire area has been cleaned. Rinse the top thoroughly with clean water and wipe surface completely dry.

**STANDARD FILING OPTIONS  
FOR PEDESTALS**

**9 wide x 30 and 36 deep pedestal**

File rails included: 2 per drawer

- A. 2 rows of letter side to side with 2 file rails
- B. 1 row of legal side to side

Replacement File Rail Kit Model #ACFLR9-P

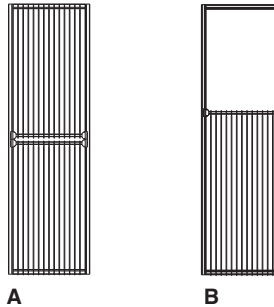

**15 wide x 30 and 36 deep pedestal**

File rails included: 2 per drawer

- C. 2 rows of letter side to side with 2 file rails
- D. 1 row of legal-side to side,

Replacement File Rail Kit Model #ACFLR15-P

**Note:** Does not accommodate letter filing front to back.

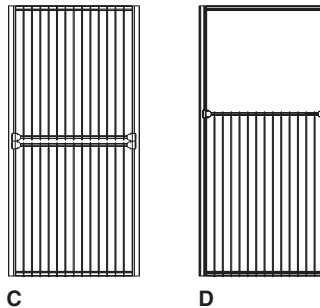

**15 wide x 24 deep pedestal**

File rails included: 1 per drawer

- E. Legal-side to side
- F. 1 row letter side to side,  
Model #ACFLR15  
Ships w/pedestal.  
1 per file drawer.

Replacement File Rail Kit Model #ACFLR15-P

**Note:** Does not accommodate letter filing front to back.

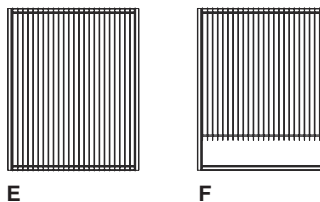

**18 wide x 24 deep pedestal**

File rails included: 1 per drawer

- G. Letter-front to back with file rail
- H. Legal-side to side

Replacement File Rail Kit Model #ACFLR18-P

**Note:** Does not accommodate letter filing front to back.

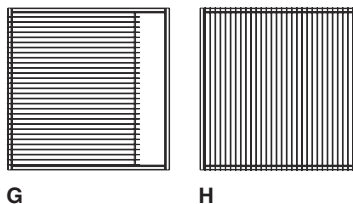

**STANDARD FILING OPTIONS**

(continued)

**Lateral 30 wide x 24 deep pedestal**

File rails included: 1 kit per drawer

- I.** Legal-side to side
- J.** Letter-side to side
- K.** 2 rows letter front to back

Replacement File Rail Kit Model #ACFLR30-P

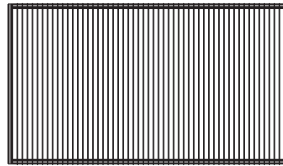

**I**

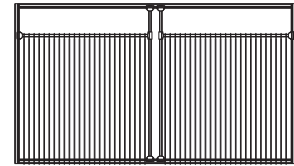

**J**

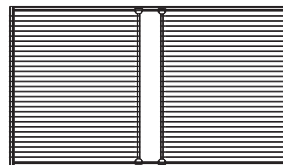

**K**

**Lateral 36 wide x 24 deep pedestal**

File rails included: 1 kit per drawer

- L.** Letter-side to side
- M.** 2 rows letter front to back
- N.** Legal-side to side
- O.** 2 rows legal front to back

Replacement File Rail Kit Model #ACFLR36-P

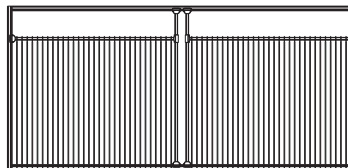

**L**

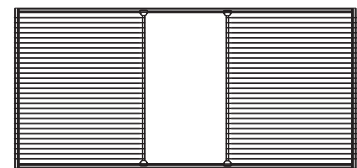

**M**

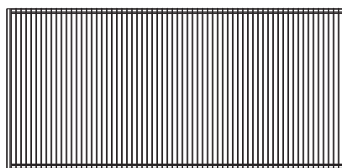

**N**

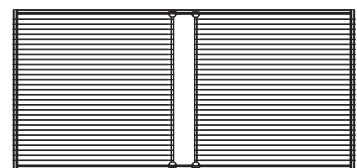

**O**

HEIGHT REFERENCE

Standard Height

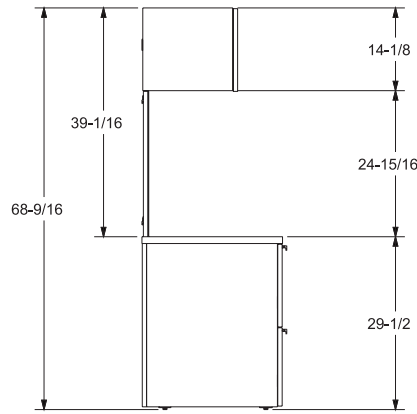

TYPICAL 1-HIGH SIDE PROFILE

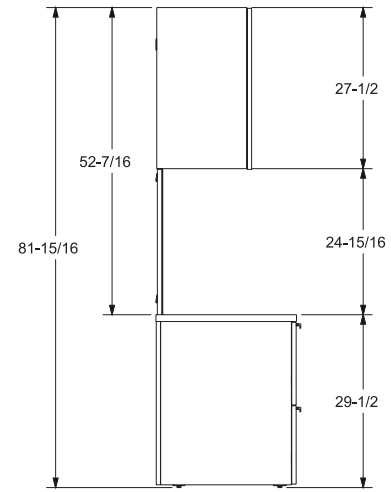

TYPICAL 2-HIGH SIDE PROFILE

Layers Height

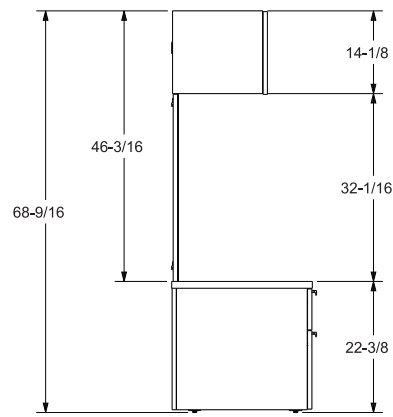

TYPICAL 1-HIGH SIDE PROFILE

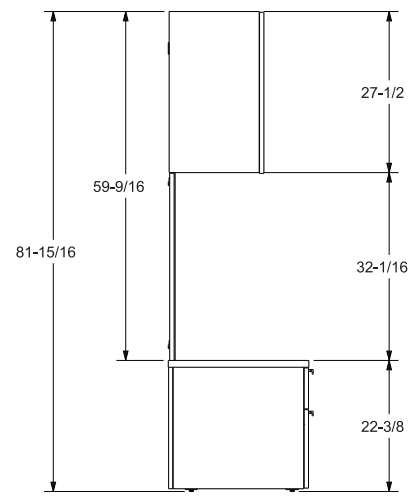

TYPICAL 2-HIGH SIDE PROFILE

Pedestal

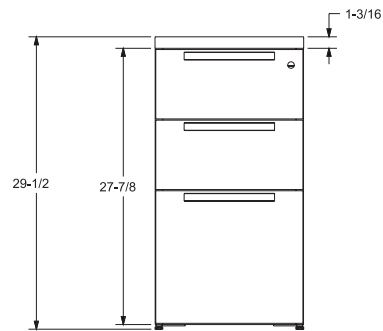

PEDESTAL FRONT PROFILE

Thoughtfully channel and conceal wires and cables using a streamlined trough feature. Easy wall access and conveniently placed grommets deliver your power and data.

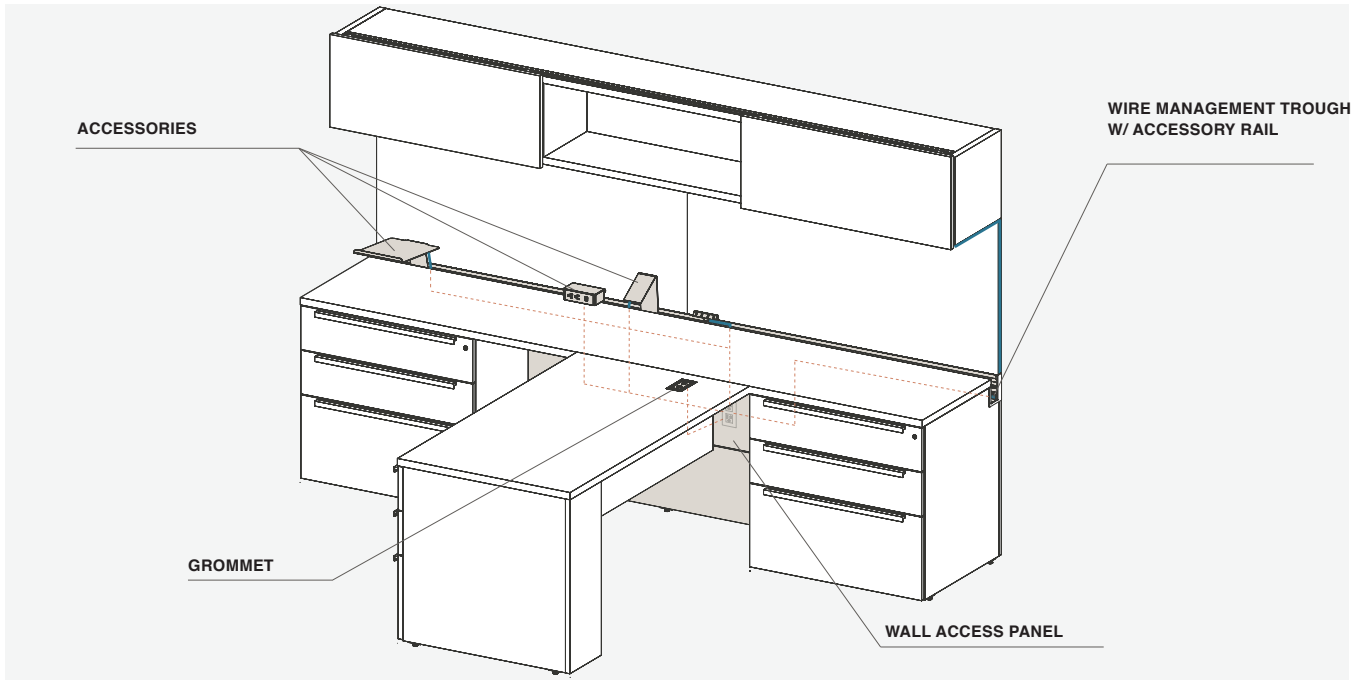

## WALL ACCESS PANEL

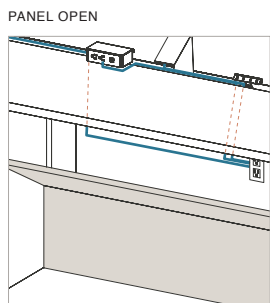

## GROMMET

CLOSED

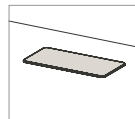

SMALL CORDS

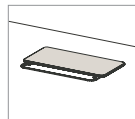

POWER

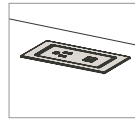

MONITOR ARM

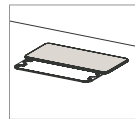

## TROUGH

WIRE ROUTE

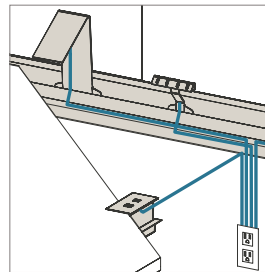

ACCESSORIES

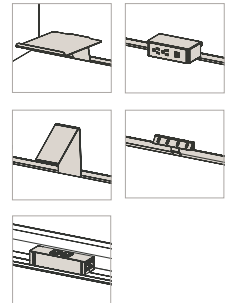

## TROUGH INFORMATION

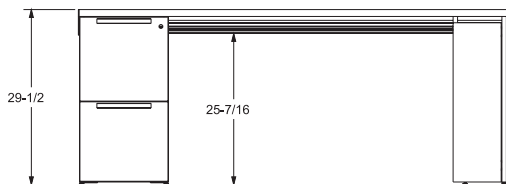

Standard Height

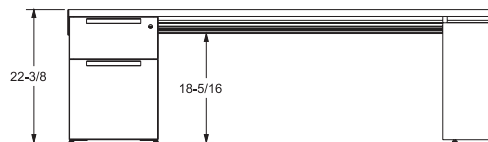

Layers Height

**GROMMET LOCATIONS**

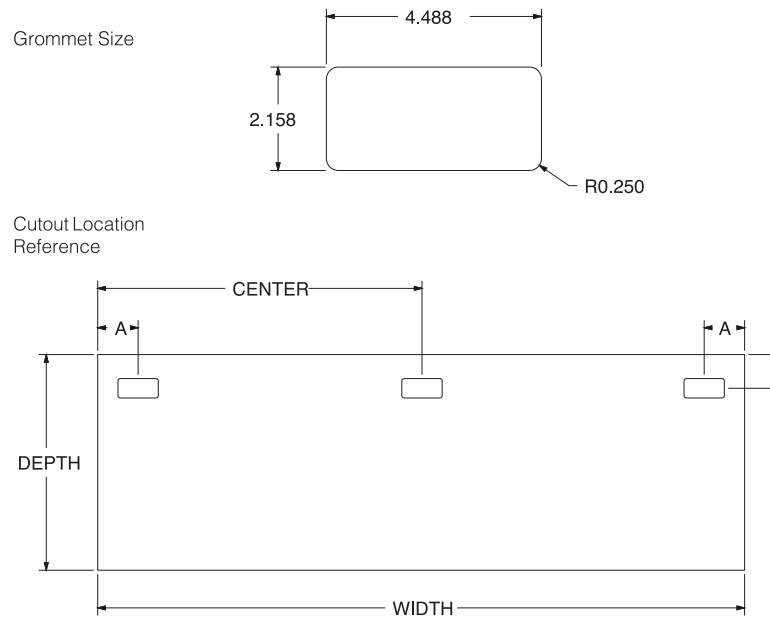

**GROMMET CUTOUT LOCATIONS**

UNIT	A	CENTER	B
24D Rectangular Tops	12	CENTER	4.25
30D Rectangular Tops	12	-	9.500
36D Rectangular Tops	12	-	9.500
Media Tops	-	CENTER	3.750
Round Tops	-	CENTER	-
Guitar Pick Tops	-	CENTER	-
22D Height Adjustable Tops	10	CENTER	3.5
28D & 34D Height Adjustable Tops	10	CENTER	4
30D Telescoping Height Adjustable Tops	12.500	-	6.125
36D Telescoping Height Adjustable Tops	12.500	-	9.125
30D Half/Full Modesty Height Adjustable Tops	12.500	-	4.500
36D Half/Full Modesty Height Adjustable Tops	12.500	-	7.500
24D Height Adjustable Units	-	CENTER	5.11

• Add \$80 per grommet based on chosen grommet configuration

Gunlocke provides versatile storage features, including convenient options for pull orientation and drawer configuration. The accessory drawer includes convenient internal compartments crafted with Gunlocke quality.

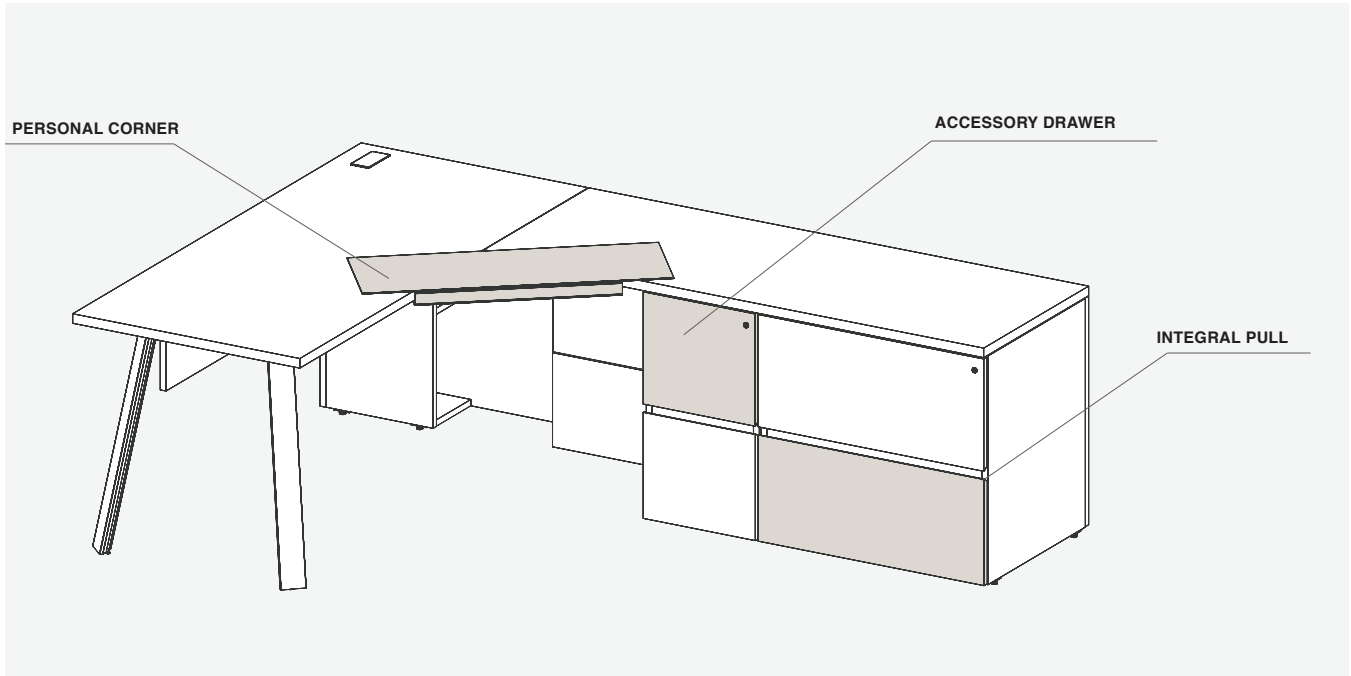

Silea pull orientation

INTEGRAL

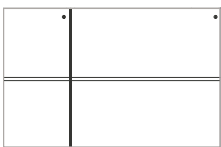

CENTERED

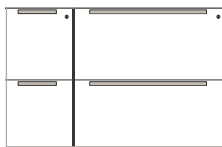

CONTINUOUS

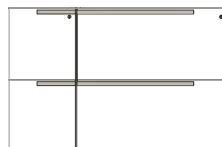

LEFT ALIGNED

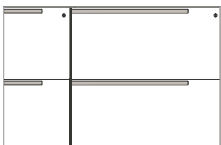

RIGHT ALIGNED

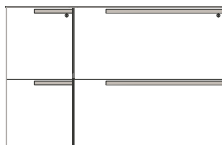

**Choice.**

Silea enables you to select drawer pull orientation at the time of installation. Maximum flexibility.

ACCESSORY DRAWER

ACCESSORY DRAWER (OPEN)

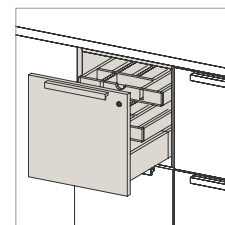



Integrated height adjustability enables the healthful rotation of working posture. The virtually concealed electric mechanism supports the quiet and easy transition to standing. Sit-to-stand, concentrate, collaborate. With height adjustability, a desk is more than a desk. It's a way of wellbeing, adjusting the worksurface to the working position that fits best.

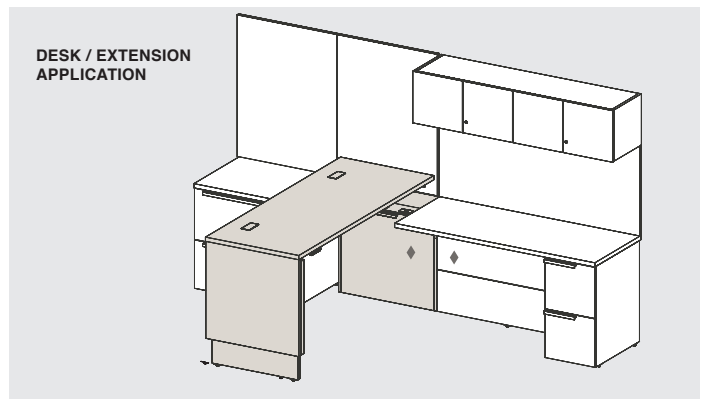
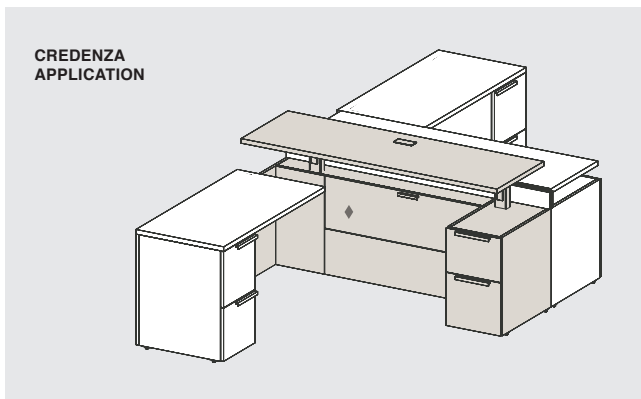
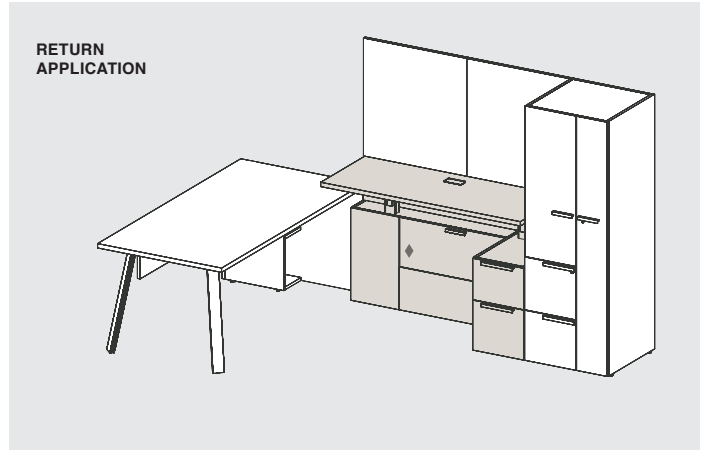
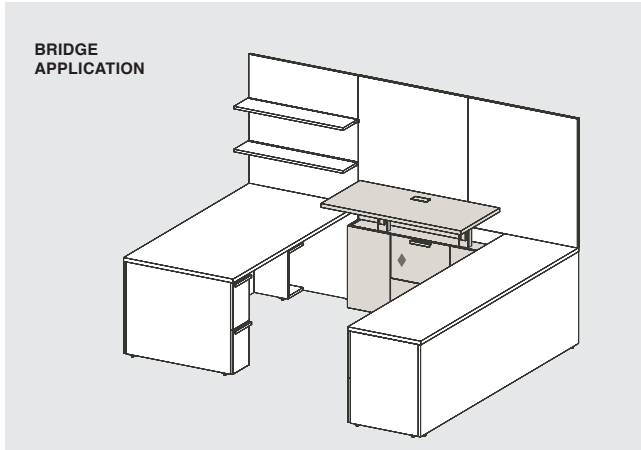

◆ WALL ACCESS PANEL

### IMPORTANT SPEC TIP: HEIGHT ADJUSTABILITY WITH MONITOR ARMS

- Monitor arms should **ALWAYS** be installed in grommets on Silea HAT units. Please ensure a grommet location is specified on the top. This allows for bolt mount or clamp mount install of monitor arm.
- Monitor arms should **NOT** be clamped to back edge of top where chassis interference can occur.
- The dimension from top of chassis to bottom of top on many HAT units allows for only approximately 2.250" clearance. Many monitor arm clamps, including Allsteel Pivot Monitor arms, have a taller clamp mount that will crash into the chassis during operation resulting in damage and/or loss of operation.

Example 1: Allsteel Pivot Monitor Arm Clamped to back edge of Silea HAT Bridge Top.

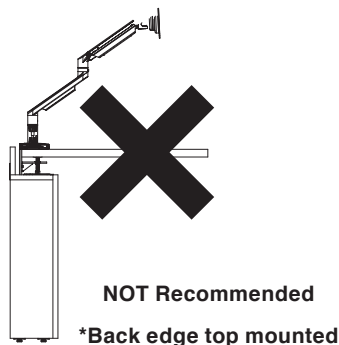

Example 2: Allsteel Pivot Monitor Arm Clamped in grommet of Silea HAT Bridge Top.

NOTE: ensure proper depth of top specified to provide adequate user space from top to monitors.

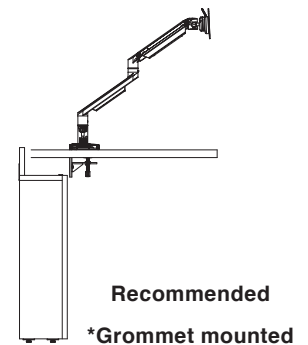

Storage options feature a nested laptop drawer, thoughtfully placed power access, and a multi-functional storage locker.

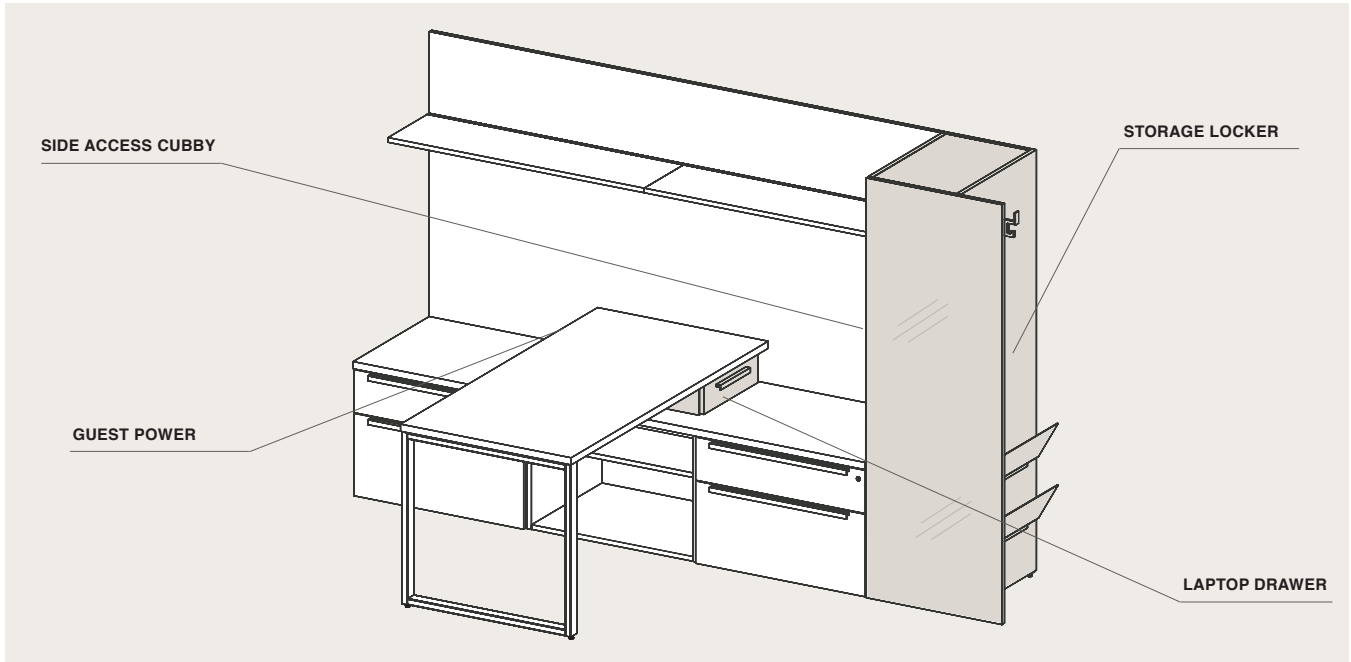

Laptop Drawer

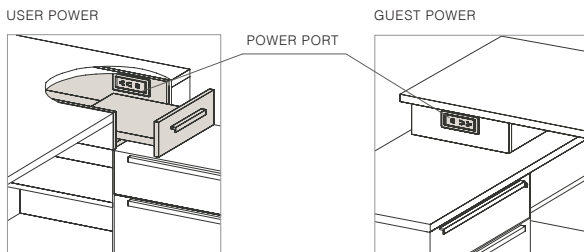

Storage Drawer

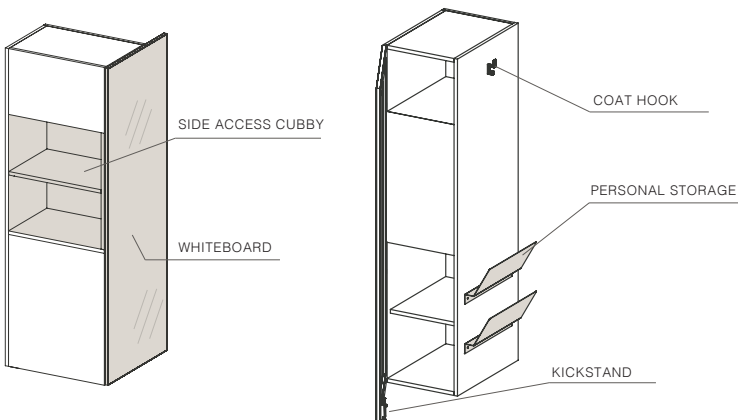

## SURFACE MOUNT CABINETS

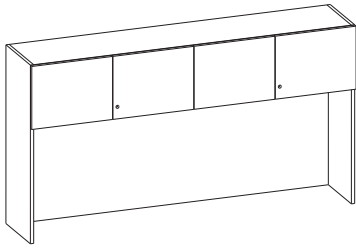

39 High

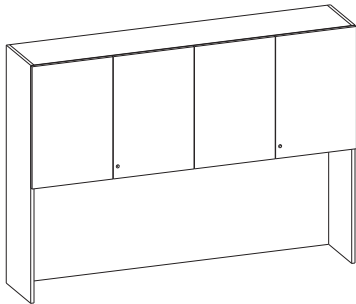

52 High

### Technology information & wire management:

- Tasklight cord grommet optional.
- Located in upper right-hand corner, provides task light cord access to wall outlets.

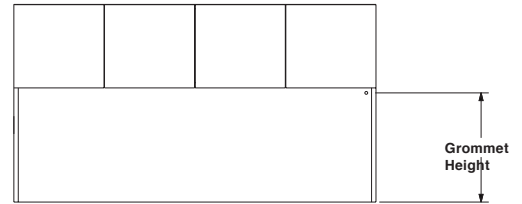

**Grommet Height** 39H and 52H = 24

Surface mount overhead cabinets must be supported with adequate pedestal or panel support on ends. In addition, the location where the surface mount cabinet and tower meet the worksurface using intermediate supports.

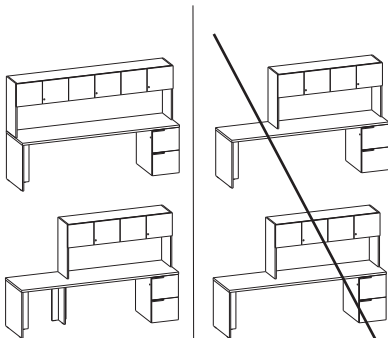

**Recommended Support Examples**

**Inadequate Support Examples**

When specifying surface mount storage across multiple units, careful considerations must be used to ensure the correct overall length. An end or back panel of a supporting unit must support the end panel of an overhead cabinet.

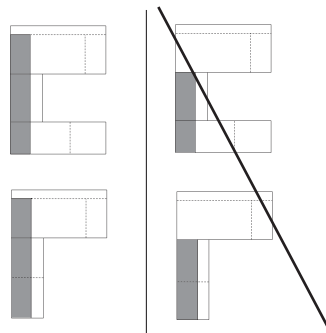

**Recommended Support Examples**

**Inadequate Support Examples**

# DIMENSIONS

Silea  
02/24

DESCRIPTION	STYLE	EXTERNAL DIMENSIONS			LOCATION	INTERNAL DIMENSIONS		
		width	depth	height		width	depth	height
Desk Pedestals 30" Deep	9" Wide Box   Box   File	9 2/5	29.13	27.88	Box Drawer	5.84	15.02	2.91
					File Drawer	5.84	25.22	9.17
	Acc.   Box   File	9 2/5	29.13	27.88	Acc. Drawer	5.93	14.92	1.50
					Box Drawer	5.84	15.02	2.91
					File Drawer	5.84	25.22	9.17
File   File	9 2/5	29.13	27.88	File Drawer	5.84	25.22	9.17	
Desk Pedestals 36" Deep	9" Wide Box   Box   File	9 2/5	35.13	27.88	Box Drawer	5.84	15.02	2.91
					File Drawer	5.84	25.22	9.17
	Acc.   Box   File	9 2/5	35.13	27.88	Acc. Drawer	5.93	14.92	1.50
					Box Drawer	5.84	15.02	2.91
					File Drawer	5.84	25.22	9.17
File   File	9 2/5	35.13	27.88	File Drawer	5.84	25.22	9.17	
Desk Pedestals 15" Wide 30" Deep	Box   Box   File	15	29.13	27.88	Box Drawer	11.40	15.02	2.91
					File Drawer	11.40	25.22	9.20
	File   File	15	29.13	27.88	File Drawer	11.40	25.22	9.20
Desk Pedestals 15" Wide 36" Deep	Box   Box   File	15	35.13	27.88	Box Drawer	11.40	15.02	2.91
					File Drawer	11.40	25.22	9.20
	File   File	15	35.13	27.88	File Drawer	11.40	25.22	9.20
Standard Height Modular Pedestals 15"W	Box   Box   File	15	23.13	27.88	Box Drawer	11.40	15.02	2.91
					File Drawer	11.40	15.02	9.17
	Acc.   Box   File	15	23.13	27.88	Acc. Drawer	11.50	14.92	1.50
					Box Drawer	11.40	15.02	2.91
					File Drawer	11.40	15.02	9.17
File   File	15	23.13	27.88	File Drawer	11.40	15.02	9.17	
Standard Height Modular Pedestals 18"W	Box   Box   File	18	23.13	27.88	Box Drawer	14.40	15.02	2.91
					File Drawer	14.40	15.02	9.17
	Acc.   Box   File	18	23.13	27.88	Acc. Drawer	14.49	14.92	1.56
					Box Drawer	14.40	15.02	2.91
					File Drawer	14.40	15.02	9.17
File   File	18	23.13	27.88	File Drawer	14.40	15.02	9.17	
Standard Height Modular Pedestals 30"W	File   File	30	23.13	27.88	File Drawer	25.90	15.02	9.25
	Box   Box   File	30	23.13	27.88	Box Drawer	26.40	13.09	2.91
					File Drawer	25.90	15.02	9.25
	Hinged Door	30	23.13	27.88	Total	28.47	13.55	26.38
					Above Shelf	28.47	13.45	12.78
					Below Shelf	28.47	13.55	12.85
	Bookcase	30	22.32	27.88	Total	28.47	13.55	26.38
					Above Shelf	28.47	13.45	12.78
					Below Shelf	28.47	13.55	12.85
Standard Height Modular Pedestals 36"W	File   File	36	23.13	27.88	File Drawer	31.90	15.02	9.25
	Box   Box   File	36	23.13	27.88	Box Drawer	32.40	13.09	2.91
					File Drawer	31.90	15.02	9.25
	Hinged Door	36	23.13	27.88	Total	34.47	13.55	26.44
					Above Shelf	34.47	13.45	12.74
					Below Shelf	34.47	13.55	12.89

DESCRIPTION	STYLE	EXTERNAL DIMENSIONS			LOCATION	INTERNAL DIMENSIONS		
		width	depth	height		width	depth	height
	Bookcase	36	22.32	27.88	Total	34.47	13.55	26.36
					Above Shelf	34.47	13.45	12.70
					Below Shelf	34.47	13.55	12.85
Layers Height Modular Pedestals 15"W	Box   File	15	23.13	20.75	Box Drawer	11.40	15.02	2.91
					File Drawer	11.40	15.02	9.17
Layers Height Modular Pedestals 18"W	Box   File	18	23.13	20.75	Box Drawer	14.40	15.02	2.91
					File Drawer	14.40	15.02	9.17
Layers Height Modular Pedestals 30"W	Box   File	30	23.13	20.75	Box Drawer	26.40	13.09	2.91
					File Drawer	25.90	15.02	9.25
	Hinged Door	30	23.13	20.75	Total	28.47	13.45	19.25
					Above Shelf	28.47	13.45	5.66
					Below Shelf	28.47	13.45	12.85
	Bookcase	30	22.32	20.75	Total	28.47	13.45	19.25
					Above Shelf	28.47	13.45	5.66
					Below Shelf	28.47	13.45	12.85
	Side Access	30	23.13	20.75	Total	28.47	25.59	19.25
					Box Drawer	25.44	15.25	5.12
Layers Height Modular Pedestals 36"W	Box   File	36	23.13	20.75	Box Drawer	32.40	13.09	2.91
					File Drawer	31.90	15.02	9.25
	Hinged Door	36	23.13	20.75	Total	34.47	13.55	19.23
					Above Shelf	34.47	13.45	5.58
					Below Shelf	34.47	13.55	12.85
	Bookcase	36	22.32	20.75	Total	34.47	13.55	19.23
					Above Shelf	34.47	13.45	5.58
					Below Shelf	34.47	13.55	12.85
	Side Access	36	23.13	20.75	Total	34.47	25.59	19.23
					Box Drawer	31.44	15.25	5.12
Mobile Pedestal	Mobile pedestal	15	21.80	22.63	Box Drawer	11.40	15.02	2.91
					File Drawer	11.40	15.02	9.17
Bookcases	2H	30	14.88	27.88	2H Top Shelf	28.47	13.91	12.76
					2H Bottom Shelf	28.47	14.07	12.85
	3H	30	14.88	41.77	3H Top Shelf	28.47	13.91	11.98
					3H Middle Shelf	28.47	13.91	13.93
					3H Bottom Shelf	28.47	14.07	12.85
	4H	30	14.88	54.00	4H Top Shelf	28.47	13.91	11.48
					4H 2nd Shelf	28.47	13.91	11.98
					4H 3rd Shelf	28.47	13.91	13.93
					4H Bottom Shelf	28.47	14.07	12.85
	5H	30	14.88	68.13	5H Top Shelf	28.47	13.91	12.61
					5H 2nd Shelf	28.47	13.91	12.25
					5H 3rd Shelf	28.47	13.91	11.98
					5H 4th Shelf	28.47	13.91	13.93
	6H	30	14.88	81.50	6H Top Shelf	28.47	13.91	12.62
6H 2nd Shelf					28.47	13.91	12.61	

# DIMENSIONS

Silea  
02/24

DESCRIPTION	STYLE	EXTERNAL DIMENSIONS			LOCATION	INTERNAL DIMENSIONS		
		width	depth	height		width	depth	height
					6H 3rd Shelf	28.47	13.91	12.25
					6H 4th Shelf	28.47	13.91	11.98
					6H 5th Shelf	28.47	13.91	13.93
					6H Bottom Shelf	28.47	14.07	12.85
<b>Bookcase / Closet</b>	5H	18	23.88	68.13	5H Top Shelf	7.86	21.10	12.61
					5H 2nd Shelf	7.86	21.10	12.25
					5H 3rd Shelf	7.86	21.10	11.98
					5H 4th Shelf	7.86	21.10	13.93
					5H Bottom Shelf	7.86	22.26	12.85
					Closet	7.86	22.26	66.61
	6H	18	23.88	81.50	6H Top Shelf	7.86	21.10	12.62
					6H 2nd Shelf	7.86	21.10	12.61
					6H 3rd Shelf	7.86	21.10	12.25
					6H 4th Shelf	7.86	21.10	11.98
					6H 5th Shelf	7.86	21.10	13.93
					6H Bottom Shelf	7.86	22.26	12.85
					Closet Above Shelf	7.86	21.10	12.62
					Closet Below Shelf	7.86	22.26	66.61
<b>Lateral Files</b>	2H	30"	23.88	29.04	File Drawer	25.90	15.02	9.25
		36"	23.88	29.04	File Drawer	31.90	15.02	9.25
	3H	30"	23.88	41.77	File Drawer	25.90	15.02	9.25
		36"	23.88	41.77	File Drawer	31.90	15.02	9.25
	4H	30"	23.88	54.00	File Drawer	25.90	15.02	9.25
		36"	23.88	54.00	File Drawer	31.90	15.02	9.25
	5H	30"	23.88	68.13	File Drawer	25.90	15.02	9.25
					Hinged Door	28.47	22.26	13.37
		36"	23.88	68.13	File Drawer	31.90	15.02	9.25
					Hinged Door	34.47	22.26	13.37
	6H	30"	23.88	81.50	File Drawer	25.90	15.02	9.25
					Hinged Door Above Shelf	28.47	21.45	13.00
					Hinged Door Below Shelf	28.47	22.26	13.00
		36"	23.88	81.50	File Drawer	31.90	15.02	9.25
					Hinged Door Above Shelf	34.47	21.45	13.00
					Hinged Door Below Shelf	34.47	22.26	13.00
<b>Closets</b>	15"	15	23.88	68.13	Total	13.47	22.26	66.61
	18"	18	23.88	68.13	Total	16.47	22.26	66.61
	18" 6H	18	23.88	81.50	Above Shelf	16.47	21.10	12.62
					Below Shelf	16.47	22.26	66.61
	5H - D	30	23.88	68.13	Top Shelf	13.86	21.10	12.61
					2nd Shelf	13.86	21.10	12.25
					3rd Shelf	13.86	21.10	11.98
					4th Shelf	13.86	21.10	13.93
					Bottom Shelf	13.86	22.26	12.85
					Coat Rod Section	13.86	22.26	66.61
	5H - S	30	23.88	68.13	Top Shelf	28.47	21.10	12.61

DESCRIPTION	STYLE	EXTERNAL DIMENSIONS			LOCATION	INTERNAL DIMENSIONS		
		width	depth	height		width	depth	height
					2nd Shelf	28.47	21.10	12.25
					3rd Shelf	28.47	21.10	11.98
					4th Shelf	28.47	21.10	13.93
					Bottom Shelf	28.47	22.26	12.85
	6H - D	30	23.88	81.50	Top Shelf	13.86	21.10	12.62
					2nd Shelf	13.86	21.10	12.61
					3rd Shelf	13.86	21.10	12.25
					4th Shelf	13.86	21.10	11.98
					5th Shelf	13.86	21.10	13.93
					Bottom Shelf	13.86	22.26	12.85
					Coat Rod Section Above Top Shelf	13.86	21.10	12.62
					Coat Rod Section Bellow Top Shelf	13.86	22.25	66.61
	6H - S	30	23.88	81.50	Top Shelf	28.47	21.10	12.62
					2nd Shelf	28.47	21.10	12.61
					3rd Shelf	28.47	21.10	12.25
					4th Shelf	28.47	21.10	11.98
					5th Shelf	28.47	21.10	13.93
					Bottom Shelf	28.47	22.26	12.85
Storage Box	5H	30	23.88	68.13	File Drawer	25.90	15.02	9.25
					Total Hinged Door	28.47	22.26	39.50
					Top Shelf	28.47	19.45	12.61
					Middle Shelf	28.47	19.45	12.10
					Bottom Shelf	28.47	22.26	13.29
	6H	30	23.88	81.50	File Drawer	25.90	15.02	9.25
					Total Hinged Door	28.47	22.26	52.87
					Top Shelf	28.47	19.45	12.62
					2nd Shelf	28.47	19.45	12.61
					3rd Shelf	28.47	19.45	12.10
					Bottom Shelf	28.47	22.26	13.29
Storage Box 18" Wide	5H	18	23.88	68.13	File Drawer	14.40	15.02	9.17
					Total Hinged Door	16.47	22.26	39.50
					Top Shelf	16.47	19.45	12.61
					Middle Shelf	16.47	19.45	12.10
					Bottom Shelf	16.47	22.26	13.29
	6H	18	23.88	81.50	File Drawer	14.40	15.02	9.17
					Total Hinged Door	16.47	22.26	52.87
					Top Shelf	16.47	19.45	12.62
					2nd Shelf	16.47	19.45	12.61
					3rd Shelf	16.47	19.45	12.10
					Bottom Shelf	16.47	22.26	13.29
Storage Box 18" Wide No Door	5H	18	23.88	68.13	File Drawer	14.40	15.02	9.17
					Total Shelf	16.47	22.26	39.50
					Top Shelf	16.47	19.45	12.61
					Middle Shelf	16.47	19.45	12.10
					Bottom Shelf	16.47	22.26	13.29

# DIMENSIONS

Silea  
02/24

DESCRIPTION	STYLE	EXTERNAL DIMENSIONS			LOCATION	INTERNAL DIMENSIONS		
		width	depth	height		width	depth	height
	6H	18	23.88	81.50	File Drawer	14.40	15.02	9.17
					Total Shelf	16.47	22.26	52.87
					Top Shelf	16.47	19.45	12.62
					2nd Shelf	16.47	19.45	12.61
					3rd Shelf	16.47	19.45	12.10
					Bottom Shelf	16.47	22.26	13.29
Utility Cabinet	5H	24	23.88	68.13	Closet	7.84	22.26	66.60
					File Drawer	11.40	15.02	9.17
					Total Hinged Door	13.47	22.32	39.53
					Top Shelf	13.47	19.45	12.61
					Middle Shelf	13.47	19.45	12.10
					Bottom Shelf	13.47	22.32	13.33
	6H	24	23.88	81.50	Closet Above Top Shelf	7.84	19.45	12.62
					Closet Below Top Shelf	7.84	22.26	66.61
					File Drawer	11.40	15.02	9.17
					Total Hinged Door	13.47	22.32	52.91
					Top Shelf	13.47	19.45	12.62
					2nd Shelf	13.47	19.45	12.61
Storage Cabinet	30"W	30	23.88	29.04	Total	28.47	22.26	26.38
					Top Shelf	28.47	21.45	12.78
					Bottom Shelf	28.47	22.26	12.85
	36"W	36	23.88	29.04	Total	34.47	22.26	26.38
					Top Shelf	34.47	21.45	12.72
					Bottom Shelf	34.47	22.26	12.85
Standard & Layers Side Access Storage Locker	5H w/ door	23 7/8	23.90	68.13	Inside Top Shelf	14.70	22.32	12.61
					Inside Bottom Shelf	14.70	22.32	12.85
					Top Side Access Shelf	21.55	15.41	12.25
					Bottom Side Access Shelf	21.55	15.47	11.97
	6H w/ door	23 7/8	23.90	81.50	Inside Shelf	14.70	21.12	12.62
					Inside Bottom Shelf	14.70	21.12	13.94
					Top Side Access Shelf	21.55	15.41	12.25
					Bottom Side Access Shelf	21.55	15.47	11.97
1H Wall Mount Cabinets – Hinged Door & Open Shelf	1H Hinged Door (16 1/5"D)	30"	See depth dimensions by style	14.13	Shelf	28.50	14.08	12.59
	1H Glass Door (16 1/4"D)	36"		14.13	Shelf	34.50	14.08	12.59
	1H Open (15 3/8"D)	42"	14.13	Left Shelf	19.67	14.08	12.59	
				Right Shelf	19.67	14.08	12.59	
		48"	14.13	Left Shelf	22.67	14.08	12.59	
				Right Shelf	22.67	14.08	12.59	
		54"	14.13	Left Shelf	25.67	14.08	12.59	
				Right Shelf	25.67	14.08	12.59	
		60"	14.13	Left Shelf	28.67	14.08	12.59	
				Right Shelf	28.67	14.08	12.59	
	66"	14.13	Left Shelf	31.67	14.08	12.59		



DESCRIPTION	STYLE	EXTERNAL DIMENSIONS			LOCATION	INTERNAL DIMENSIONS		
		width	depth	height		width	depth	height
					Right Shelf	31.67	14.08	12.59
		72"		14.13	Left Shelf	34.67	14.08	12.59
					Right Shelf	34.67	14.08	12.59
		78"		14.13	Left Shelf	37.67	14.08	12.59
					Right Shelf	37.67	14.08	12.59
		84"		14.13	Left Shelf	26.67	14.08	12.59
					Middle Shelf	26.84	14.08	12.59
					Right Shelf	26.67	14.08	12.59
		90"		14.13	Left Shelf	28.67	14.08	12.59
					Middle Shelf	28.84	14.08	12.59
					Right Shelf	28.67	14.08	12.59
		96"		14.13	Left Shelf	30.67	14.08	12.59
					Middle Shelf	30.84	14.08	12.59
					Right Shelf	30.67	14.08	12.59
		102"		14.13	Left Shelf	32.67	14.08	12.59
					Middle Shelf	32.84	14.08	12.59
					Right Shelf	32.67	14.08	12.59
		108"		14.13	Left Shelf	34.67	14.08	12.59
					Middle Shelf	34.84	14.08	12.59
					Right Shelf	34.67	14.08	12.59
1H Wall Mount Cabinets – Sliding Doors	1H	60"	16.20	14.13	Left Shelf	28.67	14.08	12.59
					Right Shelf	28.67	14.08	12.59
		72"	16.20	14.13	Left Shelf	34.67	14.08	12.59
					Right Shelf	34.67	14.08	12.59
		90"	16.20	14.13	Left Shelf	28.66	14.08	12.59
					Middle Shelf	28.86	14.08	12.59
					Right Shelf	28.66	14.08	12.59
		108"	16.20	14.13	Left Shelf	34.66	14.08	12.59
					Middle Shelf	34.86	14.08	12.59
					Right Shelf	34.66	14.08	12.59
2H Wall Mount Cabinets – Hinged Door & Open Shelf	2H Hinged Door (16 1/5"D)	30"	See depth dimensions by style	27.50	Top Shelf	28.50	13.95	12.61
	2H Glass Door (16 1/4"D)				Bottom Shelf	28.50	13.95	12.61
	2H Open (15 3/8"D)	36"		27.50	Top Shelf	34.50	13.95	12.61
					Bottom Shelf	34.50	13.95	12.61
		42"		27.50	Top Shelf Left	19.67	13.95	12.61
					Top Shelf Right	19.67	13.95	12.61
					Bottom Shelf Left	19.67	13.95	12.61
					Bottom Shelf Right	19.67	13.95	12.61
		48"		27.50	Top Shelf Left	22.67	13.95	12.61
					Top Shelf Right	22.67	13.95	12.61
					Bottom Shelf Left	22.67	13.95	12.61
					Bottom Shelf Right	22.67	13.95	12.61
		54"		27.50	Top Shelf Left	25.67	13.95	12.61
					Top Shelf Right	25.67	13.95	12.61
					Bottom Shelf Left	25.67	13.95	12.61

# DIMENSIONS

Silea

02/24

DESCRIPTION	STYLE	EXTERNAL DIMENSIONS			LOCATION	INTERNAL DIMENSIONS		
		width	depth	height		width	depth	height
					Bottom Shelf Right	25.67	13.95	12.61
		60"		27.50	Top Shelf Left	28.67	13.95	12.61
					Top Shelf Right	28.67	13.95	12.61
					Bottom Shelf Left	28.67	13.95	12.61
					Bottom Shelf Right	28.67	13.95	12.61
		66"		27.50	Top Shelf Left	31.67	13.95	12.58
					Top Shelf Right	31.67	13.95	12.58
					Bottom Shelf Left	31.67	13.95	12.58
					Bottom Shelf Right	31.67	13.95	12.58
		72"		27.50	Top Shelf Left	34.67	13.95	12.58
					Top Shelf Right	34.67	13.95	12.58
					Bottom Shelf Left	34.67	13.95	12.58
					Bottom Shelf Right	34.67	13.95	12.58
		78"		27.50	Top Shelf Left	37.67	13.95	12.58
					Top Shelf Right	37.67	13.95	12.58
					Bottom Shelf Left	37.67	13.95	12.58
					Bottom Shelf Right	37.67	13.95	12.58
		84"		27.50	Top Shelf Left	26.67	13.95	12.61
					Top Shelf Middle	26.84	13.95	12.61
					Top Shelf Right	12.67	13.95	12.61
					Bottom Shelf Left	26.67	14.08	12.61
					Bottom Shelf Middle	26.84	14.08	12.61
					Bottom Shelf Right	26.67	14.08	12.61
		90"		27.50	Top Shelf Left	28.67	13.95	12.61
					Top Shelf Middle	28.84	13.95	12.61
					Top Shelf Right	28.67	13.95	12.61
					Bottom Shelf Left	28.67	14.08	12.61
					Bottom Shelf Middle	28.84	14.08	12.61
					Bottom Shelf Right	28.67	14.08	12.61
2H Wall Mount Cabinets – Sliding Doors	2H	60"	16.20	27.50	Top Shelf Left	28.67	12.89	12.61
					Top Shelf Right	28.67	12.89	12.61
					Bottom Shelf Left	28.67	13.41	12.61
					Bottom Shelf Right	28.67	13.41	12.61
		72"	16.20	27.50	Top Shelf Left	34.67	12.89	12.58
					Top Shelf Right	34.67	12.89	12.58
					Bottom Shelf Left	34.67	13.41	12.58
					Bottom Shelf Right	34.67	13.41	12.58
		90"	16.20	27.50	Top Shelf Left	28.66	12.89	12.61
					Top Shelf Middle	28.86	12.89	12.61
					Top Shelf Right	28.66	12.89	12.61
					Bottom Shelf Left	28.66	13.41	12.61
					Bottom Shelf Middle	28.86	13.41	12.61
					Bottom Shelf Right	28.66	13.41	12.61

DESCRIPTION	STYLE	EXTERNAL DIMENSIONS			LOCATION	INTERNAL DIMENSIONS		
		width	depth	height		width	depth	height
1H Surface Mount Cabinets – Hinged Door & Open Shelf	1H Hinged Door (15 2/3"D)	60"	See depth dimensions by style	39.09	Cabinet Left	28.67	14.11	12.61
	1H Glass Door (15 3/4"D)				Cabinet Right	28.67	14.11	12.61
	1H Open (14 7/8"D)				Tackzone	58.50	14.25	24.97
		66"		39.09	Cabinet Left	31.67	14.11	12.61
					Cabinet Right	31.67	14.11	12.61
					Tackzone	64.50	14.25	24.97
		72"		39.09	Cabinet Left	34.67	14.11	12.61
					Cabinet Right	34.67	14.11	12.61
					Tackzone	70.50	14.25	24.97
		78"		39.09	Cabinet Left	37.67	14.11	12.61
					Cabinet Right	37.67	14.11	12.61
					Tackzone	76.50	14.25	24.97
		84"		39.09	Cabinet Left	26.67	14.11	12.61
					Cabinet Middle	26.84	14.11	12.61
					Cabinet Right	26.67	14.11	12.61
					Tackzone	82.50	14.25	24.97
		90"		39.09	Cabinet Left	28.67	14.11	12.61
					Cabinet Middle	28.84	14.11	12.61
					Cabinet Right	28.67	14.11	12.61
					Tackzone	88.50	14.25	24.97
		96"		39.09	Cabinet Left	30.67	14.11	12.61
					Cabinet Middle	30.84	14.11	12.61
					Cabinet Right	30.67	14.11	12.61
					Tackzone	94.50	14.25	24.97
	102"		39.09	Cabinet Left	32.67	14.11	12.61	
				Cabinet Middle	32.84	14.11	12.61	
				Cabinet Right	32.67	14.11	12.61	
				Tackzone	100.50	14.25	24.97	
	108"		39.09	Cabinet Left	34.67	14.11	12.61	
				Cabinet Middle	34.84	14.11	12.61	
				Cabinet Right	34.67	14.11	12.61	
				Tackzone	106.50	14.13	24.97	
2H Surface Mount Cabinets – Hinged Door & Open Shelf	2H Hinged Door (15 2/3"D)	60"	See depth dimensions by style	52.47	Top Shelf Left	28.67	13.98	12.61
	2H Glass Door (15 3/4"D)				Top Shelf Right	28.67	13.98	12.61
	2H Open (14 7/8"D)				Bottom Shelf Left	28.67	14.11	12.63
					Bottom Shelf Right	28.67	14.11	12.63
					Tackzone	58.50	14.25	24.97
		66"		52.47	Top Shelf Left	31.67	13.98	15.58
					Top Shelf Right	31.67	13.98	15.58
					Bottom Shelf Left	31.67	14.11	12.60
					Bottom Shelf Right	31.67	14.11	12.60
					Tackzone	64.50	14.25	24.97
		72"		52.47	Top Shelf Left	31.67	13.98	12.58
					Top Shelf Right	31.67	13.98	12.58
				Bottom Shelf Left	31.67	14.11	12.60	

# DIMENSIONS

Silea  
02/24

DESCRIPTION	STYLE	EXTERNAL DIMENSIONS			LOCATION	INTERNAL DIMENSIONS			
		width	depth	height		width	depth	height	
					Bottom Shelf Right	31.67	14.11	12.60	
					Tackzone	64.50	14.25	24.97	
		78"		52.47	Top Shelf Left	37.67	13.98	12.58	
					Top Shelf Right	37.67	13.98	12.58	
					Bottom Shelf Left	37.67	14.11	12.60	
					Bottom Shelf Right	37.67	14.11	12.60	
					Tackzone	76.50	14.25	24.97	
		84"		52.47	Top Shelf Left	26.67	13.98	12.61	
					Top Shelf Middle	26.84	13.98	12.61	
					Top Shelf Right	26.67	13.98	12.61	
					Bottom Shelf Left	26.67	14.11	12.63	
					Bottom Shelf Middle	26.84	14.11	12.63	
					Bottom Shelf Right	26.67	14.11	12.63	
					Tackzone	82.50	14.25	24.97	
		90"		52.47	Top Shelf Left	28.67	13.98	12.61	
					Top Shelf Middle	28.84	13.98	12.61	
					Top Shelf Right	28.67	13.98	12.61	
					Bottom Shelf Left	28.67	14.11	12.63	
					Bottom Shelf Middle	28.84	14.11	12.63	
					Bottom Shelf Right	28.67	14.11	12.63	
					Tackzone	88.50	14.25	24.97	
1H Surface Mount Towers – Hinged Door & Open Shelf	1H Hinged Door (15 3/4"D)	15"	See depth dimensions by style	39.09	Top Shelf	13.50	13.91	12.61	
	1H Glass Door (15 4/5"D)			Middle Shelf	13.50	13.91	12.17		
	1H Open (14 7/8"D)			Bottom Shelf	13.50	14.07	11.30		
			18"		39.09	Top Shelf	16.50	13.91	12.61
						Middle Shelf	16.50	13.91	12.17
						Bottom Shelf	16.50	14.07	11.30
			30"		39.09	Top Shelf	28.50	13.91	12.61
						Middle Shelf	28.50	13.91	12.17
						Bottom Shelf	28.50	14.07	11.30
			36"		39.09	Top Shelf	34.50	13.91	12.55
						Middle Shelf	34.50	13.91	12.11
						Bottom Shelf	34.50	14.07	11.30
2H Surface Mount Towers - Hinged Door & Open Shelf	2H Hinged Door (15 3/4"D)	15"	See depth dimensions by style	52.47	Top Shelf	13.50	13.91	12.61	
	2H Glass Door (15 4/5"D)			2nd Shelf	13.50	13.91	12.63		
	2H Open (14 7/8"D)			3rd Shelf	13.50	13.91	12.17		
						Bottom Shelf	13.50	14.07	11.30
			18"		52.47	Top Shelf	16.50	13.91	12.61
						2nd Shelf	16.50	13.91	12.63
						3rd Shelf	16.50	13.91	12.17
						Bottom Shelf	16.50	14.07	11.30
			30"		52.47	Top Shelf	28.50	13.91	12.61
						2nd Shelf	28.50	13.91	12.63
						3rd Shelf	28.50	13.91	12.17
						Bottom Shelf	28.50	14.07	11.30

DESCRIPTION	STYLE	EXTERNAL DIMENSIONS			LOCATION	INTERNAL DIMENSIONS			
		width	depth	height		width	depth	height	
		36"		52.47	Top Shelf	34.50	13.91	12.55	
					2nd Shelf	34.50	13.91	12.57	
					3rd Shelf	34.50	13.91	12.11	
					Bottom Shelf	34.50	14.07	11.30	
WorkWall	Wall Mount	72"	19.69	39.09	Collaboration Side Tackzone	34.26	11.55	36.73	
					Personal Side Tackzone	34.26	16.30	25.13	
					Personal Side Drawer	26.40	13.09	2.91	
		90°	19.69	39.09	Collaboration Side Tackzone	43.26	11.55	36.73	
	Personal Side Tackzone				43.26	16.30	25.13		
	Personal Side Drawer				32.40	13.09	2.91		
	Wall Mount w/ Wall	72"	19.69	68.13	Collaboration Side Tackzone	34.26	11.55	36.73	
	Access Panel				Personal Side Tackzone	34.26	16.27	25.13	
					Personal Side Drawer	26.40	13.09	2.91	
		90°	19.69	68.13	Wall Access Panel	34.50	6.49	29.06	
					Collaboration Side Tackzone	43.26	11.55	36.73	
					Personal Side Tackzone	43.26	16.27	25.13	
					Personal Side Drawer	32.40	13.09	2.91	
					Wall Access Panel	43.50	6.48	29.06	
	Stack On	72"	19.69	39.09	Collaboration Side Tackzone	34.26	10.38	36.41	
						Personal Side Tackzone	34.26	17.30	36.41
						Personal Side Shelf	34.26	12.70	11.81
			90°	19.69	39.09	Collaboration Side Tackzone	43.26	10.38	36.41
						Personal Side Tackzone	43.26	17.30	36.41
						Personal Side Shelf	43.26	12.70	11.81
	Freestanding	72"	23.74	75.50	Collaboration Side Tackzone	34.47	10.95	39.49	
						Collaboration Side Drawer	26.40	13.09	2.91
						Collaboration Side Top Shelf	34.47	12.20	13.33
						Collaboration Side Bottom Shelf	34.47	12.26	12.10
					Personal Side Tackzone	34.47	16.29	32.35	
					Personal Side Drawer Top	32.40	13.09	2.91	
					Personal Side Drawer 2nd	31.90	15.02	9.25	
					Personal Side Drawer Bottom	31.90	15.02	9.25	
					90°	23.74	75.50	Collaboration Side Tackzone	43.48
		Collaboration Side Drawer	32.40	13.09				2.91	
		Collaboration Side Top Shelf	43.48	12.20				13.33	
		Collaboration Side Bottom Shelf	43.48	12.26				12.10	
		Personal Side Tackzone	34.47	16.29				32.35	
		Personal Side Drawer Top	32.40	13.09				2.91	
		Personal Side Drawer 2nd	31.90	15.02				9.25	
		Personal Side Drawer Bottom	31.90	15.02				9.25	
								Closet above the Shelf	7.85
					Closet below the Shelf	7.85	17.29	12.10	
				Personal Side Drawer Bottom	31 <sup>8</sup> / <sub>9</sub>	15	9 <sup>1</sup> / <sub>4</sub>		
				Closet above the Shelf	7 <sup>6</sup> / <sub>7</sub>	17 <sup>2</sup> / <sub>9</sub>	59 <sup>4</sup> / <sub>5</sub>		
				Closet below the Shelf	7 <sup>6</sup> / <sub>7</sub>	17 <sup>2</sup> / <sub>7</sub>	12		

The typicals shown below include best practices for specifying grain direction on worksurfaces.



**LONG GRAIN:**  
Grain runs width of top



**SHORT GRAIN:**  
Grain runs depth of top

## RECOMMENDATIONS

- Grain should run parallel to one another when crossing over worksurface segments
- Avoid running the grain end-to-end when crossing over worksurface segments

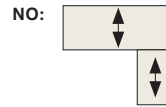

## LAMINATE GUIDELINES

- **Laminate worksurfaces:** Optional grain direction is available on worksurfaces up to 60". For worksurfaces above 60", long grain is standard.
- **Laminate modesty and wall access panels:** Grain direction is not optional. Grain runs vertically on panels up to and including 60". Grain runs horizontally on panels over 60".

### FREESTANDING

Desk: Long Grain  
Credenza: Long Grain

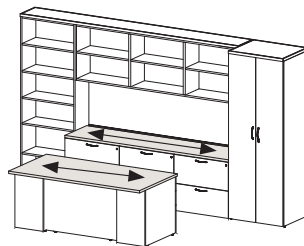

### U-STATION

Desk: Long Grain  
Bridge: Short Grain  
Credenza: Long Grain

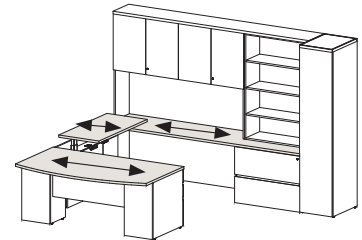

### T-STATION

Desk: Long Grain  
Return: Short Grain  
Hinged Door Cabinet: Short Grain

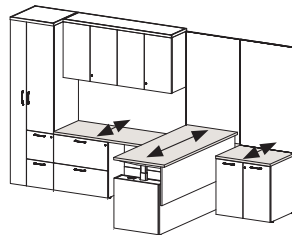

### T-STATION WITH LAYERS

Desk: Long Grain  
Layers Credenza: Short Grain

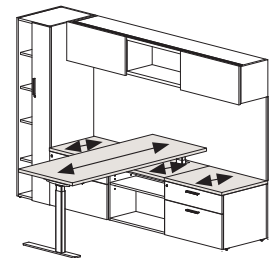

### L-STATION

Desk: Long Grain  
Return: Short Grain

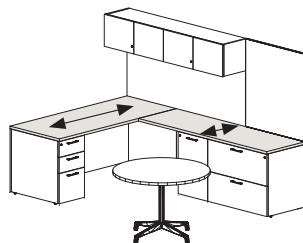

### L-STATION



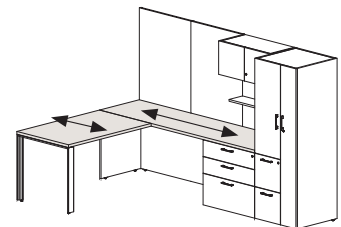

Runoff Desk: Short Grain  
Credenza: Long Grain

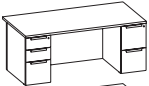

- Unitized Casegoods . . . . .49-76
  - Double Pedestal Desk . . . . . 50
  - Single Pedestal Desk . . . . . 51-52
  - Runoff Desks . . . . . 53
  - Layers Runoff W/ Layers Box / Laptop Drawer . . . . . 54-55
  - Double Pedestal Credenza . . . . . 56
  - Single Pedestal Credenza . . . . . 57
  - Full Bank Credenza . . . . . 58-59
  - Returns . . . . . 60
  - Rectangular Table Desk & Extensions . . . . . 61-63
  - Runoffs . . . . . 64
  - Rectangular Runoff . . . . . 65
  - Layers Rectangular Runoff W/ Layers Box /  
Laptop Drawer . . . . . 66-67
  - Ellipse Table Desk . . . . . 68
  - Layers Ellipse Runoff W/ Layers Box . . . . . 69
  - Arc Boat Table Desk . . . . . 70
  - Layers Arc Boat Runoff W/Layers Box . . . . . 71
  - Sightline Runoff . . . . . 72
  - Layers Sightline Runoff W/ Layers Box /  
Laptop Drawer . . . . . 73-74
  - Layers Cockpit Runoff W/ Layers Box . . . . . 75
  - Media Top . . . . . 76

# DOUBLE PEDESTAL DESK

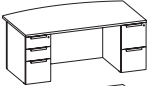
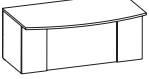
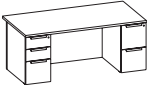
Silea  
02/24

	D	W	H	model number + type	laminate	veneer 1	veneer 2	veneer 3
 	36	72	29 1/2	<b>GS2DROB3672-32</b> [ ]	5,715	7,568	8,325	9,082
				<ul style="list-style-type: none"> <li>• 15" wide pedestals</li> <li>• 30" depth pedestals</li> <li>• 3/4" breakfront modesty</li> <li>• 6" overhang</li> </ul>				
 	42	72	29 1/2	<b>GS2DBOB4272-32</b> [ ]	6,183	8,227	9,050	9,873
Bow front				<ul style="list-style-type: none"> <li>• 15" wide pedestals</li> <li>• 30" depth pedestals</li> <li>• 3/4" breakfront modesty</li> <li>• 6" overhang</li> <li>• 12" overhang at center</li> </ul>				
 	36	72	29 1/2	<b>GS2DROF3672-32</b> [ ]	5,410	7,172	7,890	8,607
				<ul style="list-style-type: none"> <li>• 15" wide pedestals</li> <li>• 30" depth pedestals</li> <li>• Flush front modesty</li> <li>• 6" overhang</li> </ul>				

## PRODUCT INFO

Wood tops optional grain.

Laminate tops long grain standard.

 Units shipped as separate packages and require field assembly.

### Grommet Location (Add \$80 per grommet)

No Grommet **GN**  
 Left **GL**  
 Right **GR**  
 Left & Right **GB**

Specify location first, then select grommet color or "Empty Cutout" option. When "Empty Cutout" option is selected, a grommet or power unit must be ordered separately for each cutout.

## TO ORDER PLEASE SPECIFY THE FOLLOWING:







### WOOD TOP, WOOD CHASSIS

1. **MODEL NUMBER + WW**
2. **FSC**
3. **TOP WOOD FINISH + EDGE**
4. **CHASSIS WOOD FINISH**
5. **TOP FINISH**
6. **GRAIN DIRECTION**
7. **PULL**
8. **DRAWERS**
9. **GROMMET**
10. **KEYING**

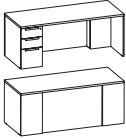
### LAM TOP, LAM CHASSIS

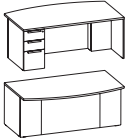
1. **MODEL NUMBER + LL**
2. **FSC**
3. **TOP LAM**
4. **CHASSIS LAM**
5. **FRONT LAM**
6. **EDGE DETAIL**
7. **PULL**
8. **DRAWERS**
9. **GROMMET**
10. **KEYING**

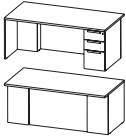

	D	W	H	model number + type	laminate	veneer 1	veneer 2	veneer 3	
<b>LEFT HAND</b> 	30	60	29 1/2	<b>GS2DRFB3060L-3</b> <input type="checkbox"/>	4,068	5,403	5,944	6,484	
	30	66	29 1/2	<b>GS2DRFB3066L-3</b> <input type="checkbox"/>	4,190	5,568	6,125	6,682	
	30	72	29 1/2	<b>GS2DRFB3072L-3</b> <input type="checkbox"/>	4,319	5,741	6,316	6,890	
	• 3/4" breakfront modesty								
	36	72	29 1/2	<b>GS2DROB3672L-3</b> <input type="checkbox"/>	4,396	5,852	6,438	7,023	
	36	78	29 1/2	<b>GS2DROB3678L-3</b> <input type="checkbox"/>	4,556	6,066	6,673	7,280	
	• 3/4" breakfront modesty • 6" overhang								
	42	72	29 1/2	<b>GS2DBOB4272L-3</b> <input type="checkbox"/>	4,864	6,511	7,163	7,814	
	• 3/4" breakfront modesty • 6" overhang • 12" overhang at center								
<b>RIGHT HAND</b> 	30	60	29 1/2	<b>GS2DRFB3060R-3</b> <input type="checkbox"/>	4,068	5,403	5,944	6,484	
	30	66	29 1/2	<b>GS2DRFB3066R-3</b> <input type="checkbox"/>	4,190	5,568	6,125	6,682	
	30	72	29 1/2	<b>GS2DRFB3072R-3</b> <input type="checkbox"/>	4,319	5,741	6,316	6,890	
	• 3/4" breakfront modesty								
	36	72	29 1/2	<b>GS2DROB3672R-3</b> <input type="checkbox"/>	4,396	5,852	6,438	7,023	
	36	78	29 1/2	<b>GS2DROB3678R-3</b> <input type="checkbox"/>	4,556	6,066	6,673	7,280	
	• 3/4" breakfront modesty • 6" overhang								
	42	72	29 1/2	<b>GS2DBOB4272R-3</b> <input type="checkbox"/>	4,864	6,511	7,163	7,814	
	• 3/4" breakfront modesty • 6" overhang • 12" overhang at center								

**PRODUCT INFO**

Wood tops optional grain.  
Laminate tops optional grain up to 60", over 60" long grain standard.  
 Units shipped as separate packages and require field assembly.

**Grommet Location**  
(Add \$80 per grommet)  
No Grommet **GN**  
Left **GL**  
Right **GR**  
Left & Right **GB**

Specify location first, then select grommet color or "Empty Cutout" option.  
When "Empty Cutout" option is selected, a grommet or power unit must be ordered separately for each cutout.



**TO ORDER PLEASE SPECIFY THE FOLLOWING:**

- |                                  |   |
|----------------------------------|---|
| WOOD TOP, WOOD CHASSIS           | LAM TOP, LAM CHASSIS                        |
| 1. <b>MODEL NUMBER + WW</b>      | 1. <b>MODEL NUMBER + LL</b>                 |
| 2. <b>FSC</b>                    | 2. <b>FSC</b>                               |
| 3. <b>TOP WOOD FINISH + EDGE</b> | 3. <b>TOP LAM</b>                           |
| 4. <b>CHASSIS WOOD FINISH</b>    | 4. <b>CHASSIS LAM</b>                       |
| 5. <b>TOP FINISH</b>             | 5. <b>FRONT LAM</b>                         |
| 6. <b>GRAIN DIRECTION</b>        | 6. <b>GRAIN DIRECTION (60W models only)</b> |
| 7. <b>PULL</b>                   | 7. <b>EDGE DETAIL</b>                       |
| 8. <b>DRAWERS</b>                | 9. <b>PULL</b>                              |
| 9. <b>GROMMET</b>                | 10. <b>DRAWERS</b>                          |
| 10. <b>KEYING</b>                | 11. <b>GROMMET</b>                          |
|                                  | 12. <b>KEYING</b>                           |

# SINGLE PEDESTAL DESK

15" Pedestals | Flush Front Modesty

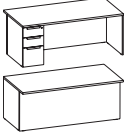
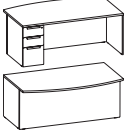
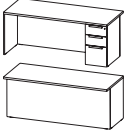
Silea  
02/24

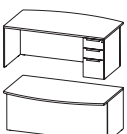
	D	W	H	model number + type	laminate	veneer 1	veneer 2	veneer 3
<b>LEFT HAND</b> 	30	60	29 1/2	<b>GS2DROF3060L-3</b> [ ]	3,854	5,334	5,868	6,401
	30	66	29 1/2	<b>GS2DROF3066L-3</b> [ ]	3,969	5,490	6,039	6,588
	30	72	29 1/2	<b>GS2DROF3072L-3</b> [ ]	4,089	5,652	6,218	6,783
	• 6" overhang							
	36	72	29 1/2	<b>GS2DROF3672L-3</b> [ ]	4,259	5,726	6,299	6,872
	36	78	29 1/2	<b>GS2DROF3678L-3</b> [ ]	4,406	5,925	6,518	7,110
	• 6" overhang							
 Bow front	42	72	29 1/2	<b>GS2DBOF4272L-3</b> [ ]	4,727	6,385	7,024	7,662
	• 6" overhang							
	• 12" overhang at center							
<b>RIGHT HAND</b> 	30	60	29 1/2	<b>GS2DROF3060R-3</b> [ ]	3,854	5,334	5,868	6,401
	30	66	29 1/2	<b>GS2DROF3066R-3</b> [ ]	3,969	6,099	6,709	7,319
	30	72	29 1/2	<b>GS2DROF3072R-3</b> [ ]	4,089	5,652	6,218	6,783
	• 6" overhang							
	36	72	29 1/2	<b>GS2DROF3672R-3</b> [ ]	4,259	5,726	6,299	6,872
	36	78	29 1/2	<b>GS2DROF3678R-3</b> [ ]	4,406	5,925	6,518	7,110
	• 6" overhang							
 Bow front	42	72	29 1/2	<b>GS2DBOF4272R-3</b> [ ]	4,727	6,385	7,024	7,662
	• 6" overhang							
	• 12" overhang at center							

## PRODUCT INFO

Wood tops optional grain.

Laminate tops long grain standard.

 Units shipped as separate packages and require field assembly.

### Grommet Location

(Add \$80 per grommet)

No Grommet **GN**  
 Left **GL**  
 Right **GR**  
 Left & Right **GB**

Specify location first, then select grommet color or "Empty Cutout" option. When "Empty Cutout" option is selected, a grommet or power unit must be ordered separately for each cutout.

## TO ORDER PLEASE SPECIFY THE FOLLOWING:

WOOD TOP, WOOD CHASSIS

- MODEL NUMBER + WW**
- FSC**
- TOP WOOD FINISH + EDGE**
- CHASSIS WOOD FINISH**
- TOP FINISH**
- GRAIN DIRECTION**
- PULL**
- DRAWERS**
- GROMMET**
- KEYING**

LAM TOP, LAM CHASSIS

- MODEL NUMBER + LL**
- FSC**
- TOP LAM**
- CHASSIS LAM**
- FRONT LAM**
- GRAIN DIRECTION (60W models only)**
- EDGE DETAIL**
- PULL**
- DRAWERS**
- GROMMET**
- KEYING**

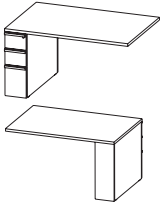
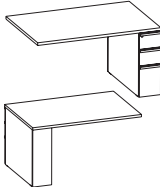
	D	W	H	model number + type	laminata	veneer 1	veneer 2	veneer 3
<b>LEFT HAND</b> 	30	48	29 1/2	<b>GS2RRO3048L-3</b> [ ]	3,018	4,198	4,618	5,038
	30	54	29 1/2	<b>GS2RRO3054L-3</b> [ ]	3,029	4,216	4,638	5,060
	36	54	29 1/2	<b>GS2RRO3654L-3</b> [ ]	3,202	4,447	4,892	5,337
	36	60	29 1/2	<b>GS2RRO3660L-3</b> [ ]	3,223	4,476	4,924	5,372
• Flat brackets ordered separately (model #MDWBRK)								
<b>RIGHT HAND</b> 	30	48	29 1/2	<b>GS2RRO3048R-3</b> [ ]	3,018	4,198	4,618	5,038
	30	54	29 1/2	<b>GS2RRO3054R-3</b> [ ]	3,029	4,216	4,638	5,060
	36	54	29 1/2	<b>GS2RRO3654R-3</b> [ ]	3,202	4,447	4,892	5,337
	36	60	29 1/2	<b>GS2RRO3660R-3</b> [ ]	3,223	4,476	4,924	5,372
• Narrow 9 7/16" width pedestal • Flat brackets ordered separately (model #MDWBRK)								

**PRODUCT INFO**

Specify pedestal location from user seated position.

All tops optional grain.

 Units shipped as separate packages and require field assembly.

Modesty panel ordered separately.

**Grommet Location**  
(Add \$80 per grommet)

No Grommet **GN**  
Left **GL**  
Right **GR**  
Left & Right **GB**

Specify location first, then select grommet color or "Empty Cutout" option. When "Empty Cutout" option is selected, a grommet or power unit must be ordered separately for each cutout.

**TO ORDER PLEASE SPECIFY THE FOLLOWING:**

WOOD TOP, WOOD CHASSIS

- MODEL NUMBER + WW**
- FSC**
- TOP WOOD FINISH + EDGE**
- CHASSIS WOOD FINISH**
- TOP FINISH**
- GRAIN DIRECTION**
- PULL**
- DRAWERS**
- GROMMET**
- KEYING**

LAM TOP, LAM CHASSIS

- MODEL NUMBER + LL**
- FSC**
- TOP LAM**
- CHASSIS LAM**
- FRONT LAM**
- GRAIN DIRECTION (60W models only)**
- EDGE DETAIL**
- PULL**
- DRAWERS**
- GROMMET**
- KEYING**

# LAYERS RUNOFF DESKS W/LAYERS BOX

Left and Right Hand | BBF Pedestal

Silea

02/24

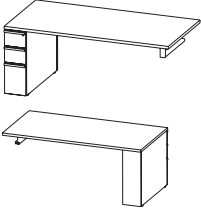
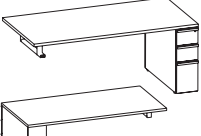
	D	W	H	model number + type	laminate	veneer 1	veneer 2	veneer 3
<b>LEFT HAND</b> 	30	66	29 1/2	<b>GS2RLO3066L-3</b> [ ]	3,612	4,820	5,302	5,784
	30	72	29 1/2	<b>GS2RLO3072L-3</b> [ ]	3,668	4,897	5,387	5,877
	36	72	29 1/2	<b>GS2RLO3672L-3</b> [ ]	3,897	5,197	5,717	6,237
	36	78	29 1/2	<b>GS2RLO3678L-3</b> [ ]	3,981	5,313	5,845	6,376
<b>RIGHT HAND</b> 	30	66	29 1/2	<b>GS2RLO3066R-3</b> [ ]	3,612	4,820	5,302	5,784
	30	72	29 1/2	<b>GS2RLO3072R-3</b> [ ]	3,668	4,897	5,387	5,877
	36	72	29 1/2	<b>GS2RLO3672R-3</b> [ ]	3,897	5,197	5,717	6,237
	36	78	29 1/2	<b>GS2RLO3678R-3</b> [ ]	3,981	5,313	5,845	6,376

- Box | Box | File pedestal
- Narrow 9 7/16" width pedestal

### Layers Box

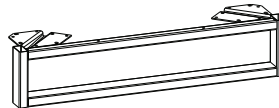

Side view

### PRODUCT INFO

Specify pedestal location from user seated position.

All tops long grain standard.

 Units shipped as separate packages and require field assembly.

#### Grommet Location (Add \$80 per grommet)

No Grommet **GN**  
 Left **GL**  
 Right **GR**  
 Left & Right **GB**

Specify location first, then select grommet color or "Empty Cutout" option. When "Empty Cutout" option is selected, a grommet or power unit must be ordered separately for each cutout.

### TO ORDER PLEASE SPECIFY THE FOLLOWING:

#### WOOD TOP, WOOD CHASSIS

1. **MODEL NUMBER + WW**
2. **FSC**
3. **TOP WOOD FINISH + EDGE**
4. **CHASSIS WOOD FINISH**
5. **TOP FINISH**
6. **PULL**
7. **HARDWARE COLOR (Layers Box)**
8. **DRAWERS**
9. **GROMMET**
10. **KEYING**

#### LAM TOP, LAM CHASSIS

1. **MODEL NUMBER + LL**
2. **FSC**
3. **TOP LAM**
4. **CHASSIS LAM**
5. **FRONT LAM**
6. **EDGE DETAIL**
7. **PULL**
8. **HARDWARE COLOR (Layers Box)**
9. **DRAWERS**
10. **GROMMET**
11. **KEYING**

# LAYERS RUNOFF DESKS W/ LAPTOP DRAWER

Left and Right Hand | BBF Pedestal

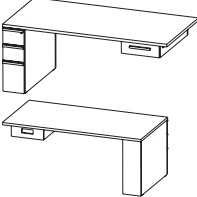
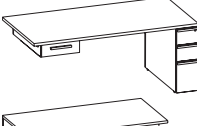
	D	W	H	model number + type	laminate	veneer 1	veneer 2	veneer 3
<b>LEFT HAND</b> 	30	66	29 1/2	<b>GS2RLOS3066L-3</b> [ ]	4,031	5,581	6,140	6,698
	30	72	29 1/2	<b>GS2RLOS3072L-3</b> [ ]	4,086	5,657	6,223	6,789
	36	72	29 1/2	<b>GS2RLOS3672L-3</b> [ ]	4,338	5,941	6,536	7,130
	36	78	29 1/2	<b>GS2RLOS3678L-3</b> [ ]	4,421	6,056	6,662	7,268
<b>RIGHT HAND</b> 	30	66	29 1/2	<b>GS2RLOS3066R-3</b> [ ]	4,031	5,581	6,140	6,698
	30	72	29 1/2	<b>GS2RLOS3072R-3</b> [ ]	4,086	5,657	6,223	6,789
	36	72	29 1/2	<b>GS2RLOS3672R-3</b> [ ]	4,338	5,941	6,536	7,130
	36	78	29 1/2	<b>GS2RLOS3678R-3</b> [ ]	4,421	6,056	6,662	7,268

- Box | Box | File pedestal
- Narrow 9 7/16" width pedestal

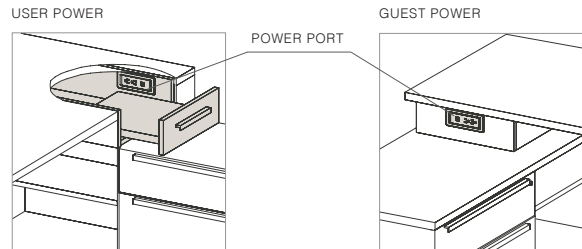

## PRODUCT INFO

Specify pedestal location from user seated position.

All tops long grain standard.

 Units shipped as separate packages and require field assembly.

Power units included (2 USB, 2 power)

### Grommet Location

(Add \$80 per grommet)

No Grommet **GN**  
 Left **GL**  
 Right **GR**  
 Left & Right **GB**

Specify location first, then select grommet color or "Empty Cutout" option. When "Empty Cutout" option is selected, a grommet or power unit must be ordered separately for each cutout.

## TO ORDER PLEASE SPECIFY THE FOLLOWING:

WOOD TOP, WOOD CHASSIS

1. **MODEL NUMBER + WW**
2. **FSC**
3. **TOP WOOD FINISH + EDGE**
4. **CHASSIS WOOD FINISH**
5. **TOP FINISH**
6. **PULL – PEDESTAL**
7. **PULL – LAPTOP DRAWER**
8. **DRAWERS**
9. **GROMMET**
10. **KEYING**
11. **POWER UNIT**

LAM TOP, LAM CHASSIS

1. **MODEL NUMBER + LL**
2. **FSC**
3. **TOP LAM**
4. **CHASSIS LAM**
5. **FRONT LAM**
6. **EDGE DETAIL**
7. **PULL**
8. **DRAWERS**
9. **GROMMET**
10. **KEYING**
11. **POWER UNIT**

# DOUBLE PEDESTAL CREDENZA

15" Pedestals

Silea  
02/24

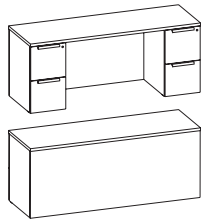

D	W	H	model number + type	laminata	veneer 1	veneer 2	veneer 3
24	72	29 1/2	<b>GS2DPC2472-22</b> [ ]	5,241	7,359	8,095	8,831

- File | File pedestal

## PRODUCT INFO

Wood tops optional grain.

Laminate tops long grain standard.

 Units shipped as separate packages and require field assembly.

### Grommet Location (Add \$80 per grommet)

No Grommet **GN**  
Left **GL**  
Right **GR**  
Left & Right **GB**

Specify location first, then select grommet color or "Empty Cutout" option. When "Empty Cutout" option is selected, a grommet or power unit must be ordered separately for each cutout.

## TO ORDER PLEASE SPECIFY THE FOLLOWING:

### WOOD TOP, WOOD CHASSIS

- MODEL NUMBER + WW**
- FSC**
- TOP WOOD FINISH + EDGE**
- CHASSIS WOOD FINISH**
- TOP FINISH**
- GRAIN DIRECTION**
- PULL**
- DRAWERS**
- GROMMET**
- MODESTY**
- KEYING**

### LAM TOP, LAM CHASSIS

- MODEL NUMBER + LL**
- FSC**
- TOP LAM**
- CHASSIS LAM**
- FRONT LAM**
- EDGE DETAIL**
- PULL**
- DRAWER**
- GROMMET**
- MODESTY**
- KEYING**

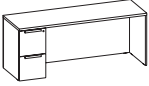
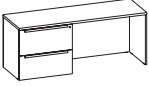
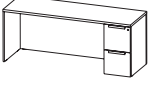
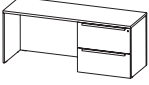
	D	W	H	model number + type	laminata	veneer 1	veneer 2	veneer 3
<b>LEFT HAND</b> 	24	66	29 1/2	<b>GS2SPC2466L-2</b> <input type="checkbox"/>	3,336	4,680	5,148	5,616
	24	72	29 1/2	<b>GS2SPC2472L-2</b> <input type="checkbox"/>	3,455	4,852	5,338	5,823
	• 15" W pedestal							
	24	72	29 1/2	<b>GS2SPC2472L-4</b> <input type="checkbox"/>	3,891	5,466	6,013	6,560
	24	78	29 1/2	<b>GS2SPC2478L-4</b> <input type="checkbox"/>	3,961	5,561	6,118	6,674
	24	84	29 1/2	<b>GS2SPC2484L-4</b> <input type="checkbox"/>	4,027	5,656	6,222	6,788
	24	90	29 1/2	<b>GS2SPC2490L-4</b> <input type="checkbox"/>	4,214	5,917	6,509	7,101
	24	96	29 1/2	<b>GS2SPC2496L-4</b> <input type="checkbox"/>	4,362	6,127	6,740	7,353
	• 30" W pedestal							
<b>RIGHT HAND</b> 	24	66	29 1/2	<b>GS2SPC2466R-2</b> <input type="checkbox"/>	3,336	4,680	5,148	5,616
	24	72	29 1/2	<b>GS2SPC2472R-2</b> <input type="checkbox"/>	3,455	4,852	5,338	5,823
	• 15" W pedestal							
	24	72	29 1/2	<b>GS2SPC2472R-4</b> <input type="checkbox"/>	3,891	5,466	6,013	6,560
	24	78	29 1/2	<b>GS2SPC2478R-4</b> <input type="checkbox"/>	3,961	5,561	6,118	6,674
	24	84	29 1/2	<b>GS2SPC2484R-4</b> <input type="checkbox"/>	4,027	5,656	6,222	6,788
	24	90	29 1/2	<b>GS2SPC2490R-4</b> <input type="checkbox"/>	4,214	5,917	6,509	7,101
	24	96	29 1/2	<b>GS2SPC2496R-4</b> <input type="checkbox"/>	4,362	6,127	6,740	7,353
	• 30" W pedestal							

**PRODUCT INFO**

Wood tops optional grain.

Laminate tops long grain standard.

 Units shipped as separate packages and require field assembly.

**Grommet Location**  
(Add \$80 per grommet)

No Grommet **GN**  
Left **GL**  
Right **GR**  
Left & Right **GB**

Specify location first, then select grommet color or "Empty Cutout" option. When "Empty Cutout" option is selected, a grommet or power unit must be ordered separately for each cutout.

**TO ORDER PLEASE SPECIFY THE FOLLOWING:**

WOOD TOP, WOOD CHASSIS

- MODEL NUMBER + WW**
- FSC**
- TOP WOOD FINISH + EDGE**
- CHASSIS WOOD FINISH**
- TOP FINISH**
- GRAIN DIRECTION**
- PULL**
- DRAWERS**
- GROMMET**
- MODESTY**
- KEYING**

LAM TOP, LAM CHASSIS



- MODEL NUMBER + LL**
- FSC**
- TOP LAM**
- CHASSIS LAM**
- FRONT LAM**
- EDGE DETAIL**
- PULL**
- DRAWER**
- GROMMET**
- MODESTY**
- KEYING**

# FULL BANK CREDENZA

Lateral File

Silea

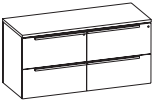
02/24

	D	W	H	model number + type	laminare	veneer 1	veneer 2	veneer 3
	24	60	29 1/2	<b>GS2FSC2460-44</b> [ ]	5,360	7,300	8,030	8,760
	24	72	29 1/2	<b>GS2FSC2472-44</b> [ ]	5,709	7,776	8,554	9,332

## PRODUCT INFO

All tops long grain standard.  
Ships assembled.

## TO ORDER PLEASE SPECIFY THE FOLLOWING:

WOOD TOP, WOOD CHASSIS

1. **MODEL NUMBER + WW**
2. **FSC**
3. **TOP WOOD FINISH + EDGE**
4. **CHASSIS WOOD FINISH**
5. **TOP FINISH**
6. **PULL**
7. **DRAWERS**
8. **KEYING**

LAM TOP, LAM CHASSIS

1. **MODEL NUMBER + LL**
2. **FSC**
3. **TOP LAM**
4. **CHASSIS LAM**
5. **FRONT LAM**
6. **EDGE DETAIL**
7. **PULL**
8. **DRAWERS**
9. **KEYING**

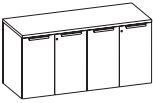
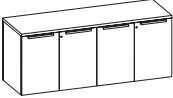

	D	W	H	model number + type	laminata	veneer 1	veneer 2	veneer 3
	24	60	29 1/2	<b>GS2FSC2460-55</b> [ ]	4,922	6,708	7,379	8,050
	24	72	29 1/2	<b>GS2FSC2472-55</b> [ ]	5,284	7,198	7,918	8,638

**PRODUCT INFO**

All tops long grain standard.  
Ships assembled.  
(1) Adjustable shelf behind each door set.

**TO ORDER PLEASE SPECIFY THE FOLLOWING:**

WOOD TOP, WOOD CHASSIS

1. **MODEL NUMBER + WW**
2. **FSC**
3. **TOP WOOD FINISH + EDGE**
4. **CHASSIS WOOD FINISH**
5. **TOP FINISH**
6. **PULL**
7. **KEYING**

LAM TOP, LAM CHASSIS

1. **MODEL NUMBER + LL**
2. **FSC**
3. **TOP LAM**
4. **CHASSIS LAM**
5. **FRONT LAM**
6. **EDGE DETAIL**
7. **PULL**
8. **KEYING**

# RETURNS

15" Pedestals | Full Modesty

Silea

02/24

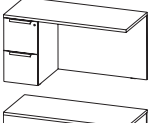
	D	W	H	model number + type	laminata	vener 1	vener 2	vener 3
<b>LEFT HAND</b> 	24	42	29 1/2	<b>GS2RTN2442L-2</b> <input type="checkbox"/>	3,084	4,257	4,683	5,109
	24	48	29 1/2	<b>GS2RTN2448L-2</b> <input type="checkbox"/>	3,170	4,378	4,816	5,254
	24	54	29 1/2	<b>GS2RTN2454L-2</b> <input type="checkbox"/>	3,235	4,469	4,916	5,363
	24	60	29 1/2	<b>GS2RTN2460L-2</b> <input type="checkbox"/>	3,331	4,598	5,058	5,518

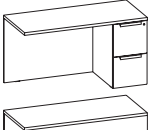
<b>RIGHT HAND</b> 	24	42	29 1/2	<b>GS2RTN2442R-2</b> <input type="checkbox"/>	3,084	4,257	4,683	5,109
	24	48	29 1/2	<b>GS2RTN2448R-2</b> <input type="checkbox"/>	3,170	4,378	4,816	5,254
	24	54	29 1/2	<b>GS2RTN2454R-2</b> <input type="checkbox"/>	3,235	4,469	4,916	5,363
	24	60	29 1/2	<b>GS2RTN2460R-2</b> <input type="checkbox"/>	3,331	4,598	5,058	5,518

• Flat brackets ordered separately (model #MDWBRK)

## PRODUCT INFO

Specify pedestal location from user seated position.

All tops optional grain.

 Units shipped as separate packages and require field assembly.

### Grommet Location

(Add \$80 per grommet)

No Grommet **GN**  
 Left **GL**  
 Right **GR**  
 Left & Right **GB**

Specify location first, then select grommet color or "Empty Cutout" option. When "Empty Cutout" option is selected, a grommet or power unit must be ordered separately for each cutout.

## TO ORDER PLEASE SPECIFY THE FOLLOWING:

WOOD TOP, WOOD CHASSIS

- MODEL NUMBER + WW**
- FSC**
- TOP WOOD FINISH + EDGE**
- CHASSIS WOOD FINISH**
- TOP FINISH**
- GRAIN DIRECTION**
- PULL**
- DRAWERS**
- GROMMET**
- KEYING**

LAM TOP, LAM CHASSIS

- MODEL NUMBER + LL**
- FSC**
- TOP LAM**
- CHASSIS LAM**
- FRONT LAM**
- GRAIN DIRECTION**
- EDGE DETAIL**
- PULL**
- DRAWER**
- GROMMET**
- KEYING**

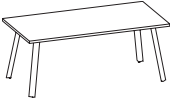
	D	W	H	model number + type	laminata	veneer 1	veneer 2	veneer 3
	30	66	29 1/2	<b>GS2TRL3066-</b> [ ]	2,200	2,618	2,880	3,142
	30	72	29 1/2	<b>GS2TRL3072-</b> [ ]	2,256	2,695	2,965	3,234
	36	72	29 1/2	<b>GS2TRL3672-</b> [ ]	2,333	2,806	3,087	3,368
	36	78	29 1/2	<b>GS2TRL3678-</b> [ ]	2,417	2,922	3,215	3,507

**PRODUCT INFO**

All tops long grain standard.  
 Units shipped as separate packages and require field assembly.

**Grommet Location**  
 (Add \$80 per grommet)

- No Grommet **GN**
- Left **GL**
- Right **GR**
- Left & Right **GB**

Specify location first, then select grommet color or "Empty Cutout" option. When "Empty Cutout" option is selected, a grommet or power unit must be ordered separately for each cutout.

**TO ORDER PLEASE SPECIFY THE FOLLOWING:**

WOOD TOP

1. **MODEL NUMBER + W**
2. **FSC**
3. **TOP WOOD FINISH + EDGE**
4. **TOP FINISH**
5. **HARDWARE COLOR**
6. **GROMMET**

LAM TOP

1. **MODEL NUMBER + L**
2. **FSC**
3. **TOP LAM**
4. **EDGE DETAIL**
5. **HARDWARE COLOR**
6. **GROMMET**

# RECTANGULAR EXTENSION

Left and Right Hand

Silea

02/24

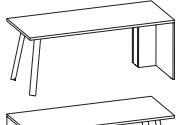
	D	W	H	model number + type	laminata	veneer 1	veneer 2	veneer 3
<b>LEFT HAND</b> 	30	66	29 1/2	<b>GS2XRL3066L-</b> [ ]	2,419	3,118	3,430	3,742
	30	72	29 1/2	<b>GS2XRL3072L-</b> [ ]	2,475	3,195	3,515	3,834
	36	72	29 1/2	<b>GS2XRL3672L-</b> [ ]	2,592	3,356	3,692	4,028
	36	78	29 1/2	<b>GS2XRL3678L-</b> [ ]	2,676	3,472	3,820	4,167

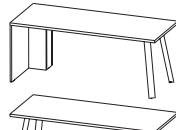
<b>RIGHT HAND</b> 	30	66	29 1/2	<b>GS2XRL3066R-</b> [ ]	2,419	3,118	3,430	3,742
	30	72	29 1/2	<b>GS2XRL3072R-</b> [ ]	2,475	3,195	3,515	3,834
	36	72	29 1/2	<b>GS2XRL3672R-</b> [ ]	2,592	3,356	3,692	4,028
	36	78	29 1/2	<b>GS2XRL3678R-</b> [ ]	2,676	3,472	3,820	4,167

- Extensions not for use as a freestanding unit, must attach to adjoining unit.

## PRODUCT INFO

Specify legs from user seated position.

All tops long grain standard.

 Units shipped as separate packages and require field assembly.

Modesty panel ordered separately.

### Grommet Location

(Add \$80 per grommet)

No Grommet **GN**  
Left **GL**  
Right **GR**  
Left & Right **GB**

Specify location first, then select grommet color or "Empty Cutout" option. When "Empty Cutout" option is selected, a grommet or power unit must be ordered separately for each cutout.



## TO ORDER PLEASE SPECIFY THE FOLLOWING:

WOOD TOP, WOOD CHASSIS

1. **MODEL NUMBER + WW**
2. **FSC**
3. **TOP WOOD FINISH + EDGE**
4. **CHASSIS WOOD FINISH**
5. **TOP FINISH**
6. **HARDWARE COLOR**
7. **GROMMET**

LAM TOP, LAM CHASSIS

1. **MODEL NUMBER + LL**
2. **FSC**
3. **TOP LAM**
4. **CHASSIS LAM**
5. **EDGE DETAIL**
6. **HARDWARE COLOR**
7. **GROMMET**

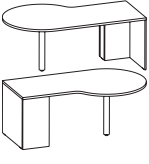
	D	W	H	model number + type	laminate	veneer 1	veneer 2	veneer 3
<b>LEFT HAND</b> 	30	66	29 1/2	<b>GS2XRT3066L-</b> [ ]	2,753	4,099	4,509	4,919
	30	72	29 1/2	<b>GS2XRT3072L-</b> [ ]	2,820	4,195	4,615	5,034
<b>RIGHT HAND</b> 	30	66	29 1/2	<b>GS2XRT3066R-</b> [ ]	2,753	4,099	4,509	4,919
	30	72	29 1/2	<b>GS2XRT3072R-</b> [ ]	2,820	4,195	4,615	5,034
<b>LEFT HAND</b> 	42	42	29 1/2	<b>GS2XDT4272-</b> [ ]	3,691	5,422	5,965	6,507
	42	48	29 1/2	<b>GS2XBT4272-</b> [ ]	3,691	5,422	5,965	6,507

• Extensions not for use as a freestanding unit, must attach to adjoining unit.

**PRODUCT INFO**

Specify column from user seated position.

Wood tops optional grain.

Laminate tops long grain standard.

 Units shipped as separate packages and require field assembly.

**Grommet Location**

(Add \$80 per grommet)

No Grommet **GN**  
 Left **GL**  
 Right **GR**  
 Left & Right **GB**

Specify location first, then select grommet color or "Empty Cutout" option. When "Empty Cutout" option is selected, a grommet or power unit must be ordered separately for each cutout.

**TO ORDER PLEASE SPECIFY THE FOLLOWING:**

WOOD TOP, WOOD CHASSIS

1. **MODEL NUMBER + WW**
2. **FSC**
3. **TOP WOOD FINISH + EDGE**
4. **CHASSIS WOOD FINISH**
5. **TOP FINISH**
6. **GRAIN DIRECTION**
7. **HARDWARE COLOR**
8. **GROMMET**

LAM TOP, LAM CHASSIS

1. **MODEL NUMBER + LL**
2. **FSC**
3. **TOP LAM**
4. **CHASSIS LAM**
5. **EDGE DETAIL**
6. **HARDWARE COLOR**
7. **GROMMET**

# RUNOFFS

15" Pedestal | Full Modesty

Silea  
02/24

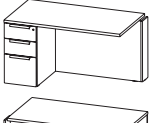
	D	W	H	model number + type	laminata	veneer 1	veneer 2	veneer 3
<b>LEFT HAND</b> 	30	48	29 1/2	<b>GS2RROF3048L-3</b> <input type="checkbox"/>	3,351	4,632	5,096	5,559
	30	54	29 1/2	<b>GS2RROF3054L-3</b> <input type="checkbox"/>	3,384	4,682	5,151	5,619
	36	54	29 1/2	<b>GS2RROF3654L-3</b> <input type="checkbox"/>	3,445	4,598	5,058	5,518
	36	60	29 1/2	<b>GS2RROF3660L-3</b> <input type="checkbox"/>	3,491	4,655	5,121	5,586

## RIGHT HAND

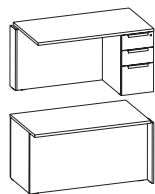

30	48	29 1/2	<b>GS2RROF3048R-3</b> <input type="checkbox"/>	3,351	4,632	5,096	5,559
30	54	29 1/2	<b>GS2RROF3054R-3</b> <input type="checkbox"/>	3,384	4,682	5,151	5,619
36	54	29 1/2	<b>GS2RROF3654R-3</b> <input type="checkbox"/>	3,445	4,598	5,058	5,518
36	60	29 1/2	<b>GS2RROF3660R-3</b> <input type="checkbox"/>	3,491	4,655	5,121	5,586

• Flat brackets ordered separately (model #MDWBRK)

## PRODUCT INFO

Specify pedestal from user seated position.

Wood tops optional grain.

Laminate tops long grain standard.

 Units shipped as separate packages and require field assembly.

### Grommet Location

(Add \$80 per grommet)

No Grommet **GN**  
Left **GL**  
Right **GR**  
Left & Right **GB**

Specify location first, then select grommet color or "Empty Cutout" option. When "Empty Cutout" option is selected, a grommet or power unit must be ordered separately for each cutout.

## TO ORDER PLEASE SPECIFY THE FOLLOWING:

WOOD TOP, WOOD CHASSIS

1. **MODEL NUMBER + WW**
2. **FSC**
3. **TOP WOOD FINISH + EDGE**
4. **CHASSIS WOOD FINISH**
5. **TOP FINISH**
6. **GRAIN DIRECTION**
7. **PULL**
8. **DRAWERS**
9. **GROMMET**
10. **KEYING**

LAM TOP, LAM CHASSIS

1. **MODEL NUMBER + LL**
2. **FSC**
3. **TOP LAM**
4. **CHASSIS LAM**
5. **FRONT LAM**
6. **GRAIN DIRECTION**
7. **EDGE DETAIL**
8. **PULL**
9. **DRAWER**
10. **GROMMET**
11. **KEYING**

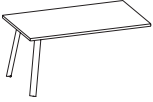
	D	W	H	model number + type	laminate	veneer 1	veneer 2	veneer 3
	30	48	29 1/2	<b>GS2RRL3048-</b> <input type="checkbox"/>	1,355	1,746	1,921	2,096
	30	54	29 1/2	<b>GS2RRL3054-</b> <input type="checkbox"/>	1,439	1,836	2,020	2,204
	36	54	29 1/2	<b>GS2RRL3654-</b> <input type="checkbox"/>	1,498	1,916	2,108	2,300
	36	60	29 1/2	<b>GS2RRL3660-</b> <input type="checkbox"/>	1,518	1,946	2,141	2,336

- Flat brackets ordered separately (model #MDWBRK)

**PRODUCT INFO**

All tops short grain standard.

 Units shipped as separate packages and require field assembly.

**Grommet Location**  
(Add \$80 per grommet)

No Grommet **GN**  
Left **GL**  
Right **GR**  
Left & Right **GB**

Specify location first, then select grommet color or "Empty Cutout" option. When "Empty Cutout" option is selected, a grommet or power unit must be ordered separately for each cutout.

**TO ORDER PLEASE SPECIFY THE FOLLOWING:**

WOOD TOP

1. **MODEL NUMBER + W**
2. **FSC**
3. **TOP WOOD FINISH + EDGE**
4. **TOP FINISH**
5. **HARDWARE COLOR**
6. **GROMMET**

LAM TOP

1. **MODEL NUMBER + L**
2. **FSC**
3. **TOP LAM**
4. **EDGE DETAIL**
5. **HARDWARE COLOR**
6. **GROMMET**

# LAYERS RECTANGULAR RUNOFF W/ LAYERS BOX

Left and Right Hand

Silea  
02/24

	D	W	H	model number + type	laminate	veneer 1	veneer 2	veneer 3
<b>LEFT HAND</b> 	30	66	29 1/2	<b>GS2RLRL3066L-</b> [ ]	1,950	2,368	2,605	2,842
	30	72	29 1/2	<b>GS2RLRL3072L-</b> [ ]	2,006	2,445	2,690	2,934
	36	72	29 1/2	<b>GS2RLRL3672L-</b> [ ]	2,121	2,594	2,854	3,113
	36	78	29 1/2	<b>GS2RLRL3678L-</b> [ ]	2,205	2,710	2,981	3,252

<b>RIGHT HAND</b> 	30	66	29 1/2	<b>GS2RLRL3066R-</b> [ ]	1,950	2,368	2,605	2,842
	30	72	29 1/2	<b>GS2RLRL3072R-</b> [ ]	2,006	2,445	2,690	2,934
	36	72	29 1/2	<b>GS2RLRL3672R-</b> [ ]	2,121	2,594	2,854	3,113
	36	78	29 1/2	<b>GS2RLRL3678R-</b> [ ]	2,205	2,710	2,981	3,252

Layers Box

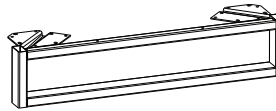

Side view

## PRODUCT INFO

Specify legs from user seated position.

All tops long grain standard.

 Units shipped as separate packages and require field assembly.

**Grommet Location**  
(Add \$80 per grommet)

No Grommet **GN**  
Left **GL**  
Right **GR**  
Left & Right **GB**

Specify location first, then select grommet color or "Empty Cutout" option. When "Empty Cutout" option is selected, a grommet or power unit must be ordered separately for each cutout.

## TO ORDER PLEASE SPECIFY THE FOLLOWING:

### WOOD TOP

1. MODEL NUMBER + W
2. FSC
3. TOP WOOD FINISH + EDGE
4. TOP FINISH
5. HARDWARE COLOR (LEG)
6. HARDWARE COLOR (LAYERS BOX)
7. GROMMET

### LAM TOP

1. MODEL NUMBER + L
2. FSC
3. TOP LAM
4. EDGE DETAIL
5. HARDWARE COLOR (LEG)
6. HARDWARE COLOR (LAYERS BOX)
9. GROMMET



# LAYERS RECTANGULAR RUNOFF W/ LAPTOP DRAWER

Left and Right Hand

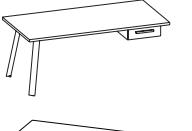
	D	W	H	model number + type	laminata	vener 1	vener 2	vener 3
<b>LEFT HAND</b> 	30	66	29 1/2	<b>GS2RLRLS3066L-</b> [ ]	2,369	3,129	3,442	3,755
	30	72	29 1/2	<b>GS2RLRLS3072L-</b> [ ]	2,424	3,205	3,526	3,846
	36	72	29 1/2	<b>GS2RLRLS3672L-</b> [ ]	2,562	3,338	3,672	4,006
	36	78	29 1/2	<b>GS2RLRLS3678L-</b> [ ]	2,645	3,453	3,799	4,144

<b>RIGHT HAND</b> 	30	66	29 1/2	<b>GS2RLRLS3066R-</b> [ ]	2,369	3,129	3,442	3,755
	30	72	29 1/2	<b>GS2RLRLS3072R-</b> [ ]	2,424	3,205	3,526	3,846
	36	72	29 1/2	<b>GS2RLRLS3672R-</b> [ ]	2,562	3,338	3,672	4,006
	36	78	29 1/2	<b>GS2RLRLS3678R-</b> [ ]	2,645	3,453	3,799	4,144

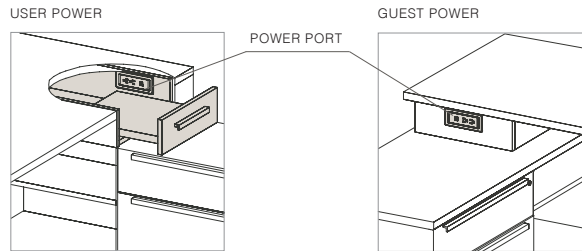

## PRODUCT INFO

Specify legs from user seated position.

All tops long grain standard.

 Units shipped as separate packages and require field assembly.

Power units included (2 USB, 2 power)

**Grommet Location**  
(Add \$80 per grommet)

No Grommet **GN**  
Left **GL**  
Right **GR**  
Left & Right **GB**

Specify location first, then select grommet color or "Empty Cutout" option. When "Empty Cutout" option is selected, a grommet or power unit must be ordered separately for each cutout.

## TO ORDER PLEASE SPECIFY THE FOLLOWING:

### WOOD TOP

- MODEL NUMBER + W**
- FSC**
- TOP WOOD FINISH + EDGE**
- CHASSIS WOOD FINISH**
- TOP FINISH**
- PULL**
- HARDWARE COLOR**
- GROMMET**
- POWER UNIT**

### LAM TOP

- MODEL NUMBER + L**
- FSC**
- TOP LAM**
- CHASSIS LAM**
- EDGE DETAIL**
- HARDWARE COLOR**
- GROMMET**
- POWER UNIT**

# ELLIPSE TABLE DESK

Silea  
02/24



D	W	H	model number + type	laminata	veneer 1	veneer 2	veneer 3	solid surface
36	72	29 1/2	<b>GS2TEL3672-</b> [ ]	2,889	3,876	4,264	4,652	10,098
42	84	29 1/2	<b>GS2TEL4284-</b> [ ]	4,211	5,708	6,279	6,850	16,981

## PRODUCT INFO

All tops long grain standard.  
 Units shipped as separate packages and require field assembly.

## TO ORDER PLEASE SPECIFY THE FOLLOWING:

### WOOD TOP

1. **MODEL NUMBER + W**
2. **FSC**
3. **TOP WOOD FINISH + EDGE**
4. **TOP FINISH**
5. **HARDWARE COLOR**

### LAM TOP

1. **MODEL NUMBER + L**
2. **FSC**
3. **TOP LAM**
4. **EDGE DETAIL**
5. **HARDWARE COLOR**

### SOLID SURFACE TOP

1. **MODEL NUMBER + S**
2. **SOLID SURFACE**
3. **EDGE DETAIL**
4. **HARDWARE COLOR**

# LAYERS ELLIPSE RUNOFF W/ LAYERS BOX



D	W	H	model number + type	laminata	veneer 1	veneer 2	veneer 3	solid surface
36	72	29 1/2	<b>GS2RLEL3672-</b> [ ]	2,751	3,738	4,112	4,486	10,602
42	84	29 1/2	<b>GS2RLEL4284-</b> [ ]	4,042	5,535	6,089	6,642	17,827

Layers Box

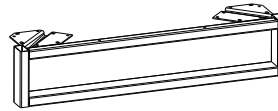

Side view

## PRODUCT INFO

All tops long grain standard.

 Units shipped as separate packages and require field assembly.

## TO ORDER PLEASE SPECIFY THE FOLLOWING:

### WOOD TOP

1. **MODEL NUMBER + W**
2. **FSC**
3. **TOP WOOD FINISH + EDGE**
4. **TOP FINISH**
5. **HARDWARE COLOR (Leg)**
6. **HARDWARE COLOR (Layers Box)**

### LAM TOP

1. **MODEL NUMBER + L**
2. **FSC**
3. **TOP LAM**
4. **EDGE DETAIL**
5. **HARDWARE COLOR (Leg)**
6. **HARDWARE COLOR (Layers Box)**

### SOLID SURFACE TOP

1. **MODEL NUMBER + S**
2. **SOLID SURFACE**
3. **EDGE DETAIL**
4. **HARDWARE COLOR (Leg)**
5. **HARDWARE COLOR (Layers Box)**

# ARC BOAT TABLE DESK

Silea  
02/24

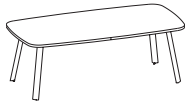

D	W	H	model number + type	laminata	veneer 1	veneer 2	veneer 3	solid surface
36	72	29 1/2	<b>GS2TFL3672-</b> [ ]	2,963	3,950	4,345	4,740	10,100
42	84	29 1/2	<b>GS2TFL4284-</b> [ ]	4,215	5,708	6,279	6,850	16,981

## PRODUCT INFO

All tops long grain standard.  
 Units shipped as separate packages and require field assembly.

## TO ORDER PLEASE SPECIFY THE FOLLOWING:

### WOOD TOP

1. **MODEL NUMBER + W**
2. **FSC**
3. **TOP WOOD FINISH + EDGE**
4. **TOP FINISH**
5. **HARDWARE COLOR**

### LAM TOP

1. **MODEL NUMBER + L**
2. **FSC**
3. **TOP LAM**
4. **EDGE DETAIL**
5. **HARDWARE COLOR**

### SOLID SURFACE TOP

1. **MODEL NUMBER + S**
2. **SOLID SURFACE**
3. **EDGE DETAIL**
4. **HARDWARE COLOR**

# LAYERS ARC BOAT RUNOFF W/LAYERS BOX

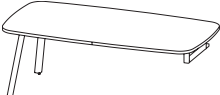
	D	W	H	model number + type	laminata	veneer 1	veneer 2	veneer 3	solid surface
	36	72	29 1/2	<b>GS2RLFL3672-</b> [ ]	2,751	3,738	4,112	4,486	10,602
	42	84	29 1/2	<b>GS2RLFL4284-</b> [ ]	4,042	5,535	6,089	6,642	17,827

Layers Box

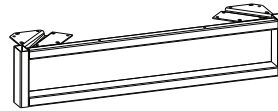

Side view

**PRODUCT INFO**

All tops long grain standard

 Units shipped as separate packages and require field assembly.

**TO ORDER PLEASE SPECIFY THE FOLLOWING:**

**WOOD TOP**

1. **MODEL NUMBER + W**
2. **FSC**
3. **TOP WOOD FINISH + EDGE**
4. **TOP FINISH**
5. **HARDWARE COLOR (Leg)**
6. **HARDWARE COLOR (Layers Box)**

**LAM TOP**

1. **MODEL NUMBER + L**
2. **FSC**
3. **TOP LAM**
4. **EDGE DETAIL**
5. **HARDWARE COLOR (Leg)**
6. **HARDWARE COLOR (Layers Box)**

**SOLID SURFACE TOP**

1. **MODEL NUMBER + S**
2. **SOLID SURFACE**
3. **EDGE DETAIL**
4. **HARDWARE COLOR (Leg)**
5. **HARDWARE COLOR (Layers Box)**

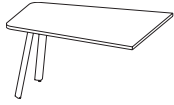

D	W	H	model number + type	laminata	veneer 1	veneer 2	veneer 3
42	54	29 1/2	<b>GS2RSL304254-</b> [ ]	1,951	2,576	2,834	3,092
48	66	29 1/2	<b>GS2RSL364866-</b> [ ]	2,126	2,716	2,988	3,260

• Flat brackets ordered separately (model #MDWBRK)

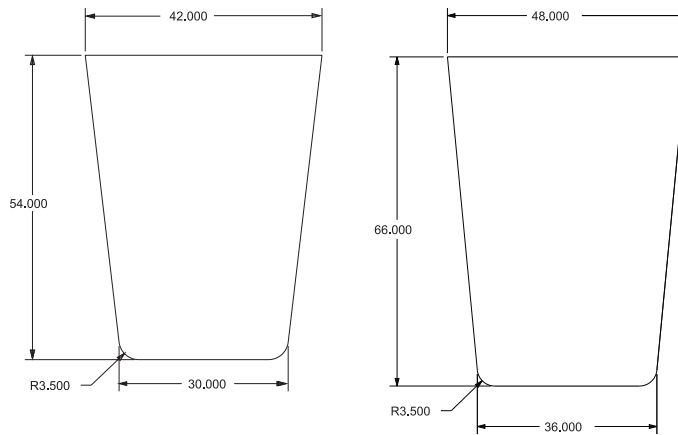

## PRODUCT INFO

All tops short grain standard.  
 Units shipped as separate packages and require field assembly.

## TO ORDER PLEASE SPECIFY THE FOLLOWING:

### WOOD TOP

1. **MODEL NUMBER + W**
2. **FSC**
3. **TOP WOOD FINISH + EDGE**
4. **TOP FINISH**
5. **HARDWARE COLOR**

### LAM TOP

1. **MODEL NUMBER + L**
2. **FSC**
3. **TOP LAM**
4. **EDGE DETAIL**
5. **HARDWARE COLOR**

# LAYERS SIGHTLINE RUNOFF W/ LAYERS BOX

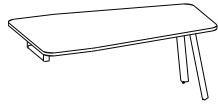

D	W	H	model number + type	laminate	veneer 1	veneer 2	veneer 3	solid surface
42	72	29 1/2	<b>GS2RLSL304272-</b> [ ]	3,044	4,052	4,458	4,863	10,602
48	84	29 1/2	<b>GS2RLSL364884-</b> [ ]	4,511	5,970	6,567	7,164	17,828

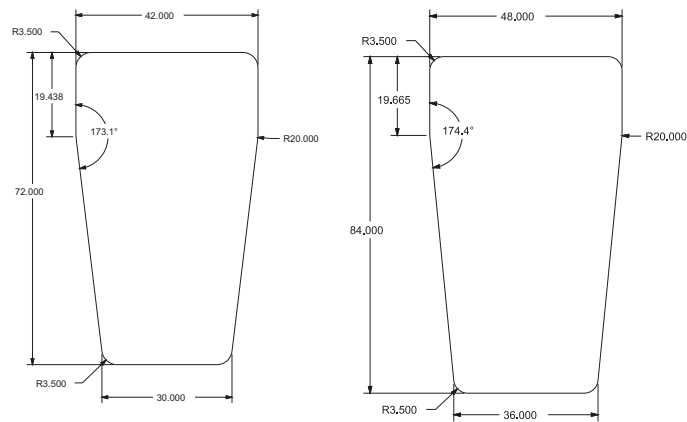

Layers Box

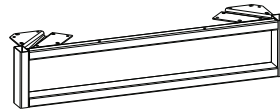

Side view

## PRODUCT INFO

All tops long grain standard.

 Units shipped as separate packages and require field assembly.

## TO ORDER PLEASE SPECIFY THE FOLLOWING:

### WOOD TOP

1. MODEL NUMBER + W
2. FSC
3. TOP WOOD FINISH + EDGE
4. TOP FINISH
5. HARDWARE COLOR (Leg)
6. HARDWARE COLOR (Layers Box)

### LAM TOP

1. MODEL NUMBER + L
2. FSC
3. TOP LAM
4. EDGE DETAIL
5. HARDWARE COLOR (Leg)
6. HARDWARE COLOR (Layers Box)

### SOLID SURFACE TOP



1. MODEL NUMBER + S
2. SOLID SURFACE
3. EDGE DETAIL
4. HARDWARE COLOR (Leg)
5. HARDWARE COLOR (Layers Box)

# LAYERS SIGHTLINE RUNOFF W/ LAPTOP DRAWER

Silea

02/24

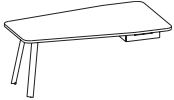
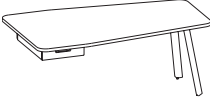
Left and Right Hand

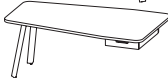
	D	W	H	model number + type	laminate	veneer 1	veneer 2	veneer 3
<b>LEFT HAND</b>  	42	72	29 1/2	<b>GS2RLSLS304272L-</b> [ ]	3,385	4,735	5,209	5,682
	48	84	29 1/2	<b>GS2RLSLS364884L-</b> [ ]	4,947	6,709	7,380	8,051
<b>RIGHT HAND</b>  	42	72	29 1/2	<b>GS2RLSLS304272R-</b> [ ]	3,385	4,735	5,209	5,682
	48	84	29 1/2	<b>GS2RLSLS364884R-</b> [ ]	4,947	6,709	7,380	8,051

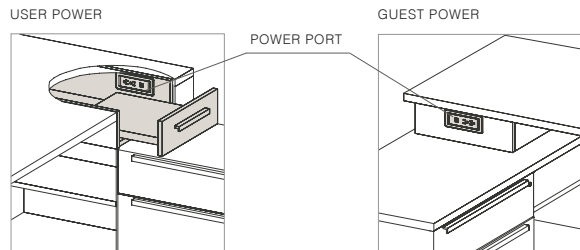

## PRODUCT INFO

Specify legs from user seated position.

All tops long grain standard.

 Units shipped as separate packages and require field assembly.

Power units included (2 USB, 2 power)

## TO ORDER PLEASE SPECIFY THE FOLLOWING:

WOOD TOP, WOOD CHASSIS

1. **MODEL NUMBER + W**
2. **FSC**
3. **TOP WOOD FINISH + EDGE**
4. **CHASSIS WOOD FINISH**
5. **TOP FINISH**
6. **PULL**
7. **HARDWARE COLOR**
8. **POWER UNIT**

LAM TOP, LAM CHASSIS

1. **MODEL NUMBER + L**
2. **FSC**
3. **TOP LAM**
4. **CHASSIS LAM**
5. **EDGE DETAIL**
6. **PULL**
7. **HARDWARE COLOR**
8. **POWER UNIT**



# LAYERS COCKPIT RUNOFF W/ LAYERS BOX

Left and Right Hand

	D	W	H	model number + type	laminata	veneer 1	veneer 2	veneer 3	solid surface
<b>LEFT HAND</b> 	60	72	29 1/2	<b>GS2RLC6072L-</b> [ ]	3,924	4,274	4,702	5,129	11,861
	60	84	29 1/2	<b>GS2RLC6084L-</b> [ ]	5,466	6,283	6,912	7,540	19,448

**RIGHT HAND**

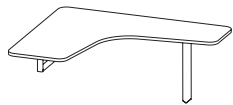

60	72	29 1/2	<b>GS2RLC6072R-</b> [ ]	3,924	4,274	4,702	5,129	11,861
60	84	29 1/2	<b>GS2RLC6084R-</b> [ ]	5,466	6,283	6,912	7,540	19,448

• All tops are 1 piece.

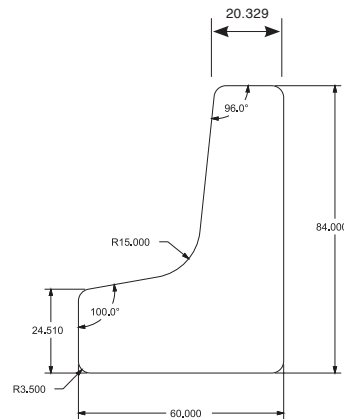
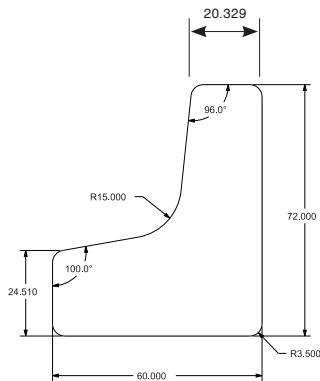

**Layers Box**

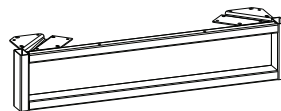

Side view

**PRODUCT INFO**

Specify legs from user seated position.

All tops long grain standard.

 Units shipped as separate packages and require field assembly.

**TO ORDER PLEASE SPECIFY THE FOLLOWING:**

**WOOD TOP**

- 1. MODEL NUMBER + W**
- 2. FSC**
- 3. TOP WOOD FINISH + EDGE**
- 4. TOP FINISH\***
- 5. HARDWARE COLOR**

**LAM TOP**

- 1. MODEL NUMBER + L**
- 2. FSC**
- 3. TOP LAM**
- 4. EDGE DETAIL**
- 5. HARDWARE COLOR**

**SOLID SURFACE TOP**

- 1. MODEL NUMBER + S**
- 2. SOLID SURFACE**
- 3. EDGE DETAIL**
- 4. HARDWARE COLOR**

• Only available in  
**OP** open pore top  
finish option

# MEDIA TOP

w/ Wall Access Panel

Silea  
02/24



D	W	H	model number + type	laminata	veneer 1	veneer 2	veneer 3
60	60	29 1/2	<b>GS2XML366060-</b> [ ]	3,794	4,734	5,208	5,681
72	60	29 1/2	<b>GS2XML487260-</b> [ ]	4,782	6,019	6,621	7,223

**NOTE: UNIT MUST BE WALL MOUNTED**

- Wood tops are 2 piece on both models (seam shown in drawing below)

- Laminate and solid surface tops are 1 piece.

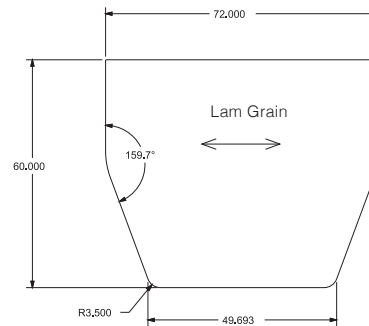
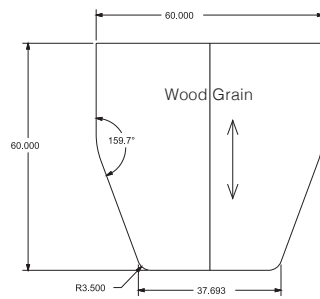

Arrows indicate grain direction.

## PRODUCT INFO

All tops long grain standard.

Units shipped as separate packages and require field assembly.

**Grommet Location**  
(Add \$80 per grommet)

No Grommet **GN**  
Left **GL**  
Right **GR**  
Left & Right **GB**

Specify location first, then select grommet color or "Empty Cutout" option. When "Empty Cutout" option is selected, a grommet or power unit must be ordered separately for each cutout.

## TO ORDER PLEASE SPECIFY THE FOLLOWING:

### WOOD TOP, WOOD CHASSIS

1. **MODEL NUMBER + WW**
2. **FSC**
3. **TOP WOOD FINISH + EDGE**
4. **CHASSIS WOOD FINISH**
5. **TOP FINISH**
6. **HARDWARE COLOR**
7. **GROMMET**

### LAM TOP, LAM CHASSIS

1. **MODEL NUMBER + LL**
2. **FSC**
3. **TOP LAM**
4. **CHASSIS LAM**
5. **EDGE DETAIL**
6. **HARDWARE COLOR**
7. **GROMMET**

Height Adjustable . . . . . 77-121

- Height Adjustable Split-Top Desks . . . . . 78-81
- Freestanding Desk / Extension . . . . . 82-87
- Credenza . . . . . 88-91
- Bridge . . . . . 92-93
- Return . . . . . 94-97
- L Shape Height Adjustable Spec Tips. . . . . 98
- L Shape Height Adjustable . . . . . 99-114
- Shroud for T-Base . . . . . 115
- Layers Bookcase . . . . . 116
- Height Adjustable Base . . . . . 117
- Height Adjustable Tops . . . . . 118
- Wall Mount Cantilever Bracket . . . . . 119
- Mixed Material Telescoping Height Adjustable . . . . . 120
- Replacement Height Adjustable Keypads . . . . . 121

# HEIGHT ADJUSTABLE SPLIT-TOP DESKS

Left Hand Desk

Silea  
02/24

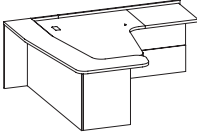
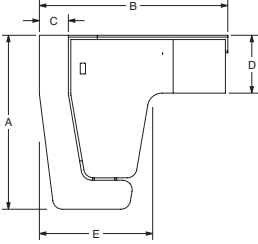
	D	W	H	model number + type	laminat	veneer 1	veneer 2	veneer 3
<b>LEFT HAND DESK</b>	72	78	29 1/2	<b>GS3STAT7278L-</b> [ ]	13,154	17,099	18,809	20,519
	A = 72" wide desk B = 78" wide total workwall C = 12" fixed guest overhang D = 24" return depth E = 48" depth total sightline top							
	72	84	29 1/2	<b>GS3STAT7284L-</b> [ ]	13,470	17,544	19,299	21,053
	A = 72" wide desk B = 84" wide total workwall C = 12" fixed guest overhang D = 24" return depth E = 48" depth total sightline top							
	78	90	29 1/2	<b>GS3STAT7890L-</b> [ ]	13,743	17,928	19,721	21,514
	A = 78" wide desk B = 90" wide total workwall C = 18" fixed guest overhang D = 24" return depth E = 54" depth total sightline top							
	78	96	29 1/2	<b>GS3STAT7896L-</b> [ ]	14,130	18,471	20,319	22,166
	A = 78" wide desk B = 96" wide total workwall C = 18" fixed guest overhang D = 24" return depth E = 54" depth total sightline top							

## PRODUCT INFO

### Unit must be wall mounted.

Metal shroud modesty panel raises up and down with height adjustable top.

29.5" to 42.5" height adjustment range.

 All units shipped as separate packages and require field assembly.

### Grommet Location

(Add \$80 per grommet)

No Grommet **GN**  
Center **GC**

Specify location first, then select grommet color or "Empty Cutout" option. When "Empty Cutout" option is selected, a grommet or power unit must be ordered separately for each cutout.

## TO ORDER PLEASE SPECIFY THE FOLLOWING:

WOOD TOP, WOOD CHASSIS

- MODEL NUMBER + WW
- FSC
- TOP WOOD FINISH + EDGE
- CHASSIS WOOD FINISH
- TOP FINISH
- HARDWARE COLOR
- HAT KEYPAD & BASE COLOR
- GROMMET

LAM TOP, LAM CHASSIS

- MODEL NUMBER + LL
- FSC
- TOP LAM
- CHASSIS LAM
- EDGE DETAIL
- HARDWARE COLOR
- HAT KEYPAD & BASE COLOR
- GROMMET



Optional height adjustable keypads available

### HAT KEYPAD & BASE COLOR

Basic Up/Down Keypad, Black P71 Column  
Memory Preset Keypad, Black P71 Column  
Paddle Keypad, Black P71 Column

**UDP71**  
**MEMP71**  
**PDLP71**

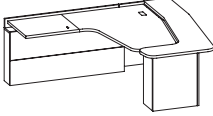
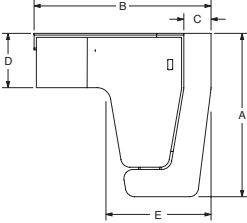
**NOTE:** Wood Tops only available with Square SQ Edge Detail option. Edge Details SQM, DFM, and TOM with 1/2" band are NOT available.

	D	W	H	model number + type	laminiate	veneer 1	veneer 2	veneer 3
<b>RIGHT HAND DESK</b> 	72	78	29 1/2	<b>GS3STAT7278R-</b> [ ]	13,154	17,099	18,809	20,519
	A = 72" wide desk B = 78" wide total workwall C = 12" fixed guest overhang D = 24" return depth E = 48" depth total sightline top							
	72	84	29 1/2	<b>GS3STAT7284R-</b> [ ]	13,470	17,544	19,299	21,053
	A = 72" wide desk B = 84" wide total workwall C = 12" fixed guest overhang D = 24" return depth E = 48" depth total sightline top							
	78	90	29 1/2	<b>GS3STAT7890R-</b> [ ]	13,743	17,928	19,721	21,514
	A = 78" wide desk B = 90" wide total workwall C = 18" fixed guest overhang D = 24" return depth E = 54" depth total sightline top							
	78	96	29 1/2	<b>GS3STAT7896R-</b> [ ]	14,130	18,471	20,319	22,166
	A = 78" wide desk B = 96" wide total workwall C = 18" fixed guest overhang D = 24" return depth E = 54" depth total sightline top							

**PRODUCT INFO**

**Unit must be wall mounted.**

Metal shroud modesty panel raises up and down with height adjustable top.

29.5" to 42.5" height adjustment range.

 All units shipped as separate packages and require field assembly.

**Grommet Location**

(Add \$80 per grommet)

No Grommet **GN**  
Center **GC**

Specify location first, then select grommet color or "Empty Cutout" option. When "Empty Cutout" option is selected, a grommet or power unit must be ordered separately for each cutout.

**TO ORDER PLEASE SPECIFY THE FOLLOWING:**

WOOD TOP, WOOD CHASSIS

- MODEL NUMBER + WW**
- FSC**
- TOP WOOD FINISH + EDGE**
- CHASSIS WOOD FINISH**
- TOP FINISH**
- HARDWARE COLOR**
- HAT KEYPAD & BASE COLOR**
- GROMMET**

LAM TOP, LAM CHASSIS

- MODEL NUMBER + LL**
- FSC**
- TOP LAM**
- CHASSIS LAM**
- EDGE DETAIL**
- HARDWARE COLOR**
- HAT KEYPAD & BASE COLOR**
- GROMMET**

Optional height adjustable keypads available

**HAT KEYPAD & BASE COLOR**

Basic Up/Down Keypad, Black P71 Column  
Memory Preset Keypad, Black P71 Column  
Paddle Keypad, Black P71 Column

**UDP71**  
**MEMP71**  
**PDL71**

**NOTE:** Wood Tops only available with Square SQ Edge Detail option. Edge Details SQM, DFM, and TOM with 1/2" band are NOT available.

# HEIGHT ADJUSTABLE SPLIT-TOP DESKS

Silea

02/24

## Left Hand Desk, Return With Pedestal

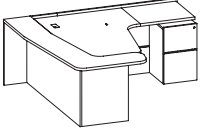
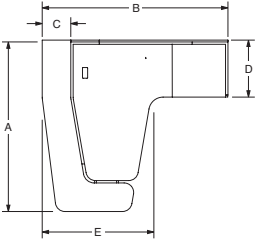
	D	W	H	model number + type	laminates	veneers 1	veneers 2	veneers 3
<b>LEFT HAND DESK</b>								
<b>RETURN WITH PEDESTAL</b>	72	78	29 1/2	<b>GS3STAT7278L-A</b> [ ]	14,587	19,272	21,200	23,127
	A = 72" wide desk B = 78" wide total workwall C = 12" fixed guest overhang D = 24" return depth E = 48" depth total sightline top Note: Return includes 15" wide Accessory/Box/File pedestal							
	72	84	29 1/2	<b>GS3STAT7284L-A</b> [ ]	14,908	19,718	21,690	23,662
	A = 72" wide desk B = 84" wide total workwall C = 12" fixed guest overhang D = 24" return depth E = 48" depth total sightline top Note: Return includes 15" wide Accessory/Box/File pedestal							
	78	90	29 1/2	<b>GS3STAT7890L-A</b> [ ]	15,181	20,102	22,113	24,123
	A = 78" wide desk B = 90" wide total workwall C = 18" fixed guest overhang D = 24" return depth E = 54" depth total sightline top Note: Return includes 15" wide Accessory/Box/File pedestal							
	78	96	29 1/2	<b>GS3STAT7896L-A</b> [ ]	15,566	20,645	22,710	24,774
	A = 78" wide desk B = 96" wide total workwall C = 18" fixed guest overhang D = 24" return depth E = 54" depth total sightline top Note: Return includes 15" wide Accessory/Box/File pedestal							

### PRODUCT INFO

#### Unit must be wall mounted.

Metal shroud modesty panel raises up and down with height adjustable top.

29.5" to 42.5" height adjustment range.

 All units shipped as separate packages and require field assembly.

#### Grommet Location (Add \$80 per grommet)

No Grommet **GN**  
Center **GC**

Specify location first, then select grommet color or "Empty Cutout" option. When "Empty Cutout" option is selected, a grommet or power unit must be ordered separately for each cutout.

NOTE: Monitor arms should **ALWAYS** be installed in grommets on Silea height adjustable units. Please ensure a grommet location is specified on the top. This allows for bolt mount or clamp mount install of monitor arm. See page 35 for details.

### TO ORDER PLEASE SPECIFY THE FOLLOWING:

WOOD TOP, WOOD CHASSIS

LAM TOP, LAM CHASSIS

- |                                       |                                       |
|---------------------------------------|---------------------------------------|
| 1. <b>MODEL NUMBER + WW</b>           | 1. <b>MODEL NUMBER + LL</b>           |
| 2. <b>FSC</b>                         | 2. <b>FSC</b>                         |
| 3. <b>TOP WOOD FINISH + EDGE</b>      | 3. <b>TOP LAM</b>                     |
| 4. <b>CHASSIS WOOD FINISH</b>         | 4. <b>CHASSIS LAM</b>                 |
| 5. <b>TOP FINISH</b>                  | 5. <b>FRONT LAM</b>                   |
| 6. <b>PULL</b>                        | 6. <b>EDGE DETAIL</b>                 |
| 7. <b>HARDWARE COLOR</b>              | 7. <b>PULL</b>                        |
| 8. <b>HAT KEYPAD &amp; BASE COLOR</b> | 8. <b>HARDWARE COLOR</b>              |
| 9. <b>GROMMET</b>                     | 9. <b>HAT KEYPAD &amp; BASE COLOR</b> |
| 10. <b>KEYING</b>                     | 10. <b>GROMMET</b>                    |
|                                       | 11. <b>KEYING</b>                     |

Optional height adjustable keypads available

#### HAT KEYPAD & BASE COLOR

Basic Up/Down Keypad, Black P71 Column	<b>UDP71</b>
Memory Preset Keypad, Black P71 Column	<b>MEMP71</b>
Paddle Keypad, Black P71 Column	<b>PDLP71</b>

**NOTE:** Wood Tops only available with Square SQ Edge Detail option. Edge Details SQM, DFM, and TOM with 1/2" band are NOT available.

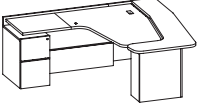
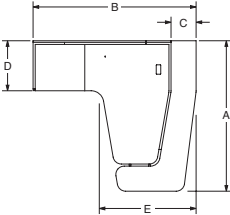
	D	W	H	model number + type	laminiate	veneer 1	veneer 2	veneer 3
<b>RIGHT HAND DESK</b>								
<b>RETURN WITH PEDESTAL</b>	72	78	29 1/2	<b>GS3STAT7278R-A</b> [ ]	14,587	19,272	21,200	23,127
	A = 72" wide desk B = 78" wide total workwall C = 12" fixed guest overhang D = 24" return depth E = 48" depth total sightline top Note: Return includes 15" wide Accessory/Box/File pedestal							
	72	84	29 1/2	<b>GS3STAT7284R-A</b> [ ]	14,908	19,718	21,690	23,662
	A = 72" wide desk B = 84" wide total workwall C = 12" fixed guest overhang D = 24" return depth E = 48" depth total sightline top Note: Return includes 15" wide Accessory/Box/File pedestal							
	78	90	29 1/2	<b>GS3STAT7890R-A</b> [ ]	15,181	20,102	22,113	24,123
	A = 78" wide desk B = 90" wide total workwall C = 18" fixed guest overhang D = 24" return depth E = 54" depth total sightline top Note: Return includes 15" wide Accessory/Box/File pedestal							
	78	96	29 1/2	<b>GS3STAT7896R-A</b> [ ]	15,566	20,645	22,710	24,774
	A = 78" wide desk B = 96" wide total workwall C = 18" fixed guest overhang D = 24" return depth E = 54" depth total sightline top Note: Return includes 15" wide Accessory/Box/File pedestal							

### PRODUCT INFO

**Unit must be wall mounted.**

Metal shroud modesty panel raises up and down with height adjustable top.

29.5" to 42.5" height adjustment range.

 All units shipped as separate packages and require field assembly.

**Grommet Location**  
(Add \$80 per grommet)

No Grommet **GN**  
Center **GC**

Specify location first, then select grommet color or "Empty Cutout" option. When "Empty Cutout" option is selected, a grommet or power unit must be ordered separately for each cutout.

NOTE: Monitor arms should **ALWAYS** be installed in grommets on Silea height adjustable units. Please ensure a grommet location is specified on the top. This allows for bolt mount or clamp mount install of monitor arm. See page 35 for details.

### TO ORDER PLEASE SPECIFY THE FOLLOWING:

WOOD TOP, WOOD CHASSIS

LAM TOP, LAM CHASSIS

- |  |  |
|--|--|
| <ol style="list-style-type: none"> <li>1. <b>MODEL NUMBER + WW</b></li> <li>2. <b>FSC</b></li> <li>3. <b>TOP WOOD FINISH + EDGE</b></li> <li>4. <b>CHASSIS WOOD FINISH</b></li> <li>5. <b>TOP FINISH</b></li> <li>6. <b>PULL</b></li> <li>7. <b>HARDWARE COLOR</b></li> <li>8. <b>HAT KEYPAD &amp; BASE COLOR</b></li> <li>9. <b>GROMMET</b></li> <li>10. <b>KEYING</b></li> </ol> | <ol style="list-style-type: none"> <li>1. <b>MODEL NUMBER + LL</b></li> <li>2. <b>FSC</b></li> <li>3. <b>TOP LAM</b></li> <li>4. <b>CHASSIS LAM</b></li> <li>5. <b>FRONT LAM</b></li> <li>6. <b>EDGE DETAIL</b></li> <li>7. <b>PULL</b></li> <li>8. <b>HARDWARE COLOR</b></li> <li>9. <b>HAT KEYPAD &amp; BASE COLOR</b></li> <li>10. <b>GROMMET</b></li> <li>11. <b>KEYING</b></li> </ol> |
|--|--|

Optional height adjustable keypads available

**HAT KEYPAD & BASE COLOR**

Basic Up/Down Keypad, Black P71 Column	<b>UDP71</b>
Memory Preset Keypad, Black P71 Column	<b>MEMP71</b>
Paddle Keypad, Black P71 Column	<b>PDLP71</b>



**NOTE:** Wood Tops only available with Square SQ Edge Detail option. Edge Details SQM, DFM, and TOM with 1/2" band are NOT available.

# HEIGHT ADJUSTABLE FREESTANDING DESK

Full Modesty

Silea

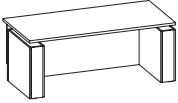
02/24

	D	W	H	model number + type	laminate	veneer 1	veneer 2	veneer 3
	30	66	29 1/2	<b>GS3DFAK3066-</b> [ ]	5,868	9,896	10,886	11,876
	30	72	29 1/2	<b>GS3DFAK3072-</b> [ ]	5,962	10,098	11,108	12,118
	36	72	29 1/2	<b>GS3DFAK3672-</b> [ ]	6,271	10,304	11,335	12,365
	36	78	29 1/2	<b>GS3DFAK3678-</b> [ ]	6,392	10,508	11,559	12,610

- Provides sit to stand electric height adjustment
- 29.5" to 42.5" height adjustment range

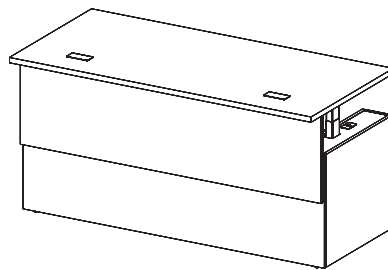

## PRODUCT INFO

All tops long grain standard.  
Wood models ship assembled.

 Laminate units shipped as separate packages and require field assembly.

### Grommet Location (Add \$80 per grommet)

No Grommet **GN**  
Left **GL**  
Right **GR**  
Left & Right **GB**

Specify location first, then select grommet color or "Empty Cutout" option. When "Empty Cutout" option is selected, a grommet or power unit must be ordered separately for each cutout.

NOTE: Monitor arms should **ALWAYS** be installed in grommets on Silea height adjustable units. Please ensure a grommet location is specified on the top. This allows for bolt mount or clamp mount install of monitor arm. See page 35 for details.

## TO ORDER PLEASE SPECIFY THE FOLLOWING:

### WOOD TOP, WOOD CHASSIS

- MODEL NUMBER + WW**
- FSC**
- TOP WOOD FINISH + EDGE**
- CHASSIS WOOD FINISH**
- TOP FINISH**
- HAT KEYPAD & BASE COLOR**
- GROMMET**

### LAM TOP, LAM CHASSIS

- MODEL NUMBER + LL**
- FSC**
- TOP LAM**
- CHASSIS LAM**
- EDGE DETAIL**
- HAT KEYPAD & BASE COLOR**
- GROMMET**

Optional height adjustable keypads available

### HAT KEYPAD & BASE COLOR

Basic Up/Down Keypad, Black P71 Column  
Memory Preset Keypad, Black P71 Column  
Paddle Keypad, Black P71 Column

**UDP71**  
**MEMP71**  
**PDLP71**

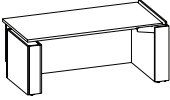

	D	W	H	model number + type	laminate	veneer 1	veneer 2	veneer 3
<b>LEFT HAND</b> 	30	66	29 1/2	<b>GS3XFAK3066L-</b> <input type="checkbox"/>	6,244	9,896	10,886	11,876
	30	72	29 1/2	<b>GS3XFAK3072L-</b> <input type="checkbox"/>	6,338	10,098	11,108	12,118
	36	72	29 1/2	<b>GS3XFAK3672L-</b> <input type="checkbox"/>	6,607	10,304	11,335	12,365
	36	78	29 1/2	<b>GS3XFAK3678L-</b> <input type="checkbox"/>	6,728	10,508	11,559	12,610

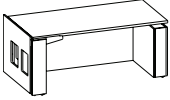
<b>RIGHT HAND</b> 	30	66	29 1/2	<b>GS3XFAK3066R-</b> <input type="checkbox"/>	6,244	9,896	10,886	11,876
	30	72	29 1/2	<b>GS3XFAK3072R-</b> <input type="checkbox"/>	6,338	10,098	11,108	12,118
	36	72	29 1/2	<b>GS3XFAK3672R-</b> <input type="checkbox"/>	6,607	10,304	11,335	12,365
	36	78	29 1/2	<b>GS3XFAK3678R-</b> <input type="checkbox"/>	6,728	10,508	11,559	12,610

- Provides sit to stand electric height adjustment
- 29.5" to 42.5" height adjustment range
- Cantilever extends 3" to support adjoining worksurface

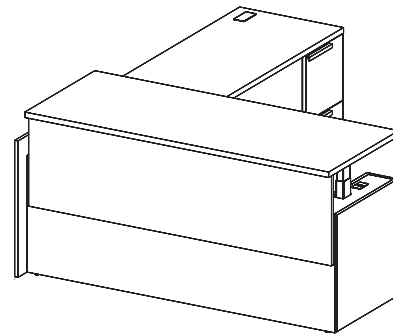

NOTE: If attaching to a return or bridge, a 3" shorter modesty or wall access panel must be used.

## PRODUCT INFO

Specify base from user seated position.

All tops long grain standard.

Wood models ship assembled.

 Laminate units shipped as separate packages and require field assembly.

### Grommet Location (Add \$80 per grommet)

No Grommet **GN**  
Left **GL**  
Right **GR**  
Left & Right **GB**

Specify location first, then select grommet color or "Empty Cutout" option. When "Empty Cutout" option is selected, a grommet or power unit must be ordered separately for each cutout.

NOTE: Monitor arms should **ALWAYS** be installed in grommets on Silea height adjustable units. Please ensure a grommet location is specified on the top. This allows for bolt mount or clamp mount install of monitor arm. See page 35 for details.

## TO ORDER PLEASE SPECIFY THE FOLLOWING:

### WOOD TOP, WOOD CHASSIS

- MODEL NUMBER + WW**
- FSC**
- TOP WOOD FINISH + EDGE**
- CHASSIS WOOD FINISH**
- TOP FINISH**
- HAT KEYPAD & BASE COLOR**
- GROMMET**

### LAM TOP, LAM CHASSIS

- MODEL NUMBER + LL**
- FSC**
- TOP LAM**
- CHASSIS LAM**
- EDGE DETAIL**
- HAT KEYPAD & BASE COLOR**
- GROMMET**

Optional height adjustable keypads available

### HAT KEYPAD & BASE COLOR

Basic Up/Down Keypad, Black P71 Column  
Memory Preset Keypad, Black P71 Column  
Paddle Keypad, Black P71 Column

**UDP71**  
**MEMP71**  
**PDLP71**

# HEIGHT ADJUSTABLE EXTENSION DESK

Full Modesty | Left and Right Hand, with Pedestal

Silea

02/24

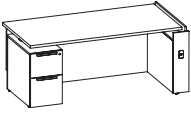
	D	W	H	model number + type	laminate	veneer 1	veneer 2	veneer 3
<b>LEFT HAND</b> 	30	66	29 1/2	<b>GS3XFAK3066L-A</b> <input type="checkbox"/>	6,826	10,883	11,972	13,060
	30	72	29 1/2	<b>GS3XFAK3072L-A</b> <input type="checkbox"/>	6,920	11,106	12,217	13,328
	36	72	29 1/2	<b>GS3XFAK3672L-A</b> <input type="checkbox"/>	7,160	11,332	12,466	13,599
	36	78	29 1/2	<b>GS3XFAK3678L-A</b> <input type="checkbox"/>	7,281	11,560	12,716	13,872

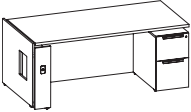
<b>RIGHT HAND</b> 	30	66	29 1/2	<b>GS3XFAK3066R-A</b> <input type="checkbox"/>	6,826	10,883	11,972	13,060
	30	72	29 1/2	<b>GS3XFAK3072R-A</b> <input type="checkbox"/>	6,920	11,106	12,217	13,328
	36	72	29 1/2	<b>GS3XFAK3672R-A</b> <input type="checkbox"/>	7,160	11,332	12,466	13,599
	36	78	29 1/2	<b>GS3XFAK3678R-A</b> <input type="checkbox"/>	7,281	11,560	12,716	13,872

- Provides sit to stand electric height adjustment
- 29.5" to 42.5" height adjustment range
- Cantilever extends 3" to support adjoining worksurface

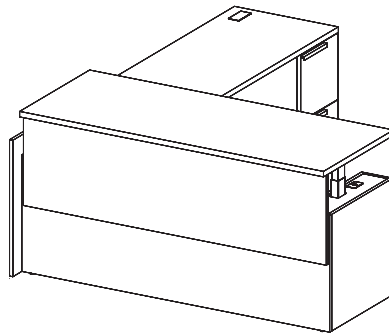

NOTE: If attaching to a return or bridge, a 3" shorter modesty or wall access panel must be used.

## PRODUCT INFO

Specify pedestal from user seated position.

All tops long grain standard.

Wood models ship assembled.

 Laminate units shipped as separate packages and require field assembly.

### Grommet Location (Add \$80 per grommet)

No Grommet **GN**  
 Left **GL**  
 Right **GR**  
 Left & Right **GB**

Specify location first, then select grommet color or "Empty Cutout" option. When "Empty Cutout" option is selected, a grommet or power unit must be ordered separately for each cutout.

NOTE: Monitor arms should **ALWAYS** be installed in grommets on Silea height adjustable units. Please ensure a grommet location is specified on the top. This allows for bolt mount or clamp mount install of monitor arm. See page 35 for details.

## TO ORDER PLEASE SPECIFY THE FOLLOWING:

### WOOD TOP, WOOD CHASSIS

1. **MODEL NUMBER + WW**
2. **FSC**
3. **TOP WOOD FINISH + EDGE**
4. **CHASSIS WOOD FINISH**
5. **TOP FINISH**
6. **PULL**
7. **HAT KEYPAD & BASE COLOR**
8. **GROMMET**
9. **KEYING**

### LAM TOP, LAM CHASSIS

1. **MODEL NUMBER + LL**
2. **FSC**
3. **TOP LAM**
4. **CHASSIS LAM**
5. **FRONT LAM**
6. **EDGE DETAIL**
7. **PULL**
8. **HAT KEYPAD & BASE COLOR**
9. **GROMMET**
10. **KEYING**

Optional height adjustable keypads available

### HAT KEYPAD & BASE COLOR

Basic Up/Down Keypad, Black P71 Column  
 Memory Preset Keypad, Black P71 Column  
 Paddle Keypad, Black P71 Column

**UDP71**  
**MEMP71**  
**PDLP71**

	D	W	H	model number + type	laminate	veneer 1	veneer 2	veneer 3
<b>LEFT HAND</b> 	30	66	29 1/2	<b>GS3XMAK3066L-</b> <input type="checkbox"/>	6,580	9,379	10,317	11,255
	30	72	29 1/2	<b>GS3XMAK3072L-</b> <input type="checkbox"/>	6,635	9,512	10,464	11,415
	36	72	29 1/2	<b>GS3XMAK3672L-</b> <input type="checkbox"/>	6,904	9,723	10,696	11,668
	36	78	29 1/2	<b>GS3XMAK3678L-</b> <input type="checkbox"/>	6,987	9,898	10,888	11,878

<b>RIGHT HAND</b> 	30	66	29 1/2	<b>GS3XMAK3066R-</b> <input type="checkbox"/>	6,580	9,379	10,317	11,255
	30	72	29 1/2	<b>GS3XMAK3072R-</b> <input type="checkbox"/>	6,635	9,512	10,464	11,415
	36	72	29 1/2	<b>GS3XMAK3672R-</b> <input type="checkbox"/>	6,904	9,723	10,696	11,668
	36	78	29 1/2	<b>GS3XMAK3678R-</b> <input type="checkbox"/>	6,987	9,898	10,888	11,878

- Provides sit to stand electric height adjustment
- 29.5" to 42.5" height adjustment range
- Cantilever extends 3" to support adjoining worksurface

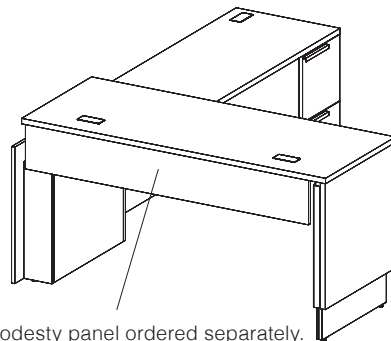

Modesty panel ordered separately.

NOTE: If attaching to a return or bridge, a 3" shorter modesty or wall access panel must be used.

## PRODUCT INFO

Specify base from user seated position.

All tops long grain standard. Wood models ship assembled.

 Laminate units shipped as separate packages and require field assembly.

Modesty panel ordered separately.

### Grommet Location

(Add \$80 per grommet)

No Grommet **GN**  
Left **GL**  
Right **GR**  
Left & Right **GB**

Specify location first, then select grommet color or "Empty Cutout" option. When "Empty Cutout" option is selected, a grommet or power unit must be ordered separately for each cutout.

NOTE: Monitor arms should **ALWAYS** be installed in grommets on Silea height adjustable units. Please ensure a grommet location is specified on the top. This allows for bolt mount or clamp mount install of monitor arm. See page 35 for details.

## TO ORDER PLEASE SPECIFY THE FOLLOWING:

### WOOD TOP, WOOD CHASSIS

1. **MODEL NUMBER + WW**
2. **FSC**
3. **TOP WOOD FINISH + EDGE**
4. **CHASSIS WOOD FINISH**
5. **TOP FINISH**
6. **HARDWARE COLOR**
7. **HAT KEYPAD & BASE COLOR**
8. **GROMMET**

### LAM TOP, LAM CHASSIS

1. **MODEL NUMBER + LL**
2. **FSC**
3. **TOP LAM**
4. **CHASSIS LAM**
5. **EDGE DETAIL**
6. **HARDWARE COLOR**
7. **HAT KEYPAD & BASE COLOR**
8. **GROMMET**

Optional height adjustable keypads available

### HAT KEYPAD & BASE COLOR

Basic Up/Down Keypad, Black P71 Column  
Memory Preset Keypad, Black P71 Column  
Paddle Keypad, Black P71 Column



**UDP71**  
**MEMP71**  
**PDL71**

# HEIGHT ADJUSTABLE FREESTANDING DESK

Half Modesty

Silea

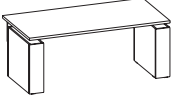
02/24

	D	W	H	model number + type	laminate	veneer 1	veneer 2	veneer 3
	30	66	29 1/2	<b>GS3DHAK3066-</b> <input type="checkbox"/>	5,705	8,411	9,253	10,094
	30	72	29 1/2	<b>GS3DHAK3072-</b> <input type="checkbox"/>	5,822	8,584	9,443	10,301
	36	72	29 1/2	<b>GS3DHAK3672-</b> <input type="checkbox"/>	6,131	8,757	9,633	10,509
	36	78	29 1/2	<b>GS3DHAK3678-</b> <input type="checkbox"/>	6,275	8,933	9,827	10,720

- Provides sit to stand electric height adjustment
- 29.5" to 42.5" height adjustment range

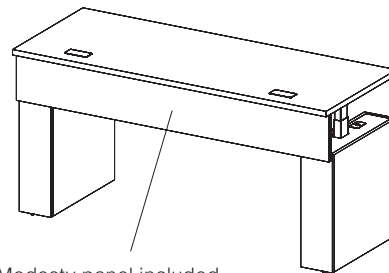

Modesty panel included.

## PRODUCT INFO

All tops long grain standard.  
Wood models ship assembled.

 Laminate units shipped as separate packages and require field assembly..

### Grommet Location (Add \$80 per grommet)

No Grommet **GN**  
Left **GL**  
Right **GR**  
Left & Right **GB**

Specify location first, then select grommet color or "Empty Cutout" option. When "Empty Cutout" option is selected, a grommet or power unit must be ordered separately for each cutout.

NOTE: Monitor arms should **ALWAYS** be installed in grommets on Silea height adjustable units. Please ensure a grommet location is specified on the top. This allows for bolt mount or clamp mount install of monitor arm. See page 35 for details.

## TO ORDER PLEASE SPECIFY THE FOLLOWING:

### WOOD TOP, WOOD CHASSIS

1. **MODEL NUMBER + WW**
2. **FSC**
3. **TOP WOOD FINISH + EDGE**
4. **CHASSIS WOOD FINISH**
5. **TOP FINISH**
6. **HAT KEYPAD & BASE COLOR**
7. **GROMMET**

### LAM TOP, LAM CHASSIS

1. **MODEL NUMBER + LL**
2. **FSC**
3. **TOP LAM**
4. **CHASSIS LAM**
5. **EDGE DETAIL**
6. **HAT KEYPAD & BASE COLOR**
7. **GROMMET**

Optional height adjustable keypads available

### HAT KEYPAD & BASE COLOR

Basic Up/Down Keypad, Black P71 Column  
Memory Preset Keypad, Black P71 Column  
Paddle Keypad, Black P71 Column

**UDP71**  
**MEMP71**  
**PDLP71**

# HEIGHT ADJUSTABLE EXTENSION DESK

Half Modesty | Left and Right Hand

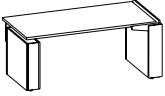
	D	W	H	model number + type	laminata	veneer 1	veneer 2	veneer 3
<b>LEFT HAND</b> 	30	66	29 1/2	<b>GS3XHAK3066L-</b> [ ]	6,081	8,411	9,253	10,094
	30	72	29 1/2	<b>GS3XHAK3072L-</b> [ ]	6,198	8,584	9,443	10,301
	36	72	29 1/2	<b>GS3XHAK3672L-</b> [ ]	6,467	8,757	9,633	10,509
	36	78	29 1/2	<b>GS3XHAK3678L-</b> [ ]	6,611	8,933	9,827	10,720

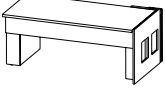
<b>RIGHT HAND</b> 	30	66	29 1/2	<b>GS3XHAK3066R-</b> [ ]	6,081	8,411	9,253	10,094
	30	72	29 1/2	<b>GS3XHAK3072R-</b> [ ]	6,198	8,584	9,443	10,301
	36	72	29 1/2	<b>GS3XHAK3672R-</b> [ ]	6,467	8,757	9,633	10,509
	36	78	29 1/2	<b>GS3XHAK3678R-</b> [ ]	6,611	8,933	9,827	10,720

- Provides sit to stand electric height adjustment
- 29.5" to 42.5" height adjustment range
- Cantilever extends 3" to support adjoining worksurface

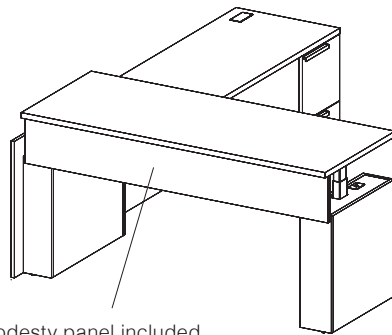

Modesty panel included.

NOTE: If attaching to a return or bridge, a 3" shorter modesty or wall access panel must be used.

## PRODUCT INFO

Specify base from user seated position.

All tops long grain standard.

Wood models ship assembled.

 Laminate units shipped as separate packages and require field assembly.

### Grommet Location (Add \$80 per grommet)

No Grommet **GN**  
 Left **GL**  
 Right **GR**  
 Left & Right **GB**

Specify location first, then select grommet color or "Empty Cutout" option. When "Empty Cutout" option is selected, a grommet or power unit must be ordered separately for each cutout.

NOTE: Monitor arms should **ALWAYS** be installed in grommets on Silea height adjustable units. Please ensure a grommet location is specified on the top. This allows for bolt mount or clamp mount install of monitor arm. See page 35 for details.

## TO ORDER PLEASE SPECIFY THE FOLLOWING:

### WOOD TOP, WOOD CHASSIS

1. **MODEL NUMBER + WW**
2. **FSC**
3. **TOP WOOD FINISH + EDGE**
4. **CHASSIS WOOD FINISH**
5. **TOP FINISH**
6. **HAT KEYPAD & BASE COLOR**
7. **GROMMET**

### LAM TOP, LAM CHASSIS

1. **MODEL NUMBER + LL**
2. **FSC**
3. **TOP LAM**
4. **CHASSIS LAM**
5. **EDGE DETAIL**
6. **HAT KEYPAD & BASE COLOR**
7. **GROMMET**

Optional height adjustable keypads available

### HAT KEYPAD & BASE COLOR

Basic Up/Down Keypad, Black P71 Column  
 Memory Preset Keypad, Black P71 Column  
 Paddle Keypad, Black P71 Column

**UDP71**  
**MEMP71**  
**PDLP71**

# HEIGHT ADJUSTABLE CREDENZA 24D

w/ Wall Access and End Panels

Silea  
02/24

	D	W	H	model number + type	laminate	veneer 1	veneer 2	veneer 3
	24	42	29 1/2	<b>GS3CAK2442-</b> [ ]	4,723	6,656	7,322	7,988
	24	48	29 1/2	<b>GS3CAK2448-</b> [ ]	4,835	6,813	7,495	8,176
	24	54	29 1/2	<b>GS3CAK2454-</b> [ ]	4,923	6,939	7,633	8,327
	24	60	29 1/2	<b>GS3CAK2460-</b> [ ]	5,036	7,099	7,809	8,519
	24	66	29 1/2	<b>GS3CAK2466-</b> [ ]	5,144	7,247	7,972	8,697
	24	72	29 1/2	<b>GS3CAK2472-</b> [ ]	5,295	7,470	8,217	8,964

- Provides sit to stand electric height adjustment
- 29.5" to 42.5" height adjustment range

## PRODUCT INFO

Wood tops optional grain standard. Lam tops optional grain up to 60", over 60" long grain standard.

Wood models ship assembled.

Laminate units shipped as separate packages and require field assembly.

### Grommet Location

(Add \$80 per grommet)

No Grommet **GN**  
Center **GC**

Specify location first, then select grommet color or "Empty Cutout" option. When "Empty Cutout" option is selected, a grommet or power unit must be ordered separately for each cutout.

NOTE: Monitor arms should **ALWAYS** be installed in grommets on Silea height adjustable units. Please ensure a grommet location is specified on the top. This allows for bolt mount or clamp mount install of monitor arm. See page 35 for details.

## TO ORDER PLEASE SPECIFY THE FOLLOWING:

### WOOD TOP, WOOD CHASSIS

1. **MODEL NUMBER + WW**
2. **FSC**
3. **TOP WOOD FINISH + EDGE**
4. **CHASSIS WOOD FINISH**
5. **TOP FINISH**
6. **GRAIN DIRECTION**
7. **HAT KEYPAD & BASE COLOR**
8. **GROMMET**

### LAM TOP, LAM CHASSIS

1. **MODEL NUMBER + LL**
2. **FSC**
3. **TOP LAM**
4. **CHASSIS LAM**
5. **GRAIN DIRECTION (up to 60")**
6. **EDGE DETAIL**
7. **HAT KEYPAD & BASE COLOR**
8. **GROMMET**

Optional height adjustable keypads available

### HAT KEYPAD & BASE COLOR

Basic Up/Down Keypad, Black P71 Column  
Memory Preset Keypad, Black P71 Column  
Paddle Keypad, Black P71 Column

**UDP71**  
**MEMP71**  
**PDLP71**

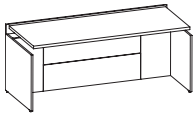
	D	W	H	model number + type	laminate	veneer 1	veneer 2	veneer 3
	30	42	29 1/2	<b>GS3CAK3042-</b> [ ]	5,143	7,321	8,054	8,786
	30	48	29 1/2	<b>GS3CAK3048-</b> [ ]	5,243	7,494	8,244	8,993
	30	54	29 1/2	<b>GS3CAK3054-</b> [ ]	5,301	7,632	8,396	9,159
	30	60	29 1/2	<b>GS3CAK3060-</b> [ ]	5,359	7,809	8,590	9,371
	30	66	29 1/2	<b>GS3CAK3066-</b> [ ]	5,462	7,972	8,770	9,567
	30	72	29 1/2	<b>GS3CAK3072-</b> [ ]	5,560	8,215	9,037	9,858

- Provides sit to stand electric height adjustment
- 29.5" to 42.5" height adjustment range

**PRODUCT INFO**

Wood tops optional grain standard. Lam tops optional grain up to 60", over 60" long grain standard.

Wood models ship assembled.

 Laminate units shipped as separate packages and require field assembly.

**Grommet Location**

(Add \$80 per grommet)

No Grommet **GN**  
Center **GC**

Specify location first, then select grommet color or "Empty Cutout" option. When "Empty Cutout" option is selected, a grommet or power unit must be ordered separately for each cutout.

NOTE: Monitor arms should **ALWAYS** be installed in grommets on Silea height adjustable units. Please ensure a grommet location is specified on the top. This allows for bolt mount or clamp mount install of monitor arm. See page 35 for details.

**TO ORDER PLEASE SPECIFY THE FOLLOWING:**

WOOD TOP, WOOD CHASSIS

- MODEL NUMBER + WW**
- FSC**
- TOP WOOD FINISH + EDGE**
- CHASSIS WOOD FINISH**
- TOP FINISH**
- GRAIN DIRECTION**
- HAT KEYPAD & BASE COLOR**
- GROMMET**

LAM TOP, LAM CHASSIS

- MODEL NUMBER + LL**
- FSC**
- TOP LAM**
- CHASSIS LAM**
- GRAIN DIRECTION (up to 60")**
- EDGE DETAIL**
- HAT KEYPAD & BASE COLOR**
- GROMMET**

Optional height adjustable keypads available

**HAT KEYPAD & BASE COLOR**

Basic Up/Down Keypad, Black P71 Column  
Memory Preset Keypad, Black P71 Column  
Paddle Keypad, Black P71 Column

**UDP71**  
**MEMP71**  
**PDLP71**

# HEIGHT ADJUSTABLE CREDENZA 24D

w/ Hidden Accessory | Box | File Pedestals

Silea  
02/24

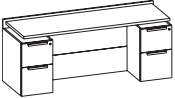
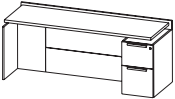
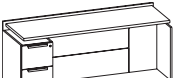
	D	W	H	model number + type	laminate	veneer 1	veneer 2	veneer 3	
	24	66	29 1/2	<b>GS3CAK2466-AA</b> [ ]	6,705	10,300	11,330	12,360	
	24	72	29 1/2	<b>GS3CAK2472-AA</b> [ ]	6,860	10,524	11,577	12,629	
<b>RIGHT HAND</b>									
	24	66	29 1/2	<b>GS3CAK2466R-A</b> [ ]	5,313	8,615	9,477	10,338	
	24	72	29 1/2	<b>GS3CAK2472R-A</b> [ ]	5,469	8,839	9,723	10,607	
<b>LEFT HAND</b>									
	24	66	29 1/2	<b>GS3CAK2466L-A</b> [ ]	5,313	8,615	9,477	10,338	
	24	72	29 1/2	<b>GS3CAK2472L-A</b> [ ]	5,469	8,839	9,723	10,607	

- Provides sit to stand electric height adjustment
- 29.5" to 42.5" height adjustment range

## PRODUCT INFO

Specify pedestal from user seated position.

Wood tops optional grain standard. Lam tops long grain standard.

Wood models ship assembled.

 Laminate units shipped as separate packages and require field assembly.

### Grommet Location

(Add \$80 per grommet)

No Grommet **GN**  
Center **GC**

Specify location first, then select grommet color or "Empty Cutout" option. When "Empty Cutout" option is selected, a grommet or power unit must be ordered separately for each cutout.

NOTE: Monitor arms should **ALWAYS** be installed in grommets on Silea height adjustable units. Please ensure a grommet location is specified on the top. This allows for bolt mount or clamp mount install of monitor arm. See page 35 for details.

## TO ORDER PLEASE SPECIFY THE FOLLOWING:

WOOD TOP, WOOD CHASSIS

1. **MODEL NUMBER + WW**
2. **FSC**
3. **TOP WOOD FINISH + EDGE**
4. **CHASSIS WOOD FINISH**
5. **TOP FINISH**
6. **GRAIN DIRECTION**
7. **PULL**
8. **HAT KEYPAD & BASE COLOR**
9. **GROMMET**
10. **KEYING**

LAM TOP, LAM CHASSIS

1. **MODEL NUMBER + LL**
2. **FSC**
3. **TOP LAM**
4. **CHASSIS LAM**
5. **FRONT LAM**
6. **EDGE DETAIL**
7. **PULL**
8. **HAT KEYPAD & BASE COLOR**
9. **GROMMET**
10. **KEYING**

Optional height adjustable keypads available

### HAT KEYPAD & BASE COLOR

Basic Up/Down Keypad, Black P71 Column  
Memory Preset Keypad, Black P71 Column  
Paddle Keypad, Black P71 Column

**UDP71**  
**MEMP71**  
**PDLP71**

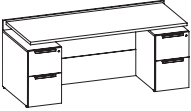
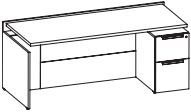
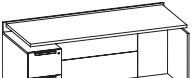

	D	W	H	model number + type	laminate	veneer 1	veneer 2	veneer 3	
	30	66	29 1/2	<b>GS3CAK3066-AA</b> [ ]	6,951	11,331	12,465	13,598	
	30	72	29 1/2	<b>GS3CAK3072-AA</b> [ ]	7,051	11,576	12,734	13,892	
<b>RIGHT HAND</b>									
	30	66	29 1/2	<b>GS3CAK3066R-A</b> [ ]	5,565	9,477	10,425	11,373	
	30	72	29 1/2	<b>GS3CAK3072R-A</b> [ ]	5,669	9,723	10,696	11,668	
<b>LEFT HAND</b>									
	30	66	29 1/2	<b>GS3CAK3066L-A</b> [ ]	5,565	9,477	10,425	11,373	
	30	72	29 1/2	<b>GS3CAK3072L-A</b> [ ]	5,669	9,723	10,696	11,668	

- Provides sit to stand electric height adjustment
- 29.5" to 42.5" height adjustment range

## PRODUCT INFO

Wood tops optional grain standard. Lam tops optional grain up to 60", over 60" long grain standard.

Wood models ship assembled.

 Laminate units shipped as separate packages and require field assembly.

### Grommet Location (Add \$80 per grommet)

No Grommet **GN**  
Center **GC**

Specify location first, then select grommet color or "Empty Cutout" option. When "Empty Cutout" option is selected, a grommet or power unit must be ordered separately for each cutout.

NOTE: Monitor arms should **ALWAYS** be installed in grommets on Silea height adjustable units. Please ensure a grommet location is specified on the top. This allows for bolt mount or clamp mount install of monitor arm. See page 35 for details.

## TO ORDER PLEASE SPECIFY THE FOLLOWING:

### WOOD TOP, WOOD CHASSIS

- MODEL NUMBER + WW**
- FSC**
- TOP WOOD FINISH + EDGE**
- CHASSIS WOOD FINISH**
- TOP FINISH**
- GRAIN DIRECTION**
- PULL**
- HAT KEYPAD & BASE COLOR**
- GROMMET**
- KEYING**

### LAM TOP, LAM CHASSIS

- MODEL NUMBER + LL**
- FSC**
- TOP LAM**
- CHASSIS LAM**
- FRONT LAM**
- EDGE DETAIL**
- PULL**
- HAT KEYPAD & BASE COLOR**
- GROMMET**
- KEYING**

Optional height adjustable keypads available

### HAT KEYPAD & BASE COLOR

Basic Up/Down Keypad, Black P71 Column  
Memory Preset Keypad, Black P71 Column  
Paddle Keypad, Black P71 Column

**UDP71**  
**MEMP71**  
**PDLP71**

# HEIGHT ADJUSTABLE BRIDGE 24D

w/ Wall Access

Silea  
02/24

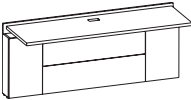
	D	W	H	model number + type	laminate	veneer 1	veneer 2	veneer 3
	24	42	29 1/2	<b>GS3BAK2442-</b> [ ]	3,798	5,356	5,892	6,428
	24	48	29 1/2	<b>GS3BAK2448-</b> [ ]	3,909	5,514	6,066	6,617
	24	54	29 1/2	<b>GS3BAK2454-</b> [ ]	3,997	5,639	6,203	6,767
	24	60	29 1/2	<b>GS3BAK2460-</b> [ ]	4,111	5,798	6,378	6,958
	24	66	29 1/2	<b>GS3BAK2466-</b> [ ]	4,218	5,949	6,544	7,139
	24	72	29 1/2	<b>GS3BAK2472-</b> [ ]	4,371	6,170	6,787	7,404

- **Unit must be wall mounted.**
- Provides sit to stand electric height adjustment
- 29.5" to 42.5" height adjustment range

## PRODUCT INFO

Wood tops optional grain standard. Lam tops opt grain up to 60". over 60" long grain standard.

Wood models shipped assembled.

 Laminate units shipped as separate packages and require field assembly.

### Grommet Location

(Add \$80 per grommet)

No Grommet **GN**  
Center **GC**

Specify location first, then select grommet color or "Empty Cutout" option. When "Empty Cutout" option is selected, a grommet or power unit must be ordered separately for each cutout.

NOTE: Monitor arms should **ALWAYS** be installed in grommets on Silea height adjustable units. Please ensure a grommet location is specified on the top. This allows for bolt mount or clamp mount install of monitor arm. See page 35 for details.

## TO ORDER PLEASE SPECIFY THE FOLLOWING:

### WOOD TOP, WOOD CHASSIS

- MODEL NUMBER + WW**
- FSC**
- TOP WOOD FINISH + EDGE**
- CHASSIS WOOD FINISH**
- TOP FINISH**
- GRAIN DIRECTION**
- HAT KEYPAD & BASE COLOR**
- GROMMET**

### LAM TOP, LAM CHASSIS

- MODEL NUMBER + LL**
- FSC**
- TOP LAM**
- CHASSIS LAM**
- GRAIN DIRECTION (up to 60")**
- EDGE DETAIL**
- HAT KEYPAD & BASE COLOR**
- GROMMET**

Optional height adjustable keypads available

### HAT KEYPAD & BASE COLOR

Basic Up/Down Keypad, Black P71 Column  
Memory Preset Keypad, Black P71 Column  
Paddle Keypad, Black P71 Column

**UDP71**  
**MEMP71**  
**PDLP71**

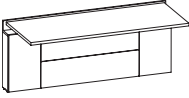
	D	W	H	model number + type	laminate	veneer 1	veneer 2	veneer 3
	30	42	29 1/2	<b>GS3BAK3042-</b> [ ]	3,996	5,624	6,187	6,749
	30	48	29 1/2	<b>GS3BAK3048-</b> [ ]	4,090	5,790	6,369	6,948
	30	54	29 1/2	<b>GS3BAK3054-</b> [ ]	4,146	5,921	6,514	7,106
	30	60	29 1/2	<b>GS3BAK3060-</b> [ ]	4,202	6,089	6,698	7,307
	30	66	29 1/2	<b>GS3BAK3066-</b> [ ]	4,298	6,247	6,872	7,497
	30	72	29 1/2	<b>GS3BAK3072-</b> [ ]	4,396	6,478	7,126	7,774

- **Unit must be wall mounted.**
- Provides sit to stand electric height adjustment
- 29.5" to 42.5" height adjustment range

**PRODUCT INFO**

Wood tops optional grain standard. Lam tops optional grain up to 60", over 60" long grain standard.

Wood models shipped assembled.

 Laminate units shipped as separate packages and require field assembly.

**Grommet Location**  
(Add \$80 per grommet)

No Grommet **GN**  
Center **GC**

Specify location first, then select grommet color or "Empty Cutout" option. When "Empty Cutout" option is selected, a grommet or power unit must be ordered separately for each cutout.

NOTE: Monitor arms should **ALWAYS** be installed in grommets on Silea height adjustable units. Please ensure a grommet location is specified on the top. This allows for bolt mount or clamp mount install of monitor arm. See page 35 for details.

**TO ORDER PLEASE SPECIFY THE FOLLOWING:**

WOOD TOP, WOOD CHASSIS

- MODEL NUMBER + WW**
- FSC**
- TOP WOOD FINISH + EDGE**
- CHASSIS WOOD FINISH**
- TOP FINISH**
- GRAIN DIRECTION**
- HAT KEYPAD & BASE COLOR**
- GROMMET**

LAM TOP, LAM CHASSIS

- MODEL NUMBER + LL**
- FSC**
- TOP LAM**
- CHASSIS LAM**
- GRAIN DIRECTION (up to 60")**
- EDGE DETAIL**
- HAT KEYPAD & BASE COLOR**
- GROMMET**

Optional height adjustable keypads available

**HAT KEYPAD & BASE COLOR**

Basic Up/Down Keypad, Black P71 Column  
Memory Preset Keypad, Black P71 Column  
Paddle Keypad, Black P71 Column

**UDP71**  
**MEMP71**  
**PDLP71**

# HEIGHT ADJUSTABLE RETURN 24D

w/ End Panel | Left and Right Hand

Silea

02/24

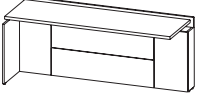
	D	W	H	model number + type	laminate	veneer 1	veneer 2	veneer 3
<b>LEFT HAND</b> 	24	42	29 1/2	<b>GS3RAK2442L-</b> <input type="checkbox"/>	4,260	6,005	6,606	7,206
	24	48	29 1/2	<b>GS3RAK2448L-</b> <input type="checkbox"/>	4,373	6,164	6,781	7,397
	24	54	29 1/2	<b>GS3RAK2454L-</b> <input type="checkbox"/>	4,460	6,289	6,918	7,547
	24	60	29 1/2	<b>GS3RAK2460L-</b> <input type="checkbox"/>	4,574	6,448	7,093	7,738
	24	66	29 1/2	<b>GS3RAK2466L-</b> <input type="checkbox"/>	4,679	6,598	7,258	7,918
	24	72	29 1/2	<b>GS3RAK2472L-</b> <input type="checkbox"/>	4,832	6,819	7,501	8,183

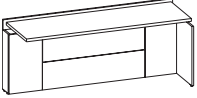
<b>RIGHT HAND</b> 	24	42	29 1/2	<b>GS3RAK2442R-</b> <input type="checkbox"/>	4,260	6,005	6,606	7,206
	24	48	29 1/2	<b>GS3RAK2448R-</b> <input type="checkbox"/>	4,373	6,164	6,781	7,397
	24	54	29 1/2	<b>GS3RAK2454R-</b> <input type="checkbox"/>	4,460	6,289	6,918	7,547
	24	60	29 1/2	<b>GS3RAK2460R-</b> <input type="checkbox"/>	4,574	6,448	7,093	7,738
	24	66	29 1/2	<b>GS3RAK2466R-</b> <input type="checkbox"/>	4,679	6,598	7,258	7,918
	24	72	29 1/2	<b>GS3RAK2472R-</b> <input type="checkbox"/>	4,832	6,819	7,501	8,183

- **Unit must be wall mounted.**
- Provides sit to stand electric height adjustment
- 29.5" to 42.5" height adjustment range

## PRODUCT INFO

Wood tops optional grain standard. Lam tops optional grain up to 60", over 60" long grain standard.

Wood models ship assembled.

 Laminate units shipped as separate packages and require field assembly.

**Grommet Location**  
(Add \$80 per grommet)

No Grommet **GN**  
Center **GC**

Specify location first, then select grommet color or "Empty Cutout" option. When "Empty Cutout" option is selected, a grommet or power unit must be ordered separately for each cutout.

NOTE: Monitor arms should **ALWAYS** be installed in grommets on Silea height adjustable units. Please ensure a grommet location is specified on the top. This allows for bolt mount or clamp mount install of monitor arm. See page 35 for details.

## TO ORDER PLEASE SPECIFY THE FOLLOWING:

WOOD TOP, WOOD CHASSIS

LAM TOP, LAM CHASSIS

- |                                       |                                       |
|---------------------------------------|---------------------------------------|
| 1. <b>MODEL NUMBER + WW</b>           | 1. <b>MODEL NUMBER + LL</b>           |
| 2. <b>FSC</b>                         | 2. <b>FSC</b>                         |
| 3. <b>TOP WOOD FINISH + EDGE</b>      | 3. <b>TOP LAM</b>                     |
| 4. <b>CHASSIS WOOD FINISH</b>         | 4. <b>CHASSIS LAM</b>                 |
| 5. <b>TOP FINISH</b>                  | 5. <b>GRAIN DIRECTION (up to 60")</b> |
| 6. <b>GRAIN DIRECTION</b>             | 6. <b>EDGE DETAIL</b>                 |
| 7. <b>HAT KEYPAD &amp; BASE COLOR</b> | 7. <b>HAT KEYPAD &amp; BASE COLOR</b> |
| 8. <b>GROMMET</b>                     | 8. <b>GROMMET</b>                     |

Optional height adjustable keypads available

### HAT KEYPAD & BASE COLOR

Basic Up/Down Keypad, Black P71 Column  
Memory Preset Keypad, Black P71 Column  
Paddle Keypad, Black P71 Column

**UDP71**  
**MEMP71**  
**PDL71**

# HEIGHT ADJUSTABLE RETURN 30D

w/ End Panel | Left and Right Hand

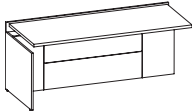
	D	W	H	model number + type	laminate	veneer 1	veneer 2	veneer 3
<b>LEFT HAND</b> 	30	42	29 1/2	<b>GS3RAK3042L-</b> <input type="checkbox"/>	4,635	6,606	7,267	7,928
	30	48	29 1/2	<b>GS3RAK3048L-</b> <input type="checkbox"/>	4,733	6,780	7,458	8,136
	30	54	29 1/2	<b>GS3RAK3054L-</b> <input type="checkbox"/>	4,792	6,917	7,609	8,301
	30	60	29 1/2	<b>GS3RAK3060L-</b> <input type="checkbox"/>	4,851	7,092	7,802	8,511
	30	66	29 1/2	<b>GS3RAK3066L-</b> <input type="checkbox"/>	4,950	7,257	7,983	8,709
	30	72	29 1/2	<b>GS3RAK3072L-</b> <input type="checkbox"/>	5,053	7,500	8,250	9,000

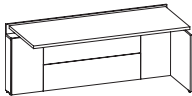
<b>RIGHT HAND</b> 	30	42	29 1/2	<b>GS3RAK3042R-</b> <input type="checkbox"/>	4,635	6,606	7,267	7,928
	30	48	29 1/2	<b>GS3RAK3048R-</b> <input type="checkbox"/>	4,733	6,780	7,458	8,136
	30	54	29 1/2	<b>GS3RAK3054R-</b> <input type="checkbox"/>	4,792	6,917	7,609	8,301
	30	60	29 1/2	<b>GS3RAK3060R-</b> <input type="checkbox"/>	4,851	7,092	7,802	8,511
	30	66	29 1/2	<b>GS3RAK3066R-</b> <input type="checkbox"/>	4,950	7,257	7,983	8,709
	30	72	29 1/2	<b>GS3RAK3072R-</b> <input type="checkbox"/>	5,053	7,500	8,250	9,000

- **Unit must be wall mounted.**
- Provides sit to stand electric height adjustment
- 29.5" to 42.5" height adjustment range

## PRODUCT INFO

Wood tops optional grain standard. Lam tops optional grain up to 60", over 60" long grain standard.

Wood models ship assembled.

 Laminate units shipped as separate packages and require field assembly.

**Grommet Location**  
(Add \$80 per grommet)

No Grommet **GN**  
Center **GC**

Specify location first, then select grommet color or "Empty Cutout" option. When "Empty Cutout" option is selected, a grommet or power unit must be ordered separately for each cutout.

NOTE: Monitor arms should **ALWAYS** be installed in grommets on Silea height adjustable units. Please ensure a grommet location is specified on the top. This allows for bolt mount or clamp mount install of monitor arm. See page 35 for details.

## TO ORDER PLEASE SPECIFY THE FOLLOWING:

WOOD TOP, WOOD CHASSIS

- MODEL NUMBER + WW**
- FSC**
- TOP WOOD FINISH + EDGE**
- CHASSIS WOOD FINISH**
- TOP FINISH**
- GRAIN DIRECTION**
- HAT KEYPAD & BASE COLOR**
- GROMMET**

LAM TOP, LAM CHASSIS

- MODEL NUMBER + LL**
- FSC**
- TOP LAM**
- CHASSIS LAM**
- GRAIN DIRECTION (up to 60")**
- EDGE DETAIL**
- HAT KEYPAD & BASE COLOR**
- GROMMET**

Optional height adjustable keypads available

### HAT KEYPAD & BASE COLOR

Basic Up/Down Keypad, Black P71 Column  
Memory Preset Keypad, Black P71 Column  
Paddle Keypad, Black P71 Column

**UDP71**  
**MEMP71**  
**PDLP71**

# HEIGHT ADJUSTABLE RETURN 24D

w/ Hidden Accessory | Box | File | Pedestals

Silea

02/24

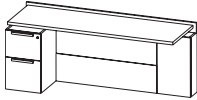
	D	W	H	model number + type	laminate	veneer 1	veneer 2	veneer 3
<b>LEFT HAND</b> 	24	42	29 1/2	<b>GS3RAK2442L-A</b> [ ]	4,737	7,530	8,283	9,036
	24	48	29 1/2	<b>GS3RAK2448L-A</b> [ ]	4,847	7,692	8,462	9,231
	24	54	29 1/2	<b>GS3RAK2454L-A</b> [ ]	4,936	7,813	8,595	9,376
	24	60	29 1/2	<b>GS3RAK2460L-A</b> [ ]	5,052	7,978	8,776	9,574
	24	66	29 1/2	<b>GS3RAK2466L-A</b> [ ]	5,236	8,126	8,939	9,752
	24	72	29 1/2	<b>GS3RAK2472L-A</b> [ ]	5,394	8,346	9,181	10,016

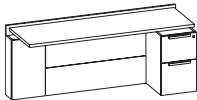
<b>RIGHT HAND</b> 	24	42	29 1/2	<b>GS3RAK2442R-A</b> [ ]	4,737	7,530	8,283	9,036
	24	48	29 1/2	<b>GS3RAK2448R-A</b> [ ]	4,847	7,692	8,462	9,231
	24	54	29 1/2	<b>GS3RAK2454R-A</b> [ ]	4,936	7,813	8,595	9,376
	24	60	29 1/2	<b>GS3RAK2460R-A</b> [ ]	5,052	7,978	8,776	9,574
	24	66	29 1/2	<b>GS3RAK2466R-A</b> [ ]	5,236	8,126	8,939	9,752
	24	72	29 1/2	<b>GS3RAK2472R-A</b> [ ]	5,394	8,346	9,181	10,016

- **Unit must be wall mounted.**
- Provides sit to stand electric height adjustment
- 29.5" to 42.5" height adjustment range

## PRODUCT INFO

Wood tops optional grain standard. Lam tops optional grain up to 60", over 60" long grain standard.

If integral pull is chosen, the wall access panel will have a black knob.

Wood models ship assembled.

 Laminate units shipped as separate packages and require field assembly.

**Grommet Location**  
(Add \$80 per grommet)

No Grommet **GN**  
Center **GC**

Specify location first, then select grommet color or "Empty Cutout" option. When "Empty Cutout" option is selected, a grommet or power unit must be ordered separately for each cutout.

NOTE: Monitor arms should **ALWAYS** be installed in grommets on Silea height adjustable units. Please ensure a grommet location is specified on the top. This allows for bolt mount or clamp mount install of monitor arm. See page 35 for details.

## TO ORDER PLEASE SPECIFY THE FOLLOWING:

### WOOD TOP, WOOD CHASSIS

- MODEL NUMBER + WW**
- FSC**
- TOP WOOD FINISH + EDGE**
- CHASSIS WOOD FINISH**
- TOP FINISH**
- GRAIN DIRECTION**
- PULL**
- HAT KEYPAD & BASE COLOR**
- GROMMET**
- KEYING**

### LAM TOP, LAM CHASSIS

- MODEL NUMBER + LL**
- FSC**
- TOP LAM**
- CHASSIS LAM**
- FRONT LAM**
- GRAIN DIRECTION (up to 60")**
- PULL**
- HAT KEYPAD & BASE COLOR**
- GROMMET**
- KEYING**

Optional height adjustable keypads available

#### HAT KEYPAD & BASE COLOR

Basic Up/Down Keypad, Black P71 Column  
Memory Preset Keypad, Black P71 Column  
Paddle Keypad, Black P71 Column

**UDP71**  
**MEMP71**  
**PDLP71**

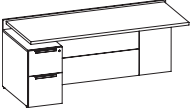
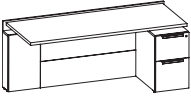
	D	W	H	model number + type	laminate	veneer 1	veneer 2	veneer 3
<b>LEFT HAND</b> 	30	42	29 1/2	<b>GS3RAK3042L-A</b> <input type="checkbox"/>	5,018	8,282	9,111	9,939
	30	48	29 1/2	<b>GS3RAK3048L-A</b> <input type="checkbox"/>	5,111	8,462	9,309	10,155
	30	54	29 1/2	<b>GS3RAK3054L-A</b> <input type="checkbox"/>	5,168	8,594	9,454	10,313
	30	60	29 1/2	<b>GS3RAK3060L-A</b> <input type="checkbox"/>	5,226	8,775	9,653	10,530
	30	66	29 1/2	<b>GS3RAK3066L-A</b> <input type="checkbox"/>	5,399	8,939	9,833	10,727
	30	72	29 1/2	<b>GS3RAK3072L-A</b> <input type="checkbox"/>	5,502	9,180	10,098	11,016
<b>RIGHT HAND</b> 	30	42	29 1/2	<b>GS3RAK3042R-A</b> <input type="checkbox"/>	5,018	8,282	9,111	9,939
	30	48	29 1/2	<b>GS3RAK3048R-A</b> <input type="checkbox"/>	5,111	8,462	9,309	10,155
	30	54	29 1/2	<b>GS3RAK3054R-A</b> <input type="checkbox"/>	5,168	8,594	9,454	10,313
	30	60	29 1/2	<b>GS3RAK3060R-A</b> <input type="checkbox"/>	5,226	8,775	9,653	10,530
	30	66	29 1/2	<b>GS3RAK3066R-A</b> <input type="checkbox"/>	5,399	8,939	9,833	10,727
	30	72	29 1/2	<b>GS3RAK3072R-A</b> <input type="checkbox"/>	5,502	9,180	10,098	11,016

- Unit must be wall mounted.
- Provides sit to stand electric height adjustment
- 29.5" to 42.5" height adjustment range

**PRODUCT INFO**

Wood tops optional grain standard. Lam tops optional grain up to 60", over 60" long grain standard. Wood models ship assembled.  Laminate units shipped as separate packages and require field assembly.

**Grommet Location**  
(Add \$80 per grommet)

No Grommet **GN**  
Center **GC**  
Specify location first, then select grommet color or "Empty Cutout" option. When "Empty Cutout" option is selected, a grommet or power unit must be ordered separately for each cutout.

NOTE: Monitor arms should **ALWAYS** be installed in grommets on Silea height adjustable units. Please ensure a grommet location is specified on the top. This allows for bolt mount or clamp mount install of monitor arm. See page 35 for details.

**TO ORDER PLEASE SPECIFY THE FOLLOWING:**

- |                                       |                                       |
|---------------------------------------|---------------------------------------|
| WOOD TOP, WOOD CHASSIS                | LAM TOP, LAM CHASSIS                  |
| 1. <b>MODEL NUMBER + WW</b>           | 1. <b>MODEL NUMBER + LL</b>           |
| 2. <b>FSC</b>                         | 2. <b>FSC</b>                         |
| 3. <b>TOP WOOD FINISH + EDGE</b>      | 3. <b>TOP LAM</b>                     |
| 4. <b>CHASSIS WOOD FINISH</b>         | 4. <b>CHASSIS LAM</b>                 |
| 5. <b>TOP FINISH</b>                  | 5. <b>FRONT LAM</b>                   |
| 6. <b>GRAIN DIRECTION</b>             | 6. <b>GRAIN DIRECTION (up to 60")</b> |
| 7. <b>PULL</b>                        | 7. <b>EDGE DETAIL</b>                 |
| 8. <b>HAT KEYPAD &amp; BASE COLOR</b> | 8. <b>PULL</b>                        |
| 9. <b>GROMMET</b>                     | 9. <b>HAT KEYPAD &amp; BASE COLOR</b> |
| 10. <b>KEYING</b>                     | 10. <b>GROMMET</b>                    |
|                                       | 11. <b>KEYING</b>                     |

Optional height adjustable keypads available

**HAT KEYPAD & BASE COLOR**

Basic Up/Down Keypad, Black P71 Column	<b>UDP71</b>
Memory Preset Keypad, Black P71 Column	<b>MEMP71</b>
Paddle Keypad, Black P71 Column	<b>PDLP71</b>

## Step 1: Select workwall chassis configuration and total width.



Bridge w/o Pedestals  
(non-handed)

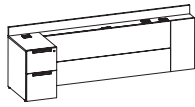

Return w/ Pedestal  
Left Hand



Return w/ Pedestal  
Right Hand

## Step 2: Select desk chassis style and size.

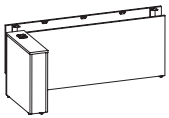

Full modesty,  
shroud pedestal  
(left hand shown)

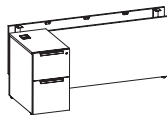

Full modesty,  
pedestal  
(left hand shown)

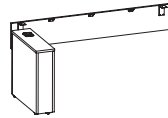

Half modesty,  
shroud pedestal  
(left hand shown)



Half modesty,  
pedestal  
(left hand shown)

## Step 3. Order desk and return rectangular tops OR a 2-piece cockpit shape top.



Desk  
30" or 36" Depth



Return  
24" or 30" Depth

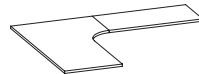

Cockpit Shape  
2-piece  
(left hand shown)

**Note:** for rectangular tops, flat brackets must be ordered separately.

## Step 4. Order height adjustable hardware and bracketry kit. Select appropriate 3 motor or 4 motor kit based on total workwall length in Step 1.

Total Workwall Width	# Motors	Model # to Order
Workwall 72"	3	GS4LALNKDPD-3
Workwall 78"	3	GS4LALNKDPD-3
Workwall 84"	3	GS4LALNKDPD-3
Workwall 90"	3	GS4LALNKDPD-3
Workwall 96"	3	GS4LALNKDPD-3
Workwall 102"	4	GS4LALNKDPD-4
Workwall 108"	4	GS4LALNKDPD-4

**NOTE:** Monitor arms should **ALWAYS** be installed in grommets on Silea height adjustable units. Please ensure a grommet location is specified on the top. This allows for bolt mount or clamp mount install of monitor arm. See page 35 for details.



	D	W	H	model number + type	laminate	veneer 1	veneer 2	veneer 3
	7 1/4	72	27 7/8	<b>GS4PLWFP72-</b> [ ]	1,820	3,060	3,366	3,672
	7 1/4	78	27 7/8	<b>GS4PLWFP78-</b> [ ]	1,965	3,302	3,633	3,963
	7 1/4	84	27 7/8	<b>GS4PLWFP84-</b> [ ]	2,041	3,439	3,783	4,127
	7 1/4	90	27 7/8	<b>GS4PLWFP90-</b> [ ]	2,145	3,789	4,168	4,547
	7 1/4	96	27 7/8	<b>GS4PLWFP96-</b> [ ]	2,133	3,713	4,085	4,456
	7 1/4	102	27 7/8	<b>GS4PLWFP102-</b> [ ]	N/A	3,898	4,288	4,678
	7 1/4	108	27 7/8	<b>GS4PLWFP108-</b> [ ]	N/A	4,086	4,495	4,904

**PRODUCT INFO**

**Unit must be wall mounted.**

Non-handed

 All units shipped as separate packages and require field assembly.

NOTE: Monitor arms should **ALWAYS** be installed in grommets on Silea height adjustable units. Please ensure a grommet location is specified on the top. This allows for bolt mount or clamp mount install of monitor arm. See page 35 for details.

**TO ORDER PLEASE SPECIFY THE FOLLOWING:**

WOOD CHASSIS

1. **MODEL NUMBER + W**
2. **FSC**
3. **CHASSIS WOOD FINISH**

LAM CHASSIS

1. **MODEL NUMBER + L**
2. **FSC**
3. **CHASSIS LAM**

# L SHAPE HEIGHT ADJUSTABLE

Workwall, Left Hand Pedestal

Silea

02/24

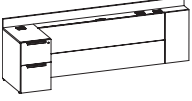
	D	W	H	model number + type	laminate	veneer 1	veneer 2	veneer 3
<b>24" DEPTH PEDESTAL</b> 	24	72	27 7/8	<b>GS4PLWFP2472L-A</b> [ ]	3,351	5,356	5,892	6,428
	24	78	27 7/8	<b>GS4PLWFP2478L-A</b> [ ]	3,414	5,475	6,023	6,570
	24	84	27 7/8	<b>GS4PLWFP2484L-A</b> [ ]	3,490	5,613	6,175	6,736
	24	90	27 7/8	<b>GS4PLWFP2490L-A</b> [ ]	3,665	6,068	6,675	7,282
	24	96	27 7/8	<b>GS4PLWFP2496L-A</b> [ ]	3,696	6,058	6,664	7,270
	24	102	27 7/8	<b>GS4PLWFP24102L-A</b> [ ]	N/A	6,175	6,793	7,410
	24	108	27 7/8	<b>GS4PLWFP24108L-A</b> [ ]	N/A	6,306	6,937	7,568
<b>30" DEPTH PEDESTAL</b>	30	72	27 7/8	<b>GS4PLWFP3072L-A</b> [ ]	3,434	5,480	6,028	6,576
	30	78	27 7/8	<b>GS4PLWFP3078L-A</b> [ ]	3,497	5,599	6,159	6,719
	30	84	27 7/8	<b>GS4PLWFP3084L-A</b> [ ]	3,573	5,737	6,311	6,885
	30	90	27 7/8	<b>GS4PLWFP3090L-A</b> [ ]	3,748	6,192	6,812	7,431
	30	96	27 7/8	<b>GS4PLWFP3096L-A</b> [ ]	3,779	6,182	6,801	7,419
	30	102	27 7/8	<b>GS4PLWFP30102L-A</b> [ ]	N/A	6,299	6,929	7,559
	30	108	27 7/8	<b>GS4PLWFP30108L-A</b> [ ]	N/A	6,430	7,073	7,716

## PRODUCT INFO

**Unit must be wall mounted.**

 All units shipped as separate packages and require field assembly.

## TO ORDER PLEASE SPECIFY THE FOLLOWING:

### WOOD CHASSIS

1. **MODEL NUMBER + W**
2. **FSC**
3. **CHASSIS WOOD FINISH**
4. **PULL**
5. **KEYING**

### LAM CHASSIS

1. **MODEL NUMBER + L**
2. **FSC**
3. **CHASSIS LAM**
4. **FRONT LAM**
5. **PULL**
6. **KEYING**

# L SHAPE HEIGHT ADJUSTABLE

Workwall, Right Hand Pedestal

	D	W	H	model number + type	laminate	veneer 1	veneer 2	veneer 3
<b>24" DEPTH PEDESTAL</b> 	24	72	27 7/8	<b>GS4PLWFP2472R-A</b> [ ]	3,351	5,356	5,892	6,428
	24	78	27 7/8	<b>GS4PLWFP2478R-A</b> [ ]	3,414	5,475	6,023	6,570
	24	84	27 7/8	<b>GS4PLWFP2484R-A</b> [ ]	3,490	5,613	6,175	6,736
	24	90	27 7/8	<b>GS4PLWFP2490R-A</b> [ ]	3,665	6,068	6,675	7,282
	24	96	27 7/8	<b>GS4PLWFP2496R-A</b> [ ]	3,696	6,058	6,664	7,270
	24	102	27 7/8	<b>GS4PLWFP24102R-A</b> [ ]	N/A	6,175	6,793	7,410
	24	108	27 7/8	<b>GS4PLWFP24108R-A</b> [ ]	N/A	6,306	6,937	7,568
<b>30" DEPTH PEDESTAL</b>	30	72	27 7/8	<b>GS4PLWFP3072R-A</b> [ ]	3,434	5,480	6,028	6,576
	30	78	27 7/8	<b>GS4PLWFP3078R-A</b> [ ]	3,497	5,599	6,159	6,719
	30	84	27 7/8	<b>GS4PLWFP3084R-A</b> [ ]	3,573	5,737	6,311	6,885
	30	90	27 7/8	<b>GS4PLWFP3090R-A</b> [ ]	3,748	6,192	6,812	7,431
	30	96	27 7/8	<b>GS4PLWFP3096R-A</b> [ ]	3,779	6,182	6,801	7,419
	30	102	27 7/8	<b>GS4PLWFP30102R-A</b> [ ]	N/A	6,299	6,929	7,559
	30	108	27 7/8	<b>GS4PLWFP30108R-A</b> [ ]	N/A	6,430	7,073	7,716

## PRODUCT INFO

**Unit must be wall mounted.**

 All units shipped as separate packages and require field assembly.

## TO ORDER PLEASE SPECIFY THE FOLLOWING:

### WOOD CHASSIS

1. **MODEL NUMBER + W**
2. **FSC**
3. **CHASSIS WOOD FINISH**
4. **PULL**
5. **KEYING**

### LAM CHASSIS

1. **MODEL NUMBER + L**
2. **FSC**
3. **CHASSIS LAM**
4. **FRONT LAM**
5. **PULL**
6. **KEYING**

# L SHAPE HEIGHT ADJUSTABLE

Desk Full Modesty, Left Hand Shroud

Silea

02/24

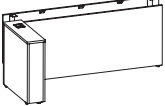
	D	W	H	model number + type	laminate	veneer 1	veneer 2	veneer 3
<b>30" DEPTH SHROUD</b> 	30	66	27 7/8	<b>GS4PLDMF3066L-</b> <input type="checkbox"/>	2,034	3,232	3,556	3,879
	30	72	27 7/8	<b>GS4PLDMF3072L-</b> <input type="checkbox"/>	2,103	3,363	3,700	4,036
	30	78	27 7/8	<b>GS4PLDMF3078L-</b> <input type="checkbox"/>	2,171	3,489	3,838	4,187
	30	84	27 7/8	<b>GS4PLDMF3084L-</b> <input type="checkbox"/>	2,315	3,692	4,062	4,431
	30	90	27 7/8	<b>GS4PLDMF3090L-</b> <input type="checkbox"/>	2,386	3,821	4,204	4,586
	30	96	27 7/8	<b>GS4PLDMF3096L-</b> <input type="checkbox"/>	2,455	3,951	4,347	4,742
<b>36" DEPTH SHROUD</b>	36	66	27 7/8	<b>GS4PLDMF3666L-</b> <input type="checkbox"/>	2,150	3,394	3,734	4,073
	36	72	27 7/8	<b>GS4PLDMF3672L-</b> <input type="checkbox"/>	2,219	3,525	3,878	4,230
	36	78	27 7/8	<b>GS4PLDMF3678L-</b> <input type="checkbox"/>	2,287	3,651	4,017	4,382
	36	84	27 7/8	<b>GS4PLDMF3684L-</b> <input type="checkbox"/>	2,431	3,854	4,240	4,625
	36	90	27 7/8	<b>GS4PLDMF3690L-</b> <input type="checkbox"/>	2,502	3,983	4,382	4,780
	36	96	27 7/8	<b>GS4PLDMF3696L-</b> <input type="checkbox"/>	2,571	4,113	4,525	4,936

## PRODUCT INFO

 All units shipped as separate packages and require field assembly.

## TO ORDER PLEASE SPECIFY THE FOLLOWING:

### WOOD CHASSIS

1. **MODEL NUMBER + W**
2. **FSC**
3. **CHASSIS WOOD FINISH**

### LAM CHASSIS

1. **MODEL NUMBER + L**
2. **FSC**
3. **CHASSIS LAM**

# L SHAPE HEIGHT ADJUSTABLE

Desk Full Modesty, Right Hand Shroud

	D	W	H	model number + type	laminate	veneer 1	veneer 2	veneer 3
<b>30" DEPTH SHROUD</b> 	30	66	27 7/8	<b>GS4PLDMF3066R-</b> <input type="checkbox"/>	2,034	3,232	3,556	3,879
	30	72	27 7/8	<b>GS4PLDMF3072R-</b> <input type="checkbox"/>	2,103	3,363	3,700	4,036
	30	78	27 7/8	<b>GS4PLDMF3078R-</b> <input type="checkbox"/>	2,171	3,489	3,838	4,187
	30	84	27 7/8	<b>GS4PLDMF3084R-</b> <input type="checkbox"/>	2,315	3,692	4,062	4,431
	30	90	27 7/8	<b>GS4PLDMF3090R-</b> <input type="checkbox"/>	2,386	3,821	4,204	4,586
	30	96	27 7/8	<b>GS4PLDMF3096R-</b> <input type="checkbox"/>	2,455	3,951	4,347	4,742
<b>36" DEPTH SHROUD</b>	36	66	27 7/8	<b>GS4PLDMF3666R-</b> <input type="checkbox"/>	2,150	3,394	3,734	4,073
	36	72	27 7/8	<b>GS4PLDMF3672R-</b> <input type="checkbox"/>	2,219	3,525	3,878	4,230
	36	78	27 7/8	<b>GS4PLDMF3678R-</b> <input type="checkbox"/>	2,287	3,651	4,017	4,382
	36	84	27 7/8	<b>GS4PLDMF3684R-</b> <input type="checkbox"/>	2,431	3,854	4,240	4,625
	36	90	27 7/8	<b>GS4PLDMF3690R-</b> <input type="checkbox"/>	2,502	3,983	4,382	4,780
	36	96	27 7/8	<b>GS4PLDMF3696R-</b> <input type="checkbox"/>	2,571	4,113	4,525	4,936

**PRODUCT INFO**

 All units shipped as separate packages and require field assembly.

**TO ORDER PLEASE SPECIFY THE FOLLOWING:**

WOOD CHASSIS

1. **MODEL NUMBER + W**
2. **FSC**
3. **CHASSIS WOOD FINISH**

LAM CHASSIS

1. **MODEL NUMBER + L**
2. **FSC**
3. **CHASSIS LAM**

# L SHAPE HEIGHT ADJUSTABLE

Desk Full Modesty, Left Hand Pedestal

Silea

02/24

	D	W	H	model number + type	laminate	veneer 1	veneer 2	veneer 3
<b>30" DEPTH PEDESTAL</b>	30	66	27 7/8	<b>GS4PLDMF3066L-A</b> <input type="checkbox"/>	2,616	4,239	4,663	5,087
	30	72	27 7/8	<b>GS4PLDMF3072L-A</b> <input type="checkbox"/>	2,685	4,370	4,807	5,244
	30	78	27 7/8	<b>GS4PLDMF3078L-A</b> <input type="checkbox"/>	2,753	4,496	4,946	5,396
	30	84	27 7/8	<b>GS4PLDMF3084L-A</b> <input type="checkbox"/>	2,897	4,699	5,169	5,639
	30	90	27 7/8	<b>GS4PLDMF3090L-A</b> <input type="checkbox"/>	2,968	4,828	5,311	5,794
	30	96	27 7/8	<b>GS4PLDMF3096L-A</b> <input type="checkbox"/>	3,037	4,958	5,454	5,950
<b>36" DEPTH PEDESTAL</b>	36	66	27 7/8	<b>GS4PLDMF3666L-A</b> <input type="checkbox"/>	2,703	4,371	4,809	5,246
	36	72	27 7/8	<b>GS4PLDMF3672L-A</b> <input type="checkbox"/>	2,772	4,502	4,953	5,403
	36	78	27 7/8	<b>GS4PLDMF3678L-A</b> <input type="checkbox"/>	2,840	4,628	5,091	5,554
	36	84	27 7/8	<b>GS4PLDMF3684L-A</b> <input type="checkbox"/>	2,984	4,831	5,315	5,798
	36	90	27 7/8	<b>GS4PLDMF3690L-A</b> <input type="checkbox"/>	3,055	4,960	5,456	5,952
	36	96	27 7/8	<b>GS4PLDMF3696L-A</b> <input type="checkbox"/>	3,124	5,090	5,599	6,108

## 30" DEPTH PEDESTAL

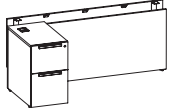

## PRODUCT INFO

 All units shipped as separate packages and require field assembly.

## TO ORDER PLEASE SPECIFY THE FOLLOWING:

### WOOD CHASSIS

1. **MODEL NUMBER + W**
2. **FSC**
3. **CHASSIS WOOD FINISH**
4. **PULL**
5. **KEYING**

### LAM CHASSIS

1. **MODEL NUMBER + L**
2. **FSC**
3. **CHASSIS LAM**
4. **FRONT LAM**
5. **PULL**
6. **KEYING**

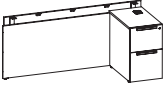
	D	W	H	model number + type	laminata	veneer 1	veneer 2	veneer 3
<b>30" DEPTH PEDESTAL</b> 	30	66	27 7/8	<b>GS4PLDMF3066R-A</b> <input type="checkbox"/>	2,616	4,239	4,663	5,087
	30	72	27 7/8	<b>GS4PLDMF3072R-A</b> <input type="checkbox"/>	2,685	4,370	4,807	5,244
	30	78	27 7/8	<b>GS4PLDMF3078R-A</b> <input type="checkbox"/>	2,753	4,496	4,946	5,396
	30	84	27 7/8	<b>GS4PLDMF3084R-A</b> <input type="checkbox"/>	2,897	4,699	5,169	5,639
	30	90	27 7/8	<b>GS4PLDMF3090R-A</b> <input type="checkbox"/>	2,968	4,828	5,311	5,794
	30	96	27 7/8	<b>GS4PLDMF3096R-A</b> <input type="checkbox"/>	3,037	4,958	5,454	5,950
<b>36" DEPTH PEDESTAL</b>	36	66	27 7/8	<b>GS4PLDMF3666R-A</b> <input type="checkbox"/>	2,703	4,371	4,809	5,246
	36	72	27 7/8	<b>GS4PLDMF3672R-A</b> <input type="checkbox"/>	2,772	4,502	4,953	5,403
	36	78	27 7/8	<b>GS4PLDMF3678R-A</b> <input type="checkbox"/>	2,840	4,628	5,091	5,554
	36	84	27 7/8	<b>GS4PLDMF3684R-A</b> <input type="checkbox"/>	2,984	4,831	5,315	5,798
	36	90	27 7/8	<b>GS4PLDMF3690R-A</b> <input type="checkbox"/>	3,055	4,960	5,456	5,952
	36	96	27 7/8	<b>GS4PLDMF3696R-A</b> <input type="checkbox"/>	3,124	5,090	5,599	6,108

**PRODUCT INFO**

 All units shipped as separate packages and require field assembly.

**TO ORDER PLEASE SPECIFY THE FOLLOWING:**

WOOD CHASSIS

1. **MODEL NUMBER + W**
2. **FSC**
3. **CHASSIS WOOD FINISH**
4. **PULL**
5. **KEYING**

LAM CHASSIS

1. **MODEL NUMBER + L**
2. **FSC**
3. **CHASSIS LAM**
4. **FRONT LAM**
5. **PULL**
6. **KEYING**

# L SHAPE HEIGHT ADJUSTABLE

Desk Half Modesty, Left Hand Shroud

Silea

02/24

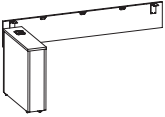
	D	W	H	model number + type	laminate	veneer 1	veneer 2	veneer 3
<b>30" DEPTH SHROUD</b> 	30	66	27 7/8	<b>GS4PLDMH3066L-</b> <input type="checkbox"/>	2,148	2,744	3,019	3,293
	30	72	27 7/8	<b>GS4PLDMH3072L-</b> <input type="checkbox"/>	2,205	2,816	3,098	3,380
	30	78	27 7/8	<b>GS4PLDMH3078L-</b> <input type="checkbox"/>	2,239	2,860	3,146	3,432
	30	84	27 7/8	<b>GS4PLDMH3084L-</b> <input type="checkbox"/>	2,348	2,980	3,278	3,576
	30	90	27 7/8	<b>GS4PLDMH3090L-</b> <input type="checkbox"/>	2,385	3,028	3,331	3,634
	30	96	27 7/8	<b>GS4PLDMH3096L-</b> <input type="checkbox"/>	2,426	3,079	3,387	3,695
<b>36" DEPTH SHROUD</b>	36	66	27 7/8	<b>GS4PLDMH3666L-</b> <input type="checkbox"/>	2,264	2,906	3,197	3,488
	36	72	27 7/8	<b>GS4PLDMH3672L-</b> <input type="checkbox"/>	2,321	2,978	3,276	3,574
	36	78	27 7/8	<b>GS4PLDMH3678L-</b> <input type="checkbox"/>	2,355	3,022	3,325	3,627
	36	84	27 7/8	<b>GS4PLDMH3684L-</b> <input type="checkbox"/>	2,464	3,142	3,457	3,771
	36	90	27 7/8	<b>GS4PLDMH3690L-</b> <input type="checkbox"/>	2,501	3,190	3,509	3,828
	36	96	27 7/8	<b>GS4PLDMH3696L-</b> <input type="checkbox"/>	2,542	3,241	3,566	3,890

## PRODUCT INFO

 All units shipped as separate packages and require field assembly.

## TO ORDER PLEASE SPECIFY THE FOLLOWING:

### WOOD CHASSIS

1. **MODEL NUMBER + W**
2. **FSC**
3. **CHASSIS WOOD FINISH**

### LAM CHASSIS

1. **MODEL NUMBER + L**
2. **FSC**
3. **CHASSIS LAM**



# L SHAPE HEIGHT ADJUSTABLE

Desk Half Modesty, Right Hand Shroud

	D	W	H	model number + type	laminate	veneer 1	veneer 2	veneer 3
<b>30" DEPTH SHROUD</b> 	30	66	27 7/8	<b>GS4PLDMH3066R-</b> <input type="checkbox"/>	2,148	2,744	3,019	3,293
	30	72	27 7/8	<b>GS4PLDMH3072R-</b> <input type="checkbox"/>	2,205	2,816	3,098	3,380
	30	78	27 7/8	<b>GS4PLDMH3078R-</b> <input type="checkbox"/>	2,239	2,860	3,146	3,432
	30	84	27 7/8	<b>GS4PLDMH3084R-</b> <input type="checkbox"/>	2,348	2,980	3,278	3,576
	30	90	27 7/8	<b>GS4PLDMH3090R-</b> <input type="checkbox"/>	2,385	3,028	3,331	3,634
	30	96	27 7/8	<b>GS4PLDMH3096R-</b> <input type="checkbox"/>	2,426	3,079	3,387	3,695
<b>36" DEPTH SHROUD</b>	36	66	27 7/8	<b>GS4PLDMH3666R-</b> <input type="checkbox"/>	2,264	2,906	3,197	3,488
	36	72	27 7/8	<b>GS4PLDMH3672R-</b> <input type="checkbox"/>	2,321	2,978	3,276	3,574
	36	78	27 7/8	<b>GS4PLDMH3678R-</b> <input type="checkbox"/>	2,355	3,022	3,325	3,627
	36	84	27 7/8	<b>GS4PLDMH3684R-</b> <input type="checkbox"/>	2,464	3,142	3,457	3,771
	36	90	27 7/8	<b>GS4PLDMH3690R-</b> <input type="checkbox"/>	2,501	3,190	3,509	3,828
	36	96	27 7/8	<b>GS4PLDMH3696R-</b> <input type="checkbox"/>	2,542	3,241	3,566	3,890

**PRODUCT INFO**

 All units shipped as separate packages and require field assembly.

**TO ORDER PLEASE SPECIFY THE FOLLOWING:**

WOOD CHASSIS

1. **MODEL NUMBER + W**
2. **FSC**
3. **CHASSIS WOOD FINISH**

LAM CHASSIS

1. **MODEL NUMBER + L**
2. **FSC**
3. **CHASSIS LAM**

# L SHAPE HEIGHT ADJUSTABLE

Desk Half Modesty, Left Hand Pedestal

Silea

02/24

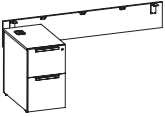
	D	W	H	model number + type	laminate	veneer 1	veneer 2	veneer 3
<b>30" DEPTH PEDESTAL</b> 	30	66	27 7/8	<b>GS4PLDMH3066L-A</b> <input type="checkbox"/>	2,742	3,913	4,305	4,696
	30	72	27 7/8	<b>GS4PLDMH3072L-A</b> <input type="checkbox"/>	2,799	3,985	4,384	4,782
	30	78	27 7/8	<b>GS4PLDMH3078L-A</b> <input type="checkbox"/>	2,833	4,029	4,432	4,835
	30	84	27 7/8	<b>GS4PLDMH3084L-A</b> <input type="checkbox"/>	2,942	4,149	4,564	4,979
	30	90	27 7/8	<b>GS4PLDMH3090L-A</b> <input type="checkbox"/>	2,979	4,197	4,617	5,037
	30	96	27 7/8	<b>GS4PLDMH3096L-A</b> <input type="checkbox"/>	3,020	4,248	4,673	5,098
<b>36" DEPTH PEDESTAL</b>	36	66	27 7/8	<b>GS4PLDMH3666L-A</b> <input type="checkbox"/>	2,829	4,045	4,450	4,854
	36	72	27 7/8	<b>GS4PLDMH3672L-A</b> <input type="checkbox"/>	2,886	4,117	4,529	4,941
	36	78	27 7/8	<b>GS4PLDMH3678L-A</b> <input type="checkbox"/>	2,920	4,161	4,578	4,994
	36	84	27 7/8	<b>GS4PLDMH3684L-A</b> <input type="checkbox"/>	3,029	4,281	4,710	5,138
	36	90	27 7/8	<b>GS4PLDMH3690L-A</b> <input type="checkbox"/>	3,066	4,329	4,762	5,195
	36	96	27 7/8	<b>GS4PLDMH3696L-A</b> <input type="checkbox"/>	3,107	4,380	4,818	5,256

## PRODUCT INFO

 All units shipped as separate packages and require field assembly.

## TO ORDER PLEASE SPECIFY THE FOLLOWING:

### WOOD CHASSIS

1. **MODEL NUMBER + W**
2. **FSC**
3. **CHASSIS WOOD FINISH**
4. **PULL**
5. **KEYING**

### LAM CHASSIS

1. **MODEL NUMBER + L**
2. **FSC**
3. **CHASSIS LAM**
4. **FRONT LAM**
5. **PULL**
6. **KEYING**

# L SHAPE HEIGHT ADJUSTABLE

Desk Half Modesty, Right Hand Pedestal

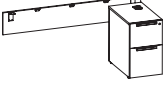
	D	W	H	model number + type	laminate	veneer 1	veneer 2	veneer 3
<b>30" DEPTH PEDESTAL</b> 	30	66	27 7/8	<b>GS4PLDMH3066R-A</b> <input type="checkbox"/>	2,742	3,913	4,305	4,696
	30	72	27 7/8	<b>GS4PLDMH3072R-A</b> <input type="checkbox"/>	2,799	3,985	4,384	4,782
	30	78	27 7/8	<b>GS4PLDMH3078R-A</b> <input type="checkbox"/>	2,833	4,029	4,432	4,835
	30	84	27 7/8	<b>GS4PLDMH3084R-A</b> <input type="checkbox"/>	2,942	4,149	4,564	4,979
	30	90	27 7/8	<b>GS4PLDMH3090R-A</b> <input type="checkbox"/>	2,979	4,197	4,617	5,037
	30	96	27 7/8	<b>GS4PLDMH3096R-A</b> <input type="checkbox"/>	3,020	4,248	4,673	5,098
<b>36" DEPTH PEDESTAL</b>	36	66	27 7/8	<b>GS4PLDMH3666R-A</b> <input type="checkbox"/>	2,829	4,045	4,450	4,854
	36	72	27 7/8	<b>GS4PLDMH3672R-A</b> <input type="checkbox"/>	2,886	4,117	4,529	4,941
	36	78	27 7/8	<b>GS4PLDMH3678R-A</b> <input type="checkbox"/>	2,920	4,161	4,578	4,994
	36	84	27 7/8	<b>GS4PLDMH3684R-A</b> <input type="checkbox"/>	3,029	4,281	4,710	5,138
	36	90	27 7/8	<b>GS4PLDMH3690R-A</b> <input type="checkbox"/>	3,066	4,329	4,762	5,195
	36	96	27 7/8	<b>GS4PLDMH3696R-A</b> <input type="checkbox"/>	3,107	4,380	4,818	5,256

**PRODUCT INFO**

 All units shipped as separate packages and require field assembly.

**TO ORDER PLEASE SPECIFY THE FOLLOWING:**

WOOD CHASSIS

1. **MODEL NUMBER + W**
2. **FSC**
3. **CHASSIS WOOD FINISH**
4. **PULL**
5. **KEYING**

LAM CHASSIS

1. **MODEL NUMBER + L**
2. **FSC**
3. **CHASSIS LAM**
4. **FRONT LAM**
5. **PULL**
6. **KEYING**

# L SHAPE HEIGHT ADJUSTABLE

## 30D & 36D Desk Worksurfaces Rectangular

Silea  
02/24

	D	W	H	model number + type	laminate	veneer 1	veneer 2	veneer 3
	30	66	1 3/16	<b>GS4LADWR3066-</b> <input type="checkbox"/>	1,068	1,454	1,600	1,745
	30	72	1 3/16	<b>GS4LADWR3072-</b> <input type="checkbox"/>	1,124	1,530	1,683	1,836
	30	78	1 3/16	<b>GS4LADWR3078-</b> <input type="checkbox"/>	1,201	1,638	1,802	1,966
	30	84	1 3/16	<b>GS4LADWR3084-</b> <input type="checkbox"/>	1,286	1,754	1,930	2,105
	30	90	1 3/16	<b>GS4LADWR3090-</b> <input type="checkbox"/>	1,370	1,842	2,027	2,211
	30	96	1 3/16	<b>GS4LADWR3096-</b> <input type="checkbox"/>	1,438	1,934	2,128	2,321
	36	66	1 3/16	<b>GS4LADWR3666-</b> <input type="checkbox"/>	1,143	1,558	1,714	1,870
	36	72	1 3/16	<b>GS4LADWR3672-</b> <input type="checkbox"/>	1,204	1,641	1,806	1,970
	36	78	1 3/16	<b>GS4LADWR3678-</b> <input type="checkbox"/>	1,289	1,756	1,932	2,108
	36	84	1 3/16	<b>GS4LADWR3684-</b> <input type="checkbox"/>	1,379	1,881	2,070	2,258
	36	90	1 3/16	<b>GS4LADWR3690-</b> <input type="checkbox"/>	1,468	1,974	2,172	2,369
	36	96	1 3/16	<b>GS4LADWR3696-</b> <input type="checkbox"/>	1,542	2,073	2,281	2,488

- Flat brackets ordered separately (model #MDWBRK)

### PRODUCT INFO

All tops long grain standard.  
Tops are undersized to allow for pinch points.

#### Grommet Location (Add \$80 per grommet)

No Grommet **GN**  
Left **GL**  
Right **GR**  
Left & Right **GB**

Specify location first, then select grommet color or "Empty Cutout" option. When "Empty Cutout" option is selected, a grommet or power unit must be ordered separately for each cutout.

### TO ORDER PLEASE SPECIFY THE FOLLOWING:

#### WOOD TOP

1. **MODEL NUMBER + W**
2. **FSC**
3. **TOP WOOD FINISH + EDGE**
4. **TOP FINISH**
5. **GROMMET**

#### LAM TOP

1. **MODEL NUMBER + L**
2. **FSC**
3. **TOP LAM**
4. **EDGE DETAIL**
5. **GROMMET**

# L SHAPE HEIGHT ADJUSTABLE

## 24D & 30D Return Worksurfaces Rectangular

	D	W	H	model number + type	laminate	veneer 1	veneer 2	veneer 3
	24	42	1 3/16	<b>GS4LACWR2442-</b> <input type="checkbox"/>	741	1,008	1,109	1,210
	24	48	1 3/16	<b>GS4LACWR2448-</b> <input type="checkbox"/>	809	1,103	1,214	1,324
	24	54	1 3/16	<b>GS4LACWR2454-</b> <input type="checkbox"/>	853	1,161	1,278	1,394
	24	60	1 3/16	<b>GS4LACWR2460-</b> <input type="checkbox"/>	926	1,262	1,389	1,515
	24	66	1 3/16	<b>GS4LACWR2466-</b> <input type="checkbox"/>	985	1,340	1,474	1,608
	24	72	1 3/16	<b>GS4LACWR2472-</b> <input type="checkbox"/>	1,098	1,499	1,649	1,799
	30	42	1 3/16	<b>GS4LACWR3042-</b> <input type="checkbox"/>	945	1,289	1,418	1,547
	30	48	1 3/16	<b>GS4LACWR3048-</b> <input type="checkbox"/>	995	1,356	1,492	1,628
	30	54	1 3/16	<b>GS4LACWR3054-</b> <input type="checkbox"/>	1,007	1,374	1,512	1,649
	30	60	1 3/16	<b>GS4LACWR3060-</b> <input type="checkbox"/>	1,020	1,389	1,528	1,667
	30	66	1 3/16	<b>GS4LACWR3066-</b> <input type="checkbox"/>	1,068	1,454	1,600	1,745
	30	72	1 3/16	<b>GS4LACWR3072-</b> <input type="checkbox"/>	1,124	1,530	1,683	1,836

• Flat brackets ordered separately (model #MDWBRK)

### PRODUCT INFO

Wood tops are short grain standard. Lam tops are short grain up to 60", over 60" are long grain standard.

Tops are undersized to allow for pinch points.

**Grommet Location**  
(Add \$80 per grommet)

No Grommet **GN**  
Center **GC**

Specify location first, then select grommet color or "Empty Cutout" option. When "Empty Cutout" option is selected, a grommet or power unit must be ordered separately for each cutout.

### TO ORDER PLEASE SPECIFY THE FOLLOWING:

#### WOOD TOP

- MODEL NUMBER + W**
- FSC**
- TOP WOOD FINISH + EDGE**
- TOP FINISH**
- GROMMET**

#### LAM TOP

- MODEL NUMBER + L**
- FSC**
- TOP LAM**
- EDGE DETAIL**
- GROMMET**

# L SHAPE HEIGHT ADJUSTABLE

Cockpit Top Shape, For Left Hand Desk

Silea  
02/24

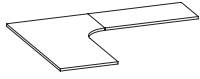

Desk Depth	Desk Width	Return Depth	Return Width	Total Workwall Width	model number + type	laminates	veneer 1	veneer 2	veneer 3
30	72	24	42	72	GS4LATOP30722442L- [ ]	2,051	2,791	3,071	3,350
30	72	24	48	78	GS4LATOP30722448L- [ ]	2,126	2,894	3,184	3,473
30	72	24	54	84	GS4LATOP30722454L- [ ]	2,173	2,961	3,258	3,554
30	72	24	60	90	GS4LATOP30722460L- [ ]	2,257	3,071	3,379	3,686
30	72	24	66	96	GS4LATOP30722466L- [ ]	2,320	3,157	3,473	3,789
30	72	24	72	102	GS4LATOP30722472L- [ ]	N/A	3,331	3,665	3,998
30	84	24	42	72	GS4LATOP30842442L- [ ]	2,230	3,037	3,341	3,645
30	84	24	48	78	GS4LATOP30842448L- [ ]	2,305	3,141	3,456	3,770
30	84	24	54	84	GS4LATOP30842454L- [ ]	2,352	3,205	3,526	3,846
30	84	24	60	90	GS4LATOP30842460L- [ ]	2,433	3,317	3,649	3,981
30	84	24	66	96	GS4LATOP30842466L- [ ]	2,496	3,402	3,743	4,083
30	84	24	72	102	GS4LATOP30842472L- [ ]	N/A	3,579	3,937	4,295
36	72	24	42	78	GS4LATOP36722442L- [ ]	2,051	2,916	3,208	3,500
36	72	24	48	84	GS4LATOP36722448L- [ ]	2,126	3,018	3,320	3,622
36	72	24	54	90	GS4LATOP36722454L- [ ]	2,173	3,084	3,393	3,701
36	72	24	60	96	GS4LATOP36722460L- [ ]	2,257	3,195	3,515	3,834
36	72	24	66	102	GS4LATOP36722466L- [ ]	N/A	3,280	3,608	3,936
36	72	24	72	108	GS4LATOP36722472L- [ ]	N/A	3,456	3,802	4,148
36	84	24	42	78	GS4LATOP36842442L- [ ]	2,230	3,176	3,494	3,812
36	84	24	48	84	GS4LATOP36842448L- [ ]	2,305	3,279	3,607	3,935
36	84	24	54	90	GS4LATOP36842454L- [ ]	2,352	3,344	3,679	4,013
36	84	24	60	96	GS4LATOP36842460L- [ ]	2,433	3,456	3,802	4,148
36	84	24	66	102	GS4LATOP36842466L- [ ]	N/A	3,542	3,897	4,251
36	84	24	72	108	GS4LATOP36842472L- [ ]	N/A	3,716	4,088	4,460

## PRODUCT INFO

Desk top portion is long grain standard, return short grain.

Tops are undersized to allow for pinch points.

### Grommet Location (Add \$80 per grommet)

No Grommet **GN**  
Left **GL**  
Right **GR**  
Left & Right **GB**

Specify location first, then select grommet color or "Empty Cutout" option. When "Empty Cutout" option is selected, a grommet or power unit must be ordered separately for each cutout.

NOTE: Monitor arms should **ALWAYS** be installed in grommets on Silea height adjustable units. Please ensure a grommet location is specified on the top. This allows for bolt mount or clamp mount install of monitor arm. See page 35 for details.

## TO ORDER PLEASE SPECIFY THE FOLLOWING:

### WOOD TOP

1. **MODEL NUMBER + W**
2. **FSC**
3. **TOP WOOD FINISH + EDGE**
4. **TOP FINISH**
5. **DESK GROMMET**

### LAM TOP

1. **MODEL NUMBER + L**
2. **FSC**
3. **TOP LAM**
4. **EDGE DETAIL**
5. **DESK GROMMET**

# L SHAPE HEIGHT ADJUSTABLE

Cockpit Top Shape, For Right Hand Desk

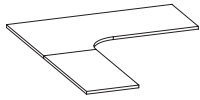

Desk Depth	Desk Width	Return Depth	Return Width	Total Workwall Width	model number + type	laminiate	veneer 1	veneer 2	veneer 3
30	72	24	42	72	<b>GS4LATOP30722442R-</b> <input type="checkbox"/>	2,051	2,791	3,071	3,350
30	72	24	48	78	<b>GS4LATOP30722448R-</b> <input type="checkbox"/>	2,126	2,894	3,184	3,473
30	72	24	54	84	<b>GS4LATOP30722454R-</b> <input type="checkbox"/>	2,173	2,961	3,258	3,554
30	72	24	60	90	<b>GS4LATOP30722460R-</b> <input type="checkbox"/>	2,257	3,071	3,379	3,686
30	72	24	66	96	<b>GS4LATOP30722466R-</b> <input type="checkbox"/>	2,320	3,157	3,473	3,789
30	72	24	72	102	<b>GS4LATOP30722472R-</b> <input type="checkbox"/>	N/A	3,331	3,665	3,998
30	84	24	42	72	<b>GS4LATOP30842442R-</b> <input type="checkbox"/>	2,230	3,037	3,341	3,645
30	84	24	48	78	<b>GS4LATOP30842448R-</b> <input type="checkbox"/>	2,305	3,141	3,456	3,770
30	84	24	54	84	<b>GS4LATOP30842454R-</b> <input type="checkbox"/>	2,352	3,205	3,526	3,846
30	84	24	60	90	<b>GS4LATOP30842460R-</b> <input type="checkbox"/>	2,433	3,317	3,649	3,981
30	84	24	66	96	<b>GS4LATOP30842466R-</b> <input type="checkbox"/>	2,496	3,402	3,743	4,083
30	84	24	72	102	<b>GS4LATOP30842472R-</b> <input type="checkbox"/>	N/A	3,579	3,937	4,295
36	72	24	42	78	<b>GS4LATOP36722442R-</b> <input type="checkbox"/>	2,051	2,916	3,208	3,500
36	72	24	48	84	<b>GS4LATOP36722448R-</b> <input type="checkbox"/>	2,126	3,018	3,320	3,622
36	72	24	54	90	<b>GS4LATOP36722454R-</b> <input type="checkbox"/>	2,173	3,084	3,393	3,701
36	72	24	60	96	<b>GS4LATOP36722460R-</b> <input type="checkbox"/>	2,257	3,195	3,515	3,834
36	72	24	66	102	<b>GS4LATOP36722466R-</b> <input type="checkbox"/>	N/A	3,280	3,608	3,936
36	72	24	72	108	<b>GS4LATOP36722472R-</b> <input type="checkbox"/>	N/A	3,456	3,802	4,148
36	84	24	42	78	<b>GS4LATOP36842442R-</b> <input type="checkbox"/>	2,230	3,176	3,494	3,812
36	84	24	48	84	<b>GS4LATOP36842448R-</b> <input type="checkbox"/>	2,305	3,279	3,607	3,935
36	84	24	54	90	<b>GS4LATOP36842454R-</b> <input type="checkbox"/>	2,352	3,344	3,679	4,013
36	84	24	60	96	<b>GS4LATOP36842460R-</b> <input type="checkbox"/>	2,433	3,456	3,802	4,148
36	84	24	66	102	<b>GS4LATOP36842466R-</b> <input type="checkbox"/>	N/A	3,542	3,897	4,251
36	84	24	72	108	<b>GS4LATOP36842472R-</b> <input type="checkbox"/>	N/A	3,716	4,088	4,460

## PRODUCT INFO

Desk top portion is long grain standard, return short grain.

Tops are undersized to allow for pinch points.

### Grommet Location

(Add \$80 per grommet)

No Grommet **GN**  
 Left **GL**  
 Right **GR**  
 Left & Right **GB**

Specify location first, then select grommet color or "Empty Cutout" option. When "Empty Cutout" option is selected, a grommet or power unit must be ordered separately for each cutout.

NOTE: Monitor arms should **ALWAYS** be installed in grommets on Silea height adjustable units. Please ensure a grommet location is specified on the top. This allows for bolt mount or clamp mount install of monitor arm. See page 35 for details.

## TO ORDER PLEASE SPECIFY THE FOLLOWING:

### WOOD TOP

- MODEL NUMBER + W**
- FSC**
- TOP WOOD FINISH + EDGE**
- TOP FINISH**
- DESK GROMMET**

### LAM TOP

- MODEL NUMBER + L**
- FSC**
- TOP LAM**
- EDGE DETAIL**
- DESK GROMMET**

# L SHAPE HEIGHT ADJUSTABLE

Hardware & Bracketry Kit

Silea  
02/24

D	W	H	model number	part #
<b>3 MOTOR KIT</b>			<b>GS4LALNKDPD-3</b>	2,213
<b>4 MOTOR KIT</b>			<b>GS4LALNKDPD-4</b>	2,748

Total Workwall Width	# Motors	Model # to Order
Workwall 72"	3	GS4LALNKDPD-3
Workwall 78"	3	GS4LALNKDPD-3
Workwall 84"	3	GS4LALNKDPD-3
Workwall 90"	3	GS4LALNKDPD-3
Workwall 96"	3	GS4LALNKDPD-3
Workwall 102"	4	GS4LALNKDPD-4
Workwall 108"	4	GS4LALNKDPD-4

## PRODUCT INFO

L shape units require field assembly

NOTE: Monitor arms should **ALWAYS** be installed in grommets on Silea height adjustable units. Please ensure a grommet location is specified on the top. This allows for bolt mount or clamp mount install of monitor arm. See page 35 for details.

## TO ORDER PLEASE SPECIFY THE FOLLOWING:

LIST

- 1. MODEL NUMBER**
- 2. HAT KEYPAD & BASE COLOR**

Optional height adjustable keypads available

### HAT KEYPAD & BASE COLOR

Basic Up/Down Keypad, Black P71 Column  
Memory Preset Keypad, Black P71 Column  
Paddle Keypad, Black P71 Column

**UDP71**  
**MEMP71**  
**PDLP71**



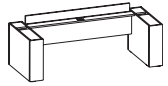

D	W	H	model number + type	laminate	veneer 1	veneer 2	veneer 3
24	42	22 1/2	GS3HASHRD2442- [ ]	2,424	3,162	3,479	3,795
24	48	22 1/2	GS3HASHRD2448- [ ]	2,455	3,202	3,523	3,843
24	54	22 1/2	GS3HASHRD2454- [ ]	2,485	3,241	3,566	3,890
24	60	22 1/2	GS3HASHRD2460- [ ]	2,515	3,279	3,607	3,935
24	66	22 1/2	GS3HASHRD2466- [ ]	2,545	3,320	3,652	3,984
24	72	22 1/2	GS3HASHRD2472- [ ]	2,575	3,358	3,694	4,030
30	42	22 1/2	GS3HASHRD3042- [ ]	2,500	3,259	3,585	3,911
30	48	22 1/2	GS3HASHRD3048- [ ]	2,531	3,298	3,628	3,958
30	54	22 1/2	GS3HASHRD3054- [ ]	2,561	3,339	3,673	4,007
30	60	22 1/2	GS3HASHRD3060- [ ]	2,591	3,379	3,717	4,055
30	66	22 1/2	GS3HASHRD3066- [ ]	2,621	3,418	3,760	4,102
30	72	22 1/2	GS3HASHRD3072- [ ]	2,651	3,458	3,804	4,150
36	42	22 1/2	GS3HASHRD3642- [ ]	2,574	3,358	3,694	4,030
36	48	22 1/2	GS3HASHRD3648- [ ]	2,605	3,398	3,738	4,078
36	54	22 1/2	GS3HASHRD3654- [ ]	2,635	3,437	3,781	4,125
36	60	22 1/2	GS3HASHRD3660- [ ]	2,665	3,477	3,825	4,173
36	66	22 1/2	GS3HASHRD3666- [ ]	2,695	3,519	3,871	4,223
36	72	22 1/2	GS3HASHRD3672- [ ]	2,725	3,556	3,912	4,268

**PRODUCT INFO**

Top and t-base ordered separately.

Wood models ship assembled.

 Laminate units shipped as separate packages and require field assembly.

NOTE: Monitor arms should **ALWAYS** be installed in grommets on Silea height adjustable units. Please ensure a grommet location is specified on the top. This allows for bolt mount or clamp mount install of monitor arm. See page 35 for details.

**TO ORDER PLEASE SPECIFY THE FOLLOWING:**

WOOD CHASSIS

- MODEL NUMBER + W**
- FSC**
- CHASSIS WOOD FINISH**

LAM CHASSIS

- MODEL NUMBER + L**
- FSC**
- CHASSIS LAM**

# LAYERS BOOKCASE

w/ top for T-Base

Silea

02/24

	D	W	H	model number + type	laminata	vener 1	vener 2	vener 3
	23 1/8	24	22 3/8	<b>GS2LHAPD2424L-</b> [ ]	1,739	2,372	2,610	2,847
	23 1/8	30	22 3/8	<b>GS2LHAPD2430L-</b> [ ]	1,859	2,536	2,790	3,044
	23 1/8	36	22 3/8	<b>GS2LHAPD2436L-</b> [ ]	1,980	2,700	2,970	3,240

	23 1/8	24	22 3/8	<b>GS2LHAPD2424R-</b> [ ]	1,739	2,372	2,610	2,847
	23 1/8	30	22 3/8	<b>GS2LHAPD2430R-</b> [ ]	1,859	2,536	2,790	3,044
	23 1/8	36	22 3/8	<b>GS2LHAPD2436R-</b> [ ]	1,980	2,700	2,970	3,240

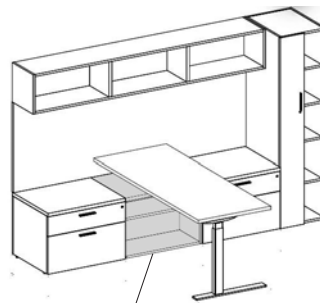

Layers Bookcase  
(right hand shown)

## PRODUCT INFO

T-base height adjustable not included.

## TO ORDER PLEASE SPECIFY THE FOLLOWING:

WOOD TOP, WOOD CHASSIS

1. **MODEL NUMBER + WW**
2. **FSC**
3. **TOP WOOD FINISH + EDGE**
4. **CHASSIS WOOD FINISH**
5. **TOP FINISH**
6. **GRAIN DIRECTION**

LAM TOP, LAM CHASSIS

1. **MODEL NUMBER + LL**
2. **FSC**
3. **TOP LAM**
4. **CHASSIS LAM**
5. **GRAIN DIRECTION**

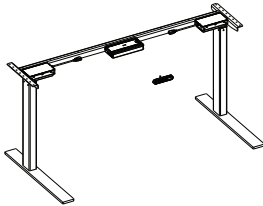
	for use with top sizes	D	W	H	model number	list
	22 x 40	21	36	26	<b>BSHAT2142</b>	3,171
	22 x 46	21	42	26	<b>BSHAT2148</b>	3,185
	22 x 52	21	48	26	<b>BSHAT2154</b>	3,204
	22 x 58	21	54	26	<b>BSHAT2160</b>	3,218
	22 x 64	21	60	26	<b>BSHAT2166</b>	3,237
	22 x 70	21	66	26	<b>BSHAT2172</b>	3,252
	28/34 x 46	27	42	26	<b>BSHAT2748</b>	3,218
	28/34 x 52	27	48	26	<b>BSHAT2754</b>	3,237
	28/34 x 58	27	54	26	<b>BSHAT2760</b>	3,252
	28/34 x 64	27	60	26	<b>BSHAT2766</b>	3,272
	28/34 x 70	27	66	26	<b>BSHAT2772</b>	3,287



Base at lowest height setting

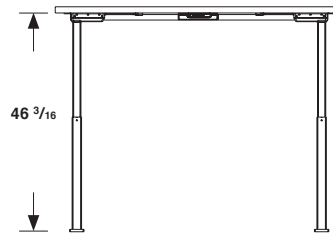

Base at tallest height setting

**PRODUCT INFO**

Tops and modesty panel ordered separately in modular tab.

**TO ORDER PLEASE SPECIFY THE FOLLOWING:**

LIST

1. **MODEL NUMBER**
2. **BASE COLOR**

# HEIGHT ADJUSTABLE TOPS

22D, 28D & 34D

Silea

02/24

	D	W	H	model number + type	laminate	veneer 1	veneer 2	veneer 3
	22	40	1 3/16	<b>GS2CWA2240-</b> <input type="checkbox"/>	741	1,008	1,109	1,210
	22	46	1 3/16	<b>GS2CWA2246-</b> <input type="checkbox"/>	809	1,103	1,214	1,324
	22	52	1 3/16	<b>GS2CWA2252-</b> <input type="checkbox"/>	853	1,161	1,278	1,394
	22	58	1 3/16	<b>GS2CWA2258-</b> <input type="checkbox"/>	926	1,262	1,389	1,515
	22	64	1 3/16	<b>GS2CWA2264-</b> <input type="checkbox"/>	985	1,340	1,474	1,608
	22	70	1 3/16	<b>GS2CWA2270-</b> <input type="checkbox"/>	1,098	1,499	1,649	1,799
	28	40	1 3/16	<b>GS2CWA2840-</b> <input type="checkbox"/>	945	1,289	1,418	1,547
	28	46	1 3/16	<b>GS2CWA2846-</b> <input type="checkbox"/>	995	1,356	1,492	1,628
	28	52	1 3/16	<b>GS2CWA2852-</b> <input type="checkbox"/>	1,007	1,374	1,512	1,649
	28	58	1 3/16	<b>GS2CWA2858-</b> <input type="checkbox"/>	1,020	1,389	1,528	1,667
	28	64	1 3/16	<b>GS2CWA2864-</b> <input type="checkbox"/>	1,068	1,454	1,600	1,745
	28	70	1 3/16	<b>GS2CWA2870-</b> <input type="checkbox"/>	1,124	1,530	1,683	1,836
	34	40	1 3/16	<b>GS2CWA3440-</b> <input type="checkbox"/>	991	1,353	1,489	1,624
	34	46	1 3/16	<b>GS2CWA3446-</b> <input type="checkbox"/>	1,045	1,425	1,568	1,710
	34	52	1 3/16	<b>GS2CWA3452-</b> <input type="checkbox"/>	1,068	1,454	1,600	1,745
	34	58	1 3/16	<b>GS2CWA3458-</b> <input type="checkbox"/>	1,089	1,483	1,632	1,780
	34	64	1 3/16	<b>GS2CWA3464-</b> <input type="checkbox"/>	1,143	1,558	1,714	1,870
	34	70	1 3/16	<b>GS2CWA3470-</b> <input type="checkbox"/>	1,204	1,641	1,806	1,970

## PRODUCT INFO

Depth & width shortened two inches for height adjustable pinch points.

Wood tops optional grain standard.

Lam tops optional grain up to 60", over 60" long grain standard.

### Grommet Location (Add \$80 per grommet)

No Grommet **GN**  
 Left **GL**  
 Center **GC**  
 Right **GR**  
 Left & Right **GB**  
 All **GA**

Specify location first, then select grommet color or "Empty Cutout" option. When "Empty Cutout" option is selected, a grommet or power unit must be ordered separately for each cutout.

## TO ORDER PLEASE SPECIFY THE FOLLOWING:

### WOOD TOP

1. **MODEL NUMBER + W**
2. **FSC**
3. **TOP WOOD FINISH + EDGE**
4. **TOP FINISH**
5. **GRAIN DIRECTION**
6. **GROMMET**

### LAM TOP

1. **MODEL NUMBER + L**
2. **FSC**
3. **TOP LAM**
4. **GRAIN DIRECTION (up to 60")**
5. **GROMMET**

D	W	H	model number	sin#
3 1/8	15 3/16	7 1/8	<b>ACWCB15</b>	235
<ul style="list-style-type: none"> <li>For use with 24" tops to provide support on center as an alternative to a T-bracket.</li> </ul>				
3 1/8	20 3/16	7 1/8	<b>ACWCB20</b>	252
<ul style="list-style-type: none"> <li>For use with 24" tops to provide support on an end condition.</li> </ul>				

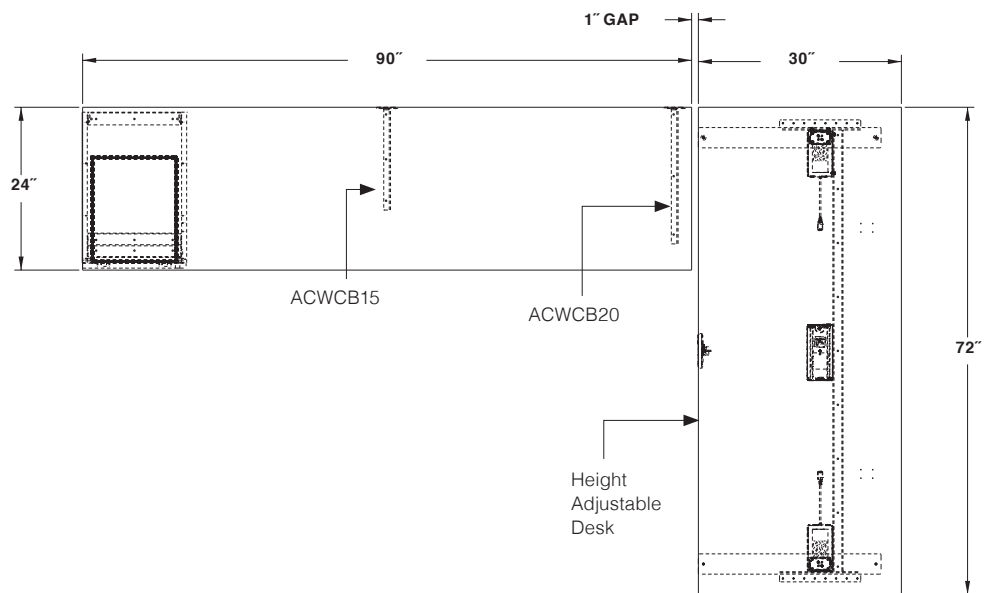
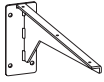

**PRODUCT INFO**

**TO ORDER PLEASE SPECIFY THE FOLLOWING:**

LIST

- MODEL NUMBER**

# MIXED MATERIAL TELESCOPING HEIGHT ADJUSTABLE

Modesty Panels

Silea  
02/24

	D	W	H	model number + type	laminat	veneer 1	veneer 2	veneer 3	metal
	3/4	58	10	<b>GS2XMAMOD66-</b> [ ]	666	846	931	1,016	657
	3/4	64	10	<b>GS2XMAMOD72-</b> [ ]	730	923	1,016	1,108	718
	3/4	70	10	<b>GS2XMAMOD78-</b> [ ]	793	963	1,060	1,156	782

- For use with Telescoping Height Adjustable Extensions

## PRODUCT INFO

### Grain Direction:

- Natural veneer:  
Vertical
- Stratawood veneer:  
Optional
- Laminate:  
Horizontal

## TO ORDER PLEASE SPECIFY THE FOLLOWING:

### WOOD MODESTY





- MODEL NUMBER + W**
- FSC**
- CHASSIS WOOD FINISH**

### LAM MODESTY

- MODEL NUMBER + L**
- FSC**
- CHASSIS LAM**

### METAL MODESTY

- MODEL NUMBER + M**
- HARDWARE COLOR**

	D	W	H	model number	list
 <p><b>BASIC UP/DOWN KEYPAD</b></p>				<b>ACHAT-UD</b>	77
				<ul style="list-style-type: none"> <li>• Basic Up/Down control.</li> </ul>	
 <p><b>MEMORY PRESET KEYPAD</b></p>				<b>ACHAT-MEM</b>	96
				<ul style="list-style-type: none"> <li>• 4 memory pre-set options allow the user to adjust their height to their preferred heights.</li> </ul>	
 <p><b>PADDLE KEYPAD</b></p>				<b>ACHAT-PDL</b>	142
				<ul style="list-style-type: none"> <li>• Simple, aesthetic control with 1 memory pre-set option and reminder mode.</li> </ul>	
 <p><b>BLUETOOTH APP CONTROL</b></p>				<b>ACHAT-BLUETOOTH</b>	113
				<ul style="list-style-type: none"> <li>• Bluetooth receiver can be paired with phone app to operate desk.</li> <li>• Can be used in combination with hand controller for multi-control option.</li> </ul>	

**PRODUCT INFO**

\*\*ONLY FOR USE WITH CANTILEVER HEIGHT ADJUSTABLE DESKS AT THIS TIME\*\*

**Note:** When purchased separately without a configurable TAA compliant end product, not on GSA contract

**TO ORDER PLEASE SPECIFY THE FOLLOWING:**

LIST

- 1. MODEL NUMBER**





- Welcome Desk . . . . . 123-146
  - Working with Welcome Desks . . . . . 124-127
  - Welcome Desk Typicals . . . . . 128-129
  - Advanced Height Adjustable Welcome Desk . . . . . 130-133
  - Advanced Fixed Height Welcome Desk . . . . . 134-135
  - Fixed Height Welcome Desk . . . . . 136-137
  - Welcome Desk Shell . . . . . 138-139
  - Welcome Desk Bridge . . . . . 140
  - Welcome Desk Returns . . . . . 141
  - Welcome Desk Credenzas . . . . . 142
  - Waterfall Transaction Tops . . . . . 143
  - Transaction Tops . . . . . 144
  - Welcome Desk Tackboard . . . . . 145
  - In/Out Storage Unit . . . . . 146

**GALLERY PANELS**

- Gallery Panels are constructed of 1 1/8" particleboard with 2mm edgebanding.
- All laminate gallery panels are made using HPL laminate. All panels greater than 60" in width will run horizontal grain.
- All veneer gallery panels are made using an engineered reconstituted (recon) veneer to provide a consistent matching grain pattern and color across adjoining gallery panels. The 2 types of recon veneer used are:
  - 1) A Recon veneer chosen as a close match to natural veneers which are used on tops/chassis. See below for recon to natural finish cross-reference:
    - Gallery panels with finish options starting with "EC" for Recon Cherry to be used with "NC" Natural Cherry tops/chassis.
    - Gallery panels with finish options starting with "ET" for Recon Walnut to be used with "NT" Natural Walnut tops/chassis.
    - Gallery panels with finish options starting with "EF" for Recon Rift Oak to be used with "RF" Natural Rift Oak tops/chassis.
  - 2) Stratawood veneer is also a reconstituted veneer in a straight grain pattern. Stratawood veneer is available on both gallery panels and tops/chassis so the same finish option can be carried through the entire office spec.
    - Stratawood is available in "SC" Cherry, "SE" Maple, "ST" Walnut, and "SF" Oak, "SB" Silver Oak, "SW" Washed Walnut veneers and finishes.

**FINISH MATRIX SUMMARY**

<b>Gallery Panel Finish Code</b>	<b>Tops/Chassis Finish Code</b>
EC Recon Cherry	NC Natural Cherry
ET Recon Walnut	NT Natural Walnut
EF Recon Rift Oak	RF Natural Rift Oak
SC Stratawood Cherry	SC Stratawood Cherry
SE Stratawood Maple	SE Stratawood Maple
ST Stratawood Walnut	ST Stratawood Walnut
SF Stratawood Oak	SF Stratawood Oak
SB Stratawood Silver Oak	SB Stratawood Silver Oak
SW Stratawood Washed Walnut	SW Stratawood Washed Walnut

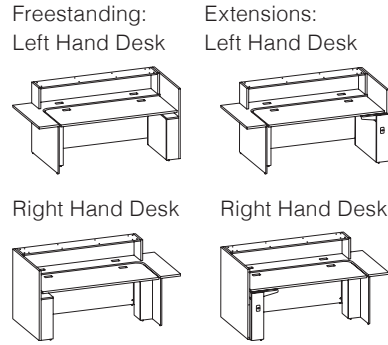

## ADVANCED HEIGHT ADJUSTABLE WELCOME DESK

- Split top design provides matching grain on fixed and HAT desk surface.
- For use with waterfall transaction tops only. A waterfall transaction top must be ordered separately and is required (waterfall transaction top substructure included with desk is unfinished).
- Available as Extension Desks or Freestanding Desks.
- Extension desks not for freestanding applications. Must connect to adjoining fixed Welcome bridge or return. Gallery end panel includes boring for connecting to adjoining gallery panels. Includes integrated cantilever support panel for supporting bridge or return top. Must only be used with Welcome bridge or returns with gallery panels.
- Freestanding desks not for use in extension applications with bridges/returns.
- Fixed portion of top always includes left & right grommets. HAT portion of top has optional grommets.
- Available with shroud or 15W desk depth pedestal on conference end.
- Monitor arms should be mounted in HAT top grommets.
- Connecting end shroud includes removable access panel for wire management.

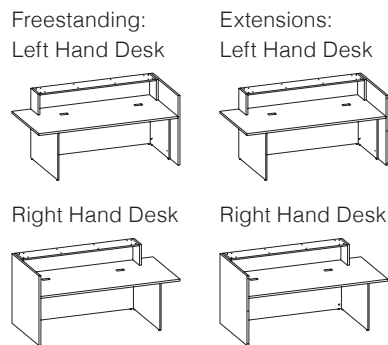

## ADVANCED FIXED HEIGHT WELCOME DESK

- For use with waterfall transaction tops only. A waterfall transaction top must be ordered separately and is required (waterfall transaction top substructure included with desk is unfinished).
- Available as Extension Desks or Freestanding Desks.
- Extension desks not for freestanding applications. Must connect to adjoining fixed bridge or return. Gallery end panel includes boring for connecting to adjoining gallery panels. Must only be used with Welcome bridge or returns with gallery panels.
- Freestanding desks not for use in extension applications with bridges/returns.
- Grommets are optional.
- Available with end panel or 15W desk depth pedestal on conference end.



## WELCOME DESK SHELL

- Available as Extension Desks or Freestanding Desks.
- Extension desks not for freestanding applications. Must connect to adjoining fixed bridge or return. Gallery end panel includes boring for connecting to adjoining gallery panels. Must only be used with Welcome bridge or returns with gallery panels.
- Freestanding desks not for use in extension applications with bridges/returns.
- Double desk configurations follow the same rules as extension vs. freestanding desks.
- Shell design allows for 30D/36D modular pedestals to be added.
- Specify appropriate desk for transaction top type to be used.
- Grommets are optional.

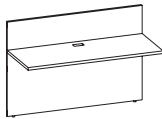
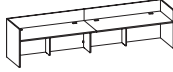

## WELCOME DESK BRIDGE

- Connects to adjoining Welcome Desk and Welcome Credenzas with gallery panels.
- Worksurface-to-worksurface flat brackets included.
- Grommets are optional.

Left Hand



## WELCOME DESK RETURNS

- Connects to adjoining Welcome Desk with gallery panels.
- Worksurface-to-worksurface flat brackets included.
- Shell design allows for 24D modular pedestals to be added.
- Grommets are optional.

Right Hand

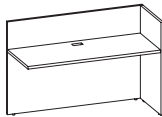

## WORKING WITH SILEA WELCOME DESKS

Left Hand

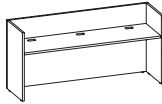

Right Hand

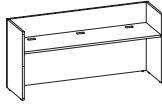

### WELCOME DESK CREDENZAS

- Connects to adjoining Welcome Bridge with gallery panels.
- Not for freestanding applications. Gallery end panel includes boring for connecting to adjoining gallery panels.
- Shell design allows for 24D modular pedestals to be added.
- Grommets are optional.

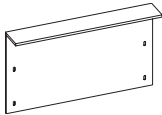

### WATERFALL TRANSACTION TOPS

- Mitered assembly.
- For use with Advanced Desks and Desk Shells that are for use with Waterfall Transaction Tops.



### TRANSACTION TOPS

- Spans across 2 gallery panels.
- 3" guest overhang.
- Attaches to gallery panels with 9" black angle brackets, must be supported by gallery panels on each and across front.

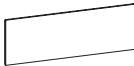

### WELCOME DESK TACKBOARD

- Height designed to sit below transaction top attachment brackets.
- To be set on worksurface and attached gallery panels using velcro.

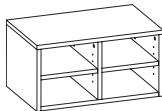

### IN/OUT STORAGE UNIT

- 3/4" panel construction.
- Center shelf adjustable on 5 hole pattern.
- Single sided access with full back panel.
- Set on worksurface with protective felt tape allows for easy relocation.

# SILEA WELCOME DESK TYPICALS

Silea  
02/24

## TYPICAL 1 — FREESTANDING DESK

Item	Model	Description	Quantity
A	GS2CPD2415-3W	GUN Mod Ped 24D x 15W-3 Wd	1
B	GS6GDR3072-WW	GUN Freestanding Desk Shell 30x72 Wd	1
C	GS6GDTT72-W	GUN Desk Transaction Top 15X72 Wd	1



## TYPICAL 2 — L STATION

Item	Model	Description	Quantity
A	GS6GRT2448L-WW	GUN Return Shell LH 24x48 Wd	1
B	GS2CPD2430L-MFW	GUN Mod Ped 24D x 30W MF LH Wd	1
C	GS6GDR3072R-WW	GUN Handed Desk Shell RH 30x72 Wd	1
D	GS6GDTT72-W	GUN Desk Transaction Top 15X72 Wd	1



## TYPICAL 3 — U STATION

Item	Model	Description	Quantity
A	S6GCR2472L-WW	GUN Credenza Shell LH 24x72 Wd	1
B	ACMWS41	GUN Acc Steel Wksf Support 41W	1
C	GS2CPD2415-2W	GUN Mod Ped 24D x 15W-2 Wd	1
D	GS2CPD2436-4W	GUN Mod Ped 24D x 36W-4 Wd	1
E	GS6GBG2454-WW	GUN Bridge Shell 24x54 Wd	1
F	GS6GDR3072R-WW	GUN Handed Desk Shell RH 30x72 Wd	1
G	GS6GDTT72-W	GUN Desk Transaction Top 15X72 Wd	1



**TYPICAL 4 — DOUBLE FREESTANDING DESK**

Item	Model	Description	Quantity
A	GS2CPD2415-2W	GUN Mod Ped 24D x 15W-2 Wd	1
B	GS2CPD2415-3W	GUN Mod Ped 24D x 15W-3 Wd	1
C	GS6GDR36144-WW	GUN Freestanding Desk Shell 36x144 Wd	1
D	GS6GDTT144-W	GUN Desk Transaction Top 15X144 Wd	1



**TYPICAL 5 — ADVANCED FREESTANDING HAT DESK**

Item	Model	Description	Quantity
A	GS6GDFA42102L-AWW	Advanced Freestnd Dsk HAT 42102 w/ -A Ped LH Wood	1
B	GS6GDXMT72-W	GUN Desk Transaction Waterfall 72 Wd	1

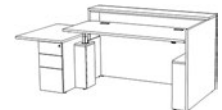

**TYPICAL 6 — DOUBLE ADVANCED FIXED DESK**

Item	Model	Description	Quantity
A	GS6GDFF42102L-AWW	Advanced FreestndDsk Fixed 42102 w/ -A Ped LH Wd	1
B	GS6GDFF42102R-AWW	Advanced FreestndDsk Fixed 42102 w/ -A Ped RH Wd	1
C	GS6GDXMT72-W	GUN Desk Transaction Waterfall 72 Wd	2



# ADVANCED HEIGHT ADJUSTABLE WELCOME DESK

Silea

02/24

Extension

	D	W	H	model number + type	laminata	veneer 1	veneer 2	veneer 3
<b>LEFT HAND DESK</b>	45	85	41	<b>GS6GDXA4284L- [ ]</b>	8,102	11,159	12,275	13,391

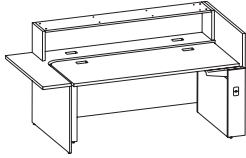

A = 69.86"  
B = 28"  
C = 11.25"  
D = 12.32"  
E = 12.13"

## RIGHT HAND DESK

	45	85	41	<b>GS6GDXA4284R- [ ]</b>	8,102	11,159	12,275	13,391
--	----	----	----	--------------------------	-------	--------	--------	--------

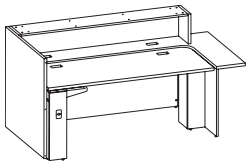

A = 69.86"  
B = 28"  
C = 11.25"  
D = 12.32"  
E = 12.13"

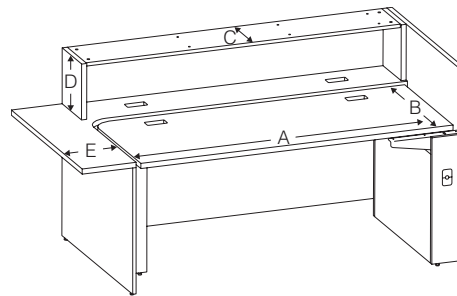

### PRODUCT INFO

Separate countertop must be specified.

29.5" to 42.5" height adjustment range.

 All units shipped as separate packages and require field assembly.

#### Grommet Location

Specify location first, then select grommet color or "Empty Cutout" option. When "Empty Cutout" option is selected, a grommet or power unit must be ordered separately for each cutout.

No upcharge for "Empty Cutout" option.

(Add +\$236 per additional grommet)

Fixed Top always has Left & Right grommets.

Left	<b>GL</b>
Right	<b>GR</b>
Left & Right	<b>GB</b>

NOTE: Monitor arms should **ALWAYS** be installed in grommets on Silea height adjustable units. Please ensure a grommet location is specified on the top. This allows for bolt mount or clamp mount install of monitor arm. See page 35 for details.

### TO ORDER PLEASE SPECIFY THE FOLLOWING:

#### WOOD TOP, WOOD CHASSIS

- MODEL NUMBER + WW**
- FSC**
- TOP WOOD FINISH + EDGE**
- CHASSIS WOOD FINISH**
- GALLERY PANEL WOOD FINISH**
- TOP FINISH**
- HAT KEYPAD & BASE COLOR**
- GROMMET**

Optional height adjustable keypads available

#### HAT KEYPAD & BASE COLOR

Basic Up/Down Keypad, Black P71 Column  
Memory Preset Keypad, Black P71 Column  
Paddle Keypad, Black P71 Column

#### LAM TOP, LAM CHASSIS

- MODEL NUMBER + LL**
- FSC**
- TOP LAM**
- CHASSIS LAM**
- EDGE DETAIL**
- HAT KEYPAD & BASE COLOR**
- GROMMET**

**UDP71**  
**MEMP71**  
**PDLP71**

NOTE: Wood Tops only available with Square SQ Edge Detail option. Edge Details SQM, DFM, and TOM with 1/2" band are NOT available.



	D	W	H	model number + type	laminare	veneer 1	veneer 2	veneer 3
<b>LEFT HAND DESK</b>	45	103	41	<b>GS6GDXA42102L-A</b> [ ]	10,516	14,598	16,058	17,518

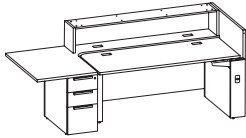

A = 69.84"  
B = 28"  
C = 11.24"  
D = 12.32"  
E = 30.13"

<b>RIGHT HAND DESK</b>	45	103	41	<b>GS6GDXA42102R-A</b> [ ]	10,516	14,598	16,058	17,518
------------------------	----	-----	----	----------------------------	--------	--------	--------	--------

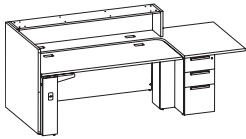

A = 69.84"  
B = 28"  
C = 11.24"  
D = 12.32"  
E = 30.13"

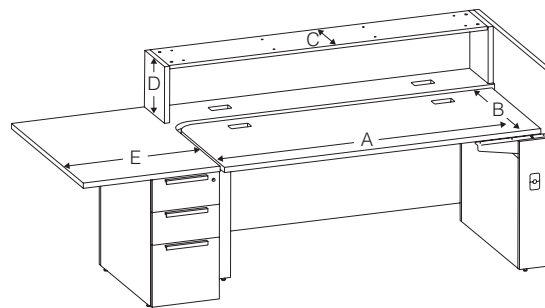

## PRODUCT INFO

Separate countertop must be specified.

29.5" to 42.5" height adjustment range.

 All units shipped as separate packages and require field assembly.

### Grommet Location

Specify location first, then select grommet color or "Empty Cutout" option. When "Empty Cutout" option is selected, a grommet or power unit must be ordered separately for each cutout.

No upcharge for "Empty Cutout" option.

(Add +\$236 per additional grommet)

Fixed Top always has Left & Right grommets.

Left	<b>GL</b>
Right	<b>GR</b>
Left & Right	<b>GB</b>

NOTE: Monitor arms should **ALWAYS** be installed in grommets on Silea height adjustable units. Please ensure a grommet location is specified on the top. This allows for bolt mount or clamp mount install of monitor arm. See page 35 for details.

## TO ORDER PLEASE SPECIFY THE FOLLOWING:

### WOOD TOP, WOOD CHASSIS

- MODEL NUMBER + WW**
- FSC**
- TOP WOOD FINISH + EDGE**
- CHASSIS WOOD FINISH**
- GALLERY PANEL WOOD FINISH**
- TOP FINISH**
- PULL**
- DRAWERS**
- HAT KEYPAD & BASE COLOR**
- GROMMET**
- KEYING**

### LAM TOP, LAM CHASSIS

- MODEL NUMBER + LL**
- FSC**
- TOP LAM**
- CHASSIS LAM**
- EDGE DETAIL**
- PULL**
- DRAWERS**
- HAT KEYPAD & BASE COLOR**
- GROMMET**
- KEYING**

Optional height adjustable keypads available

### HAT KEYPAD & BASE COLOR

Basic Up/Down Keypad, Black P71 Column  
Memory Preset Keypad, Black P71 Column  
Paddle Keypad, Black P71 Column

**UDP71**  
**MEMP71**  
**PDLP71**

NOTE: Wood Tops only available with Square SQ Edge Detail option. Edge Details SQM, DFM, and TOM with 1/2" band are NOT available.

# ADVANCED HEIGHT ADJUSTABLE WELCOME DESK

Freestanding

Silea  
02/24

	D	W	H	model number + type	laminata	veneer 1	veneer 2	veneer 3
<b>LEFT HAND DESK</b>	41	85	41	<b>GS6GDFA4284L- [ ]</b>	8,100	10,942	12,037	13,131

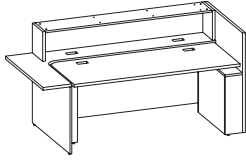

A = 69.84"  
B = 28"  
C = 11.24"  
D = 12.32"  
E = 12.13"

## RIGHT HAND DESK

	41	85	41	<b>GS6GDFA4284R- [ ]</b>	8,100	10,942	12,037	13,131
--	----	----	----	--------------------------	-------	--------	--------	--------

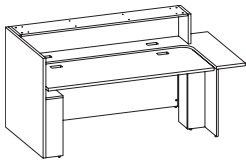

A = 69.84"  
B = 28"  
C = 11.24"  
D = 12.32"  
E = 12.13"

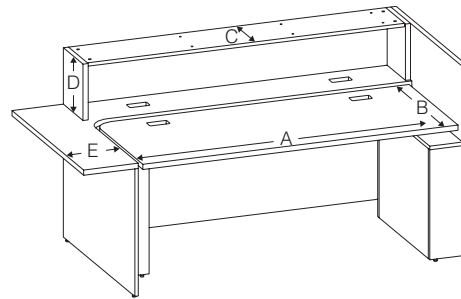

### PRODUCT INFO

Separate countertop must be specified.

29.5" to 42.5" height adjustment range.

All units shipped as separate packages and require field assembly.

#### Grommet Location

Specify location first, then select grommet color or "Empty Cutout" option. When "Empty Cutout" option is selected, a grommet or power unit must be ordered separately for each cutout.

No upcharge for "Empty Cutout" option.

(Add +\$236 per additional grommet)

Fixed Top always has Left & Right grommets.

Left	<b>GL</b>
Right	<b>GR</b>
Left & Right	<b>GB</b>

NOTE: Monitor arms should **ALWAYS** be installed in grommets on Silea height adjustable units. Please ensure a grommet location is specified on the top. This allows for bolt mount or clamp mount install of monitor arm. See page 35 for details.

### TO ORDER PLEASE SPECIFY THE FOLLOWING:

#### WOOD TOP, WOOD CHASSIS

- MODEL NUMBER + WW**
- FSC**
- TOP WOOD FINISH + EDGE**
- CHASSIS WOOD FINISH**
- GALLERY PANEL WOOD FINISH**
- TOP FINISH**
- PULL**
- DRAWERS**
- HAT KEYPAD & BASE COLOR**
- GROMMET**
- KEYING**

#### LAM TOP, LAM CHASSIS

- MODEL NUMBER + LL**
- FSC**
- TOP LAM**
- CHASSIS LAM**
- EDGE DETAIL**
- PULL**
- DRAWERS**
- HAT KEYPAD & BASE COLOR**
- GROMMET**
- KEYING**

Optional height adjustable keypads available

#### HAT KEYPAD & BASE COLOR

Basic Up/Down Keypad, Black P71 Column  
Memory Preset Keypad, Black P71 Column  
Paddle Keypad, Black P71 Column

**UDP71**  
**MEMP71**  
**PDLP71**

NOTE: Wood Tops only available with Square SQ Edge Detail option. Edge Details SQM, DFM, and TOM with 1/2" band are NOT available.

# ADVANCED HEIGHT ADJUSTABLE WELCOME DESK

Freestanding with Pedestal

	D	W	H	model number + type	laminate	veneer 1	veneer 2	veneer 3
<b>LEFT HAND DESK</b>	41	103	41	<b>GS6GDFA42102L-A</b> [ ]	10,514	14,381	15,820	17,258

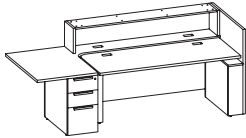

A = 69.84"  
B = 28"  
C = 11.24"  
D = 12.32"  
E = 30.13"

<b>RIGHT HAND DESK</b>	41	103	41	<b>GS6GDFA42102R-A</b> [ ]	10,514	14,381	15,820	17,258
------------------------	----	-----	----	----------------------------	--------	--------	--------	--------

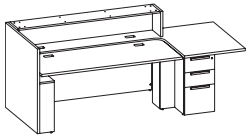

A = 69.84"  
B = 28"  
C = 11.24"  
D = 12.32"  
E = 30.13"

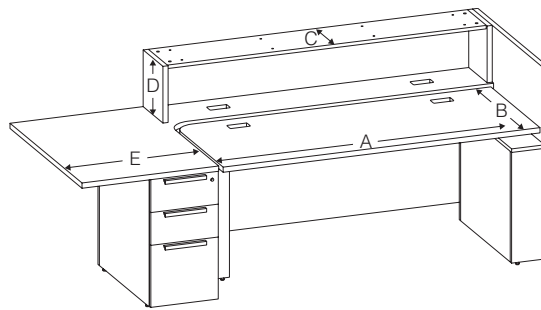

## PRODUCT INFO

Separate countertop must be specified.

29.5" to 42.5" height adjustment range.

 All units shipped as separate packages and require field assembly.

### Grommet Location

Specify location first, then select grommet color or "Empty Cutout" option. When "Empty Cutout" option is selected, a grommet or power unit must be ordered separately for each cutout.

No upcharge for "Empty Cutout" option.

(Add +\$236 per additional grommet)

Fixed Top always has Left & Right grommets.

Left **GL**  
Right **GR**  
Left & Right **GB**

NOTE: Monitor arms should **ALWAYS** be installed in grommets on Silea height adjustable units. Please ensure a grommet location is specified on the top. This allows for bolt mount or clamp mount install of monitor arm. See page 35 for details.

## TO ORDER PLEASE SPECIFY THE FOLLOWING:

### WOOD TOP, WOOD CHASSIS

- MODEL NUMBER + WW**
- FSC**
- TOP WOOD FINISH + EDGE**
- CHASSIS WOOD FINISH**
- GALLERY PANEL WOOD FINISH**
- TOP FINISH**
- HAT KEYPAD & BASE COLOR**
- GROMMET**

Optional height adjustable keypads available

### HAT KEYPAD & BASE COLOR

Basic Up/Down Keypad, Black P71 Column  
Memory Preset Keypad, Black P71 Column  
Paddle Keypad, Black P71 Column

### LAM TOP, LAM CHASSIS

- MODEL NUMBER + LL**
- FSC**
- TOP LAM**
- CHASSIS LAM**
- EDGE DETAIL**
- HAT KEYPAD & BASE COLOR**
- GROMMET**

**UDP71**  
**MEMP71**  
**PDLP71**

NOTE: Wood Tops only available with Square SQ Edge Detail option. Edge Details SQM, DFM, and TOM with 1/2" band are NOT available.

# ADVANCED FIXED HEIGHT WELCOME DESK

Silea

02/24

Extension

	D	W	H	model number + type	laminata	veneer 1	veneer 2	veneer 2
<b>LEFT HAND DESK</b>	42	85	41	<b>GS6GDXF4284L-</b> [ ]	4,996	6,945	7,640	8,334

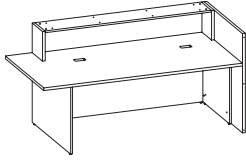

A = 84"  
B = 42"  
C = 11.25"  
D = 12.32"

<b>RIGHT HAND DESK</b>	42	85	41	<b>GS6GDXF4284R-</b> [ ]	4,996	6,945	7,640	8,334
------------------------	----	----	----	--------------------------	-------	-------	-------	-------

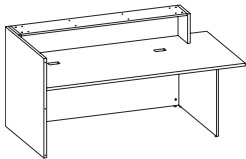

A = 84"  
B = 42"  
C = 11.25"  
D = 12.32"

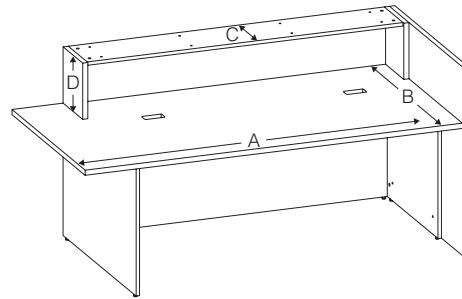

## PRODUCT INFO

Separate countertop must be specified.

### Grommet Location

(Add \$80 per grommet)

No Grommet **GN**  
Left **GL**  
Right **GR**  
Left & Right **GB**

Specify location first, then select grommet color or "Empty Cutout" option. When "Empty Cutout" option is selected, a grommet or power unit must be ordered separately for each cutout.

## TO ORDER PLEASE SPECIFY THE FOLLOWING:

### WOOD TOP, WOOD CHASSIS

1. MODEL NUMBER + WW
2. FSC
3. TOP WOOD FINISH + EDGE
4. CHASSIS WOOD FINISH
5. GALLERY PANEL WOOD FINISH
6. TOP FINISH
7. GROMMET

### LAM TOP, LAM CHASSIS

1. MODEL NUMBER + LL
2. FSC
3. TOP LAM
4. CHASSIS LAM
5. EDGE DETAIL
6. GROMMET

**NOTE:** Wood Tops only available with Square SQ Edge Detail option. Edge Details SQM, DFM, and TOM with 1/2" band are NOT available.

# ADVANCED FIXED HEIGHT WELCOME DESK

Extension with Pedestal

	D	W	H	model number + type	laminates	veneers 1	veneers 2	veneers 2
<b>LEFT HAND DESK</b>	42	103	41	<b>GS6GDXF42102L-A</b> [ ]	7,410	10,585	11,644	12,702

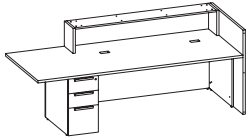

A = 102"  
B = 42"  
C = 11.25"  
D = 12.32"

<b>RIGHT HAND DESK</b>	42	103	41	<b>GS6GDXF42102R-A</b> [ ]	7,410	10,585	11,644	12,702
------------------------	----	-----	----	----------------------------	-------	--------	--------	--------

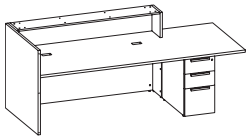

A = 102"  
B = 42"  
C = 11.25"  
D = 12.32"

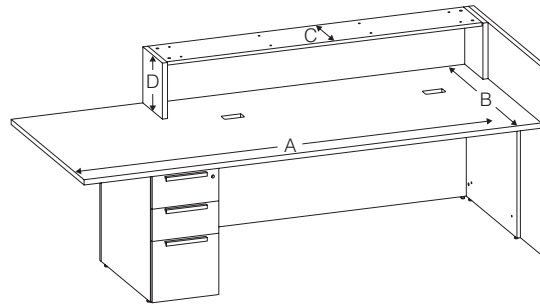

## PRODUCT INFO

Separate countertop must be specified.

### Grommet Location

(Add \$80 per grommet)

No Grommet	<b>GN</b>
Left	<b>GL</b>
Right	<b>GR</b>
Left & Right	<b>GB</b>

Specify location first, then select grommet color or "Empty Cutout" option. When "Empty Cutout" option is selected, a grommet or power unit must be ordered separately for each cutout.

## TO ORDER PLEASE SPECIFY THE FOLLOWING:

### WOOD TOP, WOOD CHASSIS

- MODEL NUMBER + WW**
- FSC**
- TOP WOOD FINISH + EDGE**
- CHASSIS WOOD FINISH**
- GALLERY PANEL WOOD FINISH**
- TOP FINISH**
- PULL**
- DRAWERS**
- GROMMET**
- KEYING**

### LAM TOP, LAM CHASSIS

- MODEL NUMBER + LL**
- FSC**
- TOP LAM**
- CHASSIS LAM**
- EDGE DETAIL**
- PULL**
- DRAWERS**
- GROMMET**
- KEYING**

**NOTE:** Wood Tops only available with Square SQ Edge Detail option. Edge Details SQM, DFM, and TOM with 1/2" band are NOT available.

# FIXED HEIGHT WELCOME DESK

Freestanding

Silea

02/24

	D	W	H	model number + type	laminate	veneer 1	veneer 2	veneer 3
<b>LEFT HAND DESK</b>	42	85	41	<b>GS6GDFF4284L- [ ]</b>	4,996	6,945	7,640	8,334

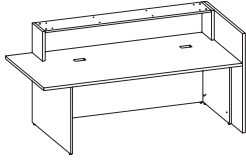

A = 84"  
B = 42"  
C = 11.25"  
D = 12.32"

<b>RIGHT HAND DESK</b>	42	85	41	<b>GS6GDFF4284R- [ ]</b>	4,996	6,945	7,640	8,334
------------------------	----	----	----	--------------------------	-------	-------	-------	-------

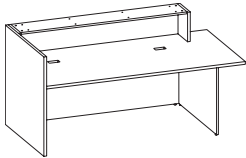

A = 84"  
B = 42"  
C = 11.25"  
D = 12.32"

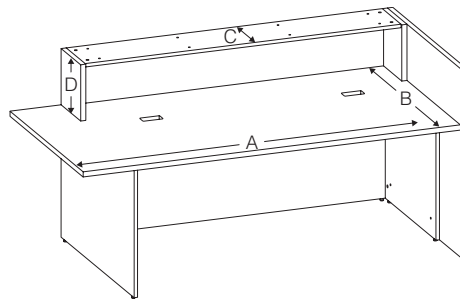

## PRODUCT INFO

Separate countertop must be specified.

### Grommet Location

(Add \$80 per grommet)

No Grommet **GN**  
Left **GL**  
Right **GR**  
Left & Right **GB**

Specify location first, then select grommet color or "Empty Cutout" option. When "Empty Cutout" option is selected, a grommet or power unit must be ordered separately for each cutout.

## TO ORDER PLEASE SPECIFY THE FOLLOWING:

### WOOD TOP, WOOD CHASSIS

- MODEL NUMBER + WW**
- FSC**
- TOP WOOD FINISH + EDGE**
- CHASSIS WOOD FINISH**
- GALLERY PANEL WOOD FINISH**
- TOP FINISH**
- GROMMET**

### LAM TOP, LAM CHASSIS

- MODEL NUMBER + LL**
- FSC**
- TOP LAM**
- CHASSIS LAM**
- EDGE DETAIL**
- GROMMET**

**NOTE:** Wood Tops only available with Square SQ Edge Detail option. Edge Details SQM, DFM, and TOM with 1/2" band are NOT available.

	D	W	H	model number + type	laminata	vener 1	vener 2	vener 3
<b>LEFT HAND DESK</b>	42	103	41	<b>GS6GDFF42102L-A</b> [ ]	7,410	10,585	11,644	12,702

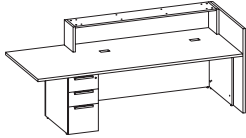

A = 102"  
B = 42"  
C = 11.25"  
D = 12.32"

<b>RIGHT HAND DESK</b>	42	103	41	<b>GS6GDFF42102R-A</b> [ ]	7,410	10,585	11,644	12,702
------------------------	----	-----	----	----------------------------	-------	--------	--------	--------

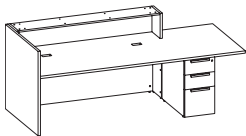

A = 102"  
B = 42"  
C = 11.25"  
D = 12.32"

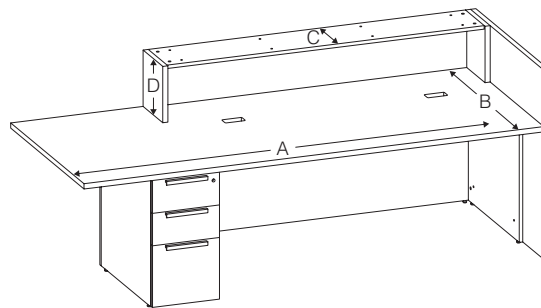

**PRODUCT INFO**

Separate countertop must be specified.

**Grommet Location**  
(Add \$80 per grommet)

- No Grommet **GN**
- Left **GL**
- Right **GR**
- Left & Right **GB**

Specify location first, then select grommet color or "Empty Cutout" option. When "Empty Cutout" option is selected, a grommet or power unit must be ordered separately for each cutout.

**TO ORDER PLEASE SPECIFY THE FOLLOWING:**

WOOD TOP, WOOD CHASSIS

1. **MODEL NUMBER + WW**
2. **FSC**
3. **TOP WOOD FINISH + EDGE**
4. **CHASSIS WOOD FINISH**
5. **GALLERY PANEL WOOD FINISH**
6. **TOP FINISH**
7. **PULL**
8. **GROMMET**
9. **KEYING**

LAM TOP, LAM CHASSIS

1. **MODEL NUMBER + LL**
2. **FSC**
3. **TOP LAM**
4. **CHASSIS LAM**
5. **EDGE DETAIL**
6. **PULL**
7. **GROMMET**
8. **KEYING**

**NOTE:** Wood Tops only available with Square SQ Edge Detail option. Edge Details SQM, DFM, and TOM with 1/2" band are NOT available.

# WELCOME DESK SHELL

Freestanding

Silea

02/24

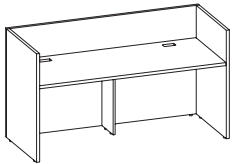
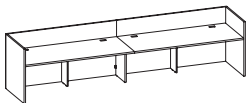
	D	W	H	model number + type	laminate	veneer 1	veneer 2	veneer 3
 GS6GDR3072	31 1/4	74 1/2	41 1/4	<b>GS6GDR3072-</b> [ ] [ ]	4,138	5,683	6,252	6,820
	37 1/4	74 1/2	41 1/4	<b>GS6GDR3672-</b> [ ] [ ]	4,380	6,003	6,604	7,204
	37 1/4	86 1/2	41 1/4	<b>GS6GDR3684-</b> [ ] [ ]	4,967	6,766	7,443	8,120
	31 1/4	146 1/2	41 1/4	<b>GS6GDR30144-</b> [ ] [ ]	6,947	9,971	10,969	11,966
	37 1/4	146 1/2	41 1/4	<b>GS6GDR36144-</b> [ ] [ ]	7,251	10,383	11,422	12,460
	37 1/4	170 1/2	41 1/4	<b>GS6GDR36168-</b> [ ] [ ]	8,389	11,860	13,046	14,232
 GS6GDR36168	<ul style="list-style-type: none"> <li>• For use with standard transaction tops or with no transaction top. NOT for use with waterfall transaction tops.</li> </ul>							
	31 1/4	74 1/2	41 1/4	<b>GS6GDTR3072-</b> [ ] [ ]	4,138	5,683	6,252	6,820
	37 1/4	74 1/2	41 1/4	<b>GS6GDTR3672-</b> [ ] [ ]	4,380	6,003	6,604	7,204

- For use with Waterfall Transaction Top only.
- Add only L or W to end of model number for these two models.

## PRODUCT INFO

Wood tops long grain.  
Laminate tops long grain standard.

 Units shipped as separate packages and require field assembly.

**Grommet Location**  
(Add \$80 per grommet for widths 72"-84", \$158 per grommet for widths 144"-168")

No Grommet **GN**  
Center **GC**  
Left & Right **GB**

Specify location first, then select grommet color or "Empty Cutout" option. When "Empty Cutout" option is selected, a grommet or power unit must be ordered separately for each cutout.

## TO ORDER PLEASE SPECIFY THE FOLLOWING:

### WOOD TOP, WOOD CHASSIS

- MODEL NUMBER + WW**
- FSC**
- TOP WOOD FINISH + EDGE**
- CHASSIS WOOD FINISH**
- GALLERY PANEL WOOD FINISH**
- TOP FINISH**
- GROMMET**

### LAM TOP, LAM CHASSIS

- MODEL NUMBER + LL**
- FSC**
- TOP LAM**
- CHASSIS LAM**
- EDGE DETAIL**
- GROMMET**

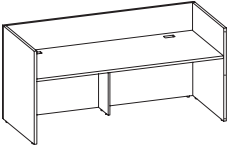
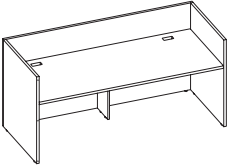
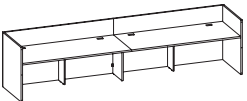

	D	W	H	model number + type	laminate	veneer 1	veneer 2	veneer 2
<b>LEFT HAND</b> 	31 1/4	74 1/2	41 1/4	<b>GS6GDR3072L-</b> [ ]	4,138	5,683	6,252	6,820
	37 1/4	74 1/2	41 1/4	<b>GS6GDR3672L-</b> [ ]	4,380	6,003	6,604	7,204
	37 1/4	86 1/2	41 1/4	<b>GS6GDR3684L-</b> [ ]	4,967	6,766	7,443	8,120
	<ul style="list-style-type: none"> <li>• For use with standard transaction tops or with no transaction top. NOT for use with waterfall transaction tops.</li> </ul>							
	31 1/4	74 1/2	41 1/4	<b>GS6GDTR3072L-</b> [ ]	4,138	5,683	6,252	6,820
	37 1/4	74 1/2	41 1/4	<b>GS6GDTR3672L-</b> [ ]	4,380	6,003	6,604	7,204
	<ul style="list-style-type: none"> <li>• For use with Waterfall Transaction Top only.</li> <li>• Add only L or W to end of model number for these two models.</li> </ul>							
<b>RIGHT HAND</b> 	31 1/4	74 1/2	41 1/4	<b>GS6GDR3072R-</b> [ ]	4,138	5,683	6,252	6,820
	37 1/4	74 1/2	41 1/4	<b>GS6GDR3672R-</b> [ ]	4,380	6,003	6,604	7,204
	37 1/4	86 1/2	41 1/4	<b>GS6GDR3684R-</b> [ ]	4,967	6,766	7,443	8,120
	<ul style="list-style-type: none"> <li>• For use with standard transaction tops or with no transaction top. NOT for use with waterfall transaction tops.</li> </ul>							
	31 1/4	74 1/2	41 1/4	<b>GS6GDTR3072R-</b> [ ]	4,138	5,683	6,252	6,820
	37 1/4	74 1/2	41 1/4	<b>GS6GDTR3672R-</b> [ ]	4,380	6,003	6,604	7,204
	<ul style="list-style-type: none"> <li>• For use with Waterfall Transaction Top only.</li> <li>• Add only L or W to end of model number for these two models.</li> </ul>							
<b>LEFT AND RIGHT HAND</b> 	31 1/4	146 1/2	41 1/4	<b>GS6GDR30144LR-</b> [ ]	6,947	9,971	10,969	11,966
	37 1/4	146 1/2	41 1/4	<b>GS6GDR36144LR-</b> [ ]	7,251	10,383	11,422	12,460
	37 1/4	170 1/2	41 1/4	<b>GS6GDR36168LR-</b> [ ]	8,389	11,860	13,046	14,232
	<ul style="list-style-type: none"> <li>• For use with standard transaction tops or with no transaction top. NOT for use with waterfall transaction tops.</li> </ul>							

**PRODUCT INFO**

Wood tops long grain.  
Laminate tops long grain standard.

 Units shipped as separate packages and require field assembly.

**Grommet Location**  
(Add \$80 per grommet for widths 72"-84", \$158 per grommet for widths 144"-168")

No Grommet **GN**  
Center **GC**  
Left & Right **GB**

Specify location first, then select grommet color or "Empty Cutout" option. When "Empty Cutout" option is selected, a grommet or power unit must be ordered separately for each cutout.

**TO ORDER PLEASE SPECIFY THE FOLLOWING:**

WOOD TOP, WOOD CHASSIS

1. MODEL NUMBER + WW
2. FSC
3. TOP WOOD FINISH + EDGE
4. CHASSIS WOOD FINISH
5. GALLERY PANEL WOOD FINISH
6. TOP FINISH
7. GROMMET

LAM TOP, LAM CHASSIS

1. MODEL NUMBER + LL
2. FSC
3. TOP LAM
4. CHASSIS LAM
5. EDGE DETAIL
6. GROMMET

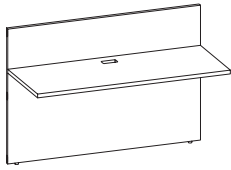

D	W	H	model number + type	laminate	veneer 1	veneer 2	veneer 3
25	48	41 1/4	<b>GS6GBG2448-</b> [ ]	1,875	2,319	2,551	2,783
25	54	41 1/4	<b>GS6GBG2454-</b> [ ]	2,135	2,495	2,745	2,994
25	60	41 1/4	<b>GS6GBG2460-</b> [ ]	2,280	2,678	2,946	3,214

**PRODUCT INFO**

Wood tops short grain standard. Lam tops short grain standard.

 Units shipped as separate packages and require field assembly.

**Grommet Location**  
(Add \$80 per grommet)

No Grommet **GN**  
Center **GC**

Specify location first, then select grommet color or "Empty Cutout" option. When "Empty Cutout" option is selected, a grommet or power unit must be ordered separately for each cutout.

**TO ORDER PLEASE SPECIFY THE FOLLOWING:**

WOOD TOP, WOOD CHASSIS

1. **MODEL NUMBER + WW**
2. **FSC**
3. **TOP WOOD FINISH + EDGE**
4. **GALLERY PANEL WOOD FINISH**
5. **TOP FINISH**
6. **GROMMET**

LAM TOP, LAM CHASSIS

1. **MODEL NUMBER + LL**
2. **FSC**
3. **TOP LAM**
4. **CHASSIS LAM**
5. **EDGE DETAIL**
6. **GROMMET**

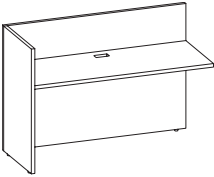
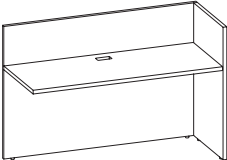
	D	W	H	model number + type	laminate	veneer 1	veneer 2	veneer 3
<b>LEFT HAND</b> 	25 1/4	49 1/4	41 1/4	<b>GS6GRT2448L-</b> <input type="checkbox"/>	2,708	3,595	3,955	4,314
	25 1/4	55 1/4	41 1/4	<b>GS6GRT2454L-</b> <input type="checkbox"/>	2,842	3,772	4,150	4,527
	25 1/4	61 1/4	41 1/4	<b>GS6GRT2460L-</b> <input type="checkbox"/>	2,982	3,959	4,355	4,751
<b>RIGHT HAND</b> 	25 1/4	49 1/4	41 1/4	<b>GS6GRT2448R-</b> <input type="checkbox"/>	2,708	3,595	3,955	4,314
	25 1/4	55 1/4	41 1/4	<b>GS6GRT2454R-</b> <input type="checkbox"/>	2,842	3,772	4,150	4,527
	25 1/4	61 1/4	41 1/4	<b>GS6GRT2460R-</b> <input type="checkbox"/>	2,982	3,959	4,355	4,751

**PRODUCT INFO**

Wood tops short grain standard. Lam tops short grain standard.

 Units shipped as separate packages and require field assembly.

**Grommet Location**  
(Add \$80 per grommet)

No Grommet **GN**  
Center **GC**

Specify location first, then select grommet color or "Empty Cutout" option. When "Empty Cutout" option is selected, a grommet or power unit must be ordered separately for each cutout.

**TO ORDER PLEASE SPECIFY THE FOLLOWING:**

WOOD TOP, WOOD CHASSIS

1. **MODEL NUMBER + WW**
2. **FSC**
3. **TOP WOOD FINISH + EDGE**
4. **GALLERY PANEL WOOD FINISH**
5. **TOP FINISH**
6. **GROMMET**

LAM TOP, LAM CHASSIS

1. **MODEL NUMBER + LL**
2. **FSC**
3. **TOP LAM**
4. **CHASSIS LAM**
5. **EDGE DETAIL**
6. **GROMMET**

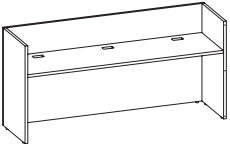
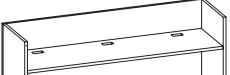
	H	W	D	model number + type	laminate	veneer 1	veneer 2	veneer 3
<b>LEFT HAND</b> 	25 1/4	74 1/2	41 1/4	<b>GS6GCR2472L-</b> [ ]	4,096	5,425	5,968	6,510
	25 1/4	80 1/2	41 1/4	<b>GS6GCR2478L-</b> [ ]	4,269	5,652	6,218	6,783
	25 1/4	86 1/2	41 1/4	<b>GS6GCR2484L-</b> [ ]	4,439	5,877	6,465	7,053
<b>RIGHT HAND</b> 	25 1/4	74 1/2	41 1/4	<b>GS6GCR2472R-</b> [ ]	4,096	5,425	5,968	6,510
	25 1/4	80 1/2	41 1/4	<b>GS6GCR2478R-</b> [ ]	4,269	5,652	6,218	6,783
	25 1/4	86 1/2	41 1/4	<b>GS6GCR2484R-</b> [ ]	4,439	5,877	6,465	7,053

• Flat brackets ordered separately (model #MDWBRK)

**PRODUCT INFO**

All tops long grain.

 Units shipped as separate packages and require field assembly.

**Grommet Location**  
(Add \$80 per grommet)

- No Grommet **GN**
- Left **GL**
- Right **GR**
- Left & Right **GB**
- Center **GC**

Specify location first, then select grommet color or "Empty Cutout" option. When "Empty Cutout" option is selected, a grommet or power unit must be ordered separately for each cutout.

**TO ORDER PLEASE SPECIFY THE FOLLOWING:**

WOOD TOP, WOOD CHASSIS

1. **MODEL NUMBER + WW**
2. **FSC**
3. **TOP WOOD FINISH + EDGE**
4. **TOP FINISH**
5. **GROMMET**

LAM TOP, LAM CHASSIS

1. **MODEL NUMBER + LL**
2. **FSC**
3. **TOP LAM**
4. **CHASSIS LAM**
5. **EDGE DETAIL**
6. **GROMMET**

D	W	H	model number + type	laminate	veneer 1	veneer 2	veneer 2	solid surface
12 1/2	74	41 1/2	<b>GS6GDXMT72- [ ]</b>	1,347	1,679	1,847	2,015	11,585

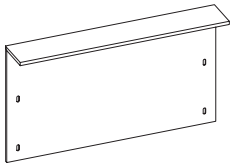

- For use with:  
Advanced HAT Welcome Desk  
Advanced Fixed Welcome Desk  
Welcome Desk Shell  
Welcome Desk Extension

**PRODUCT INFO**

Top thickness:  
Wood 1 3/16"  
Laminate 1 3/16"  
Solid Surface 1 1/4"  
Top includes inserts for connection to base.

**TO ORDER PLEASE SPECIFY THE FOLLOWING:**

WOOD TOP

1. **MODEL NUMBER + W**
2. **FSC**
3. **FINISH**
4. **TOP FINISH**

LAM TOP

1. **MODEL NUMBER + L**
2. **FSC**
3. **FINISH**

SOLID SURFACE TOP



1. **MODEL NUMBER + S**
2. **FINISH**

Example

GS6GDXMT72-W.X.NC260.OP  
 GS6GDXMT72-W    X    NC260    OP  
 MODEL NUMBER + TYPE    FSC    FINISH    TOP FINISH

# TRANSACTION TOPS

Silea  
02/24

	D	W	H	model number + type	laminate	veneer 1	veneer 2	veneer 3	solid surface
 GS6GDTT72	15	74 <sup>3</sup> / <sub>4</sub>	1	<b>GS6GDTT72-</b> [ ]	698	1,311	1,443	1,574	4,358
	15	86 <sup>3</sup> / <sub>4</sub>	1	<b>GS6GDTT84-</b> [ ]	716	1,170	1,287	1,404	4,812
 GS6GDTT168	15	146 <sup>3</sup> / <sub>4</sub>	1	<b>GS6GDTT144-</b> [ ]	899	1,512	1,664	1,815	7,572
	15	170 <sup>3</sup> / <sub>4</sub>	1	<b>GS6GDTT168-</b> [ ]	946	1,707	1,878	2,049	8,676

## PRODUCT INFO

Top thickness:  
Wood 1 <sup>3</sup>/<sub>16</sub>"  
Laminate 1 <sup>3</sup>/<sub>16</sub>"  
Solid Surface 1 <sup>1</sup>/<sub>4</sub>"  
Top includes inserts for connection to base.

## TO ORDER PLEASE SPECIFY THE FOLLOWING:

### WOOD TOP

1. **MODEL NUMBER + W**
2. **FSC**
3. **FINISH**
4. **TOP FINISH**

### LAM TOP

1. **MODEL NUMBER + L**
2. **FSC**
3. **FINISH**

### SOLID SURFACE TOP

1. **MODEL NUMBER + S**
2. **FINISH**

### Example

GS6GDTT72-W.X.NC260.OP

GS6GDTT72-W	X	NC260	OP
MODEL NUMBER + TYPE	FSC	FINISH	TOP FINISH

fabric grades

COM/4

	D	W	H	yards	model number	1	2	3	COM/4
<b>ADVANCED DESK APPLICATION</b>	1	70	11 3/8		<b>GS6GXTK72</b>	966	1,014	1,061	1,110

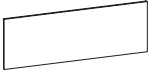

**DESK OR CREDENZA APPLICATION**



1	72	12		<b>GS6GTK72</b>	966	1,014	1,061	1,110
1	78	12		<b>GS6GTK78</b>	995	1,049	1,102	1,154
1	84	12		<b>GS6GTK84</b>	1,024	1,083	1,141	1,199
1	144	12		<b>GS6GTK144</b>	1,824	1,919	2,015	2,109
1	168	12		<b>GS6GTK168</b>	1,941	2,058	2,173	2,289

**RETURN APPLICATION**

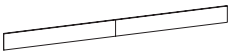

1	71	12		<b>GS6GTK71R</b>	966	1,014	1,061	1,110
1	77	12		<b>GS6GTK77R</b>	995	1,049	1,102	1,154
1	83	12		<b>GS6GTK83R</b>	1,024	1,083	1,141	1,199
1	89	12		<b>GS6GTK89R</b>	1,053	1,112	1,170	1,228
1	94	12		<b>GS6GTK94R</b>	1,079	1,143	1,207	1,270
1	95	12		<b>GS6GTK95R</b>	1,079	1,143	1,207	1,270
1	100	12		<b>GS6GTK100R</b>	1,512	1,582	1,649	1,718
1	106	12		<b>GS6GTK106R</b>	1,572	1,647	1,720	1,794
1	112	12		<b>GS6GTK112R</b>	1,630	1,708	1,783	1,859
1	118	12		<b>GS6GTK118R</b>	1,689	1,774	1,858	1,943
1	124	12		<b>GS6GTK124R</b>	1,747	1,838	1,927	2,016
1	130	12		<b>GS6GTK130R</b>	1,806	1,901	1,997	2,091

**PRODUCT INFO**

100"-130" wide tackboards are 2 piece.

For use with Silea Welcome Desks.

70" wide tackboard for use within Advanced Desk cubby space.

**TO ORDER PLEASE SPECIFY THE FOLLOWING:**

LIST

1. **MODEL NUMBER**
2. **FABRIC**
3. **FSC TACKBOARDS**

**FSC Tackboard Options**

**FSC** = FSC Required (5% COM upcharge)

**NR** = FSC Not Required

# IN/OUT STORAGE

Silea  
02/24

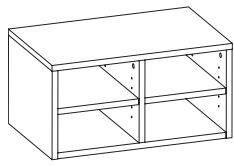

D	W	H	model number + type	laminate	veneer 1	veneer 2	veneer 3	solid surface/ veneer 1	solid surface/ veneer 2	solid surface/ veneer 3
15	23 <sup>3</sup> / <sub>4</sub>	12 <sup>5</sup> / <sub>16</sub>	<b>GS6MB24SS-L</b>	1,070	1,308	1,439	1,570	2,092	2,302	2,511

## PRODUCT INFO

### TO ORDER PLEASE SPECIFY THE FOLLOWING:

#### WOOD TOP

1. **MODEL NUMBER + WW**
2. **FSC**
3. **FINISH**
4. **TOP FINISH**

#### LAM TOP

1. **MODEL NUMBER + LL**
2. **FSC**
3. **FINISH**

#### SOLID SURFACE TOP

1. **MODEL NUMBER + WS**
2. **FSC**
3. **WOOD FINISH**
4. **SOLID SURFACE FINISH**

#### Example

GS6MBS24SS-W.X.NC260.OP

GS6MBS24SS-W	X	NC260	OP
MODEL NUMBER + TYPE	FSC	FINISH	TOP FINISH



Modular Casegoods . . . . .	147-218
Desk Worksurface . . . . .	148-151
Desk Pedestals . . . . .	152-153
Desk Legs . . . . .	154-158
Desk   Runoff Modesty Panel . . . . .	159-164
24 & 30 Depth Worksurfaces . . . . .	165-168
24 & 30 Depth Pedestals . . . . .	169-198
Modular End Panel . . . . .	199
Modular L Supports . . . . .	200
Support & Ped Backs . . . . .	201-211
Layers W/ Laptop Drawer . . . . .	212
Round Tops . . . . .	213
Guitar Pick Top . . . . .	214
Layers Box & Brackets . . . . .	215-217
Modular Pedestal Cushion . . . . .	218

# MODULAR DESK WORKSURFACE

Rectangular

Silea

02/24



D	W	H	model number + type	laminata	veneer 1	veneer 2	veneer 3
30	42	1 3/16	<b>GS2DWRR3042-</b> [ ]	945	1,289	1,418	1,547
30	48	1 3/16	<b>GS2DWRR3048-</b> [ ]	995	1,356	1,492	1,628
30	54	1 3/16	<b>GS2DWRR3054-</b> [ ]	1,007	1,374	1,512	1,649
30	60	1 3/16	<b>GS2DWRR3060-</b> [ ]	1,020	1,389	1,528	1,667
30	66	1 3/16	<b>GS2DWRR3066-</b> [ ]	1,068	1,454	1,600	1,745
30	72	1 3/16	<b>GS2DWRR3072-</b> [ ]	1,124	1,530	1,683	1,836
30	78	1 3/16	<b>GS2DWRR3078-</b> [ ]	1,201	1,638	1,802	1,966
30	84	1 3/16	<b>GS2DWRR3084-</b> [ ]	1,286	1,754	1,930	2,105
30	90	1 3/16	<b>GS2DWRR3090-</b> [ ]	1,370	1,842	2,027	2,211
30	96	1 3/16	<b>GS2DWRR3096-</b> [ ]	1,438	1,934	2,128	2,321

• Flat brackets ordered separately (model #MDWBRK)



36	42	1 3/16	<b>GS2DWRR3642-</b> [ ]	991	1,353	1,489	1,624
36	48	1 3/16	<b>GS2DWRR3648-</b> [ ]	1,045	1,425	1,568	1,710
36	54	1 3/16	<b>GS2DWRR3654-</b> [ ]	1,068	1,454	1,600	1,745
36	60	1 3/16	<b>GS2DWRR3660-</b> [ ]	1,089	1,483	1,632	1,780
36	66	1 3/16	<b>GS2DWRR3666-</b> [ ]	1,143	1,558	1,714	1,870
36	72	1 3/16	<b>GS2DWRR3672-</b> [ ]	1,204	1,641	1,806	1,970
36	78	1 3/16	<b>GS2DWRR3678-</b> [ ]	1,289	1,756	1,932	2,108
36	84	1 3/16	<b>GS2DWRR3684-</b> [ ]	1,379	1,881	2,070	2,258
36	90	1 3/16	<b>GS2DWRR3690-</b> [ ]	1,468	1,974	2,172	2,369
36	96	1 3/16	<b>GS2DWRR3696-</b> [ ]	1,542	2,073	2,281	2,488

• Flat brackets ordered separately (model #MDWBRK)

**NOTE:** Desks and Extensions without a full modesty panel and an unsupported area of 48" and greater require a steel worksurface support.

## PRODUCT INFO

Wood tops optional grain direction.

Lam tops optional grain up to 60", above 60" long grain standard.

### Grommet Location

(Add \$80 per grommet)

No Grommet **GN**  
 Left **GL**  
 Right **GR**  
 Left & Right **GB**

Specify location first, then select grommet color or "Empty Cutout" option. When "Empty Cutout" option is selected, a grommet or power unit must be ordered separately for each cutout.

## TO ORDER PLEASE SPECIFY THE FOLLOWING:

### WOOD TOP

- MODEL NUMBER + W**
- FSC**
- TOP WOOD FINISH + EDGE**
- TOP FINISH**
- GRAIN DIRECTION**
- GROMMET**

### LAM TOP

- MODEL NUMBER + L**
- FSC**
- TOP LAM**
- GRAIN DIRECTION (up to 60")**
- EDGE DETAIL**
- GROMMET**



D	W	H	model number + type	laminata	veneer 1	veneer 2	veneer 3
36	72	1 3/16	<b>GS2DWA3672-</b> [ ]	1,505	2,054	2,260	2,465
36	84	1 3/16	<b>GS2DWA3684-</b> [ ]	1,724	2,351	2,587	2,822

• Flat brackets ordered separately (model #MDWBRK)

42	72	1 3/16	<b>GS2DWA4272-</b> [ ]	1,686	2,300	2,530	2,760
42	84	1 3/16	<b>GS2DWA4284-</b> [ ]	1,930	2,633	2,897	3,160

• Flat brackets ordered separately (model #MDWBRK)

**NOTE:** Desks and Extensions without a full modesty panel and an unsupported area of 48" and greater require a steel worksurface support.

**PRODUCT INFO**

Wood tops optional grain direction.

Lam tops long grain standard.

**Grommet Location**

(Add \$80 per grommet)

No Grommet **GN**  
 Left **GL**  
 Right **GR**  
 Left & Right **GB**

Specify location first, then select grommet color or "Empty Cutout" option. When "Empty Cutout" option is selected, a grommet or power unit must be ordered separately for each cutout.

**TO ORDER PLEASE SPECIFY THE FOLLOWING:**

**WOOD TOP**

1. **MODEL NUMBER + W**
2. **FSC**
3. **TOP WOOD FINISH + EDGE**
4. **TOP FINISH**
5. **GRAIN DIRECTION**
6. **GROMMET**

**LAM TOP**

1. **MODEL NUMBER + L**
2. **FSC**
3. **TOP LAM**
4. **GROMMET**

# MODULAR DESK WORKSURFACE

Racetrack

Silea

02/24



D	W	H	model number + type	laminata	veneer 1	veneer 2	veneer 3
30	66	1 3/16	<b>GS2DWRT3066L-</b> [ ]	1,334	1,818	2,000	2,182
30	72	1 3/16	<b>GS2DWRT3072L-</b> [ ]	1,403	1,914	2,106	2,297

• Flat brackets ordered separately (model #MDWBRK)

30	66	1 3/16	<b>GS2DWRT3066R-</b> [ ]	1,334	1,818	2,000	2,182
30	72	1 3/16	<b>GS2DWRT3072R-</b> [ ]	1,403	1,914	2,106	2,297

• Flat brackets ordered separately (model #MDWBRK)

**NOTE:** Desks and Extensions without a full modesty panel and an unsupported area of 48" and greater require a steel worksurface support.

## PRODUCT INFO

Wood tops optional grain direction.

Lam tops optional grain up to 60", above 60" long grain standard.

### Grommet Location (Add \$80 per grommet)

No Grommet **GN**  
 Left **GL**  
 Right **GR**  
 Left & Right **GB**

Specify location first, then select grommet color or "Empty Cutout" option. When "Empty Cutout" option is selected, a grommet or power unit must be ordered separately for each cutout.

## TO ORDER PLEASE SPECIFY THE FOLLOWING:

### WOOD TOP

1. **MODEL NUMBER + W**
2. **FSC**
3. **TOP WOOD FINISH + EDGE**
4. **TOP FINISH**
5. **GRAIN DIRECTION**
6. **GROMMET**

### LAM TOP

1. **MODEL NUMBER + L**
2. **FSC**
3. **TOP LAM**
4. **GRAIN DIRECTION (up to 60")**
5. **GROMMET**

	D	W	H	model number + type	laminate	veneer 1	veneer 2	veneer 3
<b>b SHAPE</b>	42	72	1 3/16	<b>GS2DWB4272-</b> [ ]	2,300	3,141	3,456	3,770



- Flat brackets ordered separately (model #MDWBRK)

<b>d SHAPE</b>	42	72	1 3/16	<b>GS2DWD4272-</b> [ ]	2,300	3,141	3,456	3,770
----------------	----	----	--------	------------------------	-------	-------	-------	-------



- Flat brackets ordered separately (model #MDWBRK)

**NOTE:** Desks and Extensions without a full modesty panel and an unsupported area of 48" and greater require a steel worksurface support.

**PRODUCT INFO**

Wood tops optional grain direction.

Lam tops long grain standard.

**Grommet Location**

(Add \$80 per grommet)

- No Grommet **GN**
- Left **GL**
- Right **GR**
- Left & Right **GB**

Specify location first, then select grommet color or "Empty Cutout" option. When "Empty Cutout" option is selected, a grommet or power unit must be ordered separately for each cutout.

**TO ORDER PLEASE SPECIFY THE FOLLOWING:**

**WOOD TOP**

1. **MODEL NUMBER + W**
2. **FSC**
3. **TOP WOOD FINISH + EDGE**
4. **TOP FINISH**
5. **GRAIN DIRECTION**
6. **GROMMET**





















**LAM TOP**

1. **MODEL NUMBER + L**
2. **FSC**
3. **TOP LAM**
4. **GROMMET**

# MODULAR DESK PEDESTALS

30" & 36"D | Left and Right Hand | w/o Back Panel

Silea  
02/24

	D	W	H	model number + type	laminate	veneer 1	veneer 2	veneer 3
<b>30" DEPTH   9" WIDTH</b>								
 Box/Box/File	29 7/8	9 7/16	27 7/8	<b>GS2DPD309-3S</b> 	1,725	2,181	2,400	2,618
 File/File	29 7/8	9 7/16	27 7/8	<b>GS2DPD309-2S</b> 	1,725	2,181	2,400	2,618
<b>30" DEPTH   15" WIDTH</b>								
 	29 7/8	15	27 7/8	<b>GS2DPD3015-3</b> 	1,725	2,182	2,401	2,619
 	29 7/8	15	27 7/8	<b>GS2DPD3015-2</b> 	1,725	2,182	2,401	2,619
<b>36" DEPTH   9" WIDTH</b>								
 Box/Box/File	35 7/8	9 7/16	27 7/8	<b>GS2DPD369-3S</b> 	1,842	2,332	2,566	2,799
 File/File	35 7/8	9 7/16	27 7/8	<b>GS2DPD369-2S</b> 	1,842	2,332	2,566	2,799
<b>36" DEPTH   15" WIDTH</b>								
 	35 7/8	15	27 7/8	<b>GS2DPD3615-3</b> 	2,038	2,580	2,838	3,096
 	35 7/8	15	27 7/8	<b>GS2DPD3615-2</b> 	2,038	2,580	2,838	3,096

• -3A pedestal has hidden accessory drawer behind top drawer front.

## PRODUCT INFO

No kneewell cutout.  
No pedestal back included.



## TO ORDER PLEASE SPECIFY THE FOLLOWING:

### WOOD CHASSIS

1. MODEL NUMBER + W
2. FSC
3. CHASSIS WOOD FINISH
4. PULL
5. DRAWERS
6. KEYING

### LAM CHASSIS

1. MODEL NUMBER + L
2. FSC
3. CHASSIS LAM
4. FRONT LAM
5. PULL
6. DRAWERS
7. KEYING



	D	W	H	model number + type	laminate	veneer 1	veneer 2	veneer 3
<b>30" DEPTH</b>  Left hand	29 7/8	9 7/16	27 7/8	<b>GS2DPD309L-XN</b> [ ]	948	1,201	1,322	1,442
	29 7/8	9 7/16	27 7/8	<b>GS2DPD309R-XN</b> [ ]	948	1,201	1,322	1,442
	29 7/8	15	27 7/8	<b>GS2DPD3015L-XN</b> [ ]	998	1,791	1,971	2,150
	29 7/8	15	27 7/8	<b>GS2DPD3015R-XN</b> [ ]	998	1,791	1,971	2,150
<b>36" DEPTH</b>  Right hand	35 7/8	9 7/16	27 7/8	<b>GS2DPD369L-XN</b> [ ]	989	1,251	1,377	1,502
	35 7/8	9 7/16	27 7/8	<b>GS2DPD369R-XN</b> [ ]	989	1,251	1,377	1,502
	35 7/8	15	27 7/8	<b>GS2DPD3615L-XN</b> [ ]	1,072	1,354	1,490	1,625
	35 7/8	15	27 7/8	<b>GS2DPD3615R-XN</b> [ ]	1,072	1,354	1,490	1,625

<p><b>PRODUCT INFO</b></p> <p>Removable back panel included.</p>	<p><b>TO ORDER PLEASE SPECIFY THE FOLLOWING:</b></p> <table border="0"> <tr> <td style="vertical-align: top;"> <p>WOOD CHASSIS</p> <ol style="list-style-type: none"> <li>1. <b>MODEL NUMBER + W</b></li> <li>2. <b>FSC</b></li> <li>3. <b>CHASSIS WOOD FINISH</b></li> </ol> </td> <td style="vertical-align: top;"> <p>LAM CHASSIS</p> <ol style="list-style-type: none"> <li>1. <b>MODEL NUMBER + L</b></li> <li>2. <b>FSC</b></li> <li>3. <b>CHASSIS LAM</b></li> </ol> </td> </tr> </table>	<p>WOOD CHASSIS</p> <ol style="list-style-type: none"> <li>1. <b>MODEL NUMBER + W</b></li> <li>2. <b>FSC</b></li> <li>3. <b>CHASSIS WOOD FINISH</b></li> </ol>	<p>LAM CHASSIS</p> <ol style="list-style-type: none"> <li>1. <b>MODEL NUMBER + L</b></li> <li>2. <b>FSC</b></li> <li>3. <b>CHASSIS LAM</b></li> </ol>
<p>WOOD CHASSIS</p> <ol style="list-style-type: none"> <li>1. <b>MODEL NUMBER + W</b></li> <li>2. <b>FSC</b></li> <li>3. <b>CHASSIS WOOD FINISH</b></li> </ol>	<p>LAM CHASSIS</p> <ol style="list-style-type: none"> <li>1. <b>MODEL NUMBER + L</b></li> <li>2. <b>FSC</b></li> <li>3. <b>CHASSIS LAM</b></li> </ol>		

# MODULAR DESK PANEL LEGS

Post | Post w/ Casters | Hoop

Silea  
02/24

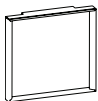
	D	W	H	model number	price
 Post	23 7/8	3	27 7/8	<b>GS2DSL24-N</b>	1,184
	29 7/8	3	27 7/8	<b>GS2DSL30-N</b>	1,222
	35 7/8	3	27 7/8	<b>GS2DSL36-N</b>	1,259
 Post w/casters	23 7/8	3	27 7/8	<b>GS2DSL24-NST</b>	1,446
	29 7/8	3	27 7/8	<b>GS2DSL30-NST</b>	1,486
	35 7/8	3	27 7/8	<b>GS2DSL36-NST</b>	1,522
 Hoop	23 7/8	3	27 7/8	<b>GS2DSL24-H</b>	1,318
	29 7/8	3	27 7/8	<b>GS2DSL30-H</b>	1,357
	35 7/8	3	27 7/8	<b>GS2DSL36-H</b>	1,397

## PRODUCT INFO

24" depth panel legs to be used with 24" depth worksurfaces only.

30" depth panel legs to be used with 30" depth worksurfaces only.

36" depth panel legs to be used with 36" depth worksurfaces only.

Legs made out of aluminum.

## TO ORDER PLEASE SPECIFY THE FOLLOWING:

LIST

1. **MODEL NUMBER**
2. **HARDWARE COLOR**



	D	W	H	model number	list
 Hoop w/glass insert	23 7/8	3	27 7/8	<b>GS2DSL24-G</b>	2,305
	29 7/8	3	27 7/8	<b>GS2DSL30-G</b>	2,674
	35 7/8	3	27 7/8	<b>GS2DSL36-G</b>	2,957



**PRODUCT INFO**

24" depth panel legs to be used with 24" depth worksurfaces only.

30" depth panel legs to be used with 30" depth worksurfaces only.

36" depth panel legs to be used with 36" depth worksurfaces only.

**TO ORDER PLEASE SPECIFY THE FOLLOWING:**

GLASS INSERT

1. **MODEL NUMBER**
2. **HARDWARE COLOR**
3. **GLASS COLOR**

# MODULAR DESK PANEL LEGS

Steel Hoop | Open

Silea

02/24

	D	W	H	model number	part
 Steel hoop	23 7/8	3	27 7/8	<b>GS2DHL24-H</b>	708
	29 7/8	3	27 7/8	<b>GS2DHL30-H</b>	766
	35 7/8	3	27 7/8	<b>GS2DHL36-H</b>	824



## PRODUCT INFO

24" depth panel legs to be used with 24" depth worksurfaces only.

30" depth panel legs to be used with 30" depth worksurfaces only.





36" depth panel legs to be used with 36" depth worksurfaces only.

Leg made out of steel.

## TO ORDER PLEASE SPECIFY THE FOLLOWING:

### LIST

1. **MODEL NUMBER**
2. **HARDWARE COLOR**

	D	W	H	model number	sq ft
 Angled	3	3	27 7/8	<b>GS2ALEG-A</b>	433
 Vertical	3	3	27 7/8	<b>GS2VLEG-A</b>	433
 Trapezoid Column	5	3	27 7/8	<b>GS2COLUMN</b>	1,152
 Round Column	3	3	27 7/8	<b>GS2RNDCOLUMN</b>	505



Angled leg



Vertical



Trapezoid Column

**PRODUCT INFO**

Each model is qty 1.  
Column leg cannot be used in freestanding applications. It must be used in adjoining units.

**TO ORDER PLEASE SPECIFY THE FOLLOWING:**

LIST

1. **MODEL NUMBER**
2. **HARDWARE COLOR**



D	W	H	model number	ISI
3	3	27 7/8	<b>GS2SRNCLEG-W</b>	886



## PRODUCT INFO

Only for use on 30" and 36" deep tops.  
 Not for use on 24" deep tops.  
 Not for use with grommet specified over leg.  
 Model is qty 1.

## TO ORDER PLEASE SPECIFY THE FOLLOWING:

### LIST

1. **MODEL NUMBER**
2. **FSC**
3. **WOOD FINISH**

# MODULAR DESK | RUNOFF MODESTY PANEL

10" high for 9" Pedestals and Panel Legs

	D	W	H	model number + type	laminate	veneer 1	veneer 2	veneer 3
	3/4	38	10	<b>GS2DMPH39-</b> <input type="checkbox"/>	423	532	586	639
	3/4	41	10	<b>GS2DMPH42-</b> <input type="checkbox"/>	437	553	609	664
	3/4	44	10	<b>GS2DMPH45-</b> <input type="checkbox"/>	455	574	632	689
	3/4	47	10	<b>GS2DMPH48-</b> <input type="checkbox"/>	503	635	699	762
	3/4	50	10	<b>GS2DMPH51-</b> <input type="checkbox"/>	522	657	723	789
	3/4	53	10	<b>GS2DMPH54-</b> <input type="checkbox"/>	534	676	744	812
	3/4	56	10	<b>GS2DMPH57-</b> <input type="checkbox"/>	554	697	767	837
	3/4	59	10	<b>GS2DMPH60-</b> <input type="checkbox"/>	592	749	824	899
	3/4	62	10	<b>GS2DMPH63-</b> <input type="checkbox"/>	609	771	849	926
	3/4	65	10	<b>GS2DMPH66-</b> <input type="checkbox"/>	625	792	872	951
	3/4	68	10	<b>GS2DMPH69-</b> <input type="checkbox"/>	657	832	916	999
	3/4	71	10	<b>GS2DMPH72-</b> <input type="checkbox"/>	683	864	951	1,037

**NOTE:** For modesty width calculation, subtract pedestal width or 3" for panel legs from the width of the worksurface.

## PRODUCT INFO

### TO ORDER PLEASE SPECIFY THE FOLLOWING:

#### WOOD CHASSIS

1. **MODEL NUMBER + W**
2. **FSC**
3. **CHASSIS WOOD FINISH**

#### LAM CHASSIS

1. **MODEL NUMBER + L**
2. **FSC**
3. **CHASSIS LAM**

# MODULAR DESK | RUNOFF MODESTY PANEL

10" high for 15" Pedestals

Silea

02/24

	D	W	H	model number + type	laminata	veneer 1	veneer 2	veneer 3
	3/4	24	10	<b>GS2DMPA24-</b> [ ]	381	480	528	576
	3/4	27	10	<b>GS2DMPA27-</b> [ ]	388	491	541	590
	3/4	30	10	<b>GS2DMPA30-</b> [ ]	395	502	553	603
	3/4	33	10	<b>GS2DMPA33-</b> [ ]	403	697	767	837
	3/4	36	10	<b>GS2DMPA36-</b> [ ]	410	741	816	890
	3/4	39	10	<b>GS2DMPA39-</b> [ ]	421	703	774	844
	3/4	42	10	<b>GS2DMPA42-</b> [ ]	437	553	609	664
	3/4	45	10	<b>GS2DMPA45-</b> [ ]	453	574	632	689
	3/4	48	10	<b>GS2DMPA48-</b> [ ]	503	635	699	762
	3/4	51	10	<b>GS2DMPA51-</b> [ ]	519	657	723	789
	3/4	54	10	<b>GS2DMPA54-</b> [ ]	537	676	744	812
	3/4	57	10	<b>GS2DMPA57-</b> [ ]	552	697	767	837
	3/4	60	10	<b>GS2DMPA60-</b> [ ]	592	749	824	899
	3/4	63	10	<b>GS2DMPA63-</b> [ ]	609	771	849	926
	3/4	66	10	<b>GS2DMPA66-</b> [ ]	626	792	872	951
	3/4	69	10	<b>GS2DMPA69-</b> [ ]	657	832	916	999
	3/4	72	10	<b>GS2DMPA72-</b> [ ]	682	864	951	1,037

## PRODUCT INFO

### TO ORDER PLEASE SPECIFY THE FOLLOWING:

#### WOOD CHASSIS

1. **MODEL NUMBER + W**
2. **FSC**
3. **CHASSIS WOOD FINISH**

#### LAM CHASSIS

1. **MODEL NUMBER + L**
2. **FSC**
3. **CHASSIS LAM**

# DOUBLE PED BREAKFRONT MODESTY

For 9" and 15" Pedestals

**FOR 15" PED**

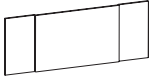

D	W	H	model number + type	laminata	veneer 1	veneer 2	veneer 3
3/4	60	27 7/8	<b>GS2DDMF1560-</b> [ ]	1,075	1,359	1,495	1,631
3/4	66	27 7/8	<b>GS2DDMF1566-</b> [ ]	1,155	1,462	1,609	1,755
3/4	72	27 7/8	<b>GS2DDMF1572-</b> [ ]	1,235	1,563	1,720	1,876
3/4	78	27 7/8	<b>GS2DDMF1578-</b> [ ]	1,317	1,667	1,834	2,001
3/4	84	27 7/8	<b>GS2DDMF1584-</b> [ ]	1,394	1,767	1,944	2,121
3/4	90	27 7/8	<b>GS2DDMF1590-</b> [ ]	1,486	1,854	2,040	2,225
3/4	96	27 7/8	<b>GS2DDMF1596-</b> [ ]	1,562	1,947	2,142	2,337

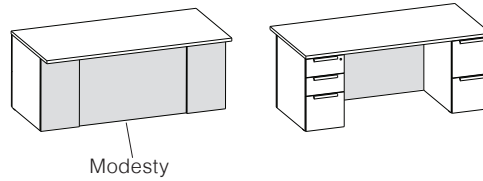

**PRODUCT INFO**

**TO ORDER PLEASE SPECIFY THE FOLLOWING:**

WOOD CHASSIS

1. **MODEL NUMBER + W**
2. **FSC**
3. **CHASSIS WOOD FINISH**

LAM CHASSIS



1. **MODEL NUMBER + L**
2. **FSC**
3. **CHASSIS LAM**

# SINGLE PED BREAKFRONT MODESTY

For 9" and 15" Pedestals

Silea

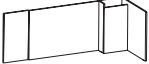
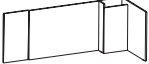
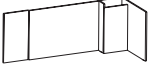
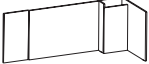
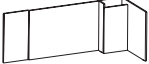
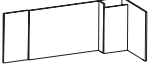
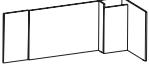
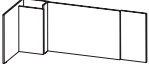
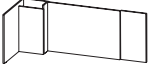
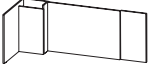
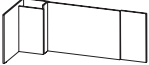
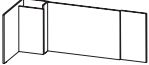
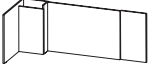
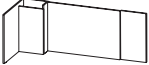
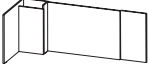
02/24

	D	W	H	model number + type	laminata	veneer 1	veneer 2	veneer 3
<b>FOR 30D X 15" PED</b>  Left hand	29 7/8	60	27 7/8	<b>GS2SDMF1560L-</b> 	1,447	1,832	2,016	2,199
	29 7/8	66	27 7/8	<b>GS2SDMF1566L-</b> 	1,525	1,932	2,126	2,319
	29 7/8	72	27 7/8	<b>GS2SDMF1572L-</b> 	1,601	2,029	2,232	2,435
	29 7/8	78	27 7/8	<b>GS2SDMF1578L-</b> 	1,680	2,128	2,341	2,554
	29 7/8	84	27 7/8	<b>GS2SDMF1584L-</b> 	1,760	2,227	2,450	2,673
	29 7/8	90	27 7/8	<b>GS2SDMF1590L-</b> 	1,874	2,339	2,573	2,807
	29 7/8	96	27 7/8	<b>GS2SDMF1596L-</b> 	1,969	2,455	2,701	2,946
 Right hand	29 7/8	60	27 7/8	<b>GS2SDMF1560R-</b> 	1,447	1,832	2,016	2,199
	29 7/8	66	27 7/8	<b>GS2SDMF1566R-</b> 	1,525	1,932	2,126	2,319
	29 7/8	72	27 7/8	<b>GS2SDMF1572R-</b> 	1,601	2,029	2,232	2,435
	29 7/8	78	27 7/8	<b>GS2SDMF1578R-</b> 	1,680	2,128	2,341	2,554
	29 7/8	84	27 7/8	<b>GS2SDMF1584R-</b> 	1,760	2,227	2,450	2,673
	29 7/8	90	27 7/8	<b>GS2SDMF1590R-</b> 	1,874	2,339	2,573	2,807
	29 7/8	96	27 7/8	<b>GS2SDMF1596R-</b> 	1,969	2,455	2,701	2,946

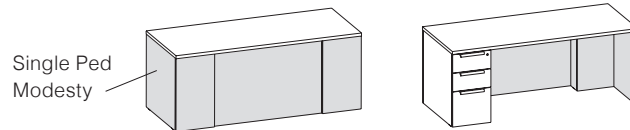

## PRODUCT INFO

### TO ORDER PLEASE SPECIFY THE FOLLOWING:

#### WOOD CHASSIS

1. **MODEL NUMBER + W**
2. **FSC**
3. **CHASSIS WOOD FINISH**

#### LAM CHASSIS

1. **MODEL NUMBER + L**
2. **FSC**
3. **CHASSIS LAM**

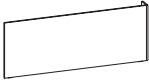

	D	W	H	model number + type	laminata	veneer 1	veneer 2	veneer 3
 Left hand	3/4	42	27 7/8	<b>GS2RRMF42L-</b> [ ]	714	906	997	1,088
	3/4	48	27 7/8	<b>GS2RRMF48L-</b> [ ]	735	930	1,023	1,116
	3/4	54	27 7/8	<b>GS2RRMF54L-</b> [ ]	758	962	1,059	1,155
	3/4	60	27 7/8	<b>GS2RRMF60L-</b> [ ]	783	990	1,089	1,188
	3/4	66	27 7/8	<b>GS2RRMF66L-</b> [ ]	858	1,090	1,199	1,308
	3/4	72	27 7/8	<b>GS2RRMF72L-</b> [ ]	1,135	1,436	1,580	1,724

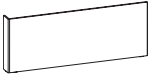
 Right hand	3/4	42	27 7/8	<b>GS2RRMF42R-</b> [ ]	714	906	997	1,088
	3/4	48	27 7/8	<b>GS2RRMF48R-</b> [ ]	735	930	1,023	1,116
	3/4	54	27 7/8	<b>GS2RRMF54R-</b> [ ]	758	962	1,059	1,155
	3/4	60	27 7/8	<b>GS2RRMF60R-</b> [ ]	783	990	1,089	1,188
	3/4	66	27 7/8	<b>GS2RRMF66R-</b> [ ]	858	1,090	1,199	1,308
	3/4	72	27 7/8	<b>GS2RRMF72R-</b> [ ]	1,135	1,436	1,580	1,724

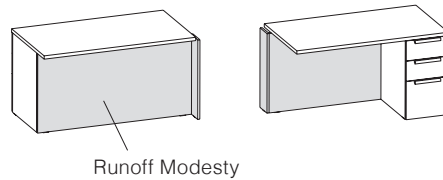

**PRODUCT INFO**

**TO ORDER PLEASE SPECIFY THE FOLLOWING:**

WOOD CHASSIS

1. **MODEL NUMBER + W**
2. **FSC**
3. **CHASSIS WOOD FINISH**

LAM CHASSIS



1. **MODEL NUMBER + L**
2. **FSC**
3. **CHASSIS LAM**

# EXTENSION FULL MODESTY

For use with Racetrack Tops with Column Base

Silea

02/24

	D	W	H	model number + type	laminata	veneer 1	veneer 2	veneer 3
 Left hand	$\frac{3}{4}$	36	$27 \frac{7}{8}$	<b>GS2XMF36L-</b> [ ]	688	870	957	1,044
	$\frac{3}{4}$	42	$27 \frac{7}{8}$	<b>GS2XMF42L-</b> [ ]	714	906	997	1,088
 Right hand	$\frac{3}{4}$	36	$27 \frac{7}{8}$	<b>GS2XMF36R-</b> [ ]	688	870	957	1,044
	$\frac{3}{4}$	42	$27 \frac{7}{8}$	<b>GS2XMF42R-</b> [ ]	714	906	997	1,088

## PRODUCT INFO

Not for use with b and d shape tops

## TO ORDER PLEASE SPECIFY THE FOLLOWING:

### WOOD CHASSIS

1. **MODEL NUMBER + W**
2. **FSC**
3. **CHASSIS WOOD FINISH**

### LAM CHASSIS

1. **MODEL NUMBER + L**
2. **FSC**
3. **CHASSIS LAM**



D	W	H	model number + type	laminata	veneer 1	veneer 2	veneer 3
24	15	1 3/16	GS2CWR2415- [ ]	545	733	807	880
24	18	1 3/16	GS2CWR2418- [ ]	560	751	827	902
24	24	1 3/16	GS2CWR2424- [ ]	574	771	849	926
24	30	1 3/16	GS2CWR2430- [ ]	580	790	869	948
24	36	1 3/16	GS2CWR2436- [ ]	649	885	974	1,062
24	42	1 3/16	GS2CWR2442- [ ]	741	1,008	1,109	1,210
24	48	1 3/16	GS2CWR2448- [ ]	809	1,103	1,214	1,324
24	54	1 3/16	GS2CWR2454- [ ]	853	1,161	1,278	1,394
24	60	1 3/16	GS2CWR2460- [ ]	926	1,262	1,389	1,515
24	66	1 3/16	GS2CWR2466- [ ]	985	1,340	1,474	1,608
24	72	1 3/16	GS2CWR2472- [ ]	1,098	1,499	1,649	1,799
24	78	1 3/16	GS2CWR2478- [ ]	1,144	1,558	1,714	1,870
24	84	1 3/16	GS2CWR2484- [ ]	1,189	1,620	1,782	1,944
24	90	1 3/16	GS2CWR2490- [ ]	1,357	1,848	2,033	2,218
24	96	1 3/16	GS2CWR2496- [ ]	1,486	2,026	2,229	2,432
24	102	1 3/16	GS2CWR24102- [ ]	1,619	2,206	2,427	2,648
24	108	1 3/16	GS2CWR24108- [ ]	1,711	2,331	2,565	2,798
24	114	1 3/16	GS2CWR24114- [ ]	1,776	2,421	2,664	2,906
24	120	1 3/16	GS2CWR24120- [ ]	1,897	2,586	2,845	3,104

• Flat brackets ordered separately (model #MDWBRK)

**NOTE:** Credenzas, returns, and bridges with no back panel and an unsupported area of 48" and greater require an intermediate T support.

**PRODUCT INFO**

Wood tops optional grain direction.  
Lam tops optional grain up to 60", over 60" long grain standard.  
30" and 36" wide worksurface only has GN or GC for grommet option choice.

**Grommet Location**  
(Add \$80 per grommet)

- No Grommet **GN**
- Left **GL**
- Center **GC**
- Right **GR**
- Left & Right **GB**
- All **GA**

Specify location first, then select grommet color or "Empty Cutout" option. When "Empty Cutout" option is selected, a grommet or power unit must be ordered separately for each cutout.

**TO ORDER PLEASE SPECIFY THE FOLLOWING:**

WOOD TOP

1. **MODEL NUMBER + W**
2. **FSC**
3. **TOP WOOD FINISH + EDGE**
4. **TOP FINISH**
5. **GRAIN DIRECTION**
6. **GROMMET**

LAM TOP

1. **MODEL NUMBER + L**
2. **FSC**
3. **TOP LAM**
4. **GRAIN DIRECTION (up to 60")**
5. **EDGE DETAIL**
6. **GROMMET**

# MODULAR 30D TOPS

For Credenzas, Returns, and Bridges

Silea  
02/24

	D	W	H	model number + type	laminata	veneer 1	veneer 2	veneer 3
	30	15	1 3/16	<b>GS2CWR3015-</b> <input type="checkbox"/>	599	806	887	968
	30	18	1 3/16	<b>GS2CWR3018-</b> <input type="checkbox"/>	614	827	910	993
	30	24	1 3/16	<b>GS2CWR3024-</b> <input type="checkbox"/>	631	847	932	1,017
	30	30	1 3/16	<b>GS2CWR3030-</b> <input type="checkbox"/>	647	870	957	1,044
	30	36	1 3/16	<b>GS2CWR3036-</b> <input type="checkbox"/>	724	972	1,070	1,167
	30	42	1 3/16	<b>GS2CWR3042-</b> <input type="checkbox"/>	945	1,289	1,418	1,547
	30	48	1 3/16	<b>GS2CWR3048-</b> <input type="checkbox"/>	995	1,356	1,492	1,628
	30	54	1 3/16	<b>GS2CWR3054-</b> <input type="checkbox"/>	1,007	1,374	1,512	1,649
	30	60	1 3/16	<b>GS2CWR3060-</b> <input type="checkbox"/>	1,020	1,389	1,528	1,667
	30	66	1 3/16	<b>GS2CWR3066-</b> <input type="checkbox"/>	1,068	1,454	1,600	1,745
	30	72	1 3/16	<b>GS2CWR3072-</b> <input type="checkbox"/>	1,124	1,530	1,683	1,836
	30	78	1 3/16	<b>GS2CWR3078-</b> <input type="checkbox"/>	1,201	1,638	1,802	1,966
	30	84	1 3/16	<b>GS2CWR3084-</b> <input type="checkbox"/>	1,286	1,754	1,930	2,105
	30	90	1 3/16	<b>GS2CWR3090-</b> <input type="checkbox"/>	1,370	1,842	2,027	2,211
	30	96	1 3/16	<b>GS2CWR3096-</b> <input type="checkbox"/>	1,438	1,934	2,128	2,321
	30	102	1 3/16	<b>GS2CWR30102-</b> <input type="checkbox"/>	1,700	2,315	2,547	2,778
	30	108	1 3/16	<b>GS2CWR30108-</b> <input type="checkbox"/>	1,796	2,447	2,692	2,937
	30	114	1 3/16	<b>GS2CWR30114-</b> <input type="checkbox"/>	1,866	2,542	2,797	3,051
	30	120	1 3/16	<b>GS2CWR30120-</b> <input type="checkbox"/>	1,994	2,717	2,989	3,261

• Flat brackets ordered separately (model #MDWBRK)

**NOTE:** Credenzas, returns, and bridges with no back panel and an unsupported area of 48" and greater require an intermediate T support.

## PRODUCT INFO

Wood tops optional grain standard.  
Lam tops optional grain up to 60", over 60" long grain standard.  
15" - 36" wide worksurfaces only have GN or GC for grommet option choice.

### Grommet Location (Add \$80 per grommet)

No Grommet **GN**  
Left **GL**  
Center **GC**  
Right **GR**  
Left & Right **GB**  
All **GA**

Specify location first, then select grommet color or "Empty Cutout" option. When "Empty Cutout" option is selected, a grommet or power unit must be ordered separately for each cutout.













## TO ORDER PLEASE SPECIFY THE FOLLOWING:

### WOOD TOP

1. **MODEL NUMBER + W**
2. **FSC**
3. **TOP WOOD FINISH + EDGE**
4. **TOP FINISH**
5. **GRAIN DIRECTION**
6. **GROMMET**

### LAM TOP

1. **MODEL NUMBER + L**
2. **FSC**
3. **TOP LAM**
4. **GRAIN DIRECTION (up to 60")**
5. **EDGE DETAIL**
6. **GROMMET**

	D	W	H	model number + type	laminata	veneer 1	veneer 2	veneer 3
	21	60	1 3/16	<b>GS2CWR2460T-</b> 	1,477	2,061	2,268	2,474
	21	66	1 3/16	<b>GS2CWR2466T-</b> 	1,566	2,185	2,404	2,622
	21	72	1 3/16	<b>GS2CWR2472T-</b> 	1,732	2,426	2,669	2,912
	21	78	1 3/16	<b>GS2CWR2478T-</b> 	1,795	2,516	2,768	3,020
	21	84	1 3/16	<b>GS2CWR2484T-</b> 	1,863	2,612	2,874	3,135
	21	90	1 3/16	<b>GS2CWR2490T-</b> 	2,110	2,965	3,262	3,558
	21	96	1 3/16	<b>GS2CWR2496T-</b> 	2,409	3,272	3,600	3,927
	21	102	1 3/16	<b>GS2CWR24102T-</b> 	2,609	3,554	3,910	4,265
	21	108	1 3/16	<b>GS2CWR24108T-</b> 	2,749	3,745	4,120	4,494
	21	114	1 3/16	<b>GS2CWR24114T-</b> 	2,852	3,885	4,274	4,662
	21	120	1 3/16	<b>GS2CWR24120T-</b> 	3,037	4,142	4,557	4,971

**NOTE:** Credenzas, returns, and bridges with no back panel and an unsupported area of 48" and greater require an intermediate T support.

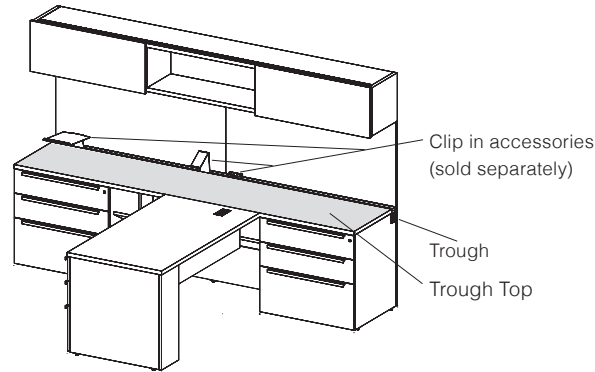

**PRODUCT INFO**

Wood tops optional grain direction.

Lam tops long grain standard.

 Units shipped as separate packages and require field assembly.

Trough tops require filler strips or back panels, ordered separately.

Do not use 2H surface mount towers on trough tops.

**TO ORDER PLEASE SPECIFY THE FOLLOWING:**

**WOOD TOP**

1. **MODEL NUMBER + W**
2. **FSC**
3. **TOP WOOD FINISH**
4. **TOP FINISH**
5. **TROUGH COLOR**
6. **GROMMET**

**LAM TOP**













1. **MODEL NUMBER + L**
2. **FSC**
3. **TOP LAM**
4. **EDGE DETAIL**
5. **TROUGH COLOR**
6. **GROMMET**

# MODULAR 30D TOPS WITH TROUGHS

For Credenzas | w/ 2 End Caps

Silea

02/24

	D	W	H	model number + type	laminate	veneer 1	veneer 2	veneer 3
	30	60	1 3/16	<b>GS2CWR3060T-</b> 	1,522	2,135	2,349	2,562
	30	66	1 3/16	<b>GS2CWR3066T-</b> 	1,613	2,263	2,490	2,716
	30	72	1 3/16	<b>GS2CWR3072T-</b> 	1,787	2,513	2,765	3,016
	30	78	1 3/16	<b>GS2CWR3078T-</b> 	1,850	2,608	2,869	3,130
	30	84	1 3/16	<b>GS2CWR3084T-</b> 	1,921	2,707	2,978	3,249
	30	90	1 3/16	<b>GS2CWR3090T-</b> 	2,176	3,074	3,382	3,689
	30	96	1 3/16	<b>GS2CWR3096T-</b> 	2,483	3,392	3,732	4,071
	30	102	1 3/16	<b>GS2CWR30102T-</b> 	2,692	3,682	4,051	4,419
	30	108	1 3/16	<b>GS2CWR30108T-</b> 	2,838	3,881	4,270	4,658
	30	114	1 3/16	<b>GS2CWR30114T-</b> 	2,942	4,028	4,431	4,834
	30	120	1 3/16	<b>GS2CWR30120T-</b> 	3,132	4,294	4,724	5,153

**NOTE:** Credenzas, returns, and bridges with no back panel and an unsupported area of 48" and greater require an intermediate T support.

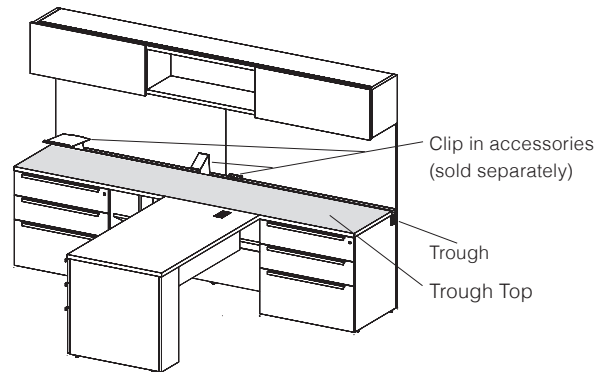

## PRODUCT INFO

Wood tops optional grain direction.

Lam tops long grain standard.

 Units shipped as separate packages and require field assembly.

Trough tops require filler strips or back panels, ordered separately.

Do not use 2H surface mount towers on trough tops.



## TO ORDER PLEASE SPECIFY THE FOLLOWING:

### WOOD TOP

1. **MODEL NUMBER + W**
2. **FSC**
3. **TOP WOOD FINISH + EDGE**
4. **TOP FINISH**
5. **GRAIN DIRECTION**
6. **TROUGH COLOR**

### LAM TOP

1. **MODEL NUMBER + L**
2. **FSC**
3. **TOP LAM**
4. **EDGE DETAIL**
5. **TROUGH COLOR**

	D	W	H	model number + type	laminate	veneer 1	veneer 2	veneer 3
<b>9" WIDTH</b>	23 1/8	9	27 7/8	<b>GS2CPD249L-X</b> <input type="checkbox"/>	857	1,170	1,287	1,404
 False Pedestal								
 Left	23 1/8	9	27 7/8	<b>GS2CPD249R-X</b> <input type="checkbox"/>	857	1,170	1,287	1,404
 Right								

**PRODUCT INFO**

All units have an unfinished back.

Units with an exposed end require a filler strip.

**TO ORDER PLEASE SPECIFY THE FOLLOWING:**

WOOD

1. **MODEL NUMBER + W**
2. **FSC**
3. **CHASSIS WOOD FINISH**

LAM





1. **MODEL NUMBER + L**
2. **FSC**
3. **CHASSIS LAM**

# MODULAR PEDS 24D

Standard Height | 15" and 18"W

Silea

02/24

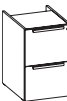
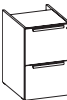
	D	W	H	model number + type	laminate	veneer 1	veneer 2	veneer 3
<b>15" WIDTH</b>								
 Box   Box   File	23 1/8	15	27 7/8	<b>GS2CPD2415-3</b> [ ]	1,723	2,346	2,581	2,816
 Hidden Accessory   Hidden Accessory   Box   File	23 1/8	15	27 7/8	<b>GS2CPD2415-3A</b> [ ]	1,723	2,346	2,581	2,816
 File   File	23 1/8	15	27 7/8	<b>GS2CPD2415-2</b> [ ]	1,723	2,346	2,581	2,816
<b>18" WIDTH</b>								
 Box   Box   File	23 1/8	18	27 7/8	<b>GS2CPD2418-3</b> [ ]	1,842	2,512	2,764	3,015
 Hidden Accessory   Hidden Accessory   Box   File	23 1/8	18	27 7/8	<b>GS2CPD2418-3A</b> [ ]	1,842	2,512	2,764	3,015
 File   File	23 1/8	18	27 7/8	<b>GS2CPD2418-2</b> [ ]	1,842	2,512	2,764	3,015

## PRODUCT INFO

All units have an unfinished back.

All pedestals with an exposed side require a filler strip or pedestal back.

## TO ORDER PLEASE SPECIFY THE FOLLOWING:







### WOOD

1. **MODEL NUMBER + W**
2. **FSC**
3. **CHASSIS WOOD FINISH**
4. **PULL**
5. **DRAWERS**
6. **KEYING**

### LAM

1. **MODEL NUMBER + L**
2. **FSC**
3. **CHASSIS LAM**
4. **FRONT LAM**
5. **PULL**
6. **DRAWERS**
7. **KEYING**

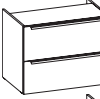
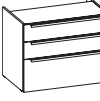

	D	W	H	model number + type	laminata	veneer 1	veneer 2	veneer 3	
<b>30" WIDTH</b>									
 File   File	23 1/8	30	27 7/8	<b>GS2CPD2430-4</b> <input type="checkbox"/>	2,160	2,944	3,239	3,533	
 Box   Box   File	23 1/8	30	27 7/8	<b>GS2CPD2430-7</b> <input type="checkbox"/>	2,203	3,003	3,304	3,604	
 Multi-File Left	23 1/8	30	27 7/8	<b>GS2CPD2430L-MF</b> <input type="checkbox"/>	2,299	3,091	3,401	3,710	
 Multi-File Right	23 1/8	30	27 7/8	<b>GS2CPD2430R-MF</b> <input type="checkbox"/>	2,299	3,091	3,401	3,710	
<b>36" WIDTH</b>									
 File   File	23 1/8	36	27 7/8	<b>GS2CPD2436-4</b> <input type="checkbox"/>	2,377	3,239	3,563	3,887	
 Box   Box   File	23 1/8	36	27 7/8	<b>GS2CPD2436-7</b> <input type="checkbox"/>	2,423	3,303	3,634	3,964	
 Multi-File Left	23 1/8	36	27 7/8	<b>GS2CPD2436L-MF</b> <input type="checkbox"/>	2,529	3,400	3,740	4,080	
 Multi-File Right	23 1/8	36	27 7/8	<b>GS2CPD2436R-MF</b> <input type="checkbox"/>	2,529	3,400	3,740	4,080	

**PRODUCT INFO**

All units have an unfinished back.  
All pedestals with an exposed side require a filler strip or pedestal back.

**TO ORDER PLEASE SPECIFY THE FOLLOWING:**

WOOD

1. **MODEL NUMBER + W**
2. **FSC**
3. **CHASSIS WOOD FINISH**
4. **PULL**
5. **DRAWERS**
6. **KEYING**

LAM







1. **MODEL NUMBER + L**
2. **FSC**
3. **CHASSIS LAM**
4. **FRONT LAM**
5. **PULL**
6. **DRAWERS**
7. **KEYING**

# MODULAR PEDS 24D

Standard Height | Hinged Door Cabinets

Silea

02/24

	D	W	H	model number + type	laminate	veneer 1	veneer 2	veneer 3
<b>15" WIDTH</b>								
 Left Hand	23 1/8	15	27 7/8	<b>GS2CPD2415L-5</b> <input type="checkbox"/>	1,482	1,992	2,192	2,391
Right Hand	23 1/8	15	27 7/8	<b>GS2CPD2415R-5</b> <input type="checkbox"/>	1,482	1,992	2,192	2,391
<b>18" WIDTH</b>								
 Left Hand	23 1/8	18	27 7/8	<b>GS2CPD2418L-5</b> <input type="checkbox"/>	1,555	2,090	2,299	2,508
Right Hand	23 1/8	18	27 7/8	<b>GS2CPD2418R-5</b> <input type="checkbox"/>	1,555	2,090	2,299	2,508
<b>24" WIDTH</b>								
 Double Door	23 1/8	24	27 7/8	<b>GS2CPD2424-5</b> <input type="checkbox"/>	1,774	2,385	2,624	2,862
<b>30" WIDTH</b>								
 Double Door	23 1/8	30	27 7/8	<b>GS2CPD2430-5</b> <input type="checkbox"/>	1,944	2,651	2,917	3,182
 With Printer Drawer	23 1/8	30	27 7/8	<b>GS2CPD2430-P</b> <input type="checkbox"/>	2,072	2,784	3,063	3,341
<b>36" WIDTH</b>								
 Double Door	23 1/8	36	27 7/8	<b>GS2CPD2436-5</b> <input type="checkbox"/>	2,137	2,916	3,208	3,500
 With Printer Drawer	23 1/8	36	27 7/8	<b>GS2CPD2436-P</b> <input type="checkbox"/>	2,277	3,060	3,366	3,672

## PRODUCT INFO

All units have an unfinished back.

If integral pull is chosen, doors will be touch latch.

All pedestals with an exposed side require a filler strip or pedestal back.

Includes one adjustable shelf.





## TO ORDER PLEASE SPECIFY THE FOLLOWING:

### WOOD

1. **MODEL NUMBER + W**
2. **FSC**
3. **CHASSIS WOOD FINISH**
4. **PULL**
5. **KEYING**

### LAM

1. **MODEL NUMBER + L**
2. **FSC**
3. **CHASSIS LAM**
4. **FRONT LAM**
5. **PULL**
6. **KEYING**

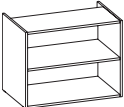
	D	W	H	model number + type	laminata	veneer 1	veneer 2	veneer 3
<b>15" WIDTH</b> 	23 1/8	15	27 7/8	<b>GS2CPD2415-SH</b> <input type="checkbox"/>	1,333	1,791	1,971	2,150
<b>18" WIDTH</b> 	23 1/8	18	27 7/8	<b>GS2CPD2418-SH</b> <input type="checkbox"/>	1,399	1,881	2,070	2,258
<b>24" WIDTH</b> 	23 1/8	24	27 7/8	<b>GS2CPD2424-SH</b> <input type="checkbox"/>	1,604	2,157	2,373	2,589
<b>30" WIDTH</b> 	23 1/8	30	27 7/8	<b>GS2CPD2430-SH</b> <input type="checkbox"/>	1,758	2,395	2,635	2,874
<b>36" WIDTH</b> 	23 1/8	36	27 7/8	<b>GS2CPD2436-SH</b> <input type="checkbox"/>	1,937	2,637	2,901	3,165

**PRODUCT INFO**

All units have an unfinished back.  
 All pedestals with an exposed side require a filler strip or pedestal back.  
 Adjustable shelf.

**TO ORDER PLEASE SPECIFY THE FOLLOWING:**

WOOD

1. **MODEL NUMBER + W**
2. **FSC**
3. **CHASSIS WOOD FINISH**

LAM





1. **MODEL NUMBER + L**
2. **FSC**
3. **CHASSIS LAM**

# TROUGH MODULAR PEDS 24D

Standard Height | 9"W | Trough Cutouts

Silea

02/24

	D	W	H	model number + type	laminate	veneer 1	veneer 2	veneer 3
<b>9" WIDTH</b>	23 1/8	9	27 7/8	<b>GS2CPD249TL-X</b> 	857	1,170	1,287	1,404
 False Pedestal								
 Left	23 1/8	9	27 7/8	<b>GS2CPD249TR-X</b> 	857	1,170	1,287	1,404
 Right								

## PRODUCT INFO

Pedestals to be used with a modular trough top.

All units have an unfinished back.

All trough pedestals require a filler strip or pedestal back.







## TO ORDER PLEASE SPECIFY THE FOLLOWING:

### WOOD

- MODEL NUMBER + W**
- FSC**
- CHASSIS WOOD FINISH**

### LAM

- MODEL NUMBER + L**
- FSC**
- CHASSIS LAM**

	D	W	H	model number + type	laminate	veneer 1	veneer 2	veneer 3	
<b>15" WIDTH</b>									
 Box   Box   File	23 1/8	15	27 7/8	<b>GS2CPD2415T-3</b> [ ]	1,723	2,346	2,581	2,816	
 Hidden Accessory   Hidden Accessory   Box   File	23 1/8	15	27 7/8	<b>GS2CPD2415T-3A</b> [ ]	1,723	2,346	2,581	2,816	
 File   File	23 1/8	15	27 7/8	<b>GS2CPD2415T-2</b> [ ]	1,723	2,346	2,581	2,816	
<b>18" WIDTH</b>									
 Box   Box   File	23 1/8	18	27 7/8	<b>GS2CPD2418T-3</b> [ ]	1,842	2,512	2,764	3,015	
 Hidden Accessory   Hidden Accessory   Box   File	23 1/8	18	27 7/8	<b>GS2CPD2418T-3A</b> [ ]	1,842	2,512	2,764	3,015	
 File   File	23 1/8	18	27 7/8	<b>GS2CPD2418T-2</b> [ ]	1,842	2,512	2,764	3,015	

**PRODUCT INFO**

All units have an unfinished back.  
Pedestals to be used with a modular trough top.  
All trough pedestals require a filler strip or pedestal back.

**TO ORDER PLEASE SPECIFY THE FOLLOWING:**

WOOD

1. **MODEL NUMBER + W**
2. **FSC**
3. **CHASSIS WOOD FINISH**
4. **PULL**
5. **DRAWERS**
6. **KEYING**





LAM

1. **MODEL NUMBER + L**
2. **FSC**
3. **CHASSIS LAM**
4. **FRONT LAM**
5. **PULL**
6. **DRAWERS**
7. **KEYING**

# TROUGH MODULAR PEDS 24D

Standard Height | 30" and 36"W | Trough Cutouts

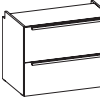
Silea  
02/24

		D	W	H	model number + type	laminate	veneer 1	veneer 2	veneer 3
<b>30" WIDTH</b>									
	File   File	23 1/8	30	27 7/8	<b>GS2CPD2430T-4</b> <input type="checkbox"/>	2,160	2,944	3,239	3,533
	Box   Box   File	23 1/8	30	27 7/8	<b>GS2CPD2430T-7</b> <input type="checkbox"/>	2,203	3,003	3,304	3,604
	Multi-File Left	23 1/8	30	27 7/8	<b>GS2CPD2430TL-MF</b> <input type="checkbox"/>	2,299	3,091	3,401	3,710
	Multi-File Right	23 1/8	30	27 7/8	<b>GS2CPD2430TR-MF</b> <input type="checkbox"/>	2,299	3,091	3,401	3,710
<b>36" WIDTH</b>									
	File   File	23 1/8	36	27 7/8	<b>GS2CPD2436T-4</b> <input type="checkbox"/>	2,377	3,239	3,563	3,887
	Box   Box   File	23 1/8	36	27 7/8	<b>GS2CPD2436T-7</b> <input type="checkbox"/>	2,423	3,303	3,634	3,964
	Multi-File Left	23 1/8	36	27 7/8	<b>GS2CPD2436TL-MF</b> <input type="checkbox"/>	2,529	3,400	3,740	4,080
	Multi-File Right	23 1/8	36	27 7/8	<b>GS2CPD2436TR-MF</b> <input type="checkbox"/>	2,529	3,400	3,740	4,080

## PRODUCT INFO

All units have an unfinished back.

Pedestals to be used with a modular trough top.

All trough pedestals require a filler strip or pedestal back.







## TO ORDER PLEASE SPECIFY THE FOLLOWING:

### WOOD

1. **MODEL NUMBER + W**
2. **FSC**
3. **CHASSIS WOOD FINISH**
4. **PULL**
5. **DRAWERS**
6. **KEYING**

### LAM

1. **MODEL NUMBER + L**
2. **FSC**
3. **CHASSIS LAM**
4. **FRONT LAM**
5. **PULL**
6. **DRAWERS**
7. **KEYING**

	D	W	H	model number + type	laminate	veneer 1	veneer 2	veneer 3	
<b>15" WIDTH</b>									
 Left Hand	23 1/8	15	27 7/8	<b>GS2CPD2415TL-5</b> <input type="checkbox"/>	1,482	1,992	2,192	2,391	
Right Hand	23 1/8	15	27 7/8	<b>GS2CPD2415TR-5</b> <input type="checkbox"/>	1,482	1,992	2,192	2,391	
<b>18" WIDTH</b>									
 Left Hand	23 1/8	18	27 7/8	<b>GS2CPD2418TL-5</b> <input type="checkbox"/>	1,555	2,090	2,299	2,508	
Right Hand	23 1/8	18	27 7/8	<b>GS2CPD2418TR-5</b> <input type="checkbox"/>	1,555	2,090	2,299	2,508	
<b>24" WIDTH</b>									
 Double Door	23 1/8	24	27 7/8	<b>GS2CPD2424T-5</b> <input type="checkbox"/>	1,774	2,385	2,624	2,862	
<b>30" WIDTH</b>									
 Double Door	23 1/8	30	27 7/8	<b>GS2CPD2430T-5</b> <input type="checkbox"/>	1,944	2,651	2,917	3,182	
 With Printer Drawer	23 1/8	30	27 7/8	<b>GS2CPD2430T-P</b> <input type="checkbox"/>	2,072	2,784	3,063	3,341	
<b>36" WIDTH</b>									
 Double Door	23 1/8	36	27 7/8	<b>GS2CPD2436T-5</b> <input type="checkbox"/>	2,137	2,916	3,208	3,500	
 With Printer Drawer	23 1/8	36	27 7/8	<b>GS2CPD2436T-P</b> <input type="checkbox"/>	2,277	3,060	3,366	3,672	

**PRODUCT INFO**

All units have an unfinished back.  
 Pedestals to be used with a modular trough top.  
 If integral pull is chosen, doors will be touch latch.  
 All trough pedestals require a filler strip or pedestal back.  
 Includes one adjustable shelf.

**TO ORDER PLEASE SPECIFY THE FOLLOWING:**

WOOD

1. **MODEL NUMBER + W**
2. **FSC**
3. **CHASSIS WOOD FINISH**
4. **PULL**
5. **KEYING**





LAM

1. **MODEL NUMBER + L**
2. **FSC**
3. **CHASSIS LAM**
4. **FRONT LAM**
5. **PULL**
6. **KEYING**

# TROUGH MODULAR PEDS 24D

Standard Height | Open Shelf | Trough Cutouts

Silea  
02/24

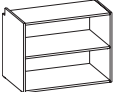
	D	W	H	model number + type	laminate	veneer 1	veneer 2	veneer 3
<b>15" WIDTH</b> 	23 1/8	15	27 7/8	<b>GS2CPD2415T-SH</b> [ ]	1,333	1,791	1,971	2,150
<b>18" WIDTH</b> 	23 1/8	18	27 7/8	<b>GS2CPD2418T-SH</b> [ ]	1,399	1,881	2,070	2,258
<b>24" WIDTH</b> 	23 1/8	24	27 7/8	<b>GS2CPD2424T-SH</b> [ ]	1,604	2,157	2,373	2,589
<b>30" WIDTH</b> 	23 1/8	30	27 7/8	<b>GS2CPD2430T-SH</b> [ ]	1,758	2,395	2,635	2,874
<b>36" WIDTH</b> 	23 1/8	36	27 7/8	<b>GS2CPD2436T-SH</b> [ ]	1,937	2,637	2,901	3,165

## PRODUCT INFO

All units have an unfinished back.

Pedestals to be used with a modular trough top.

All trough pedestals require a filler strip or pedestal back.

Adjustable shelf.

## TO ORDER PLEASE SPECIFY THE FOLLOWING:



### WOOD

1. **MODEL NUMBER + W**
2. **FSC**
3. **CHASSIS WOOD FINISH**

### LAM

1. **MODEL NUMBER + L**
2. **FSC**
3. **CHASSIS LAM**



	D	W	H	model number + type	laminata	veneer 1	veneer 2	veneer 3
<b>9" WIDTH</b>	23 1/8	9	20 3/4	<b>GS2CLPD249L-X</b> [ ]	818	1,111	1,223	1,334
 False Pedestal								
 Left	23 1/8	9	20 3/4	<b>GS2CLPD249R-X</b> [ ]	818	1,111	1,223	1,334
 Right								

**PRODUCT INFO**

All units have an unfinished back.  
Units with an exposed end require a filler strip.

**TO ORDER PLEASE SPECIFY THE FOLLOWING:**

WOOD

1. **MODEL NUMBER + W**
2. **FSC**
3. **CHASSIS WOOD FINISH**



LAM

1. **MODEL NUMBER + L**
2. **FSC**
3. **CHASSIS LAM**

# MODULAR PEDS 24D

Layers Height | 15" and 18"W

Silea  
02/24

	D	W	H	model number + type	laminata	veneer 1	veneer 2	veneer 3
<b>15" WIDTH</b>	23 1/8	15	20 3/4	<b>GS2CLPD2415-A</b> [ ]	1,636	2,228	2,451	2,674
 Box/File								
<b>18" WIDTH</b>	23 1/8	18	20 3/4	<b>GS2CLPD2418-A</b> [ ]	1,749	2,389	2,628	2,867
 Box/File								

## PRODUCT INFO

All units have an unfinished back.

All pedestals with an exposed side require a filler strip or pedestal back.

Layers pedestals may be used with feet or on glides to the floor.

Glides must be removed at install for feet applications.



## TO ORDER PLEASE SPECIFY THE FOLLOWING:

### WOOD

1. **MODEL NUMBER + W**
2. **FSC**
3. **CHASSIS WOOD FINISH**
4. **PULL**
5. **DRAWERS**
6. **KEYING**

### LAM

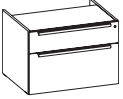
1. **MODEL NUMBER + L**
2. **FSC**
3. **CHASSIS LAM**
4. **FRONT LAM**
5. **PULL**
6. **DRAWERS**
7. **KEYING**

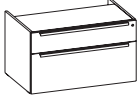
	D	W	H	model number + type	laminata	veneer 1	veneer 2	veneer 3
<b>30" WIDTH</b>	23 1/8	30	20 3/4	<b>GS2CLPD2430-B</b> 	2,052	2,797	3,077	3,357
 Box/File								
<b>36" WIDTH</b>	23 1/8	36	20 3/4	<b>GS2CLPD2436-B</b> 	2,258	3,077	3,385	3,693
 Box/File								

**PRODUCT INFO**

All units have an unfinished back.  
 All pedestals with an exposed side require a filler strip or pedestal back.  
 Layers pedestals may be used with feet or on glides to the floor.  
 Glides must be removed at install for feet applications.

**TO ORDER PLEASE SPECIFY THE FOLLOWING:**

WOOD

1. **MODEL NUMBER + W**
2. **FSC**
3. **CHASSIS WOOD FINISH**
4. **PULL**
5. **DRAWERS**
6. **KEYING**



LAM

1. **MODEL NUMBER + L**
2. **FSC**
3. **CHASSIS LAM**
4. **FRONT LAM**
5. **PULL**
6. **DRAWERS**
7. **KEYING**

# MODULAR PEDS 24D

Layers Height | 30" and 36"W

Silea  
02/24

	D	W	H	model number + type	laminate	veneer 1	veneer 2	veneer 3
<b>30" WIDTH</b>	23 1/8	30	20 3/4	<b>GS2CLPD2430-5</b> [ ]	1,846	2,518	2,770	3,022
 Hinged door								
<b>36" WIDTH</b>	23 1/8	36	20 3/4	<b>GS2CLPD2436-5</b> [ ]	2,032	2,769	3,046	3,323
 Hinged door								

## PRODUCT INFO

All units have an unfinished back.

If integral pull is chosen, doors will be touch latch.

All pedestals with an exposed side require a filler strip or pedestal back.

Includes one adjustable shelf.

Layers pedestals may be used with feet or on glides to the floor.

Glides must be removed at install for feet applications.

## TO ORDER PLEASE SPECIFY THE FOLLOWING:

### WOOD

1. **MODEL NUMBER + W**
2. **FSC**
3. **CHASSIS WOOD FINISH**
4. **PULL**
5. **KEYING**

### LAM

1. **MODEL NUMBER + L**
2. **FSC**
3. **CHASSIS LAM**
4. **FRONT LAM**
5. **PULL**
6. **KEYING**

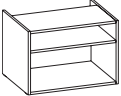
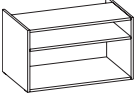
	D	W	H	model number + type	laminate	veneer 1	veneer 2	veneer 3
<b>30" WIDTH</b>  Bookcase	23 1/8	30	20 3/4	<b>GS2CLPD2430-SH</b> <input type="checkbox"/>	1,672	2,277	2,505	2,733
<b>36" WIDTH</b>  Bookcase	23 1/8	36	20 3/4	<b>GS2CLPD2436-SH</b> <input type="checkbox"/>	1,838	2,504	2,755	3,005

**PRODUCT INFO**

All units have an unfinished back.  
 All pedestals with an exposed side require a filler strip or pedestal back.  
 Adjustable shelf.  
 Layers pedestals may be used with feet or on glides to the floor.  
 Glides must be removed at install for feet applications.

**TO ORDER PLEASE SPECIFY THE FOLLOWING:**





- |                               |                            |
|-------------------------------|----------------------------|
| WOOD                          | LAM                        |
| 1. <b>MODEL NUMBER + W</b>    | 1. <b>MODEL NUMBER + L</b> |
| 2. <b>FSC</b>                 | 2. <b>FSC</b>              |
| 3. <b>CHASSIS WOOD FINISH</b> | 3. <b>CHASSIS LAM</b>      |

# TROUGH MODULAR PEDS 24D

Layers Height | 9"W | Trough Cutouts

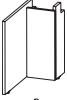
Silea

02/24

	D	W	H	model number + type	laminate	veneer 1	veneer 2	veneer 3
<b>9" WIDTH</b>	23 1/8	9	20 3/4	<b>GS2CLPD249TL-X</b> 	818	1,111	1,223	1,334
 False Pedestal								
 Left	23 1/8	9	20 3/4	<b>GS2CLPD249TR-X</b> 	818	1,111	1,223	1,334
 Right								

## PRODUCT INFO

Pedestals is to be used with a modular trough top.

All units have an unfinished back.

All trough pedestals require a filler strip or pedestal back.



## TO ORDER PLEASE SPECIFY THE FOLLOWING:

### WOOD

- MODEL NUMBER + W**
- FSC**
- CHASSIS WOOD FINISH**

### LAM

- MODEL NUMBER + L**
- FSC**
- CHASSIS LAM**

	D	W	H	model number + type	laminata	veneer 1	veneer 2	veneer 3
<b>15" WIDTH</b>  Box/File	23 1/8	15	20 3/4	<b>GS2CLPD2415T-A</b> [ ]	1,636	2,228	2,451	2,674
<b>18" WIDTH</b>  Box/File	23 1/8	18	20 3/4	<b>GS2CLPD2418T-A</b> [ ]	1,749	2,389	2,628	2,867

**PRODUCT INFO**

All units have an unfinished back.  
 Pedestals to be used with a modular trough top.  
 All trough pedestals require a filler strip or pedestal back.  
 Layers pedestals may be used with feet or on glides to the floor.  
 Glides must be removed at install for feet applications.

**TO ORDER PLEASE SPECIFY THE FOLLOWING:**

**WOOD**

1. **MODEL NUMBER + W**
2. **FSC**
3. **CHASSIS WOOD FINISH**
4. **PULL**
5. **DRAWERS**
6. **KEYING**

**LAM**

1. **MODEL NUMBER + L**
2. **FSC**
3. **CHASSIS LAM**
4. **FRONT LAM**
5. **PULL**
6. **DRAWERS**
7. **KEYING**

# TROUGH MODULAR PEDS 24D

Layers Height | 30" and 36"W | Trough Cutouts

Silea  
02/24

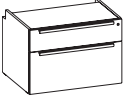
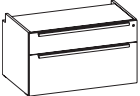
	D	W	H	model number + type	laminate	veneer 1	veneer 2	veneer 3
<b>30" WIDTH</b>  Box/File	23 1/8	30	20 3/4	<b>GS2CLPD2430T-B</b> [ ]	2,052	2,797	3,077	3,357
<b>36" WIDTH</b>  Box/File	23 1/8	36	20 3/4	<b>GS2CLPD2436T-B</b> [ ]	2,258	3,077	3,385	3,693

## PRODUCT INFO

All units have an unfinished back.

Pedestals to be used with a modular trough top.

All trough pedestals require a filler strip or pedestal back.

Layers pedestals may be used with feet or on glides to the floor.

Glides must be removed at install for feet applications.

## TO ORDER PLEASE SPECIFY THE FOLLOWING:



### WOOD

1. **MODEL NUMBER + W**
2. **FSC**
3. **CHASSIS WOOD FINISH**
4. **PULL**
5. **DRAWERS**
6. **KEYING**

### LAM

1. **MODEL NUMBER + L**
2. **FSC**
3. **CHASSIS LAM**
4. **FRONT LAM**
5. **PULL**
6. **DRAWERS**
7. **KEYING**



	D	W	H	model number + type	laminate	veneer 1	veneer 2	veneer 3
<b>30" WIDTH</b>	23 1/8	30	20 3/4	<b>GS2CLPD2430T-5</b> [ ]	1,846	2,518	2,770	3,022
 Hinged door								
<b>36" WIDTH</b>	23 1/8	36	20 3/4	<b>GS2CLPD2436T-5</b> [ ]	2,032	2,769	3,046	3,323
 Hinged door								

**PRODUCT INFO**

All units have an unfinished back.  
 Pedestals to be used with a modular trough top.  
 If integral pull is chosen, doors will be touch latch.  
 All trough pedestals require a filler strip or pedestal back.  
 Includes one adjustable shelf.  
 Layers pedestals may be used with feet or on glides to the floor.  
 Glides must be removed at install for feet applications.

**TO ORDER PLEASE SPECIFY THE FOLLOWING:**

WOOD

1. **MODEL NUMBER + W**
2. **FSC**
3. **CHASSIS WOOD FINISH**
4. **PULL**
5. **KEYING**

LAM

1. **MODEL NUMBER + L**
2. **FSC**
3. **CHASSIS LAM**
4. **FRONT LAM**
5. **PULL**
6. **KEYING**

# TROUGH MODULAR PEDS 24D

Layers Height | 30" and 36"W | Trough Cutouts

Silea  
02/24

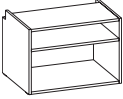
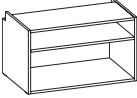
	D	W	H	model number + type	laminat	veneer 1	veneer 2	veneer 3
<b>30" WIDTH</b>	23 1/8	30	20 3/4	<b>GS2CLPD2430T-SH</b> [ ]	1,672	2,277	2,505	2,733
 Bookcase								
<b>36" WIDTH</b>	23 1/8	36	20 3/4	<b>GS2CLPD2436T-SH</b> [ ]	1,838	2,504	2,755	3,005
 Bookcase								

## PRODUCT INFO

All units have an unfinished back.  
 Pedestals to be used with a modular trough top.  
 All trough pedestals require a filler strip or pedestal back.  
 Adjustable shelf.  
 Layers pedestals may be used with feet or on glides to the floor.  
 Glides must be removed at install for feet applications.



## TO ORDER PLEASE SPECIFY THE FOLLOWING:

### WOOD

- MODEL NUMBER + W**
- FSC**
- CHASSIS WOOD FINISH**

### LAM

- MODEL NUMBER + L**
- FSC**
- CHASSIS LAM**

	D	W	H	model number + type	laminate	veneer 1	veneer 2	veneer 3
<b>9" WIDTH</b>	29 1/8	9	27 7/8	<b>GS2CPD309L-X</b> [ ]	944	1,288	1,417	1,546
 False Pedestal								
 Left	29 1/8	9	27 7/8	<b>GS2CPD309R-X</b> [ ]	944	1,288	1,417	1,546
 Right								

**PRODUCT INFO**

All units have an unfinished back.

Units with an exposed end require a filler strip.

**TO ORDER PLEASE SPECIFY THE FOLLOWING:**

WOOD CHASSIS

1. **MODEL NUMBER + W**
2. **FSC**
3. **CHASSIS WOOD FINISH**

LAM CHASSIS





1. **MODEL NUMBER + L**
2. **FSC**
3. **CHASSIS LAM**

# MODULAR PEDS 30D

Standard Height | 15" and 18"W

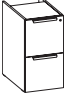
Silea

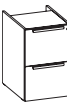
02/24

	D	W	H	model number + type	laminate	veneer 1	veneer 2	veneer 3	
<b>15" WIDTH</b>									
 Box   Box   File	29 1/8	15	27 7/8	<b>GS2CPD3015-3</b> [ ]	1,894	2,580	2,838	3,096	
 Hidden Accessory   Hidden Accessory   Box   File	29 1/8	15	27 7/8	<b>GS2CPD3015-3A</b> [ ]	1,894	2,580	2,838	3,096	
 File   File	29 1/8	15	27 7/8	<b>GS2CPD3015-2</b> [ ]	1,894	2,580	2,838	3,096	
<b>18" WIDTH</b>									
 Box   Box   File	29 1/8	18	27 7/8	<b>GS2CPD3018-3</b> [ ]	2,027	2,764	3,041	3,317	
 Hidden Accessory   Hidden Accessory   Box   File	29 1/8	18	27 7/8	<b>GS2CPD3018-3A</b> [ ]	2,027	2,764	3,041	3,317	
 File   File	29 1/8	18	27 7/8	<b>GS2CPD3018-2</b> [ ]	2,027	2,764	3,041	3,317	

## PRODUCT INFO

All units have an unfinished back.

Units with an exposed end require a filler strip.









## TO ORDER PLEASE SPECIFY THE FOLLOWING:

### WOOD CHASSIS

1. **MODEL NUMBER + W**
2. **FSC**
3. **CHASSIS WOOD FINISH**
4. **PULL**
5. **DRAWERS**
6. **KEYING**

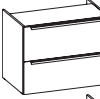
### LAM CHASSIS

1. **MODEL NUMBER + L**
2. **FSC**
3. **CHASSIS LAM**
4. **FRONT LAM**
5. **PULL**
6. **DRAWERS**
7. **KEYING**

	D	W	H	model number + type	laminate	veneer 1	veneer 2	veneer 3	
<b>30" WIDTH</b>									
 File   File	29 1/8	30	27 7/8	<b>GS2CPD3030-4</b> <input type="checkbox"/>	2,378	3,239	3,563	3,887	
 Box   Box   File	29 1/8	30	27 7/8	<b>GS2CPD3030-7</b> <input type="checkbox"/>	2,423	3,304	3,635	3,965	
 Multi-File Left	29 1/8	30	27 7/8	<b>GS2CPD3030L-MF</b> <input type="checkbox"/>	2,529	3,400	3,740	4,080	
 Multi-File Right	29 1/8	30	27 7/8	<b>GS2CPD3030R-MF</b> <input type="checkbox"/>	2,529	3,400	3,740	4,080	
<b>36" WIDTH</b>									
 File   File	29 1/8	36	27 7/8	<b>GS2CPD3036-4</b> <input type="checkbox"/>	2,614	3,562	3,919	4,275	
 Box   Box   File	29 1/8	36	27 7/8	<b>GS2CPD3036-7</b> <input type="checkbox"/>	2,667	3,633	3,997	4,360	
 Multi-File Left	29 1/8	36	27 7/8	<b>GS2CPD3036L-MF</b> <input type="checkbox"/>	2,783	3,741	4,116	4,490	
 Multi-File Right	29 1/8	36	27 7/8	<b>GS2CPD3036R-MF</b> <input type="checkbox"/>	2,783	3,741	4,116	4,490	

**PRODUCT INFO**

All units have an unfinished back.

Units with an exposed end require a filler strip.

**TO ORDER PLEASE SPECIFY THE FOLLOWING:**

WOOD CHASSIS

1. **MODEL NUMBER + W**
2. **FSC**
3. **CHASSIS WOOD FINISH**
4. **PULL**
5. **DRAWERS**
6. **KEYING**







LAM CHASSIS

1. **MODEL NUMBER + L**
2. **FSC**
3. **CHASSIS LAM**
4. **FRONT LAM**
5. **PULL**
6. **DRAWERS**
7. **KEYING**

# MODULAR PEDS 30D

Standard Height | Hinged Door Cabinets

Silea  
02/24

	D	W	H	model number + type	laminate	veneer 1	veneer 2	veneer 3
<b>15" WIDTH</b>								
 Left Hand	29 1/8	15	27 7/8	<b>GS2CPD3015L-5</b> <input type="checkbox"/>	1,630	2,190	2,409	2,628
Right Hand	29 1/8	15	27 7/8	<b>GS2CPD3015R-5</b> <input type="checkbox"/>	1,630	2,190	2,409	2,628
<b>18" WIDTH</b>								
 Left Hand	29 1/8	18	27 7/8	<b>GS2CPD3018L-5</b> <input type="checkbox"/>	1,712	2,300	2,530	2,760
Right Hand	29 1/8	18	27 7/8	<b>GS2CPD3018R-5</b> <input type="checkbox"/>	1,712	2,300	2,530	2,760
<b>24" WIDTH</b>								
 Double Door	29 1/8	24	27 7/8	<b>GS2CPD3024-5</b> <input type="checkbox"/>	1,953	2,625	2,888	3,150
<b>30" WIDTH</b>								
 Double Door	29 1/8	30	27 7/8	<b>GS2CPD3030-5</b> <input type="checkbox"/>	2,138	2,917	3,209	3,501
 With Printer Drawer	29 1/8	30	27 7/8	<b>GS2CPD3030-P</b> <input type="checkbox"/>	2,280	3,062	3,369	3,675
<b>36" WIDTH</b>								
 Double Door	29 1/8	36	27 7/8	<b>GS2CPD3036-5</b> <input type="checkbox"/>	2,352	3,207	3,528	3,849
 With Printer Drawer	29 1/8	36	27 7/8	<b>GS2CPD3036-P</b> <input type="checkbox"/>	2,505	3,367	3,704	4,041

## PRODUCT INFO

All units have an unfinished back.

Units with an exposed end require a filler strip.

If integral pull is chosen, doors will be touch latch.

-5 pedestal includes one adjustable shelf.

Printer pedestal includes printer drawer.





## TO ORDER PLEASE SPECIFY THE FOLLOWING:

### WOOD CHASSIS

- MODEL NUMBER + W**
- FSC**
- CHASSIS WOOD FINISH**
- PULL**
- KEYING**

### LAM CHASSIS

- MODEL NUMBER + L**
- FSC**
- CHASSIS LAM**
- FRONT LAM**
- PULL**
- KEYING**

	D	W	H	model number + type	laminata	veneer 1	veneer 2	veneer 3
<b>15" WIDTH</b> 	29 1/8	15	27 7/8	<b>GS2CPD3015-SH</b> [ ]	1,466	1,972	2,170	2,367
<b>18" WIDTH</b> 	29 1/8	18	27 7/8	<b>GS2CPD3018-SH</b> [ ]	1,540	2,070	2,277	2,484
<b>24" WIDTH</b> 	29 1/8	24	27 7/8	<b>GS2CPD3024-SH</b> [ ]	1,765	2,373	2,611	2,848
<b>30" WIDTH</b> 	29 1/8	30	27 7/8	<b>GS2CPD3030-SH</b> [ ]	1,932	2,637	2,901	3,165
<b>36" WIDTH</b> 	29 1/8	36	27 7/8	<b>GS2CPD3036-SH</b> [ ]	2,131	2,901	3,192	3,482

**PRODUCT INFO**

All units have an unfinished back.  
 Units with an exposed end require a filler strip.  
 Includes one adjustable shelf.

**TO ORDER PLEASE SPECIFY THE FOLLOWING:**

WOOD CHASSIS

1. **MODEL NUMBER + W**
2. **FSC**
3. **CHASSIS WOOD FINISH**

LAM CHASSIS



1. **MODEL NUMBER + L**
2. **FSC**
3. **CHASSIS LAM**

# TROUGH MODULAR PEDS 30D

Standard Height | 9"W | Trough Cutouts

Silea

02/24

	D	W	H	model number + type	laminate	veneer 1	veneer 2	veneer 3
<b>9" WIDTH</b>	29 1/8	9	27 7/8	<b>GS2CPD309TL-X</b> [ ]	944	1,288	1,417	1,546
 False Pedestal								
 Left	29 1/8	9	27 7/8	<b>GS2CPD309TR-X</b> [ ]	944	1,288	1,417	1,546
 Right								

## PRODUCT INFO

Pedestals to be used with a modular trough top.

All units have an unfinished back.

All trough pedestals require a filler strip or pedestal back.

## TO ORDER PLEASE SPECIFY THE FOLLOWING:







### WOOD CHASSIS

1. **MODEL NUMBER + W**
2. **FSC**
3. **CHASSIS WOOD FINISH**

### LAM CHASSIS

1. **MODEL NUMBER + L**
2. **FSC**
3. **CHASSIS LAM**



	D	W	H	model number + type	laminate	veneer 1	veneer 2	veneer 3	
<b>15" WIDTH</b>									
 Box   Box   File	29 1/8	15	27 7/8	<b>GS2CPD3015T-3</b> [ ]	1,894	2,580	2,838	3,096	
 Hidden Accessory   Hidden Accessory   Box   File	29 1/8	15	27 7/8	<b>GS2CPD3015T-3A</b> [ ]	1,894	2,580	2,838	3,096	
 File   File	29 1/8	15	27 7/8	<b>GS2CPD3015T-2</b> [ ]	1,894	2,580	2,838	3,096	
<b>18" WIDTH</b>									
 Box   Box   File	29 1/8	18	27 7/8	<b>GS2CPD3018T-3</b> [ ]	2,027	2,764	3,041	3,317	
 Hidden Accessory   Hidden Accessory   Box   File	29 1/8	18	27 7/8	<b>GS2CPD3018T-3A</b> [ ]	2,027	2,764	3,041	3,317	
 File   File	29 1/8	18	27 7/8	<b>GS2CPD3018T-2</b> [ ]	2,027	2,764	3,041	3,317	

**PRODUCT INFO**

All units have an unfinished back.  
Pedestals to be used with a modular trough top.  
All trough pedestals require a filler strip or pedestal back.

**TO ORDER PLEASE SPECIFY THE FOLLOWING:**

WOOD CHASSIS

1. **MODEL NUMBER + W**
2. **FSC**
3. **CHASSIS WOOD FINISH**
4. **PULL**
5. **DRAWERS**
6. **KEYING**







LAM CHASSIS

1. **MODEL NUMBER + L**
2. **FSC**
3. **CHASSIS LAM**
4. **FRONT LAM**
5. **PULL**
6. **DRAWERS**
7. **KEYING**

# TROUGH MODULAR PEDS 30D

Standard Height | 30" and 36"W | Trough Cutouts

Silea  
02/24

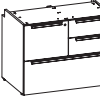
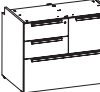
	D	W	H	model number + type	laminate	veneer 1	veneer 2	veneer 3	
<b>30" WIDTH</b>									
 File   File	29 1/8	30	27 7/8	<b>GS2CPD3030T-4</b> <input type="checkbox"/>	2,378	3,239	3,563	3,887	
 Box   Box   File	29 1/8	30	27 7/8	<b>GS2CPD3030T-7</b> <input type="checkbox"/>	2,423	3,304	3,635	3,965	
 Multi-File Left	29 1/8	30	27 7/8	<b>GS2CPD3030TL-MF</b> <input type="checkbox"/>	2,529	3,400	3,740	4,080	
 Multi-File Right	29 1/8	30	27 7/8	<b>GS2CPD3030TR-MF</b> <input type="checkbox"/>	2,529	3,400	3,740	4,080	
<b>36" WIDTH</b>									
 File   File	29 1/8	36	27 7/8	<b>GS2CPD3036T-4</b> <input type="checkbox"/>	2,614	3,562	3,919	4,275	
 Box   Box   File	29 1/8	36	27 7/8	<b>GS2CPD3036T-7</b> <input type="checkbox"/>	2,667	3,633	3,997	4,360	
 Multi-File Left	29 1/8	36	27 7/8	<b>GS2CPD3036TL-MF</b> <input type="checkbox"/>	2,783	3,741	4,116	4,490	
 Multi-File Right	29 1/8	36	27 7/8	<b>GS2CPD3036TR-MF</b> <input type="checkbox"/>	2,783	3,741	4,116	4,490	

## PRODUCT INFO

All units have an unfinished back.

Pedestals to be used with a modular trough top.

All trough pedestals require a filler strip or pedestal back.















## TO ORDER PLEASE SPECIFY THE FOLLOWING:

### WOOD CHASSIS

1. **MODEL NUMBER + W**
2. **FSC**
3. **CHASSIS WOOD FINISH**
4. **PULL**
5. **DRAWERS**
6. **KEYING**

### LAM CHASSIS

1. **MODEL NUMBER + L**
2. **FSC**
3. **CHASSIS LAM**
4. **FRONT LAM**
5. **PULL**
6. **DRAWERS**
7. **KEYING**

	D	W	H	model number + type	laminate	veneer 1	veneer 2	veneer 3	
<b>15" WIDTH</b>									
									
Left Hand	29 1/8	15	27 7/8	<b>GS2CPD3015TL-5</b> 	1,630	2,190	2,409	2,628	
Right Hand	29 1/8	15	27 7/8	<b>GS2CPD3015TR-5</b> 	1,630	2,190	2,409	2,628	
<b>18" WIDTH</b>									
									
Left Hand	29 1/8	18	27 7/8	<b>GS2CPD3018TL-5</b> 	1,712	2,300	2,530	2,760	
Right Hand	29 1/8	18	27 7/8	<b>GS2CPD3018TR-5</b> 	1,712	2,300	2,530	2,760	
<b>24" WIDTH</b>									
									
Double Door	29 1/8	24	27 7/8	<b>GS2CPD3024T-5</b> 	1,953	2,625	2,888	3,150	
<b>30" WIDTH</b>									
									
Double Door	29 1/8	30	27 7/8	<b>GS2CPD3030T-5</b> 	2,138	2,917	3,209	3,501	
With Printer Drawer	29 1/8	30	27 7/8	<b>GS2CPD3030T-P</b> 	2,280	3,062	3,369	3,675	
<b>36" WIDTH</b>									
									
Double Door	29 1/8	36	27 7/8	<b>GS2CPD3036T-5</b> 	2,352	3,207	3,528	3,849	
With Printer Drawer	29 1/8	36	27 7/8	<b>GS2CPD3036T-P</b> 	2,505	3,367	3,704	4,041	

**PRODUCT INFO**

All units have an unfinished back.  
 Pedestals to be used with a modular trough top.  
 All trough pedestals require a filler strip or pedestal back.  
 If integral pull is chosen, doors will be touch latch.  
 -5 pedestal includes one adjustable shelf.  
 Printer pedestal includes printer drawer.

**TO ORDER PLEASE SPECIFY THE FOLLOWING:**

WOOD CHASSIS

- MODEL NUMBER + W**
- FSC**
- CHASSIS WOOD FINISH**
- PULL**
- KEYING**











LAM CHASSIS

- MODEL NUMBER + L**
- FSC**
- CHASSIS LAM**
- FRONT LAM**
- PULL**
- KEYING**

# TROUGH MODULAR PEDS 30D

Standard Height | Open Shelf | Trough Cutouts

Silea  
02/24

	D	W	H	model number + type	laminate	veneer 1	veneer 2	veneer 3
<b>15" WIDTH</b> 	29 1/8	15	27 7/8	<b>GS2CPD3015T-SH</b> 	1,466	1,972	2,170	2,367
<b>18" WIDTH</b> 	29 1/8	18	27 7/8	<b>GS2CPD3018T-SH</b> 	1,540	2,070	2,277	2,484
<b>24" WIDTH</b> 	29 1/8	24	27 7/8	<b>GS2CPD3024T-SH</b> 	1,765	2,373	2,611	2,848
<b>30" WIDTH</b> 	29 1/8	30	27 7/8	<b>GS2CPD3030T-SH</b> 	1,932	2,637	2,901	3,165
<b>36" WIDTH</b> 	29 1/8	36	27 7/8	<b>GS2CPD3036T-SH</b> 	2,131	2,901	3,192	3,482

## PRODUCT INFO

All units have an unfinished back.

Pedestals to be used with a modular trough top.

All trough pedestals require a filler strip or pedestal back.

Adjustable shelf.

## TO ORDER PLEASE SPECIFY THE FOLLOWING:

### WOOD CHASSIS

- MODEL NUMBER + W**
- FSC**
- CHASSIS WOOD FINISH**

### LAM CHASSIS

- MODEL NUMBER + L**
- FSC**
- CHASSIS LAM**

	D	W	H	model number + type	laminate	veneer 1	veneer 2	veneer 3
	23 1/8	3/4	27 7/8	<b>GS2MEP24L-</b> [ ]	445	609	670	731
	23 1/8	3/4	27 7/8	<b>GS2MEP24R-</b> [ ]	445	609	670	731
	29 1/8	3/4	27 7/8	<b>GS2MEP30L-</b> [ ]	539	736	810	884
	29 1/8	3/4	27 7/8	<b>GS2MEP30R-</b> [ ]	539	736	810	884
	35 1/8	3/4	27 7/8	<b>GS2MEP36L-</b> [ ]	577	785	864	942
	35 1/8	3/4	27 7/8	<b>GS2MEP36R-</b> [ ]	577	785	864	942

• Layers version

**PRODUCT INFO**

End panels require the use of a modular full back modesty panel to complete application.

**TO ORDER PLEASE SPECIFY THE FOLLOWING:**

WOOD

1. **MODEL NUMBER + W**
2. **FSC**
3. **CHASSIS WOOD FINISH**

LAM

1. **MODEL NUMBER + L**
2. **FSC**
3. **CHASSIS LAM**

# MODULAR L SUPPORTS

No Back | No Trough | No Wall Access Panel

Silea

02/24

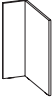
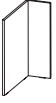
	D	W	H	model number + type	laminate	veneer 1	veneer 2	veneer 3
 Right hand	23 1/8	9	27 7/8	<b>GS2MLS24L-</b> [ ]	761	1,035	1,139	1,242
	23 1/8	9	27 7/8	<b>GS2MLS24R-</b> [ ]	761	1,035	1,139	1,242
 Left hand	29 7/8	9	27 7/8	<b>GS2MLS30L-</b> [ ]	809	1,105	1,216	1,326
	29 7/8	9	27 7/8	<b>GS2MLS30R-</b> [ ]	809	1,105	1,216	1,326

• Layers version

## PRODUCT INFO

Do not use 2 L supports to create a desk.





## TO ORDER PLEASE SPECIFY THE FOLLOWING:

### WOOD

1. **MODEL NUMBER + W**
2. **FSC**
3. **CHASSIS WOOD FINISH**

### LAM

1. **MODEL NUMBER + L**
2. **FSC**
3. **CHASSIS LAM**

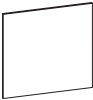
	D	W	H	model number + type	laminate	veneer 1	veneer 2	veneer 3
<b>INTERMEDIATE SUPPORT</b> 	14	3/4	27 7/8	<b>GS2MSP-</b> [ ]	334	722	795	867
<b>T SUPPORT</b> 	14 3/4	12	27 7/8	<b>GS2MSPT-</b> [ ]	402	963	1,060	1,156
<b>WORKSURFACE JUNCTION SUPPORT</b> 	14 3/4	24	27 7/8	<b>GS2MSJ24-</b> [ ]	765	1,040	1,144	1,248
<b>FILLER STRIP</b> 	3/4	9	27 7/8	<b>GS2MPF-</b> [ ]	390	687	756	825
<b>PEDESTAL BACKS</b> 	3/4	9	27 7/8	<b>GS2MPB9-</b> [ ]	390	661	728	794
	3/4	15	27 7/8	<b>GS2MPB15-</b> [ ]	402	779	857	935
	3/4	18	27 7/8	<b>GS2MPB18-</b> [ ]	459	574	632	689
	3/4	30	27 7/8	<b>GS2MPB30-</b> [ ]	517	646	711	776
	3/4	36	27 7/8	<b>GS2MPB36-</b> [ ]	540	675	743	810

**NOTE:** Credenzas, returns, and bridges with no back panel and an unsupported area of 48" and greater require an intermediate T support.

**PRODUCT INFO**

Panels for use with standard or trough tops.  
All pedestals with an exposed side require a filler strip or pedestal back.

**TO ORDER PLEASE SPECIFY THE FOLLOWING:**





- |                               |                            |
|-------------------------------|----------------------------|
| <b>WOOD</b>                   | <b>LAM</b>                 |
| <b>1. MODEL NUMBER + W</b>    | <b>1. MODEL NUMBER + L</b> |
| <b>2. FSC</b>                 | <b>2. FSC</b>              |
| <b>3. CHASSIS WOOD FINISH</b> | <b>3. CHASSIS LAM</b>      |

# MODULAR SUPPORT PANELS & PED BACKS

Silea

02/24

Layers Height

	D	W	H	model number + type	laminate	veneer 1	veneer 2	veneer 3
<b>INTERMEDIATE SUPPORT</b> 	14	3/4	20 3/4	<b>GS2MLSP-</b> [ ]	334	450	495	540
<b>T SUPPORT</b> 	14 3/4	12	20 3/4	<b>GS2MLSPT-</b> [ ]	402	540	594	648
<b>WORKSURFACE JUNCTION SUPPORT</b> 	14 3/4	24	20 3/4	<b>GS2MLSJ24-</b> [ ]	765	1,040	1,144	1,248
<b>FILLER STRIP</b> 	3/4	9	20 3/4	<b>GS2MLPF-</b> [ ]	390	687	756	825
<b>PEDESTAL BACKS</b> 	3/4	15	20 3/4	<b>GS2MLPB15-</b> [ ]	402	503	554	604
	3/4	18	20 3/4	<b>GS2MLPB18-</b> [ ]	459	574	632	689
	3/4	30	20 3/4	<b>GS2MLPB30-</b> [ ]	517	646	711	776
	3/4	36	20 3/4	<b>GS2MLPB36-</b> [ ]	540	675	743	810

**NOTE:** Credenzas, returns, and bridges with no back panel and an unsupported area of 48" and greater require an intermediate T support.

## PRODUCT INFO

Panels for use with standard or trough tops.  
All pedestals with exposed side require a filler strip or pedestal back.

## TO ORDER PLEASE SPECIFY THE FOLLOWING:

### WOOD

- MODEL NUMBER + W**
- FSC**
- CHASSIS WOOD FINISH**

### LAM

- MODEL NUMBER + L**
- FSC**
- CHASSIS LAM**



# MODULAR DESK / CREDENZA FULL MODESTY PANELS

Standard Height

	D	W	H	model number + type	laminate	veneer 1	veneer 2	veneer 3
	3/4	60	27 7/8	<b>GS2CMF60-</b> [ ]	783	990	1,089	1,188
	3/4	66	27 7/8	<b>GS2CMF66-</b> [ ]	854	1,081	1,190	1,298
	3/4	72	27 7/8	<b>GS2CMF72-</b> [ ]	921	1,167	1,284	1,401
	3/4	78	27 7/8	<b>GS2CMF78-</b> [ ]	987	1,251	1,377	1,502
	3/4	84	27 7/8	<b>GS2CMF84-</b> [ ]	1,055	1,337	1,471	1,605
	3/4	90	27 7/8	<b>GS2CMF90-</b> [ ]	1,124	1,423	1,566	1,708
	3/4	96	27 7/8	<b>GS2CMF96-</b> [ ]	1,193	1,509	1,660	1,811
	3/4	102	27 7/8	<b>GS2CMF102-</b> [ ]	N/A	1,593	1,753	1,912
	3/4	108	27 7/8	<b>GS2CMF108-</b> [ ]	N/A	1,679	1,847	2,015
	3/4	114	27 7/8	<b>GS2CMF114-</b> [ ]	N/A	1,764	1,941	2,117
3/4	120	27 7/8	<b>GS2CMF120-</b> [ ]	N/A	1,850	2,035	2,220	

## PRODUCT INFO

### Grain Direction

- Natural Veneer: Vertical
- Stratawood Veneer: Optional
- Laminate : Horizontal

## TO ORDER PLEASE SPECIFY THE FOLLOWING:

### WOOD

- 1. MODEL NUMBER + W**
- 2. FSC**
- 3. CHASSIS WOOD FINISH**

### LAM

- 1. MODEL NUMBER + L**
- 2. FSC**
- 3. CHASSIS LAM**

# MODULAR CREDENZA FULL MODESTY PANEL

Silea

02/24

Layers Height

	D	W	H	model number + type	laminate	veneer 1	veneer 2	veneer 3
	3/4	45	20 3/4	<b>GS2CLMF45-</b> [ ]	723	912	1,004	1,095
	3/4	48	20 3/4	<b>GS2CLMF48-</b> [ ]	735	929	1,022	1,115
	3/4	51	20 3/4	<b>GS2CLMF51-</b> [ ]	748	947	1,042	1,137
	3/4	54	20 3/4	<b>GS2CLMF54-</b> [ ]	758	962	1,059	1,155
	3/4	60	20 3/4	<b>GS2CLMF60-</b> [ ]	783	990	1,089	1,188
	3/4	66	20 3/4	<b>GS2CLMF66-</b> [ ]	854	1,081	1,190	1,298
	3/4	72	20 3/4	<b>GS2CLMF72-</b> [ ]	921	1,167	1,284	1,401
	3/4	78	20 3/4	<b>GS2CLMF78-</b> [ ]	987	1,251	1,377	1,502
	3/4	84	20 3/4	<b>GS2CLMF84-</b> [ ]	1,055	1,337	1,471	1,605
	3/4	90	20 3/4	<b>GS2CLMF90-</b> [ ]	1,124	1,423	1,566	1,708
	3/4	96	20 3/4	<b>GS2CLMF96-</b> [ ]	1,193	1,509	1,660	1,811
	3/4	102	20 3/4	<b>GS2CLMF102-</b> [ ]	N/A	1,593	1,753	1,912
	3/4	108	20 3/4	<b>GS2CLMF108-</b> [ ]	N/A	1,679	1,847	2,015
	3/4	114	20 3/4	<b>GS2CLMF114-</b> [ ]	N/A	1,764	1,941	2,117
3/4	120	20 3/4	<b>GS2CLMF120-</b> [ ]	N/A	1,850	2,035	2,220	

## PRODUCT INFO

### Grain Direction

- Natural Veneer: Vertical
- Stratawood Veneer: Optional
- Laminate : Horizontal

## TO ORDER PLEASE SPECIFY THE FOLLOWING:

### WOOD

1. **MODEL NUMBER + W**
2. **FSC**
3. **CHASSIS WOOD FINISH**

### LAM

1. **MODEL NUMBER + L**
2. **FSC**
3. **CHASSIS LAM**

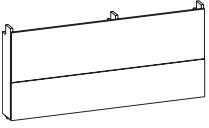

D	W	H	model number + type	laminate	veneer 1	veneer 2	veneer 3
7 1/4	21	27 7/8	<b>GS2CMA21-</b> [ ]	920	1,251	1,377	1,502
7 1/4	24	27 7/8	<b>GS2CMA24-</b> [ ]	940	1,284	1,413	1,541
7 1/4	27	27 7/8	<b>GS2CMA27-</b> [ ]	963	1,312	1,444	1,575
7 1/4	30	27 7/8	<b>GS2CMA30-</b> [ ]	985	1,344	1,479	1,613
7 1/4	33	27 7/8	<b>GS2CMA33-</b> [ ]	1,008	1,375	1,513	1,650
7 1/4	36	27 7/8	<b>GS2CMA36-</b> [ ]	1,032	1,404	1,545	1,685
7 1/4	39	27 7/8	<b>GS2CMA39-</b> [ ]	1,052	1,434	1,578	1,721
7 1/4	42	27 7/8	<b>GS2CMA42-</b> [ ]	1,077	1,467	1,614	1,761
7 1/4	45	27 7/8	<b>GS2CMA45-</b> [ ]	1,097	1,495	1,645	1,794
7 1/4	48	27 7/8	<b>GS2CMA48-</b> [ ]	1,123	1,528	1,681	1,834
7 1/4	51	27 7/8	<b>GS2CMA51-</b> [ ]	1,225	1,559	1,715	1,871
7 1/4	54	27 7/8	<b>GS2CMA54-</b> [ ]	1,247	1,588	1,747	1,906
7 1/4	57	27 7/8	<b>GS2CMA57-</b> [ ]	1,272	1,619	1,781	1,943
7 1/4	60	27 7/8	<b>GS2CMA60-</b> [ ]	1,290	1,647	1,812	1,977
7 1/4	63	27 7/8	<b>GS2CMA63-</b> [ ]	1,320	1,679	1,847	2,015
7 1/4	66	27 7/8	<b>GS2CMA66-</b> [ ]	1,342	1,711	1,883	2,054
7 1/4	69	27 7/8	<b>GS2CMA69-</b> [ ]	1,368	1,739	1,913	2,087
7 1/4	72	27 7/8	<b>GS2CMA72-</b> [ ]	1,390	1,771	1,949	2,126

**PRODUCT INFO**

**Grain Direction**

- Natural Veneer: Vertical
- Stratawood Veneer: Optional
- Laminate: Vertical up to and including 60"W. Horizontal greater than 60"W.

**TO ORDER PLEASE SPECIFY THE FOLLOWING:**

WOOD

- 1. MODEL NUMBER + W**
- 2. FSC**
- 3. CHASSIS WOOD FINISH**

LAM

- 1. MODEL NUMBER + L**
- 2. FSC**
- 3. CHASSIS LAM**

# MODULAR CREDENZA WALL ACCESS PANEL

Layers Height

Silea  
02/24

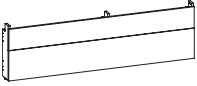
	D	W	H	model number + type	laminate	veneer 1	veneer 2	veneer 3
	7 1/4	21	20 3/4	<b>GS2CLMA21-</b> [ ]	920	1,251	1,377	1,502
	7 1/4	24	20 3/4	<b>GS2CLMA24-</b> [ ]	940	1,284	1,413	1,541
	7 1/4	27	20 3/4	<b>GS2CLMA27-</b> [ ]	963	1,312	1,444	1,575
	7 1/4	30	20 3/4	<b>GS2CLMA30-</b> [ ]	985	1,344	1,479	1,613
	7 1/4	33	20 3/4	<b>GS2CLMA33-</b> [ ]	1,008	1,375	1,513	1,650
	7 1/4	36	20 3/4	<b>GS2CLMA36-</b> [ ]	1,032	1,404	1,545	1,685
	7 1/4	39	20 3/4	<b>GS2CLMA39-</b> [ ]	1,052	1,434	1,578	1,721
	7 1/4	42	20 3/4	<b>GS2CLMA42-</b> [ ]	1,077	1,467	1,614	1,761
	7 1/4	45	20 3/4	<b>GS2CLMA45-</b> [ ]	1,097	1,495	1,645	1,794
	7 1/4	48	20 3/4	<b>GS2CLMA48-</b> [ ]	1,123	1,528	1,681	1,834
	7 1/4	51	20 3/4	<b>GS2CLMA51-</b> [ ]	1,225	1,559	1,715	1,871
	7 1/4	54	20 3/4	<b>GS2CLMA54-</b> [ ]	1,247	1,588	1,747	1,906
	7 1/4	57	20 3/4	<b>GS2CLMA57-</b> [ ]	1,272	1,619	1,781	1,943
	7 1/4	60	20 3/4	<b>GS2CLMA60-</b> [ ]	1,290	1,647	1,812	1,977
	7 1/4	63	20 3/4	<b>GS2CLMA63-</b> [ ]	1,320	1,679	1,847	2,015
	7 1/4	66	20 3/4	<b>GS2CLMA66-</b> [ ]	1,342	1,711	1,883	2,054
	7 1/4	69	20 3/4	<b>GS2CLMA69-</b> [ ]	1,368	1,739	1,913	2,087
7 1/4	72	20 3/4	<b>GS2CLMA72-</b> [ ]	1,390	1,771	1,949	2,126	

## PRODUCT INFO

### Grain Direction

- Natural Veneer: Vertical
- Stratawood Veneer: Optional
- Laminate: Vertical up to and including 60"W. Horizontal greater than 60"W.

## TO ORDER PLEASE SPECIFY THE FOLLOWING:

### WOOD

- MODEL NUMBER + W**
- FSC**
- CHASSIS WOOD FINISH**

### LAM

- MODEL NUMBER + L**
- FSC**
- CHASSIS LAM**

	D	W	H	model number + type	laminate	veneer 1	veneer 2	veneer 3
<b>LEFT HAND</b> 	3/4	39	27 7/8	<b>GS2RMF39L-</b> [ ]	703	889	978	1,067
	3/4	42	27 7/8	<b>GS2RMF42L-</b> [ ]	714	903	994	1,084
	3/4	45	27 7/8	<b>GS2RMF45L-</b> [ ]	723	912	1,004	1,095
	3/4	48	27 7/8	<b>GS2RMF48L-</b> [ ]	735	929	1,022	1,115
	3/4	51	27 7/8	<b>GS2RMF51L-</b> [ ]	748	947	1,042	1,137
	3/4	54	27 7/8	<b>GS2RMF54L-</b> [ ]	758	962	1,059	1,155
	3/4	57	27 7/8	<b>GS2RMF57L-</b> [ ]	772	973	1,071	1,168
	3/4	60	27 7/8	<b>GS2RMF60L-</b> [ ]	783	990	1,089	1,188
	3/4	63	27 7/8	<b>GS2RMF63L-</b> [ ]	818	1,035	1,139	1,242
	3/4	66	27 7/8	<b>GS2RMF66L-</b> [ ]	854	1,081	1,190	1,298
	3/4	69	27 7/8	<b>GS2RMF69L-</b> [ ]	889	1,125	1,238	1,350
	3/4	72	27 7/8	<b>GS2RMF72L-</b> [ ]	921	1,167	1,284	1,401
	3/4	75	27 7/8	<b>GS2RMF75L-</b> [ ]	955	1,210	1,331	1,452
	3/4	78	27 7/8	<b>GS2RMF78L-</b> [ ]	987	1,251	1,377	1,502
	3/4	81	27 7/8	<b>GS2RMF81L-</b> [ ]	1,022	1,295	1,425	1,554
	3/4	84	27 7/8	<b>GS2RMF84L-</b> [ ]	1,055	1,337	1,471	1,605
3/4	87	27 7/8	<b>GS2RMF87L-</b> [ ]	1,090	1,380	1,518	1,656	
3/4	90	27 7/8	<b>GS2RMF90L-</b> [ ]	1,124	1,423	1,566	1,708	

**NOTE:** If attaching to a height adjustable extension desk, a 3" shorter modesty panel must be used

PRODUCT INFO	TO ORDER PLEASE SPECIFY THE FOLLOWING:								
<p>Handed units due to hole pattern.</p> <p>For use to build full modesty returns and to attach to end panels.</p> <p><b>Grain Direction</b></p> <ul style="list-style-type: none"> <li>• Natural Veneer: Vertical</li> <li>• Stratawood Veneer: Optional</li> <li>• Laminate: Vertical up to and including 60"W. Horizontal greater than 60"W.</li> </ul>	<table border="0"> <tr> <td>WOOD</td> <td>LAM</td> </tr> <tr> <td>1. MODEL NUMBER + W</td> <td>1. MODEL NUMBER + L</td> </tr> <tr> <td>2. FSC</td> <td>2. FSC</td> </tr> <tr> <td>3. CHASSIS WOOD FINISH</td> <td>3. CHASSIS LAM</td> </tr> </table>	WOOD	LAM	1. MODEL NUMBER + W	1. MODEL NUMBER + L	2. FSC	2. FSC	3. CHASSIS WOOD FINISH	3. CHASSIS LAM
WOOD	LAM								
1. MODEL NUMBER + W	1. MODEL NUMBER + L								
2. FSC	2. FSC								
3. CHASSIS WOOD FINISH	3. CHASSIS LAM								

# MODULAR RETURN FULL MODESTY PANEL

Silea  
02/24

	D	W	H	model number + type	laminate	veneer 1	veneer 2	veneer 3
<b>RIGHT HAND</b> 	3/4	39	27 7/8	<b>GS2RMF39R-</b> [ ]	703	889	978	1,067
	3/4	42	27 7/8	<b>GS2RMF42R-</b> [ ]	714	903	994	1,084
	3/4	45	27 7/8	<b>GS2RMF45R-</b> [ ]	723	912	1,004	1,095
	3/4	48	27 7/8	<b>GS2RMF48R-</b> [ ]	735	929	1,022	1,115
	3/4	51	27 7/8	<b>GS2RMF51R-</b> [ ]	748	947	1,042	1,137
	3/4	54	27 7/8	<b>GS2RMF54R-</b> [ ]	758	962	1,059	1,155
	3/4	57	27 7/8	<b>GS2RMF57R-</b> [ ]	772	973	1,071	1,168
	3/4	60	27 7/8	<b>GS2RMF60R-</b> [ ]	783	990	1,089	1,188
	3/4	63	27 7/8	<b>GS2RMF63R-</b> [ ]	818	1,035	1,139	1,242
	3/4	66	27 7/8	<b>GS2RMF66R-</b> [ ]	854	1,081	1,190	1,298
	3/4	69	27 7/8	<b>GS2RMF69R-</b> [ ]	889	1,125	1,238	1,350
	3/4	72	27 7/8	<b>GS2RMF72R-</b> [ ]	921	1,167	1,284	1,401
	3/4	75	27 7/8	<b>GS2RMF75R-</b> [ ]	955	1,210	1,331	1,452
	3/4	78	27 7/8	<b>GS2RMF78R-</b> [ ]	987	1,251	1,377	1,502
	3/4	81	27 7/8	<b>GS2RMF81R-</b> [ ]	1,022	1,295	1,425	1,554
	3/4	84	27 7/8	<b>GS2RMF84R-</b> [ ]	1,055	1,337	1,471	1,605
3/4	87	27 7/8	<b>GS2RMF87R-</b> [ ]	1,090	1,380	1,518	1,656	
3/4	90	27 7/8	<b>GS2RMF90R-</b> [ ]	1,124	1,423	1,566	1,708	

**NOTE:** If attaching to a height adjustable extension desk, a 3" shorter modesty panel must be used

## PRODUCT INFO

Handed units due to hole pattern.

For use to build full modesty returns and to attach to end panels.

### Grain Direction

- Natural Veneer: Vertical
- Stratawood Veneer: Optional
- Laminate: Vertical up to and including 60"W. Horizontal greater than 60"W.

## TO ORDER PLEASE SPECIFY THE FOLLOWING:

### WOOD

1. **MODEL NUMBER + W**
2. **FSC**
3. **CHASSIS WOOD FINISH**

### LAM

1. **MODEL NUMBER + L**
2. **FSC**
3. **CHASSIS LAM**



D	W	H	model number + type	laminate	veneer 1	veneer 2	veneer 3
7 1/4	21	27 7/8	<b>GS2RMA21-</b> [ ]	920	1,251	1,377	1,502
7 1/4	24	27 7/8	<b>GS2RMA24-</b> [ ]	940	1,284	1,413	1,541
7 1/4	27	27 7/8	<b>GS2RMA27-</b> [ ]	963	1,312	1,444	1,575
7 1/4	30	27 7/8	<b>GS2RMA30-</b> [ ]	985	1,344	1,479	1,613
7 1/4	33	27 7/8	<b>GS2RMA33-</b> [ ]	1,008	1,375	1,513	1,650
7 1/4	36	27 7/8	<b>GS2RMA36-</b> [ ]	1,032	1,404	1,545	1,685
7 1/4	39	27 7/8	<b>GS2RMA39-</b> [ ]	1,052	1,434	1,578	1,721
7 1/4	42	27 7/8	<b>GS2RMA42-</b> [ ]	1,077	1,467	1,614	1,761
7 1/4	45	27 7/8	<b>GS2RMA45-</b> [ ]	1,097	1,495	1,645	1,794
7 1/4	48	27 7/8	<b>GS2RMA48-</b> [ ]	1,123	1,528	1,681	1,834
7 1/4	51	27 7/8	<b>GS2RMA51-</b> [ ]	1,225	1,559	1,715	1,871
7 1/4	54	27 7/8	<b>GS2RMA54-</b> [ ]	1,247	1,588	1,747	1,906
7 1/4	57	27 7/8	<b>GS2RMA57-</b> [ ]	1,272	1,619	1,781	1,943
7 1/4	60	27 7/8	<b>GS2RMA60-</b> [ ]	1,290	1,647	1,812	1,977
7 1/4	63	27 7/8	<b>GS2RMA63-</b> [ ]	1,320	1,679	1,847	2,015
7 1/4	66	27 7/8	<b>GS2RMA66-</b> [ ]	1,342	1,711	1,883	2,054
7 1/4	69	27 7/8	<b>GS2RMA69-</b> [ ]	1,368	1,739	1,913	2,087
7 1/4	72	27 7/8	<b>GS2RMA72-</b> [ ]	1,390	1,771	1,949	2,126

**NOTE:** If attaching to a height adjustable extension desk, a 3" shorter wall access panel must be used

**PRODUCT INFO**

**Grain Direction**

- Natural Veneer: Vertical
- Stratawood Veneer: Optional
- Laminate: Vertical up to and including 60"W. Horizontal greater than 60"W.

**TO ORDER PLEASE SPECIFY THE FOLLOWING:**

WOOD

1. **MODEL NUMBER + W**
2. **FSC**
3. **CHASSIS WOOD FINISH**

LAM

1. **MODEL NUMBER + L**
2. **FSC**
3. **CHASSIS LAM**

# BRIDGE FULL MODESTY PANEL

Silea  
02/24

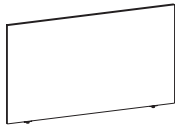

D	W	H	model number + type	laminat	veneer 1	veneer 2	veneer 3
3/4	39	27 7/8	<b>GS2BMF39-</b> [ ]	703	889	978	1,067
3/4	42	27 7/8	<b>GS2BMF42-</b> [ ]	714	903	994	1,084
3/4	45	27 7/8	<b>GS2BMF45-</b> [ ]	727	912	1,004	1,095
3/4	48	27 7/8	<b>GS2BMF48-</b> [ ]	734	929	1,022	1,115
3/4	51	27 7/8	<b>GS2BMF51-</b> [ ]	749	947	1,042	1,137
3/4	54	27 7/8	<b>GS2BMF54-</b> [ ]	761	962	1,059	1,155
3/4	57	27 7/8	<b>GS2BMF57-</b> [ ]	773	973	1,071	1,168
3/4	60	27 7/8	<b>GS2BMF60-</b> [ ]	783	990	1,089	1,188

**NOTE:** If attaching to a height adjustable extension desk, a 3" shorter modesty panel must be used

## PRODUCT INFO

### Grain Direction

- Natural Veneer: Vertical
- Stratawood Veneer: Optional
- Laminate: Vertical up to and including 60"W. Horizontal greater than 60"W.

## TO ORDER PLEASE SPECIFY THE FOLLOWING:

### WOOD

1. **MODEL NUMBER + W**
2. **FSC**
3. **CHASSIS WOOD FINISH**

### LAM

1. **MODEL NUMBER + L**
2. **FSC**
3. **CHASSIS LAM**





D	W	H	model number + type	laminate	veneer 1	veneer 2	veneer 3
7 1/4	39	27 7/8	<b>GS2BMA39-</b> [ ]	1,052	1,434	1,578	1,721
7 1/4	42	27 7/8	<b>GS2BMA42-</b> [ ]	1,077	1,467	1,614	1,761
7 1/4	45	27 7/8	<b>GS2BMA45-</b> [ ]	1,097	1,495	1,645	1,794
7 1/4	48	27 7/8	<b>GS2BMA48-</b> [ ]	1,123	1,528	1,681	1,834
7 1/4	51	27 7/8	<b>GS2BMA51-</b> [ ]	1,225	1,559	1,715	1,871
7 1/4	54	27 7/8	<b>GS2BMA54-</b> [ ]	1,247	1,588	1,747	1,906
7 1/4	57	27 7/8	<b>GS2BMA57-</b> [ ]	1,272	1,619	1,781	1,943
7 1/4	60	27 7/8	<b>GS2BMA60-</b> [ ]	1,290	1,647	1,812	1,977

**NOTE:** If attaching to a height adjustable extension desk, a 3" shorter wall access panel must be used

PRODUCT INFO	TO ORDER PLEASE SPECIFY THE FOLLOWING:								
<p><b>Grain Direction</b></p> <ul style="list-style-type: none"> <li>• Natural Veneer: Vertical</li> <li>• Stratawood Veneer: Optional</li> <li>• Laminate: Vertical up to and including 60"W. Horizontal greater than 60"W.</li> </ul>	<table border="0"> <tr> <td>WOOD</td> <td>LAM</td> </tr> <tr> <td>1. MODEL NUMBER + W</td> <td>1. MODEL NUMBER + L</td> </tr> <tr> <td>2. FSC</td> <td>2. FSC</td> </tr> <tr> <td>3. CHASSIS WOOD FINISH</td> <td>3. CHASSIS LAM</td> </tr> </table>	WOOD	LAM	1. MODEL NUMBER + W	1. MODEL NUMBER + L	2. FSC	2. FSC	3. CHASSIS WOOD FINISH	3. CHASSIS LAM
WOOD	LAM								
1. MODEL NUMBER + W	1. MODEL NUMBER + L								
2. FSC	2. FSC								
3. CHASSIS WOOD FINISH	3. CHASSIS LAM								

# LAYERS W/ LAPTOP DRAWER

For 30" and 36"D Runoff

Silea  
02/24

	D	W	H	model number + type	laminate	veneer 1	veneer 2	veneer 3
	16 3/4	26 1/2	5 15/16	<b>GS2MLB30SL-</b> [ ]	943	1,285	1,414	1,542
	16 3/4	26 1/2	5 15/16	<b>GS2MLB30SR-</b> [ ]	943	1,285	1,414	1,542

• For use with a 30" deep runoff.

	16 3/4	32 1/2	5 15/16	<b>GS2MLB36SL-</b> [ ]	1,004	1,307	1,438	1,569
	16 3/4	32 1/2	5 15/16	<b>GS2MLB36SR-</b> [ ]	1,004	1,307	1,438	1,569

• For use with a 36" deep runoff.

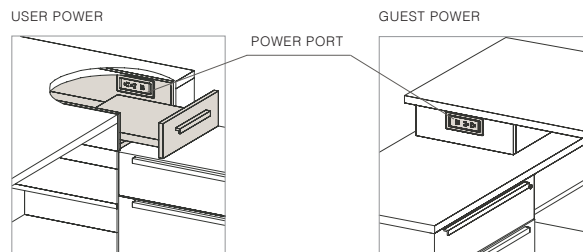

## PRODUCT INFO

Unit comes with 2 power units. Color specified in option pick.

 Units shipped as separate packages and require field assembly.

## TO ORDER PLEASE SPECIFY THE FOLLOWING:

### WOOD

1. **MODEL NUMBER + W**
2. **FSC**
3. **CHASSIS WOOD FINISH**
4. **PULL**
5. **POWER UNIT**

### LAM

1. **MODEL NUMBER + L**
2. **FSC**
3. **CHASSIS LAM**
4. **PULL**
5. **POWER UNIT**

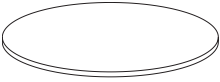
	Dia	H	model number + type	laminate	veneer 1	veneer 2	veneer 3	solid surface
	36	1 3/16	<b>GS2TRD36-</b> [ ]	1,379	2,351	2,587	2,822	7,410
	42	1 3/16	<b>GS2TRD42-</b> [ ]	1,497	2,554	2,810	3,065	8,055
	48	1 3/16	<b>GS2TRD48-</b> [ ]	1,961	3,339	3,673	4,007	10,535
	54	1 3/16	<b>GS2TRD54-</b> [ ]	2,394	4,082	4,491	4,899	12,875
	60	1 3/16	<b>GS2TRD60-</b> [ ]	2,913	4,968	5,465	5,962	15,644

**PRODUCT INFO**

Solid surface tops have a softened edge.

54" and 60" wood tops are 2-piece. If top ordered with 4 legs, metal stiffeners must be ordered separately (ACMWS30, qty. 2).

**Grommet Location**  
(Add \$80 per grommet)

No Grommet **GN**  
Center **GC**

Specify location first, then select grommet color or "Empty Cutout" option. When "Empty Cutout" option is selected, a grommet or power unit must be ordered separately for each cutout.

**TO ORDER PLEASE SPECIFY THE FOLLOWING:**

**WOOD TOP**

1. **MODEL NUMBER + W**
2. **FSC**
3. **TOP WOOD FINISH + EDGE**
4. **TOP FINISH**
5. **GROMMET**

**LAM TOP**

1. **MODEL NUMBER + L**
2. **FSC**
3. **TOP LAM**
4. **EDGE DETAIL**
5. **GROMMET**

**SOLID SURFACE TOP**

1. **MODEL NUMBER + S**
2. **SOLID SURFACE FINISH**
3. **EDGE DETAIL**
4. **GROMMET**

# GUITAR PICK TOP

Silea  
02/24

	D	W	H	model number + type	laminate	veneer 1	veneer 2	veneer 3	solid surface
	36	36	1 3/16	<b>GS2TSTG36-</b> [ ]	1,379	2,351	2,587	2,822	7,410
	42	42	1 3/16	<b>GS2TSTG42-</b> [ ]	1,497	2,554	2,810	3,065	8,055
	48	48	1 3/16	<b>GS2TSTG48-</b> [ ]	1,961	3,339	3,673	4,007	10,535

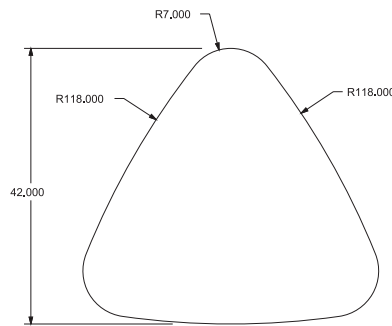

## PRODUCT INFO

Solid surface tops have a softened edge.

### Grommet Location

(Add \$80 per grommet)

No Grommet **GN**  
Center **GC**

Specify location first, then select grommet color or "Empty Cutout" option. When "Empty Cutout" option is selected, a grommet or power unit must be ordered separately for each cutout.

## TO ORDER PLEASE SPECIFY THE FOLLOWING:

### WOOD TOP

1. **MODEL NUMBER + W**
2. **FSC**
3. **TOP WOOD FINISH + EDGE**
4. **TOP FINISH**
5. **GROMMET**

### LAM TOP

1. **MODEL NUMBER + L**
2. **FSC**
3. **TOP LAM**
4. **EDGE DETAIL**
5. **GROMMET**

### SOLID SURFACE TOP

1. **MODEL NUMBER + S**
2. **SOLID SURFACE FINISH**
3. **EDGE DETAIL**
4. **GROMMET**

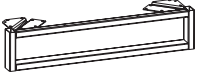
	for use with top sizes	D	W	H	model number	list
	24D/30D	1 1/2	18	5 15/16	<b>GS2MLB18</b>	465
	36D	1 1/2	24	5 15/16	<b>GS2MLB24</b>	504
	42D	1 1/2	30	5 15/16	<b>GS2MLB30</b>	544
	48D	1 1/2	36	5 15/16	<b>GS2MLB36</b>	585

**PRODUCT INFO**

To be used to support  
worksurface in layers  
applications.

**TO ORDER PLEASE SPECIFY THE FOLLOWING:**

LIST

1. **MODEL NUMBER**
2. **HARDWARE COLOR**

# STEEL WORKSURFACE SUPPORT

Silea  
02/24



D	W	H	model number	in.
1 1/2	1 1/2	30	<b>ACMWS30</b>	70
1 1/2	1 1/2	36	<b>ACMWS36</b>	75
1 1/2	1 1/2	41	<b>ACMWS41</b>	76
1 1/2	1 1/2	47	<b>ACMWS47</b>	77
1 1/2	1 1/2	53	<b>ACMWS53</b>	78
1 1/2	1 1/2	59	<b>ACMWS59</b>	79
1 1/2	1 1/2	65	<b>ACMWS65</b>	80
1 1/2	1 1/2	71	<b>ACMWS71</b>	81
1 1/2	1 1/2	83	<b>ACMWS83</b>	121



## PRODUCT INFO

Use supports on worksurfaces that span 48" unsupported without a full modesty panel. Calculate total distance between kneewell panels or bases and subtract 6". Use closest available model size.

## TO ORDER PLEASE SPECIFY THE FOLLOWING:

LIST

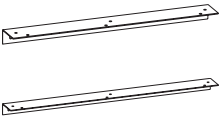
- MODEL NUMBER**

	D	W	H	model number	list
<b>FLAT BRACKET</b> 	3	6 1/2	1/8	<b>MDWBRK</b>	131
	• For worksurface connections				
<b>WALL MOUNT BRACKETS</b> 	2 1/2	19	1 1/4	<b>MDWLBK24</b>	134
	• For use with 24"D worksurface.				
	2 1/2	25	1 1/4	<b>MDWLBK30</b>	145
	• For use with 30" and 36"D worksurface.				
<b>WALL MOUNT CANTILEVER BRACKETS</b> 	3 1/8	15 3/16	7 1/8	<b>ACWCB15</b>	235
	• For use with 24" tops to provide support on center as an alternative to a T-bracket.				
	3 1/8	20 3/16	7 1/8	<b>ACWCB20</b>	252
	• For use with 24" tops to provide support on an end condition.				

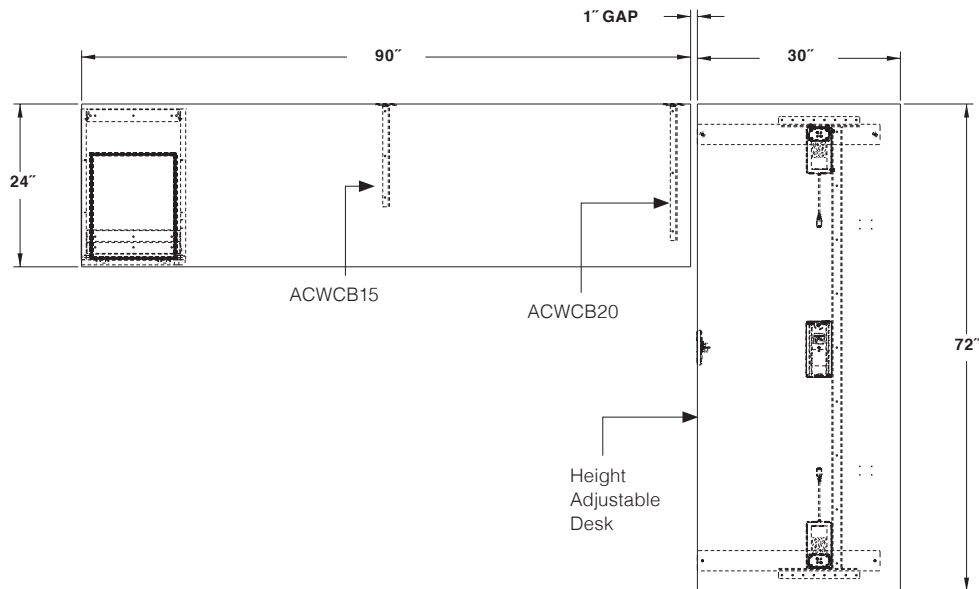

**PRODUCT INFO**

TO ORDER PLEASE SPECIFY THE FOLLOWING:

LIST

- 1. MODEL NUMBER**

# MODULAR PEDESTAL CUSHION

Standard and Trough Tops

**Silea**  
02/24

	D	W	H	model number + type	fabric grades			COM/4
					1	2	3	
	20 11/16	29 3/4	1	<b>GS2CLPD-CUSH2130T</b>	595	619	644	670
	20 11/16	35 3/4	1	<b>GS2CLPD-CUSH2136T</b>	642	672	704	737

## PRODUCT INFO

To be used with standard and trough tops.

**COM fabric 1.25 yds for both models.**

## TO ORDER PLEASE SPECIFY THE FOLLOWING:

### LIST

1. **MODEL NUMBER**
2. **FABRIC**
3. **FLAMMABILITY**

**Flammability Option Codes:**  
**U** = CTB 117

For standard flammability rating, please specify CTB 117.



# CANTILEVER HEIGHT ADJUSTABLE DESKS AND SMART STORAGE

Cantilever Height Adjustable Desks and Smart Storage . . . . .	219-233
Cantilever Height Adjustable Desks . . . . .	220-223
Smart Pedestals. . . . .	224-225
Accessory Trays and Bins For Smart Pedestals . . . . .	226
False Pedestals . . . . .	227
Smart Closets . . . . .	228-229
Smart Lockers . . . . .	230-231
Smart Pedestal Power Units For Grommet Cutout. . . . .	232
Solidwood Desktop Accessories. . . . .	233

# CANTILEVER HEIGHT ADJUSTABLE DESKS - RECTANGULAR

Silea

02/24

Left Hand Desk

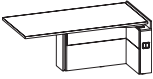
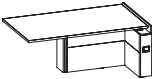
	D	W	H	model number + type	laminiate	veneer 1	veneer 2	veneer 3	
<b>36" DEPTH</b> 	36	66	29 1/2	<b>GS5CVATR3666L-</b> [ ]	8,422	12,059	13,265	14,471	
	• 22 1/2" end overhang, 6" guest overhang								
	36	72	29 1/2	<b>GS5CVATR3672L-</b> [ ]	8,481	12,142	13,357	14,571	
	• 28 1/2" end overhang, 6" guest overhang								
	36	78	29 1/2	<b>GS5CVATR3678L-</b> [ ]	8,890	12,583	13,842	15,100	
<b>42" DEPTH</b> 	• 34 1/2" end overhang, 6" guest overhang								
	42	66	29 1/2	<b>GS5CVATR4266L-</b> [ ]	8,962	12,920	14,212	15,504	
	• 22 1/2" end overhang, 9" guest overhang								
	42	72	29 1/2	<b>GS5CVATR4272L-</b> [ ]	9,038	13,026	14,329	15,632	
	• 28 1/2" end overhang, 9" guest overhang								
	42	78	29 1/2	<b>GS5CVATR4278L-</b> [ ]	9,468	13,496	14,846	16,196	
	• 34 1/2" end overhang, 9" guest overhang								
	42	84	29 1/2	<b>GS5CVATR4284L-</b> [ ]	9,576	13,649	15,014	16,379	
	• 40 1/2" end overhang, 9" guest overhang								

## PRODUCT INFO

### Unit must be wall mounted.

Top depth 1" shallower than chassis on user and guest sides to accommodate pinch points of adjoining units

29.5" to 42.5" height adjustment range

 All units shipped as separate packages and require field assembly.

### Grommet Location

(Add \$80 per grommet)

No Grommet **GN**  
Right **GR**

Specify location first, then select grommet color or "Empty Cutout" option. When "Empty Cutout" option is selected, a grommet or power unit must be ordered separately for each cutout.

NOTE: Monitor arms should **ALWAYS** be installed in grommets on Silea height adjustable units. Please ensure a grommet location is specified on the top. This allows for bolt mount or clamp mount install of monitor arm. See page 35 for details.

## TO ORDER PLEASE SPECIFY THE FOLLOWING:

WOOD TOP, WOOD CHASSIS

LAM TOP, LAM CHASSIS

- |                                       |                                       |
|---------------------------------------|---------------------------------------|
| 1. <b>MODEL NUMBER + WW</b>           | 1. <b>MODEL NUMBER + LL</b>           |
| 2. <b>FSC</b>                         | 2. <b>FSC</b>                         |
| 3. <b>TOP WOOD FINISH + EDGE</b>      | 3. <b>TOP LAM</b>                     |
| 4. <b>CHASSIS WOOD FINISH</b>         | 4. <b>CHASSIS LAM</b>                 |
| 5. <b>TOP FINISH</b>                  | 5. <b>EDGE DETAIL</b>                 |
| 6. <b>HAT KEYPAD &amp; BASE COLOR</b> | 6. <b>HAT KEYPAD &amp; BASE COLOR</b> |
| 7. <b>GROMMET</b>                     | 7. <b>GROMMET</b>                     |

Optional height adjustable keypads available

### HAT KEYPAD & BASE COLOR

Basic Up/Down Keypad, Black P71 Column  
Memory Preset Keypad, Black P71 Column  
Paddle Keypad, Black P71 Column

**UDP71**  
**MEMP71**  
**PDLP71**

# CANTILEVER HEIGHT ADJUSTABLE DESKS - RECTANGULAR

Right Hand Desk

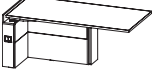
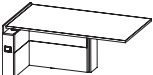
	D	W	H	model number + type	laminata	veneer 1	veneer 2	veneer 3	
<b>36" DEPTH</b> 	36	66	29 1/2	<b>GS5CVATR3666R-</b> [ ]	8,422	12,059	13,265	14,471	
	• 22 1/2" end overhang, 6" guest overhang								
	36	72	29 1/2	<b>GS5CVATR3672R-</b> [ ]	8,481	12,142	13,357	14,571	
	• 28 1/2" end overhang, 6" guest overhang								
	36	78	29 1/2	<b>GS5CVATR3678R-</b> [ ]	8,890	12,583	13,842	15,100	
	• 34 1/2" end overhang, 6" guest overhang								
<b>42" DEPTH</b> 	42	66	29 1/2	<b>GS5CVATR4266R-</b> [ ]	8,962	12,920	14,212	15,504	
	• 22 1/2" end overhang, 9" guest overhang								
	42	72	29 1/2	<b>GS5CVATR4272R-</b> [ ]	9,038	13,026	14,329	15,632	
	• 28 1/2" end overhang, 9" guest overhang								
	42	78	29 1/2	<b>GS5CVATR4278R-</b> [ ]	9,468	13,496	14,846	16,196	
	• 34 1/2" end overhang, 9" guest overhang								
	42	84	29 1/2	<b>GS5CVATR4284R-</b> [ ]	9,576	13,649	15,014	16,379	
• 40 1/2" end overhang, 9" guest overhang									

## PRODUCT INFO

### Unit must be wall mounted.

Top depth 1" shallower than chassis on user and guest sides to accommodate pinch points of adjoining units

29.5" to 42.5" height adjustment range

 All units shipped as separate packages and require field assembly.

### Grommet Location

(Add \$80 per grommet)

No Grommet **GN**  
Left **GL**

Specify location first, then select grommet color or "Empty Cutout" option. When "Empty Cutout" option is selected, a grommet or power unit must be ordered separately for each cutout.

NOTE: Monitor arms should **ALWAYS** be installed in grommets on Silea height adjustable units. Please ensure a grommet location is specified on the top. This allows for bolt mount or clamp mount install of monitor arm. See page 35 for details.

## TO ORDER PLEASE SPECIFY THE FOLLOWING:

WOOD TOP, WOOD CHASSIS

- MODEL NUMBER + WW**
- FSC**
- TOP WOOD FINISH + EDGE**
- CHASSIS WOOD FINISH**
- TOP FINISH**
- HAT KEYPAD & BASE COLOR**
- GROMMET**

LAM TOP, LAM CHASSIS

- MODEL NUMBER + LL**
- FSC**
- TOP LAM**
- CHASSIS LAM**
- EDGE DETAIL**
- HAT KEYPAD & BASE COLOR**
- GROMMET**

Optional height adjustable keypads available

### HAT KEYPAD & BASE COLOR

Basic Up/Down Keypad, Black P71 Column  
Memory Preset Keypad, Black P71 Column  
Paddle Keypad, Black P71 Column

**UDP71**  
**MEMP71**  
**PDLP71**

# CANTILEVER HEIGHT ADJUSTABLE DESKS - SIGHTLINE

Silea

02/24

Left Hand Desk

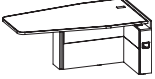
	D	W	H	model number + type	laminate	veneer 1	veneer 2	veneer 2	
<b>42" DEPTH</b> 	30-42	66	29 1/2	<b>GS5CVATS304266L-</b> [ ]	9,129	13,154	14,470	15,785	
	• 22 1/2" end overhang, 9" tapered guest overhang								
	30-42	72	29 1/2	<b>GS5CVATS304272L-</b> [ ]	9,213	13,273	14,601	15,928	
	• 28 1/2" end overhang, 9" tapered guest overhang								
	30-42	78	29 1/2	<b>GS5CVATS304278L-</b> [ ]	9,655	13,761	15,138	16,514	
• 34 1/2" end overhang, 9" tapered guest overhang									
	30-42	84	29 1/2	<b>GS5CVATS304284L-</b> [ ]	9,776	13,932	15,326	16,719	
• 40 1/2" end overhang, 9" tapered guest overhang									

## PRODUCT INFO

### Unit must be wall mounted.

Top depth 1" shallower than chassis on user and guest sides to accommodate pinch points of adjoining units

29.5" to 42.5" height adjustment range

 All units shipped as separate packages and require field assembly.

### Grommet Location (Add \$80 per grommet)

No Grommet **GN**  
 Right **GR**  
 Specify location first, then select grommet color or "Empty Cutout" option. When "Empty Cutout" option is selected, a grommet or power unit must be ordered separately for each cutout.

NOTE: Monitor arms should **ALWAYS** be installed in grommets on Silea height adjustable units. Please ensure a grommet location is specified on the top. This allows for bolt mount or clamp mount install of monitor arm. See page 35 for details.

## TO ORDER PLEASE SPECIFY THE FOLLOWING:

WOOD TOP, WOOD CHASSIS

- MODEL NUMBER + WW**
- FSC**
- TOP WOOD FINISH + EDGE**
- CHASSIS WOOD FINISH**
- TOP FINISH**
- HAT KEYPAD & BASE COLOR**
- GROMMET**

LAM TOP, LAM CHASSIS

- MODEL NUMBER + LL**
- FSC**
- TOP LAM**
- CHASSIS LAM**
- EDGE DETAIL**
- HAT KEYPAD & BASE COLOR**
- GROMMET**

Optional height adjustable keypads available

### HAT KEYPAD & BASE COLOR

Basic Up/Down Keypad, Black P71 Column  
 Memory Preset Keypad, Black P71 Column  
 Paddle Keypad, Black P71 Column

**UDP71**  
**MEMP71**  
**PDLP71**

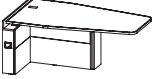
	D	W	H	model number + type	laminata	veneer 1	veneer 2	veneer 3	
<b>42" DEPTH</b> 	30-42	66	29 1/2	<b>GS5CVATS304266R-</b> [ ]	9,129	13,154	14,470	15,785	
	• 22 1/2" end overhang, 9" tapered guest overhang								
	30-42	72	29 1/2	<b>GS5CVATS304272R-</b> [ ]	9,213	13,273	14,601	15,928	
	• 28 1/2" end overhang, 9" tapered guest overhang								
	30-42	78	29 1/2	<b>GS5CVATS304278R-</b> [ ]	9,655	13,761	15,138	16,514	
• 34 1/2" end overhang, 9" tapered guest overhang									
	30-42	84	29 1/2	<b>GS5CVATS304284R-</b> [ ]	9,776	13,932	15,326	16,719	
• 40 1/2" end overhang, 9" tapered guest overhang									

## PRODUCT INFO

### Unit must be wall mounted.

Top depth 1" shallower than chassis on user and guest sides to accommodate pinch points of adjoining units

29.5" to 42.5" height adjustment range

 All units shipped as separate packages and require field assembly.

### Grommet Location

(Add \$80 per grommet)

No Grommet **GN**  
Left **GL**

Specify location first, then select grommet color or "Empty Cutout" option. When "Empty Cutout" option is selected, a grommet or power unit must be ordered separately for each cutout.

NOTE: Monitor arms should **ALWAYS** be installed in grommets on Silea height adjustable units. Please ensure a grommet location is specified on the top. This allows for bolt mount or clamp mount install of monitor arm. See page 35 for details.

## TO ORDER PLEASE SPECIFY THE FOLLOWING:

WOOD TOP, WOOD CHASSIS

- MODEL NUMBER + WW**
- FSC**
- TOP WOOD FINISH + EDGE**
- CHASSIS WOOD FINISH**
- TOP FINISH**
- HAT KEYPAD & BASE COLOR**
- GROMMET**

LAM TOP, LAM CHASSIS

- MODEL NUMBER + LL**
- FSC**
- TOP LAM**
- CHASSIS LAM**
- EDGE DETAIL**
- HAT KEYPAD & BASE COLOR**
- GROMMET**

Optional height adjustable keypads available

### HAT KEYPAD & BASE COLOR

Basic Up/Down Keypad, Black P71 Column  
Memory Preset Keypad, Black P71 Column  
Paddle Keypad, Black P71 Column

**UDP71**  
**MEMP71**  
**PDL71**

# SMART PEDESTALS

7 1/4 Depth

Silea

02/24

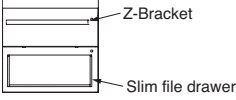
	D	W	H	model number + type	laminate	veneer 1	veneer 2	veneer 3	
<b>SINGLE UNIT</b>  	7 1/4	30	29 1/2	<b>GS5CPD730-S</b> [ ]	2,038	2,580	2,838	3,096	
	<ul style="list-style-type: none"> <li>• Bottom Door: 30" Slim File Drawer included.</li> <li>• Top Door: Includes z-bracket for clip-in accessory Bins and Trays. <u>Bins and trays must be ordered separately.</u></li> </ul>								
	7 1/4	36	29 1/2	<b>GS5CPD736-S</b> [ ]	2,240	2,839	3,123	3,407	
	<ul style="list-style-type: none"> <li>• Bottom Door: 36" Slim File Drawer included.</li> <li>• Top Door: Includes z-bracket for clip-in accessory Bins and Trays. <u>Bins and trays must be ordered separately.</u></li> </ul>								
	7 1/4	42	29 1/2	<b>GS5CPD742-S</b> [ ]	2,463	3,122	3,435	3,747	
<ul style="list-style-type: none"> <li>• Bottom Door: 36" Slim File Drawer included.</li> <li>• Top Door: Includes z-bracket for clip-in accessory Bins and Trays. <u>Bins and trays must be ordered separately.</u></li> </ul>									
7 1/4	48	29 1/2	<b>GS5CPD748-S</b> [ ]	2,828	3,582	3,941	4,299		
<ul style="list-style-type: none"> <li>• Bottom Door: 30" Slim File Drawer + 15" Slim File Drawer included.</li> <li>• Top Door: Includes z-bracket for clip-in accessory Bins and Trays. <u>Bins and trays must be ordered separately.</u></li> </ul>									
7 1/4	54	29 1/2	<b>GS5CPD754-S</b> [ ]	2,970	3,760	4,136	4,512		
<ul style="list-style-type: none"> <li>• Bottom Door: 36" Slim File Drawer + 15" Slim File Drawer included.</li> <li>• Top Door: Includes z-bracket for clip-in accessory Bins and Trays. <u>Bins and trays must be ordered separately.</u></li> </ul>									

## PRODUCT INFO

**Unit must be wall mounted.**

**Grommet Location**  
(Add \$80 per grommet)

No Grommet **GN**  
Left **GL**  
Right **GR**

Specify location first, then select grommet color or "Empty Cutout" option. When "Empty Cutout" option is selected, a grommet or power unit must be ordered separately for each cutout.

"E" grommet cutout option for rect. grommet or bezel mount power unit model # ACUNOBZL-EU

"3E" grommet cutout option is 3" dia and to be used with HQ power w/ wireless charging model # ACPHQ3QI

## TO ORDER PLEASE SPECIFY THE FOLLOWING:

### WOOD

- MODEL NUMBER + W**
- FSC**
- CHASSIS WOOD FINISH**
- PULL FOR BOTTOM DOOR**
- GROMMET**
- SIDE WIRE MGT GROMMET**
- LOCKS**

### LAM

- MODEL NUMBER + L**
- FSC**
- CHASSIS LAM**
- FRONT LAM**
- PULL FOR BOTTOM DOOR**
- GROMMET**
- SIDE WIRE MGT GROMMET**
- LOCKS**

**Pull Option:** Bottom door available with standard metal pulls or leather pull. (note: top door is taller than chassis to provide a finger pull to open door)

Leather pull available in 3 colors: Black Bridle **LP12**  
Medium Brown Bridle **LP13**  
Grey Bridle **LP14**

**Side Wire Management Grommet Option:** A rectangular cutout may be added to end panels to provide horizontal wire management within a station.

No Side Wire Management Grommets **WN**  
Side Wire Management Grommet Left **WL**  
Side Wire Management Grommet Right **WR**  
Side Wire Management Grommet Left & Right **WB**

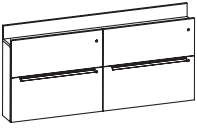
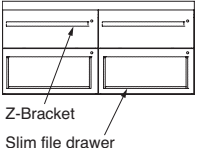
	D	W	H	model number + type	laminate	vener 1	vener 2	vener 3	
<b>DOUBLE UNIT</b>   <p>Z-Bracket Slim file drawer</p>	7 1/4	60	29 1/2	<b>GS5CPD760-S</b> [ ]	3,283	4,157	4,573	4,989	
	<ul style="list-style-type: none"> <li>Bottom Door: 30" Slim File Drawer + 30" Slim File Drawer included.</li> <li>Top Door: Includes z-bracket for clip-in accessory Bins and Trays. <u>Bins and trays must be ordered separately.</u></li> </ul>								
	7 1/4	66	29 1/2	<b>GS5CPD766-S</b> [ ]	3,447	4,364	4,801	5,237	
<ul style="list-style-type: none"> <li>Bottom Door: 30" Slim File Drawer + 36" Slim File Drawer included.</li> <li>Top Door: Includes z-bracket for clip-in accessory Bins and Trays. <u>Bins and trays must be ordered separately.</u></li> </ul>									
7 1/4	72	29 1/2	<b>GS5CPD772-S</b> [ ]	3,619	4,581	5,040	5,498		
<ul style="list-style-type: none"> <li>Bottom Door: 36" Slim File Drawer + 36" Slim File Drawer included.</li> <li>Top Door: Includes z-bracket for clip-in accessory Bins and Trays. <u>Bins and trays must be ordered separately.</u></li> </ul>									

**PRODUCT INFO**

**Unit must be wall mounted.**

**Grommet Location**

(Add \$80 per grommet)

No Grommet **GN**  
 Left **GL**  
 Right **GR**

Specify location first, then select grommet color or "Empty Cutout" option. When "Empty Cutout" option is selected, a grommet or power unit must be ordered separately for each cutout.

"E" grommet cutout option for rect. grommet or bezel mount power unit model # ACUNOBZL-EU

"3E" grommet cutout option is 3" dia and to be used with HQ power w/ wireless charging model # ACPHQ3QI

**TO ORDER PLEASE SPECIFY THE FOLLOWING:**

WOOD

- MODEL NUMBER + W**
- FSC**
- CHASSIS WOOD FINISH**
- PULL FOR BOTTOM DOOR**
- GROMMET**
- SIDE WIRE MGT GROMMET**
- LOCKS**

LAM

- MODEL NUMBER + L**
- FSC**
- CHASSIS LAM**
- FRONT LAM**
- PULL FOR BOTTOM DOOR**
- GROMMET**
- SIDE WIRE MGT GROMMET**
- LOCKS**

**Pull Option:** Bottom door available with standard metal pulls or leather pull. (note: top door is taller than chassis to provide a finger pull to open door)



Leather pull available in 3 colors: Black Bridle **LP12**  
 Medium Brown Bridle **LP13**  
 Grey Bridle **LP14**

**Side Wire Management Grommet Option:** A rectangular cutout may be added to end panels to provide horizontal wire management within a station.

No Side Wire Management Grommets **WN**  
 Side Wire Management Grommet Left **WL**  
 Side Wire Management Grommet Right **WR**  
 Side Wire Management Grommet Left & Right **WB**

# SMART PEDESTAL ACCESSORY TRAYS AND BINS

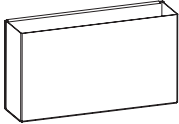
Silea  
02/24

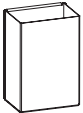
	D	W	H	model number	list
<b>LARGE TRAY</b> 	3	11 1/4	1 1/2	<b>GS5TRAY-LG</b>	92
<b>LARGE BIN</b> 	3	11 1/4	6 1/4	<b>GS5BIN-LG</b>	98
<b>SMALL TRAY</b> 	3	4 1/4	1 1/2	<b>GS5TRAY-SM</b>	84
<b>SMALL BIN</b> 	3	4 1/4	6 1/4	<b>GS5BIN-SM</b>	92

The below matrix recommendation provides a quick reference for ordering Trays and Bins to clip-in upper door of smart pedestals.

Smart Pedestal Model	Usable Inside Width	Recommended Accessories
	For Accessories	Large Tray/Bin + Small Tray/Bin
<b>GS5CPD730-S</b>	20.25	qty 1 + qty 2
<b>GS5CPD736-S</b>	26.25	qty 2 + -
<b>GS5CPD742-S</b>	32.25	qty 2 + qty 2
<b>GS5CPD748-S</b>	38.25	qty 3 + qty 1
<b>GS5CPD754-S</b>	44.25	qty 3 + qty 2
<b>GS5CPD760-S</b>	equivalent to qty (2) 30" smart pedestals	
<b>GS5CPD766-S</b>	equivalent to qty (1) 30" + qty (1) 36" smart pedestal	
<b>GS5CPD772-S</b>	equivalent to qty (2) 36" smart pedestals	

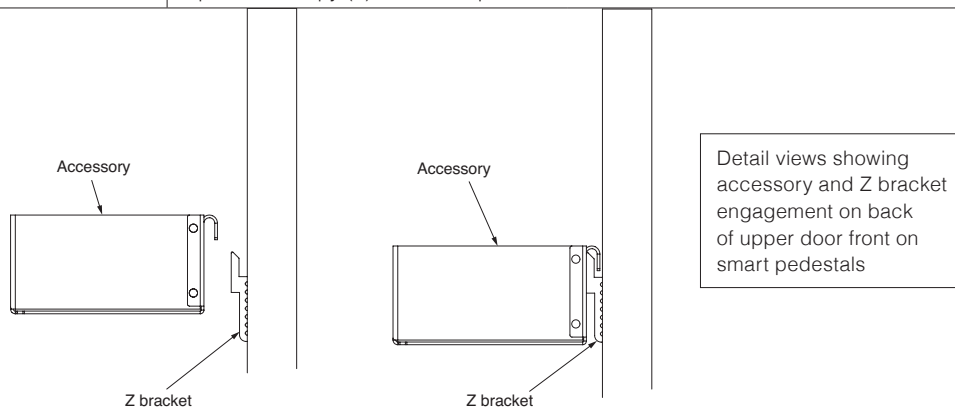

## PRODUCT INFO

Accessories clip into Z bracket included on top door of smart pedestals.

Inside bottom of unit is lined with felt.

## TO ORDER PLEASE SPECIFY THE FOLLOWING:

### LIST

- 1. MODEL NUMBER**
- 2. HARDWARE COLOR**

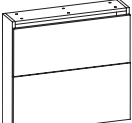

	D	W	H	model number + type	laminata	vener 1	vener 2	vener 3
<b>FALSE PEDESTALS FOR FIXED DESK OR FIXED RETURN</b>  	7 1/4	24	27 7/8	<b>GS5CPD724-X</b> [ ]	1,037	1,412	1,554	1,695
	7 1/4	30	27 7/8	<b>GS5CPD730-X</b> [ ]	1,084	1,477	1,625	1,773
	7 1/4	36	27 7/8	<b>GS5CPD736-X</b> [ ]	1,132	1,545	1,700	1,854
	7 1/4	42	27 7/8	<b>GS5CPD742-X</b> [ ]	1,182	1,613	1,775	1,936

**Notes:**

- Top door hinged for wall access.
- Door split height matches smart pedestals.
- Must be wall mounted.

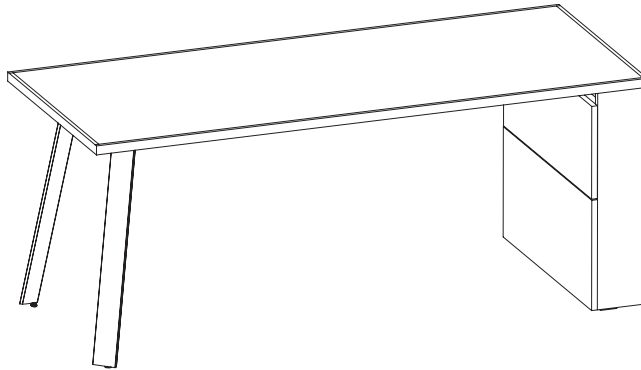

Example: False pedestal shown in application to support a fixed desk or return.

GS5CPD730-XW (false pedestal)  
GS2DWRR3072-W (desk worksurface)  
GS2ALEG-A (angled legs)

PRODUCT INFO	TO ORDER PLEASE SPECIFY THE FOLLOWING:									
<b>Unit must be wall mounted.</b>	WOOD	LAM								
	<ol style="list-style-type: none"> <li><b>MODEL NUMBER + W</b></li> <li><b>FSC</b></li> <li><b>CHASSIS WOOD FINISH</b></li> <li><b>SIDE WIRE MGT GROMMET</b></li> </ol>	<ol style="list-style-type: none"> <li><b>MODEL NUMBER + L</b></li> <li><b>FSC</b></li> <li><b>CHASSIS LAM</b></li> <li><b>FRONT LAM</b></li> <li><b>SIDE WIRE MGT GROMMET</b></li> </ol>								
	<p><b>Side Wire Management Grommet Option:</b> A rectangular cutout may be added to end panels to provide horizontal wire management within a station.</p> <table> <tr> <td>No Side Wire Management Grommets</td> <td><b>WN</b></td> </tr> <tr> <td>Side Wire Management Grommet Left</td> <td><b>WL</b></td> </tr> <tr> <td>Side Wire Management Grommet Right</td> <td><b>WR</b></td> </tr> <tr> <td>Side Wire Management Grommet Left &amp; Right</td> <td><b>WB</b></td> </tr> </table>		No Side Wire Management Grommets	<b>WN</b>	Side Wire Management Grommet Left	<b>WL</b>	Side Wire Management Grommet Right	<b>WR</b>	Side Wire Management Grommet Left & Right	<b>WB</b>
No Side Wire Management Grommets	<b>WN</b>									
Side Wire Management Grommet Left	<b>WL</b>									
Side Wire Management Grommet Right	<b>WR</b>									
Side Wire Management Grommet Left & Right	<b>WB</b>									

# SMART CLOSETS

7 1/4 Depth

Silea

02/24

	D	W	H	model number + type	laminata	veneer 1	veneer 2	veneer 3
<b>18" WIDE CLOSET</b> 	7 1/4	18	68 9/16	<b>GS5CLS5H718L-</b> [ ]	2,937	3,719	4,091	4,463
	7 1/4	18	68 9/16	<b>GS5CLS5H718R-</b> [ ]	2,937	3,719	4,091	4,463

- Behind Door - Coat hook top, 3 Metal trays bottom

Left hand shown  
 Inside cabinet views shown  
 without door

## 30" WIDE SIDE ACCESS CLOSET (18" WIDE CLOSET + 12" SIDE ACCESS)

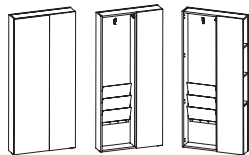

Left hand shown  
 Inside cabinet views shown  
 without door

7 1/4	30	68 9/16	<b>GS5CLS5H730L-</b> [ ]	3,807	4,824	5,307	5,789
7 1/4	30	68 9/16	<b>GS5CLS5H730R-</b> [ ]	3,807	4,824	5,307	5,789

- Behind Door - Coat hook top, 3 Metal trays bottom
- Side Access - Fixed front does not open. 12.5" inside width x 5.75" inside depth. Includes 2 adjustable shelves on 5 hole pattern.

### PRODUCT INFO

**Unit must be wall mounted.**

Coat hook and metal trays are black.

### TO ORDER PLEASE SPECIFY THE FOLLOWING:

#### WOOD

1. **MODEL NUMBER + WW**
2. **FSC**
3. **CHASSIS WOOD FINISH**
4. **LOCKS**

#### LAM

1. **MODEL NUMBER + LL**
2. **FSC**
3. **CHASSIS LAM**
4. **FRONT LAM**
5. **LOCKS**

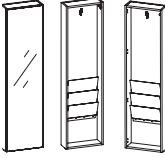
	D	W	H	model number + type	laminata	veneer 1	veneer 2	veneer 3
	7 1/4	18	68 9/16	<b>GS5CLS5H718L-</b> [ ]	N/A	4,464	4,911	5,357
	7 1/4	18	68 9/16	<b>GS5CLS5H718R-</b> [ ]	N/A	4,464	4,911	5,357

- Behind Door - Coat hook top, 3 Metal trays bottom

Left hand shown  
Inside cabinet views shown  
without door

**30" WIDE SIDE ACCESS  
CLOSET (18" WIDE CLOSET  
+ 12" SIDE ACCESS)**

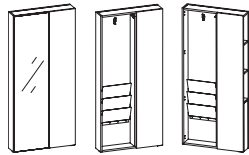

	7 1/4	30	68 9/16	<b>GS5CLS5H730L-</b> [ ]	N/A	5,787	6,366	6,945
	7 1/4	30	68 9/16	<b>GS5CLS5H730R-</b> [ ]	N/A	5,787	6,366	6,945

- Behind Door - Coat hook top, 3 Metal trays bottom
- Side Access - Fixed front does not open. 12.5" inside width x 5.75" inside depth. Includes 2 adjustable shelves on 5 hole pattern.
- Glass door over closet portion only. Side access fixed front matches chassis finish.

Left hand shown  
Inside cabinet views shown  
without door

**PRODUCT INFO**

**Unit must be wall mounted.**

Glass doors do NOT lock.

Coat hook and metal trays are black.

**TO ORDER PLEASE SPECIFY THE FOLLOWING:**

WOOD CHASSIS, GLASS DOOR

- 1. MODEL NUMBER + WG**
- 2. FSC**
- 3. CHASSIS WOOD FINISH**
- 4. GLASS**

# SMART LOCKERS

7 1/4 Depth

Silea  
02/24

	D	W	H	model number + type	laminate	veneer 1	veneer 2	veneer 3
<b>24" WIDE LOCKER</b> 	7 1/4	24	68 9/16	<b>GS5LKR5H724L-</b> [ ]	3,135	4,091	4,501	4,910
	7 1/4	24	68 9/16	<b>GS5LKR5H724R-</b> [ ]	3,135	4,091	4,501	4,910

- Behind Door - Coat hook top, 3 Metal trays bottom
- Door overhangs chassis by 6". Additional coat hook on end panel.

Left hand shown  
Inside cabinet views shown  
without door

## 36" WIDE SIDE ACCESS LOCKER (24" WIDE LOCKER + 12" SIDE ACCESS)

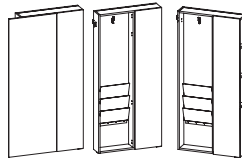

	7 1/4	36	68 9/16	<b>GS5LKR5H736L-</b> [ ]	4,066	5,305	5,836	6,366
	7 1/4	36	68 9/16	<b>GS5LKR5H736R-</b> [ ]	4,066	5,305	5,836	6,366

- Behind Door - Coat hook top, 3 Metal trays bottom
- Door overhangs chassis by 6". Additional coat hook on end panel.
- Side Access - Fixed front does not open. 12.5" inside width x 5.75" inside depth. Includes 2 adjustable shelves on 5 hole pattern.

Left hand shown  
Inside cabinet views shown  
without door

### PRODUCT INFO

#### Unit must be wall mounted.

Doors do NOT lock.

Coat hook and metal trays are black.

 Laminate units shipped as separate packages and require field assembly.

### TO ORDER PLEASE SPECIFY THE FOLLOWING:

#### WOOD

1. **MODEL NUMBER + WW**
2. **FSC**
3. **CHASSIS WOOD FINISH**

#### LAM

1. **MODEL NUMBER + LL**
2. **FSC**
3. **CHASSIS LAM**
4. **FRONT LAM**

	D	W	H	model number + type	laminated	veneer 1	veneer 2	veneer 3
<b>24" WIDE LOCKER</b>	7 1/4	24	68 9/16	<b>GS5LKR5H724L-</b> [ ]	4,106	4,908	5,399	5,890
	7 1/4	24	68 9/16	<b>GS5LKR5H724R-</b> [ ]	4,106	4,908	5,399	5,890

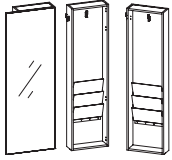

Left hand shown  
Inside cabinet views shown  
without door

- Behind Door - Coat hook top, 3 Metal trays bottom
- Door overhangs chassis by 6". Additional coat hook on end panel.

**36" WIDE SIDE ACCESS  
LOCKER (24" WIDE LOCKER  
+ 12" SIDE ACCESS)**

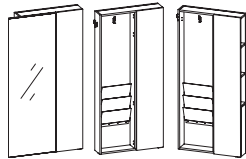

Left hand shown  
Inside cabinet views shown  
without door

	7 1/4	36	68 9/16	<b>GS5LKR5H736L-</b> [ ]	5,037	6,366	7,003	7,640
	7 1/4	36	68 9/16	<b>GS5LKR5H736R-</b> [ ]	5,037	6,366	7,003	7,640

- Behind Door - Coat hook top, 3 Metal trays bottom
- Door overhangs chassis by 6". Additional coat hook on end panel.
- Side Access - Fixed front does not open. 12.5" inside width x 5.75" inside depth. Includes 2 adjustable shelves on 5 hole pattern.

**PRODUCT INFO**

**Unit must be wall mounted.**

Doors do NOT lock.

Coat hook and metal trays are black.

 Laminate units shipped as separate packages and require field assembly.

**TO ORDER PLEASE SPECIFY THE FOLLOWING:**

WOOD CHASSIS, GLASS DOOR

1. **MODEL NUMBER + WG**
2. **FSC**
3. **CHASSIS WOOD FINISH**
4. **GLASS**

LAM CHASSIS, GLASS DOOR

1. **MODEL NUMBER + LG**
2. **FSC**
3. **CHASSIS LAM**
4. **GLASS**

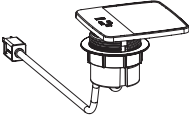
	D	W	H	model number	472
<b>HQ POWER W/ WIRELESS CHARGING TO BE USED IN 3" DIA GROMMET CUTOUT</b> 	3	11 1/4	1 1/2	<b>ACPHQ3QI-B</b>	472
	<ul style="list-style-type: none"> <li>• Black</li> <li>• Fits 3" Dia Cutout option in smart pedestals</li> <li>• 1 Power / 1 USB Charger / 1 Charging Pad</li> <li>• 10ft standard plug cord</li> </ul>				
	3	11 1/4	6 1/4	<b>ACPHQ3QI-S</b>	472
<ul style="list-style-type: none"> <li>• Silver</li> <li>• Fits 3" Dia Cutout option in smart pedestals</li> <li>• 1 Power / 1 USB Charger / 1 Charging Pad</li> <li>• 10ft standard plug cord</li> </ul>					

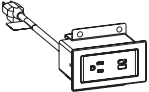
<b>BEZEL MOUNT POWER TO BE USED IN RECTANGULAR GROMMET CUTOUT</b>  <p>Can be used in grommet cutout</p>	2 7/8	4	1 3/4	<b>ACUNOBZL-EU</b>	444
	<ul style="list-style-type: none"> <li>• Optional color</li> <li>• Fits Rectangular Grommet Cutout option in smart pedestals</li> <li>• 1 Power / 2 USB Charger</li> <li>• 10ft standard plug cord</li> </ul>				
	2 7/8	4	1 3/4	<b>ACUNOBZL-EU-HW</b>	444
<ul style="list-style-type: none"> <li>• Optional color</li> <li>• Fits Rectangular Grommet Cutout option in smart pedestals</li> <li>• 1 Power / 2 USB Charger</li> <li>• 6ft hardwire cord</li> </ul>					

## PRODUCT INFO

## TO ORDER PLEASE SPECIFY THE FOLLOWING:

LIST

1. **MODEL NUMBER**
2. **BEZEL MOUNT POWER COLOR**

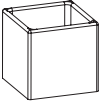
	D	W	H	model number	list
<b>PENCIL TRAY</b> 	3 15/16	11 5/16	1 1/4	<b>GS5PNCLTRAY-WLNT</b>	217
	<ul style="list-style-type: none"> <li>• Walnut, clear finish</li> <li>• Fits in 15" box drawer</li> </ul>				
	3 15/16	11 5/16	1 1/4	<b>GS5PNCLTRAY-MPLE</b>	217
<ul style="list-style-type: none"> <li>• Maple, clear finish</li> <li>• Fits in 15" box drawer</li> </ul>					
<b>PENCIL CUP</b> 	3 15/16	3 15/16	3 3/4	<b>GS5PNCLCUP-WLNT</b>	217
	<ul style="list-style-type: none"> <li>• Walnut, clear finish</li> </ul>				
	3 15/16	3 15/16	3 3/4	<b>GS5PNCLCUP-MPLE</b>	217
<ul style="list-style-type: none"> <li>• Maple, clear finish</li> </ul>					

**PRODUCT INFO**

Solidwood accessories include rubber bumpers on bottom to protect worksurfaces

**TO ORDER PLEASE SPECIFY THE FOLLOWING:**

LIST

- 1. MODEL NUMBER**







Storage .....	235-265
Bookcases .....	236
Bookcase / Closet .....	237
Lateral Files .....	238-239
Closets .....	240-244
Storage Box / Utility Cabinet .....	245-257
Side Access Storage Locker .....	258-261
Mobile Pedestal .....	262-263
Storage External Tops .....	264-265

# BOOKCASES

2 high – 6 high | 30" & 36"W

Silea

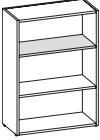
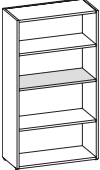
02/24

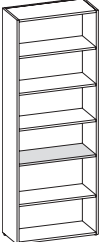
	D	W	H	model number + type	laminate	veneer 1	veneer 2	veneer 3
<b>30" &amp; 36 WIDTH</b>								
 28 High	14 7/8	30	27 7/8	<b>GS2BKN2H30N-</b> [ ]	1,508	1,909	2,100	2,291
	14 7/8	36	27 7/8	<b>GS2BKN2H36N-</b> [ ]	1,608	2,034	2,238	2,441
 42 High	14 7/8	30	42 3/16	<b>GS2BKN3H30-</b> [ ]	1,975	2,501	2,752	3,002
	14 7/8	36	42 3/16	<b>GS2BKN3H36-</b> [ ]	2,272	2,878	3,166	3,454
 55 High	14 7/8	30	54 7/16	<b>GS2BKN4H30-</b> [ ]	2,227	2,818	3,100	3,382
	14 7/8	36	54 7/16	<b>GS2BKN4H36-</b> [ ]	3,009	3,811	4,193	4,574
 68 High	14 7/8	30	68 9/16	<b>GS2BKN5H30-</b> [ ]	2,952	3,734	4,108	4,481
	14 7/8	36	68 9/16	<b>GS2BKN5H36-</b> [ ]	3,532	4,472	4,920	5,367
 82 High	14 7/8	30	81 5/16	<b>GS2BKN6H30-</b> [ ]	3,464	4,381	4,820	5,258
	14 7/8	36	81 5/16	<b>GS2BKN6H36-</b> [ ]	3,615	4,578	5,036	5,494

## PRODUCT INFO

Units have a finished back.  
 Each unit has one fixed shelf, shaded above.  
 Top not included.  
 To add storage tops, specify external tops.  
 6H bookcase to be attached to the wall.

## TO ORDER PLEASE SPECIFY THE FOLLOWING:

### WOOD

- MODEL NUMBER + WN**
- FSC**
- CHASSIS WOOD FINISH**

### LAM

- MODEL NUMBER + LN**
- FSC**
- CHASSIS LAM**

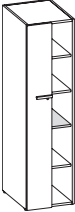
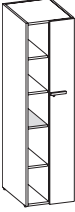
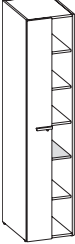
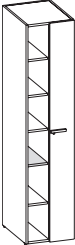
	D	W	H	model number + type	laminate	veneer 1	veneer 2	veneer 3
 <p><b>LEFT HAND</b> 68 High</p>	24	18	68 <sup>9</sup> / <sub>16</sub>	<b>GS2BCL5H18L-</b> [ ]	4,554	6,207	6,828	7,449
 <p><b>RIGHT HAND</b> 68 High</p>	24	18	68 <sup>9</sup> / <sub>16</sub>	<b>GS2BCL5H18R-</b> [ ]	4,554	6,207	6,828	7,449
 <p><b>LEFT HAND</b> 82 High</p>	24	18	81 <sup>15</sup> / <sub>16</sub>	<b>GS2BCL6H18L-</b> [ ]	5,202	7,085	7,794	8,502
 <p><b>RIGHT HAND</b> 82 High</p>	24	18	81 <sup>15</sup> / <sub>16</sub>	<b>GS2BCL6H18R-</b> [ ]	5,202	7,085	7,794	8,502

**PRODUCT INFO**

All units have a finished back.  
5H units include (1) closet rod behind door.  
6H units include (1) closet rod and (1) adjustable shelf.  
Each unit has (1) fixed shelf, highlighted above.

**TO ORDER PLEASE SPECIFY THE FOLLOWING:**

WOOD

1. **MODEL NUMBER + WW**
2. **FSC**
3. **CHASSIS WOOD FINISH**
4. **PULL**
5. **LOCKS**
6. **KEYING**

LAM

1. **MODEL NUMBER + LL**
2. **FSC**
3. **CHASSIS LAM**
4. **FRONT LAM**
5. **PULL**
6. **LOCKS**
7. **KEYING**

# LATERAL FILES 24D

2 high w/top

Silea

02/24

	D	W	H	model number + type	laminate	veneer 1	veneer 2	veneer 3
<b>30" WIDTH</b>	24	30	29 1/2	<b>GS2LFS2H30-</b> [ ]	2,896	3,946	4,341	4,736



<b>36" WIDTH</b>	24	36	29 1/2	<b>GS2LFS2H36-</b> [ ]	3,061	4,169	4,586	5,003
------------------	----	----	--------	------------------------	-------	-------	-------	-------



## PRODUCT INFO

2H lateral file comes with a top.  
All units have a finished back.









## TO ORDER PLEASE SPECIFY THE FOLLOWING:

WOOD TOP, WOOD CHASSIS

1. **MODEL NUMBER + WW**
2. **FSC**
3. **TOP WOOD FINISH + EDGE**
4. **CHASSIS WOOD FINISH**
5. **TOP FINISH**
6. **PULL**
7. **DRAWERS**
8. **KEYING**

LAM TOP, LAM CHASSIS

1. **MODEL NUMBER + LL**
2. **FSC**
3. **TOP LAM**
4. **CHASSIS LAM**
5. **FRONT LAM**
6. **EDGE DETAIL**
7. **PULL**
8. **DRAWERS**
9. **KEYING**

	D	W	H	model number + type	laminata	veneer 1	veneer 2	veneer 3
<b>30" WIDTH</b>    	24	30	42 <sup>3/16</sup>	<b>GS2LFS3H30-</b> [ ]	3,853	5,246	5,771	6,296
	24	30	54 <sup>7/16</sup>	<b>GS2LFS4H30-</b> [ ]	4,802	6,546	7,201	7,856
	24	30	68 <sup>9/16</sup>	<b>GS2LFS5H30-</b> [ ]	6,191	8,433	9,277	10,120
	24	30	81 <sup>15/16</sup>	<b>GS2LFS6H30-</b> [ ]	7,163	9,757	10,733	11,709
<b>36" WIDTH</b>    	24	36	42 <sup>3/16</sup>	<b>GS2LFS3H36-</b> [ ]	3,982	5,427	5,970	6,513
	24	36	54 <sup>7/16</sup>	<b>GS2LFS4H36-</b> [ ]	4,941	6,728	7,401	8,074
	24	36	68 <sup>9/16</sup>	<b>GS2LFS5H36-</b> [ ]	6,516	8,875	9,763	10,650
	24	36	81 <sup>15/16</sup>	<b>GS2LFS6H36-</b> [ ]	7,310	9,961	10,958	11,954

**PRODUCT INFO**

All units have a finished back.  
 If integral pull is chosen for wood, doors will be touch latch.  
 6 high units include (1) adjustable shelf behind doors.  
 5 and 6 high doors do not lock.

**TO ORDER PLEASE SPECIFY THE FOLLOWING:**

WOOD CHASSIS

1. **MODEL NUMBER + WW**
2. **FSC**
3. **CHASSIS WOOD FINISH**
4. **PULL**
5. **DRAWERS**
6. **KEYING**

LAM CHASSIS

1. **MODEL NUMBER + LL**
2. **FSC**
3. **CHASSIS LAM**
4. **FRONT LAM**
5. **PULL**
6. **DRAWERS**
7. **KEYING**

# CLOSETS 24D

5 high – 6 high

Silea

02/24

	D	W	H	model number + type	laminate	veneer 1	veneer 2	veneer 3
<b>15" WIDTH</b>	24	15	68 <sup>9</sup> / <sub>16</sub>	<b>GS2CLS5H15L-</b> [ ]	2,873	3,915	4,307	4,698
	24	15	68 <sup>9</sup> / <sub>16</sub>	<b>GS2CLS5H15R-</b> [ ]	2,873	3,915	4,307	4,698
 Door hinged left 68 High	24	15	81 <sup>15</sup> / <sub>16</sub>	<b>GS2CLS6H15L-</b> [ ]	3,152	4,295	4,725	5,154
	24	15	81 <sup>15</sup> / <sub>16</sub>	<b>GS2CLS6H15R-</b> [ ]	3,152	4,295	4,725	5,154

• 6H x 15W units must be attached to wall for stability. Wall attach hardware not provided.

<b>18" WIDTH</b>	24	18	68 <sup>9</sup> / <sub>16</sub>	<b>GS2CLS5H18L-</b> [ ]	3,017	4,110	4,521	4,932
	24	18	68 <sup>9</sup> / <sub>16</sub>	<b>GS2CLS5H18R-</b> [ ]	3,017	4,110	4,521	4,932
 Door hinged left 68 High	24	18	81 <sup>15</sup> / <sub>16</sub>	<b>GS2CLS6H18L-</b> [ ]	3,319	4,521	4,974	5,426
	24	18	81 <sup>15</sup> / <sub>16</sub>	<b>GS2CLS6H18R-</b> [ ]	3,319	4,521	4,974	5,426

## PRODUCT INFO

All units have a finished back.

If integral pull is chosen for wood, doors will be touch latch.

Units include (1) closet rod and (1) fixed shelf at bottom.

## TO ORDER PLEASE SPECIFY THE FOLLOWING:

### WOOD CHASSIS

1. **MODEL NUMBER + WW**
2. **FSC**
3. **CHASSIS WOOD FINISH**
4. **PULL**
5. **LOCKS**
6. **KEYING**

### LAM CHASSIS

1. **MODEL NUMBER + LL**
2. **FSC**
3. **CHASSIS LAM**
4. **FRONT LAM**
5. **PULL**
6. **LOCKS**
7. **KEYING**

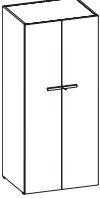
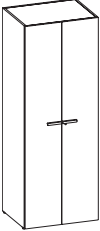
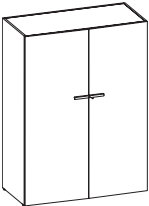
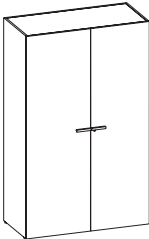
	D	W	H	model number + type	laminate	veneer 1	veneer 2	veneer 3
<b>30" WIDTH</b>  68 High	24	30	68 <sup>9</sup> / <sub>16</sub>	<b>GS2CLD5H30-D</b> [ ]	5,444	6,888	7,577	8,266
	24	30	68 <sup>9</sup> / <sub>16</sub>	<b>GS2CLD5H30-S</b> [ ]	5,078	6,422	7,065	7,707
 82 High	24	30	81 <sup>15</sup> / <sub>16</sub>	<b>GS2CLD6H30-D</b> [ ]	6,356	8,041	8,846	9,650
	24	30	81 <sup>15</sup> / <sub>16</sub>	<b>GS2CLD6H30-S</b> [ ]	5,977	7,560	8,316	9,072
<b>36" WIDTH</b>  68 High	24	36	68 <sup>9</sup> / <sub>16</sub>	<b>GS2CLD5H36-D</b> [ ]	5,987	7,578	8,336	9,094
	24	36	68 <sup>9</sup> / <sub>16</sub>	<b>GS2CLD5H36-S</b> [ ]	5,587	7,065	7,772	8,478
 82 High	24	36	81 <sup>15</sup> / <sub>16</sub>	<b>GS2CLD6H36-D</b> [ ]	6,992	8,844	9,729	10,613
	24	36	81 <sup>15</sup> / <sub>16</sub>	<b>GS2CLD6H36-S</b> [ ]	6,572	8,315	9,147	9,978

**PRODUCT INFO**

All units have a finished back.

Closet codes for 68 high units:

D = (4) 1/2 shelves/  
1/2 coat rod

S = (4) full width shelves

Closet codes for 82 high units:

D = (5) 1/2 shelves/  
1/2 coat rod

S = (5) full width shelves

If integral pull is chosen for wood, doors will be touch latch.

**TO ORDER PLEASE SPECIFY THE FOLLOWING:**

WOOD CHASSIS

1. **MODEL NUMBER + WW**
2. **FSC**
3. **CHASSIS WOOD FINISH**
4. **PULL**
5. **LOCKS**
6. **KEYING**

LAM CHASSIS

1. **MODEL NUMBER + LL**
2. **FSC**
3. **CHASSIS LAM**
4. **FRONT LAM**
5. **PULL**
6. **LOCKS**
7. **KEYING**

# CLOSETS WITH GLASS DOORS 24D

5 high – 6 high | 15" & 18"W

Silea

02/24

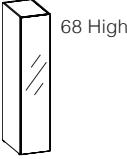
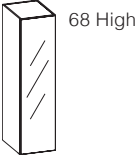
	D	W	H	model number + type	veneer 1 chassis glass door	veneer 2 chassis glass door	veneer 3 chassis glass door
<b>15" WIDTH</b> 	24	15	68 <sup>9</sup> / <sub>16</sub>	<b>GS2CLS5H15L-</b> <input type="checkbox"/>	4,698	5,168	5,638
	24	15	68 <sup>9</sup> / <sub>16</sub>	<b>GS2CLS5H15R-</b> <input type="checkbox"/>	4,698	5,168	5,638
	24	15	81 <sup>15</sup> / <sub>16</sub>	<b>GS2CLS6H15L-</b> <input type="checkbox"/>	5,153	5,669	6,184
	24	15	81 <sup>15</sup> / <sub>16</sub>	<b>GS2CLS6H15R-</b> <input type="checkbox"/>	5,153	5,669	6,184
<ul style="list-style-type: none"> <li>• 6H x 15W units must be attached to wall for stability. Wall attach hardware not provided.</li> </ul>							
<b>18" WIDTH</b> 	24	18	68 <sup>9</sup> / <sub>16</sub>	<b>GS2CLS5H18L-</b> <input type="checkbox"/>	4,932	5,426	5,919
	24	18	68 <sup>9</sup> / <sub>16</sub>	<b>GS2CLS5H18R-</b> <input type="checkbox"/>	4,932	5,426	5,919
	24	18	81 <sup>15</sup> / <sub>16</sub>	<b>GS2CLS6H18L-</b> <input type="checkbox"/>	5,425	5,968	6,510
	24	18	81 <sup>15</sup> / <sub>16</sub>	<b>GS2CLS6H18R-</b> <input type="checkbox"/>	5,425	5,968	6,510

## PRODUCT INFO

All units have a finished back.  
 Glass doors do not lock.  
 Units include (1) closet rod and  
 (1) fixed shelf at bottom.

## TO ORDER PLEASE SPECIFY THE FOLLOWING:

WOOD CHASSIS, GLASS DOOR

1. **MODEL NUMBER + WG**
2. **FSC**
3. **CHASSIS WOOD FINISH**
4. **GLASS**

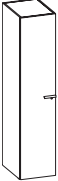

	D	W	H	model number + type	laminate	veneer 1	veneer 2	veneer 3
<b>18" WIDTH</b>  Door hinged left 68 High	30	18	68 <sup>9</sup> / <sub>16</sub>	<b>GS2CLS5H30D18L-</b> [ ]	3,320	4,521	4,974	5,426
	30	18	68 <sup>9</sup> / <sub>16</sub>	<b>GS2CLS5H30D18R-</b> [ ]	3,320	4,521	4,974	5,426
 Door hinged left 82 High	30	18	81 <sup>15</sup> / <sub>16</sub>	<b>GS2CLS6H30D18L-</b> [ ]	3,649	4,974	5,472	5,969
	30	18	81 <sup>15</sup> / <sub>16</sub>	<b>GS2CLS6H30D18R-</b> [ ]	3,649	4,974	5,472	5,969

**PRODUCT INFO**

If integral pull is chosen for wood, doors will be touch latch.  
 Units include (1) closet rod and (1) fixed shelf at bottom.  
 All units have a finished back.  
 30D Laminate units have fasteners on backside with cam covers.

**TO ORDER PLEASE SPECIFY THE FOLLOWING:**

WOOD CHASSIS

1. **MODEL NUMBER + WW**
2. **FSC**
3. **CHASSIS WOOD FINISH**
4. **PULL**
5. **LOCKS**
6. **KEYING**

LAM CHASSIS

1. **MODEL NUMBER + LL**
2. **FSC**
3. **CHASSIS LAM**
4. **FRONT LAM**
5. **PULL**
6. **LOCKS**
7. **KEYING**

# CLOSETS WITH GLASS DOORS 30D

5 high – 6 high

Silea

02/24

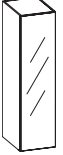
	D	W	H	model number + type	veneer 1 chassis glass door	veneer 2 chassis glass door	veneer 3 chassis glass door
<b>18" WIDTH</b>  68 High	30	18	68 <sup>9</sup> / <sub>16</sub>	<b>GS2CLS5H30D18L-</b> [ ]	5,427	5,970	6,513
	30	18	68 <sup>9</sup> / <sub>16</sub>	<b>GS2CLS5H30D18R-</b> [ ]	5,427	5,970	6,513
	30	18	81 <sup>15</sup> / <sub>16</sub>	<b>GS2CLS6H30D18L-</b> [ ]	5,967	6,564	7,161
	30	18	81 <sup>15</sup> / <sub>16</sub>	<b>GS2CLS6H30D18R-</b> [ ]	5,967	6,564	7,161





## PRODUCT INFO

All units have a finished back.  
 Glass doors do not lock.  
 Units include (1) closet rod and (1) fixed shelf at bottom.  
 All units have a finished back.  
 30D Laminate units have fasteners on backside with cam covers.

## TO ORDER PLEASE SPECIFY THE FOLLOWING:

WOOD CHASSIS, GLASS DOOR

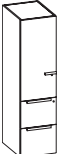
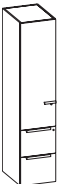
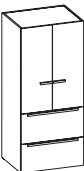
1. **MODEL NUMBER + WG**
2. **FSC**
3. **CHASSIS WOOD FINISH**
4. **GLASS**

	D	W	H	model number + type	laminated	veneer 1	veneer 2	veneer 3	
<b>15" WIDTH</b>									
 Hinged door left 68 High	24	15	68 <sup>9</sup> / <sub>16</sub>	<b>GS2SBD5H15L-</b> [ ]	3,257	4,442	4,887	5,331	
	24	15	68 <sup>9</sup> / <sub>16</sub>	<b>GS2SBD5H15R-</b> [ ]	3,257	4,442	4,887	5,331	
 Hinged door left 82 High	24	15	81 <sup>15</sup> / <sub>16</sub>	<b>GS2SBD6H15L-</b> [ ]	3,583	4,887	5,376	5,865	
	24	15	81 <sup>15</sup> / <sub>16</sub>	<b>GS2SBD6H15R-</b> [ ]	3,583	4,887	5,376	5,865	
• 6H x 15W units must be attached to wall for stability. Wall attach hardware not provided.									
<b>18" WIDTH</b>									
 Hinged door left 68 High	24	18	68 <sup>9</sup> / <sub>16</sub>	<b>GS2SBD5H18L-</b> [ ]	3,428	4,677	5,145	5,613	
	24	18	68 <sup>9</sup> / <sub>16</sub>	<b>GS2SBD5H18R-</b> [ ]	3,428	4,677	5,145	5,613	
 Hinged door left 82 High	24	18	81 <sup>15</sup> / <sub>16</sub>	<b>GS2SBD6H18L-</b> [ ]	3,771	5,145	5,660	6,174	
	24	18	81 <sup>15</sup> / <sub>16</sub>	<b>GS2SBD6H18R-</b> [ ]	3,771	5,145	5,660	6,174	
<b>30" WIDTH</b>									
 68 High	24	30	68 <sup>9</sup> / <sub>16</sub>	<b>GS2SBD5H30-</b> [ ]	5,882	8,016	8,818	9,620	
 82 High	24	30	81 <sup>15</sup> / <sub>16</sub>	<b>GS2SBD6H30-</b> [ ]	6,216	8,469	9,316	10,163	

**PRODUCT INFO**

All units have a finished back.  
If integral pull is chosen for wood, doors will be touch latch.  
5H units include (2) adjustable shelves behind doors.  
6H units include (3) adjustable shelves behind doors.

**TO ORDER PLEASE SPECIFY THE FOLLOWING:**

WOOD CHASSIS

1. MODEL NUMBER + WW
2. FSC
3. CHASSIS WOOD FINISH
4. PULL
5. DRAWERS
6. KEYING





LAM CHASSIS

1. MODEL NUMBER + LL
2. FSC
3. CHASSIS LAM
4. FRONT LAM
5. PULL
6. DRAWERS
7. KEYING

# STORAGE BOX 24D

5 high – 6 high | 15" & 18"W | Box / Box / File

Silea  
02/24

	D	W	H	model number + type	laminate	veneer 1	veneer 2	veneer 3
<b>15" WIDTH</b>								
	24	15	68 <sup>9</sup> / <sub>16</sub>	<b>GS2SBD5H15L-3</b> [ ]	3,421	4,665	5,132	5,598
 Box/Box/File Left 68 High	24	15	68 <sup>9</sup> / <sub>16</sub>	<b>GS2SBD5H15R-3</b> [ ]	3,421	4,665	5,132	5,598
<b>15" WIDTH</b>								
	24	15	81 <sup>15</sup> / <sub>16</sub>	<b>GS2SBD6H15L-3</b> [ ]	3,761	5,131	5,645	6,158
 Box/Box/File Left 82 High	24	15	81 <sup>15</sup> / <sub>16</sub>	<b>GS2SBD6H15R-3</b> [ ]	3,761	5,131	5,645	6,158
• 6H x 15W units must be attached to wall for stability. Wall attach hardware not provided.								
<b>18" WIDTH</b>								
	24	18	68 <sup>9</sup> / <sub>16</sub>	<b>GS2SBD5H18L-3</b> [ ]	3,600	4,911	5,403	5,894
 Box/Box/File Left 68 High	24	18	68 <sup>9</sup> / <sub>16</sub>	<b>GS2SBD5H18R-3</b> [ ]	3,600	4,911	5,403	5,894
<b>18" WIDTH</b>								
	24	18	81 <sup>15</sup> / <sub>16</sub>	<b>GS2SBD6H18L-3</b> [ ]	3,961	5,400	5,940	6,480
 Box/Box/File Left 82 High	24	18	81 <sup>15</sup> / <sub>16</sub>	<b>GS2SBD6H18R-3</b> [ ]	3,961	5,400	5,940	6,480

## PRODUCT INFO

If integral pull is chosen for wood, doors will be touch latch.

5H units include (2) adjustable shelves behind doors.

6H units include (3) adjustable shelves behind doors.





## TO ORDER PLEASE SPECIFY THE FOLLOWING:

### WOOD CHASSIS

1. **MODEL NUMBER + WW**
2. **FSC**
3. **CHASSIS WOOD FINISH**
4. **PULL**
5. **DRAWERS**
6. **KEYING**

### LAM CHASSIS

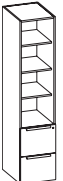
1. **MODEL NUMBER + LL**
2. **FSC**
3. **CHASSIS LAM**
4. **FRONT LAM**
5. **PULL**
6. **DRAWERS**
7. **KEYING**

	D	W	H	model number + type	laminate	veneer 1	veneer 2	veneer 3
<b>15" WIDTH</b>  68 High  82 High	24	15	68 <sup>9</sup> / <sub>16</sub>	<b>GS2SBD5H15-</b> [ ]	3,012	4,109	4,520	4,931
	24	15	81 <sup>15</sup> / <sub>16</sub>	<b>GS2SBD6H15-</b> [ ]	3,316	4,519	4,971	5,423
• 6H x 15W units must be attached to wall for stability. Wall attach hardware not provided.								
<b>18" WIDTH</b>  68 High  82 High	24	18	68 <sup>9</sup> / <sub>16</sub>	<b>GS2SBD5H18-</b> [ ]	3,170	4,324	4,757	5,189
	24	18	81 <sup>15</sup> / <sub>16</sub>	<b>GS2SBD6H18-</b> [ ]	3,489	4,758	5,234	5,710
<b>30" WIDTH</b>  68 High  82 High	24	30	68 <sup>9</sup> / <sub>16</sub>	<b>GS2SBD5H30-</b> [ ]	5,441	7,419	8,161	8,903
	24	30	81 <sup>15</sup> / <sub>16</sub>	<b>GS2SBD6H30-</b> [ ]	5,441	7,419	8,161	8,903

**PRODUCT INFO**

All units have a finished back.  
 If integral pull is chosen for wood, doors will be touch latch.  
 Adjustable shelves.

**TO ORDER PLEASE SPECIFY THE FOLLOWING:**

WOOD CHASSIS

1. **MODEL NUMBER + WN**
2. **FSC**
3. **CHASSIS WOOD FINISH**
4. **PULL**
5. **DRAWERS**
6. **KEYING**





LAM CHASSIS

1. **MODEL NUMBER + LN**
2. **FSC**
3. **CHASSIS LAM**
4. **FRONT LAM**
5. **PULL**
6. **DRAWERS**
7. **KEYING**

# STORAGE BOX 24D

5 high – 6 high | 15" & 18"W | Box / Box / File

Silea  
02/24

	D	W	H	model number + type	laminate	veneer 1	veneer 2	veneer 3
<b>15" WIDTH</b>	24	15	68 <sup>9</sup> / <sub>16</sub>	<b>GS2SBD5H15-3</b> [ ]	3,164	4,314	4,746	5,177
 Box/Box/File 68 High								
 Box/Box/File 82 High	24	15	81 <sup>15</sup> / <sub>16</sub>	<b>GS2SBD6H15-3</b> [ ]	3,480	4,746	5,221	5,696
				• 6H x 15W units must be attached to wall for stability. Wall attach hardware not provided.				
<b>18" WIDTH</b>	24	18	68 <sup>9</sup> / <sub>16</sub>	<b>GS2SBD5H18-3</b> [ ]	3,328	4,542	4,997	5,451
 Box/Box/File 68 High								
 Box/Box/File 82 High	24	18	81 <sup>15</sup> / <sub>16</sub>	<b>GS2SBD6H18-3</b> [ ]	3,663	4,995	5,495	5,994

## PRODUCT INFO

All units have a finished back.  
If integral pull is chosen for wood, doors will be touch latch.  
Adjustable shelves.

## TO ORDER PLEASE SPECIFY THE FOLLOWING:

### WOOD CHASSIS

1. **MODEL NUMBER + WN**
2. **FSC**
3. **CHASSIS WOOD FINISH**
4. **PULL**
5. **DRAWERS**
6. **KEYING**

### LAM CHASSIS

1. **MODEL NUMBER + LN**
2. **FSC**
3. **CHASSIS LAM**
4. **FRONT LAM**
5. **PULL**
6. **DRAWERS**
7. **KEYING**

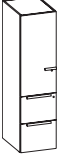
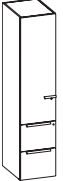
	D	W	H	model number + type	laminate	veneer 1	veneer 2	veneer 3
<b>18" WIDTH</b>	30	18	68 <sup>9</sup> / <sub>16</sub>	<b>GS2SBD5H30D18L-</b> <input type="checkbox"/>	3,771	5,146	5,661	6,176
 Hinged door left 68 High	30	18	68 <sup>9</sup> / <sub>16</sub>	<b>GS2SBD5H30D18R-</b> <input type="checkbox"/>	3,771	5,146	5,661	6,176
 Hinged door left 82 High	30	18	81 <sup>15</sup> / <sub>16</sub>	<b>GS2SBD6H30D18L-</b> <input type="checkbox"/>	4,147	5,659	6,225	6,791
	30	18	81 <sup>15</sup> / <sub>16</sub>	<b>GS2SBD6H30D18R-</b> <input type="checkbox"/>	4,147	5,659	6,225	6,791

**PRODUCT INFO**

If integral pull is chosen for wood, doors will be touch latch.

5H units include (2) adjustable shelves behind doors.

6H units include (3) adjustable shelves behind doors.

All units have a finished back.

30D Laminate units have fasteners on backside with cam covers.

**TO ORDER PLEASE SPECIFY THE FOLLOWING:**

WOOD CHASSIS

1. **MODEL NUMBER + WW**
2. **FSC**
3. **CHASSIS WOOD FINISH**
4. **PULL**
5. **DRAWERS**
6. **KEYING**

LAM CHASSIS

1. **MODEL NUMBER + LL**
2. **FSC**
3. **CHASSIS LAM**
4. **FRONT LAM**
5. **PULL**
6. **DRAWERS**
7. **KEYING**

# STORAGE BOX 30D

5 high – 6 high | 18"W | File / File

Silea

02/24

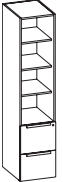
	D	W	H	model number + type	laminate	veneer 1	veneer 2	veneer 3
<b>18" WIDTH</b>  68 High	30	18	68 <sup>9</sup> / <sub>16</sub>	<b>GS2SBD5H30D18-</b> [ ]	3,489	4,757	5,233	5,709
 82 High	30	18	81 <sup>15</sup> / <sub>16</sub>	<b>GS2SBD6H30D18-</b> [ ]	3,838	5,232	5,756	6,279

## PRODUCT INFO

5H units include (2) adjustable shelves behind doors.

6H units include (3) adjustable shelves behind doors.

All units have a finished back.  
30D Laminate units have fasteners on backside with cam covers.

## TO ORDER PLEASE SPECIFY THE FOLLOWING:



### WOOD CHASSIS

1. **MODEL NUMBER + WN**
2. **FSC**
3. **CHASSIS WOOD FINISH**
4. **PULL**
5. **DRAWERS**
6. **KEYING**

### LAM CHASSIS

1. **MODEL NUMBER + LN**
2. **FSC**
3. **CHASSIS LAM**
4. **FRONT LAM**
5. **PULL**
6. **DRAWERS**
7. **KEYING**



	D	W	H	model number + type	laminate	veneer 1	veneer 2	veneer 3
<b>18" WIDTH</b>	30	18	68 <sup>9</sup> / <sub>16</sub>	<b>GS2SBD5H30D18L-3</b> [ ]	3,961	5,401	5,942	6,482
 Box/Box/File Left 68 High	30	18	68 <sup>9</sup> / <sub>16</sub>	<b>GS2SBD5H30D18R-3</b> [ ]	3,961	5,401	5,942	6,482
 Box/Box/File Left 82 High	30	18	81 <sup>15</sup> / <sub>16</sub>	<b>GS2SBD6H30D18L-3</b> [ ]	4,355	5,940	6,534	7,128
	30	18	81 <sup>15</sup> / <sub>16</sub>	<b>GS2SBD6H30D18R-3</b> [ ]	4,355	5,940	6,534	7,128

**PRODUCT INFO**

If integral pull is chosen for wood, doors will be touch latch.  
 5H units include (2) adjustable shelves behind doors.  
 6H units include (3) adjustable shelves behind doors.  
 All units have a finished back.  
 30D Laminate units have fasteners on backside with cam covers.

**TO ORDER PLEASE SPECIFY THE FOLLOWING:**

WOOD CHASSIS

1. **MODEL NUMBER + WW**
2. **FSC**
3. **CHASSIS WOOD FINISH**
4. **PULL**
5. **DRAWERS**
6. **KEYING**

LAM CHASSIS

1. **MODEL NUMBER + LL**
2. **FSC**
3. **CHASSIS LAM**
4. **FRONT LAM**
5. **PULL**
6. **DRAWERS**
7. **KEYING**

# STORAGE BOX 30D

5 high – 6 high | 18"W | Box / Box / File

Silea

02/24

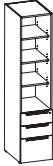
	D	W	H	model number + type	laminate	veneer 1	veneer 2	veneer 3
<b>18" WIDTH</b>	30	18	68 <sup>9</sup> / <sub>16</sub>	<b>GS2SBD5H30D18-3</b> [ ]	3,663	4,995	5,495	5,994
 Box/Box/File 68 High								
 Box/Box/File 82 High	30	18	81 <sup>15</sup> / <sub>16</sub>	<b>GS2SBD6H30D18-3</b> [ ]	4,030	5,494	6,044	6,593

## PRODUCT INFO

5H units include (2) adjustable shelves behind doors.

6H units include (3) adjustable shelves behind doors.

All units have a finished back.  
30D Laminate units have fasteners on backside with cam covers.



## TO ORDER PLEASE SPECIFY THE FOLLOWING:

### WOOD CHASSIS

1. **MODEL NUMBER + WN**
2. **FSC**
3. **CHASSIS WOOD FINISH**
4. **PULL**
5. **DRAWERS**
6. **KEYING**

### LAM CHASSIS

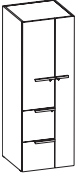
1. **MODEL NUMBER + LN**
2. **FSC**
3. **CHASSIS LAM**
4. **FRONT LAM**
5. **PULL**
6. **DRAWERS**
7. **KEYING**

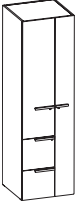
	D	W	H	model number + type	laminate	veneer 1	veneer 2	veneer 3
<b>68 HIGH</b>	24	24	68 <sup>9</sup> / <sub>16</sub>	<b>GS2UTC5H24L-</b> <input type="checkbox"/>	5,840	7,955	8,751	9,546
 Left hand								
	24	24	68 <sup>9</sup> / <sub>16</sub>	<b>GS2UTC5H24R-</b> <input type="checkbox"/>	5,840	7,955	8,751	9,546
 Right hand								
<b>82 HIGH</b>	24	24	81 <sup>15</sup> / <sub>16</sub>	<b>GS2UTC6H24L-</b> <input type="checkbox"/>	6,692	9,119	10,031	10,943
 Left hand								
	24	24	81 <sup>15</sup> / <sub>16</sub>	<b>GS2UTC6H24R-</b> <input type="checkbox"/>	6,692	9,119	10,031	10,943
 Right hand								

**PRODUCT INFO**

All units have a finished back.  
 If integral pull is chosen for wood, door will be touch latch.  
 Units include (1) closet rod behind full length door.  
 5H units include (2) adjustable shelves behind door above file drawers.  
 6H units include (4) adjustable shelves behind door above file drawers.

**TO ORDER PLEASE SPECIFY THE FOLLOWING:**

WOOD CHASSIS

1. **MODEL NUMBER + WW**
2. **FSC**
3. **CHASSIS WOOD FINISH**
4. **PULL**
5. **DRAWERS**
6. **KEYING**

LAM CHASSIS

1. **MODEL NUMBER + LL**
2. **FSC**
3. **CHASSIS LAM**
4. **FRONT LAM**
5. **PULL**
6. **DRAWERS**
7. **KEYING**

# UTILITY CABINET 24D

5 high – 6 high | 24"W | Box / Box / File

Silea  
02/24

	D	W	H	model number + type	laminate	veneer 1	veneer 2	veneer 3
<b>68" HIGH</b>	24	24	68 <sup>9</sup> / <sub>16</sub>	<b>GS2UTC5H24L-3</b> [ ]	6,131	8,352	9,188	10,023



Left hand

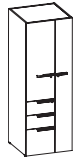

Right hand

	24	24	68 <sup>9</sup> / <sub>16</sub>	<b>GS2UTC5H24R-3</b> [ ]	6,131	8,352	9,188	10,023
--	----	----	---------------------------------	--------------------------	-------	-------	-------	--------

## 82" HIGH

	24	24	81 <sup>15</sup> / <sub>16</sub>	<b>GS2UTC6H24L-3</b> [ ]	7,027	9,576	10,534	11,492
--	----	----	----------------------------------	--------------------------	-------	-------	--------	--------

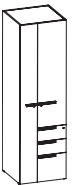

Left hand

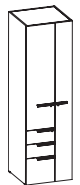

Right hand

	24	24	81 <sup>15</sup> / <sub>16</sub>	<b>GS2UTC6H24R-3</b> [ ]	7,027	9,576	10,534	11,492
--	----	----	----------------------------------	--------------------------	-------	-------	--------	--------

### PRODUCT INFO

All units have a finished back.  
If integral pull is chosen for wood, door will be touch latch.  
Units include (1) closet rod behind full length door.  
5H units include (2) adjustable shelves behind door above drawers.  
6H units include (4) adjustable shelves behind door above drawers.



### TO ORDER PLEASE SPECIFY THE FOLLOWING:

#### WOOD CHASSIS

1. **MODEL NUMBER + WW**
2. **FSC**
3. **CHASSIS WOOD FINISH**
4. **PULL**
5. **DRAWERS**
6. **KEYING**

#### LAM CHASSIS

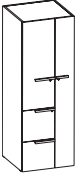
1. **MODEL NUMBER + LL**
2. **FSC**
3. **CHASSIS LAM**
4. **FRONT LAM**
5. **PULL**
6. **DRAWERS**
7. **KEYING**

	D	W	H	model number + type	laminate	veneer 1	veneer 2	veneer 3
<b>68 HIGH</b>	24	30	68 <sup>9</sup> / <sub>16</sub>	<b>GS2UTC5H30L-</b> <input type="checkbox"/>	6,424	8,750	9,625	10,500
 Left hand								
	24	30	68 <sup>9</sup> / <sub>16</sub>	<b>GS2UTC5H30R-</b> <input type="checkbox"/>	6,424	8,750	9,625	10,500
 Right hand								
<b>82 HIGH</b>	24	30	81 <sup>15</sup> / <sub>16</sub>	<b>GS2UTC6H30L-</b> <input type="checkbox"/>	7,363	10,032	11,036	12,039
 Left hand								
	24	30	81 <sup>15</sup> / <sub>16</sub>	<b>GS2UTC6H30R-</b> <input type="checkbox"/>	7,363	10,032	11,036	12,039
 Right hand								

**PRODUCT INFO**

All units have a finished back.  
 If integral pull is chosen for wood, door will be touch latch.  
 Units include (1) closet rod behind full length door.  
 5H units include (2) adjustable shelves behind door above drawers.  
 6H units include (4) adjustable shelves behind door above drawers.

**TO ORDER PLEASE SPECIFY THE FOLLOWING:**

WOOD CHASSIS

1. **MODEL NUMBER + WW**
2. **FSC**
3. **CHASSIS WOOD FINISH**
4. **PULL**
5. **DRAWERS**
6. **KEYING**

LAM CHASSIS

1. **MODEL NUMBER + LL**
2. **FSC**
3. **CHASSIS LAM**
4. **FRONT LAM**
5. **PULL**
6. **DRAWERS**
7. **KEYING**

# UTILITY CABINET 24D

5 high – 6 high | 30"W | Box / Box / File

Silea  
02/24

	D	W	H	model number + type	laminate	veneer 1	veneer 2	veneer 3
<b>68" HIGH</b>	24	30	68 <sup>9/16</sup>	<b>GS2UTC5H30L-3</b> [ ]	6,744	9,189	10,108	11,027



Left hand

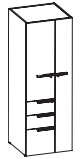

Right hand

	24	30	68 <sup>9/16</sup>	<b>GS2UTC5H30R-3</b> [ ]	6,744	9,189	10,108	11,027
--	----	----	--------------------	--------------------------	-------	-------	--------	--------

## 82" HIGH

	24	30	81 <sup>15/16</sup>	<b>GS2UTC6H30L-3</b> [ ]	7,730	10,535	11,589	12,642
--	----	----	---------------------	--------------------------	-------	--------	--------	--------

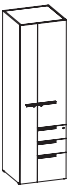

Left hand

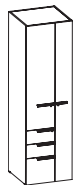

Right hand

	24	30	81 <sup>15/16</sup>	<b>GS2UTC6H30R-3</b> [ ]	7,730	10,535	11,589	12,642
--	----	----	---------------------	--------------------------	-------	--------	--------	--------

### PRODUCT INFO

All units have a finished back.  
If integral pull is chosen for wood, door will be touch latch.  
Units include (1) closet rod behind full length door.  
5H units include (2) adjustable shelves behind door above drawers.  
6H units include (4) adjustable shelves behind door above drawers.

### TO ORDER PLEASE SPECIFY THE FOLLOWING:

#### WOOD CHASSIS

1. **MODEL NUMBER + WW**
2. **FSC**
3. **CHASSIS WOOD FINISH**
4. **PULL**
5. **DRAWERS**
6. **KEYING**

#### LAM CHASSIS

1. **MODEL NUMBER + LL**
2. **FSC**
3. **CHASSIS LAM**
4. **FRONT LAM**
5. **PULL**
6. **DRAWERS**
7. **KEYING**



D	W	H	model number + type	laminata	veneer 1	veneer 2	veneer 3
24	30	29 1/2	<b>GS2SCF2H30-5</b> [ ]	2,138	2,914	3,206	3,497
24	36	29 1/2	<b>GS2SCF2H36-5</b> [ ]	2,378	3,237	3,561	3,885

**PRODUCT INFO**

Top included.  
All units have a finished back.  
If integral pull is chosen for wood, door will be touch latch.  
(1) adjustable shelf behind doors.

**TO ORDER PLEASE SPECIFY THE FOLLOWING:**



- |   |  |
|---|--|
| <p>WOOD TOP, WOOD CHASSIS</p> <ol style="list-style-type: none"> <li>1. <b>MODEL NUMBER + WW</b></li> <li>2. <b>FSC</b></li> <li>3. <b>TOP WOOD FINISH + EDGE</b></li> <li>4. <b>CHASSIS WOOD FINISH</b></li> <li>5. <b>TOP FINISH</b></li> <li>6. <b>PULL</b></li> <li>7. <b>KEYING</b></li> </ol> | <p>LAM TOP, LAM CHASSIS</p> <ol style="list-style-type: none"> <li>1. <b>MODEL NUMBER + LL</b></li> <li>2. <b>FSC</b></li> <li>3. <b>TOP LAM</b></li> <li>4. <b>CHASSIS LAM</b></li> <li>5. <b>FRONT LAM</b></li> <li>6. <b>TOP FINISH</b></li> <li>7. <b>EDGE DETAIL</b></li> <li>8. <b>PULL</b></li> <li>9. <b>KEYING</b></li> </ol> |
|---|--|

# SIDE ACCESS STORAGE LOCKER 24D

5 high – 6 high

Silea

02/24

	D	W	H	model number + type	laminate	veneer 1	veneer 2	veneer 3
<b>24" WIDTH</b>  Left hand unit 68 High	24	24	68 <sup>9</sup> / <sub>16</sub>	<b>GS2LKR5H24L-</b> [ ]	3,890	5,076	5,584	6,092
	24	24	68 <sup>9</sup> / <sub>16</sub>	<b>GS2LKR5H24R-</b> [ ]	3,890	5,076	5,584	6,092
 Right hand unit 82 High	24	24	81 <sup>15</sup> / <sub>16</sub>	<b>GS2LKR6H24L-</b> [ ]	4,799	6,259	6,885	7,511
	24	24	81 <sup>15</sup> / <sub>16</sub>	<b>GS2LKR6H24R-</b> [ ]	4,799	6,259	6,885	7,511

• Note: door overhangs chassis by 6"

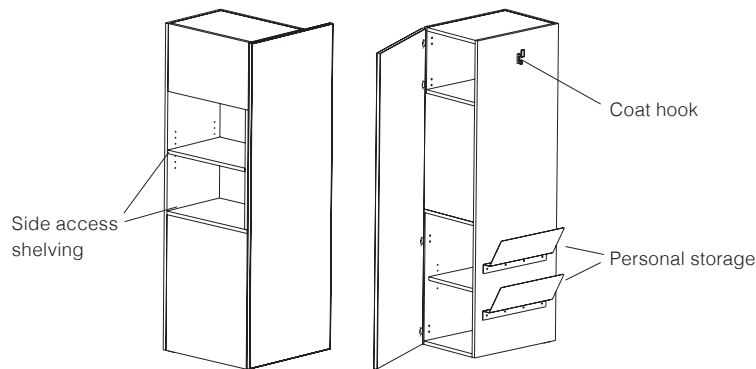

## PRODUCT INFO

All units have a finished back.

Unit does not lock.

 Laminate units shipped as separate packages and require field assembly.

Coat hook and metal personal storage shelves are black.

## TO ORDER PLEASE SPECIFY THE FOLLOWING:

### WOOD CHASSIS

1. **MODEL NUMBER + WW**
2. **FSC**
3. **CHASSIS WOOD FINISH**



### LAM CHASSIS

1. **MODEL NUMBER + LL**
2. **FSC**
3. **CHASSIS LAM**
4. **FRONT LAM**



# SIDE ACCESS STORAGE LOCKER 24D

Glass Door | 5 high – 6 high

	D	W	H	model number + type	laminate	veneer 1	veneer 2	veneer 3
<b>24" WIDTH</b>  Left hand unit 68 High	24	24	68 <sup>9/16</sup>	<b>GS2LKR5H24L-</b> [ ]	4,861	6,345	6,980	7,614
	24	24	68 <sup>9/16</sup>	<b>GS2LKR5H24R-</b> [ ]	4,861	6,345	6,980	7,614
 Right hand unit 82 High	24	24	81 <sup>15/16</sup>	<b>GS2LKR6H24L-</b> [ ]	5,996	7,824	8,607	9,389
	24	24	81 <sup>15/16</sup>	<b>GS2LKR6H24R-</b> [ ]	5,996	7,824	8,607	9,389

• Note: door overhangs chassis by 6"

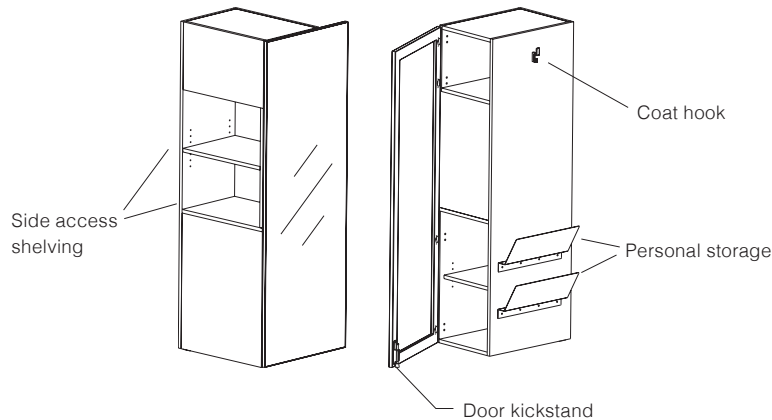

## PRODUCT INFO

All units have a finished back.  
 Door does not lock.  
 Laminate units shipped as separate packages and require field assembly.  
 Coat hook and metal personal storage shelves are black.

## TO ORDER PLEASE SPECIFY THE FOLLOWING:

WOOD CHASSIS, GLASS DOOR

1. **MODEL NUMBER + WG**
2. **FSC**
3. **CHASSIS WOOD FINISH**
4. **GLASS**

LAM CHASSIS, GLASS DOOR



1. **MODEL NUMBER + LG**
2. **FSC**
3. **CHASSIS LAM**
4. **GLASS**

# SIDE ACCESS STORAGE LOCKER LAYERS HEIGHT 24D

Silea

02/24

5 high – 6 high

	D	W	H	model number + type	laminate	veneer 1	veneer 2	veneer 3
<b>24" WIDTH</b>  Left hand unit 68 High	24	24	68 <sup>9/16</sup>	<b>GS2LLKR5H24L-</b> [ ]	3,890	5,076	5,584	6,092
	24	24	68 <sup>9/16</sup>	<b>GS2LLKR5H24R-</b> [ ]	3,890	5,076	5,584	6,092
 Right hand unit 82 High	24	24	81 <sup>15/16</sup>	<b>GS2LLKR6H24L-</b> [ ]	4,799	6,259	6,885	7,511
	24	24	81 <sup>15/16</sup>	<b>GS2LLKR6H24R-</b> [ ]	4,799	6,259	6,885	7,511

• Note: door overhangs chassis by 6"

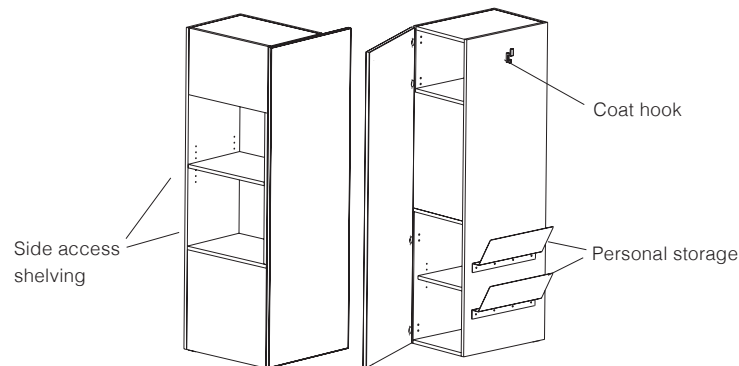

## PRODUCT INFO

All units have a finished back.

Doors do not lock.

 Laminate units shipped as separate packages and require field assembly.

Coat hook and metal personal storage shelves are black.

## TO ORDER PLEASE SPECIFY THE FOLLOWING:

### WOOD CHASSIS

1. **MODEL NUMBER + WW**
2. **FSC**
3. **CHASSIS WOOD FINISH**

### LAM CHASSIS

1. **MODEL NUMBER + LL**
2. **FSC**
3. **CHASSIS LAM**
4. **FRONT LAM**

# SIDE ACCESS STORAGE LOCKER LAYERS HEIGHT 24D

Glass Door | 5 high – 6 high

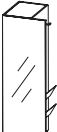
	D	W	H	model number + type	laminate	veneer 1	veneer 2	veneer 3
<b>24" WIDTH</b> 	24	24	68 <sup>9/16</sup>	<b>GS2LLKR5H24L-</b> [ ]	4,861	6,345	6,980	7,614
	24	24	68 <sup>9/16</sup>	<b>GS2LLKR5H24R-</b> [ ]	4,861	6,345	6,980	7,614
	24	24	81 <sup>15/16</sup>	<b>GS2LLKR6H24L-</b> [ ]	5,996	7,824	8,607	9,389
	24	24	81 <sup>15/16</sup>	<b>GS2LLKR6H24R-</b> [ ]	5,996	7,824	8,607	9,389

• Note: door overhangs chassis by 6"

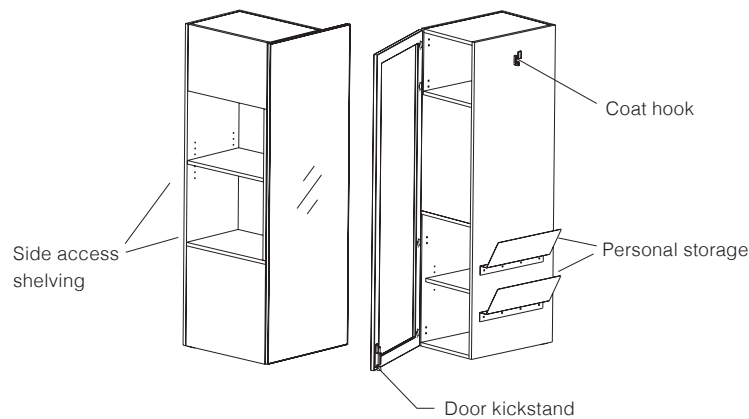

## PRODUCT INFO

All units have a finished back.  
Doors do not lock.  
 Laminate units shipped as separate packages and require field assembly.  
Coat hook and metal personal storage shelves are black.

## TO ORDER PLEASE SPECIFY THE FOLLOWING:

WOOD CHASSIS, GLASS DOOR



- MODEL NUMBER + WG**
- FSC**
- CHASSIS WOOD FINISH**
- GLASS**

LAM CHASSIS, GLASS DOOR

- MODEL NUMBER + LG**
- FSC**
- CHASSIS LAM**
- GLASS**

# MOBILE PEDESTAL

Silea  
02/24

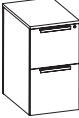
	D	W	H	model number + type	laminata	veneer 1	veneer 2	veneer 3
 Box/File	21 <sup>15</sup> / <sub>16</sub>	15 <sup>3</sup> / <sub>16</sub>	21 <sup>1</sup> / <sub>2</sub>	<b>GS2MPD-6</b> [ ]	1,904	2,597	2,857	3,117
 Box/Box/File	23 <sup>15</sup> / <sub>16</sub>	15 <sup>3</sup> / <sub>16</sub>	27 <sup>5</sup> / <sub>8</sub>	<b>GS2MPD-3</b> [ ]	2,096	2,857	3,143	3,429
 File/File	23 <sup>15</sup> / <sub>16</sub>	15 <sup>3</sup> / <sub>16</sub>	27 <sup>5</sup> / <sub>8</sub>	<b>GS2MPD-2</b> [ ]	2,096	2,857	3,143	3,429

• Taller Box/Box/File and File/File mobile pedestals with a cushion will NOT fit under a standard height desk. These taller mobile pedestals are not recommended for use with a cushion due to height.

## PRODUCT INFO

Top included.  
Pedestal on casters.

## TO ORDER PLEASE SPECIFY THE FOLLOWING:

WOOD TOP, WOOD CHASSIS

1. **MODEL NUMBER + WW**
2. **FSC**
3. **CHASSIS WOOD FINISH**
4. **PULL**
5. **DRAWERS**
6. **KEYING**

LAM TOP, LAM CHASSIS

1. **MODEL NUMBER + LL**
2. **FSC**
3. **TOP LAM**
4. **CHASSIS LAM**
5. **FRONT LAM**
6. **PULL**
7. **DRAWERS**
8. **KEYING**

	D	W	H	model number	fabric grades			COM/4
					1	2	3	
	21 11/16	14 7/8	1	<b>GS2MPD-CUSH2215</b>	528	546	566	584

**PRODUCT INFO**

For use with mobile pedestals.

**COM Fabric 1.25 yds**

**TO ORDER PLEASE SPECIFY THE FOLLOWING:**

LIST

1. **MODEL NUMBER**
2. **FABRIC**
3. **FLAMMABILITY**

**Flammability Option Codes:**

**U** = CT B117  
For standard flammability rating,  
please specify CTB 117.

# STORAGE EXTERNAL TOPS

For Units with Doors

Silea  
02/24

	D	W	H	model number + type	laminata	veneer 1	veneer 2	veneer 3
	30	18	1 3/16	<b>GS2SGTOPD3018-</b> <input type="checkbox"/>	572	779	857	935



## PRODUCT INFO

### TO ORDER PLEASE SPECIFY THE FOLLOWING:

WOOD TOP

LAM TOP

- |                                  |                            |
|----------------------------------|----------------------------|
| 1. <b>MODEL NUMBER + W</b>       | 1. <b>MODEL NUMBER + L</b> |
| 2. <b>FSC</b>                    | 2. <b>FSC</b>              |
| 3. <b>TOP WOOD FINISH + EDGE</b> | 3. <b>TOP LAM</b>          |
| 4. <b>TOP FINISH</b>             |                            |

**Top Finish Option:**

Non-UV Open Pore Finish  
Full Fill Top Finish

**NR**  
**FF (+\$282)**

# STORAGE EXTERNAL TOPS

For units without doors

D	W	H	model number + type	laminata	vener 1	vener 2	vener 2
29 1/8	18	1 3/16	<b>GS2SGTOPN3018-</b> [ ]	572	779	857	935
• For use w/ 24D and 30D storage							
14 7/8	30	1 3/16	<b>GS2SMTOPN30-</b> [ ]	414	954	1,050	1,145
14 7/8	36	1 3/16	<b>GS2SMTOPN36-</b> [ ]	469	639	703	767
14 7/8	60	1 3/16	<b>GS2SMTOPN60-</b> [ ]	705	963	1,060	1,156
14 7/8	72	1 3/16	<b>GS2SMTOPN72-</b> [ ]	810	1,106	1,217	1,328
14 7/8	90	1 3/16	<b>GS2SMTOPN90-</b> [ ]	972	1,325	1,458	1,590
14 7/8	114	1 3/16	<b>GS2SMTOPN108-</b> [ ]	1,131	1,543	1,698	1,852

• For use w/ bookcases

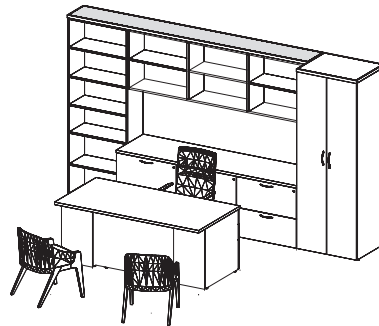

## PRODUCT INFO

### TO ORDER PLEASE SPECIFY THE FOLLOWING:

#### WOOD TOP

1. **MODEL NUMBER + W**
2. **FSC**
3. **TOP WOOD FINISH + EDGE**
4. **TOP FINISH**

#### Top Finish Option:

Non-UV Open Pore Finish  
Full Fill Top Finish

#### LAM TOP

1. **MODEL NUMBER + L**
2. **FSC**
3. **TOP LAM**

**NR**  
**FF (+\$282)**





Wall Mount . . . . .	267-302
Cabinets . . . . .	268-277
Wall Mount Wall Overhead . . . . .	278-279
Tackboard in Tackzone . . . . .	280-283
Tackboard to Top of Overhead . . . . .	284-289
Glass Whiteboard from Floor . . . . .	290
Wall Mount Wall in Tackzone . . . . .	291-294
Magnetic Wood to Top of Overhead . . . . .	295-299
Shelving for Wall Mount Wall . . . . .	300-301
Floating Shelves . . . . .	302

# WALL MOUNT CABINETS

w/ Hinged Doors | 1H

Silea

02/24

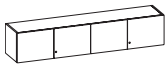
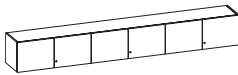
	D	W	H	model number + type	laminate	veneer 1	veneer 2	veneer 3
	16 1/4	30	14 1/8	<b>GS2WMC1H30-</b> [ ]	2,049	2,795	3,075	3,354
	16 1/4	36	14 1/8	<b>GS2WMC1H36-</b> [ ]	2,223	3,023	3,326	3,628
	16 1/4	42	14 1/8	<b>GS2WMC1H42-</b> [ ]	2,788	3,804	4,185	4,565
	16 1/4	48	14 1/8	<b>GS2WMC1H48-</b> [ ]	2,939	4,010	4,411	4,812
	16 1/4	54	14 1/8	<b>GS2WMC1H54-</b> [ ]	3,094	4,219	4,641	5,063
	16 1/4	60	14 1/8	<b>GS2WMC1H60-</b> [ ]	3,215	4,379	4,817	5,255
	16 1/4	66	14 1/8	<b>GS2WMC1H66-</b> [ ]	3,433	4,677	5,145	5,613
	16 1/4	72	14 1/8	<b>GS2WMC1H72-</b> [ ]	3,631	4,949	5,444	5,939
	16 1/4	78	14 1/8	<b>GS2WMC1H78-</b> [ ]	3,856	5,254	5,780	6,305
	16 1/4	84	14 1/8	<b>GS2WMC1H84-</b> [ ]	4,128	5,628	6,191	6,754
	16 1/4	90	14 1/8	<b>GS2WMC1H90-</b> [ ]	4,374	5,959	6,555	7,151
	16 1/4	96	14 1/8	<b>GS2WMC1H96-</b> [ ]	4,527	6,170	6,787	7,404
	16 1/4	102	14 1/8	<b>GS2WMC1H102-</b> [ ]	N/A	6,381	7,020	7,658
	16 1/4	108	14 1/8	<b>GS2WMC1H108-</b> [ ]	N/A	6,599	7,259	7,919

## PRODUCT INFO

# of doors:  
 30" and 36" = 2 doors  
 42" through 78" = 4 doors  
 84" through 108" = 6 doors

## TO ORDER PLEASE SPECIFY THE FOLLOWING:

WOOD CHASSIS, WOOD DOOR

1. **MODEL NUMBER + WW**
2. **FSC**
3. **CHASSIS WOOD FINISH**
4. **LOCKS**
5. **KEYING**

LAM CHASSIS, LAM DOOR

1. **MODEL NUMBER + LL**
2. **FSC**
3. **CHASSIS LAM**
4. **FRONT LAM**
5. **LOCKS**
6. **KEYING**

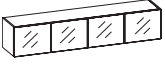
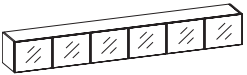
	D	W	H	model number + type	veneer 1	veneer 2	veneer 3
	16 1/4	30	14 1/8	<b>GS2WMC1H30-</b> [ ]	3,293	3,623	3,952
	16 1/4	36	14 1/8	<b>GS2WMC1H36-</b> [ ]	3,562	3,919	4,275
	16 1/4	60	14 1/8	<b>GS2WMC1H60-</b> [ ]	5,254	5,780	6,305
	16 1/4	72	14 1/8	<b>GS2WMC1H72-</b> [ ]	5,937	6,531	7,125
	16 1/4	90	14 1/8	<b>GS2WMC1H90-</b> [ ]	7,357	8,093	8,829
	16 1/4	108	14 1/8	<b>GS2WMC1H108-</b> [ ]	8,146	8,961	9,776

**PRODUCT INFO**

Type must be specified as part # of doors:  
 30" and 36" = 2 doors  
 60" through 72" = 4 doors  
 90" through 108" = 6 doors  
 Glass doors do not lock.

**TO ORDER PLEASE SPECIFY THE FOLLOWING:**

WOOD CHASSIS, GLASS DOOR

1. **MODEL NUMBER + WG**
2. **FSC**
3. **CHASSIS WOOD FINISH**
4. **GLASS**

# WALL MOUNT CABINETS

No Doors | 1H

Silea

02/24

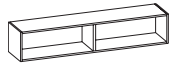

D	W	H	model number + type	laminate	veneer 1	veneer 2	veneer 3
15 3/8	30	14 1/8	<b>GS2WMC1H30-</b> [ ]	1,745	2,378	2,616	2,854
15 3/8	36	14 1/8	<b>GS2WMC1H36-</b> [ ]	1,888	2,574	2,832	3,089
15 3/8	42	14 1/8	<b>GS2WMC1H42-</b> [ ]	2,369	3,232	3,556	3,879
15 3/8	48	14 1/8	<b>GS2WMC1H48-</b> [ ]	2,497	3,410	3,751	4,092
15 3/8	54	14 1/8	<b>GS2WMC1H54-</b> [ ]	2,629	3,585	3,944	4,302
15 3/8	60	14 1/8	<b>GS2WMC1H60-</b> [ ]	2,734	3,726	4,099	4,472
15 3/8	66	14 1/8	<b>GS2WMC1H66-</b> [ ]	2,920	3,979	4,377	4,775
15 3/8	72	14 1/8	<b>GS2WMC1H72-</b> [ ]	3,087	4,211	4,633	5,054
15 3/8	78	14 1/8	<b>GS2WMC1H78-</b> [ ]	3,276	4,467	4,914	5,361
15 3/8	84	14 1/8	<b>GS2WMC1H84-</b> [ ]	3,509	4,787	5,266	5,745
15 3/8	90	14 1/8	<b>GS2WMC1H90-</b> [ ]	3,716	5,068	5,575	6,082
15 3/8	96	14 1/8	<b>GS2WMC1H96-</b> [ ]	3,848	5,246	5,771	6,296
15 3/8	102	14 1/8	<b>GS2WMC1H102-</b> [ ]	N/A	5,427	5,970	6,513
15 3/8	108	14 1/8	<b>GS2WMC1H108-</b> [ ]	N/A	5,612	6,174	6,735

## PRODUCT INFO

### TO ORDER PLEASE SPECIFY THE FOLLOWING:

#### WOOD

1. **MODEL NUMBER + WN**
2. **FSC**
3. **CHASSIS WOOD FINISH**

#### LAM

1. **MODEL NUMBER + LN**
2. **FSC**
3. **CHASSIS LAM**

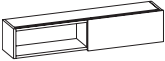
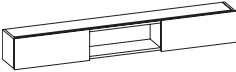
	D	W	H	model number + type	laminata	veneer 1	veneer 2	veneer 3
	16 1/4	60	14 1/8	<b>GS2WMC1H60-</b> [ ]	3,216	4,383	4,822	5,260
	16 1/4	66	14 1/8	<b>GS2WMC1H66-</b> [ ]	3,425	4,669	5,136	5,603
	16 1/4	72	14 1/8	<b>GS2WMC1H72-</b> [ ]	3,631	4,954	5,450	5,945
	16 1/4	78	14 1/8	<b>GS2WMC1H78-</b> [ ]	3,923	5,348	5,883	6,418
	16 1/4	84	14 1/8	<b>GS2WMC1H84-</b> [ ]	4,212	5,743	6,318	6,892
	16 1/4	90	14 1/8	<b>GS2WMC1H90-</b> [ ]	4,502	6,139	6,753	7,367
	16 1/4	96	14 1/8	<b>GS2WMC1H96-</b> [ ]	4,777	6,381	7,020	7,658
	16 1/4	102	14 1/8	<b>GS2WMC1H102-</b> [ ]	N/A	6,622	7,285	7,947
	16 1/4	108	14 1/8	<b>GS2WMC1H108-</b> [ ]	N/A	6,796	7,476	8,156

**PRODUCT INFO**

# of doors:  
60" - 78" = 1 door  
84" - 108" = 2 doors  
Doors do not lock.

**TO ORDER PLEASE SPECIFY THE FOLLOWING:**

WOOD CHASSIS, WOOD DOOR

1. **MODEL NUMBER + WSW**
2. **FSC**
3. **CHASSIS WOOD FINISH**

LAM CHASSIS, LAM DOOR

1. **MODEL NUMBER + LSL**
2. **FSC**
3. **CHASSIS LAM**
4. **FRONT LAM**

# WALL MOUNT CABINETS

w/ Sliding Glass Doors | 1H

Silea

02/24

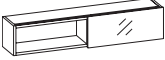
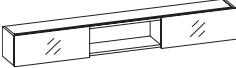
	D	W	H	model number + type	veneer 1	veneer 2	veneer 3
	16 1/4	60	14 1/8	<b>GS2WMC1H60-</b> [ ]	5,517	6,069	6,621
	16 1/4	72	14 1/8	<b>GS2WMC1H72-</b> [ ]	6,233	6,857	7,480
	16 1/4	90	14 1/8	<b>GS2WMC1H90-</b> [ ]	7,723	8,496	9,268
	16 1/4	108	14 1/8	<b>GS2WMC1H108-</b> [ ]	8,553	9,409	10,264

## PRODUCT INFO

# of doors:

60" and 72" = 1 door

90" and 108" = 2 doors

Glass doors do not lock.

## TO ORDER PLEASE SPECIFY THE FOLLOWING:

WOOD CHASSIS, GLASS DOOR

1. **MODEL NUMBER + WSG**
2. **FSC**
3. **CHASSIS WOOD FINISH**
4. **GLASS**

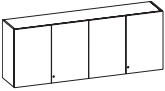
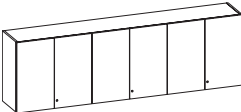
	D	W	H	model number + type	laminate	veneer 1	veneer 2	veneer 3
	16 1/4	30	27 1/2	<b>GS2WMC2H30-</b> [ ]	2,901	3,944	4,339	4,733
	16 1/4	36	27 1/2	<b>GS2WMC2H36-</b> [ ]	3,165	4,306	4,737	5,168
	16 1/4	42	27 1/2	<b>GS2WMC2H42-</b> [ ]	3,260	4,448	4,893	5,338
	16 1/4	48	27 1/2	<b>GS2WMC2H48-</b> [ ]	3,509	4,785	5,264	5,742
	16 1/4	54	27 1/2	<b>GS2WMC2H54-</b> [ ]	3,756	5,121	5,634	6,146
	16 1/4	60	27 1/2	<b>GS2WMC2H60-</b> [ ]	4,179	5,689	6,258	6,827
	16 1/4	66	27 1/2	<b>GS2WMC2H66-</b> [ ]	4,473	6,091	6,701	7,310
	16 1/4	72	27 1/2	<b>GS2WMC2H72-</b> [ ]	5,086	6,431	7,075	7,718
	16 1/4	78	27 1/2	<b>GS2WMC2H78-</b> [ ]	5,187	6,563	7,220	7,876
	16 1/4	84	27 1/2	<b>GS2WMC2H84-</b> [ ]	5,427	6,868	7,555	8,242
	16 1/4	90	27 1/2	<b>GS2WMC2H90-</b> [ ]	5,710	7,227	7,950	8,673

**PRODUCT INFO**

# of doors:  
30" and 36" = 2 doors  
60" through 78" = 4 doors  
84" and 90" = 6 doors

**TO ORDER PLEASE SPECIFY THE FOLLOWING:**

- |                               |                             |
|-------------------------------|-----------------------------|
| WOOD CHASSIS, WOOD DOOR       | LAM CHASSIS, LAM DOOR       |
| 1. <b>MODEL NUMBER + WW</b>   | 1. <b>MODEL NUMBER + LL</b> |
| 2. <b>FSC</b>                 | 2. <b>FSC</b>               |
| 3. <b>CHASSIS WOOD FINISH</b> | 3. <b>CHASSIS LAM</b>       |
| 4. <b>LOCKS</b>               | 4. <b>FRONT LAM</b>         |
| 5. <b>KEYING</b>              | 5. <b>LOCKS</b>             |
|                               | 6. <b>KEYING</b>            |

# WALL MOUNT CABINETS

w/ Hinged Glass Doors | 2H

Silea

02/24

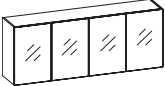
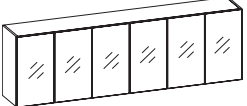
	D	W	H	model number + type	veneer 1	veneer 2	veneer 3
	16 1/4	30	27 1/2	<b>GS2WMC2H30-</b> [ ]	4,645	5,110	5,574
	16 1/4	36	27 1/2	<b>GS2WMC2H36-</b> [ ]	5,074	5,582	6,089
	16 1/4	60	27 1/2	<b>GS2WMC2H60-</b> [ ]	6,827	7,510	8,193
	16 1/4	72	27 1/2	<b>GS2WMC2H72-</b> [ ]	7,717	8,489	9,261
	16 1/4	90	27 1/2	<b>GS2WMC2H90-</b> [ ]	8,920	9,812	10,704

## PRODUCT INFO

# of doors:

30" and 36" = 2 doors

60" and 72" = 4 doors

90" = 6 doors

Glass doors do not lock.

## TO ORDER PLEASE SPECIFY THE FOLLOWING:

WOOD CHASSIS, GLASS DOOR

1. **MODEL NUMBER + WG**
2. **FSC**
3. **CHASSIS WOOD FINISH**
4. **GLASS**



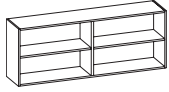

D	W	H	model number + type	laminate	veneer 1	veneer 2	veneer 3
16 1/4	30	27 1/2	<b>GS2WMC2H30-</b> [ ]	2,462	3,358	3,694	4,030
16 1/4	36	27 1/2	<b>GS2WMC2H36-</b> [ ]	2,689	3,667	4,034	4,401
16 1/4	42	27 1/2	<b>GS2WMC2H42-</b> [ ]	2,773	3,782	4,161	4,539
16 1/4	48	27 1/2	<b>GS2WMC2H48-</b> [ ]	2,982	4,067	4,474	4,881
16 1/4	54	27 1/2	<b>GS2WMC2H54-</b> [ ]	3,190	4,352	4,788	5,223
16 1/4	60	27 1/2	<b>GS2WMC2H60-</b> [ ]	3,551	4,842	5,327	5,811
16 1/4	66	27 1/2	<b>GS2WMC2H66-</b> [ ]	3,802	5,184	5,703	6,221
16 1/4	72	27 1/2	<b>GS2WMC2H72-</b> [ ]	4,321	5,472	6,020	6,567
16 1/4	78	27 1/2	<b>GS2WMC2H78-</b> [ ]	4,409	5,582	6,141	6,699
16 1/4	84	27 1/2	<b>GS2WMC2H84-</b> [ ]	4,613	5,842	6,427	7,011
16 1/4	90	27 1/2	<b>GS2WMC2H90-</b> [ ]	4,854	6,146	6,761	7,376

**PRODUCT INFO**

**TO ORDER PLEASE SPECIFY THE FOLLOWING:**

WOOD CHASSIS

1. **MODEL NUMBER + WN**
2. **FSC**
3. **CHASSIS WOOD FINISH**

LAM CHASSIS

1. **MODEL NUMBER + LN**
2. **FSC**
3. **CHASSIS LAM**

# WALL MOUNT CABINETS

w/ Sliding Doors | 2H

Silea

02/24

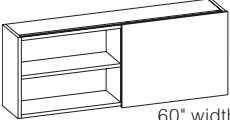
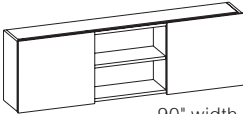
	D	W	H	model number + type	laminate	veneer 1	veneer 2	veneer 3
 <p>60" width</p>	16 1/4	60	27 1/2	<b>GS2WMC2H60-</b> [ ]	4,178	5,697	6,267	6,837
	16 1/4	66	27 1/2	<b>GS2WMC2H66-</b> [ ]	4,632	6,069	6,676	7,283
	16 1/4	72	27 1/2	<b>GS2WMC2H72-</b> [ ]	5,086	6,438	7,082	7,726
	16 1/4	78	27 1/2	<b>GS2WMC2H78-</b> [ ]	5,458	6,765	7,442	8,118
	16 1/4	84	27 1/2	<b>GS2WMC2H84-</b> [ ]	5,736	7,092	7,802	8,511
 <p>90" width</p>	16 1/4	90	27 1/2	<b>GS2WMC2H90-</b> [ ]	5,878	7,443	8,188	8,932

## PRODUCT INFO

# of doors:  
 60" - 78" = 1 door  
 84" - 90" = 2 doors  
 Doors do not lock.



## TO ORDER PLEASE SPECIFY THE FOLLOWING:

WOOD CHASSIS, WOOD DOOR

1. **MODEL NUMBER + WSW**
2. **FSC**
3. **CHASSIS WOOD FINISH**

LAM CHASSIS, LAM DOOR

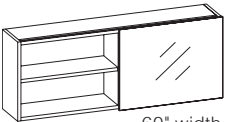
1. **MODEL NUMBER + LSL**
2. **FSC**
3. **CHASSIS LAM**
4. **FRONT LAM**

	D	W	H	model number + type	veneer 1	veneer 2	veneer 3
 60" width	16 1/4	60	27 1/2	<b>GS2WMC2H60-</b> [ ]	7,168	7,885	8,602
	16 1/4	72	27 1/2	<b>GS2WMC2H72-</b> [ ]	7,426	8,169	8,912
 90" width	16 1/4	90	27 1/2	<b>GS2WMC2H90-</b> [ ]	9,200	10,120	11,040

**PRODUCT INFO**

# of doors:  
60" and 72" = 1 door  
90" = 2 doors  
Glass doors do not lock.

**TO ORDER PLEASE SPECIFY THE FOLLOWING:**

WOOD CHASSIS, GLASS DOOR

1. **MODEL NUMBER + WSG**
2. **FSC**
3. **CHASSIS WOOD FINISH**
4. **GLASS**

# WALL MOUNT WALL OVERHEAD

Shelf Track Bottom | 1H

Silea

02/24

	D	W	H	model number + type	laminate	veneer 1	veneer 2	veneer 3
	3/4	30	14 1/8	GS2WMW1H30- [ ]	810	1,028	1,131	1,234
	3/4	36	14 1/8	GS2WMW1H36- [ ]	878	1,111	1,223	1,334
	3/4	42	14 1/8	GS2WMW1H42- [ ]	947	1,201	1,322	1,442
	3/4	48	14 1/8	GS2WMW1H48- [ ]	1,044	1,323	1,456	1,588
	3/4	54	14 1/8	GS2WMW1H54- [ ]	1,141	1,444	1,589	1,733
	3/4	60	14 1/8	GS2WMW1H60- [ ]	1,273	1,610	1,771	1,932
	3/4	66	14 1/8	GS2WMW1H66- [ ]	1,358	1,720	1,892	2,064
	3/4	72	14 1/8	GS2WMW1H72- [ ]	1,435	1,817	1,999	2,181
	3/4	78	14 1/8	GS2WMW1H78- [ ]	1,515	1,914	2,106	2,297
	3/4	84	14 1/8	GS2WMW1H84- [ ]	1,589	2,012	2,214	2,415
	3/4	90	14 1/8	GS2WMW1H90- [ ]	1,780	2,251	2,477	2,702
	3/4	96	14 1/8	GS2WMW1H96- [ ]	1,842	2,331	2,565	2,798
	3/4	102	14 1/8	GS2WMW1H102- [ ]	1,906	2,413	2,655	2,896
	3/4	108	14 1/8	GS2WMW1H108- [ ]	1,974	2,498	2,748	2,998

## PRODUCT INFO

Shelving can be mounted to bottom aluminum track.  
Shelving ordered separately.

## TO ORDER PLEASE SPECIFY THE FOLLOWING:

### WOOD

1. MODEL NUMBER + W
2. FSC
3. CHASSIS WOOD FINISH
4. EXTRUSION COLOR

### LAM

1. MODEL NUMBER + L
2. FSC
3. CHASSIS LAM
4. EXTRUSION COLOR

	D	W	H	model number + type	laminate	veneer 1	veneer 2	veneer 3
	3/4	30	27 1/2	<b>GS2WMW2H30-</b> <input type="checkbox"/>	964	1,220	1,342	1,464
	3/4	36	27 1/2	<b>GS2WMW2H36-</b> <input type="checkbox"/>	1,041	1,316	1,448	1,580
	3/4	42	27 1/2	<b>GS2WMW2H42-</b> <input type="checkbox"/>	1,114	1,412	1,554	1,695
	3/4	48	27 1/2	<b>GS2WMW2H48-</b> <input type="checkbox"/>	1,246	1,576	1,734	1,892
	3/4	54	27 1/2	<b>GS2WMW2H54-</b> <input type="checkbox"/>	1,375	1,742	1,917	2,091
	3/4	60	27 1/2	<b>GS2WMW2H60-</b> <input type="checkbox"/>	1,505	1,905	2,096	2,286
	3/4	66	27 1/2	<b>GS2WMW2H66-</b> <input type="checkbox"/>	1,612	2,039	2,243	2,447
	3/4	72	27 1/2	<b>GS2WMW2H72-</b> <input type="checkbox"/>	1,700	2,151	2,367	2,582
	3/4	78	27 1/2	<b>GS2WMW2H78-</b> <input type="checkbox"/>	1,789	2,267	2,494	2,721
	3/4	84	27 1/2	<b>GS2WMW2H84-</b> <input type="checkbox"/>	1,880	2,379	2,617	2,855
3/4	90	27 1/2	<b>GS2WMW2H90-</b> <input type="checkbox"/>	2,108	2,667	2,934	3,201	

**PRODUCT INFO**

Shelving can be mounted to bottom and center aluminum track.  
Shelving ordered separately.

**TO ORDER PLEASE SPECIFY THE FOLLOWING:**

WOOD

1. **MODEL NUMBER + W**
2. **FSC**
3. **CHASSIS WOOD FINISH**
4. **EXTRUSION COLOR**

LAM

1. **MODEL NUMBER + L**
2. **FSC**
3. **CHASSIS LAM**
4. **EXTRUSION COLOR**

# WALL MOUNT TACKBOARD IN TACKZONE

For Standard Height Credenzas

Silea

02/24

fabric grades

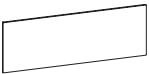
	D	W	H	yards	model number	1	2	3	COM/4
	7/8	24	24 13/16	1.00	<b>GS2TKW24</b>	777	798	822	847
	7/8	30	24 13/16	1.00	<b>GS2TKW30</b>	817	839	865	890
	7/8	36	24 13/16	1.25	<b>GS2TKW36</b>	856	885	916	949
	7/8	42	24 13/16	1.25	<b>GS2TKW42</b>	887	917	948	982
	7/8	48	24 13/16	1.25	<b>GS2TKW48</b>	918	949	982	1,015
	7/8	54	24 13/16	1.25	<b>GS2TKW54</b>	952	985	1,017	1,053
	7/8	60	24 13/16	2.00	<b>GS2TKW60</b>	997	1,044	1,093	1,143
	7/8	66	24 13/16	2.25	<b>GS2TKW66</b>	1,013	1,060	1,109	1,159
	7/8	72	24 13/16	2.25	<b>GS2TKW72</b>	1,054	1,107	1,163	1,219
	7/8	78	24 13/16	2.50	<b>GS2TKW78</b>	1,082	1,140	1,203	1,266
	7/8	84	24 13/16	2.75	<b>GS2TKW84</b>	1,113	1,171	1,234	1,297
	7/8	90	24 13/16	2.75	<b>GS2TKW90</b>	1,164	1,228	1,296	1,363
	7/8	96	24 13/16	3.00	<b>GS2TKW96</b>	1,212	1,283	1,357	1,432
	7/8	102	24 13/16	3.25	<b>GS2TKW102</b>	1,672	1,747	1,829	1,911
	7/8	108	24 13/16	3.50	<b>GS2TKW108</b>	1,733	1,815	1,902	1,990

Product Specifications:

### STANDARD

The fabric on all Gunlocke tackboards is applied in a railroad fashion.

- Tackboard widths less than or equal to 96" are one piece
- Tackboards greater than 96" are two piece and the fabric is pattern matched
- When ordering individual wall mount tackboards to be placed side by side, the fabric pattern will be random matched. If a fabric pattern match is required, contact Gunlocke Bid/Quote for a special quote.

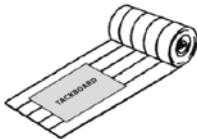

### SPECIAL

Fabric applied "up the roll" is a special application. Please see guidelines below and contact Gunlocke Bid/Quote for a special quote.

- Fabrics used on tackboard 48" and under in width can be applied "up the roll"
- Tackboards greater than 48" in width can only be applied railroaded, due to fabric height limitations

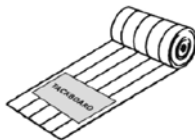

### PRODUCT INFO

102" and 108" wide tackboards are 2 piece.

See yards listed above for COM fabric requirements.

### TO ORDER PLEASE SPECIFY THE FOLLOWING:

LIST

1. **MODEL NUMBER**
2. **FABRIC**
3. **FSC TACKBOARDS**

#### FSC Tackboard Options

**FSC** = FSC Required (5% COM upcharge)

**NR** = FSC Not Required

# WALL MOUNT GLASS WHITEBOARD IN TACKZONE

For Standard Height Credenzas

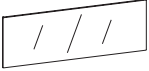
	D	W	H	model number	glass
	7/8	24	24 13/16	<b>GS2TGW24-GSA</b>	1,552
	7/8	30	24 13/16	<b>GS2TGW30-GSA</b>	1,633
	7/8	36	24 13/16	<b>GS2TGW36-GSA</b>	1,857
	7/8	42	24 13/16	<b>GS2TGW42-GSA</b>	2,147
	7/8	48	24 13/16	<b>GS2TGW48-GSA</b>	2,434
	7/8	54	24 13/16	<b>GS2TGW54-GSA</b>	2,724
	7/8	60	24 13/16	<b>GS2TGW60-GSA</b>	3,044
	7/8	66	24 13/16	<b>GS2TGW66-GSA</b>	3,485
	7/8	72	24 13/16	<b>GS2TGW72-GSA</b>	3,713
	7/8	78	24 13/16	<b>GS2TGW78-GSA</b>	4,116
	7/8	84	24 13/16	<b>GS2TGW84-GSA</b>	4,676
	7/8	90	24 13/16	<b>GS2TGW90-GSA</b>	4,891
	7/8	96	24 13/16	<b>GS2TGW96-GSA</b>	5,126
	7/8	102	24 13/16	<b>GS2TGW102-GSA</b>	5,344
7/8	108	24 13/16	<b>GS2TGW108-GSA</b>	5,571	

## PRODUCT INFO

96", 102" and 108" wide whiteboards are 2 piece.  
Whiteboard frames match glass color.  
Whiteboard is magnetic.

## TO ORDER PLEASE SPECIFY THE FOLLOWING:

GLASS

1. **MODEL NUMBER**
2. **GLASS**

# LAYERS WALL MOUNT TACKBOARD IN TACKZONE

For Layers Height Credenzas

Silea  
02/24

fabric grades

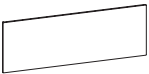
	D	W	H	yards	model number	1	2	3	COM/4
	7/8	24	31 15/16	1.00	<b>GS2TLKW24</b>	815	837	863	888
	7/8	30	31 15/16	1.00	<b>GS2TLKW30</b>	858	882	910	935
	7/8	36	31 15/16	1.25	<b>GS2TLKW36</b>	898	928	962	995
	7/8	42	31 15/16	1.25	<b>GS2TLKW42</b>	931	964	996	1,034
	7/8	48	31 15/16	1.25	<b>GS2TLKW48</b>	963	996	1,030	1,068
	7/8	54	31 15/16	1.25	<b>GS2TLKW54</b>	997	1,034	1,068	1,106
	7/8	60	31 15/16	2.00	<b>GS2TLKW60</b>	1,046	1,095	1,147	1,200
	7/8	66	31 15/16	2.25	<b>GS2TLKW66</b>	1,065	1,113	1,166	1,219
	7/8	72	31 15/16	2.25	<b>GS2TLKW72</b>	1,107	1,162	1,223	1,280
	7/8	78	31 15/16	2.50	<b>GS2TLKW78</b>	1,138	1,199	1,265	1,332
	7/8	84	31 15/16	2.75	<b>GS2TLKW84</b>	1,169	1,230	1,296	1,363
	7/8	90	31 15/16	2.75	<b>GS2TLKW90</b>	1,222	1,289	1,363	1,432
	7/8	96	31 15/16	3.00	<b>GS2TLKW96</b>	1,271	1,345	1,424	1,502
	7/8	102	31 15/16	3.25	<b>GS2TLKW102</b>	1,755	1,833	1,920	2,005
	7/8	108	31 15/16	3.50	<b>GS2TLKW108</b>	1,820	1,906	1,997	2,089

Product Specifications:

### STANDARD

The fabric on all Gunlocke tackboards is applied in a railroad fashion.

- Tackboard widths less than or equal to 96" are one piece
- Tackboards greater than 96" are two piece and the fabric is pattern matched
- When ordering individual wall mount tackboards to be placed side by side, the fabric pattern will be random matched. If a fabric pattern match is required, contact Gunlocke Bid/Quote for a special quote.

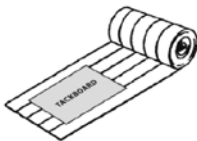

### SPECIAL

Fabric applied "up the roll" is a special application. Please see guidelines below and contact Gunlocke Bid/Quote for a special quote.

- Fabrics used on tackboard 48" and under in width can be applied "up the roll"
- Tackboards greater than 48" in width can only be applied railroaded, due to fabric height limitations

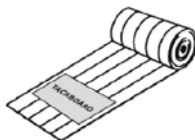

### PRODUCT INFO

102" and 108" wide tackboards are 2 piece.

See yards listed above for COM fabric requirements.

### TO ORDER PLEASE SPECIFY THE FOLLOWING:

LIST

1. **MODEL NUMBER**
2. **FABRIC**
3. **FSC TACKBOARDS**

#### FSC Tackboard Options

**FSC** = FSC Required (5% COM upcharge)

**NR** = FSC Not Required



# LAYERS WALL MOUNT GLASS WHITEBOARD IN TACKZONE

For Layers Height Credenzas

	D	W	H	model number	glass
	7/8	24	31 15/16	<b>GS2TLGW24-GSA</b>	1,629
	7/8	30	31 15/16	<b>GS2TLGW30-GSA</b>	1,714
	7/8	36	31 15/16	<b>GS2TLGW36-GSA</b>	1,951
	7/8	42	31 15/16	<b>GS2TLGW42-GSA</b>	2,264
	7/8	48	31 15/16	<b>GS2TLGW48-GSA</b>	2,576
	7/8	54	31 15/16	<b>GS2TLGW54-GSA</b>	2,890
	7/8	60	31 15/16	<b>GS2TLGW60-GSA</b>	3,198
	7/8	66	31 15/16	<b>GS2TLGW66-GSA</b>	3,660
	7/8	72	31 15/16	<b>GS2TLGW72-GSA</b>	3,898
	7/8	78	31 15/16	<b>GS2TLGW78-GSA</b>	4,321
	7/8	84	31 15/16	<b>GS2TLGW84-GSA</b>	4,908
	7/8	90	31 15/16	<b>GS2TLGW90-GSA</b>	5,136
	7/8	96	31 15/16	<b>GS2TLGW96-GSA</b>	5,384
	7/8	102	31 15/16	<b>GS2TLGW102-GSA</b>	5,613
7/8	108	31 15/16	<b>GS2TLGW108-GSA</b>	5,852	

## PRODUCT INFO

96", 102" and 108" wide whiteboards are 2 piece.  
Whiteboard frames match glass color.  
Whiteboard is magnetic.

## TO ORDER PLEASE SPECIFY THE FOLLOWING:

GLASS

1. **MODEL NUMBER**
2. **GLASS**

# TACKBOARD TO TOP OF OVERHEAD

1H and 2H | for Standard Height Credenzas

Silea

02/24

fabric grades

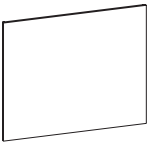
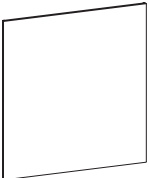
	D	W	H	yards	model number	1	2	3	COM/4
	7/8	24	39 1/16	1.25	<b>GS2TKW1H24</b>	975	996	1,020	1,045
	7/8	30	39 1/16	1.25	<b>GS2TKW1H30</b>	1,025	1,047	1,073	1,098
	7/8	36	39 1/16	1.25	<b>GS2TKW1H36</b>	1,044	1,073	1,104	1,137
	7/8	42	39 1/16	1.50	<b>GS2TKW1H42</b>	1,084	1,121	1,157	1,194
	7/8	48	39 1/16	1.50	<b>GS2TKW1H48</b>	1,118	1,155	1,191	1,228
	7/8	24	52 7/16	1.75	<b>GS2TKW2H24</b>	992	1,013	1,037	1,062
	7/8	30	52 7/16	1.75	<b>GS2TKW2H30</b>	1,044	1,066	1,092	1,117
	7/8	36	52 7/16	1.75	<b>GS2TKW2H36</b>	1,084	1,113	1,144	1,177
	7/8	42	52 7/16	1.75	<b>GS2TKW2H42</b>	1,118	1,155	1,191	1,228
	7/8	48	52 7/16	1.75	<b>GS2TKW2H48</b>	1,146	1,183	1,219	1,256

Product Specifications:

### STANDARD

The fabric on all Gunlocke tackboards is applied in a railroad fashion.

- Tackboard widths less than or equal to 96" are one piece
- Tackboards greater than 96" are two piece and the fabric is pattern matched
- When ordering individual wall mount tackboards to be placed side by side, the fabric pattern will be random matched. If a fabric pattern match is required, contact Gunlocke Bid/Quote for a special quote.

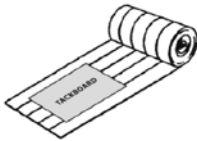

### SPECIAL

Fabric applied "up the roll" is a special application. Please see guidelines below and contact Gunlocke Bid/Quote for a special quote.

- Fabrics used on tackboard 48" and under in width can be applied "up the roll"
- Tackboards greater than 48" in width can only be applied railroaded, due to fabric height limitations

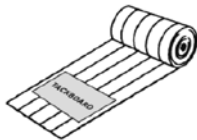

## PRODUCT INFO

See yards listed above for COM fabric requirements.

## TO ORDER PLEASE SPECIFY THE FOLLOWING:

LIST

1. **MODEL NUMBER**
2. **FABRIC**
3. **FSC TACKBOARDS**

#### FSC Tackboard Options

**FSC** = FSC Required (5% COM upcharge)

**NR** = FSC Not Required

# GLASS WHITEBOARD TO TOP OF OVERHEAD

1H and 2H | for Standard Height Credenzas

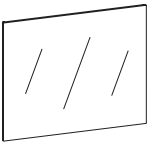
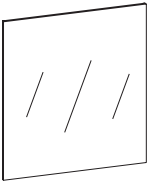
	D	W	H	model number	glass
	7/8	24	39 1/16	<b>GS2TGW1H24-GSA</b>	2,893
	7/8	30	39 1/16	<b>GS2TGW1H30-GSA</b>	3,044
	7/8	36	39 1/16	<b>GS2TGW1H36-GSA</b>	3,485
	7/8	42	39 1/16	<b>GS2TGW1H42-GSA</b>	3,713
	7/8	48	39 1/16	<b>GS2TGW1H48-GSA</b>	4,116
	7/8	24	52 7/16	<b>GS2TGW2H24-GSA</b>	3,311
	7/8	30	52 7/16	<b>GS2TGW2H30-GSA</b>	3,485
	7/8	36	52 7/16	<b>GS2TGW2H36-GSA</b>	3,713
	7/8	42	52 7/16	<b>GS2TGW2H42-GSA</b>	4,116
	7/8	48	52 7/16	<b>GS2TGW2H48-GSA</b>	4,676

## PRODUCT INFO

Whiteboard frames match glass color.  
Whiteboard is magnetic.

## TO ORDER PLEASE SPECIFY THE FOLLOWING:

GLASS

1. **MODEL NUMBER**
2. **GLASS**

# LAYERS TACKBOARD TO TOP OF OVERHEAD

1H and 2H | for Layers Height Credenzas

Silea  
02/24

fabric grades

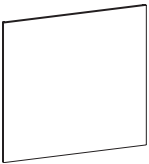
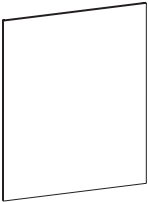
	D	W	H	yards	model number	1	2	3	COM/4
	7/8	24	46 3/16	1.50	<b>GS2TLKW1H24</b>	992	1,013	1,037	1,062
	7/8	30	46 3/16	1.50	<b>GS2TLKW1H30</b>	1,044	1,066	1,092	1,117
	7/8	36	46 3/16	1.50	<b>GS2TLKW1H36</b>	1,084	1,113	1,144	1,177
	7/8	42	46 3/16	1.50	<b>GS2TLKW1H42</b>	1,118	1,155	1,191	1,228
	7/8	48	46 3/16	1.50	<b>GS2TLKW1H48</b>	1,146	1,183	1,219	1,256
	7/8	24	59 9/16	2.00	<b>GS2TLKW2H24</b>	1,031	1,052	1,076	1,101
	7/8	30	59 9/16	2.00	<b>GS2TLKW2H30</b>	1,084	1,106	1,132	1,157
	7/8	36	59 9/16	2.00	<b>GS2TLKW2H36</b>	1,118	1,147	1,178	1,211
	7/8	42	59 9/16	2.00	<b>GS2TLKW2H42</b>	1,146	1,183	1,219	1,256
	7/8	48	59 9/16	2.00	<b>GS2TLKW2H48</b>	1,197	1,234	1,270	1,307

Product Specifications:

### STANDARD

The fabric on all Gunlocke tackboards is applied in a railroad fashion.

- Tackboard widths less than or equal to 96" are one piece
- Tackboards greater than 96" are two piece and the fabric is pattern matched
- When ordering individual wall mount tackboards to be placed side by side, the fabric pattern will be random matched. If a fabric pattern match is required, contact Gunlocke Bid/Quote for a special quote.

### SPECIAL

Fabric applied "up the roll" is a special application. Please see guidelines below and contact Gunlocke Bid/Quote for a special quote.

- Fabrics used on tackboard 48" and under in width can be applied "up the roll"
- Tackboards greater than 48" in width can only be applied railroaded, due to fabric height limitations

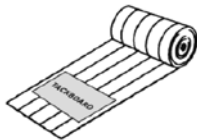
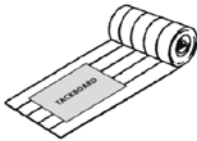

## PRODUCT INFO

See yards listed above for COM fabric requirements.

## TO ORDER PLEASE SPECIFY THE FOLLOWING:

LIST

1. **MODEL NUMBER**
2. **FABRIC**
3. **FSC TACKBOARDS**

### FSC Tackboard Options

**FSC** = FSC Required (5% COM upcharge)

**NR** = FSC Not Required

# LAYERS GLASS WHITEBOARD TO TOP OF OVERHEAD

1H and 2H | for Layers Height Credenzas

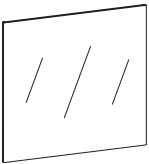
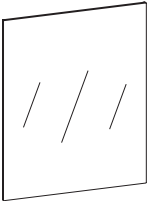
	D	W	H	model number	glass
	7/8	24	46 3/16	<b>GS2TLGW1H24-GSA</b>	3,039
	7/8	30	46 3/16	<b>GS2TLGW1H30-GSA</b>	3,198
	7/8	36	46 3/16	<b>GS2TLGW1H36-GSA</b>	3,660
	7/8	42	46 3/16	<b>GS2TLGW1H42-GSA</b>	3,898
	7/8	48	46 3/16	<b>GS2TLGW1H48-GSA</b>	4,321
	7/8	24	59 9/16	<b>GS2TLGW2H24-GSA</b>	3,478
	7/8	30	59 9/16	<b>GS2TLGW2H30-GSA</b>	3,660
	7/8	36	59 9/16	<b>GS2TLGW2H36-GSA</b>	3,898
	7/8	42	59 9/16	<b>GS2TLGW2H42-GSA</b>	4,321
	7/8	48	59 9/16	<b>GS2TLGW2H48-GSA</b>	4,908

## PRODUCT INFO

Whiteboard frames match glass color.  
Whiteboard is magnetic.

## TO ORDER PLEASE SPECIFY THE FOLLOWING:

GLASS

1. **MODEL NUMBER**
2. **GLASS**

# TACKBOARDS FOR MOUNTING 1H OVERHEADS AT 6H HEIGHT

For Standard Height Credenzas

Silea  
02/24

fabric grades

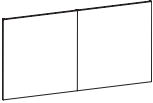
	D	W	H	yards	model number	1	2	3	COM/4
	7/8	24	38 1/4	1.00	<b>GS2TTKW24</b>	973	1,000	1,031	1,059
	7/8	30	38 1/4	1.00	<b>GS2TTKW30</b>	1,023	1,051	1,083	1,113
	7/8	36	38 1/4	1.25	<b>GS2TTKW36</b>	1,070	1,107	1,145	1,186
	7/8	42	38 1/4	1.50	<b>GS2TTKW42</b>	1,110	1,148	1,187	1,229
	7/8	48	38 1/4	1.50	<b>GS2TTKW48</b>	1,147	1,188	1,228	1,270
	7/8	54	38 1/4	2.00	<b>GS2TTKW54</b>	1,427	1,479	1,525	1,580
	7/8	60	38 1/4	2.00	<b>GS2TTKW60</b>	1,496	1,568	1,641	1,717
	7/8	66	38 1/4	2.25	<b>GS2TTKW66</b>	1,520	1,592	1,665	1,741
	7/8	72	38 1/4	2.50	<b>GS2TTKW72</b>	1,581	1,660	1,745	1,829
	7/8	78	38 1/4	2.50	<b>GS2TTKW78</b>	1,624	1,711	1,805	1,902
	7/8	84	38 1/4	2.75	<b>GS2TTKW84</b>	1,672	1,758	1,853	1,949
	7/8	90	38 1/4	3.00	<b>GS2TTKW90</b>	1,746	1,842	1,945	2,047
	7/8	96	38 1/4	3.00	<b>GS2TTKW96</b>	1,818	1,924	2,036	2,148
	7/8	102	38 1/4	3.50	<b>GS2TTKW102</b>	2,508	2,620	2,743	2,865
7/8	108	38 1/4	3.50	<b>GS2TTKW108</b>	2,601	2,723	2,856	2,985	

- Can be used in height adjustable applications with overheads to create clearance for desk and monitors. Monitor height should be verified.

Product Specifications:

### STANDARD

The fabric on all Gunlocke tackboards is applied in a railroad fashion.

- Tackboard widths less than or equal to 96" are one piece
- Tackboards greater than 96" are two piece and the fabric is pattern matched
- When ordering individual wall mount tackboards to be placed side by side, the fabric pattern will be random matched. If a fabric pattern match is required, contact Gunlocke Bid/Quote for a special quote.

### SPECIAL

Fabric applied "up the roll" is a special application. Please see guidelines below and contact Gunlocke Bid/Quote for a special quote.

- Fabrics used on tackboard 48" and under in width can be applied "up the roll"
- Tackboards greater than 48" in width can only be applied railroaded, due to fabric height limitations

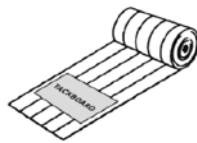
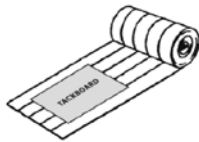

## PRODUCT INFO

54"-96" wide tackboards are 2 piece.

102"-108" wide tackboards are 3 piece.

See yards listed above for COM fabric requirements.

## TO ORDER PLEASE SPECIFY THE FOLLOWING:

LIST

1. **MODEL NUMBER**
2. **FABRIC**
3. **FSC TACKBOARDS**

**FSC Tackboard Options**

**FSC** = FSC Required (5% COM upcharge)

**NR** = FSC Not Required

# GLASS WHITEBOARDS FOR MOUNTING 1H OVERHEADS AT 6H HEIGHT

For Standard Height Credenzas

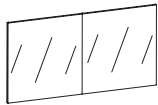

D	W	H	model number	glass
7/8	24	38 1/4	<b>GS2TTGW24-GSA</b>	2,741
7/8	30	38 1/4	<b>GS2TTGW30-GSA</b>	3,044
7/8	36	38 1/4	<b>GS2TTGW36-GSA</b>	3,485
7/8	42	38 1/4	<b>GS2TTGW42-GSA</b>	3,713
7/8	48	38 1/4	<b>GS2TTGW48-GSA</b>	4,116
7/8	54	38 1/4	<b>GS2TTGW54-GSA</b>	4,735
7/8	60	38 1/4	<b>GS2TTGW60-GSA</b>	5,483
7/8	66	38 1/4	<b>GS2TTGW66-GSA</b>	5,877
7/8	72	38 1/4	<b>GS2TTGW72-GSA</b>	6,273
7/8	78	38 1/4	<b>GS2TTGW78-GSA</b>	6,479
7/8	84	38 1/4	<b>GS2TTGW84-GSA</b>	6,684
7/8	90	38 1/4	<b>GS2TTGW90-GSA</b>	7,047
7/8	96	38 1/4	<b>GS2TTGW96-GSA</b>	7,410
7/8	102	38 1/4	<b>GS2TTGW102-GSA</b>	9,015
7/8	108	38 1/4	<b>GS2TTGW108-GSA</b>	9,410

- Can be used in height adjustable applications with overheads to create clearance for desk and monitors. Monitor height should be verified.

## PRODUCT INFO

54"-96" wide whiteboards are 2 piece.  
102"-108" wide whiteboards are 3 piece.  
Whiteboard frames match glass color.  
Whiteboard is magnetic.

## TO ORDER PLEASE SPECIFY THE FOLLOWING:

LIST

- 1. MODEL NUMBER**
- 2. GLASS**

# GLASS WHITEBOARD FROM FLOOR

To Top of 4H, 5H and 6H

Silea  
02/24

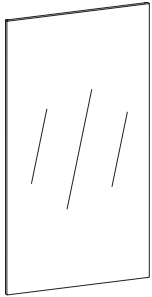

D	W	H	model number	glass
7/8	36	68 1/8	<b>GS2WGW5H36</b>	3,898
7/8	36	81 1/2	<b>GS2WGW6H36</b>	4,908

## PRODUCT INFO

Whiteboard frames match glass color.

Whiteboard is magnetic.

## TO ORDER PLEASE SPECIFY THE FOLLOWING:

GLASS

1. **MODEL NUMBER**
2. **GLASS**



# WALL MOUNT WALL IN TACKZONE

w/ Center Track | 1H | for Standard Height Credenzas

	D	W	H	model number + type	laminate	veneer 1	veneer 2	veneer 3
	3/4	30	24 13/16	<b>GS2TWD30-X</b> [ ]	864	1,092	1,202	1,311
	3/4	36	24 13/16	<b>GS2TWD36-X</b> [ ]	927	1,175	1,293	1,410
	3/4	42	24 13/16	<b>GS2TWD42-X</b> [ ]	1,034	1,305	1,436	1,566
	3/4	48	24 13/16	<b>GS2TWD48-X</b> [ ]	1,141	1,434	1,578	1,721
	3/4	54	24 13/16	<b>GS2TWD54-X</b> [ ]	1,244	1,562	1,719	1,875
	3/4	60	24 13/16	<b>GS2TWD60-X</b> [ ]	1,348	1,703	1,874	2,044
	3/4	66	24 13/16	<b>GS2TWD66-X</b> [ ]	1,440	1,823	2,006	2,188
	3/4	72	24 13/16	<b>GS2TWD72-X</b> [ ]	1,524	1,926	2,119	2,312
	3/4	78	24 13/16	<b>GS2TWD78-X</b> [ ]	1,604	2,031	2,235	2,438
	3/4	84	24 13/16	<b>GS2TWD84-X</b> [ ]	1,684	2,132	2,346	2,559
	3/4	90	24 13/16	<b>GS2TWD90-X</b> [ ]	1,886	2,385	2,624	2,862
	3/4	96	24 13/16	<b>GS2TWD96-X</b> [ ]	1,952	2,470	2,717	2,964
	3/4	102	24 13/16	<b>GS2TWD102-X</b> [ ]	2,024	2,558	2,814	3,070
	3/4	108	24 13/16	<b>GS2TWD108-X</b> [ ]	2,089	2,644	2,909	3,173

**PRODUCT INFO**

Shelving can be mounted to center aluminum track.  
Shelving ordered separately.

**TO ORDER PLEASE SPECIFY THE FOLLOWING:**

WOOD

1. **MODEL NUMBER + W**
2. **FSC**
3. **CHASSIS WOOD FINISH**
4. **EXTRUSION COLOR**

LAM

1. **MODEL NUMBER + L**
2. **FSC**
3. **CHASSIS LAM**
4. **EXTRUSION COLOR**

# MAGNETIC WALL MOUNT WALL IN TACKZONE

w/ Steel Backer | 1H | for Standard Height Credenzas

Silea

02/24

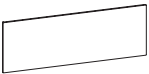
	D	W	H	model number + type	veneer 1	veneer 2	veneer 3
	3/4	24	24 13/16	<b>GS2TWD24-</b> <input type="checkbox"/>	1,467	1,614	1,761
	3/4	30	24 13/16	<b>GS2TWD30-</b> <input type="checkbox"/>	1,503	1,654	1,804
	3/4	36	24 13/16	<b>GS2TWD36-</b> <input type="checkbox"/>	1,593	1,753	1,912
	3/4	42	24 13/16	<b>GS2TWD42-</b> <input type="checkbox"/>	1,735	1,909	2,082
	3/4	48	24 13/16	<b>GS2TWD48-</b> <input type="checkbox"/>	1,877	2,065	2,253
	3/4	54	24 13/16	<b>GS2TWD54-</b> <input type="checkbox"/>	2,016	2,218	2,420
	3/4	60	24 13/16	<b>GS2TWD60-</b> <input type="checkbox"/>	2,157	2,373	2,589
	3/4	66	24 13/16	<b>GS2TWD66-</b> <input type="checkbox"/>	2,283	2,512	2,740
	3/4	72	24 13/16	<b>GS2TWD72-</b> <input type="checkbox"/>	2,478	2,726	2,974
	3/4	78	24 13/16	<b>GS2TWD78-</b> <input type="checkbox"/>	2,558	2,814	3,070
	3/4	84	24 13/16	<b>GS2TWD84-</b> <input type="checkbox"/>	2,696	2,966	3,236
	3/4	90	24 13/16	<b>GS2TWD90-</b> <input type="checkbox"/>	3,052	3,358	3,663
	3/4	96	24 13/16	<b>GS2TWD96-</b> <input type="checkbox"/>	3,141	3,456	3,770
	3/4	102	24 13/16	<b>GS2TWD102-</b> <input type="checkbox"/>	3,235	3,559	3,882
3/4	108	24 13/16	<b>GS2TWD108-</b> <input type="checkbox"/>	3,407	3,748	4,089	

## PRODUCT INFO

Tackzone is magnetic.  
It is not recommended to stack wood units side by side due to grain variation. Contact Tailored Solutions for a matched set.

## TO ORDER PLEASE SPECIFY THE FOLLOWING:

### WOOD

1. **MODEL NUMBER + W**
2. **FSC**
3. **CHASSIS WOOD FINISH**

# LAYERS WALL MOUNT WALL IN TACKZONE

w/ Center Track | for Layers Height Credenzas

	D	W	H	model number + type	laminate	veneer 1	veneer 2	veneer 3
	3/4	30	31 15/16	<b>GS2TLWD30-X</b> [ ]	907	1,148	1,263	1,378
	3/4	36	31 15/16	<b>GS2TLWD36-X</b> [ ]	974	1,234	1,358	1,481
	3/4	42	31 15/16	<b>GS2TLWD42-X</b> [ ]	1,114	1,410	1,551	1,692
	3/4	48	31 15/16	<b>GS2TLWD48-X</b> [ ]	1,225	1,548	1,703	1,858
	3/4	54	31 15/16	<b>GS2TLWD54-X</b> [ ]	1,334	1,691	1,861	2,030
	3/4	60	31 15/16	<b>GS2TLWD60-X</b> [ ]	1,416	1,792	1,972	2,151
	3/4	66	31 15/16	<b>GS2TLWD66-X</b> [ ]	1,515	1,915	2,107	2,298
	3/4	72	31 15/16	<b>GS2TLWD72-X</b> [ ]	1,598	2,026	2,229	2,432
	3/4	78	31 15/16	<b>GS2TLWD78-X</b> [ ]	1,684	2,134	2,348	2,561
	3/4	84	31 15/16	<b>GS2TLWD84-X</b> [ ]	1,770	2,241	2,466	2,690
	3/4	90	31 15/16	<b>GS2TLWD90-X</b> [ ]	1,979	2,507	2,758	3,009
	3/4	96	31 15/16	<b>GS2TLWD96-X</b> [ ]	2,049	2,597	2,857	3,117
	3/4	102	31 15/16	<b>GS2TLWD102-X</b> [ ]	2,124	2,689	2,958	3,227
3/4	108	31 15/16	<b>GS2TLWD108-X</b> [ ]	2,193	2,778	3,056	3,334	

## PRODUCT INFO

Shelving can be mounted to center aluminum track.  
Shelving ordered separately.

## TO ORDER PLEASE SPECIFY THE FOLLOWING:

### WOOD

1. **MODEL NUMBER + W**
2. **FSC**
3. **CHASSIS WOOD FINISH**
4. **EXTRUSION COLOR**

### LAM

1. **MODEL NUMBER + L**
2. **FSC**
3. **CHASSIS LAM**
4. **EXTRUSION COLOR**

# MAGNETIC WALL MOUNT WALL IN TACKZONE

w/ Steel Backer | for Layers Height Credenzas

Silea

02/24

	D	W	H	model number + type	veneer 1	veneer 2	veneer 3
	3/4	24	31 15/16	<b>GS2TLWD24-</b> <input type="checkbox"/>	1,540	1,694	1,848
	3/4	30	31 15/16	<b>GS2TLWD30-</b> <input type="checkbox"/>	1,579	1,737	1,895
	3/4	36	31 15/16	<b>GS2TLWD36-</b> <input type="checkbox"/>	1,673	1,841	2,008
	3/4	42	31 15/16	<b>GS2TLWD42-</b> <input type="checkbox"/>	1,822	2,005	2,187
	3/4	48	31 15/16	<b>GS2TLWD48-</b> <input type="checkbox"/>	1,970	2,167	2,364
	3/4	54	31 15/16	<b>GS2TLWD54-</b> <input type="checkbox"/>	2,117	2,329	2,541
	3/4	60	31 15/16	<b>GS2TLWD60-</b> <input type="checkbox"/>	2,264	2,491	2,717
	3/4	66	31 15/16	<b>GS2TLWD66-</b> <input type="checkbox"/>	2,395	2,635	2,874
	3/4	72	31 15/16	<b>GS2TLWD72-</b> <input type="checkbox"/>	2,603	2,864	3,124
	3/4	78	31 15/16	<b>GS2TLWD78-</b> <input type="checkbox"/>	2,687	2,956	3,225
	3/4	84	31 15/16	<b>GS2TLWD84-</b> <input type="checkbox"/>	2,829	3,112	3,395
	3/4	90	31 15/16	<b>GS2TLWD90-</b> <input type="checkbox"/>	3,204	3,525	3,845
	3/4	96	31 15/16	<b>GS2TLWD96-</b> <input type="checkbox"/>	3,297	3,627	3,957
	3/4	102	31 15/16	<b>GS2TLWD102-</b> <input type="checkbox"/>	3,398	3,738	4,078
3/4	108	31 15/16	<b>GS2TLWD108-</b> <input type="checkbox"/>	3,579	3,937	4,295	

## PRODUCT INFO

Tackzone is magnetic.  
It is not recommended to stack wood units side by side due to grain variation. Contact Tailored Solutions for a matched set.

## TO ORDER PLEASE SPECIFY THE FOLLOWING:

### WOOD

1. **MODEL NUMBER + W**
2. **FSC**
3. **CHASSIS WOOD FINISH**

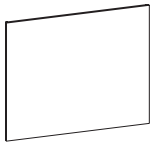

D	W	H	model number + type	veneer 1	veneer 2	veneer 3
3/4	24	39 1/16	GS2TWD1H24- [ ]	2,102	2,313	2,523
3/4	30	39 1/16	GS2TWD1H30- [ ]	2,157	2,373	2,589
3/4	36	39 1/16	GS2TWD1H36- [ ]	2,283	2,512	2,740
3/4	42	39 1/16	GS2TWD1H42- [ ]	2,478	2,726	2,974
3/4	48	39 1/16	GS2TWD1H48- [ ]	2,558	2,814	3,070
3/4	54	39 1/16	GS2TWD1H54- [ ]	2,687	2,956	3,225
3/4	60	39 1/16	GS2TWD1H60- [ ]	2,819	3,101	3,383
3/4	66	39 1/16	GS2TWD1H66- [ ]	2,961	3,258	3,554
3/4	72	39 1/16	GS2TWD1H72- [ ]	3,110	3,421	3,732
3/4	78	39 1/16	GS2TWD1H78- [ ]	3,265	3,592	3,918
3/4	84	39 1/16	GS2TWD1H84- [ ]	3,429	3,772	4,115
3/4	90	39 1/16	GS2TWD1H90- [ ]	3,600	3,960	4,320
3/4	96	39 1/16	GS2TWD1H96- [ ]	3,780	4,158	4,536
3/4	102	39 1/16	GS2TWD1H102- [ ]	3,969	4,366	4,763
3/4	108	39 1/16	GS2TWD1H108- [ ]	4,167	4,584	5,001

**PRODUCT INFO**

Tackzone is magnetic.  
It is not recommended to stack wood units side by side due to grain variation. Contact Tailored Solutions for a matched set.  
24" - 48" = 1 piece  
54" - 102" = 2 piece  
108" = 3 piece

**TO ORDER PLEASE SPECIFY THE FOLLOWING:**

- WOOD
1. **MODEL NUMBER + W**
  2. **FSC**
  3. **CHASSIS WOOD FINISH**

# MAGNETIC WOOD TO TOP OF OVERHEAD

2H | for Standard Height Credenzas

Silea

02/24

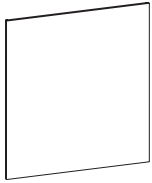

D	W	H	model number + type	veneer 1	veneer 2	veneer 3
3/4	24	52 7/16	<b>GS2TWD2H24-</b> [ ]	2,226	2,449	2,672
3/4	30	52 7/16	<b>GS2TWD2H30-</b> [ ]	2,283	2,512	2,740
3/4	36	52 7/16	<b>GS2TWD2H36-</b> [ ]	2,478	2,726	2,974
3/4	42	52 7/16	<b>GS2TWD2H42-</b> [ ]	2,558	2,814	3,070
3/4	48	52 7/16	<b>GS2TWD2H48-</b> [ ]	2,696	2,966	3,236
3/4	54	52 7/16	<b>GS2TWD2H54-</b> [ ]	2,830	3,113	3,396
3/4	60	52 7/16	<b>GS2TWD2H60-</b> [ ]	2,972	3,270	3,567
3/4	66	52 7/16	<b>GS2TWD2H66-</b> [ ]	3,121	3,434	3,746
3/4	72	52 7/16	<b>GS2TWD2H72-</b> [ ]	3,276	3,604	3,932
3/4	78	52 7/16	<b>GS2TWD2H78-</b> [ ]	3,440	3,784	4,128
3/4	84	52 7/16	<b>GS2TWD2H84-</b> [ ]	3,613	3,975	4,336
3/4	90	52 7/16	<b>GS2TWD2H90-</b> [ ]	3,792	4,172	4,551
3/4	96	52 7/16	<b>GS2TWD2H96-</b> [ ]	3,984	4,383	4,781
3/4	102	52 7/16	<b>GS2TWD2H102-</b> [ ]	4,183	4,602	5,020
3/4	108	52 7/16	<b>GS2TWD2H108-</b> [ ]	4,392	4,832	5,271

## PRODUCT INFO

Tackzone is magnetic.  
It is not recommended to stack wood units side by side due to grain variation. Contact Tailored Solutions for a matched set.

24" - 48" = 1 piece  
54" - 102" = 2 piece  
108" = 3 piece

## TO ORDER PLEASE SPECIFY THE FOLLOWING:

### WOOD

- 1. MODEL NUMBER + W**
- 2. FSC**
- 3. CHASSIS WOOD FINISH**

# LAYERS MAGNETIC WOOD TO TOP OF OVERHEAD

1H | for Layers Height Credenzas

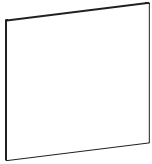

D	W	H	model number	veneer 1	veneer 2	veneer 3
3/4	24	46 3/16	<b>GS2TLWD1H24-</b> [ ]	2,207	2,428	2,649
3/4	30	46 3/16	<b>GS2TLWD1H30-</b> [ ]	2,264	2,491	2,717
3/4	36	46 3/16	<b>GS2TLWD1H36-</b> [ ]	2,395	2,635	2,874
3/4	42	46 3/16	<b>GS2TLWD1H42-</b> [ ]	2,603	2,864	3,124
3/4	48	46 3/16	<b>GS2TLWD1H48-</b> [ ]	2,687	2,956	3,225
3/4	54	46 3/16	<b>GS2TLWD1H54-</b> [ ]	2,819	3,101	3,383
3/4	60	46 3/16	<b>GS2TLWD1H60-</b> [ ]	2,961	3,258	3,554
3/4	66	46 3/16	<b>GS2TLWD1H66-</b> [ ]	3,110	3,421	3,732
3/4	72	46 3/16	<b>GS2TLWD1H72-</b> [ ]	3,265	3,592	3,918
3/4	78	46 3/16	<b>GS2TLWD1H78-</b> [ ]	3,429	3,772	4,115
3/4	84	46 3/16	<b>GS2TLWD1H84-</b> [ ]	3,600	3,960	4,320
3/4	90	46 3/16	<b>GS2TLWD1H90-</b> [ ]	3,780	4,158	4,536
3/4	96	46 3/16	<b>GS2TLWD1H96-</b> [ ]	3,969	4,366	4,763
3/4	102	46 3/16	<b>GS2TLWD1H102-</b> [ ]	4,167	4,584	5,001
3/4	108	46 3/16	<b>GS2TLWD1H108-</b> [ ]	4,375	4,813	5,250

## PRODUCT INFO

Tackzone is magnetic.  
It is not recommended to stack wood units side by side due to grain variation. Contact Tailored Solutions for a matched set.

24" - 48" = 1 piece  
54" - 102" = 2 piece  
108" = 3 piece

## TO ORDER PLEASE SPECIFY THE FOLLOWING:

### WOOD

1. **MODEL NUMBER + W**
2. **FSC**
3. **CHASSIS WOOD FINISH**

# LAYERS MAGNETIC WOOD TO TOP OF OVERHEAD

2H | for Layers Height Credenzas

Silea

02/24

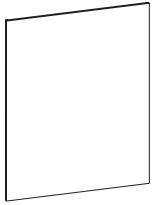

D	W	H	model number	veneer 1	veneer 2	veneer 3
3/4	24	59 9/16	<b>GS2TLWD2H24-</b> [ ]	2,337	2,571	2,805
3/4	30	59 9/16	<b>GS2TLWD2H30-</b> [ ]	2,395	2,635	2,874
3/4	36	59 9/16	<b>GS2TLWD2H36-</b> [ ]	2,603	2,864	3,124
3/4	42	59 9/16	<b>GS2TLWD2H42-</b> [ ]	2,687	2,956	3,225
3/4	48	59 9/16	<b>GS2TLWD2H48-</b> [ ]	2,829	3,112	3,395
3/4	54	59 9/16	<b>GS2TLWD2H54-</b> [ ]	2,972	3,270	3,567
3/4	60	59 9/16	<b>GS2TLWD2H60-</b> [ ]	3,121	3,434	3,746
3/4	66	59 9/16	<b>GS2TLWD2H66-</b> [ ]	3,276	3,604	3,932
3/4	72	59 9/16	<b>GS2TLWD2H72-</b> [ ]	3,440	3,784	4,128
3/4	78	59 9/16	<b>GS2TLWD2H78-</b> [ ]	3,613	3,975	4,336
3/4	84	59 9/16	<b>GS2TLWD2H84-</b> [ ]	3,792	4,172	4,551
3/4	90	59 9/16	<b>GS2TLWD2H90-</b> [ ]	3,984	4,383	4,781
3/4	96	59 9/16	<b>GS2TLWD2H96-</b> [ ]	4,183	4,602	5,020
3/4	102	59 9/16	<b>GS2TLWD2H102-</b> [ ]	4,392	4,832	5,271
3/4	108	59 9/16	<b>GS2TLWD2H108-</b> [ ]	4,609	5,070	5,531

## PRODUCT INFO

Tackzone is magnetic.

It is not recommended to stack wood units side by side due to grain variation. Contact Tailored Solutions for a matched set.

24" - 48" = 1 piece

54" - 102" = 2 piece

108" = 3 piece

## TO ORDER PLEASE SPECIFY THE FOLLOWING:

### WOOD

1. **MODEL NUMBER + W**
2. **FSC**
3. **CHASSIS WOOD FINISH**



# MAGNETIC WOOD TACKZONE FOR MOUNTING 1H OVERHEADS AT 6H HEIGHT

for Standard Height Credenzas

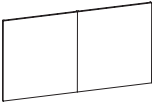
	D	W	H	model number + type	veneer 1	veneer 2	veneer 3
	7/8	24	38 1/4	<b>GS2TTWD24-</b> [ ]	2,102	2,313	2,523
	7/8	30	38 1/4	<b>GS2TTWD30-</b> [ ]	2,157	2,373	2,589
	7/8	36	38 1/4	<b>GS2TTWD36-</b> [ ]	2,283	2,512	2,740
	7/8	42	38 1/4	<b>GS2TTWD42-</b> [ ]	2,478	2,726	2,974
	7/8	48	38 1/4	<b>GS2TTWD48-</b> [ ]	2,558	2,814	3,070
	7/8	54	38 1/4	<b>GS2TTWD54-</b> [ ]	2,687	2,956	3,225
	7/8	60	38 1/4	<b>GS2TTWD60-</b> [ ]	2,819	3,101	3,383
	7/8	66	38 1/4	<b>GS2TTWD66-</b> [ ]	2,961	3,258	3,554
	7/8	72	38 1/4	<b>GS2TTWD72-</b> [ ]	3,110	3,421	3,732
	7/8	78	38 1/4	<b>GS2TTWD78-</b> [ ]	3,265	3,592	3,918
	7/8	84	38 1/4	<b>GS2TTWD84-</b> [ ]	3,429	3,772	4,115
	7/8	90	38 1/4	<b>GS2TTWD90-</b> [ ]	3,600	3,960	4,320
	7/8	96	38 1/4	<b>GS2TTWD96-</b> [ ]	3,780	4,158	4,536
	7/8	102	38 1/4	<b>GS2TTWD102-</b> [ ]	3,969	4,366	4,763
7/8	108	38 1/4	<b>GS2TTWD108-</b> [ ]	4,167	4,584	5,001	

- Can be used in height adjustable applications with overheads to create clearance for desk and monitors. Monitor height should be verified.

## PRODUCT INFO

Tackzone is magnetic.  
It is not recommended to stack wood units side by side due to grain variation. Contact Tailored Solutions for a matched set.  
54"-96" models are 2-piece.  
102"-108" models are 3-piece.

## TO ORDER PLEASE SPECIFY THE FOLLOWING:

### WOOD

- 1. MODEL NUMBER + W**
- 2. FSC**
- 3. CHASSIS WOOD FINISH**

# SHELVING FOR WALL MOUNT WALL

8 1/2" depth

Silea  
02/24

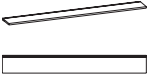
	D	W	H	model number + type	laminate	aluminum	veneer 1	veneer 2	veneer 3	
<b>ALUMINUM</b>  Side view	8 1/2	30	3/4	<b>GS2ASF830-</b> [ ]	635	831	804	885	965	
	8 1/2	36	3/4	<b>GS2ASF836-</b> [ ]	688	897	869	956	1,043	
	8 1/2	42	3/4	<b>GS2ASF842-</b> [ ]	765	981	970	1,067	1,164	
	8 1/2	48	3/4	<b>GS2ASF848-</b> [ ]	842	1,077	1,066	1,173	1,280	
	8 1/2	54	3/4	<b>GS2ASF854-</b> [ ]	920	1,175	1,165	1,282	1,398	
	8 1/2	60	3/4	<b>GS2ASF860-</b> [ ]	995	1,297	1,257	1,383	1,509	
	8 1/2	66	3/4	<b>GS2ASF866-</b> [ ]	1,063	1,385	1,346	1,481	1,616	
	8 1/2	72	3/4	<b>GS2ASF872-</b> [ ]	1,123	1,460	1,420	1,562	1,704	
	<b>LAM / WOOD</b>  Side view	8 1/2	78	3/4	<b>GS2ASF878-</b> [ ]	1,182	1,541	1,498	1,648	1,798
		8 1/2	84	3/4	<b>GS2ASF884-</b> [ ]	1,246	1,619	1,573	1,731	1,888
8 1/2		90	3/4	<b>GS2ASF890-</b> [ ]	1,391	1,811	1,761	1,938	2,114	
8 1/2		96	3/4	<b>GS2ASF896-</b> [ ]	1,444	1,875	1,822	2,005	2,187	
8 1/2		102	3/4	<b>GS2ASF8102-</b> [ ]	1,492	1,941	1,884	2,073	2,261	
8 1/2		108	3/4	<b>GS2ASF8108-</b> [ ]	1,542	2,007	1,949	2,144	2,339	
8 1/2		114	3/4	<b>GS2ASF8114-</b> [ ]	1,841	2,237	2,331	2,565	2,798	
8 1/2		120	3/4	<b>GS2ASF8120-</b> [ ]	1,990	2,591	2,516	2,768	3,020	
8 1/2		132	3/4	<b>GS2ASF8132-</b> [ ]	2,132	N/A	2,697	2,967	3,237	
8 1/2		144	3/4	<b>GS2ASF8144-</b> [ ]	2,247	N/A	2,845	3,130	3,414	

• Note: Weight capacity for 8 1/2" depth shelves is 1.75 lbs per linear inch of shelf width. Load should be evenly distributed.

## PRODUCT INFO

Aluminum shelf is powder coated.

An aluminum rail is mounted to back of shelf.

Laminate shelves (2) piece above 96".

All aluminum shelves are (1) piece.

Wood shelves (2) piece above 120".

Light ordered separately:  
 30" and 36" = (1) 24" light  
 60" = (1) 48" light  
 66" through 108" = (1) 60" light  
 120" = (2) 48" lights

## TO ORDER PLEASE SPECIFY THE FOLLOWING:

### WOOD





















- MODEL NUMBER + W**
- FSC**
- CHASSIS WOOD FINISH**
- EXTRUSION COLOR**

### ALUMINUM

- MODEL NUMBER + A**
- EXTRUSION COLOR**

### LAM

- MODEL NUMBER + L**
- FSC**
- CHASSIS LAM**
- EXTRUSION COLOR**

	D	W	H	model number + type	laminate	aluminum	veneer 1	veneer 2	veneer 3	
<b>ALUMINUM</b>  Side view	12 1/2	30	3/4	<b>GS2ASF1230-</b> 	706	922	896	986	1,076	
	12 1/2	36	3/4	<b>GS2ASF1236-</b> 	763	995	967	1,064	1,161	
	12 1/2	42	3/4	<b>GS2ASF1242-</b> 	850	1,089	1,076	1,184	1,292	
	12 1/2	48	3/4	<b>GS2ASF1248-</b> 	937	1,196	1,185	1,304	1,422	
	12 1/2	54	3/4	<b>GS2ASF1254-</b> 	1,022	1,302	1,294	1,424	1,553	
	12 1/2	60	3/4	<b>GS2ASF1260-</b> 	1,107	1,438	1,397	1,537	1,677	
	12 1/2	66	3/4	<b>GS2ASF1266-</b> 	1,182	1,540	1,495	1,645	1,794	
	12 1/2	72	3/4	<b>GS2ASF1272-</b> 	1,248	1,661	1,576	1,734	1,892	
	<b>LAM / WOOD</b>  Side view	12 1/2	78	3/4	<b>GS2ASF1278-</b> 	1,317	1,748	1,663	1,830	1,996
		12 1/2	84	3/4	<b>GS2ASF1284-</b> 	1,385	1,839	1,748	1,923	2,098
12 1/2		90	3/4	<b>GS2ASF1290-</b> 	1,547	2,014	1,955	2,151	2,346	
12 1/2		96	3/4	<b>GS2ASF1296-</b> 	1,599	2,084	2,025	2,228	2,430	
12 1/2		102	3/4	<b>GS2ASF12102-</b> 	1,656	2,156	2,095	2,305	2,514	
12 1/2		108	3/4	<b>GS2ASF12108-</b> 	1,713	2,280	2,165	2,382	2,598	
12 1/2		114	3/4	<b>GS2ASF12114-</b> 	1,983	2,490	2,512	2,764	3,015	
12 1/2		120	3/4	<b>GS2ASF12120-</b> 	2,212	2,881	2,797	3,077	3,357	
12 1/2		132	3/4	<b>GS2ASF12132-</b> 	2,367	N/A	2,996	3,296	3,596	
12 1/2		144	3/4	<b>GS2ASF12144-</b> 	2,496	N/A	3,163	3,480	3,796	

• Note: Weight capacity for 12 1/2" depth shelves is 2.50 lbs per linear inch of shelf width. Load should be evenly distributed.

**PRODUCT INFO**

Aluminum shelf is powder coated.

An aluminum rail is mounted to back of shelf.

Laminate shelves (2) piece above 96".

All aluminum shelves are (1) piece.

Wood shelves (2) piece above 120".

Light ordered separately:  
 30" and 36" = (1) 24" light  
 60" = (1) 48" light  
 66" through 108" = (1) 60" light  
 120" = (2) 48" lights

**TO ORDER PLEASE SPECIFY THE FOLLOWING:**

**WOOD**

- MODEL NUMBER + W**
- FSC**
- CHASSIS WOOD FINISH**
- EXTRUSION COLOR**

**ALUMINUM**

- MODEL NUMBER + A**
- EXTRUSION COLOR**

**LAM**

- MODEL NUMBER + L**
- FSC**
- CHASSIS LAM**
- EXTRUSION COLOR**

# FLOATING SHELVES

Silea  
02/24



D	W	H	model number + type	laminate	veneer 1	veneer 2	veneer 3
8	30	1 3/16	<b>GS2FSF830-</b> <input type="checkbox"/>	648	820	902	984
8	36	1 3/16	<b>GS2FSF836-</b> <input type="checkbox"/>	702	887	976	1,065
8	42	1 3/16	<b>GS2FSF842-</b> <input type="checkbox"/>	826	1,045	1,150	1,254
8	48	1 3/16	<b>GS2FSF848-</b> <input type="checkbox"/>	927	1,175	1,293	1,410
8	54	1 3/16	<b>GS2FSF854-</b> <input type="checkbox"/>	973	1,232	1,356	1,479
8	60	1 3/16	<b>GS2FSF860-</b> <input type="checkbox"/>	1,014	1,285	1,414	1,542
8	66	1 3/16	<b>GS2FSF866-</b> <input type="checkbox"/>	1,068	1,351	1,487	1,622
8	72	1 3/16	<b>GS2FSF872-</b> <input type="checkbox"/>	1,145	1,450	1,595	1,740

**NOTE:** For display purposes only.  
5 lb. weight restriction per linear foot.

## PRODUCT INFO

### TO ORDER PLEASE SPECIFY THE FOLLOWING:

#### WOOD

1. **MODEL NUMBER + W**
2. **FSC**
3. **CHASSIS WOOD FINISH**

#### LAM

1. **MODEL NUMBER + L**
2. **FSC**
3. **CHASSIS LAM**

Surface Mount . . . . .	303-316
Cabinets . . . . .	304-308
Towers . . . . .	309-314
Tackboard . . . . .	315
External Tops . . . . .	316

# SURFACE MOUNT CABINETS

w/ Hinged Doors | 1H

Silea  
02/24

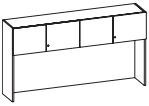
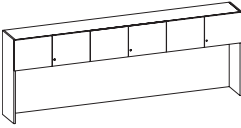
	D	W	H	model number + type	laminate	veneer 1	veneer 2	veneer 3
	15 3/4	59 7/8	39 1/16	<b>GS2SMC1H60-</b> [ ]	4,187	5,295	5,825	6,354
	15 3/4	65 7/8	39 1/16	<b>GS2SMC1H66-</b> [ ]	4,342	5,490	6,039	6,588
	15 3/4	71 7/8	39 1/16	<b>GS2SMC1H72-</b> [ ]	4,703	5,945	6,540	7,134
	15 3/4	77 7/8	39 1/16	<b>GS2SMC1H78-</b> [ ]	4,794	6,061	6,668	7,274
	15 3/4	83 7/8	39 1/16	<b>GS2SMC1H84-</b> [ ]	5,036	6,367	7,004	7,641
	15 3/4	89 7/8	39 1/16	<b>GS2SMC1H90-</b> [ ]	5,306	6,706	7,377	8,048
	15 3/4	95 7/8	39 1/16	<b>GS2SMC1H96-</b> [ ]	5,577	7,052	7,758	8,463
	15 3/4	101 7/8	39 1/16	<b>GS2SMC1H102-</b> [ ]	N/A	7,695	8,465	9,234
	15 3/4	107 7/8	39 1/16	<b>GS2SMC1H108-</b> [ ]	N/A	8,195	9,015	9,834

## PRODUCT INFO

# of doors:  
60" through 78" = 4 doors  
84" through 108" = 6 doors  
All units have a finished back.  
If tasklight cord grommet is chosen (WY), a 1 1/4" hole is included in back panel.

## TO ORDER PLEASE SPECIFY THE FOLLOWING:

- |                                  |                                  |
|----------------------------------|----------------------------------|
| WOOD CHASSIS, WOOD DOOR          | LAM CHASSIS, LAM DOOR            |
| 1. <b>MODEL NUMBER + WW</b>      | 1. <b>MODEL NUMBER + LL</b>      |
| 2. <b>FSC</b>                    | 2. <b>FSC</b>                    |
| 3. <b>CHASSIS WOOD FINISH</b>    | 3. <b>CHASSIS LAM</b>            |
| 4. <b>TASKLIGHT CORD GROMMET</b> | 4. <b>FRONT LAM</b>              |
| 5. <b>LOCKS</b>                  | 5. <b>TASKLIGHT CORD GROMMET</b> |
| 6. <b>KEYING</b>                 | 6. <b>LOCKS</b>                  |
|                                  | 7. <b>KEYING</b>                 |

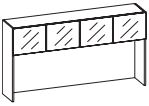
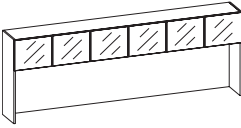
	D	W	H	model number + type	veneer 1	veneer 2	veneer 3
 	15 3/4	59 7/8	39 1/16	<b>GS2SMC1H60-</b> [ ]	6,469	7,116	7,763
	15 3/4	71 7/8	39 1/16	<b>GS2SMC1H72-</b> [ ]	7,267	7,994	8,721
	15 3/4	89 7/8	39 1/16	<b>GS2SMC1H90-</b> [ ]	8,199	9,019	9,839
	15 3/4	107 7/8	39 1/16	<b>GS2SMC1H108-</b> [ ]	10,015	11,017	12,018

**PRODUCT INFO**

# of doors:

60" and 72" = 4 doors

90" and 108" = 6 doors

All units have a finished back.

Glass doors do not lock.

Door frames match glass color.

If tasklight cord grommet is chosen (WY), a 1 1/4" hole is included in back panel.

**TO ORDER PLEASE SPECIFY THE FOLLOWING:**

WOOD CHASSIS, GLASS DOOR

1. **MODEL NUMBER + WG**
2. **FSC**
3. **CHASSIS WOOD FINISH**
4. **GLASS**
5. **TASKLIGHT CORD GROMMET**

# SURFACE MOUNT CABINETS

No Doors | 1H

Silea

02/24

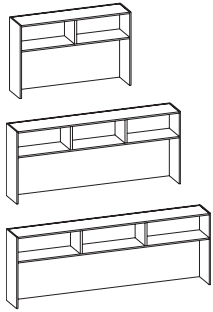

D	W	H	model number + type	laminate	veneer 1	veneer 2	veneer 3
14 7/8	59 7/8	39 1/16	<b>GS2SMC1H60-</b> [ ]	3,560	4,506	4,957	5,408
14 7/8	65 7/8	39 1/16	<b>GS2SMC1H66-</b> [ ]	3,692	4,673	5,141	5,608
14 7/8	71 7/8	39 1/16	<b>GS2SMC1H72-</b> [ ]	3,996	5,060	5,566	6,072
14 7/8	77 7/8	39 1/16	<b>GS2SMC1H78-</b> [ ]	4,075	5,162	5,679	6,195
14 7/8	83 7/8	39 1/16	<b>GS2SMC1H84-</b> [ ]	4,279	5,419	5,961	6,503
14 7/8	89 7/8	39 1/16	<b>GS2SMC1H90-</b> [ ]	4,509	5,707	6,278	6,849
14 7/8	95 7/8	39 1/16	<b>GS2SMC1H96-</b> [ ]	4,741	6,003	6,604	7,204
14 7/8	101 7/8	39 1/16	<b>GS2SMC1H102-</b> [ ]	N/A	6,549	7,204	7,859
14 7/8	107 7/8	39 1/16	<b>GS2SMC1H108-</b> [ ]	N/A	6,975	7,673	8,370

## PRODUCT INFO

# of doors:  
 60" through 78" = 4 doors  
 84" and 90" = 6 doors  
 All units have a finished back.  
 If tasklight cord grommet is chosen (WY), a 1 1/4" hole is included in back panel.

## TO ORDER PLEASE SPECIFY THE FOLLOWING:

### WOOD CHASSIS

1. **MODEL NUMBER + WN**
2. **FSC**
3. **CHASSIS WOOD FINISH**
4. **TASKLIGHT CORD GROMMET**

### LAM CHASSIS

1. **MODEL NUMBER + LN**
2. **FSC**
3. **CHASSIS LAM**
4. **TASKLIGHT CORD GROMMET**

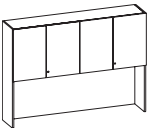
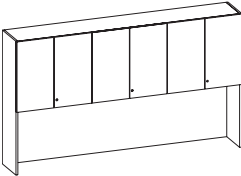

	D	W	H	model number + type	veneer 1	veneer 2	veneer 3
	15 3/4	59 7/8	52 7/16	<b>GS2SMC2H60-</b> [ ]	6,418	7,060	7,702
	15 3/4	65 7/8	52 7/16	<b>GS2SMC2H66-</b> [ ]	6,584	7,243	7,901
	15 3/4	71 7/8	52 7/16	<b>GS2SMC2H72-</b> [ ]	6,852	7,538	8,223
	15 3/4	77 7/8	52 7/16	<b>GS2SMC2H78-</b> [ ]	7,247	7,972	8,697
	15 3/4	83 7/8	52 7/16	<b>GS2SMC2H84-</b> [ ]	7,611	8,373	9,134
	15 3/4	89 7/8	52 7/16	<b>GS2SMC2H90-</b> [ ]	7,974	8,772	9,569

• Not for use w/ credenza trough top.

**PRODUCT INFO**

# of doors:  
60" through 78" = 4 doors  
84" and 90" = 6 doors  
All units have a finished back.  
If tasklight cord grommet is chosen (WY), a 1 1/4" hole is included in back panel.

**TO ORDER PLEASE SPECIFY THE FOLLOWING:**

- WOOD CHASSIS, WOOD DOOR
1. **MODEL NUMBER + WW**
  2. **FSC**
  3. **CHASSIS WOOD FINISH**
  4. **TASKLIGHT CORD GROMMET**
  5. **LOCKS**
  6. **KEYING**

# SURFACE MOUNT CABINETS

w/ Hinged Glass Doors | 2H

Silea

02/24

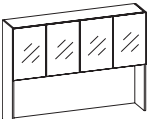
	D	W	H	model number + type	veneer 1	veneer 2	veneer 3
	15 3/4	59 7/8	52 7/16	<b>GS2SMC2H60-</b> [ ]	7,847	8,632	9,417
	15 3/4	71 7/8	52 7/16	<b>GS2SMC2H72-</b> [ ]	8,375	9,213	10,050
	15 3/4	89 7/8	52 7/16	<b>GS2SMC2H90-</b> [ ]	9,747	10,722	11,697

• Not for use w/ credenza trough top.

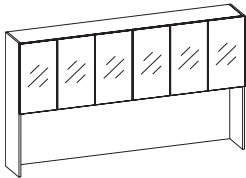

## PRODUCT INFO

# of doors:

60" and 72" = 4 doors

90" = 6 doors

Glass doors do not lock.

All units have a finished back.





Door frames match glass color.

If tasklight cord grommet is chosen (WY), a 1 1/4" hole is included in back panel.

## TO ORDER PLEASE SPECIFY THE FOLLOWING:

WOOD CHASSIS, GLASS DOOR

1. **MODEL NUMBER + WG**
2. **FSC**
3. **CHASSIS WOOD FINISH**
4. **GLASS**
5. **TASKLIGHT CORD GROMMET**

		D	W	H	model number + type	laminate	veneer 1	veneer 2	veneer 3
<b>15" WIDTH</b>									
 1 door Door hinged left	LEFT	15 3/4	15	39 1/16	<b>GS2STF1H15L-</b> <input type="text"/>	1,238	1,370	1,507	1,644
	RIGHT	15 3/4	15	39 1/16	<b>GS2STF1H15R-</b> <input type="text"/>	1,238	1,370	1,507	1,644
<b>18" WIDTH</b>									
 1 door Door hinged left	LEFT	15 3/4	18	39 1/16	<b>GS2STF1H18L-</b> <input type="text"/>	1,547	1,711	1,883	2,054
	RIGHT	15 3/4	18	39 1/16	<b>GS2STF1H18R-</b> <input type="text"/>	1,547	1,711	1,883	2,054
<b>30" WIDTH</b>									
 2 doors		15 3/4	30	39 1/16	<b>GS2STF1H30-</b> <input type="text"/>	2,504	2,769	3,046	3,323
<b>36" WIDTH</b>									
 2 doors		15 3/4	36	39 1/16	<b>GS2STF1H36-</b> <input type="text"/>	2,818	3,119	3,431	3,743

**PRODUCT INFO**

All units have a finished back.  
If integral pull is chosen for wood, doors will be touch latch.

**TO ORDER PLEASE SPECIFY THE FOLLOWING:**





- |                               |                             |
|-------------------------------|-----------------------------|
| WOOD CHASSIS, WOOD DOOR       | LAM CHASSIS, LAM DOOR       |
| 1. <b>MODEL NUMBER + WW</b>   | 1. <b>MODEL NUMBER + LL</b> |
| 2. <b>FSC</b>                 | 2. <b>FSC</b>               |
| 3. <b>CHASSIS WOOD FINISH</b> | 3. <b>CHASSIS LAM</b>       |
| 4. <b>PULLS</b>               | 4. <b>FRONT LAM</b>         |
| 5. <b>LOCKS</b>               | 5. <b>PULLS</b>             |
| 6. <b>KEYING</b>              | 6. <b>LOCKS</b>             |
|                               | 7. <b>KEYING</b>            |

# SURFACE MOUNT TOWERS

w/ Hinged Glass Doors | 1H

Silea

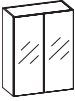
02/24

	D	W	H	model number + type	veneer 1	veneer 2	veneer 3	
<b>15" WIDTH</b>								
 1 door	LEFT	15 3/4	15	39 1/16	<b>GS2STF1H15L-</b> [ ]	1,673	1,841	2,008
	RIGHT	15 3/4	15	39 1/16	<b>GS2STF1H15R-</b> [ ]	1,673	1,841	2,008
<b>18" WIDTH</b>								
 1 door	LEFT	15 3/4	18	39 1/16	<b>GS2STF1H18L-</b> [ ]	2,092	2,302	2,511
	RIGHT	15 3/4	18	39 1/16	<b>GS2STF1H18R-</b> [ ]	2,092	2,302	2,511
<b>30" WIDTH</b>								
 2 doors		15 3/4	30	39 1/16	<b>GS2STF1H30-</b> [ ]	3,386	3,725	4,064
<b>36" WIDTH</b>								
 2 doors		15 3/4	36	39 1/16	<b>GS2STF1H36-</b> [ ]	3,811	4,193	4,574





## PRODUCT INFO

All units have a finished back.  
 Door frames match glass color.  
 Glass doors do not lock and are touch latch.

## TO ORDER PLEASE SPECIFY THE FOLLOWING:

WOOD CHASSIS, GLASS DOOR

1. **MODEL NUMBER + WG**
2. **FSC**
3. **CHASSIS WOOD FINISH**
4. **GLASS**

	D	W	H	model number + type	laminata	veneer 1	veneer 2	veneer 3
<b>15" WIDTH</b> 	14 7/8	15	39 1/16	<b>GS2STN1H15-</b> [ ]	1,102	1,220	1,342	1,464
<b>18" WIDTH</b> 	14 7/8	18	39 1/16	<b>GS2STN1H18-</b> [ ]	1,376	1,522	1,675	1,827
<b>30" WIDTH</b> 	14 7/8	30	39 1/16	<b>GS2STN1H30-</b> [ ]	2,248	2,486	2,735	2,984
<b>36" WIDTH</b> 	14 7/8	36	39 1/16	<b>GS2STN1H36-</b> [ ]	2,528	2,799	3,079	3,359

**PRODUCT INFO**

All units have a finished back.

**TO ORDER PLEASE SPECIFY THE FOLLOWING:**

WOOD CHASSIS

1. **MODEL NUMBER + WN**
2. **FSC**
3. **CHASSIS WOOD FINISH**

LAM CHASSIS



1. **MODEL NUMBER + LN**
2. **FSC**
3. **CHASSIS LAM**

# SURFACE MOUNT TOWERS

w/ Hinged Doors | 2H

Silea

02/24

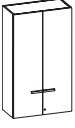
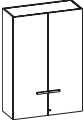
	D	W	H	model number + type	laminata	veneer 1	veneer 2	veneer 3	
<b>15" WIDTH</b>									
 1 door	LEFT	15 3/4	15	52 7/16	<b>GS2STF2H15L-</b> [ ]	2,094	2,319	2,551	2,783
	RIGHT	15 3/4	15	52 7/16	<b>GS2STF2H15R-</b> [ ]	2,094	2,319	2,551	2,783
<b>18" WIDTH</b>									
 1 door	LEFT	15 3/4	18	52 7/16	<b>GS2STF2H18L-</b> [ ]	2,618	2,898	3,188	3,478
	RIGHT	15 3/4	18	52 7/16	<b>GS2STF2H18R-</b> [ ]	2,618	2,898	3,188	3,478
<b>30" WIDTH</b>									
 2 doors		15 3/4	30	52 7/16	<b>GS2STF2H30-</b> [ ]	2,881	3,190	3,509	3,828
<b>36" WIDTH</b>									
 2 doors		15 3/4	36	52 7/16	<b>GS2STF2H36-</b> [ ]	3,222	3,568	3,925	4,282

• Not for use w/ credenza trough top.

## PRODUCT INFO

Type must be specified as part  
All units have a finished back.  
If integral pull is chosen for  
wood, doors will be touch  
latch.

## TO ORDER PLEASE SPECIFY THE FOLLOWING:

WOOD CHASSIS, WOOD DOOR

1. **MODEL NUMBER + WW**
2. **FSC**
3. **CHASSIS WOOD FINISH**
4. **PULLS**
5. **LOCKS**
6. **KEYING**

LAM CHASSIS, LAM DOOR

1. **MODEL NUMBER + LL**
2. **FSC**
3. **CHASSIS LAM**
4. **FRONT LAM**
5. **PULLS**
6. **LOCKS**
7. **KEYING**

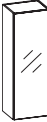
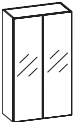
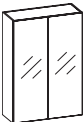
	D	W	H	model number + type	veneer 1	veneer 2	veneer 3
<b>15" WIDTH</b>							
 1 door				LEFT 15 3/4 15 52 7/16 <b>GS2STF2H15L-</b> [ ]	2,830	3,113	3,396
				RIGHT 15 3/4 15 52 7/16 <b>GS2STF2H15R-</b> [ ]	2,830	3,113	3,396
<b>18" WIDTH</b>							
 1 door				LEFT 15 3/4 18 52 7/16 <b>GS2STF2H18L-</b> [ ]	3,540	3,894	4,248
				RIGHT 15 3/4 18 52 7/16 <b>GS2STF2H18R-</b> [ ]	3,540	3,894	4,248
<b>30" WIDTH</b>							
 2 doors	15 3/4	30	52 7/16	<b>GS2STF2H30-</b> [ ]	3,898	4,288	4,678
<b>36" WIDTH</b>							
 2 doors	15 3/4	36	52 7/16	<b>GS2STF2H36-</b> [ ]	4,361	4,798	5,234

• Not for use w/ credenza trough top.

**PRODUCT INFO**

All units have a finished back.  
Door frames match glass color.  
Glass doors do not lock and are touch latch.

**TO ORDER PLEASE SPECIFY THE FOLLOWING:**

WOOD CHASSIS, GLASS DOOR



1. **MODEL NUMBER + WG**
2. **FSC**
3. **CHASSIS WOOD FINISH**
4. **GLASS**

# SURFACE MOUNT TOWERS

w/ No Doors, 2H

Silea

02/24

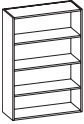
	D	W	H	model number + type	laminata	veneer 1	veneer 2	veneer 3
<b>15" WIDTH</b> 	14 7/8	15	52 7/16	<b>GS2STN2H15-</b> [ ]	1,138	1,262	1,389	1,515
<b>18" WIDTH</b> 	14 7/8	18	52 7/16	<b>GS2STN2H18-</b> [ ]	1,426	1,575	1,733	1,890
<b>30" WIDTH</b> 	14 7/8	30	52 7/16	<b>GS2STN2H30-</b> [ ]	2,497	2,765	3,042	3,318
<b>36" WIDTH</b> 	14 7/8	36	52 7/16	<b>GS2STN2H36-</b> [ ]	2,787	3,085	3,394	3,702

• Not for use w/ credenza trough top.

## PRODUCT INFO

All units have a finished back.

## TO ORDER PLEASE SPECIFY THE FOLLOWING:

### WOOD CHASSIS

- MODEL NUMBER + WN**
- FSC**
- CHASSIS WOOD FINISH**

### LAM CHASSIS

- MODEL NUMBER + LN**
- FSC**
- CHASSIS LAM**



fabric grades

COM/4



D	W	H	yards	model number	1	2	3	COM/4
7/8	58	23 7/8	1.00	<b>GS2TKS60</b>	997	1,044	1,093	1,143
7/8	64	23 7/8	1.00	<b>GS2TKS66</b>	1,013	1,060	1,109	1,159
7/8	70	23 7/8	1.25	<b>GS2TKS72</b>	1,054	1,107	1,163	1,219
7/8	76	23 7/8	1.25	<b>GS2TKS78</b>	1,082	1,140	1,203	1,266
7/8	82	23 7/8	1.25	<b>GS2TKS84</b>	1,113	1,171	1,234	1,297
7/8	88	23 7/8	1.50	<b>GS2TKS90</b>	1,164	1,228	1,296	1,363
7/8	94	23 7/8	1.50	<b>GS2TKS96</b>	1,212	1,283	1,357	1,432
7/8	100	23 7/8	1.75	<b>GS2TKS102</b>	1,672	1,747	1,829	1,911
7/8	106	23 7/8	1.75	<b>GS2TKS108</b>	1,733	1,815	1,902	1,990

**PRODUCT INFO**

102" and 108" wide tackboards are 2 piece.

For use with 1H and 2H surface mount cabinets.

See yards listed above for COM fabric requirements.

**TO ORDER PLEASE SPECIFY THE FOLLOWING:**

LIST

1. **MODEL NUMBER**
2. **FABRIC**
3. **FSC TACKBOARDS**

**FSC Tackboard Options**

**FSC** = FSC Required (5% COM upcharge)

**NR** = FSC Not Required

# SURFACE MOUNT EXTERNAL TOPS

For Units Without Doors

Silea

02/24

D	W	H	model number	laminate	veneer 1	veneer 2	veneer 3
14 7/8	30	1 3/16	<b>GS2SMTOPN30-</b> <input type="checkbox"/>	414	954	1,050	1,145
14 7/8	36	1 3/16	<b>GS2SMTOPN36-</b> <input type="checkbox"/>	469	639	703	767
14 7/8	60	1 3/16	<b>GS2SMTOPN60-</b> <input type="checkbox"/>	705	963	1,060	1,156
14 7/8	72	1 3/16	<b>GS2SMTOPN72-</b> <input type="checkbox"/>	810	1,106	1,217	1,328
14 7/8	90	1 3/16	<b>GS2SMTOPN90-</b> <input type="checkbox"/>	972	1,325	1,458	1,590
14 7/8	108	1 3/16	<b>GS2SMTOPN108-</b> <input type="checkbox"/>	1,131	1,543	1,698	1,852

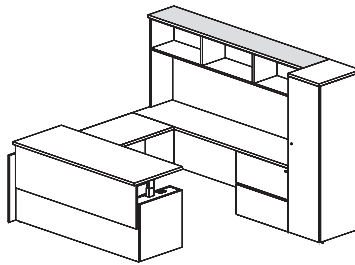

## PRODUCT INFO

### TO ORDER PLEASE SPECIFY THE FOLLOWING:

#### WOOD TOP

1. **MODEL NUMBER + W**
2. **FSC**
3. **TOP WOOD FINISH + EDGE**
4. **TOP FINISH**

#### Top Finish Option:

Non-UV Open Pore Finish

Full Fill Top Finish

**NR**

**FF (+\$282)**

#### LAM TOP

1. **MODEL NUMBER + L**
2. **FSC**
3. **TOP LAM**

Workwall . . . . .	317-322
Workwalls. . . . .	318-319
Workwall Tackboard . . . . .	320
Lounge Level Media Unit . . . . .	321-322

# WORKWALL

Wall Mount

Silea

02/24

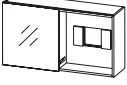
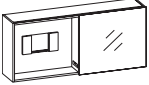
	D	W	H	model number + type	veneer 1	veneer 2	veneer 3
<b>72" WIDTH</b>  Left hand shown	19 1/2	72	39 1/16	<b>GS2WSB3H72L-</b> [ ]	10,815	11,897	12,978
	19 1/2	72	39 1/16	<b>GS2WSB3H72R-</b> [ ]	10,815	11,897	12,978
<b>90" WIDTH</b>  Right hand shown	19 1/2	90	39 1/16	<b>GS2WSB3H90L-</b> [ ]	12,491	13,741	14,990
	19 1/2	90	39 1/16	<b>GS2WSB3H90R-</b> [ ]	12,491	13,741	14,990

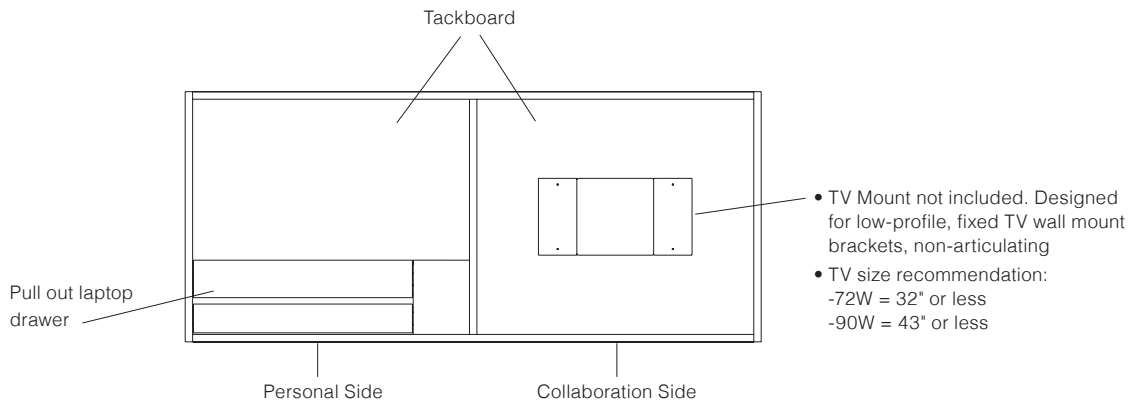

• Shown above with door removed.

## PRODUCT INFO

Must order tackboard separately.  
 2 power units included.  
 Sliding glass door frame matches glass color.  
 Whiteboard sliding door is non-magnetic.

## TO ORDER PLEASE SPECIFY THE FOLLOWING:

WOOD CHASSIS, GLASS DOOR

- MODEL NUMBER + WSG**
- FSC**
- CHASSIS WOOD FINISH**
- GLASS**
- DRAWERS**
- POWER UNIT COLOR**

	D	W	H	model number + type	veneer 1	veneer 2	veneer 3
<b>90" WIDTH</b>	23 3/4	90	76	<b>GS2FBX75H90L-</b> [ ]	21,298	23,428	25,558
	23 3/4	90	76	<b>GS2FBX75H90R-</b> [ ]	21,298	23,428	25,558

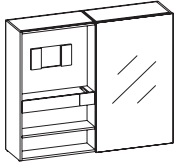

Right hand shown

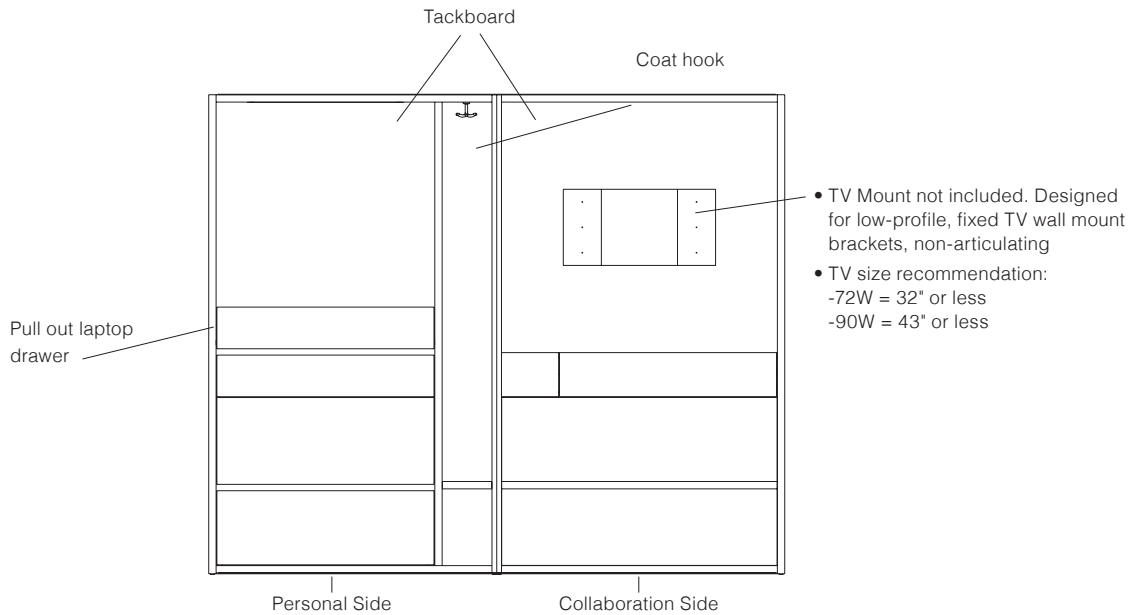

• 90" wide, shown above with door removed. 72" W does not have a closet.

**PRODUCT INFO**

Must order tackboard separately.  
2 power units included.  
Sliding glass door frame matches glass color.  
Back panel optional.  
Whiteboard sliding door is non-magnetic.

**TO ORDER PLEASE SPECIFY THE FOLLOWING:**

WOOD CHASSIS, GLASS DOOR

1. **MODEL NUMBER + WSG**
2. **FSC**
3. **CHASSIS WOOD FINISH**
4. **GLASS**
5. **BACK PANEL**
6. **DRAWERS**
7. **POWER UNIT COLOR**



D	W	H	yds	model number	fabric grades			COM/4
					1	2	3	
7/8	33 1/2	36 1/2	2.25	<b>GS2TKWSB72</b>	1,107	1,162	1,223	1,280
7/8	42 1/2	36 1/2	2.75	<b>GS2TKWSB90</b>	1,222	1,289	1,363	1,432
<ul style="list-style-type: none"> <li>• For use with Wall Mounted Workwalls, 2 pc</li> </ul>								
7/8	33 1/2	36 1/2	1.25	<b>GS2TKWSB36</b>	898	928	962	995
7/8	42 1/2	36 1/2	1.50	<b>GS2TKWSB45</b>	942	986	1,034	1,079
<ul style="list-style-type: none"> <li>• For use with Stack On Workwalls, 1 pc (Personal Side only)</li> </ul>								
7/8	33 1/2	36 1/2	2.25	<b>GS2TKFBX72</b>	1,107	1,162	1,223	1,280
7/8	42 1/2	36 1/2	2.50	<b>GS2TKFBX90</b>	1,222	1,289	1,363	1,432
<ul style="list-style-type: none"> <li>• For use with Freestanding Workwalls, 2 pc</li> </ul>								

**PRODUCT INFO**

102" and 108" wide tackboards are 2 piece.

**TO ORDER PLEASE SPECIFY THE FOLLOWING:**

LIST

1. **MODEL NUMBER**
2. **FABRIC**
3. **FSC TACKBOARDS**

**FSC Tackboard Options**

**FSC** = FSC Required (5% COM upcharge)  
**NR** = FSC Not Required

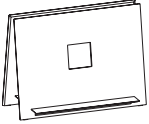
	D	W	H	model number + type	veneer 1	veneer 2	veneer 3
	30 1/4	66	49 1/2	<b>GLLM48H66-WW</b>	7,539	8,293	9,047

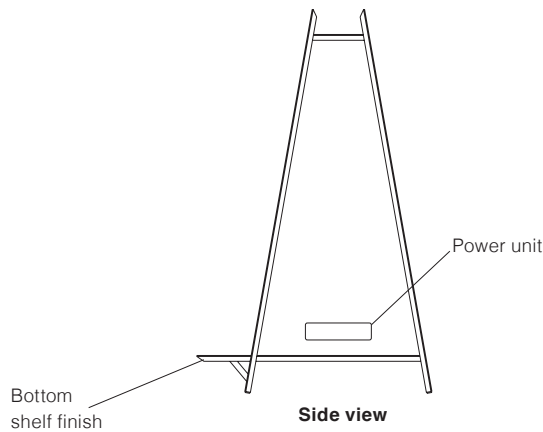

**PRODUCT INFO**

Wood models only.  
 Bottom shelf can match chassis color, or be Ebony Walnut.  
 2 power units included.  
 TV mount not included.  
 Designed for low-profile, fixed TV wall mount brackets, non-articulating. TV size recommendation is 66" or less.

**TO ORDER PLEASE SPECIFY THE FOLLOWING:**

WOOD

1. **MODEL NUMBER + WW**
2. **FSC**
3. **CHASSIS WOOD FINISH**
4. **BOTTOM SHELF FINISH**
5. **POWER UNIT COLOR**

# LOUNGE LEVEL MEDIA UNIT

Whiteboard

Silea  
02/24

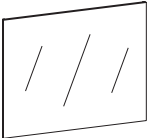
	D	W	H	model number	list
	1/2	58	36	<b>GLLMTGW36H58W-GSA</b>	3,643

## PRODUCT INFO

Whiteboard frame matches  
glass color.

Whiteboard is magnetic.

## TO ORDER PLEASE SPECIFY THE FOLLOWING:

LIST

1. **MODEL NUMBER**
2. **GLASS COLOR**



Accessories . . . . .	323-338
LED Tasklighting . . . . .	324
Trough Accessories . . . . .	325-326
Personal Corner . . . . .	327
Drawer Filing Rails & Reinforcement Bars . . . . .	328
Magnets . . . . .	329
Counterweights . . . . .	330
Wire Manager . . . . .	331
Center Drawer . . . . .	332
Pencil Tray . . . . .	333
Grommet . . . . .	334
Power Unit . . . . .	335-337
3" Dia Field Installed Grommet . . . . .	338
Grade Fabric Pricing . . . . .	340-343
Weights + Cubes . . . . .	344-382

	D	W	H	model number	lum
	3/4	23	5/8	<b>ACTLED24</b>	509
	3/4	35	5/8	<b>ACTLED36</b>	552
	3/4	47	5/8	<b>ACTLED48</b>	595
	3/4	59	5/8	<b>ACTLED60</b>	636

**Product Specifications:**

LED lighting provides high efficiency, low energy lighting with a long life. All LED lights are encased in a silver aluminum extrusion and include a built-in switch to turn the light on/off with a dimming feature. Lights are field installed. All units include a standard plug.

- Low profile strip light 5/8" H x 3/4" D
- Power: 2.92W / Foot
- LED's per meter: 120
- Color Temp: 3000K
- Certification: UL Listed
- GSA and TAA compliant

Size	Voltage	Wattage (W)	Luminous Flux (Lm)
24"	12 Volt DC	5.9	497
36"	12 Volt DC	8.8	746
48"	12 Volt DC	11.8	994
60"	12 Volt DC	14.6	1242





**PRODUCT INFO**

See product specs above.

**TO ORDER PLEASE SPECIFY THE FOLLOWING:**

LIST

- 1. MODEL NUMBER**

	D	W	H	model number	part #
<b>PAPER TRAY</b> 	12	8 1/2	6	<b>GS2AT-PAPER</b>	196
<b>PDA HOLDER</b> 	6	3	6	<b>GS2AT-PDA</b>	155
<p>• Note: Includes black non-slip surface to hold device on angled surface.</p>					
<b>PENCIL TRAY</b> 	5	8	5	<b>GS2AT-PNCL</b>	155
<b>PLUG HOLDER</b> 	1	4	3	<b>GS2AT-PLUG</b>	155
<b>SHELF</b> 	6	8	6	<b>GS2AT-SHELF</b>	196

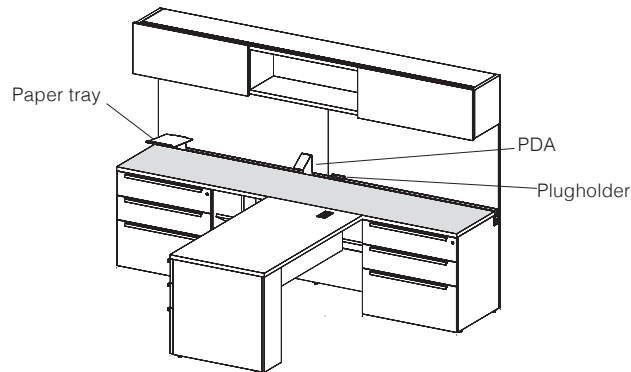

**PRODUCT INFO**

To be used with trough worksurface.  
Available in 5 metal finish colors.

**TO ORDER PLEASE SPECIFY THE FOLLOWING:**

LIST

1. **MODEL NUMBER**
2. **HARDWARE COLOR**

# TROUGH ACCESSORIES

Power Unit

Silea

02/24

	D	W	H	model number	sin#
	1 3/4	3	1 3/4	<b>ACPWRT</b> ( <i>De-emphasized</i> )	758

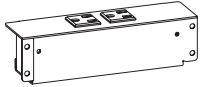

End of unit

- Includes 3 power outlets - 2 power outlets on top surface and 1 power outlet on end of unit.
- Ships with 6 ft power cord with standard plug
- UL listed
- Mounting bracket included for use installation in the following applications:
  - To bottom of worksurface beneath grommets
  - To bottom of worksurface in trough opening of trough worksurfaces
  - As power strip inside wall access panels or beneath desks

## PRODUCT INFO

To be mounted in trough opening.

## TO ORDER PLEASE SPECIFY THE FOLLOWING:

LIST

1. **MODEL NUMBER**

	D	W	H	model number	
	12 1/2	36	1 11/16	<b>SACORNER</b>	974

	18	36	1 11/16	<b>SADSKPAD</b>	1,379
---	----	----	---------	-----------------	-------

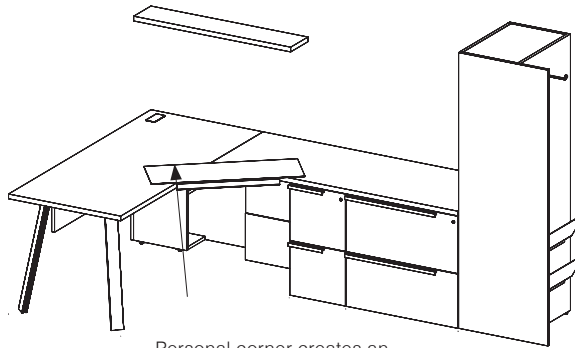

Personal corner creates an ergonomic corner to work.

**PRODUCT INFO**

**LEATHER COLORS**

Black **CBL**  
 White **CWH**  
 Chocolate **CCH**

**VINYL COLORS**

Black **VBL**  
 White **VWH**  
 Chocolate **VCH**







**TO ORDER PLEASE SPECIFY THE FOLLOWING:**

LIST

1. **MODEL NUMBER**
2. **COLOR**

# DRAWER FILING RAILS & REINFORCEMENT BARS

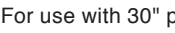
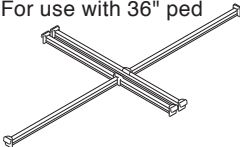
Silea  
02/24

	D	W	H	model number	$\frac{1}{8}$
For use with smart pedestals 	$\frac{1}{8}$	5	1	<b>ACFLR5-P</b>	32
For use with 9" ped 	$\frac{1}{8}$	9	1	<b>ACFLR9-P</b>	36
For use with 15" ped 	$\frac{1}{8}$	15	1	<b>ACFLR15-P</b>	41
For use with 18" ped 	$\frac{1}{8}$	18	1	<b>ACFLR18-P</b>	43
For use with 30" ped 	$\frac{1}{8}$	18	1	<b>ACFLR30-P</b>	47
For use with 36" ped 	$\frac{1}{8}$	18	1	<b>ACFLR36-P</b>	52
Optional Lateral File Drawer Reinforcement Bar 	$1 \frac{1}{2}$	$1 \frac{9}{16}$	15	<b>ACDRB-LAT</b>	68

• **Note:** Lateral file drawer reinforcement bars are OPTIONAL, and are only required when excessive stacking of paper occurs in bottom of drawers. Reinforcement bars are oriented front-to-back on file drawers and front-to-back on lateral file drawers.

## PRODUCT INFO

## TO ORDER PLEASE SPECIFY THE FOLLOWING:

LIST

### 1. MODEL NUMBER

	Dia	H	model number	list
	$\frac{3}{8}$	$\frac{1}{2}$	<b>SAMAGNET</b>	102

**QUANTITY 6**

**Note:** Quantity 6 magnets included with each whiteboard 72" W and less.  
Quantity 12 magnets included with each whiteboard 84"W and greater.

**PRODUCT INFO**

Magnets are silver.

**TO ORDER PLEASE SPECIFY THE FOLLOWING:**

LIST

- 1. MODEL NUMBER**

D	W	H	model number	list
$\frac{3}{16}$	12	15	<b>ACCNTRWGT15</b>	299
$\frac{1}{2}$	$8 \frac{5}{8}$	25	<b>ACCNTRWGT30</b>	336
$\frac{1}{2}$	$8 \frac{5}{8}$	28	<b>ACCNTRWGT36</b>	373

- For use when a 15" or 18" modular pedestal with drawers is used as a freestanding unit.

- For use when a 30" or 36" modular pedestal with drawers has a top and is a freestanding unit.

Examples:

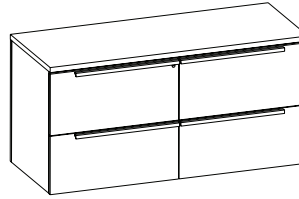
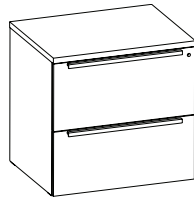

## PRODUCT INFO

TO ORDER PLEASE SPECIFY THE FOLLOWING:

LIST

1. **MODEL NUMBER**



	Dia	H	model number	sin
<b>WIRE MANAGER</b>	3 1/2	30	1 <b>ACWM</b>	115

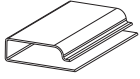

**PRODUCT INFO**

TO ORDER PLEASE SPECIFY THE FOLLOWING:

LIST

1. **MODEL NUMBER**

# CENTER DRAWER

Silea  
02/24

	D	W	H	model number + type	veneer 1	veneer 2	veneer 3
<b>CENTER DRAWER</b>	17 <sup>5</sup> / <sub>8</sub>	21 <sup>3</sup> / <sub>4</sub>	2 <sup>15</sup> / <sub>16</sub>	<b>GS2CDWSD-</b> <input type="checkbox"/>	716	788	860



**INTERIOR DIMENSIONS**

D = 15 <sup>1</sup>/<sub>2</sub>  
 W = 18 <sup>1</sup>/<sub>4</sub>  
 H = 1 <sup>3</sup>/<sub>8</sub>

- Note: Not available with a laminate drawer front.

**PRODUCT INFO**

Includes pencil tray.

**TO ORDER PLEASE SPECIFY THE FOLLOWING:**

WOOD

- 1. MODEL NUMBER + W**
- 2. CHASSIS WOOD FINISH**

	Dia	W	H	model number	sin
<b>PENCIL TRAYS</b> 	3	11 5/16	1 1/4	<b>ACPT15-GAA</b>	117
	3	14 5/16	1 1/4	<b>ACPT18-GAA</b>	124

**PRODUCT INFO**

TO ORDER PLEASE SPECIFY THE FOLLOWING:

LIST

- 1. MODEL NUMBER**

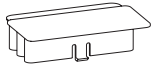

D	W	H	model number	list
2 1/2	5	1	<b>GS2GMT</b>	178

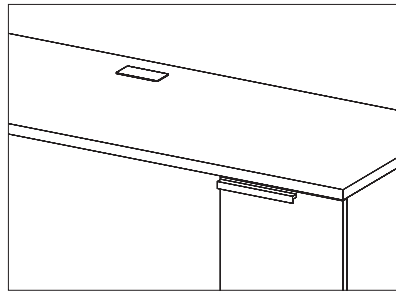

Closed

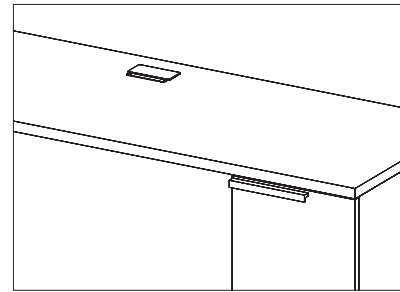

Small opening for cords

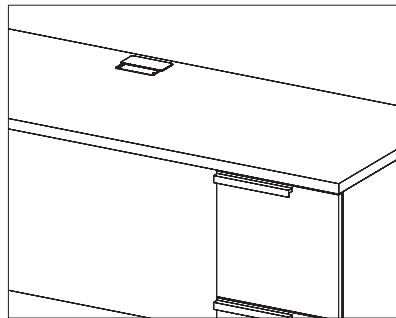

Large opening for monitor arms

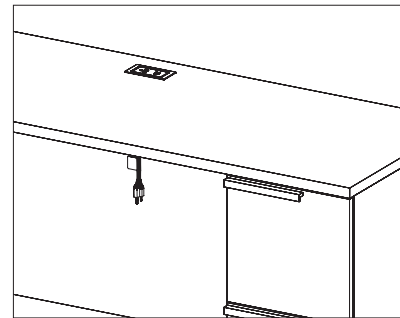

Grommet can be switched for ACUNOBZL-EU and ACUNOBZL-EU-HW power units

## PRODUCT INFO

Available in 5 metal finish colors.  
Do not place grommets over laptop drawer.

## TO ORDER PLEASE SPECIFY THE FOLLOWING:

LIST

1. **MODEL NUMBER**
2. **HARDWARE COLOR**

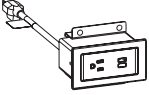
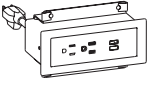
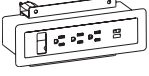
	D	W	H	model number	part
 <p>Can be used in grommet cutout</p>	2 7/8	4	1 3/4	<b>ACUNOBZL-EU</b>	444
	<ul style="list-style-type: none"> <li>Includes 1 power, 2 USB - standard plug</li> </ul>				
	2 7/8	4	1 3/4	<b>ACUNOBZL-EU-HW</b>	444
<ul style="list-style-type: none"> <li>Includes 1 power, 2 USB - hardwired</li> </ul>					
	2 7/8	5 1/2	1 3/4	<b>ACDUOBZL-EEU</b>	527
	<ul style="list-style-type: none"> <li>Includes 2 USB, 2 power - standard plug</li> </ul>				
	2 7/8	5 1/2	1 3/4	<b>ACDUOBZL-EEU-HW</b>	527
<ul style="list-style-type: none"> <li>Includes 2 USB, 2 power - hardwired</li> </ul>					
	2 7/8	8 1/16	1 3/4	<b>ACTRIOBZL-EEEUD</b>	606
	<ul style="list-style-type: none"> <li>Includes 2 USB, 3 power, 1 data - standard plug</li> </ul>				
	2 7/8	8 1/16	1 3/4	<b>ACTRIOBZL-EEEUD-HW</b>	606
<ul style="list-style-type: none"> <li>Includes 2 USB, 3 power, 1 data - hardwired</li> </ul>					

Data Port Kit included where applicable.

Insert options include:

- VGA
- Sieman
- Mini-com
- Commscope
- Ortronics
- Blank
- Cable retainer
- Belden EZ MDVO
- Keystone

**PRODUCT INFO**

ACUNOBZL-EU and ACUNOBZL-EU-HW models can be used in grommet cutout location.

10' standard plug or 6' hardwire power source.

**TO ORDER PLEASE SPECIFY THE FOLLOWING:**



LIST

- 1. MODEL NUMBER**
- 2. POWER UNIT COLOR**

# POWER UNIT

Clamp mount

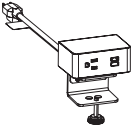
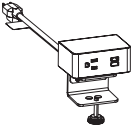
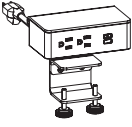
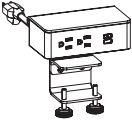
Silea  
02/24

	D	W	H	model number	part
	2 7/8	4	1 3/4	<b>ACUNOCLMP-EU</b>	444
	<ul style="list-style-type: none"> <li>Includes 1 power, 2 USB - standard plug</li> </ul>				
	2 7/8	4	1 3/4	<b>ACUNOCLMP-EU-HW</b>	444
	<ul style="list-style-type: none"> <li>Includes 1 power, 2 USB - hardwired</li> </ul>				
	2 7/8	5 1/2	1 3/4	<b>ACDUOCLMP-EEU</b>	527
	<ul style="list-style-type: none"> <li>Includes 2 USB, 2 power - standard plug</li> </ul>				
	2 7/8	5 1/2	1 3/4	<b>ACDUOCLMP-EEU-HW</b>	527
	<ul style="list-style-type: none"> <li>Includes 2 USB, 2 power - hardwired</li> </ul>				
	2 7/8	8 1/16	1 3/4	<b>ACTRIOCLMP-EEEUD</b>	606
	<ul style="list-style-type: none"> <li>Includes 2 USB, 3 power, 1 data - standard plug</li> </ul>				
	2 7/8	8 1/16	1 3/4	<b>ACTRIOCLMP-EEEUD-HW</b>	606
	<ul style="list-style-type: none"> <li>Includes 2 USB, 3 power, 1 data - hardwired</li> </ul>				

Data Port Kit included where applicable.

Insert options include:

- VGA
- Sieman
- Mini-com
- Commscope
- Ortronios
- Blank
- Cable retainer
- Belden EZ MDVO
- Keystone

## PRODUCT INFO

To be mounted on edge of worksurfaces.





Not to be used on height adjustable credenzas, returns or bridges on back edge of top or in grommet.

10' standard plug or 6' hardwire power source.

## TO ORDER PLEASE SPECIFY THE FOLLOWING:

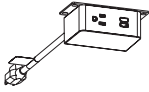
LIST

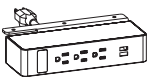
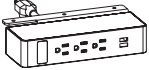
1. **MODEL NUMBER**
2. **POWER UNIT COLOR**

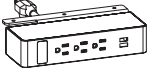
	D	W	H	model number	list
	2 7/8	4	1 3/4	<b>ACPUNDER-EU</b>	426
	<ul style="list-style-type: none"> <li>Includes 1 power, 2 USB - standard plug</li> </ul>				
	2 7/8	4	1 3/4	<b>ACPUNDER-EU-HW</b>	426
	<ul style="list-style-type: none"> <li>Includes 1 power, 2 USB - hardwired</li> </ul>				
	2 7/8	5 1/2	1 3/4	<b>GDAPPM-EEU</b>	514
	<ul style="list-style-type: none"> <li>Includes 2 USB, 2 power - standard plug</li> </ul>				
	2 7/8	5 1/2	1 3/4	<b>GDAPPM-EEU-HW</b>	514
	<ul style="list-style-type: none"> <li>Includes 2 USB, 2 power - hardwired</li> </ul>				
	2 7/8	8 1/16	1 3/4	<b>ACTRIOUNDER-EEEUD</b>	572
	<ul style="list-style-type: none"> <li>Includes 2 USB, 3 power, 1 data - standard plug</li> </ul>				
	2 7/8	8 1/16	1 3/4	<b>ACTRIOUNDER-EEEUD-HW</b>	572
	<ul style="list-style-type: none"> <li>Includes 2 USB, 3 power, 1 data - hardwired</li> </ul>				

Data Port Kit included where applicable.

Insert options include:

- VGA
- Sieman
- Mini-com
- Commscope
- Ortronics
- Blank
- Cable retainer
- Belden EZ MDVO
- Keystone

**PRODUCT INFO**

10' Standard plug or 6' hardwire power source.

**TO ORDER PLEASE SPECIFY THE FOLLOWING:**

LIST

1. **MODEL NUMBER**
2. **POWER UNIT COLOR**

# 3" DIA FIELD INSTALLED GROMMET

Silea  
02/24

	Dia	H	model number	list
<b>FIELD INSTALL GROMMET</b>	3	1	<b>ACGRMTFLD</b>	77

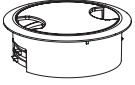

- 2 piece design - sleeve plus cover
- Fits standard 3" diameter cutout
- Plastic

## PRODUCT INFO

### TO ORDER PLEASE SPECIFY THE FOLLOWING:

#### LIST

- 1. MODEL NUMBER**
- 2. FIELD INSTALL GROMMET COLOR**
  - Black **BK**
  - Silver **SV**
  - White **WH**





# GRADE FABRIC PRICING

Silea  
02/24

model number	1	2	3	COM/4	5	6	7	8	9	10	11	12	13	14	15	16
--------------	---	---	---	-------	---	---	---	---	---	----	----	----	----	----	----	----

## Cushions

GS2MPD-CUSH2215	528	546	566	584	610	637	657	685	709	736	760	785	817	842	871	905
GS2CLPD-CUSH2130T	595	619	644	670	705	739	768	803	834	866	903	934	976	1,009	1,048	1,091
GS2CLPD-CUSH2136T	642	672	704	737	782	821	859	901	941	983	1,024	1,066	1,119	1,160	1,210	1,263

## Tackboards

GS2TKW30	817	839	865	890	923	958	983	1,015	1,047	1,079	1,113	1,144	1,184	1,216	1,252	1,295
GS2TKW36	856	885	916	949	988	1,029	1,065	1,106	1,145	1,184	1,226	1,263	1,315	1,355	1,403	1,454
GS2TKW42	887	917	948	982	1,024	1,066	1,102	1,144	1,185	1,226	1,269	1,310	1,364	1,404	1,453	1,507
GS2TKW48	918	949	982	1,015	1,061	1,104	1,141	1,184	1,227	1,268	1,313	1,356	1,411	1,453	1,504	1,560
GS2TKW54	952	985	1,017	1,053	1,098	1,143	1,183	1,230	1,274	1,316	1,359	1,404	1,460	1,505	1,559	1,617
GS2TKW60	997	1,044	1,093	1,143	1,208	1,275	1,329	1,396	1,457	1,524	1,589	1,652	1,731	1,795	1,874	1,952
GS2TKW66	1,013	1,060	1,109	1,159	1,224	1,291	1,345	1,412	1,473	1,540	1,605	1,668	1,747	1,811	1,890	1,968
GS2TKW72	1,054	1,107	1,163	1,219	1,293	1,365	1,430	1,503	1,573	1,646	1,719	1,788	1,883	1,952	2,037	2,132
GS2TKW78	1,082	1,140	1,203	1,266	1,348	1,431	1,501	1,584	1,661	1,745	1,826	1,904	2,005	2,084	2,183	2,285
GS2TKW84	1,113	1,171	1,234	1,297	1,379	1,462	1,532	1,615	1,692	1,776	1,857	1,935	2,036	2,115	2,214	2,316
GS2TKW90	1,164	1,228	1,296	1,363	1,456	1,545	1,623	1,715	1,798	1,892	1,979	2,066	2,179	2,265	2,371	2,482
GS2TKW96	1,212	1,283	1,357	1,432	1,529	1,629	1,713	1,810	1,903	2,000	2,099	2,193	2,315	2,407	2,525	2,646
GS2TKW102	1,672	1,747	1,829	1,911	2,018	2,122	2,213	2,319	2,422	2,526	2,632	2,734	2,865	2,966	3,093	3,227
GS2TKW108	1,733	1,815	1,902	1,990	2,105	2,218	2,318	2,435	2,543	2,659	2,773	2,883	3,023	3,134	3,271	3,412

## Layers Tackboards

GS2TLKW30	858	882	910	935	969	1,004	1,033	1,068	1,101	1,136	1,169	1,201	1,242	1,277	1,317	1,360
GS2TLKW36	898	928	962	995	1,040	1,079	1,118	1,160	1,202	1,244	1,287	1,327	1,381	1,424	1,474	1,527
GS2TLKW42	931	964	996	1,034	1,077	1,120	1,160	1,205	1,246	1,288	1,333	1,376	1,433	1,474	1,528	1,582
GS2TLKW48	963	996	1,030	1,068	1,112	1,157	1,198	1,245	1,289	1,333	1,378	1,422	1,482	1,525	1,580	1,637
GS2TLKW54	997	1,034	1,068	1,106	1,153	1,196	1,240	1,288	1,333	1,379	1,427	1,474	1,533	1,578	1,637	1,694
GS2TLKW60	1,046	1,095	1,147	1,200	1,268	1,337	1,395	1,465	1,529	1,599	1,667	1,732	1,816	1,881	1,965	2,050
GS2TLKW66	1,065	1,113	1,166	1,219	1,287	1,356	1,414	1,484	1,548	1,617	1,685	1,750	1,835	1,900	1,984	2,068
GS2TLKW72	1,107	1,162	1,223	1,280	1,359	1,434	1,501	1,579	1,652	1,728	1,805	1,877	1,974	2,050	2,142	2,238
GS2TLKW78	1,138	1,199	1,265	1,332	1,418	1,505	1,577	1,666	1,746	1,834	1,919	2,002	2,109	2,189	2,292	2,550
GS2TLKW84	1,169	1,230	1,296	1,363	1,449	1,536	1,608	1,697	1,777	1,865	1,950	2,033	2,140	2,220	2,323	2,581
GS2TLKW90	1,222	1,289	1,363	1,432	1,527	1,621	1,704	1,799	1,888	1,985	2,078	2,168	2,286	2,376	2,488	2,606
GS2TLKW96	1,271	1,345	1,424	1,502	1,604	1,706	1,798	1,900	1,999	2,101	2,204	2,301	2,429	2,527	2,651	2,777
GS2TLKW102	1,755	1,833	1,920	2,005	2,115	2,227	2,323	2,434	2,539	2,653	2,762	2,870	3,009	3,113	3,247	3,388
GS2TLKW108	1,820	1,906	1,997	2,089	2,210	2,329	2,434	2,555	2,671	2,791	2,911	3,027	3,175	3,289	3,433	3,582

## Tack to Top Overhead | 1H

GS2TKW1H30	1,025	1,047	1,073	1,098	1,131	1,166	1,191	1,223	1,255	1,287	1,321	1,352	1,392	1,424	1,460	1,503
GS2TKW1H36	1,044	1,073	1,104	1,137	1,176	1,217	1,253	1,294	1,333	1,372	1,414	1,451	1,503	1,543	1,591	1,642
GS2TKW1H42	1,084	1,121	1,157	1,194	1,244	1,294	1,338	1,387	1,433	1,483	1,533	1,580	1,641	1,687	1,747	1,805
GS2TKW1H48	1,118	1,155	1,191	1,228	1,278	1,328	1,372	1,421	1,467	1,517	1,567	1,614	1,675	1,721	1,781	1,839

model number      17    18    19    20    21    22    23    24    25    26    27    COL    L1    L2    L3    L4    L5

**Cushions**

GS2MPD-CUSH2215	935	957	988	1,019	1,048	1,079	1,141	1,199	1,262	1,324	1,383	584	775	981	1,188	1,394	1,579
GS2CLPD-CUSH2130T	1,131	1,161	1,202	1,239	1,280	1,319	1,401	1,478	1,563	1,642	1,721	670	925	1,199	1,474	1,749	1,996
GS2CLPD-CUSH2136T	1,312	1,350	1,400	1,448	1,498	1,548	1,649	1,750	1,850	1,952	2,051	737	1,053	1,397	1,739	2,086	2,396

**Tackboards**

GS2TKW30	1,335	1,363	1,400	1,438	1,478	1,515	1,595	1,670	1,749	1,824	1,902						
GS2TKW36	1,501	1,538	1,587	1,634	1,683	1,732	1,828	1,924	2,020	2,119	2,213						
GS2TKW42	1,555	1,592	1,641	1,691	1,741	1,791	1,893	1,993	2,093	2,195	2,293						
GS2TKW48	1,611	1,649	1,701	1,751	1,801	1,854	1,959	2,062	2,165	2,272	2,374						
GS2TKW54	1,668	1,707	1,762	1,816	1,868	1,922	2,031	2,136	2,242	2,353	2,457						
GS2TKW60	2,032	2,087	2,166	2,239	2,317	2,397	2,552	2,704	2,860	3,016	3,168						
GS2TKW66	2,048	2,103	2,182	2,255	2,333	2,413	2,568	2,720	2,876	3,032	3,184						
GS2TKW72	2,217	2,283	2,368	2,454	2,542	2,625	2,804	2,974	3,148	3,328	3,498						
GS2TKW78	2,382	2,450	2,549	2,643	2,741	2,840	3,034	3,225	3,420	3,616	3,806						
GS2TKW84	2,413	2,481	2,580	2,674	2,772	2,871	3,065	3,256	3,451	3,647	3,837						
GS2TKW90	2,590	2,668	2,776	2,878	2,986	3,094	3,308	3,517	3,733	3,950	4,161						
GS2TKW96	2,764	2,849	2,966	3,076	3,192	3,310	3,543	3,774	4,008	4,239	4,468						
GS2TKW102	3,352	3,445	3,571	3,692	3,817	3,946	4,198	4,445	4,699	4,953	5,200						
GS2TKW108	3,548	3,647	3,783	3,915	4,052	4,187	4,462	4,731	5,004	5,275	5,542						

**Layers Tackboards**

GS2TLKW30	1,401	1,431	1,471	1,510	1,553	1,591	1,673	1,755	1,837	1,918	1,998						
GS2TLKW36	1,577	1,614	1,665	1,713	1,765	1,815	1,920	2,020	2,120	2,225	2,324						
GS2TLKW42	1,635	1,674	1,727	1,777	1,830	1,882	1,991	2,094	2,198	2,306	2,409						
GS2TLKW48	1,692	1,731	1,785	1,840	1,894	1,945	2,058	2,167	2,273	2,384	2,490						
GS2TLKW54	1,750	1,792	1,849	1,901	1,962	2,015	2,132	2,240	2,357	2,467	2,580						
GS2TLKW60	2,131	2,190	2,275	2,352	2,433	2,514	2,680	2,839	3,002	3,166	3,326						
GS2TLKW66	2,150	2,209	2,292	2,371	2,450	2,533	2,698	2,857	3,020	3,182	3,345						
GS2TLKW72	2,326	2,396	2,487	2,575	2,668	2,759	2,945	3,123	3,308	3,493	3,673						
GS2TLKW78	2,502	2,574	2,678	2,777	2,879	2,982	3,187	3,388	3,591	3,799	3,997						
GS2TLKW84	2,533	2,605	2,709	2,808	2,910	3,013	3,218	3,419	3,622	3,830	4,028						
GS2TLKW90	2,718	2,800	2,914	3,021	3,134	3,246	3,473	3,694	3,922	4,147	4,366						
GS2TLKW96	2,901	2,989	3,111	3,228	3,352	3,474	3,720	3,960	4,205	4,449	4,692						
GS2TLKW102	3,518	3,616	3,748	3,875	4,006	4,141	4,408	4,666	4,933	5,201	5,460						
GS2TLKW108	3,727	3,831	3,974	4,111	4,254	4,398	4,687	4,967	5,252	5,540	5,819						

**Tack to Top Overhead I 1H**

GS2TKW1H30	1,543	1,571	1,608	1,646	1,686	1,723	1,803	1,878	1,957	2,032	2,110						
GS2TKW1H36	1,689	1,726	1,775	1,822	1,871	1,920	2,016	2,112	2,208	2,307	2,401						
GS2TKW1H42	1,865	1,910	1,966	2,022	2,084	2,140	2,259	2,373	2,490	2,606	2,723						
GS2TKW1H48	1,899	1,944	2,000	2,056	2,118	2,174	2,293	2,407	2,524	2,640	2,757						

# GRADE FABRIC PRICING

Silea  
02/24

model number	1	2	3	COM/4	5	6	7	8	9	10	11	12	13	14	15	16
<b>Tack to Top Overhead I 2H</b>																
GS2TKW2H30	1,044	1,066	1,092	1,117	1,150	1,185	1,210	1,242	1,274	1,306	1,340	1,371	1,411	1,443	1,479	1,522
GS2TKW2H36	1,084	1,113	1,144	1,177	1,216	1,257	1,293	1,334	1,373	1,412	1,454	1,491	1,543	1,583	1,631	1,682
GS2TKW2H42	1,118	1,155	1,191	1,228	1,278	1,328	1,372	1,421	1,467	1,517	1,567	1,614	1,675	1,721	1,781	1,839
GS2TKW2H48	1,146	1,183	1,219	1,256	1,306	1,356	1,400	1,449	1,495	1,545	1,595	1,642	1,703	1,749	1,809	1,867
<b>Layers Tack to Top Overhead I 1H</b>																
GS2TLKW1H30	1,044	1,066	1,092	1,117	1,150	1,185	1,210	1,242	1,274	1,306	1,340	1,371	1,411	1,443	1,479	1,522
GS2TLKW1H36	1,084	1,113	1,144	1,177	1,216	1,257	1,293	1,334	1,373	1,412	1,454	1,491	1,543	1,583	1,631	1,682
GS2TLKW1H42	1,118	1,155	1,191	1,228	1,278	1,328	1,372	1,421	1,467	1,517	1,567	1,614	1,675	1,721	1,781	1,839
GS2TLKW1H48	1,146	1,183	1,219	1,256	1,306	1,356	1,400	1,449	1,495	1,545	1,595	1,642	1,703	1,749	1,809	1,867
<b>Layers Tack to Top Overhead I 2H</b>																
GS2TLKW2H30	1,084	1,106	1,132	1,157	1,190	1,225	1,250	1,282	1,314	1,346	1,380	1,411	1,451	1,483	1,519	1,562
GS2TLKW2H36	1,118	1,147	1,178	1,211	1,250	1,291	1,327	1,368	1,407	1,446	1,488	1,525	1,577	1,617	1,665	1,716
GS2TLKW2H42	1,146	1,183	1,219	1,256	1,306	1,356	1,400	1,449	1,495	1,545	1,595	1,642	1,703	1,749	1,809	1,867
GS2TLKW2H48	1,197	1,234	1,270	1,307	1,357	1,407	1,451	1,500	1,546	1,596	1,646	1,693	1,754	1,800	1,860	1,918
<b>Surface Mount Tackboards</b>																
GS2TKS60	997	1,044	1,093	1,143	1,208	1,275	1,329	1,396	1,457	1,524	1,589	1,652	1,731	1,795	1,874	1,952
GS2TKS66	1,013	1,060	1,109	1,159	1,224	1,291	1,345	1,412	1,473	1,540	1,605	1,668	1,747	1,811	1,890	1,968
GS2TKS72	1,054	1,107	1,163	1,219	1,293	1,365	1,430	1,503	1,573	1,646	1,719	1,788	1,883	1,952	2,037	2,132
GS2TKS78	1,082	1,140	1,203	1,266	1,348	1,431	1,501	1,584	1,661	1,745	1,826	1,904	2,005	2,084	2,183	2,285
GS2TKS84	1,113	1,171	1,234	1,297	1,379	1,462	1,532	1,615	1,692	1,776	1,857	1,935	2,036	2,115	2,214	2,316
GS2TKS90	1,164	1,228	1,296	1,363	1,456	1,545	1,623	1,715	1,798	1,892	1,979	2,066	2,179	2,265	2,371	2,482
GS2TKS96	1,212	1,283	1,357	1,432	1,529	1,629	1,713	1,810	1,903	2,000	2,099	2,193	2,315	2,407	2,525	2,646
GS2TKS102	1,672	1,747	1,829	1,911	2,018	2,122	2,213	2,319	2,422	2,526	2,632	2,734	2,865	2,966	3,093	3,227
GS2TKS108	1,733	1,815	1,902	1,990	2,105	2,218	2,318	2,435	2,543	2,659	2,773	2,883	3,023	3,134	3,271	3,412
<b>WorkWall Tackboards</b>																
GS2TKWSB72	1,107	1,162	1,223	1,280	1,359	1,434	1,501	1,579	1,652	1,728	1,805	1,877	1,974	2,050	2,142	2,238
GS2TKWSB90	1,222	1,289	1,363	1,432	1,527	1,621	1,704	1,799	1,888	1,985	2,078	2,168	2,286	2,376	2,488	2,606
GS2TKWSB36	898	928	962	995	1,040	1,079	1,118	1,160	1,202	1,244	1,287	1,327	1,381	1,424	1,474	1,527
GS2TKWSB45	942	986	1,034	1,079	1,140	1,201	1,254	1,319	1,376	1,439	1,500	1,560	1,637	1,694	1,771	1,845
GS2TKFBX72	1,107	1,162	1,223	1,280	1,359	1,434	1,501	1,579	1,652	1,728	1,805	1,877	1,974	2,050	2,142	2,238
GS2TKFBX90	1,222	1,289	1,363	1,432	1,527	1,621	1,704	1,799	1,888	1,985	2,078	2,168	2,286	2,376	2,488	2,606

model number	17	18	19	20	21	22	23	24	25	26	27	COL	L1	L2	L3	L4	L5
--------------	----	----	----	----	----	----	----	----	----	----	----	-----	----	----	----	----	----

**Tack to Top Overhead I 2H**

GS2TKW2H30	1,562	1,590	1,627	1,665	1,705	1,742	1,822	1,897	1,976	2,051	2,129						
GS2TKW2H36	1,729	1,766	1,815	1,862	1,911	1,960	2,056	2,152	2,248	2,347	2,441						
GS2TKW2H42	1,899	1,944	2,000	2,056	2,118	2,174	2,293	2,407	2,524	2,640	2,757						
GS2TKW2H48	1,927	1,972	2,028	2,084	2,146	2,202	2,321	2,435	2,552	2,668	2,785						

**Layers Tack to Top Overhead I 1H**

GS2TLKW1H30	1,562	1,590	1,627	1,665	1,705	1,742	1,822	1,897	1,976	2,051	2,129						
GS2TLKW1H36	1,729	1,766	1,815	1,862	1,911	1,960	2,056	2,152	2,248	2,347	2,441						
GS2TLKW1H42	1,899	1,944	2,000	2,056	2,118	2,174	2,293	2,407	2,524	2,640	2,757						
GS2TLKW1H48	1,927	1,972	2,028	2,084	2,146	2,202	2,321	2,435	2,552	2,668	2,785						

**Layers Tack to Top Overhead I 2H**

GS2TLKW2H30	1,602	1,630	1,667	1,705	1,745	1,782	1,862	1,937	2,016	2,091	2,169						
GS2TLKW2H36	1,763	1,800	1,849	1,896	1,945	1,994	2,090	2,186	2,282	2,381	2,475						
GS2TLKW2H42	1,927	1,972	2,028	2,084	2,146	2,202	2,321	2,435	2,552	2,668	2,785						
GS2TLKW2H48	1,978	2,023	2,079	2,135	2,197	2,253	2,372	2,486	2,603	2,719	2,836						

**Surface Mount Tackboards**

GS2TKS60	2,032	2,087	2,166	2,239	2,317	2,397	2,552	2,704	2,860	3,016	3,168						
GS2TKS66	2,048	2,103	2,182	2,255	2,333	2,413	2,568	2,720	2,876	3,032	3,184						
GS2TKS72	2,217	2,283	2,368	2,454	2,542	2,625	2,804	2,974	3,148	3,328	3,498						
GS2TKS78	2,382	2,450	2,549	2,643	2,741	2,840	3,034	3,225	3,420	3,616	3,806						
GS2TKS84	2,413	2,481	2,580	2,674	2,772	2,871	3,065	3,256	3,451	3,647	3,837						
GS2TKS90	2,590	2,668	2,776	2,878	2,986	3,094	3,308	3,517	3,733	3,950	4,161						
GS2TKS96	2,764	2,849	2,966	3,076	3,192	3,310	3,543	3,774	4,008	4,239	4,468						
GS2TKS102	3,352	3,445	3,571	3,692	3,817	3,946	4,198	4,445	4,699	4,953	5,200						
GS2TKS108	3,548	3,647	3,783	3,915	4,052	4,187	4,462	4,731	5,004	5,275	5,542						

**WorkWall Tackboards**

GS2TKWSB72	2,326	2,396	2,487	2,575	2,668	2,759	2,945	3,123	3,308	3,493	3,673						
GS2TKWSB90	2,718	2,800	2,914	3,021	3,134	3,246	3,473	3,694	3,922	4,147	4,366						
GS2TKWSB36	1,577	1,614	1,665	1,713	1,765	1,815	1,920	2,020	2,120	2,225	2,324						
GS2TKWSB45	1,920	1,971	2,046	2,115	2,192	2,262	2,411	2,555	2,703	2,849	2,992						
GS2TKFBX72	2,326	2,396	2,487	2,575	2,668	2,759	2,945	3,123	3,308	3,493	3,673						
GS2TKFBX90	2,718	2,800	2,914	3,021	3,134	3,246	3,473	3,694	3,922	4,147	4,366						

# WEIGHTS + CUBES

Silea  
02/24

model number	weight	cubes	#locks	page
ACCNTRWGT15	20	0.5	-	330
ACCNTRWGT30	30	1.0	-	330
ACCNTRWGT36	35	1.0	-	330
ACDRB-LAT	2	0.5	-	328
ACDUOBZL-EEU	3	0.2	-	335
ACDUOBZL-EEU-HW	3	0.2	-	335
ACDUOCLMP-EEU	3	0.2	-	336
ACDUOCLMP-EEU-HW	3	0.2	-	336
ACFLR5-P	1	0.1	-	328
ACFLR9-P	1	0.1	-	328
ACFLR15-P	1	0.1	-	328
ACFLR18-P	1	0.2	-	328
ACFLR30-P	1	0.3	-	328
ACFLR36-P	1	0.3	-	328
ACGRMTFLD	1	0.1	-	338
ACHAT-BLUETOOTH	1	0.1	-	121
ACHAT-MEM	1	0.1	-	121
ACHAT-PDL	1	0.1	-	121
ACHAT-UD	1	0.1	-	121
ACMWS30	3	0.4	-	216
ACMWS36	4	0.5	-	216
ACMWS41	4	0.5	-	216
ACMWS47	5	0.6	-	216
ACMWS53	5	0.7	-	216
ACMWS59	6	0.7	-	216
ACMWS65	7	0.8	-	216
ACMWS71	7	0.9	-	216
ACMWS83	8	1.0	-	216
ACPHQ3QI-B	3	0.3	-	232
ACPHQ3QI-S	3	0.3	-	232
ACPT15-GAA	2	0.5	-	333
ACPT18-GAA	2	0.5	-	333
ACPUNDER-EU	2	0.2	-	337
ACPUNDER-EU-HW	2	0.2	-	337
ACPWRT	2	0.2	-	326
ACTLED24	2	0.1	-	324
ACTLED36	3	0.2	-	324
ACTLED48	4	0.3	-	324
ACTLED60	5	0.3	-	324
ACTRIOBZL-EEEUD	4	0.3	-	335
ACTRIOBZL-EEEUD-HW	4	0.3	-	335
ACTRIOCLMP-EEEUD	4	0.3	-	336
ACTRIOCLMP-EEEUD-HW	4	0.3	-	336
ACTRIOUNDER-EEEUD	4	0.3	-	337

model number	weight	cubes	#locks	page
ACTRIOUNDER-EEEUD-HW	4	0.3	-	337
ACUNOBZL-EU	2	0.2	-	232, 335
ACUNOBZL-EU-HW	2	0.2	-	232, 335
ACUNOCLMP-EU	2	0.2	-	336
ACUNOCLMP-EU-HW	2	0.2	-	336
ACWCB15	6	0.7	-	119, 217
ACWCB20	8	0.8	-	119, 217
ACWWM	2	0.1	-	331
BSHAT2142	53	5.4	-	117
BSHAT2148	55	6.3	-	117
BSHAT2154	57	7.1	-	117
BSHAT2160	59	7.9	-	117
BSHAT2166	61	8.8	-	117
BSHAT2172	63	9.6	-	117
BSHAT2748	59	7.8	-	117
BSHAT2754	61	8.9	-	117
BSHAT2760	63	9.9	-	117
BSHAT2766	65	10.9	-	117
BSHAT2772	67	12.0	-	117
GDAPPM-EEU	3	0.1	-	337
GDAPPM-EEU-HW	3	0.1	-	337
GLLM48H66-WW	225	69.7	-	321
GLLMTGW36H58W-GSA	59	4.8	-	322
GS2ALEG-A	8	0.6	-	157
GS2ASF830-A	10	0.8	-	300
GS2ASF830-L	7	0.3	-	300
GS2ASF830-W	8	0.8	-	300
GS2ASF836-A	12	1.0	-	300
GS2ASF836-L	9	0.3	-	300
GS2ASF836-W	10	1.0	-	300
GS2ASF842-A	14	1.1	-	300
GS2ASF842-L	11	1.1	-	300
GS2ASF842-W	11	1.1	-	300
GS2ASF848-A	15	1.3	-	300
GS2ASF848-L	12	1.3	-	300
GS2ASF848-W	12	1.3	-	300
GS2ASF854-A	17	1.4	-	300
GS2ASF854-L	14	1.4	-	300
GS2ASF854-W	14	1.4	-	300
GS2ASF860-A	19	1.6	-	300
GS2ASF860-L	15	0.5	-	300
GS2ASF860-W	16	1.6	-	300
GS2ASF866-A	21	1.7	-	300
GS2ASF866-L	16	0.6	-	300

model number	weight	cubes	#locks	page
GS2ASF866-W	17	1.7	-	300
GS2ASF872-A	23	1.9	-	300
GS2ASF872-L	18	0.7	-	300
GS2ASF872-W	19	1.9	-	300
GS2ASF878-A	25	2.0	-	300
GS2ASF878-L	19	0.7	-	300
GS2ASF878-W	20	2.0	-	300
GS2ASF884-A	27	1.1	-	300
GS2ASF884-L	21	0.8	-	300
GS2ASF884-W	22	1.1	-	300
GS2ASF890-A	29	1.2	-	300
GS2ASF890-L	22	0.8	-	300
GS2ASF890-W	24	1.2	-	300
GS2ASF896-A	31	1.3	-	300
GS2ASF896-L	24	0.9	-	300
GS2ASF896-W	26	1.3	-	300
GS2ASF1230-A	14	1.1	-	301
GS2ASF1230-L	10	0.3	-	301
GS2ASF1230-W	11	1.1	-	301
GS2ASF1236-A	16	1.3	-	301
GS2ASF1236-L	12	0.3	-	301
GS2ASF1236-W	13	1.3	-	301
GS2ASF1242-A	18	1.5	-	301
GS2ASF1242-L	15	1.5	-	301
GS2ASF1242-W	15	1.5	-	301
GS2ASF1248-A	21	1.7	-	301
GS2ASF1248-L	18	1.7	-	301
GS2ASF1248-W	18	1.7	-	301
GS2ASF1254-A	24	1.9	-	301
GS2ASF1254-L	20	1.9	-	301
GS2ASF1254-W	20	1.9	-	301
GS2ASF1260-A	27	2.1	-	301
GS2ASF1260-L	20	0.5	-	301
GS2ASF1260-W	22	2.1	-	301
GS2ASF1266-A	30	2.3	-	301
GS2ASF1266-L	22	0.6	-	301
GS2ASF1266-W	24	2.3	-	301
GS2ASF1272-A	33	2.5	-	301
GS2ASF1272-L	24	0.7	-	301
GS2ASF1272-W	26	2.5	-	301
GS2ASF1278-A	35	2.7	-	301
GS2ASF1278-L	26	0.7	-	301
GS2ASF1278-W	28	2.7	-	301
GS2ASF1284-A	38	1.5	-	301

model number	weight	cubes	#locks	page
GS2ASF1284-L	27	0.8	-	301
GS2ASF1284-W	31	1.5	-	301
GS2ASF1290-A	41	1.6	-	301
GS2ASF1290-L	29	0.8	-	301
GS2ASF1290-W	33	1.6	-	301
GS2ASF1296-A	44	1.7	-	301
GS2ASF1296-L	31	0.9	-	301
GS2ASF1296-W	35	1.7	-	301
GS2ASF8102-A	33	1.3	-	300
GS2ASF8102-L	25	0.5	-	300
GS2ASF8102-W	27	1.3	-	300
GS2ASF8108-A	35	1.4	-	300
GS2ASF8108-L	27	0.5	-	300
GS2ASF8108-W	28	1.4	-	300
GS2ASF8114-A	37	1.4	-	300
GS2ASF8114-L	30	2.9	-	300
GS2ASF8114-W	30	2.9	-	300
GS2ASF8120-A	39	1.6	-	300
GS2ASF8120-L	30	0.5	-	300
GS2ASF8120-W	32	1.6	-	300
GS2ASF8132-A	34	2.8	-	300
GS2ASF8132-L	34	2.8	-	300
GS2ASF8132-W	34	2.8	-	300
GS2ASF8144-A	38	3.0	-	300
GS2ASF8144-L	38	3.0	-	300
GS2ASF8144-W	38	3.0	-	300
GS2ASF12102-A	46	1.8	-	301
GS2ASF12102-L	33	0.5	-	301
GS2ASF12102-W	37	1.8	-	301
GS2ASF12108-A	49	1.9	-	301
GS2ASF12108-L	35	0.5	-	301
GS2ASF12108-W	39	1.9	-	301
GS2ASF12114-A	51	2.0	-	301
GS2ASF12114-L	41	3.9	-	301
GS2ASF12114-W	41	3.9	-	301
GS2ASF12120-A	54	2.1	-	301
GS2ASF12120-L	39	0.5	-	301
GS2ASF12120-W	44	2.1	-	301
GS2ASF12132-A	48	2.3	-	301
GS2ASF12132-L	48	2.3	-	301
GS2ASF12132-W	48	2.3	-	301
GS2ASF12144-A	52	2.5	-	301
GS2ASF12144-L	52	2.5	-	301
GS2ASF12144-W	52	2.5	-	301

# WEIGHTS + CUBES

Silea  
02/24

model number	weight	cubes	#locks	page
GS2AT-PAPER	2	0.9	-	325
GS2AT-PDA	1	0.3	-	325
GS2AT-PLUG	1	0.1	-	325
GS2AT-PNCL	1	0.4	-	325
GS2AT-SHELF	2	0.5	-	325
GS2BCL5H18L-LL	210	23.5	1	237
GS2BCL5H18L-WW	210	23.5	1	237
GS2BCL5H18R-LL	210	23.5	1	237
GS2BCL5H18R-WW	210	23.5	1	237
GS2BCL6H18L-LL	250	27.9	1	237
GS2BCL6H18L-WW	250	27.9	1	237
GS2BCL6H18R-LL	250	27.9	1	237
GS2BCL6H18R-WW	250	27.9	1	237
GS2BKN2H30N-LN	65	10.5	-	236
GS2BKN2H30N-WN	65	10.5	-	236
GS2BKN2H36N-LN	80	12.5	-	236
GS2BKN2H36N-WN	80	12.5	-	236
GS2BKN3H30-LN	100	14.7	-	236
GS2BKN3H30-WN	100	14.7	-	236
GS2BKN3H36-LN	115	18.2	-	236
GS2BKN3H36-WN	115	18.2	-	236
GS2BKN4H30-LN	127	18.6	-	236
GS2BKN4H30-WN	127	18.6	-	236
GS2BKN4H36-LN	142	23.2	-	236
GS2BKN4H36-WN	142	23.2	-	236
GS2BKN5H30-LN	152	23.2	-	236
GS2BKN5H30-WN	152	23.2	-	236
GS2BKN5H36-LN	167	28.9	-	236
GS2BKN5H36-WN	167	28.9	-	236
GS2BKN6H30-LN	213	27.6	-	236
GS2BKN6H30-WN	213	27.6	-	236
GS2BKN6H36-LN	228	34.3	-	236
GS2BKN6H36-WN	228	34.3	-	236
GS2BMA39-L	35	6.8	-	211
GS2BMA39-W	35	6.8	-	211
GS2BMA42-L	37	7.2	-	211
GS2BMA42-W	37	7.2	-	211
GS2BMA45-L	39	7.7	-	211
GS2BMA45-W	39	7.7	-	211
GS2BMA48-L	41	8.2	-	211
GS2BMA48-W	41	8.2	-	211
GS2BMA51-L	43	8.7	-	211
GS2BMA51-W	43	8.7	-	211
GS2BMA54-L	45	9.2	-	211

model number	weight	cubes	#locks	page
GS2BMA54-W	45	9.2	-	211
GS2BMA57-L	47	9.6	-	211
GS2BMA57-W	47	9.6	-	211
GS2BMA60-L	49	10.1	-	211
GS2BMA60-W	49	10.1	-	211
GS2BMF39-L	19	2.9	-	210
GS2BMF39-W	19	2.9	-	210
GS2BMF42-L	20	3.1	-	210
GS2BMF42-W	20	3.1	-	210
GS2BMF45-L	21	3.3	-	210
GS2BMF45-W	21	3.3	-	210
GS2BMF48-L	23	3.5	-	210
GS2BMF48-W	23	3.5	-	210
GS2BMF51-L	24	3.7	-	210
GS2BMF51-W	24	3.7	-	210
GS2BMF54-L	26	3.9	-	210
GS2BMF54-W	26	3.9	-	210
GS2BMF57-L	27	4.1	-	210
GS2BMF57-W	27	4.1	-	210
GS2BMF60-L	29	4.3	-	210
GS2BMF60-W	29	4.3	-	210
GS2CDWSD-W	2	13.0	-	332
GS2CLD5H30-DLL	286	36.9	1	241
GS2CLD5H30-DWW	286	36.9	1	241
GS2CLD5H30-SLL	265	36.9	1	241
GS2CLD5H30-SWW	265	36.9	1	241
GS2CLD5H36-DLL	306	55.7	-	241
GS2CLD5H36-DWW	306	55.7	-	241
GS2CLD5H36-SLL	285	55.7	-	241
GS2CLD5H36-SWW	285	55.7	-	241
GS2CLD6H30-DLL	342	43.8	1	241
GS2CLD6H30-DWW	342	43.8	1	241
GS2CLD6H30-SLL	311	43.8	1	241
GS2CLD6H30-SWW	311	43.8	1	241
GS2CLD6H36-DLL	362	55.7	-	241
GS2CLD6H36-DWW	362	55.7	-	241
GS2CLD6H36-SLL	331	55.7	-	241
GS2CLD6H36-SWW	331	55.7	-	241
GS2CLMA21-L	20	3.8	-	206
GS2CLMA21-W	20	3.8	-	206
GS2CLMA24-L	22	4.3	-	206
GS2CLMA24-W	22	4.3	-	206
GS2CLMA27-L	24	4.7	-	206
GS2CLMA27-W	24	4.7	-	206



model number	weight	cubes	#locks	page
GS2CLMA30-L	26	5.2	-	206
GS2CLMA30-W	26	5.2	-	206
GS2CLMA33-L	28	5.6	-	206
GS2CLMA33-W	28	5.6	-	206
GS2CLMA36-L	30	6.1	-	206
GS2CLMA36-W	30	6.1	-	206
GS2CLMA39-L	32	6.5	-	206
GS2CLMA39-W	32	6.5	-	206
GS2CLMA42-L	34	7.0	-	206
GS2CLMA42-W	34	7.0	-	206
GS2CLMA45-L	36	7.4	-	206
GS2CLMA45-W	36	7.4	-	206
GS2CLMA48-L	38	7.9	-	206
GS2CLMA48-W	38	7.9	-	206
GS2CLMA51-L	40	8.4	-	206
GS2CLMA51-W	40	8.4	-	206
GS2CLMA54-L	42	8.8	-	206
GS2CLMA54-W	42	8.8	-	206
GS2CLMA57-L	44	9.3	-	206
GS2CLMA57-W	44	9.3	-	206
GS2CLMA60-L	46	9.7	-	206
GS2CLMA60-W	46	9.7	-	206
GS2CLMA63-L	48	10.2	-	206
GS2CLMA63-W	48	10.2	-	206
GS2CLMA66-L	50	10.6	-	206
GS2CLMA66-W	50	10.6	-	206
GS2CLMA69-L	52	11.1	-	206
GS2CLMA69-W	52	11.1	-	206
GS2CLMA72-L	54	11.5	-	206
GS2CLMA72-W	54	11.5	-	206
GS2CLMF45-L	18	2.5	-	204
GS2CLMF45-W	18	2.5	-	204
GS2CLMF48-L	19	2.6	-	204
GS2CLMF48-W	19	2.6	-	204
GS2CLMF51-L	21	2.8	-	204
GS2CLMF51-W	21	2.8	-	204
GS2CLMF54-L	22	2.9	-	204
GS2CLMF54-W	22	2.9	-	204
GS2CLMF60-L	27	3.3	-	204
GS2CLMF60-W	27	3.3	-	204
GS2CLMF66-L	30	3.6	-	204
GS2CLMF66-W	30	3.6	-	204
GS2CLMF72-L	33	3.9	-	204
GS2CLMF72-W	33	3.9	-	204

model number	weight	cubes	#locks	page
GS2CLMF78-L	36	4.2	-	204
GS2CLMF78-W	36	4.2	-	204
GS2CLMF84-L	39	4.5	-	204
GS2CLMF84-W	39	4.5	-	204
GS2CLMF90-L	42	4.9	-	204
GS2CLMF90-W	42	4.9	-	204
GS2CLMF96-L	45	5.2	-	204
GS2CLMF96-W	45	5.2	-	204
GS2CLMF102-L	48	5.5	-	204
GS2CLMF102-W	48	5.5	-	204
GS2CLMF108-L	51	5.8	-	204
GS2CLMF108-W	51	5.8	-	204
GS2CLMF114-L	54	6.1	-	204
GS2CLMF114-W	54	6.1	-	204
GS2CLMF120-L	57	6.4	-	204
GS2CLMF120-W	57	6.4	-	204
GS2CLPD249L-XL	32	4.3	-	179
GS2CLPD249L-XW	32	4.3	-	179
GS2CLPD249R-XL	32	4.3	-	179
GS2CLPD249R-XW	32	4.3	-	179
GS2CLPD249TL-XL	32	4.3	-	184
GS2CLPD249TL-XW	32	4.3	-	184
GS2CLPD249TR-XL	32	4.3	-	184
GS2CLPD249TR-XW	32	4.3	-	184
GS2CLPD2415-AL	79	6.5	1	180
GS2CLPD2415-AW	79	6.5	1	180
GS2CLPD2415T-AL	79	6.5	1	185
GS2CLPD2415T-AW	79	6.5	1	185
GS2CLPD2418-AL	86	7.5	1	180
GS2CLPD2418-AW	86	7.5	1	180
GS2CLPD2418T-AL	86	7.5	1	185
GS2CLPD2418T-AW	86	7.5	1	185
GS2CLPD2430-5L	106	11.8	1	182
GS2CLPD2430-5W	106	11.8	1	182
GS2CLPD2430-BL	111	11.8	1	181
GS2CLPD2430-BW	111	11.8	1	181
GS2CLPD2430-SHL	96	11.8	-	183
GS2CLPD2430-SHW	96	11.8	-	183
GS2CLPD2430T-5L	106	11.8	1	187
GS2CLPD2430T-5W	106	11.8	1	187
GS2CLPD2430T-BL	111	11.8	1	186
GS2CLPD2430T-BW	111	11.8	1	186
GS2CLPD2430T-SHL	96	11.8	-	188
GS2CLPD2430T-SHW	96	11.8	-	188

# WEIGHTS + CUBES

Silea  
02/24

model number	weight	cubes	#locks	page
GS2CLPD2436-5L	124	14.0	1	182
GS2CLPD2436-5W	124	14.0	1	182
GS2CLPD2436-BL	125	14.0	1	181
GS2CLPD2436-BW	125	14.0	1	181
GS2CLPD2436-SHL	114	14.0	-	183
GS2CLPD2436-SHW	114	14.0	-	183
GS2CLPD2436T-5L	124	14.0	1	187
GS2CLPD2436T-5W	124	14.0	1	187
GS2CLPD2436T-BL	125	14.0	1	186
GS2CLPD2436T-BW	125	14.0	1	186
GS2CLPD2436T-SHL	114	14.0	-	188
GS2CLPD2436T-SHW	114	14.0	-	188
GS2CLPD-CUSH2130T	10	1.8	-	218
GS2CLPD-CUSH2136T	11	2.1	-	218
GS2CLS5H15L-LL	146	20.1	1	240
GS2CLS5H15L-WG	146	20.1	-	242
GS2CLS5H15L-WW	146	20.1	1	240
GS2CLS5H15R-LL	146	20.1	1	240
GS2CLS5H15R-WG	146	20.1	-	242
GS2CLS5H15R-WW	146	20.1	1	240
GS2CLS5H18L-LL	166	23.5	1	240
GS2CLS5H18L-WG	166	23.5	-	242
GS2CLS5H18L-WW	166	23.5	1	240
GS2CLS5H18R-LL	166	23.5	1	240
GS2CLS5H18R-WG	166	23.5	-	242
GS2CLS5H18R-WW	166	23.5	1	240
GS2CLS5H30D18L-LL	181	31.6	-	243
GS2CLS5H30D18L-WG	181	31.6	-	244
GS2CLS5H30D18L-WW	181	31.6	-	243
GS2CLS5H30D18R-LL	181	31.6	-	243
GS2CLS5H30D18R-WG	181	31.6	-	244
GS2CLS5H30D18R-WW	181	31.6	-	243
GS2CLS6H15L-LL	181	26.5	-	240
GS2CLS6H15L-WG	181	26.5	-	242
GS2CLS6H15L-WW	181	26.5	-	240
GS2CLS6H15R-LL	181	26.5	-	240
GS2CLS6H15R-WG	181	26.5	-	242
GS2CLS6H15R-WW	181	26.5	-	240
GS2CLS6H18L-LL	191	27.9	1	240
GS2CLS6H18L-WG	191	27.9	-	242
GS2CLS6H18L-WW	191	27.9	1	240
GS2CLS6H18R-LL	191	27.9	1	240
GS2CLS6H18R-WG	191	27.9	-	242
GS2CLS6H18R-WW	191	27.9	1	240

model number	weight	cubes	#locks	page
GS2CLS6H30D18L-LL	205	31.6	-	243
GS2CLS6H30D18L-WG	205	31.6	-	244
GS2CLS6H30D18L-WW	205	31.6	-	243
GS2CLS6H30D18R-LL	205	31.6	-	243
GS2CLS6H30D18R-WG	205	31.6	-	244
GS2CLS6H30D18R-WW	205	31.6	-	243
GS2CMA21-L	23	3.9	-	205
GS2CMA21-W	23	3.9	-	205
GS2CMA24-L	25	4.3	-	205
GS2CMA24-W	25	4.3	-	205
GS2CMA27-L	27	4.8	-	205
GS2CMA27-W	27	4.8	-	205
GS2CMA30-L	29	5.3	-	205
GS2CMA30-W	29	5.3	-	205
GS2CMA33-L	31	5.8	-	205
GS2CMA33-W	31	5.8	-	205
GS2CMA36-L	33	6.3	-	205
GS2CMA36-W	33	6.3	-	205
GS2CMA39-L	35	6.8	-	205
GS2CMA39-W	35	6.8	-	205
GS2CMA42-L	37	7.2	-	205
GS2CMA42-W	37	7.2	-	205
GS2CMA45-L	39	7.7	-	205
GS2CMA45-W	39	7.7	-	205
GS2CMA48-L	41	8.2	-	205
GS2CMA48-W	41	8.2	-	205
GS2CMA51-L	43	8.7	-	205
GS2CMA51-W	43	8.7	-	205
GS2CMA54-L	45	9.2	-	205
GS2CMA54-W	45	9.2	-	205
GS2CMA57-L	47	9.6	-	205
GS2CMA57-W	47	9.6	-	205
GS2CMA60-L	49	10.1	-	205
GS2CMA60-W	49	10.1	-	205
GS2CMA63-L	51	10.6	-	205
GS2CMA63-W	51	10.6	-	205
GS2CMA66-L	53	11.1	-	205
GS2CMA66-W	53	11.1	-	205
GS2CMA69-L	55	11.6	-	205
GS2CMA69-W	55	11.6	-	205
GS2CMA72-L	57	12.1	-	205
GS2CMA72-W	57	12.1	-	205
GS2CMF60-L	29	4.3	-	203
GS2CMF60-W	29	4.3	-	203

model number	weight	cubes	#locks	page
GS2CMF66-L	32	4.7	-	203
GS2CMF66-W	32	4.7	-	203
GS2CMF72-L	35	5.1	-	203
GS2CMF72-W	35	5.1	-	203
GS2CMF78-L	38	5.5	-	203
GS2CMF78-W	38	5.5	-	203
GS2CMF84-L	41	5.9	-	203
GS2CMF84-W	41	5.9	-	203
GS2CMF90-L	44	6.3	-	203
GS2CMF90-W	44	6.3	-	203
GS2CMF96-L	47	6.7	-	203
GS2CMF96-W	47	6.7	-	203
GS2CMF102-L	50	7.1	-	203
GS2CMF102-W	50	7.1	-	203
GS2CMF108-L	53	7.5	-	203
GS2CMF108-W	53	7.5	-	203
GS2CMF114-L	56	7.9	-	203
GS2CMF114-W	56	7.9	-	203
GS2CMF120-L	59	8.4	-	203
GS2CMF120-W	59	8.4	-	203
GS2COLUMN	10	0.9	-	157
GS2CPD249L-XL	37	5.6	-	169
GS2CPD249L-XW	37	5.6	-	169
GS2CPD249R-XL	37	5.6	-	169
GS2CPD249R-XW	37	5.6	-	169
GS2CPD249TL-XL	37	5.6	-	174
GS2CPD249TL-XW	37	5.6	-	174
GS2CPD249TR-XL	37	5.6	-	174
GS2CPD249TR-XW	37	5.6	-	174
GS2CPD309L-XL	40	8.7	-	189
GS2CPD309L-XW	40	8.7	-	189
GS2CPD309R-XL	40	8.7	-	189
GS2CPD309R-XW	40	8.7	-	189
GS2CPD309TL-XL	40	8.7	-	194
GS2CPD309TL-XW	40	8.7	-	194
GS2CPD309TR-XL	40	8.7	-	194
GS2CPD309TR-XW	40	8.7	-	194
GS2CPD2415-2L	84	8.4	1	170
GS2CPD2415-2W	84	8.4	1	170
GS2CPD2415-3AL	84	8.4	1	170
GS2CPD2415-3AW	84	8.4	1	170
GS2CPD2415-3L	84	8.4	1	170
GS2CPD2415-3W	84	8.4	1	170
GS2CPD2415L-5L	70	10.5	1	172

model number	weight	cubes	#locks	page
GS2CPD2415L-5W	70	10.5	1	172
GS2CPD2415R-5L	70	10.5	1	172
GS2CPD2415R-5W	70	10.5	1	172
GS2CPD2415-SHL	65	10.5	-	173
GS2CPD2415-SHW	65	10.5	-	173
GS2CPD2415T-2L	84	8.4	1	175
GS2CPD2415T-2W	84	8.4	1	175
GS2CPD2415T-3AL	84	8.4	1	175
GS2CPD2415T-3AW	84	8.4	1	175
GS2CPD2415T-3L	84	8.4	1	175
GS2CPD2415T-3W	84	8.4	1	175
GS2CPD2415TL-5L	70	10.5	1	177
GS2CPD2415TL-5W	70	10.5	1	177
GS2CPD2415TR-5L	70	10.5	1	177
GS2CPD2415TR-5W	70	10.5	1	177
GS2CPD2415T-SHL	65	10.5	-	178
GS2CPD2415T-SHW	65	10.5	-	178
GS2CPD2418-2L	91	9.8	1	170
GS2CPD2418-2W	91	9.8	1	170
GS2CPD2418-3AL	91	9.8	1	170
GS2CPD2418-3AW	91	9.8	1	170
GS2CPD2418-3L	91	9.8	1	170
GS2CPD2418-3W	91	9.8	1	170
GS2CPD2418L-5L	75	12.1	1	172
GS2CPD2418L-5W	75	12.1	1	172
GS2CPD2418R-5L	75	12.1	1	172
GS2CPD2418R-5W	75	12.1	1	172
GS2CPD2418-SHL	75	12.1	-	173
GS2CPD2418-SHW	75	12.1	-	173
GS2CPD2418T-2L	91	9.8	1	175
GS2CPD2418T-2W	91	9.8	1	175
GS2CPD2418T-3AL	91	9.8	1	175
GS2CPD2418T-3AW	91	9.8	1	175
GS2CPD2418T-3L	91	9.8	1	175
GS2CPD2418T-3W	91	9.8	1	175
GS2CPD2418TL-5L	75	12.1	1	177
GS2CPD2418TL-5W	75	12.1	1	177
GS2CPD2418TR-5L	75	12.1	1	177
GS2CPD2418TR-5W	75	12.1	1	177
GS2CPD2418T-SHL	75	12.1	-	178
GS2CPD2418T-SHW	75	12.1	-	178
GS2CPD2424-5L	85	15.4	1	172
GS2CPD2424-5W	85	15.4	1	172
GS2CPD2424-SHL	80	15.4	-	173

# WEIGHTS + CUBES

Silea  
02/24

model number	weight	cubes	#locks	page
GS2CPD2424-SHW	80	15.4	-	173
GS2CPD2424T-5L	85	15.4	1	177
GS2CPD2424T-5W	85	15.4	1	177
GS2CPD2424T-SHL	80	15.4	-	178
GS2CPD2424T-SHW	80	15.4	-	178
GS2CPD2430-4L	116	15.4	1	171
GS2CPD2430-4W	116	15.4	1	171
GS2CPD2430-5L	111	15.4	1	172
GS2CPD2430-5W	111	15.4	1	172
GS2CPD2430-7L	118	15.4	1	171
GS2CPD2430-7W	118	15.4	1	171
GS2CPD2430L-MFL	136	18.7	1	171
GS2CPD2430L-MFW	136	18.7	1	171
GS2CPD2430-PL	135	18.7	1	172
GS2CPD2430-PW	135	18.7	1	172
GS2CPD2430R-MFL	136	18.7	1	171
GS2CPD2430R-MFW	136	18.7	1	171
GS2CPD2430-SHL	101	15.4	-	173
GS2CPD2430-SHW	101	15.4	-	173
GS2CPD2430T-4L	116	15.4	1	176
GS2CPD2430T-4W	116	15.4	1	176
GS2CPD2430T-5L	111	15.4	1	177
GS2CPD2430T-5W	111	15.4	1	177
GS2CPD2430T-7L	118	15.4	1	176
GS2CPD2430T-7W	118	15.4	1	176
GS2CPD2430TL-MFL	136	18.7	1	176
GS2CPD2430TL-MFW	136	18.7	1	176
GS2CPD2430T-PL	135	18.7	1	177
GS2CPD2430T-PW	135	18.7	1	177
GS2CPD2430TR-MFL	136	18.7	1	176
GS2CPD2430TR-MFW	136	18.7	1	176
GS2CPD2430T-SHL	101	15.4	-	178
GS2CPD2430T-SHW	101	15.4	-	178
GS2CPD2436-4L	130	18.2	1	171
GS2CPD2436-4W	130	18.2	1	171
GS2CPD2436-5L	129	18.2	1	172
GS2CPD2436-5W	129	18.2	1	172
GS2CPD2436-7L	133	18.2	1	171
GS2CPD2436-7W	133	18.2	1	171
GS2CPD2436L-MFL	150	22.0	1	171
GS2CPD2436L-MFW	150	22.0	1	171
GS2CPD2436-PL	140	22.0	1	172
GS2CPD2436-PW	140	22.0	1	172
GS2CPD2436R-MFL	150	22.0	1	171

model number	weight	cubes	#locks	page
GS2CPD2436R-MFW	150	22.0	1	171
GS2CPD2436-SHL	119	18.2	-	173
GS2CPD2436-SHW	119	18.2	-	173
GS2CPD2436T-4L	130	18.2	1	176
GS2CPD2436T-4W	130	18.2	1	176
GS2CPD2436T-5L	129	18.2	1	177
GS2CPD2436T-5W	129	18.2	1	177
GS2CPD2436T-7L	133	18.2	1	176
GS2CPD2436T-7W	133	18.2	1	176
GS2CPD2436TL-MFL	150	22.0	1	176
GS2CPD2436TL-MFW	150	22.0	1	176
GS2CPD2436T-PL	140	22.0	1	177
GS2CPD2436T-PW	140	22.0	1	177
GS2CPD2436TR-MFL	150	22.0	1	176
GS2CPD2436TR-MFW	150	22.0	1	176
GS2CPD2436T-SHL	119	18.2	-	178
GS2CPD2436T-SHW	119	18.2	-	178
GS2CPD3015-2L	89	12.7	1	190
GS2CPD3015-2W	89	12.7	1	190
GS2CPD3015-3AL	89	12.7	1	190
GS2CPD3015-3AW	89	12.7	1	190
GS2CPD3015-3L	89	12.7	1	190
GS2CPD3015-3W	89	12.7	1	190
GS2CPD3015L-5L	75	12.7	1	192
GS2CPD3015L-5W	75	12.7	1	192
GS2CPD3015R-5L	75	12.7	1	192
GS2CPD3015R-5W	75	12.7	1	192
GS2CPD3015-SHL	70	12.7	-	193
GS2CPD3015-SHW	70	12.7	-	193
GS2CPD3015T-2L	88	12.7	1	195
GS2CPD3015T-2W	88	12.7	1	195
GS2CPD3015T-3AL	88	12.7	1	195
GS2CPD3015T-3AW	88	12.7	1	195
GS2CPD3015T-3L	88	12.7	1	195
GS2CPD3015T-3W	88	12.7	1	195
GS2CPD3015TL-5L	75	12.7	1	197
GS2CPD3015TL-5W	75	12.7	1	197
GS2CPD3015TR-5L	75	12.7	1	197
GS2CPD3015TR-5W	75	12.7	1	197
GS2CPD3015T-SHL	70	12.7	-	198
GS2CPD3015T-SHW	70	12.7	-	198
GS2CPD3018-2L	96	14.7	1	190
GS2CPD3018-2W	96	14.7	1	190
GS2CPD3018-3AL	96	14.7	1	190

model number	weight	cubes	#locks	page
GS2CPD3018-3AW	96	14.7	1	190
GS2CPD3018-3L	96	14.7	1	190
GS2CPD3018-3W	96	14.7	1	190
GS2CPD3018L-5L	80	14.7	1	192
GS2CPD3018L-5W	80	14.7	1	192
GS2CPD3018R-5L	80	14.7	1	192
GS2CPD3018R-5W	80	14.7	1	192
GS2CPD3018-SHL	80	14.7	-	193
GS2CPD3018-SHW	80	14.7	-	193
GS2CPD3018T-2L	95	14.7	1	195
GS2CPD3018T-2W	95	14.7	1	195
GS2CPD3018T-3AL	95	14.7	1	195
GS2CPD3018T-3AW	95	14.7	1	195
GS2CPD3018T-3L	95	14.7	1	195
GS2CPD3018T-3W	95	14.7	1	195
GS2CPD3018TL-5L	80	14.7	1	197
GS2CPD3018TL-5W	80	14.7	1	197
GS2CPD3018TR-5L	80	14.7	1	197
GS2CPD3018TR-5W	80	14.7	1	197
GS2CPD3018T-SHL	80	14.7	-	198
GS2CPD3018T-SHW	80	14.7	-	198
GS2CPD3024-5L	90	18.7	1	192
GS2CPD3024-5W	90	18.7	1	192
GS2CPD3024-SHL	85	18.7	-	193
GS2CPD3024-SHW	85	18.7	-	193
GS2CPD3024T-5L	90	18.7	1	197
GS2CPD3024T-5W	90	18.7	1	197
GS2CPD3024T-SHL	85	18.7	-	198
GS2CPD3024T-SHW	85	18.7	-	198
GS2CPD3030-4L	120	22.7	1	191
GS2CPD3030-4W	120	22.7	1	191
GS2CPD3030-5L	114	22.7	1	192
GS2CPD3030-5W	114	22.7	1	192
GS2CPD3030-7L	125	22.7	1	191
GS2CPD3030-7W	125	22.7	1	191
GS2CPD3030L-MFL	148	22.7	1	191
GS2CPD3030L-MFW	148	22.7	1	191
GS2CPD3030-PL	140	22.7	1	192
GS2CPD3030-PW	140	22.7	1	192
GS2CPD3030R-MFL	148	22.7	1	191
GS2CPD3030R-MFW	148	22.7	1	191
GS2CPD3030-SHL	105	22.7	-	193
GS2CPD3030-SHW	105	22.7	-	193
GS2CPD3030T-4L	125	22.7	1	196

model number	weight	cubes	#locks	page
GS2CPD3030T-4W	125	22.7	1	196
GS2CPD3030T-5L	119	22.7	1	197
GS2CPD3030T-5W	119	22.7	1	197
GS2CPD3030T-7L	127	22.7	1	196
GS2CPD3030T-7W	127	22.7	1	196
GS2CPD3030TL-MFL	148	22.7	1	196
GS2CPD3030TL-MFW	148	22.7	1	196
GS2CPD3030T-PL	140	22.7	1	197
GS2CPD3030T-PW	140	22.7	1	197
GS2CPD3030TR-MFL	148	22.7	1	196
GS2CPD3030TR-MFW	148	22.7	1	196
GS2CPD3030T-SHL	108	22.7	-	198
GS2CPD3030T-SHW	108	22.7	-	198
GS2CPD3036-4L	128	26.8	1	191
GS2CPD3036-4W	128	26.8	1	191
GS2CPD3036-5L	122	26.8	1	192
GS2CPD3036-5W	122	26.8	1	192
GS2CPD3036-7L	132	26.8	1	191
GS2CPD3036-7W	132	26.8	1	191
GS2CPD3036L-MFL	162	26.8	1	191
GS2CPD3036L-MFW	162	26.8	1	191
GS2CPD3036-PL	145	26.8	1	192
GS2CPD3036-PW	145	26.8	1	192
GS2CPD3036R-MFL	162	26.8	1	191
GS2CPD3036R-MFW	162	26.8	1	191
GS2CPD3036-SHL	113	26.8	-	193
GS2CPD3036-SHW	113	26.8	-	193
GS2CPD3036T-4L	140	26.8	1	196
GS2CPD3036T-4W	140	26.8	1	196
GS2CPD3036T-5L	135	26.8	1	197
GS2CPD3036T-5W	135	26.8	1	197
GS2CPD3036T-7L	143	26.8	1	196
GS2CPD3036T-7W	143	26.8	1	196
GS2CPD3036TL-MFL	162	26.8	1	196
GS2CPD3036TL-MFW	162	26.8	1	196
GS2CPD3036T-PL	145	26.8	1	197
GS2CPD3036T-PW	145	26.8	1	197
GS2CPD3036TR-MFL	162	26.8	1	196
GS2CPD3036TR-MFW	162	26.8	1	196
GS2CPD3036T-SHL	124	26.8	-	198
GS2CPD3036T-SHW	124	26.8	-	198
GS2CWA2240-L	27	2.6	-	118
GS2CWA2240-W	27	2.6	-	118
GS2CWA2246-L	31	3.0	-	118

# WEIGHTS + CUBES

Silea  
02/24

model number	weight	cubes	#locks	page
GS2CWA2246-W	31	3.0	-	118
GS2CWA2252-L	35	3.3	-	118
GS2CWA2252-W	35	3.3	-	118
GS2CWA2258-L	39	3.7	-	118
GS2CWA2258-W	39	3.7	-	118
GS2CWA2264-L	43	4.1	-	118
GS2CWA2264-W	43	4.1	-	118
GS2CWA2270-L	48	4.4	-	118
GS2CWA2270-W	48	4.4	-	118
GS2CWA2840-L	35	3.2	-	118
GS2CWA2840-W	35	3.2	-	118
GS2CWA2846-L	40	3.7	-	118
GS2CWA2846-W	40	3.7	-	118
GS2CWA2852-L	45	4.1	-	118
GS2CWA2852-W	45	4.1	-	118
GS2CWA2858-L	50	4.6	-	118
GS2CWA2858-W	50	4.6	-	118
GS2CWA2864-L	55	5.0	-	118
GS2CWA2864-W	55	5.0	-	118
GS2CWA2870-L	61	5.5	-	118
GS2CWA2870-W	61	5.5	-	118
GS2CWA3440-L	42	3.9	-	118
GS2CWA3440-W	42	3.9	-	118
GS2CWA3446-L	48	4.4	-	118
GS2CWA3446-W	48	4.4	-	118
GS2CWA3452-L	55	4.9	-	118
GS2CWA3452-W	55	4.9	-	118
GS2CWA3458-L	61	5.5	-	118
GS2CWA3458-W	61	5.5	-	118
GS2CWA3464-L	67	6.0	-	118
GS2CWA3464-W	67	6.0	-	118
GS2CWA3470-L	73	6.5	-	118
GS2CWA3470-W	73	6.5	-	118
GS2CWR2415-L	11	1.3	-	165
GS2CWR2415-W	11	1.3	-	165
GS2CWR2418-L	13	1.5	-	165
GS2CWR2418-W	13	1.5	-	165
GS2CWR2424-L	18	1.9	-	165
GS2CWR2424-W	18	1.9	-	165
GS2CWR2430-L	27	2.2	-	165
GS2CWR2430-W	27	2.2	-	165
GS2CWR2436-L	32	2.6	-	165
GS2CWR2436-W	32	2.6	-	165
GS2CWR2442-L	36	2.9	-	165

model number	weight	cubes	#locks	page
GS2CWR2442-W	36	2.9	-	165
GS2CWR2448-L	41	3.3	-	165
GS2CWR2448-W	41	3.3	-	165
GS2CWR2454-L	45	3.7	-	165
GS2CWR2454-W	45	3.7	-	165
GS2CWR2460-L	49	4.1	-	165
GS2CWR2460T-L	49	5.3	-	167
GS2CWR2460T-W	59	5.3	-	167
GS2CWR2460-W	49	4.1	-	165
GS2CWR2466-L	54	4.5	-	165
GS2CWR2466T-L	53	5.8	-	167
GS2CWR2466T-W	65	5.8	-	167
GS2CWR2466-W	54	4.5	-	165
GS2CWR2472-L	58	4.9	-	165
GS2CWR2472T-L	58	6.3	-	167
GS2CWR2472T-W	71	6.3	-	167
GS2CWR2472-W	58	4.9	-	165
GS2CWR2478-L	63	5.3	-	165
GS2CWR2478T-L	63	6.8	-	167
GS2CWR2478T-W	76	6.9	-	167
GS2CWR2478-W	63	5.3	-	165
GS2CWR2484-L	67	5.7	-	165
GS2CWR2484T-L	68	7.3	-	167
GS2CWR2484T-W	81	7.4	-	167
GS2CWR2484-W	67	5.7	-	165
GS2CWR2490-L	72	6.1	-	165
GS2CWR2490T-L	72	7.8	-	167
GS2CWR2490T-W	87	7.9	-	167
GS2CWR2490-W	72	6.1	-	165
GS2CWR2496-L	76	6.5	-	165
GS2CWR2496T-L	77	8.3	-	167
GS2CWR2496T-W	93	8.4	-	167
GS2CWR2496-W	76	6.5	-	165
GS2CWR3015-L	14	1.6	-	166
GS2CWR3015-W	14	1.6	-	166
GS2CWR3018-L	16	1.8	-	166
GS2CWR3018-W	16	1.8	-	166
GS2CWR3024-L	22	2.3	-	166
GS2CWR3024-W	22	2.3	-	166
GS2CWR3030-L	28	2.8	-	166
GS2CWR3030-W	28	2.8	-	166
GS2CWR3036-L	32	3.3	-	166
GS2CWR3036-W	32	3.3	-	166
GS2CWR3042-L	38	3.8	-	166

model number	weight	cubes	#locks	page
GS2CWR3042-W	38	3.8	-	166
GS2CWR3048-L	45	4.3	-	166
GS2CWR3048-W	45	4.3	-	166
GS2CWR3054-L	50	4.8	-	166
GS2CWR3054-W	50	4.8	-	166
GS2CWR3060-L	55	5.3	-	166
GS2CWR3060T-L	55	6.5	-	168
GS2CWR3060T-W	55	6.5	-	168
GS2CWR3060-W	55	5.3	-	166
GS2CWR3066-L	60	5.8	-	166
GS2CWR3066T-L	61	7.1	-	168
GS2CWR3066T-W	61	7.1	-	168
GS2CWR3066-W	60	5.8	-	166
GS2CWR3072-L	65	6.3	-	166
GS2CWR3072T-L	67	7.7	-	168
GS2CWR3072T-W	67	7.7	-	168
GS2CWR3072-W	65	6.3	-	166
GS2CWR3078-L	70	6.8	-	166
GS2CWR3078T-L	72	8.3	-	168
GS2CWR3078T-W	72	8.3	-	168
GS2CWR3078-W	70	6.8	-	166
GS2CWR3084-L	75	7.3	-	166
GS2CWR3084T-L	78	8.9	-	168
GS2CWR3084T-W	78	8.9	-	168
GS2CWR3084-W	75	7.3	-	166
GS2CWR3090-L	80	7.8	-	166
GS2CWR3090T-L	84	9.5	-	168
GS2CWR3090T-W	84	9.5	-	168
GS2CWR3090-W	80	7.8	-	166
GS2CWR3096-L	85	8.3	-	166
GS2CWR3096T-L	90	10.1	-	168
GS2CWR3096T-W	90	10.1	-	168
GS2CWR3096-W	85	8.3	-	166
GS2CWR24102-L	81	6.9	-	165
GS2CWR24102T-L	82	8.8	-	167
GS2CWR24102T-W	99	8.9	-	167
GS2CWR24102-W	81	6.9	-	165
GS2CWR24108-L	85	7.3	-	165
GS2CWR24108T-L	87	9.3	-	167
GS2CWR24108T-W	105	9.4	-	167
GS2CWR24108-W	85	7.3	-	165
GS2CWR24114-L	89	7.7	-	165
GS2CWR24114T-L	92	9.8	-	167
GS2CWR24114T-W	111	9.9	-	167

model number	weight	cubes	#locks	page
GS2CWR24114-W	89	7.7	-	165
GS2CWR24120-L	94	8.0	-	165
GS2CWR24120T-L	96	10.3	-	167
GS2CWR24120T-W	117	10.4	-	167
GS2CWR24120-W	94	8.0	-	165
GS2CWR30102-L	90	8.8	-	166
GS2CWR30102T-L	96	10.7	-	168
GS2CWR30102T-W	96	10.7	-	168
GS2CWR30102-W	90	8.8	-	166
GS2CWR30108-L	95	9.3	-	166
GS2CWR30108T-L	102	11.3	-	168
GS2CWR30108T-W	102	11.3	-	168
GS2CWR30108-W	95	9.3	-	166
GS2CWR30114-L	100	9.8	-	166
GS2CWR30114T-L	108	12.0	-	168
GS2CWR30114T-W	108	12.0	-	168
GS2CWR30114-W	100	9.8	-	166
GS2CWR30120-L	105	10.2	-	166
GS2CWR30120T-L	114	12.6	-	168
GS2CWR30120T-W	114	12.6	-	168
GS2CWR30120-W	105	10.2	-	166
GS2DBOB4272-32LL	342	33.8	2	50
GS2DBOB4272-32WW	342	33.8	2	50
GS2DBOB4272L-3LL	266	23.3	1	51
GS2DBOB4272L-3WW	266	23.3	1	51
GS2DBOB4272R-3LL	266	23.3	1	51
GS2DBOB4272R-3WW	266	23.3	1	51
GS2DBOF4272L-3LL	247	26.0	1	52
GS2DBOF4272L-3WW	247	26.0	1	52
GS2DBOF4272R-3LL	247	26.0	1	52
GS2DBOF4272R-3WW	247	26.0	1	52
GS2DDMF1560-L	33	3.2	-	161
GS2DDMF1560-W	33	3.2	-	161
GS2DDMF1566-L	36	3.9	-	161
GS2DDMF1566-W	36	3.9	-	161
GS2DDMF1572-L	39	4.5	-	161
GS2DDMF1572-W	39	4.5	-	161
GS2DDMF1578-L	42	5.1	-	161
GS2DDMF1578-W	42	5.1	-	161
GS2DDMF1584-L	46	5.8	-	161
GS2DDMF1584-W	46	5.8	-	161
GS2DDMF1590-L	49	5.0	-	161
GS2DDMF1590-W	49	5.0	-	161
GS2DDMF1596-L	52	5.4	-	161

# WEIGHTS + CUBES

Silea  
02/24

model number	weight	cubes	#locks	page
GS2DDMF1596-W	52	5.4	-	161
GS2DHL24-H	18	2.9	-	156
GS2DHL30-H	21	3.5	-	156
GS2DHL36-H	23	4.2	-	156
GS2DMPA24-L	7	0.8	-	160
GS2DMPA24-W	7	0.8	-	160
GS2DMPA27-L	7	0.9	-	160
GS2DMPA27-W	7	0.9	-	160
GS2DMPA30-L	7	0.9	-	160
GS2DMPA30-W	7	0.9	-	160
GS2DMPA33-L	7	1.0	-	160
GS2DMPA33-W	7	1.0	-	160
GS2DMPA36-L	7	1.1	-	160
GS2DMPA36-W	7	1.1	-	160
GS2DMPA39-L	7	1.2	-	160
GS2DMPA39-W	7	1.2	-	160
GS2DMPA42-L	8	1.3	-	160
GS2DMPA42-W	8	1.3	-	160
GS2DMPA45-L	8	1.4	-	160
GS2DMPA45-W	8	1.4	-	160
GS2DMPA48-L	9	1.5	-	160
GS2DMPA48-W	9	1.5	-	160
GS2DMPA51-L	9	1.5	-	160
GS2DMPA51-W	9	1.5	-	160
GS2DMPA54-L	10	1.6	-	160
GS2DMPA54-W	10	1.6	-	160
GS2DMPA57-L	10	1.7	-	160
GS2DMPA57-W	10	1.7	-	160
GS2DMPA60-L	11	1.8	-	160
GS2DMPA60-W	11	1.8	-	160
GS2DMPA63-L	11	1.9	-	160
GS2DMPA63-W	11	1.9	-	160
GS2DMPA66-L	12	2.0	-	160
GS2DMPA66-W	12	2.0	-	160
GS2DMPA69-L	12	2.1	-	160
GS2DMPA69-W	12	2.1	-	160
GS2DMPA72-L	13	2.1	-	160
GS2DMPA72-W	13	2.1	-	160
GS2DMPH39-G	7	1.2	-	159
GS2DMPH39-L	7	1.2	-	159
GS2DMPH39-W	7	1.2	-	159
GS2DMPH42-G	8	1.3	-	159
GS2DMPH42-L	8	1.3	-	159
GS2DMPH42-W	8	1.3	-	159

model number	weight	cubes	#locks	page
GS2DMPH45-G	8	1.3	-	159
GS2DMPH45-L	8	1.3	-	159
GS2DMPH45-W	8	1.3	-	159
GS2DMPH48-G	9	1.4	-	159
GS2DMPH48-L	9	1.4	-	159
GS2DMPH48-W	9	1.4	-	159
GS2DMPH51-G	9	1.5	-	159
GS2DMPH51-L	9	1.5	-	159
GS2DMPH51-W	9	1.5	-	159
GS2DMPH54-G	10	1.6	-	159
GS2DMPH54-L	10	1.6	-	159
GS2DMPH54-W	10	1.6	-	159
GS2DMPH57-G	10	1.7	-	159
GS2DMPH57-L	10	1.7	-	159
GS2DMPH57-W	10	1.7	-	159
GS2DMPH60-G	11	1.8	-	159
GS2DMPH60-L	11	1.8	-	159
GS2DMPH60-W	11	1.8	-	159
GS2DMPH63-G	11	1.9	-	159
GS2DMPH63-L	11	1.9	-	159
GS2DMPH63-W	11	1.9	-	159
GS2DMPH66-G	12	1.9	-	159
GS2DMPH66-L	12	1.9	-	159
GS2DMPH66-W	12	1.9	-	159
GS2DMPH69-G	12	2.0	-	159
GS2DMPH69-L	12	2.0	-	159
GS2DMPH69-W	12	2.0	-	159
GS2DMPH72-G	13	2.1	-	159
GS2DMPH72-L	13	2.1	-	159
GS2DMPH72-W	13	2.1	-	159
GS2DPC2472-22LL	265	26.8	1	56
GS2DPC2472-22WW	265	26.8	1	56
GS2DPD309-2SL	85	7.3	1	152
GS2DPD309-2SW	85	7.3	1	152
GS2DPD309-3SL	85	7.3	1	152
GS2DPD309-3SW	85	7.3	1	152
GS2DPD309L-XNL	45	7.3	-	153
GS2DPD309L-XNW	45	7.3	-	153
GS2DPD309R-XNL	45	7.3	-	153
GS2DPD309R-XNW	45	7.3	-	153
GS2DPD369-2SL	92	8.6	1	152
GS2DPD369-2SW	92	8.6	1	152
GS2DPD369-3SL	92	8.6	1	152
GS2DPD369-3SW	92	8.6	1	152



model number	weight	cubes	#locks	page
GS2DPD369L-XNL	52	8.6	-	153
GS2DPD369L-XNW	52	8.6	-	153
GS2DPD369R-XNL	52	8.6	-	153
GS2DPD369R-XNW	52	8.6	-	153
GS2DPD3015-2L	105	10.6	1	152
GS2DPD3015-2W	105	10.6	1	152
GS2DPD3015-3L	105	10.6	1	152
GS2DPD3015-3W	105	10.6	1	152
GS2DPD3015L-XNL	51	10.6	-	153
GS2DPD3015L-XNW	51	10.6	-	153
GS2DPD3015R-XNL	51	10.6	-	153
GS2DPD3015R-XNW	51	10.6	-	153
GS2DPD3615-2L	112	12.5	1	152
GS2DPD3615-2W	112	12.5	1	152
GS2DPD3615-3L	112	12.5	1	152
GS2DPD3615-3W	112	12.5	1	152
GS2DPD3615L-XNL	58	12.5	-	153
GS2DPD3615L-XNW	58	12.5	-	153
GS2DPD3615R-XNL	58	12.5	-	153
GS2DPD3615R-XNW	58	12.5	-	153
GS2DRFB3060L-3LL	218	18.8	1	51
GS2DRFB3060L-3WW	218	18.8	1	51
GS2DRFB3060R-3LL	218	18.8	1	51
GS2DRFB3060R-3WW	218	18.8	1	51
GS2DRFB3066L-3LL	229	20.0	1	51
GS2DRFB3066L-3WW	229	20.0	1	51
GS2DRFB3066R-3LL	229	20.0	1	51
GS2DRFB3066R-3WW	229	20.0	1	51
GS2DRFB3072L-3LL	240	21.1	1	51
GS2DRFB3072L-3WW	240	21.1	1	51
GS2DRFB3072R-3LL	240	21.1	1	51
GS2DRFB3072R-3WW	240	21.1	1	51
GS2DROB3672-32LL	329	32.7	2	50
GS2DROB3672-32WW	329	32.7	2	50
GS2DROB3672L-3LL	253	22.2	1	51
GS2DROB3672L-3WW	253	22.2	1	51
GS2DROB3672R-3LL	253	22.2	1	51
GS2DROB3672R-3WW	253	22.2	1	51
GS2DROB3678L-3LL	266	23.4	1	51
GS2DROB3678L-3WW	266	23.4	1	51
GS2DROB3678R-3LL	266	23.4	1	51
GS2DROB3678R-3WW	266	23.4	1	51
GS2DROF3060L-3LL	180	19.5	1	52
GS2DROF3060L-3WW	180	19.5	1	52

model number	weight	cubes	#locks	page
GS2DROF3060R-3LL	180	19.5	1	52
GS2DROF3060R-3WW	180	19.5	1	52
GS2DROF3066L-3LL	188	20.4	1	52
GS2DROF3066L-3WW	188	20.4	1	52
GS2DROF3066R-3LL	188	20.4	1	52
GS2DROF3066R-3WW	188	20.4	1	52
GS2DROF3072L-3LL	197	21.2	1	52
GS2DROF3072L-3WW	197	21.2	1	52
GS2DROF3072R-3LL	197	21.2	1	52
GS2DROF3072R-3WW	197	21.2	1	52
GS2DROF3672-32LL	325	33.3	2	50
GS2DROF3672-32WW	325	33.3	2	50
GS2DROF3672L-3LL	234	24.9	1	52
GS2DROF3672L-3WW	234	24.9	1	52
GS2DROF3672R-3LL	234	24.9	1	52
GS2DROF3672R-3WW	234	24.9	1	52
GS2DROF3678L-3LL	244	25.9	1	52
GS2DROF3678L-3WW	244	25.9	1	52
GS2DROF3678R-3LL	244	25.9	1	52
GS2DROF3678R-3WW	244	25.9	1	52
GS2DSL24-G	26	2.9	-	155
GS2DSL24-H	20	2.9	-	154
GS2DSL24-N	17	2.9	-	154
GS2DSL24-NST	18	2.9	-	154
GS2DSL30-G	29	3.5	-	155
GS2DSL30-H	23	3.5	-	154
GS2DSL30-N	20	3.5	-	154
GS2DSL30-NST	21	3.5	-	154
GS2DSL36-G	31	4.2	-	155
GS2DSL36-H	25	4.2	-	154
GS2DSL36-N	22	4.2	-	154
GS2DSL36-NST	23	4.2	-	154
GS2DWA3672-L	80	7.1	-	149
GS2DWA3672-W	80	7.1	-	149
GS2DWA3684-L	93	8.2	-	149
GS2DWA3684-W	93	8.2	-	149
GS2DWA4272-L	93	8.2	-	149
GS2DWA4272-W	93	8.2	-	149
GS2DWA4284-L	109	9.5	-	149
GS2DWA4284-W	109	9.5	-	149
GS2DWB4272-L	93	8.2	-	151
GS2DWB4272-W	93	8.2	-	151
GS2DWD4272-L	93	8.2	-	151
GS2DWD4272-W	93	8.2	-	151

# WEIGHTS + CUBES

Silea  
02/24

model number	weight	cubes	#locks	page
GS2DWRR3042-L	39	3.6	-	148
GS2DWRR3042-W	39	3.6	-	148
GS2DWRR3048-L	44	4.1	-	148
GS2DWRR3048-W	44	4.1	-	148
GS2DWRR3054-L	50	4.6	-	148
GS2DWRR3054-W	50	4.6	-	148
GS2DWRR3060-L	56	5.0	-	148
GS2DWRR3060-W	56	5.0	-	148
GS2DWRR3066-L	61	5.5	-	148
GS2DWRR3066-W	61	5.5	-	148
GS2DWRR3072-L	67	6.0	-	148
GS2DWRR3072-W	67	6.0	-	148
GS2DWRR3078-L	72	6.5	-	148
GS2DWRR3078-W	72	6.5	-	148
GS2DWRR3084-L	78	7.0	-	148
GS2DWRR3084-W	78	7.0	-	148
GS2DWRR3090-L	84	7.4	-	148
GS2DWRR3090-W	80	7.8	-	148
GS2DWRR3096-L	90	7.9	-	148
GS2DWRR3096-W	85	8.3	-	148
GS2DWRR3642-L	47	4.3	-	148
GS2DWRR3642-W	47	4.3	-	148
GS2DWRR3648-L	53	4.8	-	148
GS2DWRR3648-W	53	4.8	-	148
GS2DWRR3654-L	60	5.4	-	148
GS2DWRR3654-W	60	5.4	-	148
GS2DWRR3660-L	67	6.0	-	148
GS2DWRR3660-W	67	6.0	-	148
GS2DWRR3666-L	73	6.5	-	148
GS2DWRR3666-W	73	6.5	-	148
GS2DWRR3672-L	80	7.1	-	148
GS2DWRR3672-W	80	7.1	-	148
GS2DWRR3678-L	87	7.7	-	148
GS2DWRR3678-W	87	7.7	-	148
GS2DWRR3684-L	93	8.2	-	148
GS2DWRR3684-W	93	8.2	-	148
GS2DWRR3690-L	100	8.7	-	148
GS2DWRR3690-W	96	9.1	-	148
GS2DWRR3696-L	106	9.3	-	148
GS2DWRR3696-W	102	9.7	-	148
GS2DWRT3066L-L	61	5.5	-	150
GS2DWRT3066L-W	61	5.5	-	150
GS2DWRT3066R-L	61	5.5	-	150
GS2DWRT3066R-W	61	5.5	-	150

model number	weight	cubes	#locks	page
GS2DWRT3072L-L	67	6.0	-	150
GS2DWRT3072L-W	67	6.0	-	150
GS2DWRT3072R-L	67	6.0	-	150
GS2DWRT3072R-W	67	6.0	-	150
GS2FBX75H90L-WSG	775	103.0	-	319
GS2FBX75H90R-WSG	775	103.0	-	319
GS2FSC2460-44LL	240	32.0	2	58
GS2FSC2460-55LL	210	32.0	2	59
GS2FSC2460-55WW	210	32.0	2	59
GS2FSC2472-44LL	310	38.1	2	58
GS2FSC2472-44WW	310	38.1	2	58
GS2FSC2472-55LL	280	38.1	2	59
GS2FSC2472-55WW	280	38.1	2	59
GS2FSF830-L	10	0.9	-	302
GS2FSF830-W	10	0.9	-	302
GS2FSF836-L	12	1.0	-	302
GS2FSF836-W	12	1.0	-	302
GS2FSF842-L	14	1.2	-	302
GS2FSF842-W	14	1.2	-	302
GS2FSF848-L	16	1.4	-	302
GS2FSF848-W	16	1.4	-	302
GS2FSF854-L	18	1.5	-	302
GS2FSF854-W	18	1.5	-	302
GS2FSF860-L	20	1.7	-	302
GS2FSF860-W	20	1.7	-	302
GS2FSF866-L	22	1.8	-	302
GS2FSF866-W	22	1.8	-	302
GS2FSF872-L	24	2.0	-	302
GS2FSF872-W	24	2.0	-	302
GS2GMT	1	0.1	-	334
GS2LFS2H30-LL	156	16.8	1	238
GS2LFS2H30-WW	156	16.8	1	238
GS2LFS2H36-LL	179	19.8	1	238
GS2LFS2H36-WW	179	19.8	1	238
GS2LFS3H30-LL	201	23.3	1	239
GS2LFS3H30-WW	201	23.3	1	239
GS2LFS3H36-LL	230	27.5	1	239
GS2LFS3H36-WW	230	27.5	1	239
GS2LFS4H30-LL	246	29.6	1	239
GS2LFS4H30-WW	246	29.6	1	239
GS2LFS4H36-LL	281	35.0	1	239
GS2LFS4H36-WW	281	35.0	1	239
GS2LFS5H30-LL	291	36.9	1	239
GS2LFS5H30-WW	291	36.9	1	239

model number	weight	cubes	#locks	page
GS2LFS5H36-LL	332	43.6	1	239
GS2LFS5H36-WW	332	43.6	1	239
GS2LFS6H30-LL	337	43.8	1	239
GS2LFS6H30-WW	337	43.8	1	239
GS2LFS6H36-LL	386	51.8	1	239
GS2LFS6H36-WW	386	51.8	1	239
GS2LHAPD2424L-LL	88	10.4	-	116
GS2LHAPD2424L-WW	88	10.4	-	116
GS2LHAPD2424R-LL	88	10.4	-	116
GS2LHAPD2424R-WW	88	10.4	-	116
GS2LHAPD2430L-LL	96	12.7	-	116
GS2LHAPD2430L-WW	96	12.7	-	116
GS2LHAPD2430R-LL	96	12.7	-	116
GS2LHAPD2430R-WW	96	12.7	-	116
GS2LHAPD2436L-LL	114	15.0	-	116
GS2LHAPD2436L-WW	114	15.0	-	116
GS2LHAPD2436R-LL	114	15.0	-	116
GS2LHAPD2436R-WW	114	15.0	-	116
GS2LKR5H24L-LG	175	28.8	-	259
GS2LKR5H24L-LL	175	28.8	-	258
GS2LKR5H24L-WG	175	30.2	-	259
GS2LKR5H24L-WW	175	30.2	-	258
GS2LKR5H24R-LG	175	28.8	-	259
GS2LKR5H24R-LL	175	28.8	-	258
GS2LKR5H24R-WG	175	30.2	-	259
GS2LKR5H24R-WW	175	30.2	-	258
GS2LKR6H24L-LG	230	34.0	-	259
GS2LKR6H24L-LL	230	33.9	-	258
GS2LKR6H24L-WG	230	35.8	-	259
GS2LKR6H24L-WW	230	35.8	-	258
GS2LKR6H24R-LG	230	34.0	-	259
GS2LKR6H24R-LL	230	33.9	-	258
GS2LKR6H24R-WG	230	35.8	-	259
GS2LKR6H24R-WW	230	35.8	-	258
GS2LLKR5H24L-LG	175	28.8	-	261
GS2LLKR5H24L-LL	175	28.8	-	260
GS2LLKR5H24L-WG	175	30.2	-	261
GS2LLKR5H24L-WW	175	30.2	-	260
GS2LLKR5H24R-LG	175	28.8	-	261
GS2LLKR5H24R-LL	175	28.8	-	260
GS2LLKR5H24R-WG	175	30.2	-	261
GS2LLKR5H24R-WW	175	30.2	-	260
GS2LLKR6H24L-LG	230	34.0	-	261
GS2LLKR6H24L-LL	230	33.9	-	260

model number	weight	cubes	#locks	page
GS2LLKR6H24L-WG	230	35.8	-	261
GS2LLKR6H24L-WW	230	35.8	-	260
GS2LLKR6H24R-LG	230	34.0	-	261
GS2LLKR6H24R-LL	230	33.9	-	260
GS2LLKR6H24R-WG	230	35.8	-	261
GS2LLKR6H24R-WW	230	35.8	-	260
GS2MEP24L-L	11	1.8	-	199
GS2MEP24L-W	11	1.8	-	199
GS2MEP24R-L	11	1.8	-	199
GS2MEP24R-W	11	1.8	-	199
GS2MEP30L-L	14	2.2	-	199
GS2MEP30L-W	14	2.2	-	199
GS2MEP30R-L	14	2.2	-	199
GS2MEP30R-W	14	2.2	-	199
GS2MEP36L-L	17	2.6	-	199
GS2MEP36L-W	17	2.6	-	199
GS2MEP36R-L	17	2.6	-	199
GS2MEP36R-W	17	2.6	-	199
GS2MLB18	5	0.4	-	215
GS2MLB24	7	0.5	-	215
GS2MLB30	9	0.6	-	215
GS2MLB30SL-L	45	3.0	-	212
GS2MLB30SL-W	45	3.2	-	212
GS2MLB30SR-L	45	3.0	-	212
GS2MLB30SR-W	45	3.2	-	212
GS2MLB36	11	0.8	-	215
GS2MLB36SL-L	51	3.6	-	212
GS2MLB36SL-W	51	3.8	-	212
GS2MLB36SR-L	51	3.6	-	212
GS2MLB36SR-W	51	3.8	-	212
GS2MLPB15-L	7	0.9	-	202
GS2MLPB15-W	7	0.9	-	202
GS2MLPB18-L	11	1.1	-	202
GS2MLPB18-W	11	1.1	-	202
GS2MLPB30-L	14	1.7	-	202
GS2MLPB30-W	14	1.7	-	202
GS2MLPB36-L	17	2.0	-	202
GS2MLPB36-W	17	2.0	-	202
GS2MLPF-L	2	0.5	-	202
GS2MLPF-W	2	0.5	-	202
GS2MLS24L-L	25	2.9	-	200
GS2MLS24L-W	25	2.9	-	200
GS2MLS24R-L	25	2.9	-	200
GS2MLS24R-W	25	2.9	-	200

# WEIGHTS + CUBES

Silea  
02/24

model number	weight	cubes	#locks	page
GS2MLS30L-L	28	3.5	-	200
GS2MLS30L-W	28	3.5	-	200
GS2MLS30R-L	28	3.5	-	200
GS2MLS30R-W	28	3.5	-	200
GS2MLSJ24-L	20	1.5	-	202
GS2MLSJ24-W	20	1.5	-	202
GS2MLSP-L	9	0.9	-	202
GS2MLSPT-L	13	1.5	-	202
GS2MLSPT-W	13	1.5	-	202
GS2MLSP-W	9	0.9	-	202
GS2MPB9-L	5	0.8	-	201
GS2MPB9-W	5	0.8	-	201
GS2MPB15-L	7	1.2	-	201
GS2MPB15-W	7	1.2	-	201
GS2MPB18-L	11	1.4	-	201
GS2MPB18-W	11	1.4	-	201
GS2MPB30-L	14	2.2	-	201
GS2MPB30-W	14	2.2	-	201
GS2MPB36-L	17	2.6	-	201
GS2MPB36-W	17	2.6	-	201
GS2MPD-2LL	84	9.1	1	262
GS2MPD-2WW	84	9.1	1	262
GS2MPD-3LL	84	9.1	1	262
GS2MPD-3WW	84	9.1	1	262
GS2MPD-6LL	91	6.4	1	262
GS2MPD-6WW	91	6.4	1	262
GS2MPD-CUSH2215	7	1.0	-	263
GS2MPF-L	2	0.6	-	201
GS2MPF-W	2	0.6	-	201
GS2MSJ24-L	20	1.9	-	201
GS2MSJ24-W	20	1.9	-	201
GS2MSP-L	9	1.2	-	201
GS2MSPT-L	13	1.9	-	201
GS2MSPT-W	13	1.9	-	201
GS2MSP-W	9	1.2	-	201
GS2RLC6072L-L	149	18.4	-	75
GS2RLC6072L-S	163	18.4	-	75
GS2RLC6072L-W	156	13.5	-	75
GS2RLC6072R-L	149	18.4	-	75
GS2RLC6072R-S	163	18.4	-	75
GS2RLC6072R-W	156	13.5	-	75
GS2RLC6084L-L	171	21.1	-	75
GS2RLC6084L-S	183	21.1	-	75
GS2RLC6084L-W	180	15.4	-	75

model number	weight	cubes	#locks	page
GS2RLC6084R-L	171	21.1	-	75
GS2RLC6084R-S	183	21.1	-	75
GS2RLC6084R-W	180	15.4	-	75
GS2RLEL3672-L	104	13.3	-	69
GS2RLEL3672-S	175	13.3	-	69
GS2RLEL3672-W	108	10.2	-	69
GS2RLEL4284-L	133	16.9	-	69
GS2RLEL4284-S	190	16.9	-	69
GS2RLEL4284-W	139	12.8	-	69
GS2RLFL3672-L	104	13.3	-	71
GS2RLFL3672-S	175	13.3	-	71
GS2RLFL3672-W	108	10.2	-	71
GS2RLFL4284-L	133	16.9	-	71
GS2RLFL4284-S	190	16.9	-	71
GS2RLFL4284-W	139	12.8	-	71
GS2RLO3066L-3LL	160	13.7	1	54
GS2RLO3066L-3WW	160	13.7	1	54
GS2RLO3066R-3LL	160	13.7	1	54
GS2RLO3066R-3WW	160	13.7	1	54
GS2RLO3072L-3LL	167	14.3	1	54
GS2RLO3072L-3WW	167	14.3	1	54
GS2RLO3072R-3LL	167	14.3	1	54
GS2RLO3072R-3WW	167	14.3	1	54
GS2RLO3672L-3LL	189	16.8	1	54
GS2RLO3672L-3WW	189	16.8	1	54
GS2RLO3672R-3LL	189	16.8	1	54
GS2RLO3672R-3WW	189	16.8	1	54
GS2RLO3678L-3LL	196	17.5	1	54
GS2RLO3678L-3WW	196	17.5	1	54
GS2RLO3678R-3LL	196	17.5	1	54
GS2RLO3678R-3WW	196	17.5	1	54
GS2RLOS3066L-3LL	270	42.8	1	55
GS2RLOS3066L-3WW	196	16.0	1	55
GS2RLOS3066R-3LL	270	42.8	1	55
GS2RLOS3066R-3WW	196	16.0	1	55
GS2RLOS3072L-3LL	280	46.5	1	55
GS2RLOS3072L-3WW	202	16.5	1	55
GS2RLOS3072R-3LL	280	46.5	1	55
GS2RLOS3072R-3WW	202	16.5	1	55
GS2RLOS3672L-3LL	290	55.0	1	55
GS2RLOS3672L-3WW	228	19.5	1	55
GS2RLOS3672R-3LL	290	55.0	1	55
GS2RLOS3672R-3WW	228	19.5	1	55
GS2RLOS3678L-3LL	300	59.4	1	55

model number	weight	cubes	#locks	page
GS2RLOS3678L-3WW	235	20.1	1	55
GS2RLOS3678R-3LL	300	59.4	1	55
GS2RLOS3678R-3WW	235	20.1	1	55
GS2RLRL3066L-L	91	8.4	-	66
GS2RLRL3066L-W	91	8.4	-	66
GS2RLRL3066R-L	91	8.4	-	66
GS2RLRL3066R-W	91	8.4	-	66
GS2RLRL3072L-L	98	9.0	-	66
GS2RLRL3072L-W	98	9.0	-	66
GS2RLRL3072R-L	98	9.0	-	66
GS2RLRL3072R-W	98	9.0	-	66
GS2RLRL3672L-L	113	10.2	-	66
GS2RLRL3672L-W	113	10.2	-	66
GS2RLRL3672R-L	113	10.2	-	66
GS2RLRL3672R-W	113	10.2	-	66
GS2RLRL3678L-L	120	10.9	-	66
GS2RLRL3678L-W	120	10.9	-	66
GS2RLRL3678R-L	120	10.9	-	66
GS2RLRL3678R-W	120	10.9	-	66
GS2RLRLS3066L-L	127	10.5	-	67
GS2RLRLS3066L-W	127	10.7	-	67
GS2RLRLS3066R-L	127	10.5	-	67
GS2RLRLS3066R-W	127	10.7	-	67
GS2RLRLS3072L-L	133	11.0	-	67
GS2RLRLS3072L-W	133	11.2	-	67
GS2RLRLS3072R-L	133	11.0	-	67
GS2RLRLS3072R-W	133	11.2	-	67
GS2RLRLS3672L-L	152	12.7	-	67
GS2RLRLS3672L-W	152	12.9	-	67
GS2RLRLS3672R-L	152	12.7	-	67
GS2RLRLS3672R-W	152	12.9	-	67
GS2RLRLS3678L-L	159	13.3	-	67
GS2RLRLS3678L-W	159	13.5	-	67
GS2RLRLS3678R-L	159	13.3	-	67
GS2RLRLS3678R-W	159	13.5	-	67
GS2RLSL304272-L	118	14.9	-	73
GS2RLSL304272-S	189	14.9	-	73
GS2RLSL304272-W	123	11.4	-	73
GS2RLSL364884-L	148	18.7	-	73
GS2RLSL364884-S	235	18.7	-	73
GS2RLSL364884-W	154	14.1	-	73
GS2RLSLS304272L-L	149	16.7	-	74
GS2RLSLS304272L-W	154	13.4	-	74
GS2RLSLS304272R-L	149	16.7	-	74

model number	weight	cubes	#locks	page
GS2RLSLS304272R-W	154	13.4	-	74
GS2RLSLS364884L-L	190	21.6	-	74
GS2RLSLS364884L-W	196	17.2	-	74
GS2RLSLS364884R-L	190	21.6	-	74
GS2RLSLS364884R-W	196	17.2	-	74
GS2RMA21-L	23	3.9	-	209
GS2RMA21-W	23	3.9	-	209
GS2RMA24-L	25	4.3	-	209
GS2RMA24-W	25	4.3	-	209
GS2RMA27-L	27	4.8	-	209
GS2RMA27-W	27	4.8	-	209
GS2RMA30-L	29	5.3	-	209
GS2RMA30-W	29	5.3	-	209
GS2RMA33-L	31	5.8	-	209
GS2RMA33-W	31	5.8	-	209
GS2RMA36-L	33	6.3	-	209
GS2RMA36-W	33	6.3	-	209
GS2RMA39-L	35	6.8	-	209
GS2RMA39-W	35	6.8	-	209
GS2RMA42-L	37	7.2	-	209
GS2RMA42-W	37	7.2	-	209
GS2RMA45-L	39	7.7	-	209
GS2RMA45-W	39	7.7	-	209
GS2RMA48-L	41	8.2	-	209
GS2RMA48-W	41	8.2	-	209
GS2RMA51-L	43	8.7	-	209
GS2RMA51-W	43	8.7	-	209
GS2RMA54-L	45	11.3	-	209
GS2RMA54-W	45	11.3	-	209
GS2RMA57-L	47	11.9	-	209
GS2RMA57-W	47	11.9	-	209
GS2RMA60-L	49	12.4	-	209
GS2RMA60-W	49	12.4	-	209
GS2RMA63-L	51	13.0	-	209
GS2RMA63-W	51	13.0	-	209
GS2RMA66-L	53	13.6	-	209
GS2RMA66-W	53	13.6	-	209
GS2RMA69-L	55	14.2	-	209
GS2RMA69-W	55	14.2	-	209
GS2RMA72-L	57	14.8	-	209
GS2RMA72-W	57	14.8	-	209
GS2RMF39L-L	19	2.9	-	207
GS2RMF39L-W	19	2.9	-	207
GS2RMF39R-L	19	2.9	-	208

# WEIGHTS + CUBES

Silea  
02/24

model number	weight	cubes	#locks	page
GS2RMF39R-W	19	2.9	-	208
GS2RMF42L-L	20	3.1	-	207
GS2RMF42L-W	20	3.1	-	207
GS2RMF42R-L	20	3.1	-	208
GS2RMF42R-W	20	3.1	-	208
GS2RMF45L-L	21	3.3	-	207
GS2RMF45L-W	21	3.3	-	207
GS2RMF45R-L	21	3.3	-	208
GS2RMF45R-W	21	3.3	-	208
GS2RMF48L-L	23	3.5	-	207
GS2RMF48L-W	23	3.5	-	207
GS2RMF48R-L	23	3.5	-	208
GS2RMF48R-W	23	3.5	-	208
GS2RMF51L-L	24	3.7	-	207
GS2RMF51L-W	24	3.7	-	207
GS2RMF51R-L	24	3.7	-	208
GS2RMF51R-W	24	3.7	-	208
GS2RMF54L-L	26	3.9	-	207
GS2RMF54L-W	26	3.9	-	207
GS2RMF54R-L	26	3.9	-	208
GS2RMF54R-W	26	3.9	-	208
GS2RMF57L-L	27	4.1	-	207
GS2RMF57L-W	27	4.1	-	207
GS2RMF57R-L	27	4.1	-	208
GS2RMF57R-W	27	4.1	-	208
GS2RMF60L-L	29	4.3	-	207
GS2RMF60L-W	29	4.3	-	207
GS2RMF60R-L	29	4.3	-	208
GS2RMF60R-W	29	4.3	-	208
GS2RMF63L-L	31	3.7	-	207
GS2RMF63L-W	31	3.7	-	207
GS2RMF63R-L	31	3.7	-	208
GS2RMF63R-W	31	3.7	-	208
GS2RMF66L-L	33	3.9	-	207
GS2RMF66L-W	33	3.9	-	207
GS2RMF66R-L	33	3.9	-	208
GS2RMF66R-W	33	3.9	-	208
GS2RMF69L-L	35	4.1	-	207
GS2RMF69L-W	35	4.1	-	207
GS2RMF69R-L	35	4.1	-	208
GS2RMF69R-W	35	4.1	-	208
GS2RMF72L-L	37	4.2	-	207
GS2RMF72L-W	37	4.2	-	207
GS2RMF72R-L	37	4.2	-	208

model number	weight	cubes	#locks	page
GS2RMF72R-W	37	4.2	-	208
GS2RMF75L-L	39	4.4	-	207
GS2RMF75L-W	39	4.4	-	207
GS2RMF75R-L	39	4.4	-	208
GS2RMF75R-W	39	4.4	-	208
GS2RMF78L-L	41	4.6	-	207
GS2RMF78L-W	41	4.6	-	207
GS2RMF78R-L	41	4.6	-	208
GS2RMF78R-W	41	4.6	-	208
GS2RMF81L-L	43	4.7	-	207
GS2RMF81L-W	43	4.7	-	207
GS2RMF81R-L	43	4.7	-	208
GS2RMF81R-W	43	4.7	-	208
GS2RMF84L-L	45	4.9	-	207
GS2RMF84L-W	45	4.9	-	207
GS2RMF84R-L	45	4.9	-	208
GS2RMF84R-W	45	4.9	-	208
GS2RMF87L-L	47	5.1	-	207
GS2RMF87L-W	47	5.1	-	207
GS2RMF87R-L	47	5.1	-	208
GS2RMF87R-W	47	5.1	-	208
GS2RMF90L-L	49	5.2	-	207
GS2RMF90L-W	49	5.2	-	207
GS2RMF90R-L	49	5.2	-	208
GS2RMF90R-W	49	5.2	-	208
GS2RNDCOLUMN	10	0.6	-	157
GS2RRL3048-L	65	6.1	-	65
GS2RRL3048-W	65	6.1	-	65
GS2RRL3054-L	71	6.6	-	65
GS2RRL3054-W	75	7.1	-	65
GS2RRL3654-L	81	7.4	-	65
GS2RRL3654-W	85	7.9	-	65
GS2RRL3660-L	88	8.0	-	65
GS2RRL3660-W	92	8.5	-	65
GS2RRMF42L-L	23	4.5	-	163
GS2RRMF42L-W	23	4.5	-	163
GS2RRMF42R-L	23	4.5	-	163
GS2RRMF42R-W	23	4.5	-	163
GS2RRMF48L-L	26	5.1	-	163
GS2RRMF48L-W	26	5.1	-	163
GS2RRMF48R-L	26	5.1	-	163
GS2RRMF48R-W	26	5.1	-	163
GS2RRMF54L-L	29	5.8	-	163
GS2RRMF54L-W	29	5.8	-	163

model number	weight	cubes	#locks	page
GS2RRMF54R-L	29	5.8	-	163
GS2RRMF54R-W	29	5.8	-	163
GS2RRMF60L-L	33	6.4	-	163
GS2RRMF60L-W	33	6.4	-	163
GS2RRMF60R-L	33	6.4	-	163
GS2RRMF60R-W	33	6.4	-	163
GS2RRMF66L-L	36	7.1	-	163
GS2RRMF66L-W	36	7.1	-	163
GS2RRMF66R-L	36	7.1	-	163
GS2RRMF66R-W	36	7.1	-	163
GS2RRMF72L-L	39	7.7	-	163
GS2RRMF72L-W	39	7.7	-	163
GS2RRMF72R-L	39	7.7	-	163
GS2RRMF72R-W	39	7.7	-	163
GS2RRO3048L-3LL	136	12.6	1	53
GS2RRO3048L-3WW	141	12.6	1	53
GS2RRO3048R-3LL	136	12.6	1	53
GS2RRO3048R-3WW	141	12.6	1	53
GS2RRO3054L-3LL	143	13.2	1	53
GS2RRO3054L-3WW	148	13.2	1	53
GS2RRO3054R-3LL	143	13.2	1	53
GS2RRO3054R-3WW	148	13.2	1	53
GS2RRO3654L-3LL	160	15.3	1	53
GS2RRO3654L-3WW	165	15.4	1	53
GS2RRO3654R-3LL	160	15.3	1	53
GS2RRO3654R-3WW	165	15.4	1	53
GS2RRO3660L-3LL	168	16.1	1	53
GS2RRO3660L-3WW	173	16.1	1	53
GS2RRO3660R-3LL	168	16.1	1	53
GS2RRO3660R-3WW	173	16.1	1	53
GS2RROF3048L-3LL	154	17.6	-	64
GS2RROF3048L-3WW	154	17.6	-	64
GS2RROF3048R-3LL	154	17.6	-	64
GS2RROF3048R-3WW	154	17.6	-	64
GS2RROF3054L-3LL	163	18.7	-	64
GS2RROF3054L-3WW	163	18.7	-	64
GS2RROF3054R-3LL	163	18.7	-	64
GS2RROF3054R-3WW	163	18.7	-	64
GS2RROF3654L-3LL	194	21.7	-	64
GS2RROF3654L-3WW	194	21.7	-	64
GS2RROF3654R-3LL	194	21.7	-	64
GS2RROF3654R-3WW	194	21.7	-	64
GS2RROF3660L-3LL	205	23.0	-	64
GS2RROF3660L-3WW	205	23.0	-	64

model number	weight	cubes	#locks	page
GS2RROF3660R-3LL	205	23.0	-	64
GS2RROF3660R-3WW	205	23.0	-	64
GS2RSL304254-L	82	10.9	-	72
GS2RSL304254-W	86	8.2	-	72
GS2RSL364866-L	113	14.7	-	72
GS2RSL364866-W	118	11.0	-	72
GS2RTN2442L-2LL	140	14.4	2	60
GS2RTN2442L-2WW	140	14.4	2	60
GS2RTN2442R-2LL	140	14.4	2	60
GS2RTN2442R-2WW	140	14.4	2	60
GS2RTN2448L-2LL	148	15.2	2	60
GS2RTN2448L-2WW	148	15.2	2	60
GS2RTN2448R-2LL	148	15.2	2	60
GS2RTN2448R-2WW	148	15.2	2	60
GS2RTN2454L-2LL	155	16.0	2	60
GS2RTN2454L-2WW	155	16.0	2	60
GS2RTN2454R-2LL	155	16.0	2	60
GS2RTN2454R-2WW	155	16.0	2	60
GS2RTN2460L-2LL	162	16.8	2	60
GS2RTN2460L-2WW	162	16.8	2	60
GS2RTN2460R-2LL	162	16.8	2	60
GS2RTN2460R-2WW	162	16.8	2	60
GS2SBD5H15-3LN	160	22.5	1	248
GS2SBD5H15-3WN	160	22.5	1	248
GS2SBD5H15L-3LL	167	22.5	2	246
GS2SBD5H15L-3WW	167	22.5	2	246
GS2SBD5H15L-LL	167	22.5	2	245
GS2SBD5H15-LN	160	22.5	1	247
GS2SBD5H15L-WW	167	22.5	2	245
GS2SBD5H15R-3LL	167	22.5	2	246
GS2SBD5H15R-3WW	167	22.5	2	246
GS2SBD5H15R-LL	167	22.5	2	245
GS2SBD5H15R-WW	167	22.5	2	245
GS2SBD5H15-WN	160	22.5	1	247
GS2SBD5H18-3LN	170	26.0	1	248
GS2SBD5H18-3WN	170	26.0	1	248
GS2SBD5H18L-3LL	175	26.0	2	246
GS2SBD5H18L-3WW	175	26.0	2	246
GS2SBD5H18L-LL	175	23.5	1	245
GS2SBD5H18-LN	165	23.5	-	247
GS2SBD5H18L-WW	175	23.5	1	245
GS2SBD5H18R-3LL	175	26.0	2	246
GS2SBD5H18R-3WW	175	26.0	2	246
GS2SBD5H18R-LL	175	23.5	1	245

# WEIGHTS + CUBES

Silea  
02/24

model number	weight	cubes	#locks	page
GS2SBD5H18R-WW	175	23.5	1	245
GS2SBD5H18-WN	165	23.5	-	247
GS2SBD5H30D18-3LN	180	31.6	1	252
GS2SBD5H30D18-3WN	180	31.6	1	252
GS2SBD5H30D18L-3LL	185	31.6	2	251
GS2SBD5H30D18L-3WW	185	31.6	2	251
GS2SBD5H30D18L-LL	185	31.6	2	249
GS2SBD5H30D18-LN	180	31.6	1	250
GS2SBD5H30D18L-WW	185	31.6	2	249
GS2SBD5H30D18R-3LL	185	31.6	2	251
GS2SBD5H30D18R-3WW	185	31.6	2	251
GS2SBD5H30D18R-LL	185	31.6	2	249
GS2SBD5H30D18R-WW	185	31.6	2	249
GS2SBD5H30D18-WN	180	31.6	1	250
GS2SBD5H30-LL	297	36.9	2	245
GS2SBD5H30-LN	282	36.9	-	247
GS2SBD5H30-WN	282	36.9	-	247
GS2SBD5H30-WW	297	36.9	2	245
GS2SBD6H15-3LN	190	26.5	1	248
GS2SBD6H15-3WN	190	26.5	1	248
GS2SBD6H15L-3LL	197	26.5	2	246
GS2SBD6H15L-3WW	197	26.5	2	246
GS2SBD6H15L-LL	197	26.5	2	245
GS2SBD6H15-LN	190	26.5	1	247
GS2SBD6H15L-WW	197	26.5	2	245
GS2SBD6H15R-3WW	197	26.5	2	246
GS2SBD6H15R-LL	197	26.5	2	245
GS2SBD6H15R-WW	197	26.5	2	245
GS2SBD6H15-WN	190	26.5	1	247
GS2SBD6H18-3LN	200	30.7	1	248
GS2SBD6H18-3WN	200	30.7	1	248
GS2SBD6H18L-3LL	205	30.7	2	246
GS2SBD6H18L-3WW	205	30.7	2	246
GS2SBD6H18L-LL	205	27.9	1	245
GS2SBD6H18-LN	195	27.9	-	247
GS2SBD6H18L-WW	205	27.9	1	245
GS2SBD6H18R-3LL	205	30.7	2	246
GS2SBD6H18R-3WW	205	30.7	2	246
GS2SBD6H18R-LL	205	27.9	1	245
GS2SBD6H18R-WW	205	27.9	1	245
GS2SBD6H18-WN	195	27.9	-	247
GS2SBD6H30D18-3LN	210	37.2	1	252
GS2SBD6H30D18-3WN	210	37.2	1	252

model number	weight	cubes	#locks	page
GS2SBD6H30D18L-3LL	215	37.2	2	251
GS2SBD6H30D18L-3WW	215	37.2	2	251
GS2SBD6H30D18L-LL	215	37.2	2	249
GS2SBD6H30D18-LN	210	37.2	1	250
GS2SBD6H30D18L-WW	215	37.2	2	249
GS2SBD6H30D18R-3LL	215	37.2	2	251
GS2SBD6H30D18R-3WW	215	37.2	2	251
GS2SBD6H30D18R-LL	215	37.2	2	249
GS2SBD6H30D18R-WW	215	37.2	2	249
GS2SBD6H30D18-WN	210	37.2	1	250
GS2SBD6H30-LL	343	43.8	2	245
GS2SBD6H30-LN	328	43.8	-	247
GS2SBD6H30-WN	328	43.8	-	247
GS2SBD6H30-WW	343	43.8	2	245
GS2SCF2H30-5LL	123	16.8	1	257
GS2SCF2H30-5WW	123	16.8	1	257
GS2SCF2H36-5LL	143	19.8	1	257
GS2SCF2H36-5WW	143	19.8	1	257
GS2SDMF1560L-L	57	3.2	-	162
GS2SDMF1560L-W	57	3.2	-	162
GS2SDMF1560R-L	57	3.2	-	162
GS2SDMF1560R-W	57	3.2	-	162
GS2SDMF1566L-L	63	3.9	-	162
GS2SDMF1566L-W	63	3.9	-	162
GS2SDMF1566R-L	63	3.9	-	162
GS2SDMF1566R-W	63	3.9	-	162
GS2SDMF1572L-L	68	4.5	-	162
GS2SDMF1572L-W	68	4.5	-	162
GS2SDMF1572R-L	68	4.5	-	162
GS2SDMF1572R-W	68	4.5	-	162
GS2SDMF1578L-L	74	5.1	-	162
GS2SDMF1578L-W	74	5.1	-	162
GS2SDMF1578R-L	74	5.1	-	162
GS2SDMF1578R-W	74	5.1	-	162
GS2SDMF1584L-L	80	5.8	-	162
GS2SDMF1584L-W	80	5.8	-	162
GS2SDMF1584R-L	80	5.8	-	162
GS2SDMF1584R-W	80	5.8	-	162
GS2SDMF1590L-L	74	4.7	-	162
GS2SDMF1590L-W	74	5.0	-	162
GS2SDMF1590R-L	74	4.7	-	162
GS2SDMF1590R-W	74	5.0	-	162
GS2SDMF1596L-L	77	5.2	-	162



model number	weight	cubes	#locks	page
GS2SDF1596L-W	77	5.4	-	162
GS2SDF1596R-L	77	5.2	-	162
GS2SDF1596R-W	77	5.4	-	162
GS2SGTOPD3018-L	16	1.8	-	264
GS2SGTOPD3018-W	16	1.8	-	264
GS2SGTOPN3018-L	16	1.8	-	265
GS2SGTOPN3018-W	16	1.8	-	265
GS2SMC1H60-LL	120	27.3	2	304
GS2SMC1H60-LN	110	27.4	-	306
GS2SMC1H60-WG	120	27.3	-	305
GS2SMC1H60-WN	110	27.4	-	306
GS2SMC1H60-WW	120	27.3	2	304
GS2SMC1H66-LL	130	29.9	2	304
GS2SMC1H66-LN	120	30.0	-	306
GS2SMC1H66-WN	120	30.0	-	306
GS2SMC1H66-WW	130	29.9	2	304
GS2SMC1H72-LL	140	32.5	2	304
GS2SMC1H72-LN	130	32.6	-	306
GS2SMC1H72-WG	140	32.5	-	305
GS2SMC1H72-WN	130	32.6	-	306
GS2SMC1H72-WW	140	32.5	2	304
GS2SMC1H78-LL	148	35.1	2	304
GS2SMC1H78-LN	138	35.2	-	306
GS2SMC1H78-WN	138	35.2	-	306
GS2SMC1H78-WW	148	35.1	2	304
GS2SMC1H84-LL	167	37.7	3	304
GS2SMC1H84-LN	157	37.8	-	306
GS2SMC1H84-WN	157	37.8	-	306
GS2SMC1H84-WW	167	37.7	3	304
GS2SMC1H90-LL	175	40.3	3	304
GS2SMC1H90-LN	165	40.4	-	306
GS2SMC1H90-WG	175	40.3	-	305
GS2SMC1H90-WN	165	40.4	-	306
GS2SMC1H90-WW	175	40.3	3	304
GS2SMC1H96-LL	183	42.9	3	304
GS2SMC1H96-LN	173	43.0	-	306
GS2SMC1H96-WN	173	43.0	-	306
GS2SMC1H96-WW	183	42.9	3	304
GS2SMC1H102-LL	191	47.9	3	304
GS2SMC1H102-LN	181	45.6	-	306
GS2SMC1H102-WN	181	45.6	-	306
GS2SMC1H102-WW	191	45.5	3	304
GS2SMC1H108-LL	200	50.6	3	304
GS2SMC1H108-LN	190	48.2	-	306

model number	weight	cubes	#locks	page
GS2SMC1H108-WG	200	48.1	-	305
GS2SMC1H108-WN	190	48.2	-	306
GS2SMC1H108-WW	200	48.1	3	304
GS2SMC2H60-WG	180	35.9	-	308
GS2SMC2H60-WW	180	35.9	2	307
GS2SMC2H66-WW	195	39.4	2	307
GS2SMC2H72-WG	210	42.8	2	308
GS2SMC2H72-WW	210	42.8	-	307
GS2SMC2H78-WW	225	46.2	2	307
GS2SMC2H84-WW	245	49.6	3	307
GS2SMC2H90-WG	265	53.1	-	308
GS2SMC2H90-WW	265	53.1	3	307
GS2SMTOPN30-L	14	1.4	-	265, 316
GS2SMTOPN30-W	14	1.4	-	265, 316
GS2SMTOPN36-L	17	1.7	-	265, 316
GS2SMTOPN36-W	17	1.7	-	265, 316
GS2SMTOPN60-L	28	2.7	-	265, 316
GS2SMTOPN60-W	28	2.7	-	265, 316
GS2SMTOPN72-L	33	3.2	-	265, 316
GS2SMTOPN72-W	33	3.2	-	265, 316
GS2SMTOPN90-L	41	4.0	-	265, 316
GS2SMTOPN90-W	41	4.0	-	265, 316
GS2SMTOPN108-L	50	4.8	-	265, 316
GS2SMTOPN108-W	50	4.8	-	265, 316
GS2SPC2466L-2LL	174	17.6	1	57
GS2SPC2466L-2WW	174	17.6	1	57
GS2SPC2466R-2LL	174	17.6	1	57
GS2SPC2466R-2WW	174	17.6	1	57
GS2SPC2472L-2LL	181	18.4	1	57
GS2SPC2472L-2WW	181	18.4	1	57
GS2SPC2472L-4LL	213	25.4	1	57
GS2SPC2472L-4WW	213	25.4	1	57
GS2SPC2472R-2LL	181	18.4	1	57
GS2SPC2472R-2WW	181	18.4	1	57
GS2SPC2472R-4LL	213	25.4	1	57
GS2SPC2472R-4WW	213	25.4	1	57
GS2SPC2478L-4LL	221	26.2	1	57
GS2SPC2478L-4WW	221	26.2	1	57
GS2SPC2478R-4LL	221	26.2	1	57
GS2SPC2478R-4WW	221	26.2	1	57
GS2SPC2484L-4LL	229	27.0	1	57
GS2SPC2484L-4WW	229	27.0	1	57
GS2SPC2484R-4LL	229	27.0	1	57
GS2SPC2484R-4WW	229	27.0	1	57

# WEIGHTS + CUBES

Silea  
02/24

model number	weight	cubes	#locks	page
GS2SPC2490L-4LL	237	27.8	1	57
GS2SPC2490L-4WW	237	27.8	1	57
GS2SPC2490R-4LL	237	27.8	1	57
GS2SPC2490R-4WW	237	27.8	1	57
GS2SPC2496L-4LL	244	28.6	1	57
GS2SPC2496L-4WW	244	28.6	1	57
GS2SPC2496R-4LL	244	28.6	1	57
GS2SPC2496R-4WW	244	28.6	1	57
GS2SRNCLEG-W	20	0.6	-	158
GS2STF1H15L-LL	58	8.2	1	309
GS2STF1H15L-WG	58	8.2	-	310
GS2STF1H15L-WW	58	8.2	1	309
GS2STF1H15R-LL	58	8.2	1	309
GS2STF1H15R-WG	58	8.2	-	310
GS2STF1H15R-WW	58	8.2	1	309
GS2STF1H18L-LL	65	9.1	1	309
GS2STF1H18L-WG	65	9.1	-	310
GS2STF1H18L-WW	65	9.1	1	309
GS2STF1H18R-LL	65	9.1	1	309
GS2STF1H18R-WG	65	9.1	-	310
GS2STF1H18R-WW	65	9.1	1	309
GS2STF1H30-LL	100	14.3	1	309
GS2STF1H30-WG	100	14.3	-	310
GS2STF1H30-WW	100	14.3	1	309
GS2STF1H36-LL	115	16.9	1	309
GS2STF1H36-WG	115	16.9	-	310
GS2STF1H36-WW	115	16.9	1	309
GS2STF2H15L-LL	83	10.8	1	312
GS2STF2H15L-WG	83	10.8	-	313
GS2STF2H15L-WW	83	10.8	1	312
GS2STF2H15R-LL	83	10.8	1	312
GS2STF2H15R-WG	83	10.8	-	313
GS2STF2H15R-WW	83	10.8	1	312
GS2STF2H18L-LL	90	12.0	1	312
GS2STF2H18L-WG	90	12.0	-	313
GS2STF2H18L-WW	90	12.0	1	312
GS2STF2H18R-LL	90	12.0	1	312
GS2STF2H18R-WG	90	12.0	-	313
GS2STF2H18R-WW	90	12.0	1	312
GS2STF2H30-LL	125	18.9	1	312
GS2STF2H30-WG	125	18.9	-	313
GS2STF2H30-WW	125	18.9	1	312
GS2STF2H36-LL	150	22.3	1	312
GS2STF2H36-WG	150	22.3	-	313

model number	weight	cubes	#locks	page
GS2STF2H36-WW	150	22.3	1	312
GS2STN1H15-LN	50	7.8	-	311
GS2STN1H15-WN	50	7.8	-	311
GS2STN1H18-LN	55	9.1	-	311
GS2STN1H18-WN	55	9.1	-	311
GS2STN1H30-LN	90	9.1	-	311
GS2STN1H30-WN	90	14.3	-	311
GS2STN1H36-LN	100	14.3	-	311
GS2STN1H36-WN	100	16.9	-	311
GS2STN2H15-LN	60	10.3	-	314
GS2STN2H15-WN	60	10.3	-	314
GS2STN2H18-LN	65	12.0	-	314
GS2STN2H18-WN	65	12.0	-	314
GS2STN2H30-LN	100	12.0	-	314
GS2STN2H30-WN	100	12.0	-	314
GS2STN2H36-LN	110	18.9	-	314
GS2STN2H36-WN	110	18.9	-	314
GS2TEL3672-L	108	14.2	-	68
GS2TEL3672-S	179	14.2	-	68
GS2TEL3672-W	112	11.1	-	68
GS2TEL4284-L	135	17.6	-	68
GS2TEL4284-S	197	18.3	-	68
GS2TEL4284-W	146	14.2	-	68
GS2TFL3672-L	113	14.8	-	70
GS2TFL3672-S	184	14.8	-	70
GS2TFL3672-W	117	11.7	-	70
GS2TFL4284-L	140	18.3	-	70
GS2TFL4284-S	197	18.3	-	70
GS2TFL4284-W	146	14.2	-	70
GS2TGW1H24-GSA	35	2.1	-	285
GS2TGW1H30-GSA	43	3.2	-	285
GS2TGW1H36-GSA	50	3.8	-	285
GS2TGW1H42-GSA	58	4.3	-	285
GS2TGW1H48-GSA	66	4.9	-	285
GS2TGW2H24-GSA	41	2.8	-	285
GS2TGW2H30-GSA	50	4.1	-	285
GS2TGW2H36-GSA	59	4.8	-	285
GS2TGW2H42-GSA	67	5.6	-	285
GS2TGW2H48-GSA	76	6.3	-	285
GS2TGW24-GSA	24	1.4	-	281
GS2TGW30-GSA	28	2.1	-	281
GS2TGW36-GSA	32	2.4	-	281
GS2TGW42-GSA	36	2.8	-	281
GS2TGW48-GSA	40	3.2	-	281

model number	weight	cubes	#locks	page
GS2TGW54-GSA	45	3.6	-	281
GS2TGW60-GSA	50	3.9	-	281
GS2TGW66-GSA	55	4.3	-	281
GS2TGW72-GSA	59	4.7	-	281
GS2TGW78-GSA	64	5.1	-	281
GS2TGW84-GSA	68	5.4	-	281
GS2TGW90-GSA	73	5.8	-	281
GS2TGW96-GSA	77	3.2	-	281
GS2TGW102-GSA	82	3.4	-	281
GS2TGW108-GSA	86	3.6	-	281
GS2TKFBX72	28	5.0	-	320
GS2TKFBX90	35	6.2	-	320
GS2TKS60	26	3.7	-	315
GS2TKS66	28	4.0	-	315
GS2TKS72	29	4.4	-	315
GS2TKS78	31	4.8	-	315
GS2TKS84	33	5.1	-	315
GS2TKS90	34	5.5	-	315
GS2TKS96	36	5.8	-	315
GS2TKS102	37	3.3	-	315
GS2TKS108	39	3.4	-	315
GS2TKW1H24	20	2.1	-	284
GS2TKW1H30	24	3.2	-	284
GS2TKW1H36	27	3.8	-	284
GS2TKW1H42	29	4.3	-	284
GS2TKW1H48	32	4.9	-	284
GS2TKW2H24	23	2.8	-	284
GS2TKW2H30	26	4.1	-	284
GS2TKW2H36	29	4.8	-	284
GS2TKW2H42	33	5.6	-	284
GS2TKW2H48	36	6.3	-	284
GS2TKW24	16	1.4	-	280
GS2TKW30	18	2.1	-	280
GS2TKW36	20	2.4	-	280
GS2TKW42	21	2.8	-	280
GS2TKW48	22	3.2	-	280
GS2TKW54	24	3.6	-	280
GS2TKW60	26	3.9	-	280
GS2TKW66	28	4.3	-	280
GS2TKW72	29	4.7	-	280
GS2TKW78	31	5.1	-	280
GS2TKW84	33	5.4	-	280
GS2TKW90	34	5.8	-	280
GS2TKW96	36	6.2	-	280

model number	weight	cubes	#locks	page
GS2TKW102	37	3.4	-	280
GS2TKW108	39	3.6	-	280
GS2TKWSB36	14	3.2	-	320
GS2TKWSB45	17	4.0	-	320
GS2TKWSB72	28	5.0	-	320
GS2TKWSB90	35	6.2	-	320
GS2TLGW1H24-GSA	40	2.5	-	287
GS2TLGW1H30-GSA	49	3.6	-	287
GS2TLGW1H36-GSA	58	4.3	-	287
GS2TLGW1H42-GSA	67	5.0	-	287
GS2TLGW1H48-GSA	75	5.6	-	287
GS2TLGW2H24-GSA	46	3.1	-	287
GS2TLGW2H30-GSA	56	4.6	-	287
GS2TLGW2H36-GSA	66	5.5	-	287
GS2TLGW2H42-GSA	76	6.3	-	287
GS2TLGW2H48-GSA	86	7.2	-	287
GS2TLGW24-GSA	29	1.8	-	283
GS2TLGW30-GSA	34	2.6	-	283
GS2TLGW36-GSA	39	3.1	-	283
GS2TLGW42-GSA	45	3.5	-	283
GS2TLGW48-GSA	50	4.0	-	283
GS2TLGW54-GSA	56	4.5	-	283
GS2TLGW60-GSA	62	4.9	-	283
GS2TLGW66-GSA	68	5.4	-	283
GS2TLGW72-GSA	74	5.9	-	283
GS2TLGW78-GSA	79	6.3	-	283
GS2TLGW84-GSA	85	6.8	-	283
GS2TLGW90-GSA	91	7.3	-	283
GS2TLGW96-GSA	97	4.0	-	283
GS2TLGW102-GSA	102	4.2	-	283
GS2TLGW108-GSA	108	4.5	-	283
GS2TLKW1H24	23	2.5	-	286
GS2TLKW1H30	26	3.6	-	286
GS2TLKW1H36	29	4.3	-	286
GS2TLKW1H42	33	5.0	-	286
GS2TLKW1H48	36	5.6	-	286
GS2TLKW2H24	24	3.1	-	286
GS2TLKW2H30	28	4.6	-	286
GS2TLKW2H36	32	5.5	-	286
GS2TLKW2H42	36	6.3	-	286
GS2TLKW2H48	40	7.2	-	286
GS2TLKW24	18	1.8	-	282
GS2TLKW30	20	2.6	-	282
GS2TLKW36	22	3.1	-	282

# WEIGHTS + CUBES

Silea  
02/24

model number	weight	cubes	#locks	page
GS2TLKW42	24	3.5	-	282
GS2TLKW48	26	4.0	-	282
GS2TLKW54	28	4.5	-	282
GS2TLKW60	31	4.9	-	282
GS2TLKW66	33	5.4	-	282
GS2TLKW72	35	5.9	-	282
GS2TLKW78	37	6.3	-	282
GS2TLKW84	39	6.8	-	282
GS2TLKW90	41	7.3	-	282
GS2TLKW96	43	7.8	-	282
GS2TLKW102	45	4.2	-	282
GS2TLKW108	47	4.5	-	282
GS2TLWD1H24-W	60	3.4	-	297
GS2TLWD1H30-W	73	3.5	-	297
GS2TLWD1H36-W	85	4.2	-	297
GS2TLWD1H42-W	96	4.8	-	297
GS2TLWD1H48-W	108	5.4	-	297
GS2TLWD1H54-W	130	5.4	-	297
GS2TLWD1H60-W	140	6.0	-	297
GS2TLWD1H66-W	150	6.5	-	297
GS2TLWD1H72-W	175	7.0	-	297
GS2TLWD1H78-W	190	7.5	-	297
GS2TLWD1H84-W	205	8.1	-	297
GS2TLWD1H90-W	215	8.6	-	297
GS2TLWD1H96-W	225	9.1	-	297
GS2TLWD1H102-W	240	9.6	-	297
GS2TLWD1H108-W	270	9.4	-	297
GS2TLWD2H24-W	70	4.4	-	298
GS2TLWD2H30-W	73	4.5	-	298
GS2TLWD2H36-W	85	5.3	-	298
GS2TLWD2H42-W	96	6.1	-	298
GS2TLWD2H48-W	108	6.9	-	298
GS2TLWD2H54-W	150	6.9	-	298
GS2TLWD2H60-W	160	7.6	-	298
GS2TLWD2H66-W	170	8.2	-	298
GS2TLWD2H72-W	195	8.9	-	298
GS2TLWD2H78-W	210	9.6	-	298
GS2TLWD2H84-W	225	10.2	-	298
GS2TLWD2H90-W	240	10.9	-	298
GS2TLWD2H96-W	255	11.6	-	298
GS2TLWD2H102-W	270	12.2	-	298
GS2TLWD2H108-W	295	11.9	-	298
GS2TLWD24-W	23	2.5	-	294
GS2TLWD30-W	26	2.5	-	294

model number	weight	cubes	#locks	page
GS2TLWD30-XL	21	2.7	-	293
GS2TLWD30-XW	26	2.5	-	293
GS2TLWD36-W	29	3.0	-	294
GS2TLWD36-XL	25	3.2	-	293
GS2TLWD36-XW	29	3.0	-	293
GS2TLWD42-W	33	3.4	-	294
GS2TLWD42-XL	33	3.4	-	293
GS2TLWD42-XW	33	3.4	-	293
GS2TLWD48-W	36	3.9	-	294
GS2TLWD48-XL	36	3.9	-	293
GS2TLWD48-XW	36	3.9	-	293
GS2TLWD54-W	39	4.3	-	294
GS2TLWD54-XL	39	4.3	-	293
GS2TLWD54-XW	39	4.3	-	293
GS2TLWD60-W	42	4.8	-	294
GS2TLWD60-XL	41	5.1	-	293
GS2TLWD60-XW	42	4.8	-	293
GS2TLWD66-W	45	5.2	-	294
GS2TLWD66-XL	45	5.6	-	293
GS2TLWD66-XW	45	5.2	-	293
GS2TLWD72-W	48	5.7	-	294
GS2TLWD72-XL	49	6.1	-	293
GS2TLWD72-XW	48	5.7	-	293
GS2TLWD78-W	51	6.1	-	294
GS2TLWD78-XL	54	6.6	-	293
GS2TLWD78-XW	51	6.1	-	293
GS2TLWD84-W	54	6.6	-	294
GS2TLWD84-XL	58	7.0	-	293
GS2TLWD84-XW	54	6.6	-	293
GS2TLWD90-W	57	7.1	-	294
GS2TLWD90-XL	62	7.5	-	293
GS2TLWD90-XW	57	7.1	-	293
GS2TLWD96-W	60	7.5	-	294
GS2TLWD96-XL	66	8.0	-	293
GS2TLWD96-XW	60	7.5	-	293
GS2TLWD102-W	63	8.0	-	294
GS2TLWD102-XL	70	4.2	-	293
GS2TLWD102-XW	63	8.0	-	293
GS2TLWD108-W	67	8.4	-	294
GS2TLWD108-XL	74	4.5	-	293
GS2TLWD108-XW	67	8.4	-	293
GS2TRD36-L	45	3.7	-	213
GS2TRD36-S	68	3.7	-	213
GS2TRD36-W	45	3.7	-	213

model number	weight	cubes	#locks	page
GS2TRD42-L	59	4.9	-	213
GS2TRD42-S	89	4.9	-	213
GS2TRD42-W	59	4.9	-	213
GS2TRD48-L	76	6.3	-	213
GS2TRD48-S	114	6.3	-	213
GS2TRD48-W	76	6.3	-	213
GS2TRD54-L	95	7.9	-	213
GS2TRD54-S	143	7.9	-	213
GS2TRD54-W	95	7.9	-	213
GS2TRD60-L	116	9.6	-	213
GS2TRD60-S	174	9.6	-	213
GS2TRD60-W	116	9.6	-	213
GS2TRL3066-L	102	10.0	-	61
GS2TRL3066-W	102	10.0	-	61
GS2TRL3072-L	109	10.6	-	61
GS2TRL3072-W	109	10.6	-	61
GS2TRL3672-L	122	11.7	-	61
GS2TRL3672-W	122	11.7	-	61
GS2TRL3678-L	129	12.4	-	61
GS2TRL3678-W	129	12.4	-	61
GS2TSTG36-L	45	3.7	-	214
GS2TSTG36-S	68	3.7	-	214
GS2TSTG36-W	45	3.7	-	214
GS2TSTG42-L	59	4.9	-	214
GS2TSTG42-S	89	4.9	-	214
GS2TSTG42-W	59	4.9	-	214
GS2TSTG48-L	76	6.3	-	214
GS2TSTG48-S	114	6.3	-	214
GS2TSTG48-W	76	6.3	-	214
GS2TTGW24-GSA	35	2.1	-	289
GS2TTGW30-GSA	43	2.5	-	289
GS2TTGW36-GSA	50	3.0	-	289
GS2TTGW42-GSA	58	3.4	-	289
GS2TTGW48-GSA	66	3.9	-	289
GS2TTGW54-GSA	82	3.9	-	289
GS2TTGW60-GSA	90	4.2	-	289
GS2TTGW66-GSA	98	4.6	-	289
GS2TTGW72-GSA	106	5.0	-	289
GS2TTGW78-GSA	114	5.4	-	289
GS2TTGW84-GSA	122	5.7	-	289
GS2TTGW90-GSA	130	6.1	-	289
GS2TTGW96-GSA	138	6.5	-	289
GS2TTGW102-GSA	150	7.6	-	289
GS2TTGW108-GSA	158	8.0	-	289

model number	weight	cubes	#locks	page
GS2TTKW24	19	2.1	-	288
GS2TTKW30	21	2.5	-	288
GS2TTKW36	23	3.0	-	288
GS2TTKW42	25	3.4	-	288
GS2TTKW48	27	3.9	-	288
GS2TTKW54	30	3.9	-	288
GS2TTKW60	32	4.2	-	288
GS2TTKW66	34	4.6	-	288
GS2TTKW72	36	5.0	-	288
GS2TTKW78	38	5.4	-	288
GS2TTKW84	40	5.7	-	288
GS2TTKW90	42	6.1	-	288
GS2TTKW96	44	6.5	-	288
GS2TTKW102	47	7.6	-	288
GS2TTKW108	50	8.0	-	288
GS2TTWD24-W	52	2.9	-	299
GS2TTWD30-W	60	3.6	-	299
GS2TTWD36-W	70	4.2	-	299
GS2TTWD42-W	80	4.8	-	299
GS2TTWD48-W	100	5.4	-	299
GS2TTWD54-W	120	4.6	-	299
GS2TTWD60-W	140	5.1	-	299
GS2TTWD66-W	150	5.5	-	299
GS2TTWD72-W	160	6.0	-	299
GS2TTWD78-W	170	6.4	-	299
GS2TTWD84-W	180	6.9	-	299
GS2TTWD90-W	190	7.3	-	299
GS2TTWD96-W	200	7.8	-	299
GS2TTWD102-W	210	8.2	-	299
GS2TTWD108-W	240	8.0	-	299
GS2TWD1H24-W	52	2.9	-	295
GS2TWD1H30-W	68	3.0	-	295
GS2TWD1H36-W	80	3.6	-	295
GS2TWD1H42-W	91	4.1	-	295
GS2TWD1H48-W	103	4.7	-	295
GS2TWD1H54-W	120	4.6	-	295
GS2TWD1H60-W	140	5.1	-	295
GS2TWD1H66-W	150	5.5	-	295
GS2TWD1H72-W	160	6.0	-	295
GS2TWD1H78-W	170	6.4	-	295
GS2TWD1H84-W	180	6.9	-	295
GS2TWD1H90-W	190	7.3	-	295
GS2TWD1H96-W	200	7.8	-	295
GS2TWD1H102-W	210	8.2	-	295

# WEIGHTS + CUBES

Silea  
02/24

model number	weight	cubes	#locks	page
GS2TWD1H108-W	240	8.0	-	295
GS2TWD2H24-W	64	3.8	-	296
GS2TWD2H30-W	78	4.0	-	296
GS2TWD2H36-W	92	4.7	-	296
GS2TWD2H42-W	106	5.4	-	296
GS2TWD2H48-W	120	6.1	-	296
GS2TWD2H54-W	140	6.1	-	296
GS2TWD2H60-W	150	6.7	-	296
GS2TWD2H66-W	160	7.3	-	296
GS2TWD2H72-W	185	7.8	-	296
GS2TWD2H78-W	200	8.4	-	296
GS2TWD2H84-W	215	9.0	-	296
GS2TWD2H90-W	230	9.6	-	296
GS2TWD2H96-W	245	10.2	-	296
GS2TWD2H102-W	260	10.8	-	296
GS2TWD2H108-W	280	10.5	-	296
GS2TWD24-W	18	2.0	-	292
GS2TWD30-W	21	2.0	-	292
GS2TWD30-XL	16	2.1	-	291
GS2TWD30-XW	21	2.0	-	291
GS2TWD36-W	24	2.4	-	292
GS2TWD36-XL	20	2.5	-	291
GS2TWD36-XW	24	2.4	-	291
GS2TWD42-W	27	2.7	-	292
GS2TWD42-XL	27	2.7	-	291
GS2TWD42-XW	27	2.7	-	291
GS2TWD48-W	30	3.1	-	292
GS2TWD48-XL	30	3.1	-	291
GS2TWD48-XW	30	3.1	-	291
GS2TWD54-W	33	3.4	-	292
GS2TWD54-XL	33	3.4	-	291
GS2TWD54-XW	33	3.4	-	291
GS2TWD60-W	37	3.8	-	292
GS2TWD60-XL	33	4.1	-	291
GS2TWD60-XW	37	3.8	-	291
GS2TWD66-W	40	4.2	-	292
GS2TWD66-XL	36	4.4	-	291
GS2TWD66-XW	40	4.2	-	291
GS2TWD72-W	43	4.5	-	292
GS2TWD72-XL	39	4.8	-	291
GS2TWD72-XW	43	4.5	-	291
GS2TWD78-W	46	4.9	-	292
GS2TWD78-XL	43	5.2	-	291
GS2TWD78-XW	46	4.9	-	291

model number	weight	cubes	#locks	page
GS2TWD84-W	49	5.3	-	292
GS2TWD84-XL	46	5.6	-	291
GS2TWD84-XW	49	5.3	-	291
GS2TWD90-W	52	5.6	-	292
GS2TWD90-XL	49	6.0	-	291
GS2TWD90-XW	52	5.6	-	291
GS2TWD96-W	55	6.0	-	292
GS2TWD96-XL	53	6.4	-	291
GS2TWD96-XW	55	6.0	-	291
GS2TWD102-W	58	6.3	-	292
GS2TWD102-XL	56	3.4	-	291
GS2TWD102-XW	58	6.3	-	291
GS2TWD108-W	62	6.7	-	292
GS2TWD108-XL	59	3.6	-	291
GS2TWD108-XW	62	6.7	-	291
GS2UTC5H24L-3LL	269	33.1	3	254
GS2UTC5H24L-3WW	269	33.1	3	254
GS2UTC5H24L-LL	269	30.2	3	253
GS2UTC5H24L-WW	269	30.2	3	253
GS2UTC5H24R-3LL	269	33.1	3	254
GS2UTC5H24R-3WW	269	33.1	3	254
GS2UTC5H24R-LL	269	30.2	3	253
GS2UTC5H24R-WW	269	30.2	3	253
GS2UTC5H30L-3LL	285	40.2	3	256
GS2UTC5H30L-3WW	285	40.2	3	256
GS2UTC5H30L-LL	285	40.2	3	255
GS2UTC5H30L-WW	285	40.2	3	255
GS2UTC5H30R-3LL	285	40.2	3	256
GS2UTC5H30R-3WW	285	40.2	3	256
GS2UTC5H30R-LL	285	40.2	3	255
GS2UTC5H30R-WW	285	40.2	3	255
GS2UTC6H24L-3LL	317	39.0	3	254
GS2UTC6H24L-3WW	317	39.0	3	254
GS2UTC6H24L-LL	317	35.8	3	253
GS2UTC6H24L-WW	317	35.8	3	253
GS2UTC6H24R-3LL	317	39.0	3	254
GS2UTC6H24R-3WW	317	39.0	3	254
GS2UTC6H24R-LL	317	35.8	3	253
GS2UTC6H24R-WW	317	35.8	3	253
GS2UTC6H30L-3LL	330	47.4	3	256
GS2UTC6H30L-3WW	330	47.4	3	256
GS2UTC6H30L-LL	330	47.4	3	255
GS2UTC6H30L-WW	330	47.4	3	255
GS2UTC6H30R-3LL	330	47.4	3	256

model number	weight	cubes	#locks	page
GS2UTC6H30R-3WW	330	47.4	3	256
GS2UTC6H30R-LL	330	47.4	3	255
GS2UTC6H30R-WW	330	47.4	3	255
GS2VLEG-A	8	0.6	-	157
GS2WGW5H36	74	6.2	-	290
GS2WGW6H36	85	7.4	-	290
GS2WMC1H30-LL	45	5.8	1	268
GS2WMC1H30-LN	40	6.0	-	270
GS2WMC1H30-WG	45	5.8	-	269
GS2WMC1H30-WN	40	6.0	-	270
GS2WMC1H30-WW	45	5.8	1	268
GS2WMC1H36-LL	52	6.9	1	268
GS2WMC1H36-LN	47	7.1	-	270
GS2WMC1H36-WG	52	6.9	-	269
GS2WMC1H36-WN	47	7.1	-	270
GS2WMC1H36-WW	52	6.9	1	268
GS2WMC1H42-LL	60	8.6	2	268
GS2WMC1H42-LN	50	8.2	-	270
GS2WMC1H42-WN	50	8.2	-	270
GS2WMC1H42-WW	60	8.6	2	268
GS2WMC1H48-LL	69	9.7	2	268
GS2WMC1H48-LN	59	9.3	-	270
GS2WMC1H48-WN	59	9.3	-	270
GS2WMC1H48-WW	69	9.7	2	268
GS2WMC1H54-LL	78	10.9	2	268
GS2WMC1H54-LN	68	10.4	-	270
GS2WMC1H54-WN	68	10.4	-	270
GS2WMC1H54-WW	78	10.9	2	268
GS2WMC1H60-LL	85	11.1	2	268
GS2WMC1H60-LN	75	11.5	-	270
GS2WMC1H60-LSL	85	11.1	-	271
GS2WMC1H60-WG	85	11.1	-	269
GS2WMC1H60-WN	75	11.5	-	270
GS2WMC1H60-WSG	85	11.1	-	272
GS2WMC1H60-WSW	85	11.1	-	271
GS2WMC1H60-WW	85	11.1	2	268
GS2WMC1H66-LL	94	12.2	2	268
GS2WMC1H66-LN	84	12.6	-	270
GS2WMC1H66-LSL	95	15.0	-	271
GS2WMC1H66-WN	84	12.6	-	270
GS2WMC1H66-WSW	95	15.0	-	271
GS2WMC1H66-WW	94	12.2	2	268
GS2WMC1H72-LL	105	13.2	2	268
GS2WMC1H72-LN	95	13.7	-	270

model number	weight	cubes	#locks	page
GS2WMC1H72-LSL	105	13.2	-	271
GS2WMC1H72-WG	105	13.2	-	269
GS2WMC1H72-WN	95	13.7	-	270
GS2WMC1H72-WSG	105	13.2	-	272
GS2WMC1H72-WSW	105	13.2	-	271
GS2WMC1H72-WW	105	13.2	2	268
GS2WMC1H78-LL	115	14.3	2	268
GS2WMC1H78-LN	105	14.8	-	270
GS2WMC1H78-LSL	115	17.6	-	271
GS2WMC1H78-WN	105	14.8	-	270
GS2WMC1H78-WSW	115	17.6	-	271
GS2WMC1H78-WW	115	14.3	2	268
GS2WMC1H84-LL	125	15.4	3	268
GS2WMC1H84-LN	115	15.8	-	270
GS2WMC1H84-LSL	125	18.8	-	271
GS2WMC1H84-WN	115	15.8	-	270
GS2WMC1H84-WSW	125	18.8	-	271
GS2WMC1H84-WW	125	15.4	3	268
GS2WMC1H90-LL	135	16.4	3	268
GS2WMC1H90-LN	125	16.9	-	270
GS2WMC1H90-LSL	135	16.4	-	271
GS2WMC1H90-WG	135	16.4	-	269
GS2WMC1H90-WN	125	16.9	-	270
GS2WMC1H90-WSG	135	16.4	-	272
GS2WMC1H90-WSW	135	16.4	-	271
GS2WMC1H90-WW	135	16.4	3	268
GS2WMC1H96-LL	142	17.5	3	268
GS2WMC1H96-LN	132	18.0	-	270
GS2WMC1H96-LSL	145	21.4	-	271
GS2WMC1H96-WN	132	18.0	-	270
GS2WMC1H96-WSW	145	21.4	-	271
GS2WMC1H96-WW	142	17.5	3	268
GS2WMC1H102-LL	149	20.0	3	268
GS2WMC1H102-LN	139	19.1	-	270
GS2WMC1H102-WN	139	19.1	-	270
GS2WMC1H102-WSW	155	22.7	-	271
GS2WMC1H102-WW	149	18.5	3	268
GS2WMC1H108-LL	158	21.2	3	268
GS2WMC1H108-LN	148	20.2	-	270
GS2WMC1H108-WG	158	19.6	-	269
GS2WMC1H108-WN	148	20.2	-	270
GS2WMC1H108-WSG	158	19.6	-	272
GS2WMC1H108-WSW	158	19.6	-	271
GS2WMC1H108-WW	158	19.6	3	268

# WEIGHTS + CUBES

Silea  
02/24

model number	weight	cubes	#locks	page
GS2WMC2H30-LL	85	10.4	1	273
GS2WMC2H30-LN	80	10.7	-	275
GS2WMC2H30-WG	85	10.4	-	274
GS2WMC2H30-WN	80	10.7	-	275
GS2WMC2H30-WW	85	10.4	1	273
GS2WMC2H36-LL	93	12.3	1	273
GS2WMC2H36-LN	88	12.6	-	275
GS2WMC2H36-WG	93	12.3	-	274
GS2WMC2H36-WN	88	12.6	-	275
GS2WMC2H36-WW	93	12.3	1	273
GS2WMC2H42-LL	108	15.3	2	273
GS2WMC2H42-LN	98	14.6	-	275
GS2WMC2H42-WN	98	14.6	-	275
GS2WMC2H42-WW	108	15.3	2	273
GS2WMC2H48-LL	122	17.3	2	273
GS2WMC2H48-LN	112	16.5	-	275
GS2WMC2H48-WN	112	16.5	-	275
GS2WMC2H48-WW	122	17.3	2	273
GS2WMC2H54-LL	136	19.4	2	273
GS2WMC2H54-LN	126	18.5	-	275
GS2WMC2H54-WN	126	18.5	-	275
GS2WMC2H54-WW	136	19.4	2	273
GS2WMC2H60-LL	150	19.8	2	273
GS2WMC2H60-LN	140	20.4	-	275
GS2WMC2H60-LSL	150	19.8	-	276
GS2WMC2H60-WG	150	19.8	-	274
GS2WMC2H60-WN	140	20.4	-	275
GS2WMC2H60-WSG	150	19.8	-	277
GS2WMC2H60-WSW	150	19.8	-	276
GS2WMC2H60-WW	150	19.8	2	273
GS2WMC2H66-LL	167	21.7	2	273
GS2WMC2H66-LN	157	22.4	-	275
GS2WMC2H66-LSL	168	25.9	-	276
GS2WMC2H66-WN	157	22.4	-	275
GS2WMC2H66-WSW	168	25.9	-	276
GS2WMC2H66-WW	167	21.7	2	273
GS2WMC2H72-LL	186	23.6	2	273
GS2WMC2H72-LN	176	24.3	-	275
GS2WMC2H72-LSL	186	23.6	-	276
GS2WMC2H72-WG	186	23.6	-	274
GS2WMC2H72-WN	176	24.3	-	275
GS2WMC2H72-WSG	186	23.6	-	277
GS2WMC2H72-WSW	186	23.6	-	276
GS2WMC2H72-WW	186	23.6	2	273

model number	weight	cubes	#locks	page
GS2WMC2H78-LL	201	25.5	2	273
GS2WMC2H78-LN	191	26.3	-	275
GS2WMC2H78-LSL	204	30.4	-	276
GS2WMC2H78-WN	191	26.3	-	275
GS2WMC2H78-WSW	204	30.4	-	276
GS2WMC2H78-WW	201	25.5	2	273
GS2WMC2H84-LL	218	27.4	3	273
GS2WMC2H84-LN	208	28.2	-	275
GS2WMC2H84-LSL	220	32.6	-	276
GS2WMC2H84-WN	208	28.2	-	275
GS2WMC2H84-WSW	220	32.6	-	276
GS2WMC2H84-WW	218	27.4	3	273
GS2WMC2H90-LL	237	29.2	3	273
GS2WMC2H90-LN	227	30.2	-	275
GS2WMC2H90-LSL	237	29.2	-	276
GS2WMC2H90-WG	237	29.2	-	274
GS2WMC2H90-WN	227	30.2	-	275
GS2WMC2H90-WSG	237	29.2	-	277
GS2WMC2H90-WSW	237	29.2	-	276
GS2WMC2H90-WW	237	29.2	3	273
GS2WMW1H30-L	10	1.3	-	278
GS2WMW1H30-W	10	1.3	-	278
GS2WMW1H36-L	12	1.5	-	278
GS2WMW1H36-W	12	1.5	-	278
GS2WMW1H42-L	14	1.8	-	278
GS2WMW1H42-W	14	1.8	-	278
GS2WMW1H48-L	16	2.0	-	278
GS2WMW1H48-W	16	2.0	-	278
GS2WMW1H54-L	18	2.3	-	278
GS2WMW1H54-W	18	2.3	-	278
GS2WMW1H60-L	20	2.5	-	278
GS2WMW1H60-W	20	2.5	-	278
GS2WMW1H66-L	22	2.7	-	278
GS2WMW1H66-W	22	2.7	-	278
GS2WMW1H72-L	24	3.0	-	278
GS2WMW1H72-W	25	3.0	-	278
GS2WMW1H78-L	26	3.2	-	278
GS2WMW1H78-W	27	3.2	-	278
GS2WMW1H84-L	28	3.4	-	278
GS2WMW1H84-W	29	3.4	-	278
GS2WMW1H90-L	31	3.7	-	278
GS2WMW1H90-W	32	3.7	-	278
GS2WMW1H96-L	33	3.9	-	278
GS2WMW1H96-W	4	3.9	-	278



model number	weight	cubes	#locks	page
GS2WMW1H102-L	35	2.1	-	278
GS2WMW1H102-W	35	4.2	-	278
GS2WMW1H108-L	37	2.2	-	278
GS2WMW1H108-W	39	4.4	-	278
GS2WMW2H30-L	19	2.3	-	279
GS2WMW2H30-W	21	2.3	-	279
GS2WMW2H36-L	22	2.8	-	279
GS2WMW2H36-W	25	2.8	-	279
GS2WMW2H42-L	29	3.2	-	279
GS2WMW2H42-W	29	3.2	-	279
GS2WMW2H48-L	34	3.6	-	279
GS2WMW2H48-W	34	3.6	-	279
GS2WMW2H54-L	38	4.0	-	279
GS2WMW2H54-W	38	4.0	-	279
GS2WMW2H60-L	37	4.4	-	279
GS2WMW2H60-W	42	4.4	-	279
GS2WMW2H66-L	41	4.9	-	279
GS2WMW2H66-W	46	4.9	-	279
GS2WMW2H72-L	45	5.3	-	279
GS2WMW2H72-W	51	5.3	-	279
GS2WMW2H78-L	49	5.7	-	279
GS2WMW2H78-W	56	5.7	-	279
GS2WMW2H84-L	52	6.1	-	279
GS2WMW2H84-W	60	6.1	-	279
GS2WMW2H90-L	56	6.6	-	279
GS2WMW2H90-W	67	6.6	-	279
GS2WSB3H72L-WSG	300	41.1	-	318
GS2WSB3H72R-WSG	300	41.1	-	318
GS2WSB3H90L-WSG	375	50.9	-	318
GS2WSB3H90R-WSG	375	50.9	-	318
GS2XBT4272-LL	154	19.6	-	63
GS2XBT4272-WW	154	19.6	-	63
GS2XDT4272-LL	154	19.6	-	63
GS2XDT4272-WW	154	19.6	-	63
GS2XMAMOD66-L	12	1.7	-	120
GS2XMAMOD66-M	12	1.7	-	120
GS2XMAMOD66-W	12	1.9	-	120
GS2XMAMOD72-L	12	1.9	-	120
GS2XMAMOD72-M	12	1.9	-	120
GS2XMAMOD72-W	13	1.9	-	120
GS2XMAMOD78-L	12	2.1	-	120
GS2XMAMOD78-M	12	2.1	-	120
GS2XMAMOD78-W	12	2.1	-	120
GS2XMF36L-L	20	3.9	-	164

model number	weight	cubes	#locks	page
GS2XMF36L-W	20	3.9	-	164
GS2XMF36R-L	20	3.9	-	164
GS2XMF36R-W	20	3.9	-	164
GS2XMF42L-L	23	4.5	-	164
GS2XMF42L-W	23	4.5	-	164
GS2XMF42R-L	23	4.5	-	164
GS2XMF42R-W	23	4.5	-	164
GS2XML366060-LL	173	26.3	-	76
GS2XML366060-WW	179	22.1	-	76
GS2XML487260-LL	202	30.9	-	76
GS2XML487260-WW	209	25.9	-	76
GS2XRL3066L-LL	143	17.3	-	62
GS2XRL3066L-WW	143	17.3	-	62
GS2XRL3066R-LL	143	17.3	-	62
GS2XRL3066R-WW	143	17.3	-	62
GS2XRL3072L-LL	151	18.0	-	62
GS2XRL3072L-WW	151	18.0	-	62
GS2XRL3072R-LL	151	18.0	-	62
GS2XRL3072R-WW	151	18.0	-	62
GS2XRL3672L-LL	171	20.4	-	62
GS2XRL3672L-WW	171	20.4	-	62
GS2XRL3672R-LL	171	20.4	-	62
GS2XRL3672R-WW	171	20.4	-	62
GS2XRL3678L-LL	180	21.3	-	62
GS2XRL3678L-WW	178	21.3	-	62
GS2XRL3678R-LL	180	21.3	-	62
GS2XRL3678R-WW	178	21.3	-	62
GS2XRT3066L-LL	122	16.9	-	63
GS2XRT3066L-WW	122	16.9	-	63
GS2XRT3066R-LL	122	16.9	-	63
GS2XRT3066R-WW	122	16.9	-	63
GS2XRT3072L-LL	128	17.4	-	63
GS2XRT3072L-WW	128	17.4	-	63
GS2XRT3072R-LL	128	17.4	-	63
GS2XRT3072R-WW	128	17.4	-	63
GS3BAK2442-LL	80	11.7	-	92
GS3BAK2442-WW	80	10.2	-	92
GS3BAK2448-LL	90	13.4	-	92
GS3BAK2448-WW	90	11.5	-	92
GS3BAK2454-LL	100	15.0	-	92
GS3BAK2454-WW	100	12.9	-	92
GS3BAK2460-LL	110	16.6	-	92
GS3BAK2460-WW	110	14.2	-	92
GS3BAK2466-LL	120	18.3	-	92

# WEIGHTS + CUBES

Silea  
02/24

model number	weight	cubes	#locks	page
GS3BAK2466-WW	120	15.6	-	92
GS3BAK2472-LL	130	19.9	-	92
GS3BAK2472-WW	130	16.9	-	92
GS3BAK3042-LL	216	19.2	-	93
GS3BAK3042-WW	130	30.5	-	93
GS3BAK3048-LL	227	20.8	-	93
GS3BAK3048-WW	140	34.5	-	93
GS3BAK3054-LL	239	22.4	-	93
GS3BAK3054-WW	149	38.5	-	93
GS3BAK3060-LL	256	24.0	-	93
GS3BAK3060-WW	157	42.5	-	93
GS3BAK3066-LL	274	25.6	-	93
GS3BAK3066-WW	165	46.5	-	93
GS3BAK3072-LL	286	51.4	-	93
GS3BAK3072-WW	176	50.4	-	93
GS3CAK2442-LL	229	63.0	-	88
GS3CAK2442-WW	167	30.5	-	88
GS3CAK2448-LL	240	35.9	-	88
GS3CAK2448-WW	175	34.5	-	88
GS3CAK2454-LL	250	39.2	-	88
GS3CAK2454-WW	183	38.5	-	88
GS3CAK2460-LL	265	42.5	-	88
GS3CAK2460-WW	190	42.5	-	88
GS3CAK2466-AALL	349	37.5	2	90
GS3CAK2466-AAWW	295	46.5	2	90
GS3CAK2466L-ALL	328	47.7	1	90
GS3CAK2466L-AWW	260	46.5	1	90
GS3CAK2466-LL	283	45.8	-	88
GS3CAK2466R-ALL	328	47.7	1	90
GS3CAK2466R-AWW	255	46.5	1	90
GS3CAK2466-WW	197	46.5	-	88
GS3CAK2472-AALL	358	39.0	2	90
GS3CAK2472-AAWW	305	50.4	2	90
GS3CAK2472L-ALL	338	51.0	1	90
GS3CAK2472L-AWW	275	50.4	1	90
GS3CAK2472-LL	293	49.1	-	88
GS3CAK2472R-ALL	338	51.0	1	90
GS3CAK2472R-AWW	265	50.4	1	90
GS3CAK2472-WW	207	50.4	-	88
GS3CAK3042-LL	238	37.8	-	89
GS3CAK3042-WW	151	30.5	-	89
GS3CAK3048-LL	249	41.8	-	89
GS3CAK3048-WW	160	34.5	-	89
GS3CAK3054-LL	261	45.8	-	89

model number	weight	cubes	#locks	page
GS3CAK3054-WW	169	38.5	-	89
GS3CAK3060-LL	278	49.8	-	89
GS3CAK3060-WW	177	42.5	-	89
GS3CAK3066-AALL	386	42.2	1	91
GS3CAK3066-AAWW	304	46.5	1	91
GS3CAK3066L-ALL	356	56.1	1	91
GS3CAK3066L-AWW	251	46.5	1	91
GS3CAK3066-LL	296	53.8	-	89
GS3CAK3066R-ALL	356	56.1	1	91
GS3CAK3066R-AWW	251	46.5	1	91
GS3CAK3066-WW	185	46.5	-	89
GS3CAK3072-AALL	397	43.8	1	91
GS3CAK3072-AAWW	315	50.4	1	91
GS3CAK3072L-ALL	368	60.1	1	91
GS3CAK3072L-AWW	261	50.4	1	91
GS3CAK3072-LL	308	57.8	-	89
GS3CAK3072R-ALL	368	60.1	1	91
GS3CAK3072R-AWW	261	50.4	1	91
GS3CAK3072-WW	196	50.4	-	89
GS3DFAK3066-LL	339	30.9	-	82
GS3DFAK3066-WW	308	46.5	-	82
GS3DFAK3072-LL	354	32.7	-	82
GS3DFAK3072-WW	318	50.4	-	82
GS3DFAK3672-WW	328	60.2	-	82
GS3DFAK3678-LL	385	35.7	-	82
GS3DFAK3678-WW	338	65.0	-	82
GS3DHAK3066-LL	296	25.4	-	86
GS3DHAK3066-WW	266	46.5	-	86
GS3DHAK3072-LL	307	26.7	-	86
GS3DHAK3072-WW	276	50.4	-	86
GS3DHAK3672-LL	325	28.3	-	86
GS3DHAK3672-WW	286	60.2	-	86
GS3DHAK3678-LL	334	29.5	-	86
GS3DHAK3678-WW	296	65.0	-	86
GS3HASHRD2442-L	124	13.3	-	115
GS3HASHRD2442-W	76	9.4	-	115
GS3HASHRD2448-L	128	14.4	-	115
GS3HASHRD2448-W	80	9.4	-	115
GS3HASHRD2454-L	132	14.9	-	115
GS3HASHRD2454-W	84	9.4	-	115
GS3HASHRD2460-L	136	15.6	-	115
GS3HASHRD2460-W	86	9.4	-	115
GS3HASHRD2466-L	140	16.4	-	115
GS3HASHRD2466-W	90	9.4	-	115

model number	weight	cubes	#locks	page
GS3HASHRD2472-L	144	17.2	-	115
GS3HASHRD2472-W	94	10.8	-	115
GS3HASHRD3042-L	138	15.3	-	115
GS3HASHRD3042-W	84	11.6	-	115
GS3HASHRD3048-L	142	16.3	-	115
GS3HASHRD3048-W	88	11.6	-	115
GS3HASHRD3054-L	146	16.9	-	115
GS3HASHRD3054-W	92	11.6	-	115
GS3HASHRD3060-L	150	17.6	-	115
GS3HASHRD3060-W	96	11.6	-	115
GS3HASHRD3066-L	154	18.4	-	115
GS3HASHRD3066-W	100	11.6	-	115
GS3HASHRD3072-L	158	19.1	-	115
GS3HASHRD3072-W	104	11.6	-	115
GS3HASHRD3642-L	150	17.3	-	115
GS3HASHRD3642-W	98	14.1	-	115
GS3HASHRD3648-L	154	18.3	-	115
GS3HASHRD3648-W	102	14.1	-	115
GS3HASHRD3654-L	158	18.8	-	115
GS3HASHRD3654-W	106	14.1	-	115
GS3HASHRD3660-L	162	19.6	-	115
GS3HASHRD3660-W	110	14.1	-	115
GS3HASHRD3666-L	166	20.4	-	115
GS3HASHRD3666-W	114	14.1	-	115
GS3HASHRD3672-L	170	21.1	-	115
GS3HASHRD3672-W	118	14.1	-	115
GS3RAK2442L-ALL	283	25.5	1	96
GS3RAK2442L-AWW	228	30.5	1	96
GS3RAK2442L-LL	221	33.3	-	94
GS3RAK2442L-WW	160	30.5	-	94
GS3RAK2442R-ALL	153	18.0	1	96
GS3RAK2442R-AWW	228	30.5	1	96
GS3RAK2442R-LL	221	33.3	-	94
GS3RAK2442R-WW	160	30.5	-	94
GS3RAK2448L-ALL	294	27.2	1	96
GS3RAK2448L-AWW	233	34.5	1	96
GS3RAK2448L-LL	232	36.8	-	94
GS3RAK2448L-WW	168	34.5	-	94
GS3RAK2448R-ALL	162	19.6	1	96
GS3RAK2448R-AWW	170	25.9	1	96
GS3RAK2448R-LL	232	36.8	-	94
GS3RAK2448R-WW	168	34.5	-	94
GS3RAK2454L-ALL	304	28.8	1	96
GS3RAK2454L-AWW	237	38.5	1	96

model number	weight	cubes	#locks	page
GS3RAK2454L-LL	242	40.2	-	94
GS3RAK2454L-WW	176	38.5	-	94
GS3RAK2454R-ALL	170	21.2	1	96
GS3RAK2454R-AWW	180	28.9	1	96
GS3RAK2454R-LL	242	40.2	-	94
GS3RAK2454R-WW	176	38.5	-	94
GS3RAK2460L-ALL	319	30.4	1	96
GS3RAK2460L-AWW	242	42.5	1	96
GS3RAK2460L-LL	257	43.6	-	94
GS3RAK2460L-WW	183	42.5	-	94
GS3RAK2460R-ALL	178	22.9	1	96
GS3RAK2460R-AWW	190	32.0	1	96
GS3RAK2460R-LL	257	43.6	-	94
GS3RAK2460R-WW	183	42.5	-	94
GS3RAK2466L-ALL	337	32.0	1	96
GS3RAK2466L-AWW	248	46.5	1	96
GS3RAK2466L-LL	275	47.0	-	94
GS3RAK2466L-WW	190	46.5	-	94
GS3RAK2466R-ALL	187	24.5	1	96
GS3RAK2466R-AWW	200	35.0	1	96
GS3RAK2466R-LL	275	47.0	-	94
GS3RAK2466R-WW	190	46.5	-	94
GS3RAK2472L-ALL	347	33.6	1	96
GS3RAK2472L-AWW	258	50.4	-	96
GS3RAK2472L-LL	285	50.4	-	94
GS3RAK2472L-WW	200	50.4	-	94
GS3RAK2472R-ALL	195	26.2	1	96
GS3RAK2472R-AWW	210	38.1	1	96
GS3RAK2472R-LL	285	50.4	-	94
GS3RAK2472R-WW	200	50.4	-	94
GS3RAK3042L-ALL	301	28.1	1	97
GS3RAK3042L-AWW	215	30.5	1	97
GS3RAK3042L-LL	227	37.8	-	95
GS3RAK3042L-WW	141	30.5	-	95
GS3RAK3042R-ALL	301	28.1	1	97
GS3RAK3042R-AWW	215	30.5	1	97
GS3RAK3042R-LL	227	37.8	-	95
GS3RAK3042R-WW	141	30.5	-	95
GS3RAK3048L-ALL	312	29.8	1	97
GS3RAK3048L-AWW	221	34.5	1	97
GS3RAK3048L-LL	238	41.8	-	95
GS3RAK3048L-WW	150	34.5	-	95
GS3RAK3048R-ALL	312	29.8	1	97
GS3RAK3048R-AWW	221	34.5	1	97

# WEIGHTS + CUBES

Silea  
02/24

model number	weight	cubes	#locks	page
GS3RAK3048R-LL	238	41.8	-	95
GS3RAK3048R-WW	150	34.5	-	95
GS3RAK3054L-ALL	324	31.5	1	97
GS3RAK3054L-AWW	226	38.5	1	97
GS3RAK3054L-LL	250	45.8	-	95
GS3RAK3054L-WW	159	38.5	-	95
GS3RAK3054R-ALL	324	31.5	1	97
GS3RAK3054R-AWW	226	38.5	1	97
GS3RAK3054R-LL	250	45.8	-	95
GS3RAK3054R-WW	159	38.5	-	95
GS3RAK3060L-ALL	341	33.1	1	97
GS3RAK3060L-AWW	232	42.5	1	97
GS3RAK3060L-LL	267	49.8	-	95
GS3RAK3060L-WW	167	42.5	-	95
GS3RAK3060R-ALL	341	33.1	1	97
GS3RAK3060R-AWW	232	42.5	1	97
GS3RAK3060R-LL	267	49.8	-	95
GS3RAK3060R-WW	167	42.5	-	95
GS3RAK3066L-ALL	359	34.8	1	97
GS3RAK3066L-AWW	239	46.5	1	97
GS3RAK3066L-LL	285	53.8	-	95
GS3RAK3066L-WW	175	46.5	-	95
GS3RAK3066R-ALL	359	34.8	1	97
GS3RAK3066R-AWW	239	46.5	1	97
GS3RAK3066R-LL	285	53.8	-	95
GS3RAK3066R-WW	175	46.5	-	95
GS3RAK3072L-ALL	371	36.5	1	97
GS3RAK3072L-AWW	250	50.4	1	97
GS3RAK3072L-LL	297	57.8	-	95
GS3RAK3072L-WW	186	50.4	-	95
GS3RAK3072R-ALL	371	36.5	1	97
GS3RAK3072R-AWW	250	50.4	1	97
GS3RAK3072R-LL	297	57.8	-	95
GS3RAK3072R-WW	186	50.4	-	95
GS3STAT7278L-ALL	505	68.1	1	80
GS3STAT7278L-AWW	505	68.1	1	80
GS3STAT7278L-LL	450	62.0	-	78
GS3STAT7278L-WW	450	62.0	-	78
GS3STAT7278R-ALL	505	68.1	1	81
GS3STAT7278R-AWW	505	68.1	1	81
GS3STAT7278R-LL	450	62.0	-	79
GS3STAT7278R-WW	450	62.0	-	79
GS3STAT7284L-ALL	519	69.3	1	80
GS3STAT7284L-AWW	519	69.3	1	80

model number	weight	cubes	#locks	page
GS3STAT7284L-LL	464	63.2	-	78
GS3STAT7284L-WW	464	63.2	-	78
GS3STAT7284R-ALL	519	69.3	1	81
GS3STAT7284R-AWW	519	69.3	1	81
GS3STAT7284R-LL	464	63.2	-	79
GS3STAT7284R-WW	464	63.2	-	79
GS3STAT7890L-ALL	547	71.9	1	80
GS3STAT7890L-AWW	547	71.9	1	80
GS3STAT7890L-LL	492	65.7	-	78
GS3STAT7890L-WW	492	65.7	-	78
GS3STAT7890R-ALL	547	71.9	1	81
GS3STAT7890R-AWW	547	71.9	1	81
GS3STAT7890R-LL	492	65.7	-	79
GS3STAT7890R-WW	492	65.7	-	79
GS3STAT7896L-ALL	560	73.1	1	80
GS3STAT7896L-AWW	560	73.1	1	80
GS3STAT7896L-LL	451	60.6	-	78
GS3STAT7896L-WW	451	60.6	-	78
GS3STAT7896R-ALL	560	73.1	1	81
GS3STAT7896R-AWW	560	73.1	1	81
GS3STAT7896R-LL	505	66.9	-	79
GS3STAT7896R-WW	505	66.9	-	79
GS3XFAK3066L-ALL	370	34.4	1	84
GS3XFAK3066L-AWW	340	56.2	1	84
GS3XFAK3066L-LL	322	31.7	-	83
GS3XFAK3066L-WW	323	56.2	-	83
GS3XFAK3066R-ALL	370	36.3	1	84
GS3XFAK3066R-AWW	340	56.2	1	84
GS3XFAK3066R-LL	322	31.7	-	83
GS3XFAK3066R-WW	323	56.2	-	83
GS3XFAK3072L-ALL	384	35.9	1	84
GS3XFAK3072L-AWW	360	61.0	1	84
GS3XFAK3072L-LL	336	33.3	-	83
GS3XFAK3072L-WW	333	61.0	-	83
GS3XFAK3072R-ALL	384	37.8	1	84
GS3XFAK3072R-AWW	360	61.0	1	84
GS3XFAK3072R-LL	336	33.3	-	83
GS3XFAK3072R-WW	333	61.0	-	83
GS3XFAK3672L-ALL	412	38.2	1	84
GS3XFAK3672L-AWW	380	80.8	1	84
GS3XFAK3672L-LL	359	36.4	-	83
GS3XFAK3672L-WW	343	80.8	-	83
GS3XFAK3672R-ALL	412	40.1	1	84
GS3XFAK3672R-AWW	380	80.8	1	84

model number	weight	cubes	#locks	page
GS3XFAK3672R-LL	359	36.4	-	83
GS3XFAK3672R-WW	343	80.8	-	83
GS3XFAK3678L-ALL	427	38.5	1	84
GS3XFAK3678L-AWW	400	87.1	1	84
GS3XFAK3678L-LL	374	37.0	-	83
GS3XFAK3678L-WW	353	87.1	-	83
GS3XFAK3678R-ALL	427	40.4	1	84
GS3XFAK3678R-AWW	400	87.1	1	84
GS3XFAK3678R-LL	374	37.0	-	83
GS3XFAK3678R-WW	353	87.1	-	83
GS3XHAK3066L-LL	279	29.4	-	87
GS3XHAK3066L-WW	281	56.2	-	87
GS3XHAK3066R-LL	279	29.4	-	87
GS3XHAK3066R-WW	281	56.2	-	87
GS3XHAK3072L-LL	289	30.6	-	87
GS3XHAK3072L-WW	291	61.0	-	87
GS3XHAK3072R-LL	289	30.6	-	87
GS3XHAK3072R-WW	291	61.0	-	87
GS3XHAK3672L-LL	312	33.7	-	87
GS3XHAK3672L-WW	301	61.0	-	87
GS3XHAK3672R-LL	312	33.7	-	87
GS3XHAK3672R-WW	301	61.0	-	87
GS3XHAK3678L-LL	323	33.9	-	87
GS3XHAK3678L-WW	311	65.8	-	87
GS3XHAK3678R-LL	323	33.9	-	87
GS3XHAK3678R-WW	311	65.8	-	87
GS3XMAK3066L-LL	288	35.1	-	85
GS3XMAK3066L-WW	301	55.5	-	85
GS3XMAK3066R-LL	288	35.1	-	85
GS3XMAK3066R-WW	301	55.5	-	85
GS3XMAK3072L-LL	297	36.4	-	85
GS3XMAK3072L-WW	310	60.2	-	85
GS3XMAK3072R-LL	297	36.4	-	85
GS3XMAK3072R-WW	310	60.2	-	85
GS3XMAK3672L-LL	325	40.5	-	85
GS3XMAK3672L-WW	319	60.2	-	85
GS3XMAK3672R-LL	325	40.5	-	85
GS3XMAK3672R-WW	319	79.7	-	85
GS3XMAK3678L-LL	335	41.8	-	85
GS3XMAK3678L-WW	328	65.0	-	85
GS3XMAK3678R-LL	335	41.8	-	85
GS3XMAK3678R-WW	328	86.0	-	85
GS4LACWR2442-L	36	2.8	-	111
GS4LACWR2442-W	36	2.8	-	111

model number	weight	cubes	#locks	page
GS4LACWR2448-L	41	3.2	-	111
GS4LACWR2448-W	41	3.2	-	111
GS4LACWR2454-L	45	3.6	-	111
GS4LACWR2454-W	45	3.6	-	111
GS4LACWR2460-L	49	4.0	-	111
GS4LACWR2460-W	49	4.0	-	111
GS4LACWR2466-L	54	4.4	-	111
GS4LACWR2466-W	54	4.4	-	111
GS4LACWR2472-L	58	4.7	-	111
GS4LACWR2472-W	58	4.7	-	111
GS4LACWR3042-L	41	3.6	-	111
GS4LACWR3042-W	41	3.6	-	111
GS4LACWR3048-L	47	4.1	-	111
GS4LACWR3048-W	47	4.1	-	111
GS4LACWR3054-L	52	4.6	-	111
GS4LACWR3054-W	52	4.6	-	111
GS4LACWR3060-L	56	7.2	-	111
GS4LACWR3060-W	56	5.1	-	111
GS4LACWR3066-L	62	7.9	-	111
GS4LACWR3066-W	62	5.5	-	111
GS4LACWR3072-L	66	8.6	-	111
GS4LACWR3072-W	66	8.6	-	111
GS4LADWR3066-L	61	5.2	-	110
GS4LADWR3066-W	61	5.5	-	110
GS4LADWR3072-L	67	5.7	-	110
GS4LADWR3072-W	67	6.0	-	110
GS4LADWR3078-L	72	6.1	-	110
GS4LADWR3078-W	72	6.5	-	110
GS4LADWR3084-L	78	6.6	-	110
GS4LADWR3084-W	78	7.0	-	110
GS4LADWR3090-L	84	7.1	-	110
GS4LADWR3090-W	84	7.5	-	110
GS4LADWR3096-L	90	7.5	-	110
GS4LADWR3096-W	90	7.9	-	110
GS4LADWR3666-L	70	6.2	-	110
GS4LADWR3666-W	70	6.5	-	110
GS4LADWR3672-L	75	6.7	-	110
GS4LADWR3672-W	75	7.1	-	110
GS4LADWR3678-L	81	7.3	-	110
GS4LADWR3678-W	81	7.7	-	110
GS4LADWR3684-L	88	7.8	-	110
GS4LADWR3684-W	88	8.2	-	110
GS4LADWR3690-L	94	8.4	-	110
GS4LADWR3690-W	94	8.8	-	110

# WEIGHTS + CUBES

Silea  
02/24

model number	weight	cubes	#locks	page
GS4LADWR3696-L	101	8.9	-	110
GS4LADWR3696-W	101	9.4	-	110
GS4LALNKDPD-3	85	9.5	-	114
GS4LALNKDPD-4	105	9.5	-	114
GS4LATOP30722442L-L	102	11.7	-	112
GS4LATOP30722442L-W	102	11.7	-	112
GS4LATOP30722442R-L	102	11.7	-	113
GS4LATOP30722442R-W	102	11.7	-	113
GS4LATOP30722448L-L	106	11.7	-	112
GS4LATOP30722448L-W	106	11.7	-	112
GS4LATOP30722448R-L	106	11.7	-	113
GS4LATOP30722448R-W	106	11.7	-	113
GS4LATOP30722454L-L	110	11.7	-	112
GS4LATOP30722454L-W	110	11.7	-	112
GS4LATOP30722454R-L	110	11.7	-	113
GS4LATOP30722454R-W	110	11.7	-	113
GS4LATOP30722460L-L	114	11.7	-	112
GS4LATOP30722460L-W	114	11.7	-	112
GS4LATOP30722460R-L	114	11.7	-	113
GS4LATOP30722460R-W	114	11.7	-	113
GS4LATOP30722466L-L	118	11.7	-	112
GS4LATOP30722466L-W	118	11.7	-	112
GS4LATOP30722466R-L	118	11.7	-	113
GS4LATOP30722466R-W	118	11.7	-	113
GS4LATOP30722472L-W	122	11.7	-	112
GS4LATOP30722472R-W	122	11.7	-	113
GS4LATOP30842442L-L	110	13.6	-	112
GS4LATOP30842442L-W	110	13.6	-	112
GS4LATOP30842442R-L	110	13.6	-	113
GS4LATOP30842442R-W	110	13.6	-	113
GS4LATOP30842448L-L	114	13.6	-	112
GS4LATOP30842448L-W	114	13.6	-	112
GS4LATOP30842448R-L	114	13.6	-	113
GS4LATOP30842448R-W	114	13.6	-	113
GS4LATOP30842454L-L	118	13.6	-	112
GS4LATOP30842454L-W	118	13.6	-	112
GS4LATOP30842454R-L	118	13.6	-	113
GS4LATOP30842454R-W	118	13.6	-	113
GS4LATOP30842460L-L	122	13.6	-	112
GS4LATOP30842460L-W	122	13.6	-	112
GS4LATOP30842460R-L	122	13.6	-	113
GS4LATOP30842460R-W	122	13.6	-	113
GS4LATOP30842466L-L	126	13.6	-	112
GS4LATOP30842466L-W	126	13.6	-	112

model number	weight	cubes	#locks	page
GS4LATOP30842466R-L	126	13.6	-	113
GS4LATOP30842466R-W	126	13.6	-	113
GS4LATOP30842472L-W	130	13.6	-	112
GS4LATOP30842472R-W	130	13.6	-	113
GS4LATOP36722442L-L	118	13.3	-	112
GS4LATOP36722442L-W	118	13.3	-	112
GS4LATOP36722442R-L	118	13.3	-	113
GS4LATOP36722442R-W	118	13.3	-	113
GS4LATOP36722448L-L	122	13.3	-	112
GS4LATOP36722448L-W	122	13.3	-	112
GS4LATOP36722448R-L	122	13.3	-	113
GS4LATOP36722448R-W	122	13.3	-	113
GS4LATOP36722454L-L	126	13.3	-	112
GS4LATOP36722454L-W	126	13.3	-	112
GS4LATOP36722454R-L	126	13.3	-	113
GS4LATOP36722454R-W	126	13.3	-	113
GS4LATOP36722460L-L	130	13.3	-	112
GS4LATOP36722460L-W	130	13.3	-	112
GS4LATOP36722460R-L	130	13.3	-	113
GS4LATOP36722460R-W	130	13.3	-	113
GS4LATOP36722466L-W	134	13.3	-	112
GS4LATOP36722466R-W	134	13.3	-	113
GS4LATOP36722472L-W	138	13.3	-	112
GS4LATOP36722472R-W	138	13.3	-	113
GS4LATOP36842442L-L	121	15.4	-	112
GS4LATOP36842442L-W	121	15.4	-	112
GS4LATOP36842442R-L	121	15.4	-	113
GS4LATOP36842442R-W	121	15.4	-	113
GS4LATOP36842448L-L	125	15.4	-	112
GS4LATOP36842448L-W	125	15.4	-	112
GS4LATOP36842448R-L	125	15.4	-	113
GS4LATOP36842448R-W	125	15.4	-	113
GS4LATOP36842454L-L	129	15.4	-	112
GS4LATOP36842454L-W	129	15.4	-	112
GS4LATOP36842454R-L	129	15.4	-	113
GS4LATOP36842454R-W	129	15.4	-	113
GS4LATOP36842460L-L	133	15.4	-	112
GS4LATOP36842460L-W	133	15.4	-	112
GS4LATOP36842460R-L	133	15.4	-	113
GS4LATOP36842460R-W	133	15.4	-	113
GS4LATOP36842466L-W	137	15.4	-	112
GS4LATOP36842466R-W	137	15.4	-	113
GS4LATOP36842472L-W	141	15.4	-	112
GS4LATOP36842472R-W	141	15.4	-	113

model number	weight	cubes	#locks	page
GS4PLDMF3066L-AL	161	13.3	1	104
GS4PLDMF3066L-AW	161	15.1	1	104
GS4PLDMF3066L-L	135	9.5	-	102
GS4PLDMF3066L-W	135	9.7	-	102
GS4PLDMF3066R-AL	161	13.5	1	105
GS4PLDMF3066R-AW	161	15.1	1	105
GS4PLDMF3066R-L	135	9.8	-	103
GS4PLDMF3066R-W	135	9.7	-	103
GS4PLDMF3072L-AL	164	13.9	1	104
GS4PLDMF3072L-AW	164	15.5	1	104
GS4PLDMF3072L-L	138	10.1	-	102
GS4PLDMF3072L-W	138	10.1	-	102
GS4PLDMF3072R-AL	164	13.9	1	105
GS4PLDMF3072R-AW	164	15.5	1	105
GS4PLDMF3072R-L	138	10.1	-	103
GS4PLDMF3072R-W	138	10.1	-	103
GS4PLDMF3078L-AL	166	14.3	1	104
GS4PLDMF3078L-AW	166	15.9	1	104
GS4PLDMF3078L-L	140	10.5	-	102
GS4PLDMF3078L-W	140	10.5	-	102
GS4PLDMF3078R-AL	166	14.3	1	105
GS4PLDMF3078R-AW	166	15.9	1	105
GS4PLDMF3078R-L	140	10.5	-	103
GS4PLDMF3078R-W	140	10.5	-	103
GS4PLDMF3084L-AL	176	15.3	1	104
GS4PLDMF3084L-AW	176	16.9	1	104
GS4PLDMF3084L-L	150	11.6	-	102
GS4PLDMF3084L-W	150	11.5	-	102
GS4PLDMF3084R-AL	176	15.3	1	105
GS4PLDMF3084R-AW	176	16.9	1	105
GS4PLDMF3084R-L	150	11.6	-	103
GS4PLDMF3084R-W	150	11.5	-	103
GS4PLDMF3090L-AL	179	15.8	1	104
GS4PLDMF3090L-AW	179	17.4	1	104
GS4PLDMF3090L-L	153	12.0	-	102
GS4PLDMF3090L-W	153	12.0	-	102
GS4PLDMF3090R-AL	179	15.8	1	105
GS4PLDMF3090R-AW	179	17.4	1	105
GS4PLDMF3090R-L	153	12.0	-	103
GS4PLDMF3090R-W	153	12.0	-	103
GS4PLDMF3096L-AL	183	16.3	1	104
GS4PLDMF3096L-AW	183	17.9	1	104
GS4PLDMF3096L-L	157	12.5	-	102
GS4PLDMF3096L-W	157	12.5	-	102

model number	weight	cubes	#locks	page
GS4PLDMF3096R-AL	183	16.3	1	105
GS4PLDMF3096R-AW	183	17.9	1	105
GS4PLDMF3096R-L	157	12.5	-	103
GS4PLDMF3096R-W	157	12.5	-	103
GS4PLDMF3666L-AL	173	14.5	1	104
GS4PLDMF3666L-AW	173	15.1	1	104
GS4PLDMF3666L-L	140	10.2	-	102
GS4PLDMF3666L-W	140	10.2	-	102
GS4PLDMF3666R-AL	173	14.8	1	105
GS4PLDMF3666R-AW	173	15.1	1	105
GS4PLDMF3666R-L	140	10.5	-	103
GS4PLDMF3666R-W	140	10.2	-	103
GS4PLDMF3672L-AL	176	15.2	1	104
GS4PLDMF3672L-AW	176	15.5	1	104
GS4PLDMF3672L-L	143	10.9	-	102
GS4PLDMF3672L-W	143	10.6	-	102
GS4PLDMF3672R-AL	176	15.2	1	105
GS4PLDMF3672R-AW	176	15.5	1	105
GS4PLDMF3672R-L	143	10.9	-	103
GS4PLDMF3672R-W	143	10.6	-	103
GS4PLDMF3678L-AL	178	15.6	1	104
GS4PLDMF3678L-AW	178	15.9	1	104
GS4PLDMF3678L-L	145	11.3	-	102
GS4PLDMF3678L-W	145	11.0	-	102
GS4PLDMF3678R-AL	178	15.6	1	105
GS4PLDMF3678R-AW	178	15.9	1	105
GS4PLDMF3678R-L	145	11.3	-	103
GS4PLDMF3678R-W	145	11.0	-	103
GS4PLDMF3684L-AL	188	16.6	1	104
GS4PLDMF3684L-AW	188	16.9	1	104
GS4PLDMF3684L-L	155	12.3	-	102
GS4PLDMF3684L-W	155	12.1	-	102
GS4PLDMF3684R-AL	188	16.6	1	105
GS4PLDMF3684R-AW	188	16.9	1	105
GS4PLDMF3684R-L	155	12.3	-	103
GS4PLDMF3684R-W	155	12.1	-	103
GS4PLDMF3690L-AL	191	17.1	1	104
GS4PLDMF3690L-AW	191	17.4	1	104
GS4PLDMF3690L-L	158	12.8	-	102
GS4PLDMF3690L-W	158	12.6	-	102
GS4PLDMF3690R-AL	191	17.1	1	105
GS4PLDMF3690R-AW	191	17.4	1	105
GS4PLDMF3690R-L	158	12.8	-	103
GS4PLDMF3690R-W	158	12.6	-	103

# WEIGHTS + CUBES

Silea  
02/24

model number	weight	cubes	#locks	page
GS4PLDMF3696L-AL	195	17.5	1	104
GS4PLDMF3696L-AW	195	17.9	1	104
GS4PLDMF3696L-L	162	13.2	-	102
GS4PLDMF3696L-W	162	13.0	-	102
GS4PLDMF3696R-AL	195	17.5	1	105
GS4PLDMF3696R-AW	195	17.9	1	105
GS4PLDMF3696R-L	162	13.2	-	103
GS4PLDMF3696R-W	162	13.0	-	103
GS4PLDMH3066L-AL	120	12.5	1	108
GS4PLDMH3066L-AW	120	14.1	1	108
GS4PLDMH3066L-L	90	8.2	-	106
GS4PLDMH3066L-W	90	8.2	-	106
GS4PLDMH3066R-AL	120	12.5	1	109
GS4PLDMH3066R-AW	120	14.1	1	109
GS4PLDMH3066R-L	90	8.2	-	107
GS4PLDMH3066R-W	90	8.2	-	107
GS4PLDMH3072L-AL	121	13.0	1	108
GS4PLDMH3072L-AW	121	14.3	1	108
GS4PLDMH3072L-L	91	8.7	-	106
GS4PLDMH3072L-W	91	8.4	-	106
GS4PLDMH3072R-AL	121	13.0	1	109
GS4PLDMH3072R-AW	121	14.3	1	109
GS4PLDMH3072R-L	91	8.7	-	107
GS4PLDMH3072R-W	91	8.4	-	107
GS4PLDMH3078L-AL	122	12.9	1	108
GS4PLDMH3078L-AW	122	14.5	1	108
GS4PLDMH3078L-L	92	8.6	-	106
GS4PLDMH3078L-W	92	8.6	-	106
GS4PLDMH3078R-AL	122	12.9	1	109
GS4PLDMH3078R-AW	122	14.5	1	109
GS4PLDMH3078R-L	92	8.6	-	107
GS4PLDMH3078R-W	92	8.6	-	107
GS4PLDMH3084L-AL	128	13.7	1	108
GS4PLDMH3084L-AW	128	15.4	1	108
GS4PLDMH3084L-L	98	9.4	-	106
GS4PLDMH3084L-W	98	9.4	-	106
GS4PLDMH3084R-AL	128	13.7	1	109
GS4PLDMH3084R-AW	128	15.4	1	109
GS4PLDMH3084R-L	98	9.4	-	107
GS4PLDMH3084R-W	98	9.4	-	107
GS4PLDMH3090L-AL	130	14.0	1	108
GS4PLDMH3090L-AW	130	15.6	1	108
GS4PLDMH3090L-L	100	9.7	-	106
GS4PLDMH3090L-W	100	9.7	-	106
GS4PLDMH3090R-AL	130	14.0	1	109

model number	weight	cubes	#locks	page
GS4PLDMH3090R-AW	130	15.6	1	109
GS4PLDMH3090R-L	100	9.7	-	107
GS4PLDMH3090R-W	100	9.7	-	107
GS4PLDMH3096L-AL	132	14.3	1	108
GS4PLDMH3096L-AW	132	15.9	1	108
GS4PLDMH3096L-L	102	10.0	-	106
GS4PLDMH3096L-W	102	10.0	-	106
GS4PLDMH3096R-AL	132	14.3	1	109
GS4PLDMH3096R-AW	132	15.9	1	109
GS4PLDMH3096R-L	102	10.0	-	107
GS4PLDMH3096R-W	102	10.0	-	107
GS4PLDMH3666L-AL	132	13.8	1	108
GS4PLDMH3666L-AW	132	14.1	1	108
GS4PLDMH3666L-L	95	9.0	-	106
GS4PLDMH3666L-W	95	8.8	-	106
GS4PLDMH3666R-AL	132	13.8	1	109
GS4PLDMH3666R-AW	132	14.1	1	109
GS4PLDMH3666R-L	95	9.0	-	107
GS4PLDMH3666R-W	95	8.8	-	107
GS4PLDMH3672L-AL	133	14.3	1	108
GS4PLDMH3672L-AW	133	14.3	1	108
GS4PLDMH3672L-L	96	9.5	-	106
GS4PLDMH3672L-W	96	9.0	-	106
GS4PLDMH3672R-AL	133	14.3	1	109
GS4PLDMH3672R-AW	133	14.3	1	109
GS4PLDMH3672R-L	96	9.5	-	107
GS4PLDMH3672R-W	96	9.0	-	107
GS4PLDMH3678L-AL	134	14.2	1	108
GS4PLDMH3678L-AW	134	14.5	1	108
GS4PLDMH3678L-L	97	9.3	-	106
GS4PLDMH3678L-W	97	9.2	-	106
GS4PLDMH3678R-AL	134	14.2	1	109
GS4PLDMH3678R-AW	134	14.5	1	109
GS4PLDMH3678R-L	97	9.3	-	107
GS4PLDMH3678R-W	97	9.2	-	107
GS4PLDMH3684L-AL	140	15.0	1	108
GS4PLDMH3684L-AW	140	15.4	1	108
GS4PLDMH3684L-L	103	10.2	-	106
GS4PLDMH3684L-W	103	10.0	-	106
GS4PLDMH3684R-AL	140	15.0	1	109
GS4PLDMH3684R-AW	140	15.4	1	109
GS4PLDMH3684R-L	103	10.2	-	107
GS4PLDMH3684R-W	103	10.0	-	107
GS4PLDMH3690L-AL	142	15.3	1	108
GS4PLDMH3690L-AW	142	15.6	1	108



model number	weight	cubes	#locks	page
GS4PLDMH3690L-L	105	10.5	-	106
GS4PLDMH3690L-W	105	10.3	-	106
GS4PLDMH3690R-AL	142	15.3	1	109
GS4PLDMH3690R-AW	142	15.6	1	109
GS4PLDMH3690R-L	105	10.5	-	107
GS4PLDMH3690R-W	105	10.3	-	107
GS4PLDMH3696L-AL	144	15.5	1	108
GS4PLDMH3696L-AW	144	15.9	1	108
GS4PLDMH3696L-L	107	10.7	-	106
GS4PLDMH3696L-W	107	10.5	-	106
GS4PLDMH3696R-AL	144	15.5	1	109
GS4PLDMH3696R-AW	144	15.9	1	109
GS4PLDMH3696R-L	107	10.7	-	107
GS4PLDMH3696R-W	107	10.5	-	107
GS4PLWFP72-L	127	15.4	-	99
GS4PLWFP72-W	127	15.4	-	99
GS4PLWFP78-L	135	16.7	-	99
GS4PLWFP78-W	135	16.7	-	99
GS4PLWFP84-L	142	17.9	-	99
GS4PLWFP84-W	142	17.9	-	99
GS4PLWFP90-L	149	19.1	-	99
GS4PLWFP90-W	149	19.1	-	99
GS4PLWFP96-L	156	20.3	-	99
GS4PLWFP96-W	156	20.3	-	99
GS4PLWFP102-W	164	21.5	-	99
GS4PLWFP108-W	170	22.8	-	99
GS4PLWFP2472L-AL	166	21.6	1	100
GS4PLWFP2472L-AW	166	21.6	1	100
GS4PLWFP2472R-AL	166	21.6	1	101
GS4PLWFP2472R-AW	166	21.6	1	101
GS4PLWFP2478L-AL	174	22.8	1	100
GS4PLWFP2478L-AW	174	22.8	1	100
GS4PLWFP2478R-AL	174	22.8	1	101
GS4PLWFP2478R-AW	174	22.8	1	101
GS4PLWFP2484L-AL	181	24.0	1	100
GS4PLWFP2484L-AW	181	24.0	1	100
GS4PLWFP2484R-AL	181	24.0	1	101
GS4PLWFP2484R-AW	181	24.0	1	101
GS4PLWFP2490L-AL	189	25.3	1	100
GS4PLWFP2490L-AW	189	25.3	1	100
GS4PLWFP2490R-AL	189	25.3	1	101
GS4PLWFP2490R-AW	189	25.3	1	101
GS4PLWFP2496L-AL	196	26.5	1	100
GS4PLWFP2496L-AW	196	26.5	1	100
GS4PLWFP2496R-AL	196	26.5	1	101

model number	weight	cubes	#locks	page
GS4PLWFP2496R-AW	196	26.5	1	101
GS4PLWFP3072L-AL	174	23.5	1	100
GS4PLWFP3072L-AW	174	23.5	1	100
GS4PLWFP3072R-AL	174	23.5	1	101
GS4PLWFP3072R-AW	174	23.5	1	101
GS4PLWFP3078L-AL	182	24.7	1	100
GS4PLWFP3078L-AW	182	24.7	1	100
GS4PLWFP3078R-AL	182	24.7	1	101
GS4PLWFP3078R-AW	182	24.7	1	101
GS4PLWFP3084L-AL	189	25.9	1	100
GS4PLWFP3084L-AW	189	25.9	1	100
GS4PLWFP3084R-AL	189	25.9	1	101
GS4PLWFP3084R-AW	189	25.9	1	101
GS4PLWFP3090L-AL	197	27.2	1	100
GS4PLWFP3090L-AW	197	27.2	1	100
GS4PLWFP3090R-AL	197	27.2	1	101
GS4PLWFP3090R-AW	197	27.2	1	101
GS4PLWFP3096L-AL	204	28.4	1	100
GS4PLWFP3096L-AW	204	28.4	1	100
GS4PLWFP3096R-AL	204	28.4	1	101
GS4PLWFP3096R-AW	204	28.4	1	101
GS4PLWFP24102L-AW	204	27.7	1	100
GS4PLWFP24102R-AW	204	27.7	1	101
GS4PLWFP24108L-AW	210	28.9	1	100
GS4PLWFP24108R-AW	210	28.9	1	101
GS4PLWFP30102L-AW	212	29.6	1	100
GS4PLWFP30102R-AW	212	29.6	1	101
GS4PLWFP30108L-AW	218	30.8	1	100
GS4PLWFP30108R-AW	218	30.8	1	101
GS5BIN-LG	1	0.5	-	226
GS5BIN-SM	1	0.2	-	226
GS5CLS5H718L-LL	105	9.1	1	228
GS5CLS5H718L-WG	105	9.1	-	229
GS5CLS5H718L-WW	105	9.1	1	228
GS5CLS5H718R-LL	105	9.1	1	228
GS5CLS5H718R-WG	105	9.1	-	229
GS5CLS5H718R-WW	105	9.1	1	228
GS5CLS5H730L-LL	180	9.1	1	228
GS5CLS5H730L-WG	180	14.3	-	229
GS5CLS5H730L-WW	180	14.3	1	228
GS5CLS5H730R-LL	180	9.1	1	228
GS5CLS5H730R-WG	180	14.3	-	229
GS5CLS5H730R-WW	180	14.3	1	228
GS5CPD724-XL	48	4.9	-	227
GS5CPD724-XW	48	4.9	-	227

# WEIGHTS + CUBES

Silea  
02/24

model number	weight	cubes	#locks	page
GS5CPD730-SL	60	6.0	2	224
GS5CPD730-SW	60	6.0	2	224
GS5CPD730-XL	55	6.0	-	227
GS5CPD730-XW	55	6.0	-	227
GS5CPD736-SL	72	7.1	2	224
GS5CPD736-SW	72	7.1	2	224
GS5CPD736-XL	62	7.1	-	227
GS5CPD736-XW	62	7.1	-	227
GS5CPD742-SL	84	8.2	2	224
GS5CPD742-SW	84	8.2	2	224
GS5CPD742-XL	69	8.2	-	227
GS5CPD742-XW	69	8.2	-	227
GS5CPD748-SL	96	9.3	2	224
GS5CPD748-SW	96	9.3	2	224
GS5CPD754-SL	108	10.4	2	224
GS5CPD754-SW	108	10.4	2	224
GS5CPD760-SL	120	11.5	4	225
GS5CPD760-SW	120	11.5	4	225
GS5CPD766-SL	132	12.6	4	225
GS5CPD766-SW	132	12.6	4	225
GS5CPD772-SL	144	13.7	4	225
GS5CPD772-SW	144	13.7	4	225
GS5CVATR3666L-LL	382	40.6	-	220
GS5CVATR3666L-WW	382	40.6	-	220
GS5CVATR3666R-LL	382	40.6	-	221
GS5CVATR3666R-WW	382	40.6	-	221
GS5CVATR3672L-LL	389	41.1	-	220
GS5CVATR3672L-WW	389	41.1	-	220
GS5CVATR3672R-LL	389	41.1	-	221
GS5CVATR3672R-WW	389	41.1	-	221
GS5CVATR3678L-LL	406	42.2	-	220
GS5CVATR3678L-WW	406	42.2	-	220
GS5CVATR3678R-LL	396	42.2	-	221
GS5CVATR3678R-WW	396	42.2	-	221
GS5CVATR3684L-LL	412	42.8	-	220
GS5CVATR3684L-WW	412	42.8	-	220
GS5CVATR3684R-LL	402	42.8	-	221
GS5CVATR3684R-WW	402	42.8	-	221
GS5CVATR4266L-LL	411	46.0	-	220
GS5CVATR4266L-WW	411	46.0	-	220
GS5CVATR4266R-LL	411	46.0	-	221
GS5CVATR4266R-WW	411	46.0	-	221
GS5CVATR4272L-LL	418	46.7	-	220
GS5CVATR4272L-WW	418	46.7	-	220
GS5CVATR4272R-LL	418	46.7	-	221

model number	weight	cubes	#locks	page
GS5CVATR4272R-WW	418	46.7	-	221
GS5CVATR4278L-LL	436	47.8	-	220
GS5CVATR4278L-WW	436	47.8	-	220
GS5CVATR4278R-LL	426	47.8	-	221
GS5CVATR4278R-WW	426	47.8	-	221
GS5CVATR4284L-LL	444	48.5	-	220
GS5CVATR4284L-WW	444	48.5	-	220
GS5CVATR4284R-LL	434	48.5	-	221
GS5CVATR4284R-WW	434	48.5	-	221
GS5CVATS304266L-LL	411	46.0	-	222
GS5CVATS304266L-WW	411	46.0	-	222
GS5CVATS304266R-LL	411	46.0	-	223
GS5CVATS304266R-WW	411	46.0	-	223
GS5CVATS304272L-LL	418	46.7	-	222
GS5CVATS304272L-WW	418	46.7	-	222
GS5CVATS304272R-LL	418	46.7	-	223
GS5CVATS304272R-WW	418	46.7	-	223
GS5CVATS304278L-LL	436	47.8	-	222
GS5CVATS304278L-WW	436	47.8	-	222
GS5CVATS304278R-LL	426	47.8	-	223
GS5CVATS304278R-WW	426	47.8	-	223
GS5CVATS304284L-LL	444	48.5	-	222
GS5CVATS304284L-WW	444	48.5	-	222
GS5CVATS304284R-LL	434	48.5	-	223
GS5CVATS304284R-WW	434	48.5	-	223
GS5LKR5H724L-LG	155	21.2	-	231
GS5LKR5H724L-LL	155	21.2	-	230
GS5LKR5H724L-WG	155	11.7	-	231
GS5LKR5H724L-WW	155	11.7	-	230
GS5LKR5H724R-LG	155	21.2	-	231
GS5LKR5H724R-LL	155	21.2	-	230
GS5LKR5H724R-WG	155	11.7	-	231
GS5LKR5H724R-WW	155	11.7	-	230
GS5LKR5H736L-LG	195	21.2	-	231
GS5LKR5H736L-LL	195	21.2	-	230
GS5LKR5H736L-WG	195	16.9	-	231
GS5LKR5H736L-WW	195	16.9	-	230
GS5LKR5H736R-LG	195	21.2	-	231
GS5LKR5H736R-LL	195	21.2	-	230
GS5LKR5H736R-WG	195	16.9	-	231
GS5LKR5H736R-WW	195	16.9	-	230
GS5PNCLCUP-MPLE	1	0.2	-	233
GS5PNCLCUP-WLNT	1	0.2	-	233
GS5PNCLTRAY-MPLE	2	0.2	-	233
GS5PNCLTRAY-WLNT	2	0.2	-	233

model number	weight	cubes	#locks	page
GS5TRAY-LG	1	0.2	-	226
GS5TRAY-SM	1	0.1	-	226
GS6GBG2448-LL	111	28.9	-	140
GS6GBG2448-WW	111	28.9	-	140
GS6GBG2454-LL	123	32.5	-	140
GS6GBG2454-WW	123	32.5	-	140
GS6GBG2460-LL	36.1	135.0	-	140
GS6GBG2460-WW	36.1	135.0	-	140
GS6GCR2472L-LL	236	45.0	-	142
GS6GCR2472L-WW	236	45.0	-	142
GS6GCR2472R-LL	236	45.0	-	142
GS6GCR2472R-WW	236	45.0	-	142
GS6GCR2478L-LL	249	48.6	-	142
GS6GCR2478L-WW	249	48.6	-	142
GS6GCR2478R-LL	249	48.6	-	142
GS6GCR2478R-WW	249	48.6	-	142
GS6GCR2484L-LL	261	52.3	-	142
GS6GCR2484L-WW	261	52.3	-	142
GS6GCR2484R-LL	261	52.3	-	142
GS6GCR2484R-WW	261	52.3	-	142
GS6G DFA4284L-LL	491	83.7	-	132
GS6G DFA4284L-WW	491	83.7	-	132
GS6G DFA4284R-LL	491	83.7	-	132
GS6G DFA4284R-WW	491	83.7	-	132
GS6G DFA42102L-ALL	599	101.4	1	133
GS6G DFA42102L-AWW	599	101.3	1	133
GS6G DFA42102R-ALL	599	101.4	1	133
GS6G DFA42102R-AWW	599	101.3	1	133
GS6G DFF4284L-LL	316	85.7	-	136
GS6G DFF4284L-WW	316	85.7	-	136
GS6G DFF4284R-LL	316	85.7	-	136
GS6G DFF4284R-WW	316	85.7	-	136
GS6G DFF42102L-ALL	424	103.8	1	137
GS6G DFF42102L-AWW	424	103.8	1	137
GS6G DFF42102R-ALL	424	103.8	1	137
GS6G DFF42102R-AWW	424	103.8	1	137
GS6G DR3072-LL	269	55.7	-	138
GS6G DR3072L-LL	269	55.7	-	139
GS6G DR3072L-WW	269	55.7	-	139
GS6G DR3072R-LL	269	55.7	-	139
GS6G DR3072R-WW	269	55.7	-	139
GS6G DR3072-WW	269	55.7	-	138
GS6G DR3672-LL	299	66.4	-	138
GS6G DR3672L-LL	299	66.4	-	139
GS6G DR3672L-WW	299	66.4	-	139
GS6G DR3672R-LL	299	66.4	-	139
GS6G DR3672R-WW	299	66.4	-	139
GS6G DR3672-WW	299	66.4	-	138
GS6G DTT72-L	36	4.3	-	144
GS6G DTT72-S	39	5.2	-	144
GS6G DTT72-W	36	4.3	-	144
GS6G DTT84-L	42	5.0	-	144
GS6G DTT84-S	46	6.0	-	144
GS6G DTT84-W	42	5.0	-	144
GS6G DTT144-L	72	6.0	-	144
GS6G DTT144-S	78	6.9	-	144
GS6G DTT144-W	72	6.0	-	144
GS6G DTT168-L	84	6.9	-	144
GS6G DTT168-S	92	7.9	-	144
GS6G DTT168-W	84	6.9	-	144

model number	weight	cubes	#locks	page
GS6G DR3672R-LL	299	66.4	-	139
GS6G DR3672R-WW	299	66.4	-	139
GS6G DR3672-WW	299	66.4	-	138
GS6G DR3684-LL	327	77.1	-	138
GS6G DR3684L-LL	327	77.1	-	139
GS6G DR3684L-WW	327	77.1	-	139
GS6G DR3684R-LL	327	77.1	-	139
GS6G DR3684R-WW	327	77.1	-	139
GS6G DR3684-WW	327	77.1	-	138
GS6G DR30144-LL	458	109.5	-	138
GS6G DR30144LR-LL	458	109.5	-	139
GS6G DR30144LR-WW	458	109.5	-	139
GS6G DR30144-WW	458	109.5	-	138
GS6G DR36144-LL	503	130.5	-	138
GS6G DR36144LR-LL	503	130.5	-	139
GS6G DR36144LR-WW	503	130.5	-	139
GS6G DR36144-WW	503	130.5	-	138
GS6G DR36168-LL	559	151.9	-	138
GS6G DR36168LR-LL	559	151.9	-	139
GS6G DR36168LR-WW	559	151.9	-	139
GS6G DR36168-WW	559	151.9	-	138
GS6G DTR3072-LL	269	55.7	-	138
GS6G DTR3072L-LL	269	55.7	-	139
GS6G DTR3072L-WW	269	55.7	-	139
GS6G DTR3072R-LL	269	55.7	-	139
GS6G DTR3072R-WW	269	55.7	-	139
GS6G DTR3072-WW	269	55.7	-	138
GS6G DTR3672-LL	299	66.4	-	138
GS6G DTR3672L-LL	299	66.4	-	139
GS6G DTR3672L-WW	299	66.4	-	139
GS6G DTR3672R-LL	299	66.4	-	139
GS6G DTR3672R-WW	299	66.4	-	139
GS6G DTR3672-WW	299	66.4	-	138
GS6G DTT72-L	36	4.3	-	144
GS6G DTT72-S	39	5.2	-	144
GS6G DTT72-W	36	4.3	-	144
GS6G DTT84-L	42	5.0	-	144
GS6G DTT84-S	46	6.0	-	144
GS6G DTT84-W	42	5.0	-	144
GS6G DTT144-L	72	6.0	-	144
GS6G DTT144-S	78	6.9	-	144
GS6G DTT144-W	72	6.0	-	144
GS6G DTT168-L	84	6.9	-	144
GS6G DTT168-S	92	7.9	-	144
GS6G DTT168-W	84	6.9	-	144

# WEIGHTS + CUBES

Silea  
02/24

model number	weight	cubes	#locks	page
GS6GDXA4284L-LL	494	91.7	-	130
GS6GDXA4284L-WW	494	91.7	-	130
GS6GDXA4284R-LL	494	91.7	-	130
GS6GDXA4284R-WW	494	91.7	-	130
GS6GDXA42102L-ALL	602	111.0	1	131
GS6GDXA42102L-AWW	602	111.0	1	131
GS6GDXA42102R-ALL	602	111.0	1	131
GS6GDXA42102R-AWW	602	111.0	1	131
GS6GDXF4284L-LL	316	85.6	-	134
GS6GDXF4284L-WW	316	85.6	-	134
GS6GDXF4284R-LL	316	85.6	-	134
GS6GDXF4284R-WW	316	85.6	-	134
GS6GDXF42102L-ALL	424	103.6	1	135
GS6GDXF42102L-AWW	424	103.6	1	135
GS6GDXF42102R-ALL	424	103.6	1	135
GS6GDXF42102R-AWW	424	103.6	1	135
GS6GDXMT72-L	174	14.5	-	143
GS6GDXMT72-S	240	54.3	-	143
GS6GDXMT72-W	174	14.5	-	143
GS6GRT2448L-LL	151	29.8	-	141
GS6GRT2448L-WW	151	29.8	-	141
GS6GRT2448R-LL	151	29.8	-	141
GS6GRT2448R-WW	151	29.8	-	141
GS6GRT2454L-LL	163	33.4	-	141
GS6GRT2454L-WW	163	33.4	-	141
GS6GRT2454R-LL	163	33.4	-	141
GS6GRT2454R-WW	163	33.4	-	141
GS6GRT2460L-LL	175	37.0	-	141
GS6GRT2460L-WW	175	37.0	-	141
GS6GRT2460R-LL	175	37.0	-	141
GS6GRT2460R-WW	175	37.0	-	141
GS6GTK71R	14	3.6	-	145
GS6GTK72	14	3.6	-	145
GS6GTK77R	15	3.8	-	145
GS6GTK78	15	3.8	-	145
GS6GTK83R	16	4.1	-	145
GS6GTK84	16	4.1	-	145
GS6GTK89R	17	4.4	-	145
GS6GTK94R	19	3.6	-	145
GS6GTK95R	18	4.6	-	145
GS6GTK100R	22	3.1	-	145
GS6GTK106R	24	3.2	-	145
GS6GTK112R	26	3.4	-	145
GS6GTK118R	28	3.6	-	145
GS6GTK124R	30	3.4	-	145

model number	weight	cubes	#locks	page
GS6GTK130R	32	3.6	-	145
GS6GTK144	30	4.3	-	145
GS6GTK168	32	4.9	-	145
GS6GXTK72	13	3.5	-	145
GS6MB24SS-L	30	5.3	-	146
GS6MB24SS-W	30	5.2	-	146
GS6MB24SS-WS	50	5.2	-	146
MDWBRK	1	0.4	-	217
MDWLBK24	2	0.3	-	217
MDWLBK30	2	0.4	-	217
SACORNER	8	1.7	-	327
SADSKPAD	10	2.3	-	327
SAMAGNET	1	0.1	-	329



---

---

# Gunlocke®

One Gunlocke Drive  
Wayland, NY 14572  
800 828 6300

[GUNLOCKE.COM](http://GUNLOCKE.COM)

FORM #G1066.A3 (5/24)