

Casegoods & Storage

Price & Specification Guide 2024

Prices effective February 1, 2024

PDF updated March 5, 2024

Limited Lifetime Warranty

Our unwavering commitment to our customers compels us to care, and our dedication to quality is just one of the ways we show our customers how much they mean to us.

We recognize that keeping up with the pace of change requires having products that work as hard as the people who use them. That's why each of our products is rigorously tested and certified to meet the highest industry standards.

In the unlikely event that any Allsteel product or component covered by the Allsteel Warranty should fail under normal workplace use because of defective material or workmanship, Allsteel promises to fix it. Because taking care of *people* is how Allsteel takes care of business.

For information on Allsteel's warranty coverage, visit AllsteelOffice.com.

Government Support – GovernmentSupport@hniworkplacefurnishings.com
Product, Parts, Non-Warranty Parts Orders – ProductSupport@hniworkplacefurnishings.com
Quick Ship Orders – QuickShip@hniworkplacefurnishings.com
Order Status – OrderStatus@hniworkplacefurnishings.com
General Inquiries – GeneralSupport@hniworkplacefurnishings.com

- Software support packages furnished to the customer, either by Allsteel® or by another source, which support the sale of Allsteel products are superseded by printed price lists.
- Prices are subject to change without notice. All orders are subject to prices in effect at the time of order.
- Please refer to your Allsteel Dealer Sales and Discount Policies for order placement information and terms and conditions.
- Additional copies of this Specification and Price List are available upon request from Allsteel Literature Fulfillment at 1-866-255-7833.

- Ordering information appears at the bottom of each product page complete with examples on how to specify. Fabric and finish pages are referenced at the bottom of product pages.

This publication is available as an interactive or downloadable PDF at www.allsteeloffice.com.

Questions or Comments?

Please call us at: **888-ALLSTEEL**
888-255-7833

Warranty	Inside Front Cover
New, Revised, and Discontinued Products	4
COM, Specials Policies, and Programs	5-9
Upholstery and Finishes	10-21
Storage Introduction and Pull Option Matrix	22-23
Working with Digital Lock	24-25
ALIGN™ METAL STORAGE	
Statement of Line	26-27
Finishes	30-31
Working with Align Metal Storage	32-34
Dimensions	35
File/Load Capacities	36-37
Align Metal Pedestal Specifications	38-39
Credenzas and Accessories	40-41
Metal Credenzas with Panel Frames	42
Lateral/Personal/Laminate Top Specifications	43
Tower Specifications	44-45
Locker Specifications	46
Support, Mobile, and Freestanding Pedestals	47-50
Pedestal Tops and Accessories	51
22" H Credenzas	52-60
22" H Pedestals	61
Open Shelf & HAT Credenzas	62
Wire Management	63
Align Accessories	64-66
28" H Laterals, Personal Files, and Bookcases	67
Align Metal Towers	68-79
Align Lockers, Wardrobes, and Accessories	80-90
Digital Lock Keys and Accessories	91
Storage Islands	92-102
ESSENTIALS™ METAL	
Finishes	104
Working with Essentials Metal Storage	105-110
Essentials Metal Pedestals and Accessories	111-113
Essentials Metal Lateral Files	114
Essentials Metal Combination Files	115
Essentials Metal Storage Cabinets	116
Essentials Metal Bookcases	117
VERTICAL METAL STORAGE	
Finishes	120
Working with Vertical Files	121
A990 / A940 Series Vertical Files	122
METAL OVERHEADS & SHELVES	
Finishes	124
Working with Terrace Overheads, Shelves, and Hutches	125-128
Overhead Cabinets, Shelves, and Up-mount Kits	129-130
Hutches, Tackboards, and Accessories	131
RADII™ STORAGE	
Finishes	134
Digital Lock Specifications	135
Pedestal Functionality with Work Tools	136
Freestanding and Mobile Pedestals	137-140
Pedestal Functionality with Work Tools	141
Undermount, L-Cube, and Work Tools	142-144
Caddy	145
Digital Lock Keys and Accessories	146

APPROACH™	
Overview	147-172
Approach Statement of Line	149-152
Finishes	173
Laminate Storage Brackets	174
Approach and Involve Laminate Wood Storage	175-176
Storage Open Plan Supports	177-178
Working with Approach	179-201
Desks	202-204
Pedestals	205-206
Credenzas	207-217
Storage Back Panels	218
Lateral Files	219
Bookcases	220
False Peds / Wall Access Panels / Bridges	221
Table Tops	222
Worksurfaces and Supports	223-226
Modesty Panels — Laminate	227
Towers and Wardrobes	228-237
Overheads and Stack on Storage	238-241
Tackboards & Writable Boards	242-243
Counterweights & Accessories	244
Altitude Height-Adjustable	245-248
INVOLVE®	
Finishes	250
Involve® Overview	251-252
Working with Involve®	253-272
Pedestals, Credenzas, and Bookcases	273-280
Soft Seating	281-286
Storage Towers	287-291
Stacking Storage	292
Overheads, Shelves, Stanchions, Hutches, and Tackboards	293-298
Worksurfaces — 18" D / Primary / EZ View	299
Worksurface Supports	300-301
Screens	302-304
FURTHER™	
Finishes	306
Statement of Line	307
Working with Storage	308-309
Pedestals and Credenzas	310
Storage Towers	311
AWARE®	
Credenzas	312-313
EXTENSIONS™	
Working with Ergonomic Accessories	315-316
Working with Organization Tools	317-322
Working with Illumination	323-326
Power/Data Modules	327
ACCESSORIES	
Working with Pivot Monitor Arms	328-331
APPENDIX AND INDEX	
Locking Specification/Easy Lock	332-334
Touch-Up Paint	335
Fabric Grades G-J and Upholstery Grades 9-23	336-337
Index — Model Numbers with Page Reference	338-345

COM Program

Allsteel understands that customers may at times want to specify fabrics outside of Allsteel’s standard fabric offering. Our COM program was designed to make specifying COMs on Allsteel products a simpler, friendlier, and hassle-free process. This process is simple and easy to use, and is described below under “Allsteel to Supply (ATS).” If a Dealer wishes to manage the COM process themselves, they can do so by following guidelines under “Dealer to Supply (DTS)”. **ATS is the preferred method for all COM fabrics.** With ATS, Company will provide acknowledgment based upon planned date of receipt of COM fabric and manage the entire process. DTS is allowed if it is not a partnership fabric or if Company does not have access to the supplier. **DTS may cause order delays and is strongly discouraged.** Find out more about Allsteel’s COM process by emailing our COM Department at allsteelcomteam@allsteeloffice.com.

Allsteel to Supply (ATS):

1. Select the fabric you wish to use and check the COM Search on Synergy at: Allsteelsynergy/Design Resources/Textiles & Finishes/COM Search or COM Search quick link. You will need to have the COM supplier’s name, fabric pattern name, and color name to search for approved fabrics.
2. If your fabric is listed as an approved fabric, you may place your order directly with Allsteel Customer Support. Please use the fabric code (e.g., S216426XP) from the COM Test Request on your order in the place of the standard fabric code.

If your fabric is not listed as approved, you will need to select the “Request COM Test” link on the COM Search website. If your fabric is not listed as approved, and it is not a Partnership fabric you may request a “Dealer to Supply” code. Select the “Request COM Test” link on the COM Search website. Your name, company name and email will be prepopulated fields. The secondary email, project name, and bid/contract number are optional information. The supplier, pattern, and color will show a list by clicking in the box and entering the first letter of the name and these are free form text boxes. Once that information is entered click add. (Multiple series can be added to the same request if they are the same supplier, pattern, and color.) Then click submit.
3. An email will be sent to the to the requestor stating the COM Request was successfully submitted. Up to four emails could be received: Testing materials requested, in testing, and final approval/denial with price grade and fabric code. It’s rare actual test yardage is required. Testing is mainly done by reviewing the attributes of the fabric. The testing process takes approximately 48 hours. Written COM price quotes hold pricing for 90 days after issue date.
4. Once the fabric has been approved by Allsteel, enter your order directly with Allsteel Customer Support. Allsteel will purchase all COM fabric directly from the COM suppliers and schedule for production.

In the event that the Dealer decides to cancel a COM fabric order, the Dealer is responsible for the cost of the fabric plus a handling charge that is equal to 10% of the fabric cost.

Dealer to Supply (DTS):

1. Select the fabric you wish to use and check the COM Search on Synergy at: Allsteelsynergy/Design Resources/Textiles & Finishes/COM Search or COM Search quick link. Or call Allsteel Customer Support to see if the fabric you have chosen has already been tested and approved on the product you are interested in.

You will need to have the COM supplier’s name, fabric pattern name, and color name for this inquiry.
2. If your fabric is not listed as approved, and it is not a Partnership fabric you may request a “Dealer to Supply” code. Select the “Request COM Test” link on the COM Search website. Your name, company name and email will be prepopulated fields. The secondary email, project name, and bid/contract number are optional information. The supplier, pattern, and color will show a list by clicking in the box and entering the first letter of the name and these are free form text boxes. Once that information is entered click add. (Multiple series can be added to the same request if they are the same supplier, pattern, and color.) Then click submit.
3. An email will be sent to the to the requestor stating the COM Request was successfully submitted. Up to four emails could be received: Testing materials requested, in testing, and final approval/denial with price grade and fabric code. It’s rare actual test yardage is required. Testing is mainly done by reviewing the attributes of the fabric. The testing process takes approximately 48 hours.
4. Make sure to use a “Dealer to Supply” COM code (e.g., S216426ZP) and place your order directly with Allsteel Customer Support.
5. All “Dealer to Supply” orders will be charged Grade 4 pricing for seating, Grade 3 for Gather, and Grade D pricing for panels. Dealers will pay for the COM fabric separately.
6. All “Dealer to Supply” fabric must be sent on a fabric roll. Estimate the yardage required by using the yardage requirements listed in the price list by model. For questions please contact Allsteel Customer Support.
7. Place your fabric order directly with the COM Supplier with instructions for the fabric to be sent on a fabric roll to:

HNI Textile Distribution Center
COM Production Yardage — PO Number
 Docks 20-22
 301 Mulberry Avenue
 Muscatine, IA 52761

Information that MUST be included in the packing slip attached to the DTS fabric:

1. Dealer's Purchase Order number to Allsteel
2. Allsteel's Tracking number for the COM fabric
3. Dealer Name
4. Yards of Fabric

If the fabric shipment does not match the correct fabric and yardage, Allsteel will notify the Dealer for resolution.

If Allsteel receives fabric with incorrect labeling or fabric yardage that cannot be linked to an Allsteel furniture order, Allsteel will hold the fabric for up to 4 weeks. After 4 weeks Allsteel will dispose of the fabric. There are no exceptions to this policy.

Specific to DTS orders - The customer should send only the amount needed for the order. Excess yardage, or yardage not attached to an order will be disposed of at Allsteel's discretion.

Any canceled orders are subject to cancellation charges up to the full value of the Allsteel product canceled. Allsteel will determine the actual cancellation charge at the time the cancellation is requested.

8. For additional details on "Dealer to Supply" fabric refer to your Allsteel terms and conditions.

Additional Policy Information:

The company assumes no responsibility for the overall appearance, flammability, normal durability, colorfastness, or any other quality standards. The company reserves the right to reject a COM if the quality of the COM is not satisfactory for the product. Should this occur, the customer will be notified with an explanation when the issue is found.

The company is not responsible for fabric that has become obsolete at the COM supplier, that is of poor quality, or that is delivered late to the manufacturer from the COM supplier.

All cancellations or changes to COM orders are subject to Company approval. Because of the nature of COM, special fabrics, finishes, and structural modifications, products ordered as specials and then canceled prior to shipment are subject to cancellation costs up to the full value of the product canceled. The company determines the actual cancellation charge at the time the cancellation is requested. Upon approval, a cancellation number is issued to the Customer.

Purchase orders will not be accepted or entered unless the testing process is complete with positive results.

If all testing has been previously completed, re-testing is only necessary if fabric is to be used on a different product, or pattern direction has changed from that previously approved.

Previous test results can be obtained by a customer on the COM Search on Synergy or by calling Allsteel Customer Support.

All COM fabric will be applied to seating and panel systems Pattern Cut unless Railroad Cut is requested and approved on the COM Test Request. Any fabrics approved as a width pass, the dealer is responsible for clarifying Railroad Cut on orders containing items that are too large to support the Pattern Cut of a fabric application (any items larger than 48" high or wide).

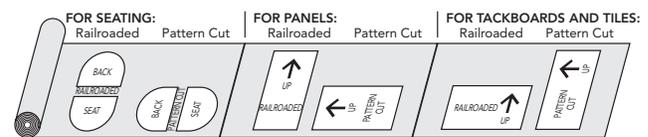

Fire Retardant

The Dealer is responsible for ensuring that the COM fabric is certified to meet all flame retardant requirements.

For more information, please contact Allsteel Customer Support.

YARDAGE REQUIREMENTS FOR FABRIC WITH REPEATS — FOR USE ON GATHER™ PRODUCTS

Fabric Width	Plain Fabric	2"– 14" Repeat	15"– 19" Repeat	20"– 27" Repeat	28"– 36" Repeat
54"	0	+15%	+20%	+25%	+30%
53"	+6%	+19%	+24%	+28%	+36%
52"	+13%	+23%	+28%	+33%	+38%
51"	+19%	+26%	+31%	+36%	+41%
50"	+25%	+30%	+35%	+40%	+45%
49"	+30%	+35%	+40%	+45%	+50%
48"	+35%	+40%	+45%	+50%	+55%
47"	+45%	+50%	+55%	+58%	+65%

Depending upon the pattern repeat, it may be necessary to pattern cut the fabric. This will require 10% additional fabric.

To calculate multiple repeats (vertical and horizontal), add each repeat for total yardage required. For example for a fabric width of 54": 7" vertical requires 15%, 15" horizontal requires 20% total additional yardage required equals 35% (15% + 20%). Therefore, if your chair requires 2 yards of fabric, multiply 2 by 35%. Then 2.7 yards will be yardage required.

Special Paint & Stain Policy

Allsteel at its own discretion may modify its standard products with non-standard paint and stain colors to meet specific needs. Dealer is required to submit a special paint or stain request via the COM Search on Synergy. A sample of the non-standard paint or stain color desired will be required for matching. Pricing, lead time, and order information will be provided at the time of approval.

- For each new requested stain or paint, there will be a \$500 net fee to cover supplier costs to match the special item.
- For existing, previously-approved stains or paints, there is no \$500 matching fee, however, there is a sample chip fee of \$175 net for stains and \$100 net for paints.
- Samples, preferably at least 3" x 5" chips, of the exact color desired should be sent to the Allsteel Tailored Products Group. Paint matches require (3) sample chips and stain matches require (3) sample chips. Please mail these sample chips to the address below and reference the Special Item Request Number from Tailored Solutions.

Allsteel Inc.

Attn: COM Team
200 Oak St.
Muscatine, IA 52761

- Allsteel will color match the sample and send control samples to the address provided in the request. Dealer will review Allsteel's color match and approve by signing the back of the sample chip. Send the signed sample back to the Allsteel Tailored Products Group.
- Special paints will be assigned a paint price grade.
- Orders will not be accepted until Allsteel receives the Dealer's written approval on the color match.
- Extended lead times will apply on orders containing special paints or stains.
- Due to manufacturing techniques, materials, and quality issues, some exclusions will apply and some matches may be declined.

Important Notes

- Natural veneer is subject to nature's quality control. Differences in grain and color are naturally occurring variations and cannot be controlled by the manufacturer and cannot be considered as product defects. Natural veneer has the characteristics and beauty of a living organism; with its own variations of grain, growth, and color patterns. For these reasons, Natural veneer is preferred by many for its warmth and personal characteristics.
- Color changes will occur over time when wood is exposed to light. For this reason, when new product is ordered as an addition to existing product, there will be color variances between the old and new product. Please remember when specifying new product that although the species of veneer will be the same, additional product is being manufactured from a different tree. It may take several months for the new furniture to mature to the color level of existing product. Even with this maturation process the additional product will not be an exact match.

Special Laminate Policy

The Company at its own discretion may modify its standard products with non-standard laminates to meet specific needs. Contact the Allsteel Tailored Products Group for pre-approved Wilsonart, Formica, Nevamar and Pionite laminates and pricing for special laminates. When requesting a special laminate please supply manufacturer, along with name and pattern number of laminate.

- Extended lead times will apply on orders containing special laminates.
- Due to manufacturing techniques, materials, and quality issues, some product exclusions will apply and some requests may be declined.

Veneer Care Instructions

Veneer worksurfaces feature the Gunlocke® finishing system. The finishing system is a process that begins with the application of stains, which promote exceptional depth and clarity. Next the worksurface receives a specialized coating that provides exceptional durability and chemical resistance. The remaining surfaces receive a top coat. These finishing processes ensure depth, clarity, color consistency and durability throughout the product.

Caring for your veneer finish:

- General maintenance procedures entail wiping clean the entire surface with a clean, water dampened soft cloth once per week (be sure to wipe with the grain)
- Murphy's® Oil Soap may be used as a general purpose type cleaner with warm water to clean tops.
- The finish may also be polished with Guardsman® Furniture Polish (contains no waxes or silicones) to provide renewed luster.
- Be sure to wipe up all spills immediately. Do not allow spills to dry.

Wood owes its inherent beauty to variations in color, grain and texture, and therefore, these variations are not considered defects. There may be minor variations from one piece of furniture to the next even though they are finished at the same time. Exposure to light and the aging process will cause a darkening of natural wood products. Light finishes on wood products do not mask the natural characteristics of wood. Allsteel does not guarantee the exact matching of grain, pattern and color.

Allsteel Open Line Laminate Program

The Open Line Laminate (OLL) program makes it even easier for a customer to tailor their Allsteel product for a custom look. Select Allsteel furniture products accommodate hundreds of graded-in high-pressure laminates (HPL) from the leading laminate manufacturers' open lines.

Laminates that are currently available in the program can be viewed in specification tools.

Requests to add laminates to the standard specials program can be submitted through the CET Specials Integration tool as well as Community.

Matching edge options are not available offered for laminates in the OLL program. When selecting a laminate please select an edge option from the Allsteel standard offering. If a matching edge is required a modification request can be submitted through the CET Specials Integration tool as well as Community.

Due to manufacturing techniques, materials, quality issues of varying laminates, and minimum order quantities some product exclusions will apply, and some requests may be declined.

Extended lead times may apply on orders containing special laminates.

Contact the Tailored Products Group for questions or additional information regarding pre-approved laminates and pricing.

Allsteel

Phone: 888-255-7833 Option 4.2

Email: ASITPG@allsteeloffice.com

For edge band recommendations from the Allsteel standard offering, please email the HNI Workplace Colors, Materials and Finishes team at allsteel finishes@allsteeloffice.com.

Allsteel edge samples can be ordered through the Allsteel Synergy literature site, <https://www.allsteelsynergy.com>.

For laminate samples, please contact the manufacturer directly:

Wilsonart

<https://www.wilsonart.com/>

1-800-433-3222

Formica

<https://www.formica.com/en-us/>

1-800-FORMICA (367-6422)

Nevamar and Pionite

<https://www.panolam.com>

877-726-6526

Everyday Advantage[®]

New terms and conditions for EDA:

1. Orders must clearly state “Everyday Advantage Order” and include the appropriate Everyday Advantage contract number:
 - Everyday Advantage Std-0125, Everyday Advantage Canada-0127
2. Everyday Advantage orders are not eligible for bid pricing.
3. Program discounting includes the complete Optimize, Further, Terrace, and Stride systems lines, private office solution, Approach and Involve storage. This program also includes Acuity, Access, Evo, Inspire, Lyric, Mimeo, Nimble, Quip, Relate, Seek, and Svelte, seating. Altitude, Aware, and Structure tables are also available, along with Align pedestals, lockers and metal storage and Essentials pedestals, and Radii storage lines. In addition, Extensions ergonomic accessories and lighting are part of the standard offering. All other product not called out is available for order on the contract but will receive standard discounting of 55%–65%.
4. All textiles and finishes except for veneer and some wood finishes are available, depending on quantity and selection, and may have extended lead times.
5. Everyday Advantage orders are not limited to a minimum or maximum.
6. All orders ship based on standard lead times. Large-quantity orders of like products may be subject to longer lead times.
7. Standard freight terms apply.
8. If driver assistance is needed, standard driver assist charges will be added at time of order entry.

Allsteel Inc. reserves the right to amend or terminate this program at anytime with 30 days written notice. Allsteel is not liable for service delays caused by force majeure (circumstances beyond Allsteel's control).

Refer to page 13 for current upholstery availability by model/series.

GSA Reference Page

ALLSTEEL MATERIALS PARTNERSHIP PROGRAM — See program explanation at bottom of page.

UPHOLSTERY

GRADE 2	GRADE 4	GRADE 4 – continued	GRADE 4 – continued	GRADE 4 – continued
Maharam MELD	HBF Textiles BLINK	Maharam MANNER	Maharam MERIT	Maharam METRIC
Amethyst.....SMHMMLD18	Bright Blue.....1048-59	Ablaze.....SMHMMAN13	Aegean.....SMHMMER15	Admiral.....SMHMMET26
Antler.....SMHMMLD13	Dark Violet.....1048-77	Aquatic.....SMHMMAN22	Alert.....SMHMMER37	Alligator.....SMHMMET20
Bare.....SMHMMLD26	Dove Grey*.....1048-83	Atmospheric*..SMHMMAN36	Armada.....SMHMMER16	Anchor.....SMHMMET24
Blonde.....SMHMMLD27	Lemon Yellow*.....1048-22	Baroness*.....SMHMMAN53	Arrow*.....SMHMMER33	Arabica*.....SMHMMET09
Bride.....SMHMMLD10	Ocean Blue*.....1048-56	Basin.....SMHMMAN26	Bellini*.....SMHMMER24	Aztec*.....SMHMMET41
Bulb.....SMHMMLD09	Peppery.....1048-90	Butterscotch*...SMHMMAN16	Beluga*.....SMHMMER02	Bittersweet*....SMHMMET08
Clementine.....SMHMMLD23	Red Orange.....1048-44	Caper*.....SMHMMAN19	Blackout*.....SMHMMER04	Bonsai*.....SMHMMET22
Comet.....SMHMMLD29	Sea Green*.....1048-67	Carob*.....SMHMMAN02	Blizzard*.....SMHMMER10	Brick*.....SMHMMET11
Crater.....SMHMMLD14	Silvery.....1048-80	Charisma*.....SMHMMAN49	Brass.....SMHMMER32	Canary*.....SMHMMET39
Creek.....SMHMMLD40		Citronella*.....SMHMMAN45	Cabernet.....SMHMMER39	Caramel*.....SMHMMET17
Fox.....SMHMMLD24	Maharam CAPER	Cloudburst*....SMHMMAN37	Eggplant*.....SMHMMER40	Cardinal.....SMHMMET12
Fuchsia.....SMHMMLD17	Bliss.....SMHMCAP09	Cocoa*.....SMHMMAN08	Farro*.....SMHMMER29	Cedar*.....SMHMMET15
Globe.....SMHMMLD42	Cactus*.....SMHMCAP08	Cola*.....SMHMMAN10	Gator.....SMHMMER19	Cerise*.....SMHMMET10
Gloss.....SMHMMLD08	Cameo*.....SMHMCAP10	Comfort*.....SMHMMAN42	Gelato*.....SMHMMER34	Downpour*.....SMHMMET33
Grate.....SMHMMLD07	Cinnamon*.....SMHMCAP04	Cottage.....SMHMMAN23	Goji.....SMHMMER38	Driftwood*.....SMHMMET06
Heat.....SMHMMLD22	Cougar*.....SMHMCAP03	Cruise.....SMHMMAN35	Gunmetal.....SMHMMER03	Envy*.....SMHMMET21
Honeydew.....SMHMMLD30	Note.....SMHMCAP06	Dahlia*.....SMHMMAN24	Hawk.....SMHMMER41	Film.....SMHMMET31
Isle.....SMHMMLD39	Paprika.....SMHMCAP05	Dill.....SMHMMAN43	Hedera*.....SMHMMER17	Fleece*.....SMHMMET03
Kale.....SMHMMLD34	Ribbon*.....SMHMCAP11	Ember*.....SMHMMAN11	Highborn*.....SMHMMER07	Fog*.....SMHMMET02
Kiss.....SMHMMLD25	Sidekick.....SMHMCAP12	Firth*.....SMHMMAN39	Immersed.....SMHMMER08	Fruit*.....SMHMMET42
Knight.....SMHMMLD04	Silverback.....SMHMCAP07	Flint.....SMHMMAN04	Kiwi.....SMHMMER22	Galah.....SMHMMET43
Magma.....SMHMMLD20	Smolder*.....SMHMCAP13	Grandeur*.....SMHMMAN41	Kookaburra.....SMHMMER23	Hedgerow*.....SMHMMET36
Mariner.....SMHMMLD41	Whim*.....SMHMCAP01	Greenway*.....SMHMMAN21	Lynx*.....SMHMMER28	Highway*.....SMHMMET38
Merlot.....SMHMMLD19	Wise*.....SMHMCAP02	Harvest*.....SMHMMAN17	Macaron.....SMHMMER36	Hopscoth.....SMHMMET30
Mimosa.....SMHMMLD28		Hush.....SMHMMAN05	Manila*.....SMHMMER30	Kiln*.....SMHMMET44
Mulberry.....SMHMMLD16	Stinson LATERAL	Kimono.....SMHMMAN51	Mudder*.....SMHMMER27	Lava.....SMHMMET13
Nordic.....SMHMMLD36	Calypso.....SCFSLAT43	Lattice*.....SMHMMAN30	Nectarine*.....SMHMMER35	Midday.....SMHMMET34
Panda.....SMHMMLD02	Citrine.....SCFSLAT41	Lioness*.....SMHMMAN18	Ocean.....SMHMMER06	Mineral*.....SMHMMET07
Perennial.....SMHMMLD15	Horizon.....SCFSLAT42	Magic*.....SMHMMAN01	Overcast.....SMHMMER43	Moth*.....SMHMMET45
Pipe.....SMHMMLD06	Mist.....SCFSLAT40	Magnetic.....SMHMMAN32	Pine.....SMHMMER21	Oriole*.....SMHMMET14
Quill.....SMHMMLD05	Papaya.....SCFSLAT45	Nuance*.....SMHMMAN06	Poolside*.....SMHMMER11	Phantom*.....SMHMMET01
Reef.....SMHMMLD37	Peppercorn*.....SCFSLAT46	Oceanside.....SMHMMAN40	Rainfall.....SMHMMER09	Pollen*.....SMHMMET18
Rooster.....SMHMMLD21	Sangria.....SCFSLAT47	Parakeet.....SMHMMAN20	Rainforest*.....SMHMMER18	Scuba*.....SMHMMET28
Seashell.....SMHMMLD12	Skyline*.....SCFSLAT48	Passerine.....SMHMMAN46	Ripple*.....SMHMMER14	Seaport.....SMHMMET27
Seed.....SMHMMLD33	Sterling.....SCFSLAT44	Pathway*.....SMHMMAN09	Sandstorm*.....SMHMMER26	Skate.....SMHMMET29
Skyline.....SMHMMLD03		Peel.....SMHMMAN14	Stag*.....SMHMMER42	Snorkel*.....SMHMMET37
Spa.....SMHMMLD43	HBF Textiles LOOK-SEE	Penny*.....SMHMMAN15	Starfish*.....SMHMMER31	Sourdough*.....SMHMMET04
Stark.....SMHMMLD11	Electric*.....1044-77	Poplar*.....SMHMMAN44	Steel*.....SMHMMER12	Sunny.....SMHMMET40
Vast.....SMHMMLD01	Foggy.....1044-85	Porpoise.....SMHMMAN03	Superior.....SMHMMER05	Talisman.....SMHMMET35
Vine.....SMHMMLD32	Foliage.....1044-67	Resolute*.....SMHMMAN34	Trickle.....SMHMMER01	Tar*.....SMHMMET23
Waterfall.....SMHMMLD35	Lava.....1044-44	Roseate.....SMHMMAN48	Vineyard.....SMHMMER20	Toffee*.....SMHMMET05
Wave.....SMHMMLD38	Midnight.....1044-59	Schooner.....SMHMMAN27	Zircon.....SMHMMER13	Tupelo*.....SMHMMET19
Wild.....SMHMMLD31	Plum.....1044-75	Siltstone.....SMHMMAN50		Twilight*.....SMHMMET25
	Shady.....1044-80	Silverpoint.....SMHMMAN29		Whale*.....SMHMMET32
	Snowy.....1044-11	Slope*.....SMHMMAN28		
	Stone.....1044-89	Smoky*.....SMHMMAN31		
	Terra Cotta*.....1044-46	Southwest*.....SMHMMAN47		
	Ultramarine.....1044-57	Thicket*.....SMHMMAN07		
	Wavelet*.....1044-56	Tidewater.....SMHMMAN38		
	Wine*.....1044-74	Valiant.....SMHMMAN52		
		Vivid*.....SMHMMAN25		
		Wagon*.....SMHMMAN12		
		Woad.....SMHMMAN33		

Multi-use fabrics are noted with the following designators: **B** – Tackboards, **C** – Concensys®, **O** – Optimize™, **S** – Stride®, **T** – Terrace®, **F** – Further™.

* Colorway not shown on Textiles card; all Partnership Program memo samples are available from supplier. See contact information below.

ALLSTEEL PARTNERSHIP PROGRAM

Allsteel understands that customers may want to specify panel and seating textiles outside of Allsteel's standard offering. Allsteel's Partnership Program consists of on-trend and design-forward patterns that have been tested and approved by Allsteel for use on Allsteel products. A subset of these approved patterns is available on cards in the textile binder, while numerous others are available on our website, allsteeloffice.com.

For memo samples, please contact our partners:

- Camira, memos@camirafabrics.com 1.616.288.0655
- CF Stinson, cfstinson.com 1.800.841.6279
- HBF Textiles, hbftextiles.com 1.877.494.5727
- Maharam, maharam.com 1.800.645.3943
- Ultrafabrics, ultrafabricsinc.com 1.877.309.6648

The intent of the **Partnership Program** is to offer a wide variety of on-trend textiles to meet your varied needs, but since these textiles are not part of our standard offering they may be subject to extended lead times. Because new materials will be introduced regularly, Allsteel reserves the right to change the offering at any time.

Refer to page 13 for current upholstery availability by model/series.

GSA Reference Page

ALLSTEEL MATERIALS PARTNERSHIP PROGRAM — SEE PROGRAM EXPLANATION AT BOTTOM OF PAGE 10.

GRADE 4 – continued

Maharam MODE	
Alder*	SMHMMOD23
Angelfish*	SMHMMOD32
Ballpoint*	SMHMMOD29
Barberry*	SMHMMOD25
Billygoat*	SMHMMOD10
Blush*	SMHMMOD21
Bonsai*	SMHMMOD40
Carotene*	SMHMMOD20
Celtic*	SMHMMOD38
Clavicle*	SMHMMOD09
Cottontail*	SMHMMOD16
Crush*	SMHMMOD34
Denim*	SMHMMOD33
Eucalyptus*	SMHMMOD39
Goldenrod*	SMHMMOD15
Henge*	SMHMMOD14
Hollow*	SMHMMOD07
Intaglio*	SMHMMOD02
Jetty*	SMHMMOD35
Kermes*	SMHMMOD24
Lemon*	SMHMMOD12
Lichen*	SMHMMOD43
Lioness*	SMHMMOD17
Machine*	SMHMMOD04
Mallard*	SMHMMOD37
Marsh*	SMHMMOD06
Odyssey*	SMHMMOD28
Ominous*	SMHMMOD03
Oriole*	SMHMMOD18
Oxeye*	SMHMMOD13
Paradise*	SMHMMOD31
Petal*	SMHMMOD26
Rust*	SMHMMOD19
Saltwater*	SMHMMOD36
Sassafras*	SMHMMOD41
Spindle*	SMHMMOD11
Stroll*	SMHMMOD01
Sycamore*	SMHMMOD08
Talus*	SMHMMOD05
Toile*	SMHMMOD30
Valley*	SMHMMOD27
Vermilion*	SMHMMOD22
Yucca*	SMHMMOD42
Maharam MULTIPLY	
Contrast*	SMHMMMLT04
Craft*	SMHMMMLT11
Daze*	SMHMMMLT06
Deep*	SMHMMMLT10
Encore*	SMHMMMLT02
Limit*	SMHMMMLT13
Mystique*	SMHMMMLT09
Sailor*	SMHMMMLT08
Sterling*	SMHMMMLT05
Sway*	SMHMMMLT07
Swing*	SMHMMMLT03
Tamale*	SMHMMMLT14
Town*	SMHMMMLT12
Winter*	SMHMMMLT01
Maharam MURMUR	
Argan*	SMHMMUR17
Baby*	SMHMMUR10
Biome*	SMHMMUR15
Canopy*	SMHMMUR03
Cask*	SMHMMUR16
Cauldron*	SMHMMUR06
Conquer*	SMHMMUR07
Dim*	SMHMMUR04
Elderberry*	SMHMMUR11
Gust*	SMHMMUR01
Harmonica*	SMHMMUR02
Iceberg*	SMHMMUR12
Ignite*	SMHMMUR19
Peppercorn*	SMHMMUR05
Rapids*	SMHMMUR08
Sangria*	SMHMMUR21
Seawater*	SMHMMUR09
Sultry*	SMHMMUR20
Sundown*	SMHMMUR18
Tallgrass*	SMHMMUR13
Underground*	SMHMMUR14

GRADE 4 – continued

Maharam MUSE	
Ascend*	SMHMMUS04
Bergamot*	SMHMMUS11
Celebrate*	SMHMMUS30
Clear*	SMHMMUS07
Compass*	SMHMMUS10
Crescendo*	SMHMMUS01
Fantasy*	SMHMMUS08
Frigid*	SMHMMUS16
Goal*	SMHMMUS13
Grasshopper*	SMHMMUS12
Haven*	SMHMMUS24
Jovial*	SMHMMUS27
Mead*	SMHMMUS25
Miso*	SMHMMUS09
Mistletoe*	SMHMMUS14
Neat*	SMHMMUS26
Noble*	SMHMMUS18
Poinsettia*	SMHMMUS29
Pulsar*	SMHMMUS19
Refresh*	SMHMMUS06
Resonate*	SMHMMUS02
Riverbend*	SMHMMUS17
Runway*	SMHMMUS03
Sailboat*	SMHMMUS21
Seaglass*	SMHMMUS15
Sparse*	SMHMMUS22
Spectacle*	SMHMMUS31
Theater*	SMHMMUS28
Vase*	SMHMMUS23
Veil*	SMHMMUS05
Velella*	SMHMMUS20
Maharam TRUNDLE	
Aloe*	SMHMTRN05
Cabana*	SMHMTRN06
Confetti*	SMHMTRN09
Crabapple*	SMHMTRN10
Element*	SMHMTRN02
Hibernate*	SMHMTRN04
Magnet*	SMHMTRN11
Rainstorm*	SMHMTRN07
Ray*	SMHMTRN03
Ski*	SMHMTRN01
Wake*	SMHMTRN08
HBF Textiles WALKABOUT	
Alluring Aqua*	1046-56
Bewitched Blue*	1046-59
Bold Burgundy*	1046-74
Classic Cobalt*	1046-55
Cool Carbon*	1046-87
Gallant Green*	1046-67
Gutsy Grey*	1046-85
Jungly Jade*	1046-64
Noble Navy*	1046-58
Peaceful Pewter*	1046-89
Reliable Red*	1046-44
Swanky Silver*	1046-80
Wistful White*	1046-11

GRADE 5

HBF Textiles CHECKMATE	
Aqua Sky*	1043-56
Blue Green*	1043-63
Charcoal Black*	1043-89
Forest Mint*	1043-66
Golden Grey*	1043-22
Purple Indigo*	1043-77
Red Brick*	1043-44
Royal Navy*	1043-58
Rust*	1043-43
Smoke Slate*	1043-80
Tanned Umber*	1043-25
Camira MAIN LINE FLAX	
Aldgate*	SCAMMLF01
Archway*	SCAMMLF02
Bank*	SCAMMLF23
Barbican*	SCAMMLF03
Bayswater*	SCAMMLF24
Bethnal*	SCAMMLF25
Brompton*	SCAMMLF35
Camden*	SCAMMLF26
Charing*	SCAMMLF27
Edgware*	SCAMMLF28
Euston*	SCAMMLF04
Farringdon*	SCAMMLF29
Finsbury*	SCAMMLF30
Goldhawk*	SCAMMLF31
Greenford*	SCAMMLF32
Highgate*	SCAMMLF33
Hillingdon*	SCAMMLF41
Holborn*	SCAMMLF05
Kensington*	SCAMMLF07
Kilburn*	SCAMMLF06
Lambeth*	SCAMMLF08
Leyton*	SCAMMLF13
Monument*	SCAMMLF09
Mordun*	SCAMMLF12
Newbury*	SCAMMLF10
Northfields*	SCAMMLF40
Paddington*	SCAMMLF39
Parsons*	SCAMMLF14
Pimlico*	SCAMMLF34
Russell*	SCAMMLF38
Stanmore*	SCAMMLF37
Stockwell*	SCAMMLF15
Temple*	SCAMMLF16
Tooting*	SCAMMLF17
Tower*	SCAMMLF36
Tufnell*	SCAMMLF18
Upminster*	SCAMMLF20
Victoria*	SCAMMLF19
Waterloo*	SCAMMLF21
Wembley*	SCAMMLF11
Westminster*	SCAMMLF22
HBF Textiles ZIPPY	
Dark Grey*	1045-89
Deep Red*	1045-44
Denim Blue*	1045-58
Grey*	1045-80
Navy*	1045-59
Pine*	1045-67
School Blue*	1045-55
Winter White*	1045-10

GRADE 6

Camira BLAZER	
Aberlour*	SCAMBLZ15
Aberarty*	SCAMBLZ36
Aston*	SCAMBLZ02
Barlborough*	SCAMBLZ40
Barnard*	SCAMBLZ27
Bromsgrove*	SCAMBLZ35
Bryanston*	SCAMBLZ53
Camphill*	SCAMBLZ16
Cardiff*	SCAMBLZ04
Dartmouth*	SCAMBLZ24
Dunhurst*	SCAMBLZ58
Edge Hill*	SCAMBLZ90
Edinburgh*	SCAMBLZ23
Eynesbury*	SCAMBLZ44
Fairfield*	SCAMBLZ47
Glasgow*	SCAMBLZ01
Glenalmond*	SCAMBLZ62
Goldsmith*	SCAMBLZ39
Handcross*	SCAMBLZ63
Holyoke*	SCAMBLZ43
Hull*	SCAMBLZ19
Kingsmead*	SCAMBLZ67
Knightsbridge*	SCAMBLZ26
Latimer*	SCAMBLZ33
Magdalene*	SCAMBLZ42
Manchester*	SCAMBLZ21
Marymount*	SCAMBLZ38
Montcrest*	SCAMBLZ37
Napier*	SCAMBLZ08
Newcastle*	SCAMBLZ22
Newport*	SCAMBLZ17
Oriel*	SCAMBLZ18
Oxford*	SCAMBLZ09
Penola*	SCAMBLZ45
Plymouth*	SCAMBLZ20
Scottsdale*	SCAMBLZ41
Sheffield*	SCAMBLZ03
Silcoates*	SCAMBLZ30
Silverdale*	SCAMBLZ28
St. Andrews*	SCAMBLZ86
Stanford*	SCAMBLZ25
Surrey*	SCAMBLZ10
Trevelyan*	SCAMBLZ31
Tyndale*	SCAMBLZ46
Ulster*	SCAMBLZ11
Vassar*	SCAMBLZ34
Wellington*	SCAMBLZ13
Wesley*	SCAMBLZ82
Winchester*	SCAMBLZ12
Woodcroft*	SCAMBLZ48
Camira HEMP	
Acre*	SCAMHMP19
Alec*	SCAMHMP12
Arable*	SCAMHMP04
Ashworth*	SCAMHMP26
Bale*	SCAMHMP02
Barn*	SCAMHMP23
Dale*	SCAMHMP18
Dew*	SCAMHMP16
Fallow*	SCAMHMP28
Gorse*	SCAMHMP03
Grain*	SCAMHMP27
Heath*	SCAMHMP07
Hectare*	SCAMHMP21
Hedgerow*	SCAMHMP09
Oat*	SCAMHMP05
Plough*	SCAMHMP01
Pollen*	SCAMHMP08
Root*	SCAMHMP06
Seed*	SCAMHMP13
Sickle*	SCAMHMP30
Trough*	SCAMHMP20

GRADE 6 – continued

HBF Textiles POPPY	
Flame*	1047-44
Graphite*	1047-85
Ink*	1047-89
Khaki*	1047-35
Limelight*	1047-63
Natural*	1047-16
Neutral*	1047-83
Night*	1047-59
Pool*	1047-56
Punch*	1047-45
GRADE 7	
Camira SLIK	
Arabia*	SCAMSLK02
Assam*	SCAMSLK11
Brunei*	SCAMSLK08
Byzantine*	SCAMSLK03
Chancellor*	SCAMSLK19
Divine*	SCAMSLK13
Dynasty*	SCAMSLK17
Emperor*	SCAMSLK16
Empress*	SCAMSLK05
Forbidden*	SCAMSLK07
Imeon*	SCAMSLK20
Incense*	SCAMSLK06
Kingdom*	SCAMSLK10
Monarch*	SCAMSLK15
Oriental*	SCAMSLK12
Pamir*	SCAMSLK14
Parthian*	SCAMSLK09
Persia*	SCAMSLK04
Sahara*	SCAMSLK01
Sovereign*	SCAMSLK18
Tussah*	SCAMSLK21

UPHOLSTERY

* Colorway not shown on Textiles card; all Partnership Program memo samples are available from supplier. See contact information on page 10.

Refer to page 13 for current upholstery availability by model/series.

ALLSTEEL MATERIALS PARTNERSHIP PROGRAM — SEE PROGRAM EXPLANATION AT BOTTOM OF PAGE 10.

UPHOLSTERY

GRADE 8

<i>Ultrafabrics</i>	
BRISA*	▲
Abyss*	RS78
Apple Green	RS25
Ash	RS05
Aztec*	RS16
Bark*	RS18
Beet Root*	RS361
Birch	RS64
Black Onyx	RS01
Blossom*	RS74
Blue Sea	RS621
Bone	RS31
Cabernet	RS99
Cambridge Blue	RS17
Canyon*	RS07
Caramel	RS91
Celery	RS87
Cinnabar*	RS36
Coffee Bean*	RS33
Cookie Dough*	RS234
Cream*	RS63
Desert Clay*	RS19
Esmeralda	RS302
Evening Blue	RS620
Flamingo	RS203
French Vanilla	RS66
Ginger*	RS51
Golden*	RS67
Gravel*	RS275
Hazy Lilac*	RS310
Honeycomb*	RS233
Iceberg	RS272
Indigo	RS14
Koi	RS202
Mineral*	RS97
Moon	RS277
New Sand*	RS20
Night Navy*	RS94
Olive*	RS02
Peat*	RS00
Pompeian Red	RS83
Putty	RS08
Quicksilver	RS30
Rose Red*	RS43
Sage	RS10
Salsa	RS15
Seaweed	RS303
Shiitake*	RS22
Skyway*	RS96
Sterling Blue	RS98
Strawberry	RS359
Truffle	RS12
Turq	RS23
White	RS47
Wishbone*	RS276
Wrought Iron*	RS27

GRADE 8 – continued

<i>Camira ZAP</i>	
Argh	SCAMZAP11
Awesome*	SCAMZAP14
Boing	SCAMZAP21
Bonza	SCAMZAP25
Clang*	SCAMZAP19
Clobber*	SCAMZAP12
Cool*	SCAMZAP30
Crackle*	SCAMZAP05
Crash*	SCAMZAP16
Flump	SCAMZAP17
Gasp*	SCAMZAP15
Hahaha*	SCAMZAP09
Kapow*	SCAMZAP06
Omg	SCAMZAP13
Power*	SCAMZAP18
Puff	SCAMZAP26
Screech	SCAMZAP08
Snap*	SCAMZAP01
Splash	SCAMZAP27
Splat	SCAMZAP20
Thud*	SCAMZAP29
Wham	SCAMZAP23
Whirr	SCAMZAP03
Whomp*	SCAMZAP28
Whoosh*	SCAMZAP02
Wowzers*	SCAMZAP07
Yeah*	SCAMZAP04
Yikes	SCAMZAP10
Zoink	SCAMZAP24
Zoom	SCAMZAP22

GRADE 9

<i>Ultrafabrics</i>	
ULTRALEATHER PRO	
Aubergine	SUF554336
Blue Bird	SUF554661
Blueberry	SUF554711
Blush	SUF554200
Butterfly	SUF554216
Butternut*	SUF554241
Campfire	SUF554229
Capri*	SUF554522
Char	SUF554626
Chestnut	SUF554214
Cloud	SUF554648
Coastal	SUF554450
Cork	SUF554595
Cougar*	SUF554209
Cranberry	SUF554357
Dark Chocolate	SUF554376
Dark Knight	SUF554618
Ember	SUF554649
Laurel	SUF554443
Mortar	SUF554733
Parfait	SUF554803
Persian Green	SUF554453
Rhubarb	SUF554329
Sailor	SUF554547
Sea Mist	SUF554478
Shore	SUF554352
Sky	SUF554530
Swan	SUF554811
Toasted Bagel*	SUF554444
Tundra	SUF554353
Violet	SUF554395
White Wash	SUF554008
Woodcres	SUF554087
<i>Camira YOREDALE</i>	
Askrigg*	SCAMYDL03
Buckden	SCAMYDL01
Burnsall	SCAMYDL22
Carperby	SCAMYDL07
Cracoe	SCAMYDL23
Cray	SCAMYDL10
Dacre	SCAMYDL21
Darley	SCAMYDL20
Fossdale	SCAMYDL11
Gayle	SCAMYDL08
Hardraw	SCAMYDL04
Kidstone	SCAMYDL02
Leyburn	SCAMYDL25
Litton	SCAMYDL15
Nidd*	SCAMYDL16
Ribble	SCAMYDL17
Ripley*	SCAMYDL19
Sedbusk	SCAMYDL14
Simonstone*	SCAMYDL05
Thoralby	SCAMYDL06
Thornton	SCAMYDL09
Walden	SCAMYDL13
Warfe*	SCAMYDL18
Woden*	SCAMYDL24
Woodale*	SCAMYDL12

* Colorway not shown on Textiles card; all Partnership Program memo samples are available from supplier. See contact information on page 10.

Upholstery Selections for Storage by Model/Series

Upholstery colors and codes for standard fabrics are listed on page 14. Partnership (⊕) upholstery colors and codes are listed in the Seating, Social Collaborative & Tables Price List.

		Banquette/Seat Cushions Radin Ped Topper Align, Essentials, Involve Ped Topper					Banquette/Seat Cushions Radin Ped Topper Align, Essentials, Involve Ped Topper		
GRADE 1									
Apex	APX	•	•	•					
Centurion	CU	◆	•	◆					
Contourett	UR	◆	•	•					
Dapper	DAPR	◆	•	◆					
Ensemble	ENSB	•	•	•					
Hamilton	HAML	◆	•	◆					
Inertia	NR	◆	•	◆					
Optic	OP	•	•	•					
GRADE 2									
Appoint Seating	PNS	◆	•	◆					
Blume	BLME	•	•	•					
Clyde	CLYD	•	•	•					
Dotty	DOT	◆	•	•					
Meld ⊕	SMHMLD	•	•	•					
Rush	RUSH	◆	•	•					
Spin Seating	SPNN	◆	•	•					
Taylor	TAY								
GRADE 3									
Parker ⊕	PRKR		•	•					
Purl	PURL	◆	•	•					
Quill	QUL	◆	•	•					
Lateral ⊕	SCFSLAT		•	•					
GRADE 4									
Blink ⊕	1048	•	•	•					
Caper ⊕	SMHMCAP	•	•	•					
Look-See ⊕	1044	•	•	•					
Manner ⊕	SMHMMAN	◆	•	•					
Merit ⊕	SMHMMER	•	•	•					
Metric ⊕	SMHMMET	◆	•	•					
Mode ⊕	SMHMMOD	•	•	•					
Multiply ⊕	SMHMMLT	•	•	•					
Murmur ⊕	SMHMMUR		•	•					
Muse ⊕	SMHMMUS	•	•	•					
Trundle ⊕	SMHMTRN	•	•	•					
Walkabout ⊕	1046	•	•	•					
GRADE 5									
Blazer ⊕	SCAMBLZ	• ^s	•	•					
Checkmate ⊕	1043	•	•	•					
Main Line Flax ⊕	SCAMMLF	•	•	•					
Zippy ⊕	1045	•	•	•					
GRADE 6									
Arris	ARR	•							
Hemp ⊕	SCAMHMP	•	•	•					
Poppy ⊕	1047	•	•	•					
GRADE 7									
Silk ⊕	SCAMSLK		•	•					
GRADE 8									
Brisa ⊕	RS								
Zap ⊕	SCAMZAP	•	•	•					
GRADE 9									
Ultraleather Pro ⊕	SUF554		•	•					
Yoredale ⊕	SCAMYDL	•	•	•					

^sSeat Only

• Available upholstery option

◆ Available upholstery option with CTB133 approval — requires FC suffix added to model (FC extra, \$ varies by series)

⊕ Partnership Program — See page 10 for details. Partnership colors and codes are listed in the Seating, Collaboration and Tables Price List.

Refer to page 13 for current upholstery availability by model/series.

UPHOLSTERY

GRADE 1

APEX	
Basalt.....	APX25
Beet.....	APX12
Blackberry.....	APX20
Chive.....	APX05
Iris.....	APX03
Kiwi.....	APX06
Lemonade.....	APX08
Navy.....	APX13
Papaya.....	APX09
Pumice.....	APX23
Rain.....	APX19
Resort.....	APX15
Royal.....	APX14
Tiki.....	APX29
Tomato.....	APX11
*CENTURION B, C, F, O, S, T	
Apricot.....	CU47
Bark.....	CU25
Black.....	CU10
Espresso.....	CU49
Fog.....	CU03
Frost.....	CU22
Goldenrod.....	CU27
Indigo.....	CU06
Iris.....	CU50
Iron Ore.....	CU19
Jade.....	CU83
Marsala.....	CU63
Morel.....	CU24
Navy.....	CU98
Peacock.....	CU97
Pear.....	CU84
Ruby.....	CU67
Sapphire.....	CU09
CONTOURETT	
Baltic.....	UR94
Beach.....	UR23
Black.....	UR10
Bordeaux.....	UR63
Buff.....	UR22
Cloud.....	UR18
Coffee Bean.....	UR49
Crater.....	UR51
Flame.....	UR62
Graphite.....	UR19
Iron.....	UR20
Luggage.....	UR26
Marine.....	UR92
Navy.....	UR95
Nimbus.....	UR93
Ocean.....	UR96
Pumpkin.....	UR42
Quarry.....	UR24
Red.....	UR64
Safari.....	UR27
Sage.....	UR82
Steel.....	UR21
Storm.....	UR17
Taupe.....	UR28
Trunk.....	UR50

Multi-use fabrics are noted with the following designators:
B – Tackboards
C – Concensys®
F – Further™
O – Optimize™
S – Stride®
T – Terrace®
 * limited to 48"W or less
 * Not available on 72"W.

GRADE 1 – continued

DAPPER B^w, F^w, S^w, T^w	
Ash.....	DAPR20
Breeze.....	DAPR06
Canvas.....	DAPR25
Charcoal.....	DAPR01
Clover.....	DAPR22
Currant.....	DAPR00
Fawn.....	DAPR35
Fern.....	DAPR85
Gerbera.....	DAPR16
Grape.....	DAPR33
Jewel.....	DAPR08
Marigold.....	DAPR65
Onyx.....	DAPR10
Orchid.....	DAPR90
Parrot.....	DAPR59
Poppy.....	DAPR19
Sapphire.....	DAPR07
Scarlet.....	DAPR45
Sepia.....	DAPR30
Slate.....	DAPR15
Sky.....	DAPR44
Sorbet.....	DAPR55
Spring.....	DAPR80
Terracotta.....	DAPR13
Titanium.....	DAPR17
Varsity.....	DAPR09
Zest.....	DAPR70
ENSEMBLE	
Aquamarine.....	ENSB30
Ash.....	ENSB39
Greige.....	ENSB36
Harbor.....	ENSB34
Navy.....	ENSB35
Oat.....	ENSB37
Pear.....	ENSB33
Sand.....	ENSB38
Scarlet.....	ENSB32
Slate.....	ENSB31
Stone.....	ENSB40
HAMILTON	
Azure.....	HAML10
Biscotti.....	HAML11
Cabernet.....	HAML08
Carolina.....	HAML21
Charcoal.....	HAML17
Chocolate.....	HAML13
Cloud.....	HAML18
Dane.....	HAML16
Dusty Rose.....	HAML07
Esmeralda.....	HAML06
Fern.....	HAML04
Fresh.....	HAML03
Granola.....	HAML19
Lilac.....	HAML14
Lime.....	HAML05
Lipstick.....	HAML09
Oxford.....	HAML20
Passion Fruit.....	HAML02
Pepper.....	HAML15
Powder.....	HAML12
Sunrise.....	HAML01
INERTIA	
Amethyst.....	NR61
Calypso.....	NR98
Cherry.....	NR66
Cobalt.....	NR91
Coffee.....	NR49
Fog.....	NR19
Fuchsia.....	NR63
Gecko.....	NR76
Glow.....	NR27
Leaf.....	NR75
Lime.....	NR82
Loft.....	NR22
Mandarin.....	NR47
Meteor.....	NR30
Mustard.....	NR26
Nickel.....	NR23
Onyx.....	NR10
Regatta.....	NR90
Shadow.....	NR20
Surf.....	NR96
Tangelo.....	NR46

GRADE 1 – continued

OPTIC	
Aurora.....	OP72
Bark.....	OP24
Canopy.....	OP84
Char.....	OP49
Ruby.....	OP42
Sand.....	OP17
Sky.....	OP83
Slate.....	OP19
Sprout.....	OP74
Starry Night.....	OP11
Storm.....	OP56
Wildfire.....	OP66

GRADE 2

APPOINT SEATING	
Blackberry.....	PNS012
Bronze.....	PNS002
Carbon.....	PNS008
Cherry.....	PNS010
Espresso.....	PNS003
Framboise.....	PNS011
Jet.....	PNS007
Lawn.....	PNS005
Mandarin.....	PNS009
Morel.....	PNS001
Platinum.....	PNS004
Turquoise.....	PNS006

BLUME

Chalk.....	BLME03
Char.....	BLME00
Coin.....	BLME02
Driftwood.....	BLME05
Emerald City.....	BLME07
Fir.....	BLME09
Harvest.....	BLME04
Haze.....	BLME08
Hyacinth.....	BLME14
Jasper.....	BLME13
Merlot.....	BLME10
Moonstone.....	BLME01
Opal.....	BLME06
Scarlet.....	BLME11
Slate.....	BLME12

CLYDE

Antique.....	CLYD04
Artifact.....	CLYD01
Blacksmith.....	CLYD10
Claret.....	CLYD13
Craftsman.....	CLYD08
Crate.....	CLYD12
Fossil.....	CLYD02
Heirloom.....	CLYD05
Iron.....	CLYD11
Linen.....	CLYD14
Relic.....	CLYD06
Seasoned.....	CLYD03
Trestle.....	CLYD07

DOTTY

Candy.....	DOT63
Gelato.....	DOT34
Indigo.....	DOT31
Onyx.....	DOT35
Park.....	DOT83
Peat.....	DOT24
Peony.....	DOT32
Suit.....	DOT20
Sunflower.....	DOT33
Tailor.....	DOT21
Tide.....	DOT90
Velum.....	DOT29
Violet.....	DOT30

GRADE 2 – continued

RUSH	
Anchor.....	RUSH07
Basil.....	RUSH16
Blueberry.....	RUSH10
Flamingo.....	RUSH21
Greenery.....	RUSH15
Greyhound.....	RUSH06
Marina.....	RUSH13
Merlot.....	RUSH19
Midnight.....	RUSH11
Mint.....	RUSH09
Mulberry.....	RUSH18
Pumice.....	RUSH01
Punch.....	RUSH20
Sage.....	RUSH14
Salsa.....	RUSH24
Sand.....	RUSH05
Seal.....	RUSH08
Soot.....	RUSH02
Stout.....	RUSH03
Sunshine.....	RUSH23
Tapestry.....	RUSH04
Tiger.....	RUSH22
Vintage.....	RUSH17
Wave.....	RUSH12

SPIN SEATING

Alabaster.....	SPNN02
Cavern.....	SPNN03
Cobblestone.....	SPNN04
Ember.....	SPNN06
Flame.....	SPNN07
Heron.....	SPNN13
Oat.....	SPNN01
Ocean.....	SPNN12
Plum.....	SPNN15
Pool.....	SPNN11
Raven.....	SPNN10
Rhubarb.....	SPNN14
Tropic.....	SPNN08
Willow.....	SPNN05

TAYLOR

Autumn.....	TAY43
Daffodil.....	TAY20
Deep Lilac.....	TAY75
Dreamy.....	TAY80
Envious.....	TAY58
Handkerchief.....	TAY90
Luxe.....	TAY50
Malbec.....	TAY40
Martini.....	TAY60
Mink.....	TAY30
Pearl.....	TAY15
Spritz.....	TAY45
Tungsten.....	TAY85

GRADE 3

PARKER

Aloe.....	PRKR01
Cumulus.....	PRKR05
Cyan.....	PRKR06
Domino.....	PRKR07
Fossil.....	PRKR10
Graphite.....	PRKR11
Grass.....	PRKR12
Grenadine.....	PRKR13
Griffin.....	PRKR14
Kiln.....	PRKR16
Magnesium.....	PRKR18
Magnet.....	PRKR19
Mica.....	PRKR20
Mink.....	PRKR21
Punch.....	PRKR22
Paprika.....	PRKR24
Pine.....	PRKR25
Rapids.....	PRKR28
Rioja.....	PRKR30

PURL

Alpaca.....	PURL08
Braid.....	PURL10
Deep.....	PURL12
Graze.....	PURL05
Loom.....	PURL06
Needle.....	PURL07
Pasture.....	PURL02
Ranch.....	PURL04
Shuttle.....	PURL09
Skein.....	PURL01
Thistle.....	PURL11
Yearling.....	PURL03

QUILL

Aviary.....	QUL03
Feather.....	QUL02
Fountain.....	QUL06
Ink.....	QUL05
Metal.....	QUL04
Reed.....	QUL08
Scroll.....	QUL01
Well.....	QUL07

GRADE 6

ARRIS

Artisan.....	ARR01
Baroque.....	ARR07
Noble.....	ARR02
Rattan.....	ARR05
Rich.....	ARR04
Tapestry.....	ARR03
Welt.....	ARR06

GRADE A

APPOINT PANEL

Artichoke.....	APN911
Blackberry.....	APN932
Bronze.....	APN922
Carbon.....	APN928
Chai.....	APN912
Cherry.....	APN930
Dark Pewter.....	APN917
Dune.....	APN915
Espresso.....	APN923
Framboise.....	APN931
Frost.....	APN934
Jet.....	APN927
Lawn.....	APN925
Mandarin.....	APN929
Morel.....	APN909
Nimbus.....	APN916
Platinum.....	APN924
Turquoise.....	APN926

BINARY †

Blush.....	BNRY12
Coal.....	BNRY06
Cream.....	BNRY01
Denim.....	BNRY08
Diamond.....	BNRY03
Graphite.....	BNRY05
Juniper.....	BNRY10
Lagoon.....	BNRY07
Lavendar.....	BNRY11
Mineral.....	BNRY04
Reef.....	BNRY09
Sand Dollar.....	BNRY02

CENTURION^w

Apricot.....	CU47
Bark.....	CU25
Black.....	CU10
Espresso.....	CU49
Fog.....	CU03
Frost.....	CU22
Goldenrod.....	CU27
Indigo.....	CU06
Iris.....	CU50
Iron Ore.....	CU19
Jade.....	CU83
Marsala.....	CU63
Morel.....	CU24
Navy.....	CU98
Peacock.....	CU97
Pear.....	CU84
Ruby.....	CU67
Sapphire.....	CU09

CIRCUIT † ♣

Atlas.....	CIRC35
Dolphin.....	CIRC63
Island White.....	CIRC14
Moon.....	CIRC07
Night.....	CIRC49
Pacific.....	CIRC28
Quartz.....	CIRC01
Sienna.....	CIRC56
Silk.....	CIRC21
Snap Pea.....	CIRC42

ETCH

Axis.....	ECH913
Blend.....	ECH914
Cast.....	ECH912
Highlight.....	ECH910
Midtone.....	ECH911
Outline.....	ECH908
Shade.....	ECH909
Tonal.....	ECH916
Vanish.....	ECH915

GRADE A – continued

LANDSCAPE

Cornsilk.....	LN15
Drift.....	LN05
Khaki.....	LN20
Sheen.....	LN10
Slate.....	LN35
Umber.....	LN25
Urban.....	LN30

LUCY

Aspen.....	LC932
Cornsilk.....	LC930
Dusk.....	LC922
Fawn.....	LC933
Graphite.....	LC934
Mist.....	LC920
Neutra.....	LC924
Pewter.....	LC935
Snowdrop.....	LC928

NOBLE

Aspen.....	NBLE14
Bordeaux.....	NBLE01
Brick.....	NBLE02
Chambray.....	NBLE10
Clementine.....	NBLE04
Dawn.....	NBLE13
Denim.....	NBLE09
Grass.....	NBLE07
Gunmetal.....	NBLE15
Harvest.....	NBLE12
Jade.....	NBLE06
Knight.....	NBLE17
Mesa.....	NBLE03
Pacific.....	NBLE08
Rainforest.....	NBLE05
Regal.....	NBLE11
Stormy.....	NBLE16

REFLECTIONS

Galvanized.....	REF929
Ice.....	REF920
Loggia.....	REF921
Mistral.....	REF928
Moonstone.....	REF923
Pewter.....	REF922
Stainless.....	REF924
Vanilla.....	REF925
Winter.....	REF927

REFUGE

Artesian.....	RFG996
Dune.....	RFG992
Eclipse.....	RFG990
Frost †.....	RFG993
Glacier †.....	RFG991
Mineral.....	RFG998
Tidal.....	RFG994

TEMPEST

Dragonfly.....	TP930
Frost.....	TP915
Full Stream.....	TP980
Gold Rush.....	TP910
Slate.....	TP945
Tumbleweed.....	TP970
Wind Chill.....	TP940
Zebra.....	TP935

GRADE B

COAST † ♣

Channel.....	COA914
Dune.....	COA903
Headlands.....	COA910
Marsh.....	COA902
Pebble.....	COA912
Pier.....	COA913
Shoal.....	COA901
Silt.....	COA906
Tide.....	COA908

DISPERSE †

Autumn.....	DISP03
Branch.....	DISP10
Coffee Bean.....	DISP13
Dusk.....	DISP09
Emerald City.....	DISP08
Gold Rush.....	DISP02
Igloo.....	DISP11
Ink.....	DISP06
Mist.....	DISP12
Oatmeal.....	DISP15
Prince.....	DISP07
Reservoir.....	DISP01
Rose.....	DISP04
Spring.....	DISP05
Steel.....	DISP16
Taupe.....	DISP14

MICA (De-emphasized)

Anthracite.....	MCA911
Breeze.....	MCA918
Bronze.....	MCA913
Buff.....	MCA914
Cremini.....	MCA917
Crystal.....	MCAWIT
Dew.....	MCA920
Dove.....	MCA912
Fresh.....	MCA916
Mineral.....	MCA915
Nectar.....	MCA919
Shale.....	MCA910

SPIN PANEL

Alabaster.....	SPIN02
Cavern.....	SPIN03
Cobblestone.....	SPIN04
Ember.....	SPIN06
Flame.....	SPIN07
Heron.....	SPIN13
Oat.....	SPIN01
Ocean.....	SPIN12
Plum.....	SPIN15
Pool.....	SPIN11
Raven.....	SPIN10
Rhubarb.....	SPIN14
Tropic.....	SPIN08
Willow.....	SPIN05

TERRAIN

Bay.....	TRRN05
Bayou.....	TRRN35
Canyon.....	TRRN30
Cliff.....	TRRN45
Crest.....	TRRN25
Delta.....	TRRN10
Plateau.....	TRRN15
Ridge.....	TRRN20
Valley.....	TRRN40

^w Limited to product 48"W or less.

▼ Panel fabric is not available on Further[™].

♣ Panel fabric is not available on Optimize[®].

† Panel fabric is not available on Concensys[®].

◆ Panel fabric is not available on Involve[®].

GRADE A

APPOINT PANEL

Artichoke	APN911
Blackberry	APN932
Bronze	APN922
Carbon	APN928
Chai	APN912
Cherry	APN930
Dark Pewter	APN917
Dune	APN915
Espresso	APN923
Frost	APN934
Framboise	APN931
Jet	APN927
Lawn	APN925
Mandarin	APN929
Morel	APN909
Nimbus	APN916
Platinum	APN924
Turquoise	APN926

BINARY †

Blush	BNRY12
Coal	BNRY06
Cream	BNRY01
Denim	BNRY08
Diamond	BNRY03
Graphite	BNRY05
Juniper	BNRY10
Lagoon	BNRY07
Lavender	BNRY11
Mineral	BNRY04
Reef	BNRY09
Sand Dollar	BNRY02

CENTURION^w

Apricot	CU47
Bark	CU25
Black	CU10
Espresso	CU49
Fog	CU03
Frost	CU22
Goldenrod	CU27
Indigo	CU06
Iris	CU50
Iron Ore	CU19
Jade	CU83
Marsala	CU63
Morel	CU24
Navy	CU98
Peacock	CU97
Pear	CU84
Ruby	CU67
Sapphire	CU09

CIRCUIT † ♣

Atlas	CIRC35
Dolphin	CIRC63
Island White	CIRC14
Moon	CIRC07
Night	CIRC49
Pacific	CIRC28
Quartz	CIRC01
Sienna	CIRC56
Silk	CIRC21
Snap Pea	CIRC42

ETCH

Axis	ECH913
Blend	ECH914
Cast	ECH912
Highlight	ECH910
Midtone	ECH911
Outline	ECH908
Shade	ECH909
Tonal	ECH916
Vanish	ECH915

GRADE A – continued

LANDSCAPE

Cornsilk	LN15
Drift	LN05
Khaki	LN20
Sheen	LN10
Slate	LN35
Umber	LN25
Urban	LN30

LUCY

Aspen	LC932
Cornsilk	LC930
Dusk	LC922
Fawn	LC933
Graphite	LC934
Mist	LC920
Neutra	LC924
Pewter	LC935
Snowdrop	LC928

NOBLE

Aspen	NBLE14
Bordeaux	NBLE01
Brick	NBLE02
Chambrey	NBLE10
Clementine	NBLE04
Dawn	NBLE13
Grass	NBLE07
Gunmetal	NBLE15
Harvest	NBLE12
Jade	NBLE06
Knight	NBLE17
Mesa	NBLE03
Pacific	NBLE08
Rainforest	NBLE05
Regal	NBLE11
Stormy	NBLE16

REFLECTIONS

Galvanized	REF929
Ice	REF920
Loggia	REF921
Mistral	REF928
Moonstone	REF923
Pewter	REF922
Stainless	REF924
Vanilla	REF925
Winter	REF927

REFUGE

Artesian	RFG996
Dune	RFG992
Eclipse	RFG990
Frost †	RFG993
Glacier †	RFG991
Hemp	RFG997
Mineral	RFG998
Sandbar	RFG995
Tidal	RFG994

SARTO ▼

Ash	SRT988
Fog	SRT914
Lemongrass	SRT949
Mist	SRT945
Mushroom	SRT976
Oyster	SRT918
Reef	SRT964
Sesame	SRT993
Shale	SRT952

TEMPEST

Dragonfly	TP930
Frost	TP915
Full Stream	TP980
Gold Rush	TP910
Slate	TP945
Tumbleweed	TP970
Wind Chill	TP940
Zebra	TP935

GRADE B

COAST † ♣

Channel	COA914
Dune	COA903
Headlands	COA910
Marsh	COA902
Pebble	COA912
Pier	COA913
Shoal	COA901
Silt	COA906
Tide	COA908

DISPERSE †

Autumn	DISP03
Branch	DISP10
Coffee Bean	DISP13
Dusk	DISP09
Emerald City	DISP08
Gold Rush	DISP02
Igloo	DISP11
Ink	DISP06
Mist	DISP12
Oatmeal	DISP15
Prince	DISP07
Reservoir	DISP01
Rose	DISP04
Spring	DISP05
Steel	DISP16
Taupe	DISP14

MICA (De-emphasized)

Anthracite	MCA911
Breeze	MCA918
Bronze	MCA913
Buff	MCA914
Cremini	MCA917
Crystal †	MCAWIT
Dew	MCA920
Dove	MCA912
Fresh	MCA916
Mineral	MCA915
Nectar	MCA919
Shale	MCA910

SPIN PANEL

Alabaster	SPIN02
Cavern	SPIN03
Cobblestone	SPIN04
Ember	SPIN06
Flame	SPIN07
Heron	SPIN13
Oat	SPIN01
Ocean	SPIN12
Plum	SPIN15
Pool	SPIN11
Raven	SPIN10
Rhubarb	SPIN14
Tropic	SPIN08
Willow	SPIN05

TERRAIN

Bay	TRRN05
Bayou	TRRN35
Canyon	TRRN30
Cliff	TRRN45
Crest	TRRN25
Delta	TRRN10
Plateau	TRRN15
Ridge	TRRN20
Valley	TRRN40

^w Limited to 48"W or less

▼ Panel fabric is not available on Further.

♣ Panel fabric is not available on Optimize®.

† Panel fabric is not available on Concensys®.

◆ Panel fabric is not available on Involve.

* Not available on 72"W

Multi-use fabrics are seating fabrics that can be used on specific Allsteel panels systems, providing more color and pattern options. The applicable Allsteel multi-use fabrics are noted with System designators in the Seating, Collaboration, and Tables Price List.

Notes

UPHOLSTERY

Finishes

FINISHES

Paint Name	Allsteel Paint Code	Grade	Cadence	Universal Hutches & Universal Overhead Storage	Essentials Storage	Essentials Bookcases & Shelf	Vertical Metal Storage	Metal Center Drawers	Align Storage & Shelf Option	Stride Storage Foot	Involve	Radji	Approach O Legs & Supports
Black	P27	1	•	•	•	•	•	•		•		•	•
Black	P71	1	•	•	•	•	•	•		•	•	•	•
Brownstone	P7D	1	•	•	•	•	•	•		•	•	•	•
Bungalow	P7C	1	•	•	•	•	•	•		•		•	•
Charblack	CBK	1											
Cinder	P7Q	1	•	•	•	•	•	•		•	•	•	•
Designer White	PJW	1	•	•	•	•	•	•		•	•	•	•
Flint	P02	1	•	•	•	•	•	•		•	•	•	•
Fossil	P28	1	•	•	•	•	•	•		•	•	•	•
Loft	P7B	1	•	•	•	•	•	•		•	•	•	•
Muslin	P4J	1	•	•	•	•	•	•		•	•	•	•
Parchment	P93	1	•	•	•	•	•	•		•		•	•
Pebble	P8R	1	•	•	•	•	•	•		•	•	•	•
Pewter	P8D	1	•	•	•	•	•	•		•	•	•	•
Salt	P8C	1	•	•	•	•	•	•		•	•	•	•
Textured Brownstone	P7J	1											
Textured Designer White	PK7	1											
Textured Flint	P7A	1											
Textured Loft	P7L	1											
Textured Muslin	P7M	1											
Textured Pebble	P8Y	1											
Textured Salt	P8Z	1											
Textured Titanium	P8V	1											
Titanium	P8T / T	1	•	•	•	•	•	•		•	•	•	•
Champagne Metallic	PR5	2	•	•	•	•	•	•		•	•	•	•
Gunmetal Metallic	PR3	2	•	•	•	•	•	•		•	•	•	•
Night Bronze	P8B	2											•
Platinum Metallic	PR2	2	•	•	•	•	•	•		•		•	•
Pyrite	PJE	2											•
Silver	PR6**	2	•	•	•			•	•	•	•	•	•
Silver Texture	PR8	2	•	•	•								•
Solar Black	P8X	2	•	•	•			•		•	•	•	•
Atom	P8S	3	•	•	•			•		•	•	•	•
Blossom	P8K	3	•	•	•			•		•	•	•	•
Bullseye	PJF	3	•	•	•			•		•	•	•	•
Ember	P8P	3	•	•	•			•		•	•	•	•
Ion	P8N	3	•	•	•			•		•	•	•	•
Iris	P8J	3	•	•	•			•		•	•	•	•
Krypton	P8F	3	•	•	•			•		•	•	•	•
Regatta	P8M	3	•	•	•			•		•	•	•	•
Succulent	P8A	3	•	•	•			•		•	•	•	•

**PR6 no upcharge on storage hardware

Finishes

Paint Name	Allsteel Paint Code	Grade	Approach Splay Leg	Approach Post Foot	Approach Back Panels	Approach End Cap	Approach Wall Mount Kit	Approach Foot
Black	P27	1	•		•	•	•	•
Black	P71	1	•					
Brownstone	P7D	1	•					
Bungalow	P7C	1	•					
Charblack	CBK	1						
Cinder	P7Q	1	•					
Designer White	PJW	1	•	•	•	•	•	•
Flint	P02	1	•	•				
Fossil	P28	1	•					
Loft	P7B	1	•	•				
Muslin	P4J	1	•					
Parchment	P93	1	•					
Pebble	P8R	1	•					
Pewter	P8D	1	•					
Salt	P8C	1	•					
Textured Brownstone	P7J	1	•					
Textured Designer White	PK7	1	•					
Textured Flint	P7A	1	•					
Textured Loft	P7L	1	•					
Textured Muslin	P7M	1	•					
Textured Pebble	P8Y	1	•					
Textured Salt	P8Z	1	•					
Textured Titanium	P8V	1	•					
Titanium	P8T / T	1	•					
Champagne Metallic	PR5	2	•					
Gunmetal Metallic	PR3	2	•					
Night Bronze	P8B	2	•					
Platinum Metallic	PR2	2	•					
Pyrite	PJE	2	•	•				
Silver	PR6**	2	•	•	•	•	•	•
Silver Texture	PR8	2	•					
Solar Black	P8X	2	•	•				
Atom	P8S	3	•					
Blossom	P8K	3	•					
Bullseye	PJF	3	•					
Ember	P8P	3	•					
Ion	P8N	3	•					
Iris	P8J	3	•					
Krypton	P8F	3	•					
Regatta	P8M	3	•					
Succulent	P8A	3	•					

**PR6 no upcharge on storage hardware

FINISHES

Finishes

LAMINATES

GRADE L1

SOLID COLORS

Black P
Brownstone*LM13
Bungalow*LM12
Designer White*LDW1
Flint*LM16
Fossil Shale*LEH1
Loft*LM11
Muslin*LM15
Titanium*LT11

ABSTRACT

AshLT3B
Handspun PearlLAHP
Handspun DoveLAHD
Handspun SlateLAHS
Handspun ChestnutLAHC
Silver MeshLT8D

WOODGRAIN

BelairLWBA
Bourbon CherryH
Field ElmLWFE
Florence Walnut*LFW1
Kingswood Walnut*LK11
Natural Maple*LWD
NeoWalnut*LNU1
PinnaclePINC
Shaker Cherry*LW7C

GRADE L2

Beigewood*LWBE
Fawn Cypress*LFC1
Lowell Ash*LLA1
Mangalore Mango*LMM1
Natural Recon*LNR1
Phantom Charcoal*LPC1
Phantom Ecru*LPE1
Portico Teak*LPT1
Skyline Walnut*LSW1
Veranda TeakLVT1

GRADE L3

Natural Walnut*LWNW
-----------------	-----------

* Storage available in these 30 laminates.

LAMINATE AND PAINTED WOOD STORAGE PULLS

SilverPR6
--------	----------

LAMINATE EDGE COLORS

BeigewoodDE
BelairBA
BlackE4
Bourbon CherryH
BrownstoneEY
BungalowEX
Designer WhiteDW
Fawn CypressFC
Field ElmFE
FlintE9
Florence WalnutFW
FossilEH
Kingswood WalnutKI
LoftEV
Lowell AshDL
Mangalore MangoMM
MuslinEU
Natural MapleDD
Natural ReconNR
Natural WalnutDN
NeoWalnutNU
ParchmentEN
Phantom CharcoalPC
Phantom EcruPE
PinnaclePI
Platinum Metallic†EP
Plyband ♦PL
Portico TeakDP
Shaker CherryDF
Skyline WalnutSW
TitaniumTI
Veranda TeakVT

† Not available on Aware table tops.

♦ Edge is limited to flat edge surfaces: rectangle, square, trapezoid, polygon, or round. No curvilinear or combination curve and straight.

NOTE: Refer to individual product pages for upcharges.

FSC Certified Wood at Allsteel
See page 336 for more information.

Finishes

Pattern Name	Code	Grade	Align	Involve Storage Screens & Desking	Approach
Belair	LWBA	1	•		
Bourbon Cherry	H	1	•		•
Brownstone	LM13	1	•	•	
Bungalow	LM12	1	•	•	
Designer White 15051	LDW1	1	•	•	•
Field Elm	LWFE	1	•		•
Flint	LM16	1	•	•	•
Fossil Shale	LEH1	1	•	•	
Loft	LM11	1	•	•	•
Muslin	LM15	1	•	•	
Titanium	LT11	1	•	•	
Florence Walnut	LFW1	1	•	•	•
Kingswood Walnut	LK11	1	•	•	•
Natural Maple	LWD	1	•	•	
NeoWalnut	LNU1	1	•	•	•
Pinnacle	PINC	1	•		•
Shaker Cherry	LW7C	1	•	•	
Beigewood	LWBE	2	•	•	
Fawn Cypress	LFC1	2	•	•	•
Lowell Ash	LLA1	2	•	•	•
Mangalore Mango	LMM1	2	•	•	
Natural Recon	LNR1	2	•	•	•
Phantom Charcoal	LPC1	2	•	•	
Phantom Ecrú	LPE1	2	•	•	•
Portico Teak	LPT1	2	•	•	•
Skyline Walnut	LSW1	2	•	•	•
Veranda Teak	LVT1	2	•	•	•
Natural Walnut	LWNW	3	•	•	

Pattern Name	Code	Grade	Beam	Half	Square	Bar	Arch
Designer White	PJW	1	•	•	•	•	
Silver	PR6	1	•	•		•	
Black	P27	1				•	
Flint	P02	1			•		
Loft	P7B	1			•		
Matte Silver	EL	1			•		
Anodized Silver	PR0	1					•
Pyrite	PJE	2	•	•	•		
Solar Black	P8X	2	•	•	•		

Storage is an essential part of the productive workplace.

Make storage a matter of personal choice as well as necessity. Choose from metal, laminate, or veneer with features like multiple pull styles, drawer sizes, finishes, and more. It's your workspace. Shouldn't it look like it?

PERSONAL STORAGE

- 1. Pedestal.**
Support, mobile, or suspended, with three drawer sizes.
- 2. Personal file.**
Combines pedestal and lateral storage to create a personal filing solution for letter and legal size documents.

- 3. Personal tower.**
Versatile storage with a small footprint. It's storage that goes up, not out. Combine drawers, personal storage, and wardrobe options for the right solution.
- 4. Low credenza.**
Active storage that creates a layered look in any workspace.

LATERALS AND SHARED STORAGE

- 5. Lateral file.**
The storage workhorse, in multiple heights and widths. Works with systems furniture or by itself.
- 6. Combination file.**
The perfect combination of file storage and shelf storage, with concealed or open shelves.
- 7. Storage cabinet.**
Equipped with hinged, locking doors and adjustable shelves to conceal and secure supplies.
- 8. Bookcases.**
Quick access to information, in depths to match laterals or narrower profiles to stand on their own.

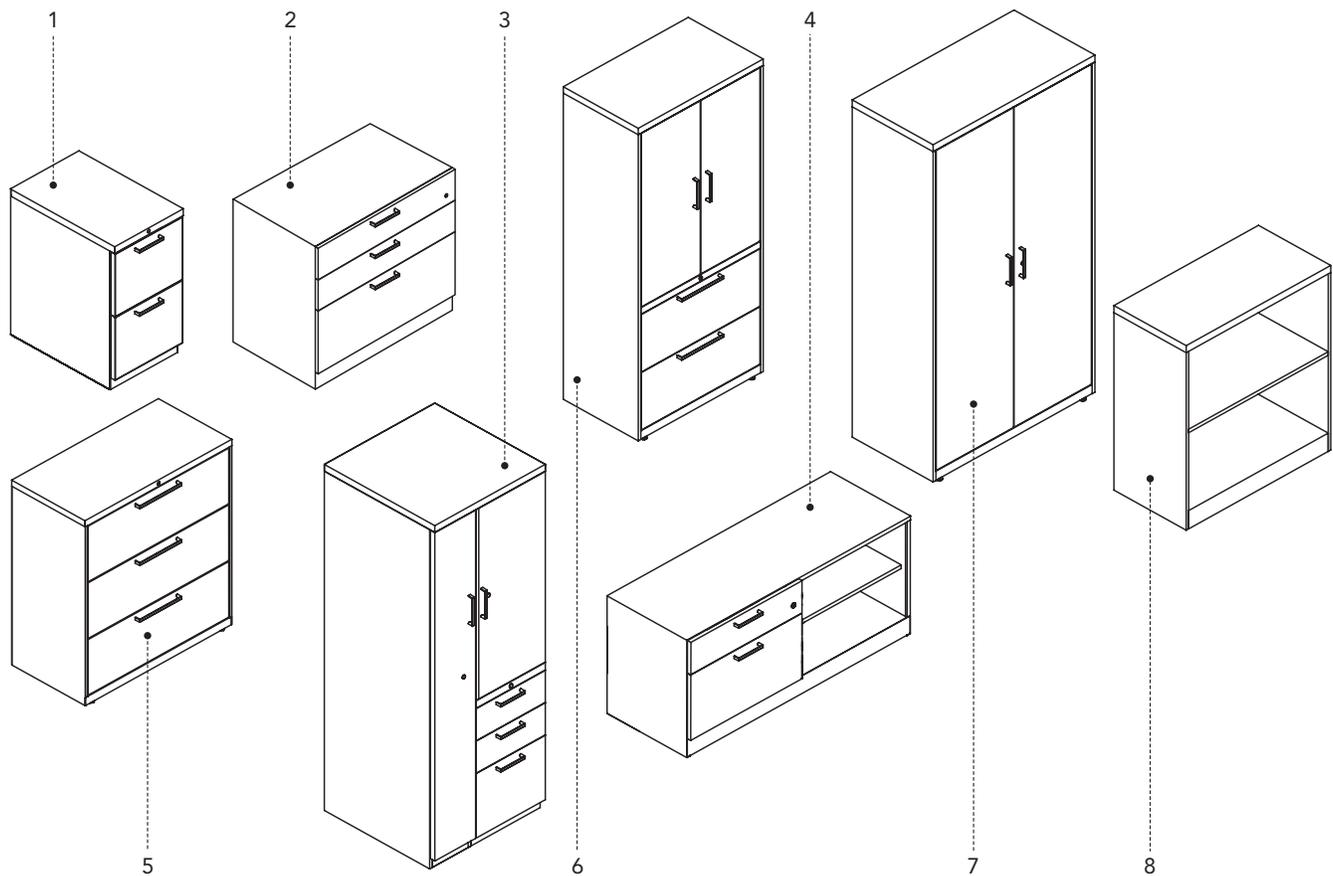

STORAGE OVERVIEW

PULL OPTIONS AVAILABLE									
Beam and Halo Pulls available Q1 of 2021									
STORAGE SOLUTIONS	Arch	Bar	Beam	Halo	Straight	Square	Beveled	Linear	Integral
Pull Letter Designator:	A				H	S	B	(None)	I
Pull Reference: (Pedestal Drawer Fronts)									
Align Metal	•		•	•	•	•	•		•
<i>Align 12" W Metal Towers*</i>									
<i>Align Metal Lockers*</i>									
Align Metal Storage with Laminate Fronts	•		•	•	•	•			
Align Veneer	•		•	•		•			
<i>Align Veneer Hutch*</i>									
<i>Align All Veneer Overhead w/hinged doors*</i>									
<i>Align All Veneer Bookcases</i>									
Essentials	•					•	•		•
<i>Essentials Bookcases*</i>									
<i>Essentials Overfile*</i>									
Radii		•	•	•		•			
All Metal Overheads	•					•			
<i>All Metal Overhead w/single sliding door</i>									
Approach	•	•	•	•		•			
Involve	•		•	•	•	•			
<i>Involve Overheads*</i>									
Further	•		•	•	•	•		•	

Exceptions:

Align 12" W Metal Towers not available with Integral Pull

Align Metal Lockers not available with Bevel Pull

Align Veneer Hutch (no pull required)

Align All Veneer Overhead (no pull required)

Align All Veneer Bookcases (no pull required)

Involve Overheads (no pull required)

Essentials Bookcases (no pull required)

Essentials Overfile (no pull required)

All Metal Overhead with single sliding door (no pull required)

Note: Beam and Halo pulls available on Radii, Approach, Involve, and Further casegoods March 15, 2021 with retrofit pull pack models for Align until Q4 2021

FOOT OPTIONS AVAILABLE							
	Blade Foot	Mobile	Plinth/No Foot	Post Foot	Stride Foot	Terrace Foot	Pier Foot
Align Metal Storage		•	•		•	•	•
Align Veneer			•				
Approach	•		•	•			
Essentials		•	•				
Further		•	•				
Involve			•		•	•	
Radii		•	•				

Available on Align Lockers and Wardrobes (pages 80-90)

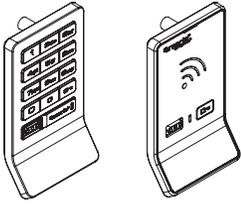

Keypad lock, left
RFID lock, right

The digital keypad & RFID lock options support applications where workstations or storage banks are shared by multiple users. This is an alternative to a standard key lock. This feature facilitates the use of storage by multiple users through eliminating the need to keep and hand-off physical keys. These locks ship in “shared mode” by default; shared mode indicates that the lock will “forget” the paired 4-digit code or RFID badge after the lock is opened, allowing the unit to be used by multiple users.

Digital keypad & RFID locks:

- Offered on Align™ lockers and wardrobes
- Ship factory installed
- Offered in a polished silver finish
- Digital keypad lock requires input of a user-selected 4-digit code
- RFID lock requires a compatible RFID card or sticker
- Digital keypad and RFID locks are powered using 4 premium AA batteries.
- Battery life is dependent on the frequency of operation but can last up to 5-7 years
- To order Align wardrobes or lockers with a digital lock option, add "E" suffix to base model number. The digital lock has an integrated pull, so no pull will be specified.

RFID locks require user to present a compatible RFID card or sticker to the lock in order to gain access. This is the same technology as “badge” systems that allows employers to grant employee with cards that can be scanned to gain access to entrances and buildings. Allsteel locks *may or may not be* compatible with these existing badge systems.

- For existing RFID badge system compatibility, badges must operate on a 13.56 MHz frequency with both iClass (ISO 15693) and Mifare (ISO 14443).
- If existing badge system is not compatible with 13.56 MHz frequency, compatible RFID badges or RFID stickers are sold separately as an accessory model.

Additional information about setup and common troubleshooting problems can be found here: [Digital Lock Overview](#).

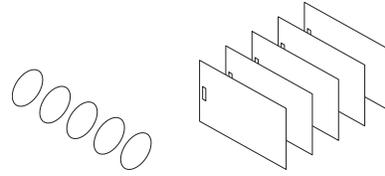

Digital Lock Accessory Models (page 91)

- RFID-compatible cards and stickers are sold as accessory models in increments of 5, 25, or 100.
- RFID cards are plain white and have a lanyard cut in them.
- RFID stickers are plain white, approximately 1" in diameter, and may be added to the back of an existing badge or employee identification card.
- Every digital keypad or RFID installation site will require *one* Programming Key and *at least one* Manager Key, sold separately.

Programming Key

- A Programming Key is a device used to initialize locks out of factory default mode and register Manager Keys to the locks.
- Only one Programming Key should be specified per installation site because multiple Programming Keys are not compatible with each other.
- Once a programming key is used with a unit, it is tied to that lock. Another programming key can not be used.
- Add-on digital lock orders should be programmed with the original programming key.

Manager Key

- A Manager Key is used to bypass a locked unit; this operates as the “master” key and it is recommended that building facilitators have at least one Manager Key.
- Up to 6 Manager Keys may be registered to each lock.
- Manager Keys provide external power to locks in case of battery failure.

Description	Model	List Price
Digital Lock Keys and Accessories		
Programming Key	YPLDIGPRG	\$ 340
Manager Key	YPLDIGMGR	\$ 263
5pk RFID Stickers	YPLRFID5S	\$ 113
5pk RFID Cards	YPLRFID5C	\$ 226
25pk RFID Stickers	YPLRFID25S	\$ 537
25pk RFID Cards	YPLRFID25C	\$ 1074

*Digital Lock users must purchase a programming key to operate. Programming keys and manager keys are purchased separately from locks.

Available on Align (Pedestals, Credenzas, Towers) and Radii Products

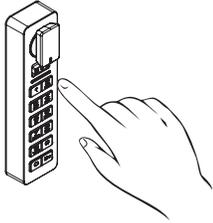

The digital keypad lock options support applications where workstations or storage banks are shared by multiple users. This is an alternative to a standard key lock. This feature facilitates the use of storage by multiple users through eliminating the need to keep and hand-off physical keys. These locks ship in “shared mode” by default; shared mode indicates that the lock will “forget” the paired 4-digit code, allowing the unit to be used by multiple users.

Digital keypad locks:

- Ship factory installed
- Offered in a polished silver finish
- Digital keypad lock requires input of a user-selected 4-digit code
- Digital keypad powered using 2 premium lithium CR2450 batteries
- Battery life is dependent on the frequency of operation but can last up to 5-7 years
- Digital keypad locks are installed horizontally on Align pedestals, credenzas, and towers

Additional information about setup and common troubleshooting problems can be found here: [Digital Lock Overview](#).

Programming Key

- A Programming Key is a device used to initialize locks out of factory default mode and register Manager Keys to the locks.
- Only one Programming Key should be specified per installation site because multiple Programming Keys are not compatible with each other.
- Once a programming key is used with a unit, it is tied to that lock. Another programming key can not be used.
- Add-on digital lock orders should be programmed with the original programming key.

Manager Key

- A Manager Key is used to bypass a locked unit; this operates as the “master” key and it is recommended that building facilitators have at least one Manager Key.
- Up to 6 Manager Keys may be registered to each lock.
- Manager Keys provide external power to locks in case of battery failure.

Description	Model	List Price
Digital Lock Keys and Accessories		
Programming Key	YPLDIGPRG	\$ 340
Manager Key	YPLDIGMGR	\$ 263

*Digital Lock users must purchase a programming key to operate. Programming keys and manager keys are purchased separately from locks.

Align Metal Pedestals — support or mobile



File/File
28½"H x 15"W
18", 23¼", 29¼"D



Box/Box/File
28½"H x 15"W
18", 23¼", 29¼"D



File/File
26½"H x 15"W
18", 23¼", 29¼"D



Box/Box/File
26½"H x 15"W
18", 23¼", 29¼"D



Box/File
20½"H Mobile,
22"H Freestanding
18", 23¼", 29¼"D x 15"W

Plinth base shown, models available with Stride or Terrace feet. Choice of metal or laminate fronts.

Align Low Metal Storage — credenzas, right and left configurations available

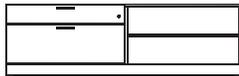

Box/Lateral/Open
72"W
22"H x 18", 24"D

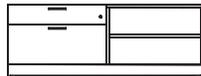

Box/Lateral/Open
60"W
22"H x 18", 24"D

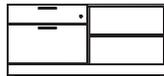

Box/Lateral/Open
48"W
22"H x 18", 24"D

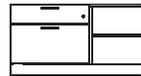

Box/Lateral/Open
42"W
22"H x 18", 24"D

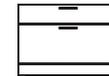

Box/Lateral
24", 30", 36", 42"W
22"H x 18", 24"D

Plinth base shown, models available with Stride or Terrace feet. Choice of metal or laminate fronts.

Align Metal Lateral and Personal Files



2-High
28"H
30", 36", 42"W
18"D



2-High
28"H
30"W
18"D



2-High
28"H
24", 30", 36"W
18"D



Open
24", 30", 36", 42"W
22"H x 18", 24"D

Plinth base shown, models available with Stride or Terrace feet. Choice of metal or laminate fronts.

Align Metal Personal Towers — Stride®/Terrace®/Optimize™ Height — left configuration shown, also available right

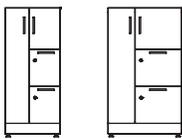

42½"H
18", 24"W
24"D

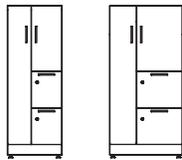

50"H
18", 24"W
24"D

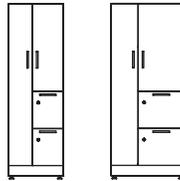

57½"H
18", 24"W
24"D

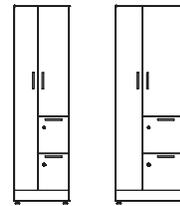

65"H
18", 24"W
24"D

Plinth base shown, models available with Stride or Terrace feet. Choice of metal or laminate fronts.

Align Lockers — Overview — Left configurations shown, also available right

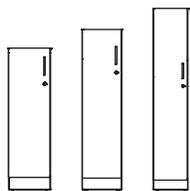

Single 12"W
42½", 50", 65"H / 18", 24"D

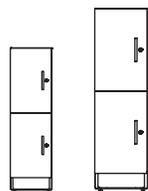

Double 12"W
42½", 65"H / 18"D

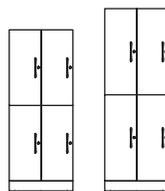

Quad 24"W
42½", 65"H / 18"D

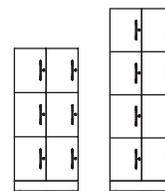

Cubby 24"W
50", 65"H / 18"D

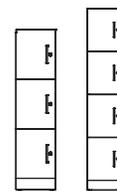

Cubby 12"W
50", 65"H / 18"D

Plinth base shown, models available with Stride or Terrace feet. Choice of metal or laminate fronts.

Essentials Pedestals — Ball-Bearing Slides

Support



File/File
28"H x 15"W
18", 22⁷/₈", 28⁷/₈"D



Box/Box/File
28"H x 15"W
18", 22⁷/₈", 28⁷/₈"D

Suspended



Box/File
19¹/₂"H x 15"W
18", 22⁷/₈"D

Basic Support



File/File
28" x 15"W
19¹/₂", 22⁷/₈"



Box/Box/File
28"H x 15"W
19¹/₂", 22⁷/₈"

Mobile



File/File
28"H x 15"W
18", 22⁷/₈", 28⁷/₈"D



Box/Box/File
28"H x 15"W
18", 22⁷/₈", 28⁷/₈"D



Box/File
22¹/₂"H x 15"W
22⁷/₈"D

Basic Mobile



File/File
28"H x 15"W
19¹/₂", 22⁷/₈"



Box/Box/File
28"H x 15"W
19¹/₂", 22⁷/₈"

Essentials Lateral Files

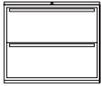

2-High
28"H
30", 36", 42"W
18"D

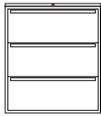

3-High
39¹/₂"H
30", 36", 42"W
18"D



4-High
52¹/₂"H
30", 36", 42"W
18"D



5-High
64¹/₄"H
30", 36", 42"W
18"D

Essentials Combination Files

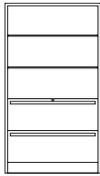

Without Doors
64¹/₄"H
30", 36"W
18"D

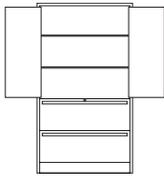

Hinged Doors
64¹/₄"H
30", 36"W
18"D

Essentials Cabinets

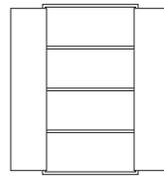

Hinged Doors
28", 39¹/₂", 52¹/₂", 64¹/₄"H
30", 36"W
18"D

Essentials Bookcases



28", 39¹/₂"H
30", 36"W
18"D



52¹/₂", 64¹/₄"H
30", 36"W
18"D

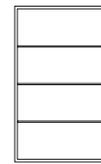

29", 41", 59",
71", 81"H
34¹/₂"W
12¹/₂"D

Notes

METAL STORAGE

- Finishes 30-31
- Working with Align Metal Storage..... 32-34
- Dimensions 35
- File/Load Capacities 36-37
- Align Metal Pedestal Specifications..... 38-39
- Credenzas and Accessories 40-41
- Metal Credenzas with Panel Frames 42
- Lateral/Personal/Laminate Top Specifications 43
- Tower Specifications 44-45
- Locker Specifications..... 46
- Support, Mobile, and Freestanding Pedestals 47-50
- Pedestal Tops and Accessories 51
- 22"H Credenzas..... 52-60
- 22"H Pedestals..... 61
- Open Shelf & HAT Credenzas 62
- Wire Management..... 63
- Align Accessories..... 64-66
- 28"H Laterals, Personal Files, and Bookcases 67
- Align Metal Towers..... 68-79
- Align Lockers, Wardrobes, and Accessories..... 80-90
- Digital Lock Keys and Accessories 91
- Storage Islands 92-102



PAINTED METAL FINISHES

GRADE P1

Black	P27
Brownstone	P7D
Bungalow	P7C
Cinder	P7Q
Cove	P096
Designer White	PJW
Dune	P094
Flint	P02
Fossil	P28
Harbor	P097
Loft	P7B
Muslin	P4J
Parchment	P93
Pebble	P8R
Pewter	P8D
Sage	P095
Salt	P8C
Textured Designer White	PK7
Textured Flint	P7A
Titanium	P8T

GRADE P2

Champagne Metallic	PR5
Gunmetal Metallic	PR3
Platinum Metallic	PR2
Silver**	PR6
Solar Black	PRX

**PR6 no upcharge on Involve; available as a Grade P2 color on stanchions. PR6 & PRX are not available on Concensys, Essentials bookcase, and vertical files.

GRADE P3

Atom	P8S
Blossom***	P8K
Bullseye	PJF
Ember	P8P
Ion	P8N
Iris	P8J
Krypton	P8F
Ochre***	P093
Regatta	P8M
Sienna***	P092
Succulent***	P8A

Metallic paints, due to varying reflectance, may appear to have less visual color consistency than other paint finishes, even when L/A/B values are exactly the same. (L/A/B — measurable aspects of color — values are maintained within a specified range, to ensure consistent appearance of paint colors.)

***These colors are intended to be an inspirational option for the trending market. Product application is limited and color availability is approximately two years to coincide with evolving workplace trends.

METAL STORAGE PULLS

Black (Bar or Arch Pull)	E4/P71
Designer White (Bar pull only)	PJW
Silver	EL/PR6

LAMINATES

GRADE L1

SOLID		
Black	P
Brownstone	LM13
Bungalow	LM12
Designer White	LDW1
Flint	LM16
Fossil Shale	LEH1
Loft	LM11
Muslin	LM15
Titanium	LTI1

WOODGRAIN

Belair	LWBA
Bourbon Cherry	H
Field Elm	LWFE
Florence Walnut	LFW1
Kingswood Walnut	LK11
Natural Maple	LWD
NeoWalnut	LNU1
Pinnacle	PINC
Shaker Cherry	LW7C

GRADE L2

Beigewood	LWBE
Fawn Cypress	LFC1
Lowell Ash	LLA1
Mangalore Mango	LMM1
Natural Recon	LNR1
Phantom Charcoal	LPC1
Phantom Ecu	LPE1
Portico Teak	LPT1
Skyline Walnut	LSW1
Veranda Teak	LVT1

GRADE L3

Natural Walnut	LWNW
----------------	-------	------

LAMINATE EDGE COLORS

Beigewood	DE
Belair	BA
Black	E4
Bourbon Cherry	H
Brownstone	EY
Bungalow	EX
Designer White	DW
Fawn Cypress	FC
Field Elm	FE
Flint	E9
Florence Walnut	FW
Fossil	EH
Kingswood Walnut	KI
Loft	EV
Lowell Ash	DL
Mangalore Mango	MM
Muslin	EU
Natural Maple	DD
Natural Recon	NR
Natural Walnut	DN
NeoWalnut	NU
Phantom Charcoal	PC
Phantom Ecu	PE
Pinnacle	PI
Portico Teak	DP
Shaker Cherry	DF
Skyline Walnut	SW
Titanium	TI
Veranda Teak	VT

STRATAWOOD VENEERS

GRADE V1

Add FSC prefix to Stratawood codes listed below for Stratawood veneer trim on Stride and Terrace.
Example: **FSCSC777**

CHERRY

Cinnamon/Biltmore Cherry	SC260
Lowell Ash Cherry	SC394
Clear Cherry	SC700
Light Cherry	SC701
Shaker Cherry	SC774
Burnished Cherry	SC777

MAPLE

Field Elm	SE599
Clear Maple***	SE800
Harvest Maple	SE856
Beigewood	SE878
Phantom Ecu	SE912
Belair	SE934

OAK

Clear Silver Oak****	SB100
Portico Teak Silver Oak	SB150
Clear Oak	SF300
Dark Rift Oak	SF331

****No FSC available

WALNUT

Florence Walnut	ST579
Light Walnut	ST601
Skyline Walnut	ST625
Pinnacle Walnut	ST679
Sumatra Walnut	ST693

NATURAL VENEERS — FLAT CUT

GRADE V2

CHERRY

Cinnamon/Biltmore Cherry	NC260
Lowell Ash	NC394
Medium Red Cherry	NC512
Light Cherry	NC701
Shaker Cherry	NC774
Burnished Cherry	NC777

MAPLE

Clear Maple	NE800
Harvest Maple	NE856

WALNUT

Ebony Walnut	NT509
Florence Walnut	NT579
Light Walnut	NT601
Skyline Walnut	NT625
Nutmeg Walnut	NT629
Pinnacle Walnut	NT679
Sumatra Walnut	NT693

NATURAL VENEERS — RIFT CUT

GRADE V3

Fawn Cypress Rift Cut Oak	RF108
Light Rift Cut Oak	RF301
Dark Rift Cut Oak	RF331
Phantom Ecu Rift Cut Oak	RF912

The beauty of wood is the natural variation of grain patterns and colors that make each piece unique. This variation is also influenced by lighting conditions, orientation of mated parts, and varying acceptance of the finishing process. The varying colors and physical characteristics naturally occur in all wood species but are most pronounced in lighter colored woods, and are especially evident in natural finishes.

GROMMETS ON VENEER WORKSURFACES

Wire management grommets come standard on most veneer worksurfaces. Choose between metal or plastic grommet option. Note: Plastic grommet color is predetermined based on finish selection. All Maple veneers.....Muslin EU All other veneersBlack E4

LOCKS

Black	E4
Chrome	ordered by base model
Matte Silver	EL

NOTE: Refer to individual product pages for upcharges.

FABRIC WIRE MANAGER

GRADE 1

DAPPER

Ash.....	DAPR20
Breeze.....	DAPR06
Canvas.....	DAPR25
Charcoal.....	DAPR01
Clover.....	DAPR22
Currant.....	DAPR00
Fawn.....	DAPR35
Fern.....	DAPR85
Gerbera.....	DAPR16
Grape.....	DAPR33
Jewel.....	DAPR08
Marigold.....	DAPR65
Onyx.....	DAPR10
Orchid.....	DAPR90
Parrot.....	DAPR59
Poppy.....	DAPR19
Sapphire.....	DAPR07
Scarlet.....	DAPR45
Sepia.....	DAPR30
Sky.....	DAPR44
Slate.....	DAPR15
Sorbet.....	DAPR55
Spring.....	DAPR80
Terracotta.....	DAPR13
Titanium.....	DAPR17
Varsity.....	DAPR09
Zest.....	DAPR70

HAMILTON

Biscotti.....	HAML11
Cabernet.....	HAML08
Carolina.....	HAML21
Charcoal.....	HAML17
Chocolate.....	HAML13
Cloud.....	HAML18
Dane.....	HAML16
Dusty Rose.....	HAML07
Esmeralda.....	HAML06
Fern.....	HAML04
Fresh.....	HAML03
Granola.....	HAML19
Lilac.....	HAML14
Lime.....	HAML05
Lipstick.....	HAML09
Oxford.....	HAML20
Passion Fruit.....	HAML02
Pepper.....	HAML15
Powder.....	HAML12
Sunrise.....	HAML01

FABRIC WIRE MANAGER

— cont'd

GRADE 3

MOXIE

Barnwood.....	SX09
Basalt.....	SX23
Bayou.....	SX02
Bermuda.....	SX52
Biscotti.....	SX08
Blackberry.....	SX48
Blarney.....	SX49
Blueberry.....	SX05
Bonsai.....	SX20
Brigade.....	SX53
Butterscotch.....	SX54
Carob.....	SX24
Chalk.....	SX50
Chartreuse.....	SX34
Cherry.....	SX38
Cinnamon.....	SX13
Cobalt.....	SX01
Coconut.....	SX06
Concrete.....	SX43
Cozumel.....	SX55
Cumin.....	SX32
Dragonfly.....	SX44
Dover.....	SX56
Earl Grey.....	SX40
Elysian.....	SX04
Evergreen.....	SX21
Fatigue.....	SX18
Fawn.....	SX30
Flint.....	SX39
Forsythia.....	SX57
Grenache.....	SX58
Hazel.....	SX31
Hemp.....	SX45
Hickory.....	SX25
Holly.....	SX51
Jam.....	SX16
Kelly.....	SX33
Lemongrass.....	SX19
Lime.....	SX41
Macintosh.....	SX12
Midnight.....	SX59
Mulberry.....	SX15
Muslin.....	SX60
Pacifica.....	SX61
Parchment.....	SX07
Peacock.....	SX03
Phantom.....	SX62
Pineapple.....	SX42
Plum.....	SX17
Punch.....	SX46
Riverstone.....	SX47
Russet.....	SX14
Smokestack.....	SX22
Tangerine.....	SX37
Terracotta.....	SX11
Thicket.....	SX35
Walnut.....	SX10
Whirlwind.....	SX63

PURL

(80% Polyester, 20% Acrylic)

Alpaca.....	PURL08
Braid.....	PURL10
Deep.....	PURL12
Graze.....	PURL05
Loom.....	PURL06
Needle.....	PURL07
Pasture.....	PURL02
Ranch.....	PURL04
Shuttle.....	PURL09
Skein.....	PURL01
Thistle.....	PURL11
Yearling.....	PURL03

FABRIC WIRE MANAGER

— cont'd

QUILL

Aviary.....	QUL03
Feather.....	QUL02
Fountain.....	QUL06
Ink.....	QUL05
Metal.....	QUL04
Reed.....	QUL08
Scroll.....	QUL01
Well.....	QUL07

"O" Frame Construction

Heavy duty outer shell and front and rear perimeter frames provides significant strength; helps keep the cabinet true to square.

File and Box Drawers

Full extension file and box drawers glide easily on steel ball-bearing suspensions; allows complete access to drawer contents with a quiet drawer motion.

Filing

File drawers can accommodate front-to-back and side-to-side filing. Order hanging frames separately.

Full Front Drawer Design

Drawer front is square and extends fully across the case.

Counterweight

Counterweights (standard on mobile pedestal units) inhibit tipping when drawers are opened. Optional counterweight kits.

Aesthetic Alignment

Drawer alignment matches across Align storage offering. Base height matches Stride® and Terrace® panel base.

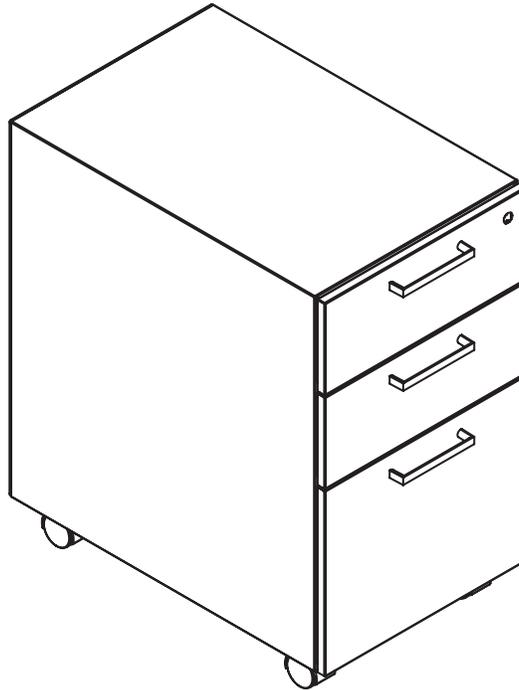

Locking System

Robust lock system for security and reliability.

Core Removable Locks

Master-keyed core removable lock feature allows key numbers to be easily changed in the field and facilitates one-key access.

Omit Lock Core

Units can be shipped with lock cores removed; cores can then be installed after units are placed. Different storage components can be keyed alike within a workstation.

Mobile Pedestals

Mobile pedestals provide flexible storage and can be nested under worksurfaces. (Take into consideration when planning offices which may have uneven floors.)

Support Pedestals

Support pedestals can support one end of a panel-attached worksurface, in lieu of other worksurface supports, and can be used to support worksurfaces in desking applications. Drawers align with laterals.

Freestanding Pedestals

Freestanding pedestal drawers align with credenzas.

Depth

Pedestals are 18", 23¼", and 29¼"D, and credenzas are 18" and 24"D, both can be used with systems worksurfaces. Placement may affect access to receptacles in base pathway and worksurface grommets.

Pull Styles

Choice of pull styles, available on pedestals, credenzas, towers, and laterals, allows for total design coordination on projects.

Veneer and Landscape Fronts

Contact Allsteel Tailored Products Group for availability.

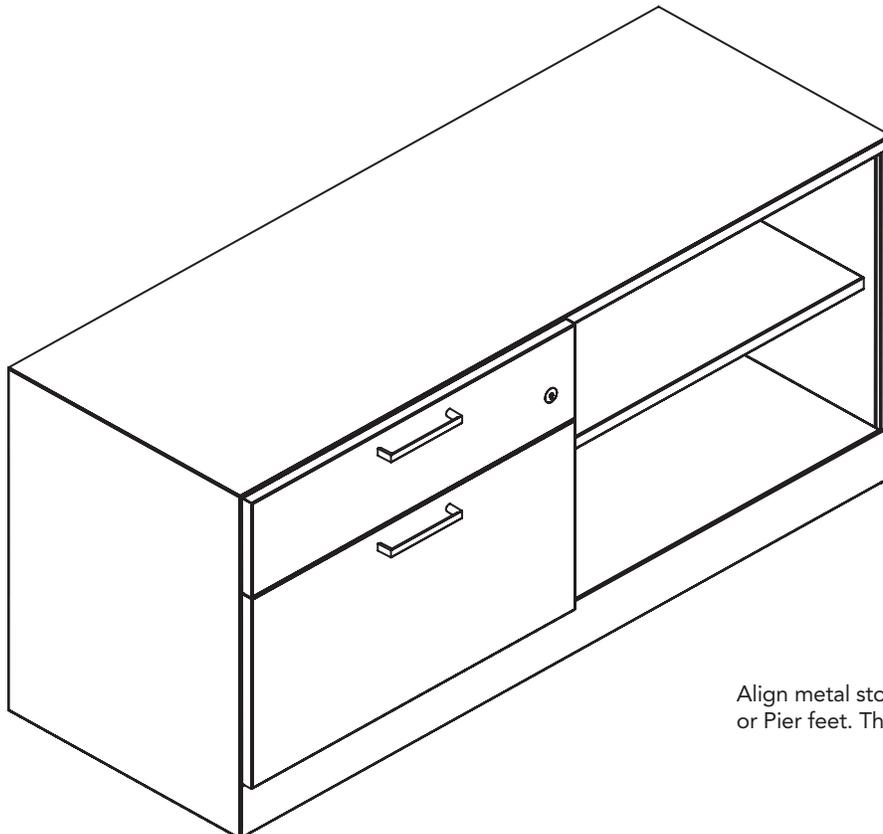

Align metal storage models are available with Terrace, Stride, or Pier feet. There is also a laminate front option.

Seven-formation

Front Post Design

Steel front posts are formed with seven formations to provide unparalleled stability and strength. This unique design allows unmatched longevity for Allsteel files.

Dual-side Locking

Drawers and doors lock on both sides to prevent being pried open. The locking system is enclosed within the case to hide mechanisms which can snag and scratch. This feature is not found on most other manufacturers' files.

Dual Interlock

This mechanism inhibits roll out of more than one drawer, either sequentially or simultaneously.

Adjustable Drawer Backs

Backs are adjustable to three depths to accommodate letter, A4, and legal documents side to side without the need for extra components.

Infinitely Adjustable Divider

This Allsteel exclusive design allows the divider to also function as a compressor in that it can be located where it is needed versus being limited to pre-set positions.

Offset Construction

As a result of the back and the top of the case sides being offset, the file case has a finished appearance with smooth seams and no overlaps.

Fully Enclosed Bottom

Unlike many files, the Allsteel file features a fully enclosed steel bottom to help prevent moisture and dust from affecting the filed documents. Double bottoms are welded into all files for added rigidity.

Side Knockouts

Files have two knockouts on each side to allow easy ganging of freestanding units to inhibit tipping.

Four Hex-head Leveling Glides

Leveling glides can be adjusted from outside or inside the case. Because of the hex-head design of the stem, leveling can be done even when the file is fully loaded. Range is 1½".

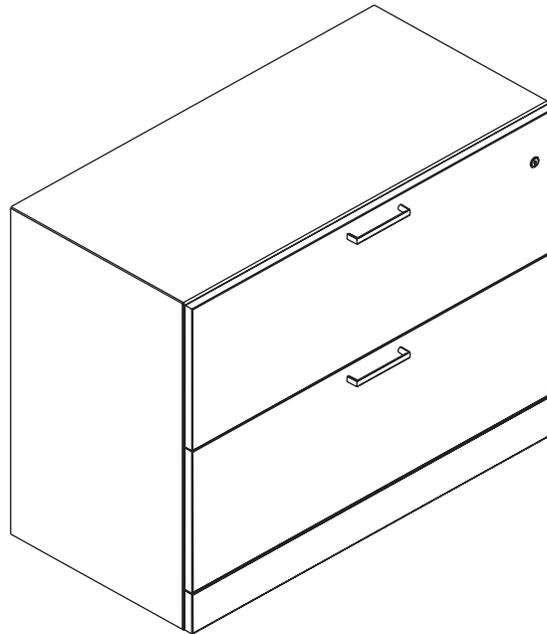

Suspension

Extra heavy-duty, telescoping, ball-bearing slides.

Hanging Frames

Front-to-back and side-to-side are both standard. For front-to-back filing, backs should be set on rear position for maximum storage capacity.

Core Removable Lock

Core removable lock feature allows key numbers to be easily changed in the field. It also facilitates installation.

Omit Lock Core

Files can be shipped with lock cores removed; cores can then be installed after files are placed. Laterals can be keyed alike with pedestals, laterals, credenzas, towers, and overhead cabinets.

Full Front Drawer Style

Features core removable lock located in top drawer on the right.

Front Drawer Options

Optional veneer and Landscape™ fronts available on laterals, contact Allsteel Tailored Products Group.

Pull Styles

Choice of pull styles, available on pedestals, credenzas, towers, lockers, wardrobes and laterals, allows for total design coordination on projects.

Double-wall Drawer Front Construction

Drawer fronts are fully lined to reduce noise and to prevent damage from drawer contents.

Counterweight Kit

The unique design of the counterweight allows easy installation because, unlike some files, the drawers and shelves in Allsteel files do not have to be removed to install the required counterweights.

Drawer Interiors

Painted same color as case.

Paint Finish

Durable baked enamel finish is applied over rust-inhibiting phosphate pre-treatment.

Four Hex-head Leveling Glides

Hex-head design of the stem allows leveling to be done even when the cabinet is fully loaded (plinth units only). Plinth units include leveling glides that can be adjusted 1½" from outside or inside the case. Footed units include leveling glides that can be adjusted 2¼" from outside the case only.

Aesthetic Alignment

Drawer alignment matches other Align storage.

Full Front Design

Drawer and door fronts extend fully across the case.

Pull Styles

Choice of pull styles, available on pedestals, credenzas, towers, lockers, wardrobes and laterals, allows for total design coordination on projects.

Suspension

Heavy-duty, telescoping ball-bearing slides.

Omit Lock Core

Units can be shipped with lock cores removed; cores can then be installed after storage units are placed. Laterals can be keyed alike with pedestals, towers, and overhead cabinets.

Core Removable Locks

Core removable lock feature allows key numbers to be easily changed in the field. It also facilitates installation.

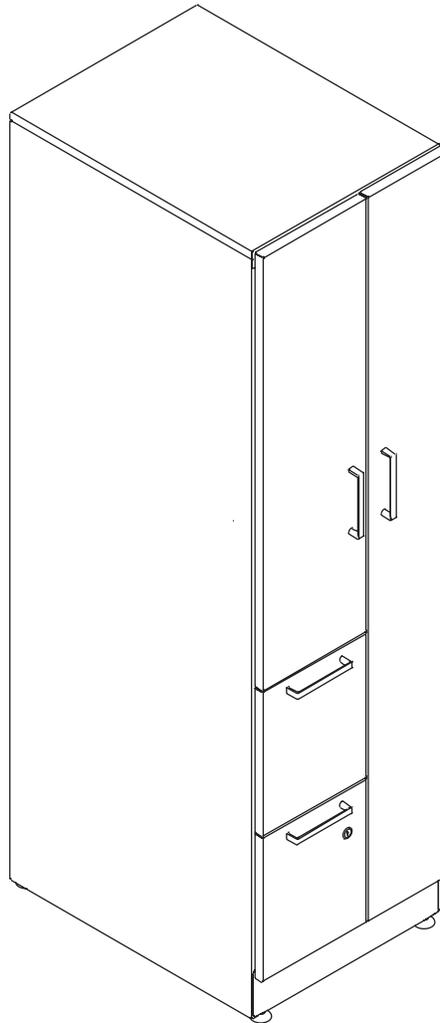

Locking

All door & drawer locks are controlled by one lock core located on the top drawer. Standard core removable locks, see page 65.

European Hinges

Wardrobe and cabinet door both contain European-style hinged door.

Filing

File drawers in 24"W towers accommodate front-to-back and side-to-side filing. Order file rails for side-to-side separately. File drawers in 18"W slim towers accommodate side-to-side filing only, hang rails are included.

Counterweight

Towers are factory-installed with counterweights to allow them to be freestanding.

Interior Dimensions for Credenzas

Description	Height	Depth	Width	
CREDENZAS	Open	22"H – 17¼"	18"D — 17½" – 17" interior Shelf 15¼"	24" exterior – 22½" interior 30" exterior – 28½" interior
		1 Adj. Shelf ¾"	24"D — 23½" – 23" interior Shelf 21¼"	36" exterior – 34½" interior 42" exterior – 40½" interior
		8¼" Shelf 8¼" or 12" Shelf 4½"		
	Box/Lateral	Box – 3⅞"	Box – 13¼"	24" exterior – 21" interior 30" exterior – 27" interior 36" exterior – 33" interior
		Lateral – 10½"	18"D — Lateral – 13¼" 24"D — Lateral – 15½"	24" exterior – 20½" interior 30" exterior – 26½" interior 36" exterior – 32½" interior
	Box/Lateral w/Open Side	Box – 3⅞"	Box – 13¼"	42" exterior – 21" interior 48" exterior – 21" interior 60" exterior – 27" interior 72" exterior – 33" interior
		Lateral – 10½"	18"D — Lateral – 13¼" 24"D — Lateral – 15½"	42" exterior – 20½" interior 48" exterior – 20½" interior 60" exterior – 26½" interior 72" exterior – 32½" interior
		Open – 17¼"	18"D — 17½" – 17" interior Shelf 15¼"	42" exterior – 16½" interior 48" exterior – 22½" interior
		1 Adj. Shelf ¾"	24"D — 23½" – 23" interior Shelf 21¼"	60" exterior – 28½" interior 72" exterior – 34½" interior
		8¼", Shelf, 8¼" or 12", Shelf, 4½"		
	LATERALS	Lateral – 10½"	18"D — Lateral – 13¼"	30" exterior – 26½" interior
			24"D — Lateral – 15½"	36" exterior – 32½" interior 42" exterior – 38½" interior

LOW STORAGE CREDENZAS — LATERAL FILE WIDTH:

24", 42", or 48"W

30" or 60"W

36" or 72"W

(42", 48", 60", and 72" credenzas are half lateral drawer/half open shelf)

Front-to-Back Filing*

Outside tabs of folders rest on drawer sides.

Letter Size Hanging File Folders
(8½ x 11" documents)



18"D – 11¼" of letter filing
24"D – 14¾" of letter filing



18"D – 23½" of letter filing
24"D – 29½" of letter filing



18"D – 23½" of letter filing
24"D – 29½" of letter filing

A4 Hanging File Folders
(8¼ x 11⅝" documents)



18"D – 11¼" of A4 filing
24"D – 14¾" of A4 filing



18"D – 23½" of A4 filing
24"D – 29½" of A4 filing



18"D – 23½" of A4 filing
24"D – 29½" of A4 filing

Legal Size Hanging File Folders
(8½ x 14" documents)



18"D – 11¼" of legal filing
24"D – 14¾" of legal filing



18"D – 11¼" of legal filing
24"D – 29½" of legal filing



18"D – 23½" of legal filing
24"D – 29½" of legal filing

Side-to-Side Filing

Letter or A4 Hanging File Folders

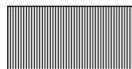

18"D – 20¼" of letter or A4 filing
24"D – 20¼" of letter, A4, or legal filing

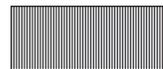

18"D – 26¼" of letter or A4 filing
24"D – 26¼" of letter, A4, or legal filing

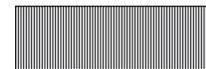

18"D – 32¼" of letter or A4 filing
24"D – 32¼" of letter, A4, or legal filing

* Front-to-back filing requires optional front-to-back filing bars **YPCAHR12** for 18"D units (except 2H lateral files use filing bar **YPCAHR15**) or **YPCAHR15** for 24"D units, one bar per row of filing. Order bars separately, see page 65.

LATERAL FILE WIDTH

30"W

36"W

42"W

Front-to-Back Filing — outside tabs of folders rest on drawer sides

Letter Size
(8½ x 11")

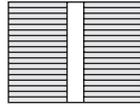

Filing Volume:
29½" (Align™)
30" (Essentials™)

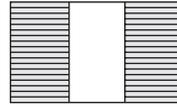

Filing Volume:
29½" (Align)
30" (Essentials)

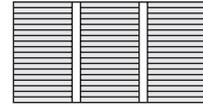

Filing Volume:
44¼" (Align)
45" (Essentials)

SHADED BOX INDICATES
MAXIMUM FILING EFFICIENCY

A4
(8¼ x 11¾")



Filing Volume:
14¾" (Align)
15" (Essentials)

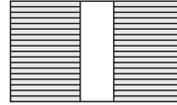

Filing Volume:
29½" (Align)
30" (Essentials)

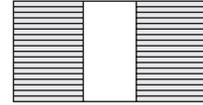

Filing Volume:
29½" (Align)
30" (Essentials)

Legal Size
(8½ x 14")

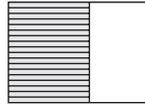

Filing Volume:
14¾" (Align)
15" (Essentials)

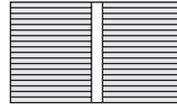

Filing Volume:
29½" (Align)
30" (Essentials)

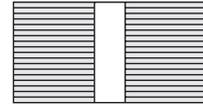

Filing Volume:
29½" (Align)
30" (Essentials)

EDP

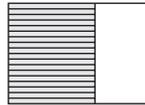

Filing Volume:
14¾" (Align)

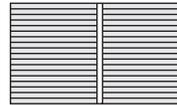

Filing Volume:
29½" (Align)

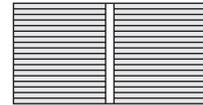

Filing Volume:
29½" (Align)

Side-to-Side Filing

Letter, A4 and Legal

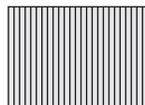

Filing Volume: 26¼"

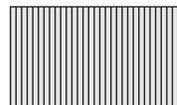

Filing Volume: 32¼"

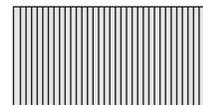

Filing Volume: 38¼"

Load Capacities (per current ANSI/BIFMA standards)

Align™

Opening Height	30" Wide	36" Wide	42" Wide
12"	87 lbs. (Metal)	107 lbs. (Metal)	126 lbs.

ANSI/BIFMA Standards

Allsteel lateral files, incorporating the **required counterweights** in freestanding situations, meet or exceed the applicable ANSI/BIFMA Storage Unit Test Standards X5.9-2012.

Align Metal Support, Freestanding, and Mobile Pedestals

- Heavy-duty steel O-frame.
- Steel, ball-bearing slide suspension with full-extension drawers.
- Support pedestals are available with flush or recessed plinth base, and Terrace, Stride, or Pier feet.
- Full front drawers are available as metal or laminate.
- Box drawers have an adjustable divider.
- Standard core removable locks, see page 65.
- For locking specification, see pages 332-334.

Align Metal Support Pedestals (pages 47-51)

- Support pedestals have a fully enclosed top with exposed pre-drilled holes for top attachment. An additional top is required.
- Available as box/box/file or file/file drawers.
- Pencil trays included — one per pedestal with a box drawer.
- File drawer front reveals of support pedestals will align with Align metal laterals, towers, and credenzas.
- Leveling glides standard on freestanding pedestals.
- Hardware for attaching pedestal to worksurface is included
- 28 $\frac{1}{8}$ " H pedestals can be used to support worksurface at 29 $\frac{1}{2}$ " H.
- Align metal support pedestals are available with flush or recessed base, and Terrace, Stride, or Pier feet.

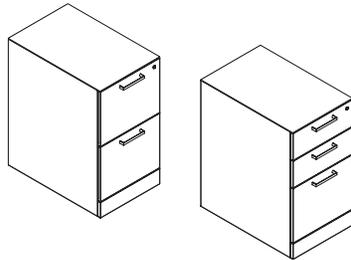

Align Metal Freestanding Pedestals (page 49)

- Available as box/file drawers.
- Pencil tray included in box drawer.
- Drawer reveals of freestanding pedestals will align with Align credenzas.
- Leveling glides standard on freestanding pedestals.
- Align metal freestanding pedestals are available with Terrace, Stride, or Pier feet.

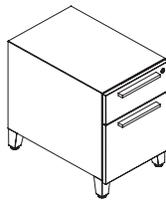

Align Metal Mobile Pedestals (pages 47-51)

- Available as box/file, box/box/file or file/file drawers.
- To allow clearance under worksurfaces, an Align mobile pedestal is 1 $\frac{1}{2}$ " shorter than an equivalent Align support pedestal. This, combined with the leveling range of Align support pedestals, personal files, towers, laterals, and credenzas will result in an offset of horizontal drawer reveals of 1 $\frac{1}{2}$ " to 3".
- Counterweight is standard in mobile pedestals.
- Four casters.
- Pencil trays included — one per pedestal with a box drawer.

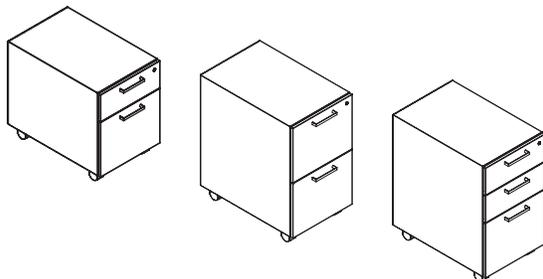

NEW models launching October 2021 as part of a model logic update. The new model logic will allow future flexibility to add additional pull and foot options. Existing models will discontinue November 1, 2021.

Align Metal Support and Mobile Pedestal Tops and Accessories

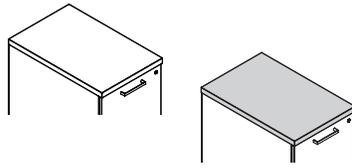

Align Pedestal Tops (page 51)

Field installed tops create additional storage and work areas on metal support or mobile pedestals.

- Laminate and veneer tops are 1/4" thick.
- Seat cushion provides quick and convenient additional seating on box/file pedestals.
- Seat cushion adds approximately 2"H to pedestal.
- YPPA prefix models have stitched corners and bumpers on bottom.
- Seat cushion to be used on steel (mobile) pedestal top only.
- COM yardage for seat cushion is 0.9 yards.

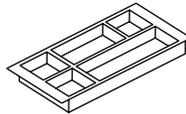

Align Pedestal Accessories (page 51)

- Accessories are for use with Align metal: pedestals, personal files, and personal towers.

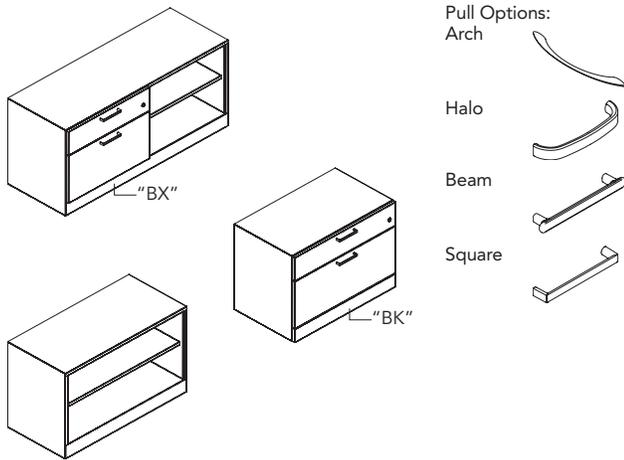

Load Capacities (per current ANSI/BIFMA standards)

Align 22"H Credenzas	24" Wide	30" Wide	36" Wide
3 7/8" H Box Drawer	19 lbs.	24 lbs.	30 lbs.
10 1/2" H Box Drawer	50 lbs.	64 lbs.	78 lbs.

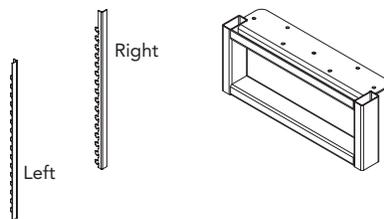

Credenzas (pages 52-60)

- Full metal construction with finished top and back.
- Welded case with "O" frame construction for added strength.
- Full front design with proud, double wall drawer fronts.
- Units are 18"D or 24"D, 17 1/4"D or 23 1/4"D on open bookcases.
- Interlock and full extension ball bearing slides on all drawers.
- Enclosed bottom pan on open bookcase and on box/lateral/open units.
- Available with Terrace, Stride, or Pier feet. Also available with plinth base, either flush or recessed.
- Drawer fronts are available as metal or laminate.
- Plinth base option on drawer only units: recessed or flush.
- Leveling glides can be extended 1 1/2".
- Side-to-side filing bar included. Front-to-back filing with optional filing bar. Two rows of front to back letter filing on drawers 30"W or wider drawers, order 2 filing bars. See page 36.
- Accessories include: seat cushions, laminate tops.
- Planning: requires panel bracket, worksurface stanchion, or counterweight (sold separately) for units with drawers. See page 42 for specification examples.

Storage-to-Panel Bracket (page 64)

- Used to attach the back or side of storage to a panel frame to provide stability when used with Stride, Terrace, or Optimize panel frames.
- Handedness is determined by side of storage that attaches to panel when facing panel run.

Worksurface Support Stanchions (page 64)

- Worksurface stanchions are PR6 Silver and made of aluminum.
- Use 5"H stanchions for 22"H Align credenza with worksurface, or 6"H stanchions for credenza without a worksurface.
- Available in depths of 12" and 18". 12" is designed to work with 18"D worksurfaces and 18" with 24"D worksurfaces. Use two stanchions when mounting a 30"D or deeper worksurface.
- Stanchion orientation should run perpendicular to the length of the worksurface it is supporting.

Front-to-Back Filing Bar (page 65)

- Front-to-back filing bar can be positioned to accommodate letter, A4, or legal size documents. 30"W and wider drawers can accommodate two rows requiring two bars. See page 36.

Counterweight Kits for 22"H Credenzas (page 65)

- Metal weight attached to back of freestanding files to inhibit tipping; field installed only. The use of a storage-to-panel bracket and worksurface stanchion may eliminate the need for counterweight, see page 42.
- Counterweight kit required for freestanding files:
 - 42"W and 48"W Credenzas..... 25 LB kit
 - 24"W, 60"W, and 72"W Credenzas..... 35 LB kit
 - 30"W and 36"W Credenzas..... 50 LB kit

Matte Silver Removable Lock Core Kit (page 65)

- Matte Silver used on Align credenzas with drawers. Includes one core, two keys, one core removal tool, adapter and instructions.
- The Allsteel Easy Lock Program simplifies the lock-core ordering process when multiple cores are being specified. To ensure ease of ordering in different situations the Easy Lock cores can be specified in three different ways — Random, Specified or Sequential. See page 334 for complete details and examples on the Allsteel Easy Lock program.

Magnetic Label Holder - Available July 2021 (page 65)

- 5 pack of magnetic label holders.

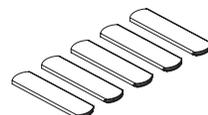

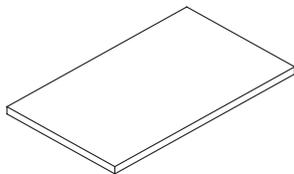

Credenza Cushions (page 66)

- Cushions are for use on 22"H Align credenzas to create additional seating.
- Cushions can be placed directly on metal top of unit or on laminate top.
- Freestanding applications require counterweights — see page 40.

Plinth Base models available.

Side-mounted Credenzas

Use 1 storage-to-panel bracket per Credenza — 1 LH and 1 RH.

The minimum credenza size is 22"H x 36"W x 18"D or 24"D.
 With a mid-run floor support, the maximum panel run is 144".
 Without a mid-run floor support, the maximum panel run is 96".
 Overheads and shelves cannot be used with 22"H side mounted credenzas.
 Worksurfaces (if specified) must be mounted on the same side of the parent run as the credenzas.
 Panel frame maximum height is 65".
 Counterweight is required.

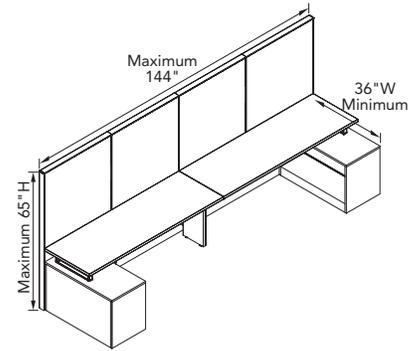

Back-mounted Credenzas — Modular

Use 2 storage-to-panel brackets per Credenza — 2 LH and 2 RH.

The minimum Credenza size is 22"H x 42"W x 18"D or 24"D.
 The maximum panel run between back-mounted Credenzas is 60".
 Overheads and shelves cannot be used with 22"H back mounted Credenzas.
 Worksurfaces (if specified) must be mounted on the same side of the parent run as the Credenzas.
 Panel frame maximum height is 65".

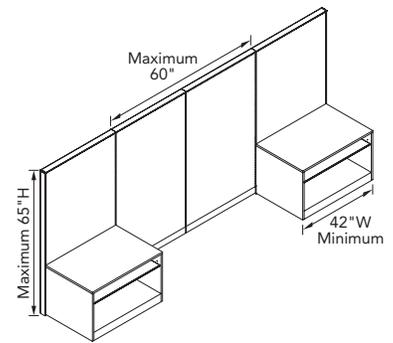

Back-mounted Credenzas — Off-Modular Ends

Use 1 storage-to-panel bracket per Credenza — 1 LH and 1 RH.

The minimum Credenza size is 22"H x 42"W x 18"D or 24"D.
 With a mid-run floor support, the maximum panel run is 144".
 Without a mid-run floor support, the maximum panel run is 96".
 Overheads and shelves cannot be used with 22"H back mounted Credenzas.
 Worksurfaces (if specified) must be mounted on the same side of the parent run as the Credenzas.
 Panel frame maximum height is 65".

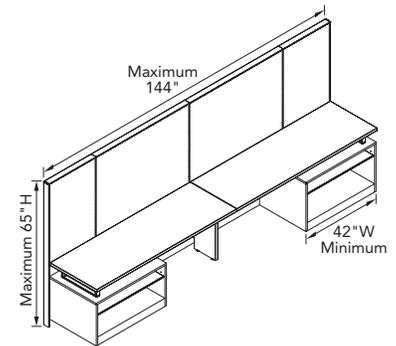

Side-mounted Credenzas — with Return Panel

Use 1 storage-to-panel bracket on Credenza.

The minimum Credenza size is 22"H x 36"W x 18"D or 24"D.
 The minimum size for panel return is 35"H x 36"W.
 With a mid-run floor support, the maximum panel run is 144".
 Without a mid-run floor support, the maximum panel run is 96".
 Overheads and shelves cannot be used with 22"H side mounted Credenzas.
 Worksurfaces (if specified) must be mounted on the same side of the parent run as the Credenzas.
 Panel frame maximum height is 65".
 Counterweight is required.

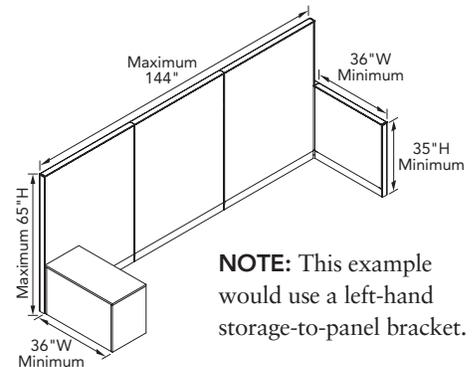

NOTE: This example would use a left-hand storage-to-panel bracket.

Align Lateral Files, Personal Files, and Accessories

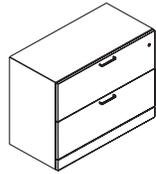

28"H Align Lateral Files, Personal Files, and Bookcases (page 67)

- Square edge full front.
- Beam, Halo, Square, and Arch metal pulls are customer installed.
- All files are 18"D.
- Files ship with glides fully recessed. Extend glides on 2-high files 3/4" to align with support pedestals.
- Hanging frames and dividers installed on-site.
- 2-high units have one lock.
- For locking specifications, see pages 332-334.
- Tops are available — order separately.
- 28"H Bookcases include one adjustable shelf.
- Adjustable shelf has 3 locations in 3.75" increments:
 - Bottom shelf location is 6.9" from bottom of case.
 - Middle shelf location is centered in case.
 - Top shelf location is 6.9" from top of case.
- Lateral Files come with file bars to accommodate either front-to-back or side-to-side filing. Personal files come with file bars to accommodate side-to-side filing only; front-to-back filing bars may be purchased separately.

Note: Counterweight kits are required for freestanding lateral files (i.e., files that are not positioned under a worksurface, ganged to an adjacent file, or bolted to the floor or wall.)

Align Accessories

Counterweight kit(s) for 28"H Credenzas (page 66)

- Counterweight kit(s) required for freestanding files:

2-high 30"W file.....	50 lbs.
2-high 36"W files	57½ lbs.
2-high 42"W files	70 lbs.
- Metal weight placed in bottom of freestanding files to inhibit tipping; field installed only.

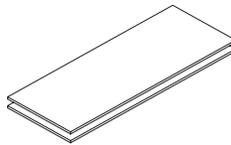

Front-to-back Filing Bar (page 65)

- Front-to-back filing bar can be positioned to accommodate letter, A4, legal or EDP size documents. See page 37 for complete filing information. Front-to-back filing bar must be used with side-to-side hanging frame.
- For 12"H interiors.

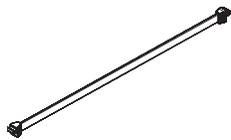

Plinth Base – Flush or Recessed

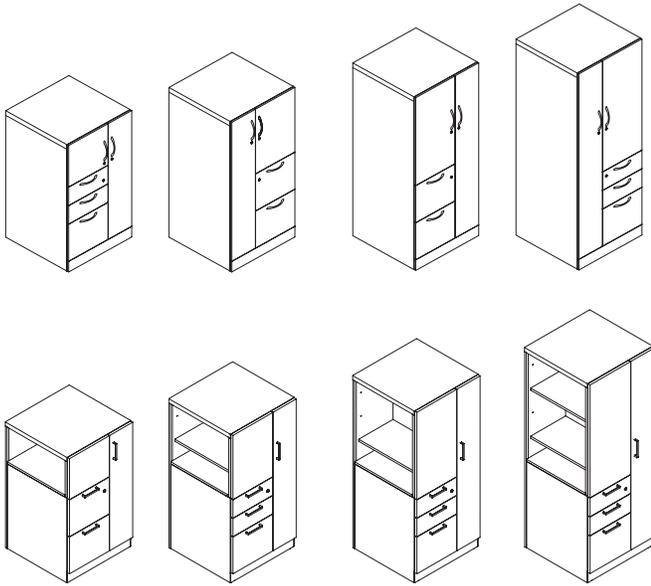

Foot Base – Stride®, Pier or Terrace DNA®

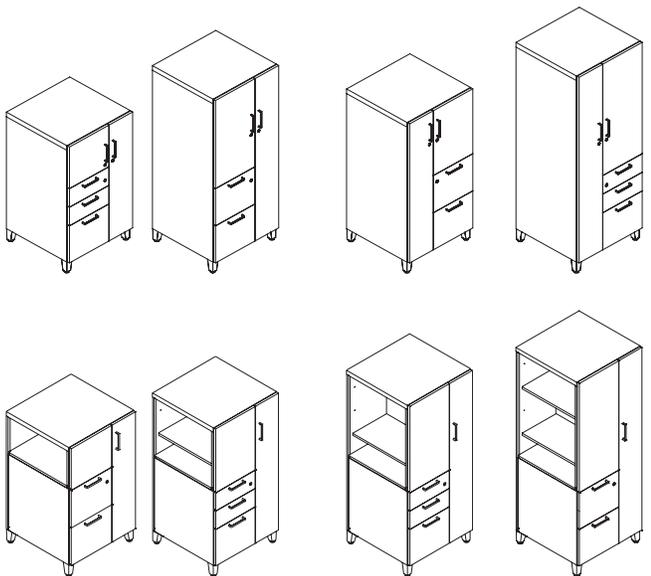

NEW & IMPROVED 18"W and 24"W Align Metal Towers

(pages 68-79)

This specification information is for Align tower models with the new model logic, ordered & produced after March 2020.

- Front-access personal towers include locking cabinet section, locking wardrobe section, and locking drawer section. Side-access personal towers include open side access bookcase, locking wardrobe section, and locking drawer section.
- 24"W towers offer the option of box/box/file or file/file drawer configuration. 18"W tower offers file/file drawer configuration only.
- Available with Terrace, Stride, or Pier feet. Also available with plinth base, either flush or recessed. Plinth is approximately 3.35"H and matches other Align storage. 18"W tower is also available as a mobile tower with casters.
- 18"W Mobile towers have two locking casters (in front) and two non-locking casters.
- Full front drawers and doors are available as metal or laminate. Laminate fronts have grain running vertically and are grain-matched.
- Optional markerboard finish is available only on side-access units with metal fronts. Only the front panel of the side-access portion will be finished with markerboard paint, the remaining drawer and door fronts will be painted to match the chassis. Markerboard finish is white.
- 24"W tower wardrobe portion is approximately 9"W. 18"W tower wardrobe portion is approximately 8 $\frac{1}{3}$ "W.
- The wardrobe portion of each tower comes installed with a rod accessory to accept clothing hanger(s) or a Radian work tool coat hook can be added. Radian coat hook is sold separately.
- Units can be shipped with lock cores removed; cores can then be installed after storage units are placed. Towers can be keyed alike with pedestals, credenzas, laterals, and overhead cabinets.
- Towers can be used to support a work surface. In order to bracket a work surface to a tower, order bracket model YPWTAWSBKT24.
- All drawers use heavy-duty, telescoping ball-bearing slides. All drawers feature 100% drawer extension.
- Case has a finished appearance with smooth seams and no overlaps.
- Drawer alignment matches other Align storage.
- 24"W tower is available with all pull styles. 18"W tower is available only with arch and square pull styles due to slim width of drawer.
- Cabinet door on 50"H and 57 $\frac{1}{2}$ "H units include one adjustable shelf. 65"H units include two adjustable shelves in this area. 42 $\frac{1}{2}$ "H unit does not include an adjustable shelf in the cabinet section.
- Side access portion door on 50"H and 57 $\frac{1}{2}$ "H units include one adjustable shelf. 65"H units include two adjustable shelves in this area. 42 $\frac{1}{2}$ "H unit does not include an adjustable shelf in the side-access portion.

Plinth or Foot Base — 12"W Wardrobe / Locker

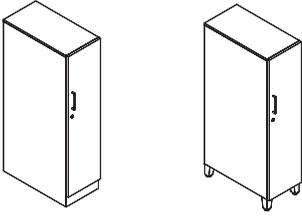
**NEW & IMPROVED 12"W Align Metal Wardrobe/Single Door Locker** (pages 80-82)

This specification information is for Align wardrobe models with the new model logic, ordered & produced after March 2020.

- Available in 42½", 50", and 65"H. Available in 18" or 24"D.
- Available with Terrace, Stride, or Pier feet. Also available with plinth base, either flush or recessed. Plinth is approximately 3.35"H and matches other Align storage.
- Full front doors are available as metal or laminate. Laminate fronts have grain running vertically.
- 18"D Wardrobes: 42"H and 50"H plinth wardrobes can be freestanding. 18" D footed units must be attached to a panel, worksurface, or ganged to another unit.
- 24"D Wardrobes: 42"H and 50"H plinth and footed wardrobes can be freestanding.
- 65"H wardrobes: 18"D and 24"D wardrobes must be attached to a panel, worksurface, or ganged to another unit.
- To attach wardrobes to a panel, use brackets AP22PBKLN or AP22PBKRH.
- Wardrobes can be used to support a work surface. In order to bracket a work surface to a tower, order bracket model YPWTAWSBKT18 or YPWTAWSBKT24.
- Wardrobes come installed with a rod accessory to accept clothing hanger(s) or a Ralii work tool coat hook can be added. Ralii coat hook is sold separately.
- Wardrobes have slots cut into the inner liner that allow the user to hang Ralii work tool accessories inside the unit. 42"H wardrobes have 2 slots, 50"H and 65"H wardrobes have 4 slots.
- Wardrobes are shipped with one adjustable shelf. 42"H and 50"H wardrobes have 3 shelf locations; 65"H wardrobes have 6 shelf locations.
- Units can be shipped with lock cores removed; cores can then be installed after storage units are placed. Towers can be keyed alike with pedestals, credenzas, laterals, and overhead cabinets.
- Wardrobes are also offered with a digital locking option. Digital lock replaces the pull. For digital lock specification information, see page 24.

[GSA Reference Page](#)

SINGLE LOCKERS

Plinth Base – Flush or Recessed

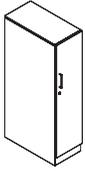

Foot Base – Stride, Terrace, or Pier

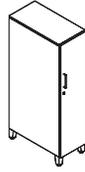

Align lockers provide a comprehensive solution of secure storage outside the primary workstation. Whether you're minimizing the overall workstation footprint or have mobile workers needing a place for their personal belongings, lockers provide the right amount of storage.

Align lockers include single, double, and quad locker variations, as well as an additional cubby solution. Designers have the freedom to select from a variety of aesthetic options including plinth or footed based, painted and laminate fronts, and a variety of pull options, to reflect any company culture.

DOUBLE LOCKERS

Plinth Base – Flush or Recessed

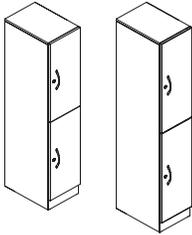

Foot Base – Stride, Terrace, or Pier

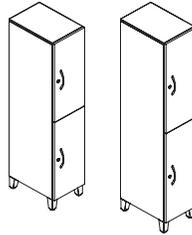

NEW & IMPROVED Align Lockers (pages 80-90)

This specification information is for Align locker models with the new model logic, ordered & produced after March 2020.

Align Lockers (pages 80-90)

- Available in 42½", 50", and 65"H. Available in 18"D.
- Available with Terrace, Stride, or Pier feet. Also available with plinth base, either flush or recessed. Plinth is approximately 3.35"H and matches other Align storage.
- Full front doors are available as metal or laminate. Laminate fronts have grain running vertically and are grain-matched.
- Units can be shipped with lock cores removed; cores can then be installed after storage units are placed. Towers can be keyed alike with pedestals, credenzas, laterals, and overhead cabinets.
- Lockers can be ganged either side-to-side or back-to-back.
- "Double" and "Quad" lockers include two double coat hooks in each compartment.
- 42"H x 12"W and 50"H x 12"W plinth lockers can be freestanding. 65"H x 12"W plinth lockers and all heights of 12"W footed lockers must be attached to a panel, worksurface, or ganged to another unit.

QUAD LOCKERS

Plinth Base – Flush or Recessed

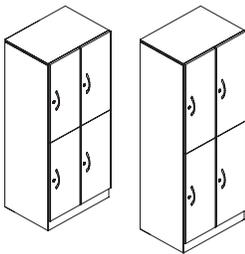

Foot Base – Stride, Terrace, or Pier

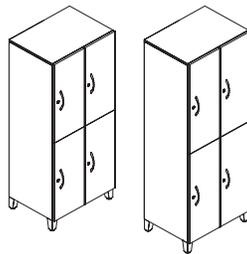

CUBBY LOCKERS

Plinth Base – Flush or Recessed

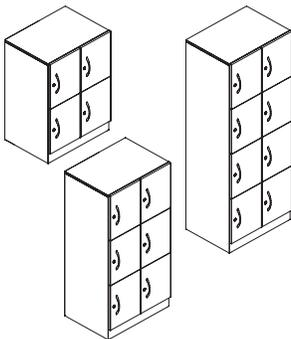

Foot Base – Stride, Terrace, or Pier

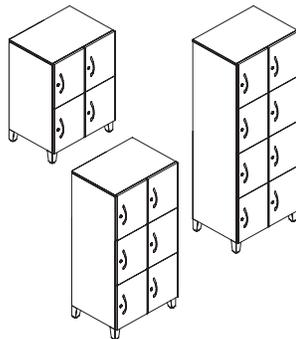

	Description	Model	P1 Paint List Price
	Support Pedestal 28½"H — File/File — Metal Case/Metal Fronts		
	17"D x 15"W*	YPPSP281518FFM	\$ 1162
	23"D x 15"W	YPPSP281524FFM	\$ 1211
	29"D x 15"W	YPPSP281530FFM	\$ 1249
	Support Pedestal 28½"H — Box/Box/File — Metal Case/Metal Fronts		
	17"D x 15"W*	YPPSP281518BBFM	\$ 1162
	23"D x 15"W	YPPSP281524BBFM	\$ 1211
	29"D x 15"W	YPPSP281530BBFM	\$ 1249
	Mobile Pedestal 26½"H — File/File — Metal Case/Metal Fronts		
	17"D x 15"W*	YPPM271518FFM	\$ 1177
	23"D x 15"W	YPPM271524FFM	\$ 1225
	29"D x 15"W	YPPM271530FFM	\$ 1264
	Mobile Pedestal 26½"H — Box/Box/File — Metal Case/Metal Fronts		
	17"D x 15"W*	YPPM271518BBFM	\$ 1177
	23"D x 15"W	YPPM271524BBFM	\$ 1225
	29"D x 15"W	YPPM271530BBFM	\$ 1263
	Mobile Pedestal 20½"H — Box/File — Metal Case/Metal Fronts		
	17"D x 15"W*	YPPM211518BFM	\$ 984
	23"D x 15"W	YPPM211524BFM	\$ 1028
	29"D x 15"W	YPPM211530BFM	\$ 1077

Square Pulls shown

*17"D Pedestals do not accommodate legal size filing.

How to specify — Select the Model Number from above.	1st Option: Base Option (if applicable):	2nd Option: Pull Option:	3rd Option: Pull Color (if applicable):	4th Option: Paint Case:	5th Option: Paint Fronts:	6th Option: Lock:	7th Option: Digital Lock Color (if applicable):
<p>Y P P</p> <p>_____ .</p>	<p>BK Flush Kickplate</p> <p>BX Recessed Kickplate</p> <p>B</p>	<p>A Arch</p> <p>B Bevel</p> <p>M Beam</p> <p>O Halo</p> <p>S Square</p> <p>I Integral</p>	<p>M Beam / O Halo</p> <p>PJW Designer White</p> <p>PR6 Silver</p> <p>PJE Pyrite</p> <p>P8X Solar Black</p> <p>AP Arch</p> <p>PRO Anodized Silver</p> <p>SP Square</p> <p>PJW Designer White</p> <p>EL Matte Silver</p> <p>P02 Flint</p> <p>P7B Loft</p> <p>PJE Pyrite</p> <p>P8X Solar Black</p> <p>P2 upcharge +\$18/pull</p>	<p>P1 P2 P3</p> <p>See page 30 for finishes.</p> <p>P2 upcharge \$23</p> <p>P3 upcharge \$46</p>	<p>NA Match Case</p> <p>P1 \$57</p> <p>P2 \$80</p> <p>P3 \$102</p>	<p>L Standard Lock</p> <p>X Omit Lock Core (Deduct \$20 per lock)</p> <p>E Digital Lock (Add \$422 per lock)</p> <p>See page 25 for specification information.</p>	<p>BNL Brushed Nickel</p>

Example: YPPSP281518FFM.BX.APRO.PJW.NA.L

For specification information see pages 32 and 38-39.

Laminate Fronts with Plinth Base

GSA SIN 33721

	Width	Model	P1 Paint		
			L1	L2	L3
	Support Pedestal 28½"H — File/File — Metal Case/Laminate Fronts				
	17"D x 15"W*	YPPSP281518FFL	\$ 1551	\$ 1610	\$ 1662
	23"D x 15"W	YPPSP281524FFL	\$ 1598	\$ 1672	\$ 1744
	29"D x 15"W	YPPSP281530FFL	\$ 1638	\$ 1713	\$ 1786
	Support Pedestal 28½"H — Box/Box/File — Metal Case/Laminate Fronts				
	17"D x 15"W*	YPPSP281518BBFL	\$ 1618	\$ 1689	\$ 1751
	23"D x 15"W	YPPSP281524BBFL	\$ 1671	\$ 1748	\$ 1821
	29"D x 15"W	YPPSP281530BBFL	\$ 1707	\$ 1785	\$ 1861
	Mobile Pedestal 26½"H — File/File — Metal Case/Laminate Fronts				
	17"D x 15"W*	YPPM271518FFL	\$ 1569	\$ 1643	\$ 1706
	23"D x 15"W	YPPM271524FFL	\$ 1619	\$ 1698	\$ 1775
	29"D x 15"W	YPPM271530FFL	\$ 1658	\$ 1738	\$ 1817
	Mobile Pedestal 26½"H — Box/Box/File — Metal Case/Laminate Fronts				
	17"D x 15"W*	YPPM271518BBFL	\$ 1637	\$ 1714	\$ 1780
	23"D x 15"W	YPPM271524BBFL	\$ 1690	\$ 1772	\$ 1850
	29"D x 15"W	YPPM271530BBFL	\$ 1728	\$ 1811	\$ 1894
	Mobile Pedestal 20½"H — Box/File — Metal Case/Laminate Fronts				
	17"D x 15"W*	YPPM211518BFL	\$ 1335	\$ 1403	\$ 1476
	23"D x 15"W	YPPM211524BFL	\$ 1345	\$ 1415	\$ 1481
	29"D x 15"W	YPPM211530BFL	\$ 1391	\$ 1463	\$ 1534

Square Pulls shown

*17"D Pedestals do not accommodate legal size filing.

METAL STORAGE

How to specify — Select the Model Number from above.	1st Option: Base Option (if applicable):	2nd Option: Pull Option:	3rd Option: Pull Color (if applicable):	4th Option: Paint Case:	5th Option: Laminate Fronts: Laminate & Edge:	6th Option: Lock:	7th Option: Digital Lock Color (if applicable):
Y P P	BX Recessed Kickplate	A Arch M Beam O Halo S Square	M Beam / O Halo P JW Designer White P R6 Silver P JE Pyrite P BX Solar Black AP Arch P R0 Anodized Silver SP Square P JW Designer White EL Matte Silver P O2 Flint P 7B Loft P JE Pyrite P BX Solar Black P2 upcharge +\$18/pull	P1 P2 P3 See page 30 for finishes. P2 upcharge \$23 P3 upcharge \$46	See page 30 for finishes. L2 upcharge \$169 L3 upcharge \$337	L Standard Lock X Omit Lock Core (Deduct \$20 per lock) E Digital Lock (Add \$422 per lock) See page 25 for specification information.	BNL Brushed Nickel
	. BX .		.	P .	.		

Example: YPPSP281518FFL.BK.APR0.PJW.LVT1VT.L

For specification information see pages 32 and 38-39.

Metal Fronts Footed

GSA SIN 33721

	Description	Model	P1 Paint List Price
	Support Pedestal 28½"H — File/File — Metal Case/Metal Fronts		
	17"D x 15"W*	YPPSF281518FFM	\$ 1373
	23"D x 15"W	YPPSF281524FFM	\$ 1418
	29"D x 15"W	YPPSF281530FFM	\$ 1458
	Support Pedestal 28½"H — Box/Box/File — Metal Case/Metal Fronts		
	17"D x 15"W*	YPPSF281518BBFM	\$ 1373
	23"D x 15"W	YPPSF281524BBFM	\$ 1418
	29"D x 15"W	YPPSF281530BBFM	\$ 1458
	Freestanding Pedestal 22"H — Box/File — Metal Case/Metal Fronts		
	17"D x 15"W*	YPPFF221518BFM	\$ 1329
	23"D x 15"W	YPPFF221524BFM	\$ 1379

*17"D Pedestals do not accommodate legal size filing.

How to specify — Select the Model Number from above.	1st Option: Base Option:	2nd Option: Foot Finish:	3rd Option: Pull Option:	4th Option: Pull Color (if applicable):	5th Option: Paint Case:	6th Option: Paint Fronts:	7th Option: Lock:	8th Option: Digital Lock Color (if applicable):
Y P P	TF Terrace Foot ZF Stride Foot (+\$85) PF Pier Foot (+\$130)	Terrace, Stride PR6 Silver Pier PR6 Silver P8X Solar Black PJE Pyrite (+\$91) P02 Flint (+\$91) P7B Loft PJW Designer White	A Arch B Bevel M Beam O Halo S Square I Integral	M Beam / O Halo PJW Designer White PR6 Silver PJE Pyrite P8X Solar Black AP Arch PRO Anodized Silver SP Square PJW Designer White EL Matte Silver P02 Flint P7B Loft PJE Pyrite P8X Solar Black P2 upcharge +\$18/pull	P1 P2 P3 See page 30 for finishes. P2 upcharge \$23 P3 upcharge \$46	NA Match Case P1 \$57 P2 \$80 P3 \$102	L Standard Lock X Omit Lock Core (Deduct \$20 per lock) E Digital Lock (Add \$422 per lock) See page 25 for specification information.	BNL Brushed Nickel
Y P P	F	P R 6 .			P .			

Example: YPPSF281518FFM.TFPR6.APRO.PJW.NA.L

Align™ Metal Storage

Support and Freestanding Pedestals

For specification information see pages 32 and 38-39.

Laminate Fronts Footed

GSA SIN 33721

	Width	Model	P1 Paint		
			L1	L2	L3
	Support Pedestal 28 1/2"H — File/File — Metal Case/Laminate Fronts				
	17"D x 15"W*	YPPSF281518FFL	\$ 1520	\$ 1579	\$ 1631
	23"D x 15"W	YPPSF281524FFL	\$ 1572	\$ 1646	\$ 1708
	29"D x 15"W	YPPSF281530FFL	\$ 1616	\$ 1693	\$ 1757
	Support Pedestal 28 1/2"H — Box/Box/File — Metal Case/Laminate Fronts				
	17"D x 15"W*	YPPSF281518BBFL	\$ 1608	\$ 1667	\$ 1719
	23"D x 15"W	YPPSF281524BBFL	\$ 1664	\$ 1739	\$ 1808
	29"D x 15"W	YPPSF281530BBFL	\$ 1708	\$ 1786	\$ 1855
	Freestanding Pedestal 22"H — Box/File — Metal Case/Laminate Fronts				
	17"D x 15"W*	YPPFF221518BFL	\$ 1788	\$ 1865	\$ 1931
	23"D x 15"W	YPPFF221524BFL	\$ 1815	\$ 1900	\$ 1985

*17"D Pedestals do not accommodate legal size filing.

METAL STORAGE

How to specify — Select the Model Number from above.	1st Option: Base Option:	2nd Option: Foot Finish:	3rd Option: Pull Option:	4th Option: Pull Color (if applicable):	5th Option: Paint Case:	6th Option: Laminate Fronts: Laminate & Edge:	7th Option: Lock:	8th Option: Digital Lock Color (if applicable):
Y P P	TF Terrace Foot ZF Stride Foot (+\$85) PF Pier Foot (+\$130)	Terrace, Stride PR6 Silver Pier PR6 Silver P8X Solar Black PJE Pyrite (+\$91) P02 Flint (+\$91) P7B Loft PJW Designer White	A Arch M Beam O Halo S Square	M Beam / O Halo PJW Designer White PR6 Silver PJE Pyrite P8X Solar Black AP Arch PR0 Anodized Silver SP Square PJW Designer White EL Matte Silver P02 Flint P7B Loft PJE Pyrite P8X Solar Black P2 upcharge +\$18/pull	P1 P2 P3 See page 30 for finishes. P2 upcharge \$23 P3 upcharge \$46	See page 30 for finishes.	L Standard Lock X Omit Lock Core (Deduct \$20 per lock) E Digital Lock (Add \$422 per lock) See page 25 for specification information.	BNL Brushed Nickel
.	F	PR6	.	.	P

Example: YPPSF281518FFL.ZFPR6.APR0.PJW.LVT1VT.L

For specification information see pages 32 and 38-39.

GSA SIN 33721

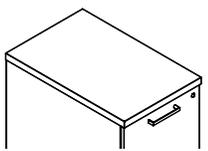

Description	Model	L1 List Price	L2 List Price	L3 List Price
Laminate Top — Flat Edge (for metal pedestal case)				
23½"D	ASPTP-24LL S	\$ 341	\$ 357	\$ 369
29½"D	ASPTP-30LL S	\$ 423	\$ 442	\$ 456

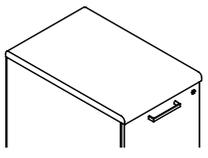

Description	Model	List Price							
		Grade 1	Grade 2	Grade 3	Grade 4	Grade 5	Grade 6	Grade 7	Grade 8
Seat Cushion — For Metal Mobile Pedestals only (specify seating upholstery — no leathers)									
17"D	YPPA1815SC S	\$ 263	\$ 279	\$ 293	\$ 308	\$ 328	\$ 347	\$ 366	\$ 386
23"D	YPPA2415SC S	\$ 314	\$ 330	\$ 344	\$ 359	\$ 379	\$ 398	\$ 417	\$ 437
29"D	YPPA3015SC S	\$ 329	\$ 345	\$ 359	\$ 374	\$ 394	\$ 413	\$ 432	\$ 452

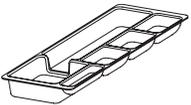

Description	Model	List Price
Box Drawer Accessories		
Pencil Tray (Black only)	A2280-000 S	\$ 50

<p>How to specify — Select the Model Number from above.</p>	<p><i>1st Option:</i> Laminate or Veneer Type and Finish (if applicable): See page 30 for finishes.</p>	<p><i>1st Option:</i> Paint (if applicable): See page 30 for finishes.</p>	<p><i>2nd Option:</i> Edge (if applicable): Laminate Flat Edge Tops only. See page 30 for finishes.</p>	<p><i>Only Option for Seat Cushion:</i> Upholstery: Specify seating upholstery.</p>
<div style="border-bottom: 1px solid black; width: 100%; height: 15px;"></div>	<div style="border-bottom: 1px solid black; width: 100%; height: 15px;"></div>	<div style="border-bottom: 1px solid black; width: 100%; height: 15px;"></div>	<div style="border-bottom: 1px solid black; width: 100%; height: 15px;"></div>	<div style="border-bottom: 1px solid black; width: 100%; height: 15px;"></div>

Examples: ASPTP-24LL.TM20.E2 YPPA2415SC.PNS012 2282-400

S Shippable by small-package carrier.

Align™ Metal Storage

22"H Credenzas

For specification information see pages 32-37 and 40-43.

Metal Fronts with Plinth Base

GSA SIN 33721

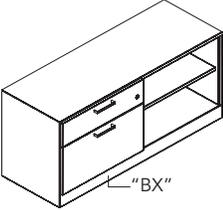
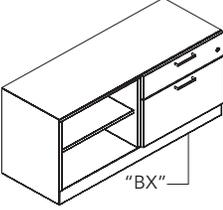
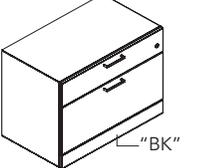
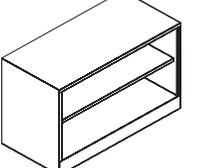
	Description	Model	Recessed Base "BX"	
				P1 Paint
	22"H Box/Lateral and Right Open w/Metal Shelf			
	42"W x 18"D	YPCP224218RBFOM		\$ 3294
	42"W x 24"D	YPCP224224RBFOM		\$ 3508
	48"W x 18"D	YPCP224818RBFOM (shown)		\$ 3405
	48"W x 24"D	YPCP224824RBFOM		\$ 3626
	60"W x 18"D	YPCP226018RBFOM		\$ 3607
	60"W x 24"D	YPCP226024RBFOM		\$ 3841
	72"W x 18"D	YPCP227218RBFOM		\$ 3940
	72"W x 24"D	YPCP227224RBFOM		\$ 4194
	22"H Left Open w/Metal Shelf and Box/Lateral			
	42"W x 18"D	YPCP224218LBFOM		\$ 3294
	42"W x 24"D	YPCP224224LBFOM		\$ 3508
	48"W x 18"D	YPCP224818LBFOM (shown)		\$ 3405
	48"W x 24"D	YPCP224824LBFOM		\$ 3626
	60"W x 18"D	YPCP226018LBFOM		\$ 3607
	60"W x 24"D	YPCP226024LBFOM		\$ 3841
	72"W x 18"D	YPCP227218LBFOM		\$ 3940
	72"W x 24"D	YPCP227224LBFOM		\$ 4194
	22"H Box/Lateral			
	24"W x 18"D	YPCP222418BFM		\$ 2414
	24"W x 24"D	YPCP222424BFM		\$ 2557
	30"W x 18"D	YPCP223018BFM (shown)		\$ 2460
	30"W x 24"D	YPCP223024BFM		\$ 2605
	36"W x 18"D	YPCP223618BFM		\$ 2711
	36"W x 24"D	YPCP223624BFM		\$ 2869
	42"W x 18"D	YPCP224218BFM		\$ 2960
	42"W x 24"D	YPCP224224BFM		\$ 3135
	22"H Open Binder w/Metal Shelf			
	24"W x 17¼"D	YPCP222418O		\$ 1533
	24"W x 23¼"D	YPCP222424O		\$ 1636
	30"W x 17¼"D	YPCP223018O		\$ 1563
	30"W x 23¼"D	YPCP223024O		\$ 1661
	36"W x 17¼"D	YPCP223618O (shown)		\$ 1704
	36"W x 23¼"D	YPCP223624O		\$ 1812
	42"W x 17¼"D	YPCP224218O		\$ 1885
	42"W x 23¼"D	YPCP224224O		\$ 2008

METAL STORAGE

How to specify — Select the Model Number from above.	1st Option: Base Option (if applicable):	2nd Option: Pull Option:	3rd Option: Pull Color (if applicable):	4th Option: Paint Case:	5th Option: Paint Fronts:	6th Option: Paint Shelf:	7th Option: Lock:	8th Option: Digital Lock Color (if applicable):
Y P C	BK Flush BX Kickplate BX Recessed Kickplate	A Arch B Bevel M Beam O Halo S Square I Integral	M Beam / O Halo P JW Designer White P R6 Silver P JE Pyrite P B X Solar Black A P Arch P R O Anodized Silver S P Square P JW Designer White E L Matte Silver P O 2 Flint P 7 B Loft P JE Pyrite P B X Solar Black P 2 upcharge +\$18/pull	P1 P2 P3 See inside front cover for finishes. P2 upcharge \$57 P3 upcharge \$135	NA Match Case P1 \$254 P2 \$332 P3 \$405	Specify "NA" for shelf color to match case color; or specify a different color and add \$0 for P1, \$18 for P2, or \$41 for P3.	L Standard Lock X Omit Lock Core (Deduct \$20 per lock) E Digital Lock (Add \$422 per lock) See page 25 for specification information.	BNL Brushed Nickel
.	B .		.	P .	N A

Example: YPCP224818RBFOM.BX.APR0.PJW.NA.P7B.L

Align™ Metal Storage

22"H Credenzas

For specification information see pages 32-37 and 40-43.

Laminate Fronts with Plinth Base

GSA SIN 33721

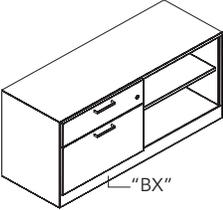

Width	Model	Base List Price L1
22"H Box/Lateral w/Laminate Fronts and Right Open w/Metal Shelf		
42"W x 18"D	YPCP224218BFFOL	\$ 3607
42"W x 24"D	YPCP224224BFFOL	\$ 3841
48"W x 18"D	YPCP224818BFFOL (shown)	\$ 3718
48"W x 24"D	YPCP224824BFFOL	\$ 3959
60"W x 18"D	YPCP226018BFFOL	\$ 3957
60"W x 24"D	YPCP226024BFFOL	\$ 4212
72"W x 18"D	YPCP227218BFFOL	\$ 4364
72"W x 24"D	YPCP227224BFFOL	\$ 4647

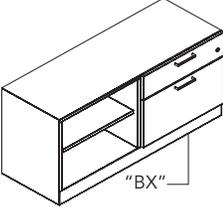

Width	Model	Base List Price L1
22"H Left Open w/Metal Shelf and Box/Lateral w/Laminate Fronts		
42"W x 18"D	YPCP224218LBFOL	\$ 3607
42"W x 24"D	YPCP224224LBFOL	\$ 3841
48"W x 18"D	YPCP224818LBFOL (shown)	\$ 3718
48"W x 24"D	YPCP224824LBFOL	\$ 3959
60"W x 18"D	YPCP226018LBFOL	\$ 3957
60"W x 24"D	YPCP226024LBFOL	\$ 4212
72"W x 18"D	YPCP227218LBFOL	\$ 4364
72"W x 24"D	YPCP227224LBFOL	\$ 4647

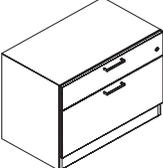

Width	Model	Base List Price L1
22"H Box/Lateral w/Laminate Fronts		
24"W x 18"D	YPCP222418BFL	\$ 2478
24"W x 24"D	YPCP222424BFL	\$ 2635
30"W x 18"D	YPCP223018BFL (shown)	\$ 2560
30"W x 24"D	YPCP223024BFL	\$ 2724
36"W x 18"D	YPCP223618BFL	\$ 2881
36"W x 24"D	YPCP223624BFL	\$ 3066
42"W x 18"D	YPCP224218BFL	\$ 3167
42"W x 24"D	YPCP224224BFL	\$ 3368

How to specify — Select the Model Number from above.	1st Option: Base Option (if applicable): BX Recessed Kickplate	2nd Option: Pull Option: A Arch M Beam O Halo S Square	3rd Option: Pull Color (if applicable): M Beam / O Halo PJW Designer White PR6 Silver PJE Pyrite P8X Solar Black AP Arch PRO Anodized Silver SP Square PJW Designer White EL Matte Silver P02 Flint P7B Loft PJE Pyrite P8X Solar Black P2 upcharge +\$18/pull	4th Option: Paint Case: P1 P2 P3 See page 30 for finishes. P2 upcharge \$57 P3 upcharge \$135	5th Option: Laminate Fronts: Laminate & Edge: See page 30 for finishes. L2 upcharge \$113 L3 upcharge \$225	6th Option: Paint Shelf: Specify "NA" for shelf color to match case color; or specify a different color and add \$0 for P1, \$18 for P2, or \$41 for P3.	7th Option: Lock: L Standard Lock X Omit Lock Core (Deduct \$20 per lock) E Digital Lock (Add \$422 per lock) See page 25 for specification information.	8th Option: Digital Lock Color (if applicable): BNL Brushed Nickel
Y P C	B X .		.	P

Example: YPCP226018LBFOL.BX.APR0.P7B.LVT1VT.P7B.X

5 Shippable by small-package carrier.

Align™ Metal Storage

For specification information see pages 32-37 and 40-43.

22"H Credenzas

Metal Fronts Footed

GSA SIN 33721

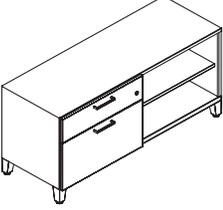
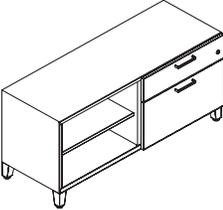
	Description	Model	P1
			Paint List Price
	22"H Box/Lateral and Right Open w/Metal Shelf		
	42"W x 18"D	YPCF224218RBFOM	\$ 3524
	42"W x 24"D	YPCF224224RBFOM	\$ 3754
	48"W x 18"D	YPCF224818RBFOM (shown)	\$ 3634
	48"W x 24"D	YPCF224824RBFOM	\$ 3870
	60"W x 18"D	YPCF226018RBFOM	\$ 3896
	60"W x 24"D	YPCF226024RBFOM	\$ 4146
	72"W x 18"D	YPCF227218RBFOM	\$ 4227
	72"W x 24"D	YPCF227224RBFOM	\$ 4500
	22"H Left Open w/Metal Shelf and Box/Lateral		
	42"W x 18"D	YPCF224218LBFOM	\$ 3524
	42"W x 24"D	YPCF224224LBFOM	\$ 3754
	48"W x 18"D	YPCF224818LBFOM (shown)	\$ 3634
	48"W x 24"D	YPCF224824LBFOM	\$ 3870
	60"W x 18"D	YPCF226018LBFOM	\$ 3896
	60"W x 24"D	YPCF226024LBFOM	\$ 4146
	72"W x 18"D	YPCF227218LBFOM	\$ 4227
	72"W x 24"D	YPCF227224LBFOM	\$ 4500
	22"H Box/Lateral		
	24"W x 18"D	YPCF222418BFM	\$ 2648
	24"W x 24"D	YPCF222424BFM	\$ 2802
	30"W x 18"D	YPCF223018BFM (shown)	\$ 2691
	30"W x 24"D	YPCF223024BFM	\$ 2849
	36"W x 18"D	YPCF223618BFM	\$ 2941
	36"W x 24"D	YPCF223624BFM	\$ 3116
	42"W x 18"D	YPCF224218BFM	\$ 3190
	42"W x 24"D	YPCF224224BFM	\$ 3380
	22"H Open Binder w/Metal Shelf		
	24"W x 17¼"D	YPCF222418O	\$ 1766
	24"W x 23¼"D	YPCF222424O	\$ 1880
	30"W x 17¼"D	YPCF223018O (shown)	\$ 1792
	30"W x 23¼"D	YPCF223024O	\$ 1908
	36"W x 17¼"D	YPCF223618O	\$ 1932
	36"W x 23¼"D	YPCF223624O	\$ 2055
	42"W x 17¼"D	YPCF224218O	\$ 2114
	42"W x 23¼"D	YPCF224224O	\$ 2250

How to specify —

Select the Model Number from above.

Y P C

1st Option:
Base Option:
TF Terrace Foot
ZF Stride Foot (+\$85)
PF Pier Foot (+\$130)

2nd Option:
Foot Finish:
Terrace, Stride
PR6 Silver

Pier
PR6 Silver
P8X Solar Black
PJE Pyrite (+\$91)
P02 Flint (+\$91)
P7B Loft
P JW Designer White

P

3rd Option:
Pull Option:
A Arch
B Bevel
M Beam
O Halo
S Square
I Integral

4th Option:
Pull Color (if applicable):
M Beam / O Halo
P JW Designer White
PR6 Silver
PJE Pyrite
P8X Solar Black
AP Arch
PRO Anodized Silver
P2 upcharge +\$18/pull

SP Square
P JW Designer White
EL Matte Silver
P02 Flint
P7B Loft
PJE Pyrite
P8X Solar Black
P2 upcharge +\$18/pull

Continued below ▼

5th Option:
Paint Case:
P1 P2 P3
See page 30 for finishes.
P2 upcharge \$57
P3 upcharge \$135

P

6th Option:
Paint Fronts:
NA Match Case
P1 \$254
P2 \$332
P3 \$405

NA

7th Option:
Paint Shelf:
Specify "NA" for shelf color to match case color; or specify a different color and add \$0 for P1, \$18 for P2, or \$41 for P3.

8th Option:
Lock:
L Standard Lock
X Omit Lock Core (Deduct \$20 per lock)
E Digital Lock (Add \$422 per lock)
See page 25 for specification information.

9th Option:
Digital Lock Color (if applicable):
BNL Brushed Nickel

Example: YPCF226018LBFOM.TFPR6.APR0.PJW.NA.P7B.L

METAL STORAGE

Align™ Metal Storage

22"H Credenzas

For specification information see pages 32-37 and 40-43.

Laminate Fronts Footed

GSA SIN 33721

Description	Model	Base
		List Price L1
22"H Box/Lateral w/Laminate Fronts and Right Open w/Metal Shelf		
42"W x 18"D	YPCF224218RBFOL	\$ 3839
42"W x 24"D	YPCF224224RBFOL	\$ 4088
48"W x 18"D	YPCF224818RBFOL (shown)	\$ 3950
48"W x 24"D	YPCF224824RBFOL	\$ 4205
60"W x 18"D	YPCF226018RBFOL	\$ 4243
60"W x 24"D	YPCF226024RBFOL	\$ 4517
72"W x 18"D	YPCF227218RBFOL	\$ 4649
72"W x 24"D	YPCF227224RBFOL	\$ 4953

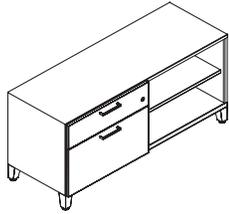

22"H Left Open w/Metal Shelf and Box/Lateral w/Laminate Fronts		
42"W x 18"D	YPCF224218LBFOL	\$ 3839
42"W x 24"D	YPCF224224LBFOL	\$ 4088
48"W x 18"D	YPCF224818LBFOL (shown)	\$ 3950
48"W x 24"D	YPCF224824LBFOL	\$ 4205
60"W x 18"D	YPCF226018LBFOL	\$ 4243
60"W x 24"D	YPCF226024LBFOL	\$ 4517
72"W x 18"D	YPCF227218LBFOL	\$ 4649
72"W x 24"D	YPCF227224LBFOL	\$ 4953

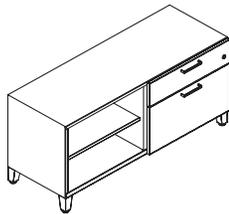

22"H Box/Lateral w/Laminate Fronts		
24"W x 18"D	YPCF222418BFL	\$ 2706
24"W x 24"D	YPCF222424BFL	\$ 2881
30"W x 18"D	YPCF223018BFL (shown)	\$ 2789
30"W x 24"D	YPCF223024BFL	\$ 2972
36"W x 18"D	YPCF223618BFL	\$ 3111
36"W x 24"D	YPCF223624BFL	\$ 3310
42"W x 18"D	YPCF224218BFL	\$ 3395
42"W x 24"D	YPCF224224BFL	\$ 3613



<p>How to specify — Select the Model Number from above.</p> <p>Y P C </p>	<p>1st Option: Base Option: TF Terrace Foot ZF Stride Foot (+\$85) PF Pier Foot (+\$130)</p>	<p>2nd Option: Foot Finish: Terrace, Stride PR6 Silver Pier PR6 Silver P8X Solar Black PJE Pyrite (+\$91) P02 Flint (+\$91) P7B Loft PJW Designer White</p>	<p>3rd Option: Pull Option: A Arch M Beam O Halo S Square</p>	<p>4th Option: Pull Color (if applicable): M Beam / O Halo PJW Designer White PR6 Silver PJE Pyrite P8X Solar Black AP Arch PRO Anodized Silver P2 upcharge +\$18/pull</p>	<p>5th Option: Pull Color (if applicable): SP Square PJW Designer White EL Matte Silver P02 Flint P7B Loft PJE Pyrite P8X Solar Black P2 upcharge +\$18/pull</p>
	<p>_____ .</p>	<p>_____ .</p>	<p>_____ .</p>	<p>_____ .</p>	<p>_____ .</p>

Continued below ▼

<p>6th Option: Paint Case: P1 P2 P3 See page 30 for finishes. P2 upcharge \$57 P3 upcharge \$135</p>	<p>7th Option: Laminate Fronts: Laminate & Edge: See page 30 for finishes. L2 upcharge \$113 L3 upcharge \$225</p>	<p>8th Option: Paint Shelf: Specify "NA" for shelf color to match case color; or specify a different color and add \$0 for P1, \$18 for P2, or \$41 for P3.</p>	<p>9th Option: Digital Lock Color (if applicable): BNL Brushed Nickel</p>
<p>_____ .</p>	<p>_____ .</p>	<p>_____ .</p>	<p>_____ .</p>

Example: YPCF226018LBFOL.TFPR6.APRO.P7B.LVT1VT.P7B.L

Align™ Metal Storage

For specification information see pages 32-37 and 40-43.

22"H Credenzas

Metal Fronts Footed

Open Market

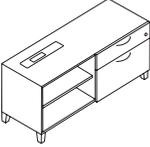
	Description	Model	Base List Price
	Footed, Metal Front Integrated HAT Combo Unit Credenzas		
	22"H x 48" W x 18"D	YPCF224818RBFOMHAT (shown)	\$ 4052
	22"H x 60" W x 18"D	YPCF226018RBFOMHAT	\$ 4325
	22"H x 72" W x 18"D	YPCF227218RBFOMHAT	\$ 4671
	22"H x 48" W x 18"D	YPCF224818LBFOMHAT (shown)	\$ 4052
	22"H x 60" W x 18"D	YPCF226018LBFOMHAT	\$ 4325
	22"H x 72" W x 18"D	YPCF227218LBFOMHAT	\$ 4671
Notes: For use with A6 2-stage C and T bases, 24"D or 30"D. Install Tip: will not accommodate pre-drilled Altitude A6 top locations in captured panel systems setups due to offset position in credenza and will require field location from Credenza leg to bottom of top. Recommended to use vertical fabric wire manager model FBRZPWM to manage cords from worksurface to inside credenza through grommet opening. See page 63.			
	Footed, Metal Front Low Credenza Box / Open Bottom		
	22"H x 24" W x 18"D	YPCF222418BOM (shown)	\$ 2290
	22"H x 30" W x 18"D	YPCF223018BOM	\$ 2326
	22"H x 36" W x 18"D	YPCF223618BOM	\$ 2538
	22"H x 42" W x 18"D	YPCF224218BOM	\$ 2750
	Footed, Metal Front Combo Unit Credenzas w/ Open Shelf		
	22"H x 36" W x 18"D	YPCF223618RBFOM (shown)	\$ 3141
	22"H x 36" W x 18"D	YPCF223618LBFOM	\$ 3141
	Footed, Metal Front Low Credenza Open / File Drawer Bottom		
	22"H x 24" W x 18"D	YPCF222418OFM	\$ 2409
	22"H x 30" W x 18"D	YPCF223018OFM	\$ 2448
	22"H x 36" W x 18"D	YPCF223618OFM	\$ 2672
	22"H x 42" W x 18"D	YPCF224218OFM (shown)	\$ 2897
	Footed, Metal Front, Open/File Drawer Bottom		
	28"H x 30" W x 18"D	YPLF283018OFM	\$ 2057
	28"H x 36" W x 18"D	YPLF283618OFM (shown)	\$ 2226
	28"H x 42" W x 18"D	YPLF284218OFM	\$ 2392

How to specify —
Select the Model Number from above.

1st Option: Base Option:
TF Terrace Foot
ZF Stride Foot (+\$85)
PF Pier Foot (+\$130)

2nd Option: Foot Finish:
Terrace, Stride
PR6 Silver

Pier
PR6 Silver
P8X Solar Black
PJE Pyrite (+\$91)
P02 Flint (+\$91)
P7B Loft
P JW Designer White

3rd Option: Pull Option:
A Arch
B Bevel
M Beam
O Halo
S Square
I Integral

4th Option: Pull Color (if applicable):
M Beam / O Halo
P JW Designer White
PR6 Silver
PJE Pyrite
P8X Solar Black
AP Arch
PR0 Anodized Silver
P2 upcharge +\$18/pull

SP Square
P JW Designer White
EL Matte Silver
P02 Flint
P7B Loft
PJE Pyrite
P8X Solar Black
P2 upcharge +\$18/pull

Model Number Template: Y P C | | | | . | F | P | | | . | | | | .

Continued below ▼

5th Option: Paint Case:
P1 P2 P3
See page 30 for finishes.
P2 upcharge \$57
P3 upcharge \$135

6th Option: Paint Fronts:
NA Match Case
P1 \$254
P2 \$332
P3 \$405

7th Option: Paint Shelf:
Specify "NA" for shelf color to match case color; or specify a different color and add \$0 for P1, \$18 for P2, or \$41 for P3.
Not needed on models ending in OFM

8th Option: Lock:
L Standard Lock
X Omit Lock Core (Deduct \$20 per lock)
E Digital Lock (Add \$422 per lock)
See page 25 for specification information.

9th Option: Digital Lock Color (if applicable):
BNL Brushed Nickel

Model Number Template: P | | | . | | | . | | | | . | | | | . | | | |

Example: YPCF222418OFM.PFPJE.APR0.P27.PJW.PJW.EBNL

METAL STORAGE

	Description	Model	List Price
	Plinth, Metal Front Integrated HAT Combo Unit Credenzas		
	22"H x 48"W x 18"D	YPCP224818RBFOMHAT (shown)	\$ 3812
	22"H x 60"W x 18"D	YPCP226018RBFOMHAT	\$ 4023
	22"H x 72"W x 18"D	YPCP227218RBFOMHAT	\$ 4371
	22"H x 48"W x 18"D	YPCP224818LBFOMHAT (shown)	\$ 3812
	22"H x 60"W x 18"D	YPCP226018LBFOMHAT	\$ 4023
	Plinth, Metal Front Low Credenza Box / Open Bottom		
	22"H x 24"W x 18"D	YPCP222418BOM	\$ 2090
	22"H x 30"W x 18"D	YPCP223018BOM	\$ 2129
	Plinth, Metal Front Low Credenza Open / File Drawer Bottom		
	22"H x 24"W x 18"D	YPCP222418OFM	\$ 2198
	22"H x 30"W x 18"D	YPCP223018OFM	\$ 2239
	Plinth, Metal Front, Open Shelf, File Drawer Bottom Personal File		
	28"H x 30"W x 18"D	YPLP283018OFM	\$ 2023
	28"H x 36"W x 18"D	YPLP283618OFM (shown)	\$ 2214
	Plinth, Metal Front Combo Unit Credenzas w/ Open Shelf		
	22"H x 36"W x 18"D	YPCP223618RBFOM (shown)	\$ 2952
	22"H x 36"W x 18"D	YPCP223618LBFOM	\$ 2952

Notes: For use with A6 2-stage C and T bases, 24"D or 30"D.

Install Tip: will not accommodate pre-drilled Altitude A6 top locations in captured panel systems setups due to offset position in credenza and will require field location from Credenza leg to bottom of top.

Recommended to use vertical fabric wire manager model FBRZPWM to manage cords from worksurface to inside credenza through grommet opening. See page 63.

Plinth, Metal Front Low Credenza Box / Open Bottom

22"H x 24"W x 18"D	YPCP222418BOM	\$ 2090
22"H x 30"W x 18"D	YPCP223018BOM	\$ 2129
22"H x 36"W x 18"D	YPCP223618BOM (shown)	\$ 2342
22"H x 42"W x 18"D	YPCP224218BOM	\$ 2554

Plinth, Metal Front Low Credenza Open / File Drawer Bottom

22"H x 24"W x 18"D	YPCP222418OFM	\$ 2198
22"H x 30"W x 18"D	YPCP223018OFM	\$ 2239
22"H x 36"W x 18"D	YPCP223618OFM	\$ 2466
22"H x 42"W x 18"D	YPCP224218OFM (shown)	\$ 2689

Plinth, Metal Front, Open Shelf, File Drawer Bottom Personal File

28"H x 30"W x 18"D	YPLP283018OFM	\$ 2023
28"H x 36"W x 18"D	YPLP283618OFM (shown)	\$ 2214
28"H x 42"W x 18"D	YPLP284218OFM	\$ 2399

Note: Drawers on these 3 models are letter depth.

Plinth, Metal Front Combo Unit Credenzas w/ Open Shelf

22"H x 36"W x 18"D	YPCP223618RBFOM (shown)	\$ 2952
22"H x 36"W x 18"D	YPCP223618LBFOM	\$ 2952

How to specify — Select the Model Number from above.	1st Option: Base Option (if applicable):	2nd Option: Pull Option:	3rd Option: Pull Color (if applicable):	4th Option: Paint Case:	5th Option: Paint Fronts:	6th Option: Paint Shelf:	7th Option: Lock:	8th Option: Digital Lock Color (if applicable):
Y P C	BK Flush BX Kickplate BX Recessed Kickplate	A Arch B Bevel M Beam O Halo S Square I Integral	M Beam / O Halo PJW Designer White PR6 Silver PJE Pyrite P8X Solar Black AP Arch PRO Anodized Silver SP Square PJW Designer White EL Matte Silver P02 Flint P7B Loft PJE Pyrite P8X Solar Black P2 upcharge +\$18/pull	P1 P2 P3 See inside front cover for finishes. P2 upcharge \$57 P3 upcharge \$135	NA Match Case P1 \$254 P2 \$332 P3 \$405	Specify "NA" for shelf color to match case color; or specify a different color and add \$0 for P1, \$18 for P2, or \$41 for P3. Only needed on model ending in L/RBFOM and L/RBFOMHAT	L Standard Lock X Omit Lock Core (Deduct \$20 per lock) E Digital Lock (Add \$422 per lock) See page 25 for specification information.	BNL Brushed Nickel
.	B .		.	P .	.	.		

Example: YPCP222418BOM.BX.APR0.PJW.NA.P7B.L

		Base List Price L1	
	Description	Model	
	Footed, Laminate Front Integrated HAT Combo Unit Credenzas		
	22"H x 48"W x 18"D	YPCF224818RBFOLHAT (shown)	\$ 4127
	22"H x 60"W x 18"D	YPCF226018RBFOLHAT	\$ 4433
	22"H x 72"W x 18"D	YPCF227218RBFOLHAT	\$ 4858
	22"H x 48"W x 18"D	YPCF224818LBFOLHAT	\$ 4127
	22"H x 60"W x 18"D	YPCF226018LBFOLHAT	\$ 4433
	22"H x 72"W x 18"D	YPCF227218LBFOLHAT (shown)	\$ 4858
	Notes: For use with A6 2-sage C and T bases, 24"D or 30"D. Install Tip: will not accommodate pre-drilled Altitude A6 top locations in captured panel systems setups due to offset position in credenza and will require field location from Credenza leg to bottom of top. Recommended to use vertical fabric wire manager model FBRZPWM to manage cords from worksurface to inside credenza through grommet opening. See page 63.		
Footed, Laminate Front Low Credenza Open / File Drawer Bottom			
22"H x 24"W x 18"D	YPCF222418BOL	\$ 2300	
22"H x 30"W x 18"D	YPCF223018BOL	\$ 2371	
22"H x 36"W x 18"D	YPCF223618BOL (shown)	\$ 2646	
22"H x 42"W x 18"D	YPCF224218BOL	\$ 2887	
Footed, Laminate Front Low Credenza Box / Open Bottom			
22"H x 24"W x 18"D	YPCF222418OFL	\$ 2435	
22"H x 30"W x 18"D	YPCF223018OFL	\$ 2510	
22"H x 36"W x 18"D	YPCF223618OFL (shown)	\$ 2800	
22"H x 42"W x 18"D	YPCF224218OFL	\$ 3057	
Footed, Laminate Front, Open Shelf, File Drawer Bottom Personal File			
28"H x 30"W x 18"D	YPLF283018OFL	\$ 2156	
28"H x 36"W x 18"D	YPLF283618OFL (shown)	\$ 2375	
28"H x 42"W x 18"D	YPLF284218OFL	\$ 2577	
Footed, Laminate Front Combo Unit Credenzas w/ Open Shelf			
22"H x 36"W x 18"D	YPCF223618RBFOL (shown)	\$ 3145	
22"H x 36"W x 18"D	YPCF223618LBFOL	\$ 3145	

METAL STORAGE

How to specify — Select the Model Number from above. Y P .	1st Option: Base Option: TF Terrace Foot ZF Stride Foot (+\$85) PF Pier Foot (+\$130)	2nd Option: Foot Finish: Terrace, Stride PR6 Silver Pier PR6 Silver P8X Solar Black PJE Pyrite (+\$91) P02 Flint (+\$91) P7B Loft PJW Designer White	3rd Option: Pull Option: A Arch M Beam O Halo S Square	4th Option: Pull Color (if applicable): M Beam / O Halo PJW Designer White PR6 Silver PJE Pyrite (+\$34) P8X Solar Black (+\$34) A Arch PR0 Anodized Silver S Square PJW Designer White EL Matte Silver P02 Flint P7B Loft PJE Pyrite (+\$34) P8X Solar Black (+\$34)
	5th Option: Paint Case: P1 P2 P3 See page 30 for finishes. P2 upcharge \$57 P3 upcharge \$135 P .	6th Option: Laminate Fronts: Laminate & Edge: See page 30 for finishes. L2 upcharge \$113 L3 upcharge \$225 .	7th Option: Paint Shelf: Specify "NA" for shelf color to match case color; or specify a different color and add \$0 for P1, \$18 for P2, or \$41 for P3. Only needed on products ending in FOL/FOLHAT .	8th Option: Lock: L Standard Lock X Omit Lock Core (Deduct \$20 per lock) E Digital Lock (Add \$422 per lock) See page 25 for specification information. .

Example: YPLF283018OFL.PFPJE.APR0.P27.P.NA.EBNL

Align™ Metal Storage

Credenzas

For specification information see pages 32-37 and 40-43.

Laminate Fronts with Plinth Base

Open Market

Description	Model	Base List Price L1
Plinth, Laminate Front Integrated HAT Combo Unit Credenzas		
22"H x 48"W x 18"D	YPCP224818RBFOLHAT (shown)	\$ 3886
22"H x 60"W x 18"D	YPCP226018RBFOLHAT	\$ 4136
22"H x 72"W x 18"D	YPCP227218RBFOLHAT	\$ 4560
Plinth, Laminate Front Low Credenza Box / Open Bottom		
22"H x 36"W x 18"D	YPCP223618RBFOL (shown)	\$ 2955
22"H x 36"W x 18"D	YPCP223618LBFOL	\$ 2955
Plinth, Laminate Front Low Credenza Box / Open Bottom		
22"H x 24"W x 18"D	YPCP222418BOL	\$ 2107
22"H x 30"W x 18"D	YPCP223018BOL (shown)	\$ 2176
22"H x 36"W x 18"D	YPCP223618BOL	\$ 2450
22"H x 42"W x 18"D	YPCP224218BOL	\$ 2692
Plinth, Laminate Front Low Credenza Open / File Drawer Bottom		
22"H x 24"W x 18"D	YPCP222418OFL	\$ 2230
22"H x 30"W x 18"D	YPCP223018OFL (shown)	\$ 2304
22"H x 36"W x 18"D	YPCP223618OFL	\$ 2593
22"H x 42"W x 18"D	YPCP224218OFL	\$ 2849
Plinth, Laminate Front, Open Shelf, File Drawer Bottom Personal File		
28"H x 30"W x 18"D	YPLP283018OFL	\$ 1963
28"H x 36"W x 18"D	YPLP283618OFL (shown)	\$ 2181
28"H x 42"W x 18"D	YPLP284218OFL	\$ 2385

Notes: For use with A6 2-stage C and T bases, 24"D or 30"D.

Install Tip: will not accommodate pre-drilled Altitude A6 top locations in captured panel systems setups due to offset position in credenza and will require field location from Credenza leg to bottom of top.

Recommended to use vertical fabric wire manager model FBRZPWM to manage cords from worksurface to inside credenza through grommet opening. See page 63.

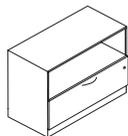
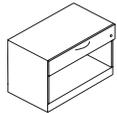
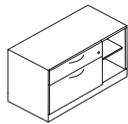
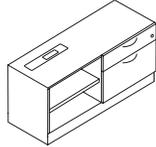
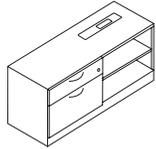

<p>How to specify — Select the Model Number from above.</p> <p>Y P .</p>	<p>1st Option: Base Option (if applicable): BX Recessed Kickplate</p> <p>B X .</p>	<p>2nd Option: Pull Option: A Arch M Beam O Halo S Square</p> <p> .</p>	<p>3rd Option: Pull Color (if applicable): M Beam / O Halo P JW Designer White PR 6 Silver P JE Pyrite (+\$34) P 8X Solar Black (+\$34) A Arch PR O Anodized Silver S Square P JW Designer White EL Matte Silver P O 2 Flint P 7B Loft P JE Pyrite (+\$34) P 8X Solar Black (+\$34)</p> <p> .</p>
---	--	--	--

Continued below ▼

<p>4th Option: Paint Case: P 1 P 2 P 3 See page 30 for finishes. P2 upcharge \$57 P3 upcharge \$135</p> <p>P .</p>	<p>5th Option: Laminate Fronts: Laminate & Edge: See page 30 for finishes. L2 upcharge \$113 L3 upcharge \$225</p> <p> .</p>	<p>6th Option: Paint Shelf: Specify "NA" for shelf color to match case color; or specify a different color and add \$0 for P1, \$18 for P2, or \$41 for P3. Only available on models ending in FOL/FOLHAT</p> <p> .</p>	<p>7th Option: Lock: L Standard Lock X Omit Lock Core (Deduct \$20 per lock) E Digital Lock (Add \$422 per lock) See page 25 for specification information.</p> <p> .</p>	<p>8th Option: Digital Lock Color (if applicable): BNL Brushed Nickel</p> <p> .</p>
--	--	--	--	--

Example: YPCP222418BOL.BXA.PRO.P27.P.NA.EBNL

Align™ Metal Storage

For specification information see pages 32-37 and 40-43.

Open Market

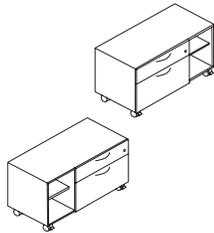
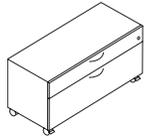
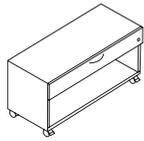

Description	Model	P1 Paint List Price
Mobile, Metal Front Low Credenza Box / Open Bottom		
22"H x 24"W x 18"D	YPCM222418BOM	\$ 2506
22"H x 30"W x 18"D	YPCM223018BOM	\$ 2542
22"H x 36"W x 18"D	YPCM223618BOM	\$ 2754
22"H x 42"W x 18"D	YPCM224218BOM (shown)	\$ 2967
Mobile Laminate Front Low Credenza Box / Open Bottom		
22"H x 24"W x 18"D	YPCM222418OFM	\$ 2744
22"H x 30"W x 18"D	YPCM223018OFM	\$ 2788
22"H x 36"W x 18"D	YPCM223618OFM (shown)	\$ 3020
22"H x 42"W x 18"D	YPCM224218OFM	\$ 3259
Mobile, Metal Front Low Credenza Box/ File Drawer		
22"H x 24"W x 18"D	YPCM222418BFM	\$ 2866
22"H x 30"W x 18"D	YPCM223018BFM	\$ 2911
22"H x 36"W x 18"D	YPCM223618BFM	\$ 3159
22"H x 42"W x 18"D	YPCM224218BFM (shown)	\$ 3410
Mobile, Metal Front Combo Unit Credenzas w/ Open Shelf		
22"H x 36"W x 18"D	YPCM223618RBFOM (shown)	\$ 3239
22"H x 42"W x 18"D	YPCM224218RBFOM	\$ 3507
22"H x 36"W x 18"D	YPCM223618LBFOM (shown)	\$ 3239
22"H x 42"W x 18"D	YPCM224218LBFOM	\$ 3507

METAL STORAGE

How to specify — Select the Model Number from above. Y P C . . H . . .		1st Option: Casters: H Hard Casters	2nd Option: Pull Option: A Arch B Bevel M Beam O Halo S Square I Integral	3rd Option: Pull Color (if applicable): M Beam / O Halo PJW Designer White PR6 Silver PJE Pyrite P8X Solar Black AP Arch PRO Anodized Silver P2 upcharge +\$18/pull	SP Square PJW Designer White EL Matte Silver P02 Flint P7B Loft PJE Pyrite P8X Solar Black P2 upcharge +\$18/pull
4th Option: Paint Case: P1 P2 P3 See page 30 for finishes. P2 upcharge \$57 P3 upcharge \$135	5th Option: Paint Fronts: NA Match Case P1 \$254 P2 \$332 P3 \$405	6th Option: Paint Shelf: Specify "NA" for shelf color to match case color; or specify a different color and add \$0 for P1, \$18 for P2, or \$41 for P3. Only available on options ending in RBFOM/LBFOM	7th Option: Lock: L Standard Lock X Omit Lock Core (Deduct \$20 per lock) E Digital Lock (Add \$422 per lock) See page 25 for specification information.	8th Option: Digital Lock Color (if applicable): BNL Brushed Nickel	

Example: YPCM222418BFM.H.APRO.P27.NA.NA.EBNL

Continued below ▼

Align™ Metal Storage

For specification information see pages 32-37 and 40-43.

22"H Pedestal

Laminate Fronts Mobile

Open Market

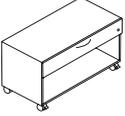
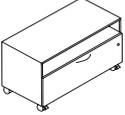
	Description	Model	Base List Price L1
	Mobile Laminate Front Low Credenza Box / Open Bottom		
	22"H x 24"W x 18"D	YPCM222418BOL	\$ 2517
	22"H x 30"W x 18"D	YPCM223018BOL	\$ 2587
	22"H x 36"W x 18"D	YPCM223618BOL (shown)	\$ 2862
	22"H x 42"W x 18"D	YPCM224218BOL	\$ 3103
	Mobile, Laminate Front Low Credenza Open / File Drawer Bottom		
	22"H x 24"W x 18"D	YPCM222418OFL	\$ 2653
	22"H x 30"W x 18"D	YPCM223018OFL	\$ 2729
	22"H x 36"W x 18"D	YPCM223618OFL (shown)	\$ 3018
	22"H x 42"W x 18"D	YPCM224218OFL	\$ 3276
	Mobile, Laminate Front Low Credenza Box / File Drawer		
	22"H x 24"W x 18"D	YPCM222418BFL	\$ 2924
	22"H x 30"W x 18"D	YPCM223018BFL	\$ 3008
	22"H x 36"W x 18"D	YPCM223618BFL (shown)	\$ 3330
	22"H x 42"W x 18"D	YPCM224218BFL	\$ 3616
	Mobile, Laminate Front Combo Unit Credenzas w/ Open Shelf		
	22"H x 36"W x 18"D	YPCM223618BFOFOL (shown)	\$ 3243
	22"H x 42"W x 18"D	YPCM224218BFOFOL	\$ 3534
	22"H x 36"W x 18"D	YPCM223618LBFOL	\$ 3243
	22"H x 42"W x 18"D	YPCM224218LBFOL	\$ 3534

<p>How to specify — Select the Model Number from above.</p> <p>Y P C </p> <p> </p>	<p>1st Option: Casters: H Hard Casters</p>	<p>2nd Option: Pull Option: A Arch M Beam O Halo S Square</p>	<p>3rd Option: Pull Color (if applicable): M Beam / O Halo P JW Designer White PR6 Silver P JE Pyrite P8X Solar Black AP Arch P RO Anodized Silver P2 upcharge +\$18/pull</p>	<p>SP Square P JW Designer White EL Matte Silver P O2 Flint P7B Loft P JE Pyrite P8X Solar Black P2 upcharge +\$18/pull</p>
	<p>4th Option: Paint Case: P1 P2 P3 See page 30 for finishes. P2 upcharge \$57 P3 upcharge \$135</p> <p>P </p>	<p>5th Option: Laminate Fronts: Laminate & Edge: See page 30 for finishes. L2 upcharge \$113 L3 upcharge \$225</p> <p> </p>	<p>6th Option: Paint Shelf: Specify "NA" for shelf color to match case color; or specify a different color and add \$0 for P1, \$18 for P2, or \$41 for P3.</p> <p> </p>	<p>7th Option: Lock: L Standard Lock X Omit Lock Core (Deduct \$20 per lock) E Digital Lock (Add \$422 per lock) See page 25 for specification information.</p> <p> </p>

Example: YPCM222418BFL.H.APR0.P27.P.NA.EBNL

Continued below ▼

Align™ Metal Storage

For specification information see pages 32-37 and 40-43.

Open Market

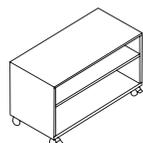

Description	Model	Base List Price P1
Mobile, Open Shelf Credenzas		
22"H x 24"W x 18"D	YPCM222418O	\$ 1982
22"H x 30"W x 18"D	YPCM223018O	\$ 2008
22"H x 36"W x 18"D	YPCM223618O (shown)	\$ 2148
22"H x 42"W x 18"D	YPCM224218O	\$ 2330

<p>How to specify — Select the Model Number from above.</p> <p>Y P C </p> <p> </p>	<p>1st Option: Casters: H Hard Casters</p>	<p>2nd Option: Paint Case: P1 P2 P3 See page 30 for finishes. P2 upcharge \$57 P3 upcharge \$135</p>	<p>3rd Option: Paint Shelf: Specify "NA" for shelf color to match case color; or specify a different color and add \$0 for P1, \$18 for P2, or \$41 for P3.</p>
	<p>Example: YPCM222418O.H.P27.NA</p>		

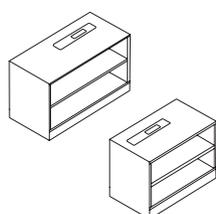

Description	Model	Base List Price P1
Plinth, Integrated HAT Open Shelf Credenzas		
22"H x 30"W x 18"D	YPCP223018ROHAT	\$ 1719
22"H x 36"W x 18"D	YPCP223618ROHAT (shown)	\$ 1875
22"H x 42"W x 18"D	YPCP224218ROHAT	\$ 2073
22"H x 30"W x 18"D	YPCP223018LOHAT (shown)	\$ 1719
22"H x 36"W x 18"D	YPCP223618LOHAT	\$ 1875
22"H x 42"W x 18"D	YPCP224218LOHAT	\$ 2073

<p>How to specify — Select the Model Number from above.</p> <p>Y P C </p> <p> </p>	<p>1st Option: Base Option: BK Flush Plinth BX Recessed Plinth</p>	<p>2nd Option: Paint Case: P1 P2 P3 See page 30 for finishes. P2 upcharge \$57 P3 upcharge \$135</p>	<p>3rd Option: Paint Shelf: Specify "NA" for shelf color to match case color; or specify a different color and add \$0 for P1, \$18 for P2, or \$41 for P3.</p>
	<p>Example: YPCP223018ROHAT.BX.P27.NA</p>		

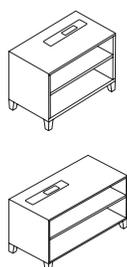

Description	Model	Base List Price P1
Footed, Integrated HAT Open Shelf Credenzas		
22"H x 30"W x 18"D	YPCF223018ROHAT (shown)	\$ 1972
22"H x 36"W x 18"D	YPCF223618ROHAT	\$ 2125
22"H x 42"W x 18"D	YPCF224218ROHAT	\$ 2325
22"H x 36"W x 18"D	YPCF223018LOHAT	\$ 1972
22"H x 36"W x 18"D	YPCF223618LOHAT (shown)	\$ 2125
22"H x 42"W x 18"D	YPCF224218LOHAT	\$ 2325

Notes: For use with A6 2-stage C and T bases, 24"D or 30"D.
Install Tip: will not accommodate pre-drilled Altitude A6 top locations in captured panel systems setups due to offset position in credenza and will require field location from Credenza leg to bottom of top.
 Recommended to use vertical fabric wire manager model FBRZPWM to manage cords from worksurface to inside credenza through grommet opening. See page 63.

<p>How to specify — Select the Model Number from above.</p> <p>Y P C </p> <p> </p>	<p>1st Option: Base Option: TF Terrace Foot ZF Stride Foot (+\$85) PF Pier Foot (+\$130)</p>	<p>2nd Option: Foot Finish: Terrace, Stride PR6 Silver Pier PR6 Silver P8X Solar Black PJE Pyrite (+\$91) P02 Flint (+\$91) P7B Loft PJW Designer White</p>	<p>3rd Option: Paint Case: P1 P2 P3 See page 30 for finishes. P2 upcharge \$57 P3 upcharge \$135</p>	<p>4th Option: Paint Shelf: Specify "NA" for shelf color to match case color; or specify a different color and add \$0 for P1, \$18 for P2, or \$41 for P3.</p>
	<p>Example: YPCF223018ROHAT.PFPJE.P27.NA</p>			

METAL STORAGE

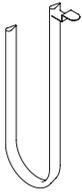

Description	Model	List Price
Fabric Wire Manager (Pack of 2) *Metal Hook attachments available in black only.	FBRZPWM	\$ 361

METAL STORAGE

<p><i>How to specify —</i> Select the Model Number from above.</p>	<p><i>1st Option:</i> Fabric: See page 31 for fabrics.</p>
--	---

F | B | R | Z | P | W | M | .

| | | | | | |

Example: FBRZPWM.DAPR20

For specification information see pages 40-43.

GSA SIN 33721

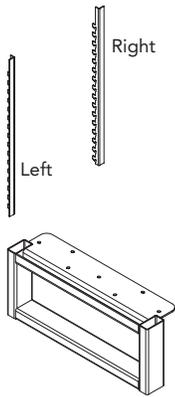

Description	Model	P1 Paint List Price	P2 Paint List Price	P3 Paint List Price
Storage-to-Panel Bracket Kits for 22"H Credenzas				
Left	AP22PBKLH S	\$ 173	\$ 191	\$ 207
Right	AP22PBKRH S	\$ 173	\$ 191	\$ 207
Worksurface Support Stanchions for use with 22"H Align Credenzas				
12"D x 5"H for use on credenza with laminate top	APOLG0512 S	\$ 416	\$ 445	\$ 468
12"D x 6"H for use on credenza without laminate top	APOLG0612 S	\$ 416	\$ 445	\$ 468
18"D x 5"H for use on credenza with laminate top	APOLG0518 S	\$ 453	\$ 482	\$ 505
18"D x 6"H for use on credenza without laminate top	APOLG0618 S	\$ 453	\$ 482	\$ 505

<p>How to specify — Select the Model Number from above.</p>	<p><i>1st Option:</i> Paint (if applicable): P1 P2 P3</p>	<p><i>1st Option:</i> Key Type (if applicable): X Random X□□□ Number Specified SEQ / □□□ Sequential Keying</p>	<p><i>2nd Option:</i> Quantity of Core Lock Kits (if applicable): See page 334 for details.</p>
<p>Examples: AP22PBKLH.P7B YPCAHR12 YPCACW25 ALKF26EL LKFE4MTS.X202.3</p>	<p>S Shippable by small-package carrier.</p>		

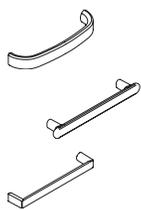

Description	Model	List Price
Pull Packs – Hardware Included		
Align Ped 2 QTY Pull Pack	YPPULL2	\$ 108
Align Ped 3 QTY Pull Pack	YPPULL3	\$ 161
Utilize as retrofit, samples, replacements, etc. Not compatible with Involve Straight Pull Pyrite and Solar Black finish will assume +\$18/per pull upcharge. Ex: YPPULL2.M.P8X +\$36 upcharge		

<p>How to specify — Select the Model Number from above.</p>	<p><i>1st Option:</i> Pull Type (if applicable): M Beam O Halo S Square See matrix on page 21.</p>	<p><i>2nd Option:</i> Pull Color (if applicable): M Beam/O Halo PR6 Silver PJW Designer White PJE Pyrite +\$18/pull upcharge P8X Solar +\$18/pull upcharge S Square EL Matte Silver PJW Designer White P02 Flint P7B Loft PJE Pyrite +\$18/pull upcharge P8X Solar Black +\$18/pull upcharge</p>
<p>Example: YPPULL2.S.PJW</p>	<p>S Shippable by small-package carrier.</p>	

For specification information see pages 40-43.

GSA SIN 33721



Description	Model	List Price
Front-to-Back Filing Bar for Credenzas		
12"D Hangrail Kit for 18"D Credenzas and 18"D Personal Files	YPCAHR12 <input type="checkbox"/>	\$ 32
15"D Hangrail Kit for 24"D Credenzas or 18"D 2H Lateral Files	YPCAHR15 <input type="checkbox"/>	\$ 50

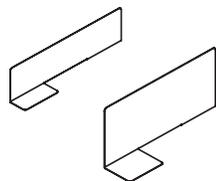

Dividers for Credenzas		
Box Drawer Dividers — 2 pack	YPCABD02 <input type="checkbox"/>	\$ 75
Box Drawer Dividers — 10 pack	YPCABD10 <input type="checkbox"/>	\$ 297
File Drawer Dividers — 2 pack	YPCAFD02 <input type="checkbox"/>	\$ 91
File Drawer Dividers — 10 pack	YPCAFD10 <input type="checkbox"/>	\$ 352

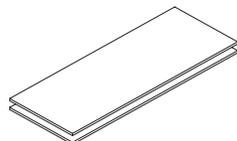

Counterweight Kits for Align 22"H Credenzas w/Drawers		
25 lbs. for 42"W and 48"W Box/Lateral/Open unit	YPCACW25	\$ 342
35 lbs. for 24"W, 60"W, and 72"W Box/Lateral/Open unit	YPCACW35	\$ 457
50 lbs. for 30"W and 36"W Box/Lateral unit	YPCACW50	\$ 508
65 lbs. for 42"W Box/Lateral unit	YPCACW65	\$ 557

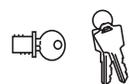

Matte Silver Removable Lock Core Kit	Key Numbers 101E-225E	
Used on Align metal pedestals, credenzas, and towers. Includes one core, two keys, one core removal tool, adapter and instructions.		
	ALKF26EL** <input type="checkbox"/>	\$ 30

**When purchased separately without a configurable TAA compliant end product, not on GSA contract.

Easy Lock Lock-Core — Reference Appendix page 334 for Easy Lock specification details.

Lock Core Kit Matte Silver — 1 core, 2 keys	LKFE1MTS** <input type="checkbox"/>	\$ 30
Lock Core Kit Matte Silver — 2 cores, 2 keys	LKFE2MTS** <input type="checkbox"/>	\$ 61
Lock Core Kit Matte Silver — 3 cores, 2 keys	LKFE3MTS** <input type="checkbox"/>	\$ 91
Lock Core Kit Matte Silver — 4 cores, 2 keys	LKFE4MTS** <input type="checkbox"/>	\$ 121
Lock Core Kit Matte Silver — 5 cores, 2 keys	LKFE5MTS** <input type="checkbox"/>	\$ 151

**When purchased separately without a configurable TAA compliant end product, not on GSA contract.

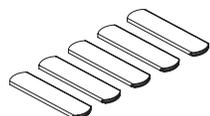

Magnetic Label Holder (5 Pack)		
	ASISLABEL5	\$ 38

<p>How to specify — Select the Model Number from above.</p>	<p><i>1st Option:</i> Paint (if applicable):</p> <p><input type="radio"/> P1 <input type="radio"/> P2 <input type="radio"/> P3</p>	<p><i>1st Option:</i> Key Type (if applicable):</p> <p>X Random X□□□ Number Specified SEQ / □□□ Sequential Keying</p>	<p><i>2nd Option:</i> Quantity of Core Lock Kits (if applicable):</p> <p>See page 334 for details.</p>
	<p>_____ . P _____</p>	<p>_____ .</p>	<p>_____</p>

Examples: AP22PBKLN.P7B YPCAHR12 YPCACW25

ALKF26EL LKFE4MTS.X202.3

Shippable by small-package carrier.

For specification information see pages 40-43.

GSA SIN 33721

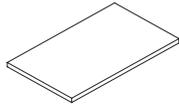

Description	Model	List Price											
		Grade 1	Grade 2	Grade 3	Grade 4	Grade 5	Grade 6	Grade 7	Grade 8	Grade L1	Grade L2		
Credenza Cushions for 18"D Credenzas													
24"W	[S] K5CT1824SC	\$ 408	\$ 438	\$ 467	\$ 497	\$ 536	\$ 575	\$ 614	\$ 653	\$ 632	\$ 792		
30"W	[S] K5CT1830SC	\$ 440	\$ 470	\$ 499	\$ 529	\$ 568	\$ 607	\$ 646	\$ 685	\$ 664	\$ 824		
36"W	K5CT1836SC	\$ 496	\$ 526	\$ 555	\$ 585	\$ 624	\$ 663	\$ 702	\$ 741	\$ 720	\$ 880		
42"W	K5CT1842SC	\$ 494	\$ 524	\$ 553	\$ 583	\$ 622	\$ 661	\$ 700	\$ 739	\$ 718	\$ 878		
48"W	K5CT1848SC	\$ 511	\$ 541	\$ 570	\$ 600	\$ 639	\$ 678	\$ 717	\$ 756	\$ 735	\$ 895		

COM Yardage: 0.7 yards (no vinyls), COL 7 sq.ft.

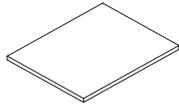

Description	Model	List Price											
		Grade 1	Grade 2	Grade 3	Grade 4	Grade 5	Grade 6	Grade 7	Grade 8	Grade 9	Grade 10	Grade 11	Grade 12
Credenza Cushions for 24"D Credenzas													
24"W	K5CT2424SC	\$ 426	\$ 466	\$ 503	\$ 541	\$ 590	\$ 641	\$ 691	\$ 742	\$ 715	\$ 920		
30"W	K5CT2430SC	\$ 458	\$ 498	\$ 535	\$ 573	\$ 622	\$ 673	\$ 723	\$ 774	\$ 747	\$ 952		
36"W	K5CT2436SC	\$ 496	\$ 536	\$ 573	\$ 611	\$ 660	\$ 711	\$ 761	\$ 812	\$ 785	\$ 990		
48"W	K5CT2448SC	\$ 555	\$ 595	\$ 632	\$ 670	\$ 719	\$ 770	\$ 820	\$ 871	\$ 844	\$ 1049		

COM Yardage: 0.9 yards (no vinyls), COL 8 sq.ft.



ASPT-24SC

Description	Model	List Price											
		Grade 1	Grade 2	Grade 3	Grade 4	Grade 5	Grade 6	Grade 7	Grade 8	Grade 9	Grade 10	Grade 11	Grade 12
Seat Cushion — For Metal Mobile Pedestals only (Specify seating fabric — no leathers)													
23½"D	ASPT-24SC	\$ 309	\$ 325	\$ 339	\$ 354	\$ 374	\$ 393	\$ 412	\$ 432	\$ 452	\$ 470	\$ 491	\$ 510
29½"D	ASPT-30SC	\$ 323	\$ 339	\$ 353	\$ 368	\$ 388	\$ 407	\$ 426	\$ 446	\$ 466	\$ 484	\$ 505	\$ 524

ASPT- cushions have a rounded corner and the YPPA-cushions have a square corner.

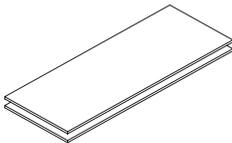

Description	Model	List Price
Counterweight Kits for Align 28"H Lateral and Personal Files		
50 lbs. for 30"W Lateral or Personal File	YPLACW50	\$ 475
57½ lbs. for 36"W Lateral	YPLACW57 [S]	\$ 496
70 lbs. for 42"W Lateral	YPLACW70	\$ 532

METAL STORAGE

<p>How to specify — Select the Model Number from above.</p>	<p><i>1st Option:</i> Upholstery (if applicable): Specify seating upholstery. See Seating, Collaboration, and Tables Price List for available upholstery selection.</p>
--	--

Examples: K5CT1824SC.PNS012

[S] Shippable by small-package carrier.

Align™ Metal Storage

28"H Laterals, Personal Files, and Bookcases

For specification information see pages 33, 37, and 43.

GSA SIN 33721

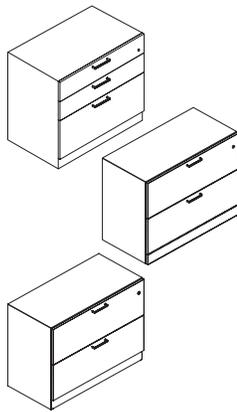

Description	Model	P1 Paint List Price
28"H Metal Case / Metal Fronts		
30"W x 18"D Box/Box/File	YPFCP283018BBFM (shown)	\$ 2222
30"W x 18"D File/File	YPLP283018FFM	\$ 1893
36"W x 18"D File/File	YPLP283618FFM (shown)	\$ 2096
42"W x 18"D File/File	YPLP284218FFM	\$ 2293

Width	Model	Base List Price L1
28"H Metal Case / Laminate Fronts		
30"W x 18"D Box/Box/File	YPFCP283018BBFL	\$ 2710
30"W x 18"D File/File	YPLP283018FFL	\$ 2309
36"W x 18"D File/File	YPLP283618FFL (shown)	\$ 2566
42"W x 18"D File/File	YPLP284218FFL	\$ 2805

Note: Laminate front pull selection is limited to Arch, Square, or Straight pulls.

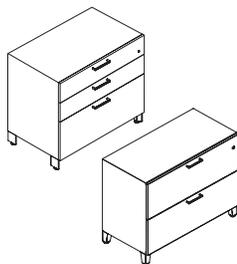

Description	Model	P1 Paint List Price
28"H Metal Case / Metal Fronts / Feet		
30"W x 18"D Box/Box/File	YPFCF283018BBFM (shown)	\$ 2487
30"W x 18"D File/File	YPLF283018FFM	\$ 2120
36"W x 18"D File/File	YPLF283618FFM (shown)	\$ 2319
42"W x 18"D File/File	YPLF284218FFM	\$ 2516

Width	Model	Base List Price L1
28"H Metal Case / Laminate Fronts / Feet		
30"W x 18"D Box/Box/File	YPFCF283018BBFL	\$ 2975
30"W x 18"D File/File	YPLF283018FFL	\$ 2537
36"W x 18"D File/File	YPLF283618FFL (shown)	\$ 2794
42"W x 18"D File/File	YPLF284218FFL	\$ 3031

Note: Laminate front pull selection is limited to Arch, Square, or Straight pulls.

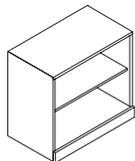

Description	Model	P1 Paint List Price
28"H Bookcase, Metal Case / Plinth		
24"W x 18"D Open Shelf	YPCP282418O	\$ 1413
30"W x 18"D Open Shelf	YPCP283018O	\$ 1532
36"W x 18"D Open Shelf	YPCP283618O	\$ 1671



Description	Model	P1 Paint List Price
28"H Bookcase, Metal Case / Feet		
24"W x 18"D Open Shelf	YPCF282418O	\$ 1640
30"W x 18"D Open Shelf	YPCF283018O	\$ 1760
36"W x 18"D Open Shelf	YPCF283618O	\$ 1896

How to specify —
Select the Model Number from above.

<p>1st Option:</p> <p>Base Option:</p> <p>TF Terrace Foot</p> <p>ZF Stride Foot (+\$85)</p> <p>BK Flush Kickplate</p> <p>BX Recessed Kickplate</p> <p>PF Pier Foot (+\$130)</p>	<p>2nd Option:</p> <p>Foot Finish (if applicable):</p> <p>Terrace, Stride</p> <p>PR6 Silver</p> <p>Pier</p> <p>PR6 Silver</p> <p>P8X Solar Black</p> <p>PJE Pyrite (+\$91)</p> <p>P02 Flint (+\$91)</p> <p>P7B Loft</p> <p>PJW Designer White</p>	<p>3rd Option:</p> <p>Pull Option:</p> <p>A Arch</p> <p>B Bevel</p> <p>M Beam</p> <p>O Halo</p> <p>S Square</p> <p>I Integral</p>	<p>4th Option:</p> <p>Pull Color (if applicable):</p> <p>M Beam / O Halo</p> <p>PJW Designer White</p> <p>PR6 Silver</p> <p>PJE Pyrite</p> <p>P8X Solar Black</p> <p>AP Arch</p> <p>PRO Anodized Silver</p> <p>P2 upcharge +\$18/pull</p> <p>SP Square</p> <p>PJW Designer White</p> <p>EL Matte Silver</p> <p>P02 Flint</p> <p>P7B Loft</p> <p>PJE Pyrite</p> <p>P8X Solar Black</p> <p>P2 upcharge +\$18/pull</p>
---	---	---	---

Y P C | | | | | | | | | . | F | P R 6 | | .

Continued below ▼

<p>5th Option:</p> <p>Paint Case:</p> <p>P1 P2 P3</p> <p>See page 30 for finishes.</p> <p>P2 upcharge \$57</p> <p>P3 upcharge \$135</p> <p>P .</p>	<p>6th Option:</p> <p>Paint Fronts:</p> <p>NA Match Case</p> <p>N1 \$254</p> <p>P2 \$332</p> <p>P3 \$405</p> <p>N A .</p>	<p>7th Option:</p> <p>Laminate Fronts (if applicable):</p> <p>Laminate & Edge:</p> <p>See page 30 for finishes.</p> <p>L2 upcharge \$113</p> <p>L3 upcharge \$225</p> <p> .</p>	<p>8th Option:</p> <p>Paint Shelf:</p> <p>Specify "NA" for shelf color to match case color; or specify a different color and add \$0 for P1, \$18 for P2, or \$41 for P3.</p> <p> .</p>	<p>9th Option:</p> <p>Lock:</p> <p>L Standard Lock</p> <p>X Omit Lock Core (Deduct \$20 per lock)</p> <p>E Digital Lock (Add \$422 per lock) See page 25 for specification information.</p> <p> .</p>	<p>10th Option:</p> <p>Digital Lock Color (if applicable):</p> <p>BNL Brushed Nickel</p> <p> .</p>
--	---	---	--	--	---

Example: YPLP283618FFM.BK.B.P8T.NA.X

Shippable by small-package carrier.

Align™ Metal Storage

Front and Side Access Towers

For specification information see pages 34 and 44-45.

Metal Fronts with Plinth Base

GSA SIN 33721

Description	Model	P1 Paint List Price
42½"H Personal Towers — 24"W x 24"D – Metal Case/Metal Fronts		
Wardrobe Left / Door/File/File	YPTP422424LFFM	\$ 3480
Wardrobe Right / Door/File/File	YPTP422424RFFM	\$ 3480
Wardrobe Left / Door/Box/Box/File	YPTP422424LBBFM	\$ 3792
Wardrobe Right / Door/Box/Box/File (shown)	YPTP422424RBBFM	\$ 3792
50"H Personal Towers — 24"W x 24"D – Metal Case/Metal Fronts		
Wardrobe Left / Door/File/File (shown)	YPTP502424LFFM	\$ 3594
Wardrobe Right / Door/File/File	YPTP502424RFFM	\$ 3594
Wardrobe Left / Door/Box/Box/File	YPTP502424LBBFM	\$ 3902
Wardrobe Right / Door/Box/Box/File	YPTP502424RBBFM	\$ 3902
57½"H Personal Towers — 24"W x 24"D – Metal Case/Metal Fronts		
Wardrobe Left / Door/File/File	YPTP572424LFFM	\$ 3710
Wardrobe Right / Door/File/File (shown)	YPTP572424RFFM	\$ 3710
Wardrobe Left / Door/Box/Box/File	YPTP572424LBBFM	\$ 4020
Wardrobe Right / Door/Box/Box/File	YPTP572424RBBFM	\$ 4020
65"H Personal Towers — 24"W x 24"D – Metal Case/Metal Fronts		
Wardrobe Left / Door/File/File	YPTP652424LFFM	\$ 3831
Wardrobe Right / Door/File/File	YPTP652424RFFM	\$ 3831
Wardrobe Left / Door/Box/Box/File (shown)	YPTP652424LBBFM	\$ 4141
Wardrobe Right / Door/Box/Box/File	YPTP652424RBBFM	\$ 4141
42½"H Side Access Personal Towers — 24"W x 24"D – Metal Case/Metal Fronts		
Wardrobe Left / File/File	YPTSP422424LFFM	\$ 3790
Wardrobe Right / File/File (shown)	YPTSP422424RFFM	\$ 3790
Wardrobe Left / Box/Box/File	YPTSP422424LBBFM	\$ 4098
Wardrobe Right / Box/Box/File	YPTSP422424RBBFM	\$ 4098
50"H Side Access Personal Towers — 24"W x 24"D – Metal Case/Metal Fronts		
Wardrobe Left / File/File	YPTSP502424LFFM	\$ 3912
Wardrobe Right / File/File	YPTSP502424RFFM	\$ 3912
Wardrobe Left / Box/Box/File	YPTSP502424LBBFM	\$ 4221
Wardrobe Right / Box/Box/File (shown)	YPTSP502424RBBFM	\$ 4221
57½"H Side Access Personal Towers — 24"W x 24"D – Metal Case/Metal Fronts		
Wardrobe Left / File/File	YPTSP572424LFFM	\$ 4040
Wardrobe Right / File/File	YPTSP572424RFFM	\$ 4040
Wardrobe Left / Box/Box/File	YPTSP572424LBBFM	\$ 4350
Wardrobe Right / Box/Box/File (shown)	YPTSP572424RBBFM	\$ 4350
65"H Side Access Personal Towers — 24"W x 24"D – Metal Case/Metal Fronts		
Wardrobe Left / File/File	YPTSP652424LFFM	\$ 4174
Wardrobe Right / File/File	YPTSP652424RFFM	\$ 4174
Wardrobe Left / Box/Box/File	YPTSP652424LBBFM	\$ 4483
Wardrobe Right / Box/Box/File (shown)	YPTSP652424RBBFM	\$ 4483

How to specify — Select the Model Number from above.	1st Option: Base Option (if applicable):	2nd Option: Pull Option:	3rd Option: Pull Color (if applicable):	4th Option: Paint Case:	5th Option: Paint Fronts:	6th Option: Markerboard Front:	7th Option: Lock:	8th Option: Digital Lock Color (if applicable):
Y P T	BK Flush BX Kickplate Recessed Kickplate	A Arch B Bevel M Beam O Halo S Square I Integral	M Beam / O Halo PJW Designer White PR6 Silver PJE Pyrite P8X Solar Black AP Arch PRO Anodized Silver SP Square PJW Designer White EL Matte Silver P02 Flint P7B Loft PJE Pyrite P8X Solar Black P2 upcharge +\$18/pull	P1 P2 P3 See inside front cover for finishes. P2 upcharge \$113 P3 upcharge \$225	NA Match Case P1 \$254 P2 \$332 P3 \$405	Offered on front panel of side access models only MKB Yes (+\$113) NA No	L Standard Lock X Omit Lock Core (Deduct \$20 per lock) E Digital Lock (Add \$422 per lock) See page 25 for specification information.	BNL Brushed Nickel
Y P T	B .	.	.	P .	N A

Example: YPTP652424RBBFM.BK.APRO.PJW.NA.L

Shippable by small-package carrier.

For specification information see pages 34 and 44-45.

Laminate Fronts with Plinth Base

GSA SIN 33721

Width	Model	P1 Paint List Price
42½"H Personal Towers — 24"W x 24"D – Metal Case/Laminate Fronts		
Wardrobe Left / Door/File/File	YPTP422424LFFL	\$ 3968
Wardrobe Right / Door/File/File	YPTP422424RFFL	\$ 3968
Wardrobe Left / Door/Box/Box/File	YPTP422424LBBFL	\$ 4351
Wardrobe Right / Door/Box/Box/File (shown)	YPTP422424RBBFL	\$ 4351
50"H Personal Towers — 24"W x 24"D – Metal Case/Laminate Fronts		
Wardrobe Left / Door/File/File (shown)	YPTP502424LFFL	\$ 4106
Wardrobe Right / Door/File/File	YPTP502424RFFL	\$ 4106
Wardrobe Left / Door/Box/Box/File	YPTP502424LBBFL	\$ 4489
Wardrobe Right / Door/Box/Box/File	YPTP502424RBBFL	\$ 4489
57½"H Personal Towers — 24"W x 24"D – Metal Case/Laminate Fronts		
Wardrobe Left / Door/File/File	YPTP572424LFFL	\$ 4251
Wardrobe Right / Door/File/File (shown)	YPTP572424RFFL	\$ 4251
Wardrobe Left / Door/Box/Box/File	YPTP572424LBBFL	\$ 4633
Wardrobe Right / Door/Box/Box/File	YPTP572424RBBFL	\$ 4633
65"H Personal Towers — 24"W x 24"D – Metal Case/Laminate Fronts		
Wardrobe Left / Door/File/File	YPTP652424LFFL	\$ 4401
Wardrobe Right / Door/File/File	YPTP652424RFFL	\$ 4401
Wardrobe Left / Door/Box/Box/File (shown)	YPTP652424LBBFL	\$ 4780
Wardrobe Right / Door/Box/Box/File	YPTP652424RBBFL	\$ 4780
42½"H Side Access Personal Towers — 24"W x 24"D – Metal Case/Laminate Fronts		
Wardrobe Left / File/File	YPTSP422424LFFL	\$ 4348
Wardrobe Right / File/File (shown)	YPTSP422424RFFL	\$ 4348
Wardrobe Left / Box/Box/File	YPTSP422424LBBFL	\$ 4729
Wardrobe Right / Box/Box/File	YPTSP422424RBBFL	\$ 4729
50"H Side Access Personal Towers — 24"W x 24"D – Metal Case/Laminate Fronts		
Wardrobe Left / File/File	YPTSP502424LFFL	\$ 4500
Wardrobe Right / File/File	YPTSP502424RFFL	\$ 4500
Wardrobe Left / Box/Box/File	YPTSP502424LBBFL	\$ 4881
Wardrobe Right / Box/Box/File (shown)	YPTSP502424RBBFL	\$ 4881
57½"H Side Access Personal Towers — 24"W x 24"D – Metal Case/Laminate Fronts		
Wardrobe Left / File/File	YPTSP572424LFFL	\$ 4656
Wardrobe Right / File/File	YPTSP572424RFFL	\$ 4656
Wardrobe Left / Box/Box/File	YPTSP572424LBBFL	\$ 5037
Wardrobe Right / Box/Box/File (shown)	YPTSP572424RBBFL	\$ 5037
65"H Side Access Personal Towers — 24"W x 24"D – Metal Case/Laminate Fronts		
Wardrobe Left / File/File	YPTSP652424LFFL	\$ 4822
Wardrobe Right / File/File	YPTSP652424RFFL	\$ 4822
Wardrobe Left / Box/Box/File	YPTSP652424LBBFL	\$ 5203
Wardrobe Right / Box/Box/File (shown)	YPTSP652424RBBFL	\$ 5203

How to specify — Select the Model Number from above. Y P I T 	1st Option: Base Option (if applicable): BX Recessed Kickplate	2nd Option: Pull Option: A Arch M Beam O Halo S Square	3rd Option: Pull Color (if applicable): M Beam / O Halo PJW Designer White PR6 Silver PJE Pyrite P8X Solar Black AP Arch PRO Anodized Silver SP Square PJW Designer White EL Matte Silver P02 Flint P7B Loft PJE Pyrite P8X Solar Black P2 upcharge +\$18/pull	4th Option: Paint Case: P1 P2 P3 See page 30 for finishes. P2 upcharge \$113 P3 upcharge \$225	5th Option: Laminate Fronts: Laminate & Edge: See page 30 for finishes. L2 upcharge \$169 L3 upcharge \$337	6th Option: Lock: L Standard Lock X Omit Lock Core (Deduct \$20 per lock) E Digital Lock (Add \$422 per lock) See page 25 for specification information.	7th Option: Digital Lock Color (if applicable): BNL Brushed Nickel
	 	BX .			P		

Example: YPTP652424RBBFL.BK.APR0.PJW.LVT1VT.L

Align™ Metal Storage

Front Access Towers

For specification information see pages 34 and 44-45.

Metal Fronts Footed

GSA SIN 33721

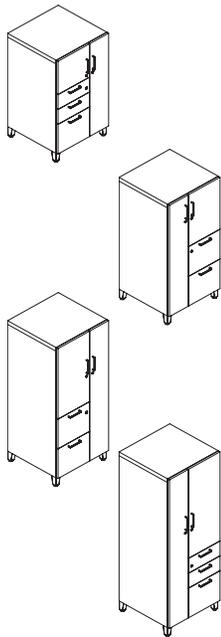

Description	Model	P1 Paint List Price
42½"H Personal Towers — 24"W x 24"D – Metal Case/Metal Fronts		
Wardrobe Left / Door/File/File	YPTF422424LFFM	\$ 3750
Wardrobe Right / Door/File/File	YPTF422424RFFM	\$ 3750
Wardrobe Left / Door/Box/Box/File	YPTF422424LBBFM	\$ 4060
Wardrobe Right / Door/Box/Box/File (shown)	YPTF422424RBBFM	\$ 4060
50"H Personal Towers — 24"W x 24"D – Metal Case/Metal Fronts		
Wardrobe Left / Door/File/File (shown)	YPTF502424LFFM	\$ 3863
Wardrobe Right / Door/File/File	YPTF502424RFFM	\$ 3863
Wardrobe Left / Door/Box/Box/File	YPTF502424LBBFM	\$ 4174
Wardrobe Right / Door/Box/Box/File	YPTF502424RBBFM	\$ 4174
57½"H Personal Towers — 24"W x 24"D – Metal Case/Metal Fronts		
Wardrobe Left / Door/File/File	YPTF572424LFFM	\$ 3981
Wardrobe Right / Door/File/File (shown)	YPTF572424RFFM	\$ 3981
Wardrobe Left / Door/Box/Box/File	YPTF572424LBBFM	\$ 4290
Wardrobe Right / Door/Box/Box/File	YPTF572424RBBFM	\$ 4290
65"H Personal Towers — 24"W x 24"D – Metal Case/Metal Fronts		
Wardrobe Left / Door/File/File	YPTF652424LFFM	\$ 4102
Wardrobe Right / Door/File/File	YPTF652424RFFM	\$ 4102
Wardrobe Left / Door/Box/Box/File (shown)	YPTF652424LBBFM	\$ 4413
Wardrobe Right / Door/Box/Box/File	YPTF652424RBBFM	\$ 4413

METAL STORAGE

<p>How to specify — Select the Model Number from above.</p> <p>Y P T F</p>	<p>1st Option: Base Option: TF Terrace Foot ZF Stride Foot (+\$85) PF Pier Foot (+\$130)</p>	<p>2nd Option: Foot Finish: Terrace, Stride PR6 Silver Pier PR6 Silver P8X Solar Black PJE Pyrite (+\$91) P02 Flint (+\$91) P7B Loft P JW Designer White</p>	<p>3rd Option: Pull Option: A Arch B Bevel M Beam O Halo S Square I Integral</p>	<p>4th Option: Pull Color (if applicable): M Beam / O Halo P JW Designer White PR6 Silver PJE Pyrite P8X Solar Black AP Arch PRO Anodized Silver P2 upcharge +\$18/pull SP Square P JW Designer White EL Matte Silver P02 Flint P7B Loft PJE Pyrite P8X Solar Black P2 upcharge +\$18/pull</p>
	<p>_____ .</p>	<p>_____ F _____</p>	<p>_____ P R 6 _____</p>	<p>_____ .</p>

Continued below ▼

<p>5th Option: Paint Case: P1 P2 P3 See inside front cover for finishes. P2 upcharge \$113 P3 upcharge \$225</p>	<p>6th Option: Paint Fronts: NA Match Case P1 \$254 P2 \$332 P3 \$405</p>	<p>7th Option: Markerboard Front: Offered on front panel of side access models only MKB Yes (+\$113) NA No</p>	<p>8th Option: Lock: L Standard Lock X Omit Lock Core (Deduct \$20 per lock) E Digital Lock (Add \$422 per lock) See page 25 for specification information.</p>	<p>9th Option: Digital Lock Color (if applicable): BNL Brushed Nickel</p>
<p>P _____ .</p>	<p>NA _____</p>	<p>_____ .</p>	<p>_____ .</p>	<p>_____ .</p>

Example: YPTF652424RBBFM.TFPR6.APRO.P JW.NA.X

Align™ Metal Storage

Side Access Towers

For specification information see pages 34 and 44-45.

Metal Fronts Footed

GSA SIN 33721

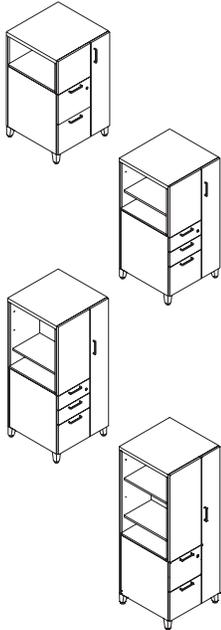

Description	Model	P1 Paint List Price
42½"H Side Access Personal Towers — 24"W x 24"D – Metal Case/Metal Fronts		
Wardrobe Left / File/File	YPTSF422424LFFM	\$ 4059
Wardrobe Right / File/File (shown)	YPTSF422424RFFM	\$ 4059
Wardrobe Left / Box/Box/File	YPTSF422424LBBFM	\$ 4369
Wardrobe Right / Box/Box/File	YPTSF422424RBBFM	\$ 4369
50"H Side Access Personal Towers — 24"W x 24"D – Metal Case/Metal Fronts		
Wardrobe Left / File/File	YPTSF502424LFFM	\$ 4182
Wardrobe Right / File/File	YPTSF502424RFFM	\$ 4182
Wardrobe Left / Box/Box/File	YPTSF502424LBBFM	\$ 4492
Wardrobe Right / Box/Box/File (shown)	YPTSF502424RBBFM	\$ 4492
57½"H Side Access Personal Towers — 24"W x 24"D – Metal Case/Metal Fronts		
Wardrobe Left / File/File	YPTSF572424LFFM	\$ 4310
Wardrobe Right / File/File	YPTSF572424RFFM	\$ 4310
Wardrobe Left / Box/Box/File	YPTSF572424LBBFM	\$ 4621
Wardrobe Right / Box/Box/File (shown)	YPTSF572424RBBFM	\$ 4621
65"H Side Access Personal Towers — 24"W x 24"D – Metal Case/Metal Fronts		
Wardrobe Left / File/File	YPTSF652424LFFM	\$ 4446
Wardrobe Right / File/File (shown)	YPTSF652424RFFM	\$ 4446
Wardrobe Left / Box/Box/File	YPTSF652424LBBFM	\$ 4756
Wardrobe Right / Box/Box/File	YPTSF652424RBBFM	\$ 4756

<p>How to specify — Select the Model Number from above.</p> <p>Y P T S </p>	<p>1st Option: Base Option: TF Terrace Foot ZF Stride Foot (+\$85) PF Pier Foot (+\$130)</p>	<p>2nd Option: Foot Finish: Terrace, Stride PR6 Silver Pier PR6 Silver P8X Solar Black PJE Pyrite (+\$91) P02 Flint (+\$91) P7B Loft PJW Designer White</p>	<p>3rd Option: Pull Option: A Arch B Bevel M Beam O Halo S Square I Integral</p>	<p>4th Option: Pull Color (if applicable): M Beam / O Halo PJW Designer White PR6 Silver PJE Pyrite P8X Solar Black AP Arch PRO Anodized Silver P2 upcharge +\$18/pull</p>	<p>5th Option: SP Square PJW Designer White EL Matte Silver P02 Flint P7B Loft PJE Pyrite P8X Solar Black P2 upcharge +\$18/pull</p>
	<p>_____ .</p>	<p>_____ F _____ .</p>	<p>_____ P R 6 _____ .</p>	<p>_____ _____ .</p>	<p>_____ _____ .</p>

Continued below ▼

<p>5th Option: Paint Case: P1 P2 P3 See inside front cover for finishes. P2 upcharge \$113 P3 upcharge \$225</p>	<p>6th Option: Paint Fronts: NA Match Case P1 \$254 P2 \$332 P3 \$405</p>	<p>7th Option: Markerboard Front: Offered on front panel of side access models only MKB Yes (+\$113) NA No</p>	<p>8th Option: Lock: L Standard Lock X Omit Lock Core (Deduct \$20 per lock) E Digital Lock (Add \$422 per lock) See page 25 for specification information.</p>	<p>9th Option: Digital Lock Color (if applicable): BNL Brushed Nickel</p>
<p>P _____ .</p>	<p>NA _____ .</p>	<p>_____ _____ .</p>	<p>_____ _____ .</p>	<p>_____ _____ .</p>

Example: YPTS652424RBBFM.TFPR6.APRO.PJW.NA.X

Align™ Metal Storage

For specification information see pages 34 and 44-45.

Front Access Towers

Laminate Fronts Footed

GSA SIN 33721

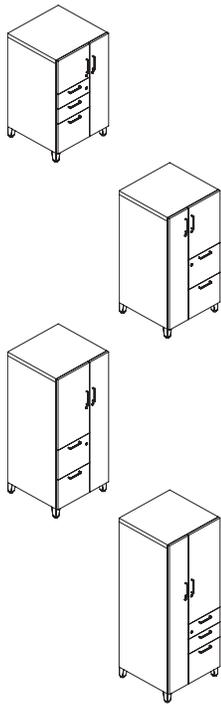

Width	Model	P1 Paint List Price
42½"H Personal Towers — 24"W x 24"D – Metal Case/Laminate Fronts		
Wardrobe Left / Door/File/File	YPTF422424LFFL	\$ 4240
Wardrobe Right / Door/File/File	YPTF422424RFFL	\$ 4240
Wardrobe Left / Door/Box/Box/File	YPTF422424LBBFL	\$ 4621
Wardrobe Right / Door/Box/Box/File (shown)	YPTF422424RBBFL	\$ 4621
50"H Personal Towers — 24"W x 24"D – Metal Case/Laminate Fronts		
Wardrobe Left / Door/File/File (shown)	YPTF502424LFFL	\$ 4377
Wardrobe Right / Door/File/File	YPTF502424RFFL	\$ 4377
Wardrobe Left / Door/Box/Box/File	YPTF502424LBBFL	\$ 4758
Wardrobe Right / Door/Box/Box/File	YPTF502424RBBFL	\$ 4758
57½"H Personal Towers — 24"W x 24"D – Metal Case/Laminate Fronts		
Wardrobe Left / Door/File/File	YPTF572424LFFL	\$ 4524
Wardrobe Right / Door/File/File (shown)	YPTF572424RFFL	\$ 4524
Wardrobe Left / Door/Box/Box/File	YPTF572424LBBFL	\$ 4903
Wardrobe Right / Door/Box/Box/File	YPTF572424RBBFL	\$ 4903
65"H Personal Towers — 24"W x 24"D – Metal Case/Laminate Fronts		
Wardrobe Left / Door/File/File	YPTF652424LFFL	\$ 4669
Wardrobe Right / Door/File/File	YPTF652424RFFL	\$ 4669
Wardrobe Left / Door/Box/Box/File (shown)	YPTF652424LBBFL	\$ 5054
Wardrobe Right / Door/Box/Box/File	YPTF652424RBBFL	\$ 5054

METAL STORAGE

How to specify — Select the Model Number from above.	1st Option: Base Option:	2nd Option: Foot Finish:	3rd Option: Pull Option:	4th Option: Pull Color (if applicable):	5th Option: Paint Case:	6th Option: Laminate Fronts: Laminate & Edge:	7th Option: Lock:	8th Option: Digital Lock Color (if applicable):
Y P T F	TF Terrace Foot ZF Stride Foot (+\$85) PF Pier Foot (+\$130)	PR6 Silver Pier PR6 Silver P8X Solar Black PJE Pyrite (+\$91) P02 Flint (+\$91) P7B Loft PJW Designer White	A Arch M Beam O Halo S Square	M Beam / O Halo PJW Designer White PR6 Silver PJE Pyrite P8X Solar Black AP Arch PRO Anodized Silver SP Square PJW Designer White EL Matte Silver P02 Flint P7B Loft PJE Pyrite P8X Solar Black P2 upcharge +\$18/pull	P1 P2 P3 See page 30 for finishes. P2 upcharge \$113 P3 upcharge \$225	L2 upcharge \$169 L3 upcharge \$337	L Standard Lock X Omit Lock Core (Deduct \$20 per lock) E Digital Lock (Add \$422 per lock) See page 25 for specification information.	BNL Brushed Nickel
_____ .	F	PR6	_____ .	_____ .	P	_____ .	_____ .	_____ .

Example: YPTF652424RBBFL.ZFPR6.APRO.PJW.LVT1VT.L

Align™ Metal Storage

For specification information see pages 34 and 44-45.

Side Access Towers

Laminate Fronts Footed

GSA SIN 33721

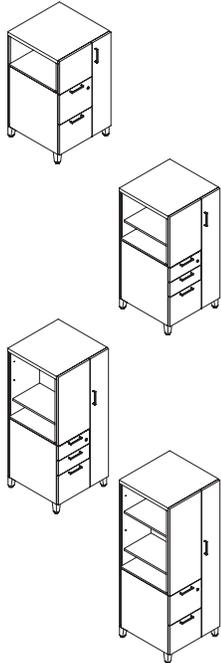

Width	Model	P1 Paint List Price
42½"H Side Access Personal Towers — 24"W x 24"D – Metal Case/Laminate Fronts		
Wardrobe Left / File/File	YPTSF422424LFFL	\$ 4619
Wardrobe Right / File/File (shown)	YPTSF422424RFFL	\$ 4619
Wardrobe Left / Box/Box/File	YPTSF422424LBBFL	\$ 5002
Wardrobe Right / Box/Box/File	YPTSF422424RBBFL	\$ 5002
50"H Side Access Personal Towers — 24"W x 24"D – Metal Case/Laminate Fronts		
Wardrobe Left / File/File	YPTSF502424LFFL	\$ 4770
Wardrobe Right / File/File	YPTSF502424RFFL	\$ 4770
Wardrobe Left / Box/Box/File	YPTSF502424LBBFL	\$ 5152
Wardrobe Right / Box/Box/File (shown)	YPTSF502424RBBFL	\$ 5152
57½"H Side Access Personal Towers — 24"W x 24"D – Metal Case/Laminate Fronts		
Wardrobe Left / File/File	YPTSF572424LFFL	\$ 4928
Wardrobe Right / File/File	YPTSF572424RFFL	\$ 4928
Wardrobe Left / Box/Box/File	YPTSF572424LBBFL	\$ 5309
Wardrobe Right / Box/Box/File (shown)	YPTSF572424RBBFL	\$ 5309
65"H Side Access Personal Towers — 24"W x 24"D – Metal Case/Laminate Fronts		
Wardrobe Left / File/File	YPTSF652424LFFL	\$ 5093
Wardrobe Right / File/File (shown)	YPTSF652424RFFL	\$ 5093
Wardrobe Left / Box/Box/File	YPTSF652424LBBFL	\$ 5472
Wardrobe Right / Box/Box/File	YPTSF652424RBBFL	\$ 5472

How to specify — Select the Model Number from above.	1st Option: Base Option:	2nd Option: Foot Finish: Terrace, Stride PR6 Silver Pier PR6 Silver P8X Solar Black PJE Pyrite (+\$91) P02 Flint (+\$91) P7B Loft PJW Designer White	3rd Option: Pull Option: A Arch M Beam O Halo S Square	4th Option: Pull Color (if applicable): M Beam / O Halo PJW Designer White PR6 Silver PJE Pyrite P8X Solar Black AP Arch PRO Anodized Silver SP Square PJW Designer White EL Matte Silver P02 Flint P7B Loft PJE Pyrite P8X Solar Black P2 upcharge +\$18/pull	5th Option: Paint Case: P1 P2 P3 See page 30 for finishes. P2 upcharge \$113 P3 upcharge \$225	6th Option: Laminate Fronts: Laminate & Edge: See page 30 for finishes. L2 upcharge \$169 L3 upcharge \$337	7th Option: Lock: L Standard Lock X Omit Lock Core (Deduct \$20 per lock) E Digital Lock (Add \$422 per lock) See page 25 for specification information.	8th Option: Digital Lock Color (if applicable): BNL Brushed Nickel
Y P T S	F	P R 6	.	.	P	.	.	.

Example: YPTSF652424RBBFL.ZFPR6.APRO.PJW.LVT1VT.L

Align™ Metal Storage

18"W Front and Side Access Towers

For specification information see pages 34 and 44-45.

Metal Fronts with Plinth Base

GSA SIN 33721

	Description	Model	P1 Paint List Price
	42½"H Personal Tower — 18"W x 24"D – Metal Case/Metal Fronts		
	Wardrobe Left / Door/File/File (shown)	YPTP421824LFFM	\$ 3222
	Wardrobe Right / Door/File/File	YPTP421824RFFM	\$ 3222
	50"H Personal Tower — 18"W x 24"D – Metal Case/Metal Fronts		
	Wardrobe Left / Door/File/File	YPTP501824LFFM	\$ 3325
	Wardrobe Right / Door/File/File	YPTP501824RFFM	\$ 3325
	57½"H Personal Tower — 18"W x 24"D – Metal Case/Metal Fronts		
	Wardrobe Left / Door/File/File (shown)	YPTP571824LFFM	\$ 3433
	Wardrobe Right / Door/File/File (shown)	YPTP571824RFFM	\$ 3433
	65"H Personal Tower — 18"W x 24"D – Metal Case/Metal Fronts		
	Wardrobe Left / Door/File/File	YPTP651824LFFM	\$ 3541
	Wardrobe Right / Door/File/File (shown)	YPTP651824RFFM	\$ 3541
	42½"H Side Access Tower — 18"W x 24"D – Metal Case/Metal Fronts		
	Wardrobe Left / Door/File/File	YPTSP421824LFFM	\$ 3505
	Wardrobe Right / Door/File/File (shown)	YPTSP421824RFFM	\$ 3505
	50"H Side Access Tower — 18"W x 24"D – Metal Case/Metal Fronts		
	Wardrobe Left / Door/File/File	YPTSP501824LFFM	\$ 3618
	Wardrobe Right / Door/File/File (shown)	YPTSP501824RFFM	\$ 3618
	57½"H Side Access Tower — 18"W x 24"D – Metal Case/Metal Fronts		
	Wardrobe Left / Door/File/File	YPTSP571824LFFM	\$ 3736
	Wardrobe Right / Door/File/File (shown)	YPTSP571824RFFM	\$ 3736
	65"H Side Access Tower — 18"W x 24"D – Metal Case/Metal Fronts		
	Wardrobe Left / Door/File/File	YPTSP651824LFFM	\$ 3859
	Wardrobe Right / Door/File/File (shown)	YPTSP651824RFFM	\$ 3859

METAL STORAGE

How to specify	1st Option:	2nd Option:	3rd Option:	4th Option:	5th Option:	6th Option:	7th Option:	8th Option:
Select the Model Number from above.	Base Option (if applicable):	Pull Option:	Pull Color (if applicable):	Paint Case:	Paint Fronts:	Markerboard Front:	Lock:	Digital Lock Color (if applicable):
	BK Flush Kickplate BX Recessed Kickplate	A Arch B Bevel M Beam O Halo S Square	M Beam / O Halo PJW Designer White PR6 Silver PJE Pyrite P8X Solar Black AP Arch PRO Anodized Silver SP Square PJW Designer White EL Matte Silver P02 Flint P7B Loft PJE Pyrite P8X Solar Black P2 upcharge +\$18/pull	P1 P2 P3 See inside front cover for finishes. P2 upcharge \$113 P3 upcharge \$225	NA Match Case P1 \$254 P2 \$332 P3 \$405	Offered on front panel of side access models only MKB Yes (+\$113) NA No	L Standard Lock X Omit Lock Core (Deduct \$20 per lock) E Digital Lock (Add \$422 per lock) See page 25 for specification information.	BNL Brushed Nickel
Y P T	B			P	NA			

Example: YPTP651824RFFM.BK.APRO.PJW.NA.L

Align™ Metal Storage

18"W Front and Side Access Towers

For specification information see pages 34 and 44-45.

Laminate Fronts with Plinth Base

GSA SIN 33721

		P1 Paint List Price
Description	Model	
42½"H Personal Tower — 18"W x 24"D — Metal Case/Laminate Fronts		
Wardrobe Left / Door/File/File (shown)	YPTP421824LFFL	\$ 3649
Wardrobe Right / Door/File/File	YPTP421824RFFL	\$ 3649
50"H Personal Tower — 18"W x 24"D — Metal Case/Laminate Fronts		
Wardrobe Left / Door/File/File	YPTP501824LFFL	\$ 3778
Wardrobe Right / Door/File/File	YPTP501824RFFL	\$ 3778
57½"H Personal Tower — 18"W x 24"D — Metal Case/Laminate Fronts		
Wardrobe Left / Door/File/File (shown)	YPTP571824LFFL	\$ 3909
Wardrobe Right / Door/File/File (shown)	YPTP571824RFFL	\$ 3909
65"H Personal Tower — 18"W x 24"D — Metal Case/Laminate Fronts		
Wardrobe Left / Door/File/File	YPTP651824LFFL	\$ 4047
Wardrobe Right / Door/File/File (shown)	YPTP651824RFFL	\$ 4047
42½"H Side Access Tower — 18"W x 24"D — Metal Case/Laminate Fronts		
Wardrobe Left / Door/File/File	YPTSP421824LFFL	\$ 3997
Wardrobe Right / Door/File/File (shown)	YPTSP421824RFFL	\$ 3997
50"H Side Access Tower — 18"W x 24"D — Metal Case/Laminate Fronts		
Wardrobe Left / Door/File/File	YPTSP501824LFFL	\$ 4138
Wardrobe Right / Door/File/File (shown)	YPTSP501824RFFL	\$ 4138
57½"H Side Access Tower — 18"W x 24"D — Metal Case/Laminate Fronts		
Wardrobe Left / Door/File/File	YPTSP571824LFFL	\$ 4282
Wardrobe Right / Door/File/File (shown)	YPTSP571824RFFL	\$ 4282
65"H Side Access Tower — 18"W x 24"D — Metal Case/Laminate Fronts		
Wardrobe Left / Door/File/File	YPTSP651824LFFL	\$ 4434
Wardrobe Right / Door/File/File (shown)	YPTSP651824RFFL	\$ 4434

How to specify — Select the Model Number from above.	1st Option:	2nd Option:	3rd Option:	4th Option:	5th Option:	6th Option:	7th Option:
	Base Option (if applicable): BK Flush Kickplate BX Recessed Kickplate	Pull Option: A Arch M Beam O Halo S Square	Pull Color (if applicable): M Beam / O Halo PJW Designer White PR6 Silver PJE Pyrite P8X Solar Black AP Arch PRO Anodized Silver SP Square PJW Designer White EL Matte Silver P02 Flint P7B Loft PJE Pyrite P8X Solar Black P2 upcharge +\$18/pull	Paint Case: P1 P2 P3 See page 30 for finishes. P2 upcharge \$113 P3 upcharge \$225	Laminate Fronts: Laminate & Edge: See page 30 for finishes. L2 upcharge \$169 L3 upcharge \$337	Lock: L Standard Lock X Omit Lock Core (Deduct \$20 per lock) E Digital Lock (Add \$422 per lock) See page 25 for specification information.	Digital Lock Color (if applicable): BNL Brushed Nickel
Y P T .	B .	.	.	P .	.		

Example: YPTP651824RFFL.BK.APR0.PJW.LVT1VT.L

Align™ Metal Storage

18"W Front and Side Access Towers

For specification information see pages 34 and 44-45.

Metal Fronts Footed

GSA SIN 33721

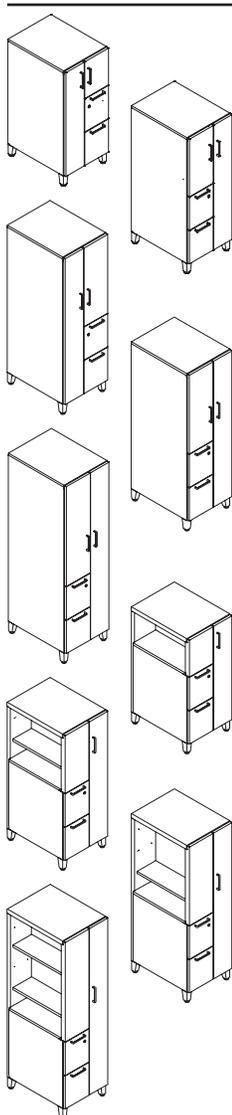

Description	Model	P1 Paint List Price
42½"H Personal Tower — 18"W x 24"D — Metal Case/Metal Fronts		
Wardrobe Left / Door/File/File (shown)	YPTF421824LFFM	\$ 3506
Wardrobe Right / Door/File/File	YPTF421824RFFM	\$ 3506
50"H Personal Tower — 18"W x 24"D — Metal Case/Metal Fronts		
Wardrobe Left / Door/File/File (shown)	YPTF501824LFFM	\$ 3609
Wardrobe Right / Door/File/File (shown)	YPTF501824RFFM	\$ 3609
57½"H Personal Tower — 18"W x 24"D — Metal Case/Metal Fronts		
Wardrobe Left / Door/File/File (shown)	YPTF571824LFFM	\$ 3715
Wardrobe Right / Door/File/File (shown)	YPTF571824RFFM	\$ 3715
65"H Personal Tower — 18"W x 24"D — Metal Case/Metal Fronts		
Wardrobe Left / Door/File/File	YPTF651824LFFM	\$ 3829
Wardrobe Right / Door/File/File (shown)	YPTF651824RFFM	\$ 3829
42½"H Side Access Tower — 18"W x 24"D — Metal Case/Metal Fronts		
Wardrobe Left / Door/File/File	YPTSF421824LFFM	\$ 3792
Wardrobe Right / Door/File/File (shown)	YPTSF421824RFFM	\$ 3792
50"H Side Access Tower — 18"W x 24"D — Metal Case/Metal Fronts		
Wardrobe Left / Door/File/File	YPTSF501824LFFM	\$ 3902
Wardrobe Right / Door/File/File (shown)	YPTSF501824RFFM	\$ 3902
57½"H Side Access Tower — 18"W x 24"D — Metal Case/Metal Fronts		
Wardrobe Left / Door/File/File	YPTSF571824LFFM	\$ 4022
Wardrobe Right / Door/File/File (shown)	YPTSF571824RFFM	\$ 4022
65"H Side Access Tower — 18"W x 24"D — Metal Case/Metal Fronts		
Wardrobe Left / Door/File/File	YPTSF651824LFFM	\$ 4145
Wardrobe Right / Door/File/File (shown)	YPTSF651824RFFM	\$ 4145

METAL STORAGE

<p>How to specify — Select the Model Number from above.</p> <p>Y P T </p> <p> </p>	<p><i>1st Option:</i> Base Option: TF Terrace Foot ZF Stride Foot (+\$85) PF Pier Foot (+\$130)</p>	<p><i>2nd Option:</i> Foot Finish: Terrace, Stride PR6 Silver Pier PR6 Silver P8X Solar Black PJE Pyrite (+\$91) P02 Flint (+\$91) P7B Loft PJW Designer White</p>	<p><i>3rd Option:</i> Pull Option: A Arch B Bevel M Beam O Halo S Square</p>	<p><i>4th Option:</i> Pull Color (if applicable): M Beam / O Halo PJW Designer White PR6 Silver PJE Pyrite P8X Solar Black AP Arch PRO Anodized Silver P2 upcharge +\$18/pull SP Square PJW Designer White EL Matte Silver P02 Flint P7B Loft PJE Pyrite P8X Solar Black P2 upcharge +\$18/pull</p>
	<p>F </p>			

Continued below ▼

<p><i>5th Option:</i> Paint Case: P1 P2 P3 See inside front cover for finishes. P2 upcharge \$113 P3 upcharge \$225</p>	<p><i>6th Option:</i> Paint Fronts: NA Match Case P1 \$254 P2 \$332 P3 \$405</p>	<p><i>7th Option:</i> Markerboard Front: Offered on front panel of side access models only MKB Yes (+\$113) NA No</p>	<p><i>8th Option:</i> Lock: L Standard Lock X Omit Lock Core (Deduct \$20 per lock) E Digital Lock (Add \$422 per lock) See page 25 for specification information.</p>	<p><i>9th Option:</i> Digital Lock Color (if applicable): BNL Brushed Nickel</p>
<p>P </p>				

Example: YPTF651824RFFM.TFPR6.APRO.PJW.NA.L

Align™ Metal Storage

18"W Front and Side Access Towers

For specification information see pages 34 and 44-45.

Laminate Fronts Footed

GSA SIN 33721

	Description	Model	P1 Paint List Price
	42½"H Personal Tower — 18"W x 24"D – Metal Case/Laminate Fronts		
	Wardrobe Left / Door/File/File (shown)	YPTF421824LFFL	\$ 3936
	Wardrobe Right / Door/File/File	YPTF421824RFFL	\$ 3936
	50"H Personal Tower — 18"W x 24"D – Metal Case/Laminate Fronts		
	Wardrobe Left / Door/File/File (shown)	YPTF501824LFFL	\$ 4063
	Wardrobe Right / Door/File/File (shown)	YPTF501824RFFL	\$ 4063
	57½"H Personal Tower — 18"W x 24"D – Metal Case/Laminate Fronts		
	Wardrobe Left / Door/File/File (shown)	YPTF571824LFFL	\$ 4194
	Wardrobe Right / Door/File/File (shown)	YPTF571824RFFL	\$ 4194
	65"H Personal Tower — 18"W x 24"D – Metal Case/Laminate Fronts		
	Wardrobe Left / Door/File/File	YPTF651824LFFL	\$ 4332
	Wardrobe Right / Door/File/File (shown)	YPTF651824RFFL	\$ 4332
	42½"H Side Access Tower — 18"W x 24"D – Metal Case/Laminate Fronts		
	Wardrobe Left / Door/File/File	YPTSF421824LFFL	\$ 4282
	Wardrobe Right / Door/File/File (shown)	YPTSF421824RFFL	\$ 4282
	50"H Side Access Tower — 18"W x 24"D – Metal Case/Laminate Fronts		
	Wardrobe Left / Door/File/File	YPTSF501824LFFL	\$ 4423
	Wardrobe Right / Door/File/File (shown)	YPTSF501824RFFL	\$ 4423
	57½"H Side Access Tower — 18"W x 24"D – Metal Case/Laminate Fronts		
	Wardrobe Left / Door/File/File	YPTSF571824LFFL	\$ 4566
	Wardrobe Right / Door/File/File (shown)	YPTSF571824RFFL	\$ 4566
	65"H Side Access Tower — 18"W x 24"D – Metal Case/Laminate Fronts		
	Wardrobe Left / Door/File/File	YPTSF651824LFFL	\$ 4719
	Wardrobe Right / Door/File/File (shown)	YPTSF651824RFFL	\$ 4719

How to specify — Select the Model Number from above.	1st Option: Base Option:	2nd Option: Foot Finish:	3rd Option: Pull Option:	2nd Option: Pull Color (if applicable):	5th Option: Paint Case:	6th Option: Laminate Fronts: Laminate & Edge:	7th Option: Lock:	8th Option: Digital Lock Color (if applicable):
YPT	TF Terrace Foot ZF Stride Foot (+\$85) PF Pier Foot (+\$130)	Terrace, Stride PR6 Silver Pier PR6 Silver P8X Solar Black PJE Pyrite (+\$91) P02 Flint (+\$91) P7B Loft PJW Designer White	A Arch M Beam O Halo S Square	M Beam / O Halo PJW Designer White PR6 Silver PJE Pyrite P8X Solar Black AP Arch PRO Anodized Silver SP Square PJW Designer White EL Matte Silver P02 Flint P7B Loft PJE Pyrite P8X Solar Black P2 upcharge +\$18/pull	P1 P2 P3 See page 30 for finishes. P2 upcharge \$113 P3 upcharge \$225	See page 30 for finishes. L2 upcharge \$169 L3 upcharge \$337	L Standard Lock X Omit Lock Core (Deduct \$20 per lock) E Digital Lock (Add \$422 per lock) See page 25 for specification information.	BNL Brushed Nickel
	F	PR6			P			

Example: YPTF651824RFFL.ZFPR6.APRO.PJW.LVT1VT.L

Align™ Metal Storage

18"W Front and Side Access Towers

For specification information see pages 34 and 44-45.

Metal Fronts with Casters

GSA SIN 33721

	Description	Model	P1 Paint List Price
	42½"H Personal Tower — 18"W x 24"D – Metal Case/Metal Fronts		
	Wardrobe Left / Door/File/File	YPTM421824LFFM	\$ 3493
	Wardrobe Right / Door/File/File (shown)	YPTM421824RFFM	\$ 3493
	50"H Personal Tower — 18"W x 24"D – Metal Case/Metal Fronts		
	Wardrobe Left / Door/File/File	YPTM501824LFFM	\$ 3596
	Wardrobe Right / Door/File/File (shown)	YPTM501824RFFM	\$ 3596
	57½"H Personal Tower — 18"W x 24"D – Metal Case/Metal Fronts		
	Wardrobe Left / Door/File/File	YPTM571824LFFM	\$ 3703
	Wardrobe Right / Door/File/File (shown)	YPTM571824RFFM	\$ 3703
	65"H Personal Tower — 18"W x 24"D – Metal Case/Metal Fronts		
	Wardrobe Left / Door/File/File	YPTM651824LFFM	\$ 3813
	Wardrobe Right / Door/File/File (shown)	YPTM651824RFFM	\$ 3813
	42½"H Side Access Tower — 18"W x 24"D – Metal Case/Metal Fronts		
	Wardrobe Left / Door/File/File (shown)	YPTSM421824LFFM	\$ 4060
	Wardrobe Right / Door/File/File	YPTSM421824RFFM	\$ 4060
	50"H Side Access Tower — 18"W x 24"D – Metal Case/Metal Fronts		
	Wardrobe Left / Door/File/File	YPTSM501824LFFM	\$ 4176
	Wardrobe Right / Door/File/File (shown)	YPTSM501824RFFM	\$ 4176
	57½"H Side Access Tower — 18"W x 24"D – Metal Case/Metal Fronts		
	Wardrobe Left / Door/File/File (shown)	YPTSM571824LFFM	\$ 4293
	Wardrobe Right / Door/File/File	YPTSM571824RFFM	\$ 4293
	65"H Side Access Tower — 18"W x 24"D – Metal Case/Metal Fronts		
	Wardrobe Left / Door/File/File	YPTSM651824LFFM	\$ 4415
	Wardrobe Right / Door/File/File (shown)	YPTSM651824RFFM	\$ 4415

METAL STORAGE

How to specify — Select the Model Number from above.	1st Option: Pull Option:	2nd Option: Pull Color (if applicable):	3rd Option: Paint Case:	4th Option: Paint Fronts:	5th Option: Markerboard Front:	6th Option: Lock:	7th Option: Digital Lock Color (if applicable):
Y P T	A Arch B Bevel M Beam O Halo S Square	M Beam / O Halo P JW Designer White P R6 Silver P JE Pyrite P B X Solar Black A P Arch P R O Anodized Silver S P Square P JW Designer White E L Matte Silver P O 2 Flint P 7 B Loft P JE Pyrite P B X Solar Black P 2 upcharge +\$18/pull	P 1 P 2 P 3 See inside front cover for finishes. P 2 upcharge \$113 P 3 upcharge \$225	N A Match C ase P 1 \$254 P 2 \$332 P 3 \$405	M KB Yes (+\$113) N A No	L Standard Lock X Omit Lock Core (Deduct \$20 per lock) E Digital Lock (Add \$422 per lock) See page 25 for specification information.	B N L Brushed N ickel
_____ .	_____	_____ .	P .	N A .	_____ .	_____	_____ .

Example: YPTM651824RFFM.AP.RO.PJW.NA.L

Align™ Metal Storage

18"W Front and Side Access Towers

For specification information see pages 34 and 44-45.

Laminate Fronts with Casters

GSA SIN 33721

	Description	Model	P1 Paint List Price
	42½"H Personal Tower — 18"W x 24"D – Metal Case/Laminate Fronts		
	Wardrobe Left / Door/File/File	YPTM421824LFFL	\$ 3923
	Wardrobe Right / Door/File/File (shown)	YPTM421824RFFL	\$ 3923
	50"H Personal Tower — 18"W x 24"D – Metal Case/Laminate Fronts		
	Wardrobe Left / Door/File/File	YPTM501824LFFL	\$ 4049
	Wardrobe Right / Door/File/File (shown)	YPTM501824RFFL	\$ 4049
	57½"H Personal Tower — 18"W x 24"D – Metal Case/Laminate Fronts		
	Wardrobe Left / Door/File/File	YPTM571824LFFL	\$ 4180
	Wardrobe Right / Door/File/File (shown)	YPTM571824RFFL	\$ 4180
	65"H Personal Tower — 18"W x 24"D – Metal Case/Laminate Fronts		
	Wardrobe Left / Door/File/File	YPTM651824LFFL	\$ 4317
	Wardrobe Right / Door/File/File (shown)	YPTM651824RFFL	\$ 4317
	42½"H Side Access Tower — 18"W x 24"D – Metal Case/Laminate Fronts		
	Wardrobe Left / Door/File/File (shown)	YPTSM421824LFFL	\$ 4553
	Wardrobe Right / Door/File/File	YPTSM421824RFFL	\$ 4553
	50"H Side Access Tower — 18"W x 24"D – Metal Case/Laminate Fronts		
	Wardrobe Left / Door/File/File	YPTSM501824LFFL	\$ 4694
	Wardrobe Right / Door/File/File (shown)	YPTSM501824RFFL	\$ 4694
	57½"H Side Access Tower — 18"W x 24"D – Metal Case/Laminate Fronts		
	Wardrobe Left / Door/File/File (shown)	YPTSM571824LFFL	\$ 4837
	Wardrobe Right / Door/File/File	YPTSM571824RFFL	\$ 4837
	65"H Side Access Tower — 18"W x 24"D – Metal Case/Laminate Fronts		
	Wardrobe Left / Door/File/File	YPTSM651824LFFL	\$ 4990
	Wardrobe Right / Door/File/File (shown)	YPTSM651824RFFL	\$ 4990

How to specify — Select the Model Number from above.	1st Option: Pull Option:	2nd Option: Pull Color (if applicable):	3rd Option: Paint Case:	4th Option: Laminate Fronts: Laminate & Edge:	5th Option: Lock:	6th Option: Digital Lock Color (if applicable):
Y P T	A Arch M Beam O Halo S Square	M Beam / O Halo P JW Designer White P R6 Silver P JE Pyrite P B X Solar Black AP Arch P RO Anodized Silver SP Square P JW Designer White EL Matte Silver P O2 Flint P 7 B Loft P JE Pyrite P B X Solar Black P2 upcharge +\$18/pull	P1 P2 P3 See page 30 for finishes. P2 upcharge \$113 P3 upcharge \$225	See page 30 for finishes. L2 upcharge \$169 L3 upcharge \$337	L Standard Lock X Omit Lock Core (Deduct \$20 per lock) E Digital Lock (Add \$422 per lock) See page 25 for specification information.	BNL Brushed Nickel
.	.	.	P

Example: YPTM651824RFFL.APRO.PJW.LVT1VT.L

For specification information see pages 34 and 46.

Metal Fronts with Plinth Base

GSA SIN 33721

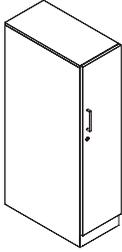

Description	Model	P1 Paint List Price
42½"H Wardrobe / Lockers — 12"W – Metal Case/Metal Front		
18"D Wardrobe Hinges on Left	YPWP421218LM	\$ 2209
18"D Wardrobe Hinges on Right	YPWP421218RM	\$ 2209
24"D Wardrobe Hinges on Left	YPWP421224LM	\$ 2366
24"D Wardrobe Hinges on Right (shown)	YPWP421224RM	\$ 2366
50"H Wardrobe / Lockers — 12"W – Metal Case/Metal Front		
18"D Wardrobe Hinges on Left	YPWP501218LM	\$ 2444
18"D Wardrobe Hinges on Right	YPWP501218RM	\$ 2444
24"D Wardrobe Hinges on Left	YPWP501224LM	\$ 2757
24"D Wardrobe Hinges on Right	YPWP501224RM	\$ 2757
65"H Wardrobe / Lockers — 12"W – Metal Case/Metal Front/Plinth Base		
18"D Wardrobe Hinges on Left	YPWP651218LM	\$ 2677
18"D Wardrobe Hinges on Right	YPWP651218RM	\$ 2677
24"D Wardrobe Hinges on Left	YPWP651224LM	\$ 2991
24"D Wardrobe Hinges on Right	YPWP651224RM	\$ 2991

Note: To order Align wardrobes or lockers with a digital lock option, add suffix "E" to base model number.

To order Align wardrobes or lockers with a digital lock option, add "E" suffix to base model number. The digital lock has an integrated pull, so no pull will be specified.

METAL STORAGE

How to specify — Select the Model Number from above.	1st Option: Base Option (if applicable):	2nd Option: Pull Option:	3rd Option: Pull Color (if applicable):	4th Option: Paint Case:	5th Option: Paint Fronts:	6th Option: Lock:
Y P W	BK Flush Kickplate BX Recessed Kickplate	A Arch B Bevel M Beam O Halo S Square I Integral Pull Option (Digital Lock): E Keypad (+\$478) D RFID (+\$591)	M Beam / O Halo PJW Designer White PR6 Silver PJE Pyrite P8X Solar Black AP Arch PRO Anodized Silver SP Square PJW Designer White EL Matte Silver P02 Flint P7B Loft PJE Pyrite P8X Solar Black P2 upcharge +\$18/pull	P1 P2 P3 See inside front cover for finishes. P2 upcharge \$52 P3 upcharge \$113	NA Match Case P1 \$254 P2 \$332 P3 \$405	L Standard Lock X Omit Lock Core (Deduct \$20 per lock)
Y P W	B .		.	P .	N A .	

Example: YPWP421218RME.BX.E.PJW.NA

For specification information see pages 34 and 46.

Metal Fronts Footed

GSA SIN 33721

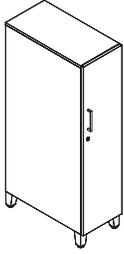

Description	Model	P1 Paint List Price
42½"H Wardrobe / Lockers — 12"W – Metal Case/Metal Front		
18"D Wardrobe Hinges on Left	YPWF421218LM	\$ 2482
18"D Wardrobe Hinges on Right	YPWF421218RM	\$ 2482
24"D Wardrobe Hinges on Left	YPWF421224LM	\$ 2640
24"D Wardrobe Hinges on Right (shown)	YPWF421224RM	\$ 2640
50"H Wardrobe / Lockers — 12"W – Metal Case/Metal Front		
18"D Wardrobe Hinges on Left	YPWF501218LM	\$ 2716
18"D Wardrobe Hinges on Right	YPWF501218RM	\$ 2716
24"D Wardrobe Hinges on Left	YPWF501224LM	\$ 3030
24"D Wardrobe Hinges on Right	YPWF501224RM	\$ 3030
65"H Wardrobe / Lockers — 12"W – Metal Case/Metal Front/Footed Base		
18"D Wardrobe Hinges on Left	YPWF651218LM	\$ 2951
18"D Wardrobe Hinges on Right	YPWF651218RM	\$ 2951
24"D Wardrobe Hinges on Left	YPWF651224LM	\$ 3264
24"D Wardrobe Hinges on Right	YPWF651224RM	\$ 3264

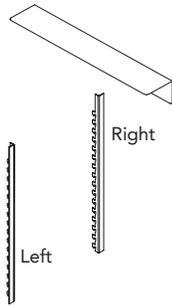

Description	Model	P1 Paint List Price	P2 Paint List Price	P3 Paint List Price
Accessories for 12"W Wardrobe / Lockers				
18"D Wardrobe Tower to Worksurface Bracket	YPWTAWSBKT18	\$ 109	\$ 121	\$ 127
24"D Wardrobe Tower to Worksurface Bracket	YPWTAWSBKT24	\$ 113	\$ 125	\$ 131
Panel Mounting Bracket — Left-Hand	AP22PBKLN	\$ 173	\$ 191	\$ 207
Panel Mounting Bracket — Right-Hand	AP22PBKRH	\$ 173	\$ 191	\$ 207

Note: To order Align wardrobes or lockers with a digital lock option, add suffix "E" to base model number.

To order Align wardrobes or lockers with a digital lock option, add "E" suffix to base model number. The digital lock has an integrated pull, so no pull will be specified.

How to specify — Select the Model Number from above.	1st Option: Base Option:	2nd Option: Foot Finish:	3rd Option: Pull Option (Standard Lock):	4th Option: Pull Color (if applicable):	5th Option: Paint Case:	6th Option: Paint Fronts:	7th Option: Lock:
Y P W	TF Terrace Foot (+\$85) ZF Stride Foot (+\$85) PF Pier Foot (+\$130)	Terrace, Stride PR6 Silver Pier PR6 Silver P8X Solar Black PJE Pyrite (+\$91) P02 Flint (+\$91) P7B Loft P JW Designer White	A Arch B Bevel M Beam O Halo S Square I Integral Pull Option (Digital Lock): E Keypad (+\$478) D RFID (+\$591)	M Beam / O Halo P JW Designer White PR6 Silver PJE Pyrite P8X Solar Black AP Arch PRO Anodized Silver SP Square P JW Designer White EL Matte Silver P02 Flint P7B Loft PJE Pyrite P8X Solar Black P2 upcharge +\$18/pull	P1 P2 P3 See inside front cover for finishes. P2 upcharge \$52 P3 upcharge \$113	NA Match Case P1 \$254 P2 \$332 P3 \$405	L Standard Lock X Omit Lock Core (Deduct \$20 per lock)
. F		P R 6 .	.	.	P .	N A .	.

Example: YPWF421218RM.TFPR6.APRO.PJW.NA.L

Align™ Metal Storage

12"W Wardrobe / Single Lockers

For specification information see pages 34 and 46.

Laminate Fronts with Plinth Base or Footed

GSA SIN 33721

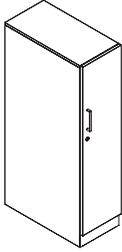

Width	Model	P1 Paint List Price
42½" H Wardrobe / Locker — 12"W – Metal Case/Laminate Front/Recessed Base		
18"D Hinges on Left	YPWP421218LL	\$ 2297
18"D Hinges on Right	YPWP421218RL	\$ 2297
24"D Hinges on Left	YPWP421224LL	\$ 2481
24"D Hinges on Right (shown)	YPWP421224RL	\$ 2481
50" H Wardrobe / Locker — 12"W – Metal Case/Laminate Front/Recessed Base		
18"D Hinges on Left	YPWP501218LL	\$ 2573
18"D Hinges on Right	YPWP501218RL	\$ 2573
24"D Hinges on Left	YPWP501224LL	\$ 2941
24"D Hinges on Right	YPWP501224RL	\$ 2941
65"H Wardrobe / Lockers — 12"W – Metal Case/Laminate Front/Plinth Base		
18"D Wardrobe Hinges on Left	YPWP651218LL	\$ 2847
18"D Wardrobe Hinges on Right	YPWP651218RL	\$ 2847
24"D Wardrobe Hinges on Left	YPWP651224LL	\$ 3216
24"D Wardrobe Hinges on Right	YPWP651224RL	\$ 3216

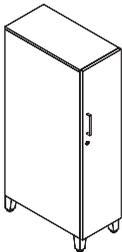

Width	Model	P1 Paint List Price
42½" H Wardrobe / Locker — 12"W – Metal Case/Laminate Front/Recessed Base		
18"D Hinges on Left	YPWF421218LL	\$ 2620
18"D Hinges on Right	YPWF421218RL	\$ 2620
24"D Hinges on Left	YPWF421224LL	\$ 2804
24"D Hinges on Right (shown)	YPWF421224RL	\$ 2804
50" H Wardrobe / Locker — 12"W – Metal Case/Laminate Front/Recessed Base		
18"D Hinges on Left	YPWF501218LL	\$ 2896
18"D Hinges on Right	YPWF501218RL	\$ 2896
24"D Hinges on Left	YPWF501224LL	\$ 3263
24"D Hinges on Right	YPWF501224RL	\$ 3263
65"H Wardrobe / Lockers — 12"W – Metal Case/Laminate Front/Footed Base		
18"D Wardrobe Hinges on Left	YPWF651218LL	\$ 3170
18"D Wardrobe Hinges on Right	YPWF651218RL	\$ 3170
24"D Wardrobe Hinges on Left	YPWF651224LL	\$ 3539
24"D Wardrobe Hinges on Right	YPWF651224RL	\$ 3539

To order Align wardrobes or lockers with a digital lock option, add "E" suffix to base model number. The digital lock has an integrated pull, so no pull will be specified.

METAL STORAGE

How to specify — Select the Model Number from above. Y P W	1st Option: Plinth Base Options (if applicable): BX Recessed Kickplate Footed Base Options: TF Terrace Foot ZF Stride Foot (+\$85) PF Pier Foot (+\$130)	2nd Option: Foot Finish: Terrace, Stride PR6 Silver Pier PR6 Silver P8X Solar Black PJE Pyrite (+\$91) P02 Flint (+\$91) P7B Loft PJW Designer White	3rd Option: Pull Option (Standard Lock): A Arch M Beam O Halo S Square Pull Option (Digital Lock): E Keypad (+\$478) D RFID (+\$591)	4th Option: Pull Color (if applicable): M Beam / O Halo PJW Designer White PR6 Silver PJE Pyrite P8X Solar Black AP Arch PRO Anodized Silver SP Square PJW Designer White EL Matte Silver P02 Flint P7B Loft PJE Pyrite P8X Solar Black P2 upcharge +\$18/pull	5th Option: Paint Case: P1 P2 P3 See page 30 for finishes. P2 upcharge \$52 P3 upcharge \$113	6th Option: Laminate Fronts: Laminate & Edge: See page 30 for finishes. L2 upcharge \$169 L3 upcharge \$337	7th Option: Lock: L Standard Lock X Omit Lock Core (Deduct \$20 per lock)
			P R 6		P		

Example: YPWP421218RL.BX.APR0.PJW.LVT1VT.X

Align™ Metal Storage

12"W Double Lockers

For specification information see pages 34 and 46.

Metal Fronts with Plinth Base or Footed

GSA SIN 33721

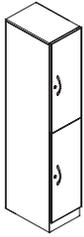

Description	Model	P1 Paint List Price
65"H Double Locker — 12"W – Metal Case/Metal Fronts		
18"D Hinges on Left	YPDLP651218LM	\$ 3029
18"D Hinges on Right (shown)	YPDLP651218RM	\$ 3029

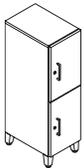

Description	Model	P1 Paint List Price
42 1/2" H Double Locker — 12"W – Metal Case/Metal Fronts/Footed Base		
18"D Hinges on Left	YPDFL421218LM	\$ 2682
18"D Hinges on Right (shown)	YPDFL421218RM	\$ 2682

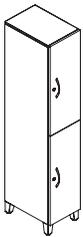

Description	Model	P1 Paint List Price
65"H Double Locker — 12"W – Metal Case/Metal Fronts		
18"D Hinges on Left	YPDFL651218LM	\$ 3298
18"D Hinges on Right (shown)	YPDFL651218RM	\$ 3298

To order Align wardrobes or lockers with a digital lock option, add "E" suffix to base model number. The digital lock has an integrated pull, so no pull will be specified.

How to specify — Select the Model Number from above.	1st Option: Plinth Base Options (if applicable):	2nd Option: Foot Finish:	3rd Option: Pull Option (Standard Lock):	4th Option: Pull Color (if applicable):	5th Option: Paint Case:	6th Option: Paint Fronts:	7th Option: Lock:
Y P	BK Flush Kickplate BX Recessed Kickplate Footed Base Options: TF Terrace Foot (+\$85) ZF Stride Foot (+\$85) PF Pier Foot (+\$130)	Terrace, Stride PR6 Silver Pier PR6 Silver P8X Solar Black PJE Pyrite (+\$91) P02 Flint (+\$91) P7B Loft PJW Designer White	A Arch B Bevel M Beam O Halo S Square I Integral Pull Option (Digital Lock): E Keypad (+\$478 per door) D RFID (+\$591 per door)	M Beam / O Halo PJW Designer White PR6 Silver PJE Pyrite P8X Solar Black AP Arch PRO Anodized Silver SP Square PJW Designer White EL Matte Silver P02 Flint P7B Loft PJE Pyrite P8X Solar Black P2 upcharge +\$18/pull	P1 P2 P3 See page 30 for finishes. P2 upcharge \$85 P3 upcharge \$192	NA Match Case P1 \$254 P2 \$332 P3 \$405	L Standard Lock X Omit Lock Core (Deduct \$20 per lock)
.		P R 6 .	.	P .	N A .		

Example: YPDLP651218LM.BX.E.PJW.NA

Align™ Metal Storage

12"W Double Lockers

For specification information see pages 34 and 46.

Laminate Fronts with Plinth Base or Footed

GSA SIN 33721

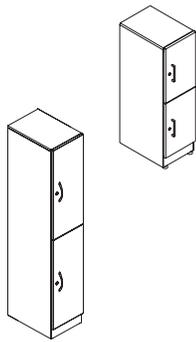

Width	Model	P1 Paint List Price
42½" H Double Locker — 12"W – Metal Case/Laminate Fronts/Plinth Base		
18"D Hinges on Left	YPDLP421218LL	\$ 2537
18"D Hinges on Right (shown)	YPDLP421218RL	\$ 2537
65"H Double Locker — 12"W – Metal Case/Laminate Fronts		
18"D Hinges on Left	YPDLP651218LL	\$ 3259
18"D Hinges on Right (shown)	YPDLP651218RL	\$ 3259

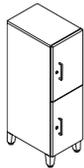

Width	Model	P1 Paint List Price
42½" H Double Locker — 12"W – Metal Case/Laminate Fronts/Footed Base		
18"D Hinges on Left	YPDLF421218LL	\$ 2855
18"D Hinges on Right (shown)	YPDLF421218RL	\$ 2855

To order Align wardrobes or lockers with a digital lock option, add "E" suffix to base model number. The digital lock has an integrated pull, so no pull will be specified.

METAL STORAGE

How to specify — Select the Model Number from above. Y P 	1st Option: Plinth Base Options (if applicable): BX Recessed Kickplate Footed Base Options: TF Terrace Foot ZF Stride Foot (+\$85) PF Pier Foot (+\$130)	2nd Option: Foot Finish: Terrace, Stride PR6 Silver Pier PR6 Silver P8X Solar Black PJE Pyrite (+\$91) P02 Flint (+\$91) P7B Loft PJW Designer White	3rd Option: Pull Option (Standard Lock): A Arch M Beam O Halo S Square Pull Option (Digital Lock): E Keypad (+\$478 per door) D RFID (+\$591 per door)	4th Option: Pull Color (if applicable): M Beam / O Halo PJW Designer White PR6 Silver PJE Pyrite P8X Solar Black AP Arch PRO Anodized Silver SP Square PJW Designer White EL Matte Silver P02 Flint P7B Loft PJE Pyrite P8X Solar Black P2 upcharge +\$18/pull	5th Option: Paint Case: P1 P2 P3 See page 30 for finishes. P2 upcharge \$85 P3 upcharge \$192	6th Option: Laminate Fronts: Laminate & Edge: See page 30 for finishes. L2 upcharge \$169 L3 upcharge \$337	7th Option: Lock: L Standard Lock X Omit Lock Core (Deduct \$20 per lock)
	 	 	P R 6 	 	P 	 	

Example: YDLP651218LL.BX.APRO.PJW.LVT1VT.X

Align™ Metal Storage

24"W Quad Lockers

For specification information see pages 34 and 46.

Metal Fronts with Plinth Base or Footed

GSA SIN 33721

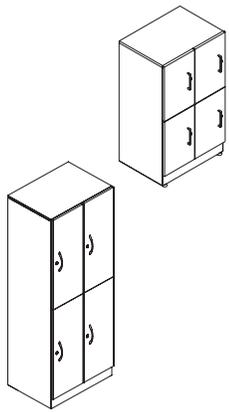

Description	Model	P1 Paint List Price
42½" H Quad Locker — 24"W – Metal Case/Metal Fronts/Plinth Base		
18"D Hinges on Left	YPQLP422418LM	\$ 3645
18"D Hinges on Right (shown)	YPQLP422418RM	\$ 3645
65"H Quad Locker — 24"W – Metal Case/Metal Fronts		
18"D Hinges on Left	YPQLP652418LM	\$ 4108
18"D Hinges on Right (shown)	YPQLP652418RM	\$ 4108

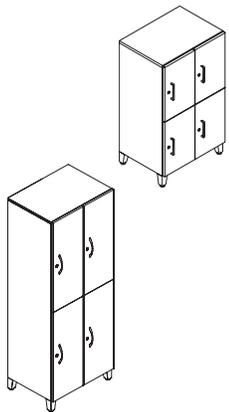

Description	Model	P1 Paint List Price
42½" H Quad Locker — 24"W – Metal Case/Metal Fronts/Footed Base		
18"D Hinges on Left	YPQLF422418LM	\$ 3917
18"D Hinges on Right (shown)	YPQLF422418RM	\$ 3917
65"H Quad Locker — 24"W – Metal Case/Metal Fronts		
18"D Hinges on Left	YPQLF652418LM	\$ 4378
18"D Hinges on Right (shown)	YPQLF652418RM	\$ 4378

To order Align wardrobes or lockers with a digital lock option, add "E" suffix to base model number. The digital lock has an integrated pull, so no pull will be specified.

How to specify — Select the Model Number from above.	1st Option: Plinth Base Options (if applicable):	2nd Option: Foot Finish:	3rd Option: Pull Option (Standard Lock):	4th Option: Pull Color (if applicable):	5th Option: Paint Case:	6th Option: Paint Fronts:	7th Option: Lock:
Y P	BK Flush Kickplate BX Recessed Kickplate Footed Base Options: TF Terrace Foot (+\$85) ZF Stride Foot (+\$85) PF Pier Foot (+\$130)	Terrace, Stride PR6 Silver Pier PR6 Silver P8X Solar Black PJE Pyrite (+\$91) P02 Flint (+\$91) P7B Loft PJW Designer White	A Arch B Bevel M Beam O Halo S Square I Integral Pull Option (Digital Lock): E Keypad (+\$478 per door) D RFID (+\$591 per door)	M Beam / O Halo PJW Designer White PR6 Silver PJE Pyrite P8X Solar Black AP Arch PRO Anodized Silver SP Square PJW Designer White EL Matte Silver P02 Flint P7B Loft PJE Pyrite P8X Solar Black P2 upcharge +\$18/pull	P1 P2 P3 See page 30 for finishes. P2 upcharge \$113 P3 upcharge \$254	NA Match Case P1 \$254 P2 \$332 P3 \$405	L Standard Lock X Omit Lock Core (Deduct \$20 per lock)
		P R 6 .			P	N A .	

Example: YPQLP422418RM.BK.APR0.PJW.NA.L

Align™ Metal Storage

24"W Quad Lockers

For specification information see pages 34 and 46.

Laminate Fronts with Plinth Base or Footed

GSA SIN 33721

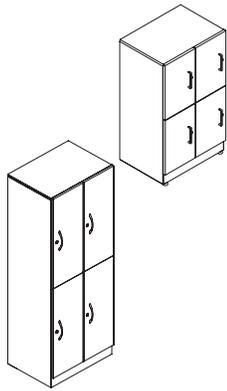

Width	Model	P1 Paint List Price
42½"H Quad Locker — 24"W – Metal Case/Laminate Fronts/Plinth Base		
18"D Hinges on Left	YPQLP422418LL	\$ 3986
18"D Hinges on Right (shown)	YPQLP422418RL	\$ 3986
65"H Quad Locker — 24"W – Metal Case/Laminate Fronts		
18"D Hinges on Left	YPQLP652418LL	\$ 4529
18"D Hinges on Right (shown)	YPQLP652418RL	\$ 4529

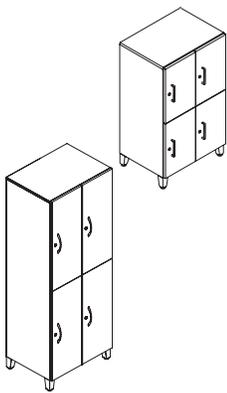

Width	Model	P1 Paint List Price
42½"H Quad Locker — 24"W – Metal Case/Laminate Fronts/Footed Base		
18"D Hinges on Left	YPQLF422418LL	\$ 4302
18"D Hinges on Right (shown)	YPQLF422418RL	\$ 4302
65"H Quad Locker — 24"W – Metal Case/Laminate Fronts		
18"D Hinges on Left	YPQLF652418LL	\$ 4846
18"D Hinges on Right (shown)	YPQLF652418RL	\$ 4846

To order Align wardrobes or lockers with a digital lock option, add "E" suffix to base model number. The digital lock has an integrated pull, so no pull will be specified.

METAL STORAGE

How to specify — Select the Model Number from above.	1st Option: Plinth Base Options (if applicable): BX Recessed Kickplate Footed Base Options: TF Terrace Foot ZF Stride Foot (+\$85) PF Pier Foot (+\$130)	2nd Option: Foot Finish: Terrace, Stride PR6 Silver Pier PR6 Silver P8X Solar Black PJE Pyrite (+\$91) P02 Flint (+\$91) P7B Loft PJW Designer White	3rd Option: Pull Option (Standard Lock): A Arch M Beam O Halo S Square Pull Option (Digital Lock): E Keypad (+\$478 per door) D RFID (+\$591 per door)	4th Option: Pull Color (if applicable): M Beam / O Halo PJW Designer White PR6 Silver PJE Pyrite P8X Solar Black AP Arch PRO Anodized Silver SP Square PJW Designer White EL Matte Silver P02 Flint P7B Loft PJE Pyrite P8X Solar Black P2 upcharge +\$18/pull	5th Option: Paint Case: P1 P2 P3 See page 30 for finishes. P2 upcharge \$113 P3 upcharge \$254	6th Option: Laminate Fronts: Laminate & Edge: See page 30 for finishes. L2 upcharge \$169 L3 upcharge \$337	7th Option: Lock: L Standard Lock X Omit Lock Core (Deduct \$20 per lock)
Y P	P R 6	P

Example: YPQLP652418LL.BX.APRO.PJW.LVT1VT.X

Align™ Metal Storage

12"W Cubby Lockers

For specification information see pages 31 and 43.

Metal Fronts with Plinth Base or Footed

GSA SIN 33721

		Description	Model Numbers	P1 Paint List Price
	50"H Cubby Locker — 12"W – Metal Case/Metal Fronts/Plinth Base			
		18"D Hinges on Left	YPCLP501218LM	\$ 2491
		18"D Hinges on Right	YPCLP501218RM	\$ 2491
	50"H Cubby Locker — 12"W – Metal Case/Metal Fronts/Footed Base			
		18"D Hinges on Left	YPCLF501218LM	\$ 2759
		18"D Hinges on Right	YPCLF501218RM	\$ 2759
65"H Cubby Locker — 12"W – Metal Case/Metal Fronts/Footed Base				
	18"D Hinges on Left	YPCLF651218LM	\$ 3222	
	18"D Hinges on Right	YPCLF651218RM	\$ 3222	

To order Align wardrobes or lockers with a digital lock option, add "E" suffix to base model number. The digital lock has an integrated pull, so no pull will be specified.

How to specify — Select the Model Number from above.	1st Option: Plinth Base Options (if applicable):	2nd Option: Foot Finish:	3rd Option: Pull Option (Standard Lock):	4th Option: Pull Color (if applicable):	5th Option: Paint Case:	6th Option: Paint Fronts:	7th Option: Lock:
Y P	BK Flush Kickplate BX Recessed Kickplate Footed Base Options: TF Terrace Foot (+\$85) ZF Stride Foot (+\$130) PF Pier Foot (+\$130)	Terrace, Stride PR6 Silver Pier PR6 Silver P8X Solar Black PJE Pyrite (+\$91) P02 Flint (+\$91) P7B Loft PJW Designer White	A Arch B Bevel M Beam O Halo S Square I Integral Pull Option (Digital Lock): E Keypad (+\$478 per door) D RFID (+\$591 per door)	M Beam / O Halo PJW Designer White PR6 Silver PJE Pyrite P8X Solar Black AP Arch PRO Anodized Silver SP Square PJW Designer White EL Matte Silver P02 Flint P7B Loft PJE Pyrite P8X Solar Black P2 upcharge +\$18/pull	Paint Case: P1 P2 P3 See page 30 for finishes. P2 upcharge \$113 P3 upcharge \$254	NA Match Case P1 \$254 P2 \$332 P3 \$405	L Standard Lock X Omit Lock Core (Deduct \$20 per lock)
.		PR6 .	.	.	P .	NA .	

Example: YPCLP501218LM.BX.APRO.PJW.NA.X

For specification information see pages 31 and 43.

Laminate Fronts with Plinth Base or Footed

GSA SIN 33721

Width	Model Numbers	P1 Paint List Price
50"H Cubby Locker — 12"W – Metal Case/Laminate Fronts/Plinth Base		
18"D Hinges on Left	YPCLP501218LL	\$ 2627
18"D Hinges on Right	YPCLP501218RL	\$ 2627
50"H Cubby Locker — 12"W – Metal Case/Laminate Fronts/Footed Base		
18"D Hinges on Left	YPCLF501218LL	\$ 2944
18"D Hinges on Right	YPCLF501218RL	\$ 2944
65"H Cubby Locker — 12"W – Metal Case/Laminate Fronts/Plinth Base		
18"D Hinges on Left	YPCLP651218LL	\$ 3169
18"D Hinges on Right	YPCLP651218RL	\$ 3169
65"H Cubby Locker — 12"W – Metal Case/Laminate Fronts/Footed Base		
18"D Hinges on Left	YPCLF651218LL	\$ 3487
18"D Hinges on Right	YPCLF651218RL	\$ 3487

To order Align wardrobes or lockers with a digital lock option, add "E" suffix to base model number. The digital lock has an integrated pull, so no pull will be specified.

METAL STORAGE

How to specify — Select the Model Number from above. Y P .	1st Option: Plinth Base Options (if applicable): BX Recessed Kickplate Footed Base Options: TF Terrace Foot ZF Stride Foot (+\$85) PF Pier Foot (+\$130)	2nd Option: Foot Finish: Terrace, Stride PR6 Silver Pier PR6 Silver P8X Solar Black PJE Pyrite (+\$91) P02 Flint (+\$91) P7B Loft PJW Designer White	3rd Option: Pull Option (Standard Lock): A Arch M Beam O Halo S Square Pull Option (Digital Lock): E Keypad (+\$478 per door) D RFID (+\$591 per door)	4th Option: Pull Color (if applicable): M Beam / O Halo PJW Designer White PR6 Silver PJE Pyrite P8X Solar Black AP Arch PRO Anodized Silver SP Square PJW Designer White EL Matte Silver P02 Flint P7B Loft PJE Pyrite P8X Solar Black P2 upcharge +\$18/pull	5th Option: Paint Case: P1 P2 P3 See page 28 for finishes. P2 upcharge \$113 P3 upcharge \$254	6th Option: Laminate Fronts: Laminate & Edge: See page 28 for finishes. L2 upcharge \$169 L3 upcharge \$337	7th Option: Lock: L Standard Lock X Omit Lock Core (Deduct \$20 per lock)
	P R 6	P

Example: YPCLP501218LL.BX.APR0.PJW.LVT1VT.X

Align™ Metal Storage

24"W Cubby Lockers

For specification information see pages 34 and 46.

Metal Fronts with Plinth Base or Footed

GSA SIN 33721

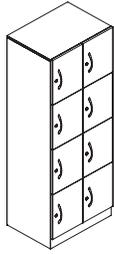

Description	Model	P1 Paint List Price
65"H Cubby Locker — 24"W – Metal Case/Metal Fronts		
18"D Hinges on Left	YPCLP652418LM	\$ 5033
18"D Hinges on Right (shown)	YPCLP652418RM	\$ 5033

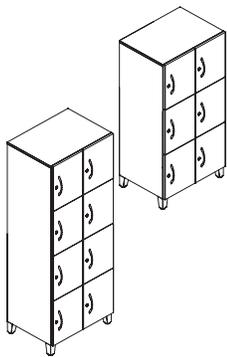

Description	Model	P1 Paint List Price
50"H Cubby Locker — 24"W – Metal Case/Metal Fronts		
18"D Hinges on Left	YPCLF502418LM	\$ 4533
18"D Hinges on Right (shown)	YPCLF502418RM	\$ 4533
65"H Cubby Locker — 24"W – Metal Case/Metal Fronts		
18"D Hinges on Left	YPCLF652418LM	\$ 5304
18"D Hinges on Right (shown)	YPCLF652418RM	\$ 5304

To order Align wardrobes or lockers with a digital lock option, add "E" suffix to base model number. The digital lock has an integrated pull, so no pull will be specified.

How to specify — Select the Model Number from above.	1st Option: Plinth Base Options (if applicable):	2nd Option: Foot Finish:	3rd Option: Pull Option (Standard Lock):	4th Option: Pull Color (if applicable):	5th Option: Paint Case:	6th Option: Paint Fronts:	7th Option: Lock:
Y P	BK Flush Kickplate BX Recessed Kickplate Footed Base Options: TF Terrace Foot (+\$85) ZF Stride Foot (+\$130) PF Pier Foot (+\$130)	Terrace, Stride PR6 Silver Pier PR6 Silver P8X Solar Black PJE Pyrite (+\$91) P02 Flint (+\$91) P7B Loft PJW Designer White	A Arch B Bevel M Beam O Halo S Square I Integral Pull Option (Digital Lock): E Keypad (+\$478 per door) D RFID (+\$591 per door)	M Beam / O Halo PJW Designer White PR6 Silver PJE Pyrite P8X Solar Black AP Arch PRO Anodized Silver SP Square PJW Designer White EL Matte Silver P02 Flint P7B Loft PJE Pyrite P8X Solar Black P2 upcharge +\$18/pull	Paint Case: P1 P2 P3 See page 30 for finishes. P2 upcharge \$113 P3 upcharge \$254	Paint Fronts: NA Match Case P1 \$254 P2 \$332 P3 \$405	L Standard Lock X Omit Lock Core (Deduct \$20 per lock)
.		PR6 .	.	.	P .	NA .	

Example: YPCLP652418LM.BX.APRO.PJW.NA.X

Align™ Metal Storage

24"W Cubby Lockers

For specification information see pages 34 and 46.

Laminate Fronts with Plinth Base or Footed

GSA SIN 33721

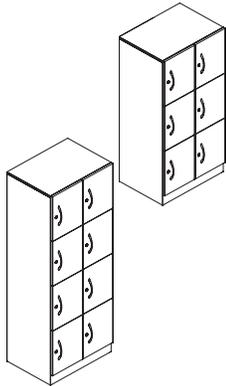

Width	Model	P1 Paint List Price
50"H Cubby Locker — 24"W – Metal Case/Laminate Fronts		
18"D Hinges on Left	YPCLP502418LL	\$ 4710
18"D Hinges on Right (shown)	YPCLP502418RL	\$ 4710
65"H Cubby Locker — 24"W – Metal Case/Laminate Fronts		
18"D Hinges on Left	YPCLP652418LL	\$ 5617
18"D Hinges on Right (shown)	YPCLP652418RL	\$ 5617

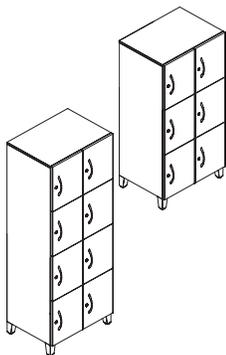

Width	Model	P1 Paint List Price
50"H Cubby Locker — 24"W – Metal Case/Laminate Fronts		
18"D Hinges on Left	YPCLF502418LL	\$ 5027
18"D Hinges on Right (shown)	YPCLF502418RL	\$ 5027
65"H Cubby Locker — 24"W – Metal Case/Laminate Fronts		
18"D Hinges on Left	YPCLF652418LL	\$ 5932
18"D Hinges on Right (shown)	YPCLF652418RL	\$ 5932

To order Align wardrobes or lockers with a digital lock option, add "E" suffix to base model number. The digital lock has an integrated pull, so no pull will be specified.

METAL STORAGE

How to specify — Select the Model Number from above.	1st Option: Plinth Base Options (if applicable): BX Recessed Kickplate Footed Base Options: TF Terrace Foot ZF Stride Foot (+\$85) PF Pier Foot (+\$130)	2nd Option: Foot Finish: Terrace, Stride PR6 Silver Pier PR6 Silver P8X Solar Black PJE Pyrite (+\$91) P02 Flint (+\$91) P7B Loft PJW Designer White	3rd Option: Pull Option (Standard Lock): A Arch M Beam O Halo S Square Pull Option (Digital Lock): E Keypad (+\$478 per door) D RFID (+\$591 per door)	4th Option: Pull Color (if applicable): M Beam / O Halo PJW Designer White PR6 Silver PJE Pyrite P8X Solar Black AP Arch PRO Anodized Silver SP Square PJW Designer White EL Matte Silver P02 Flint P7B Loft PJE Pyrite P8X Solar Black P2 upcharge +\$18/pull	5th Option: Paint Case: P1 P2 P3 See page 30 for finishes. P2 upcharge \$113 P3 upcharge \$254	6th Option: Laminate Fronts: Laminate & Edge: See page 30 for finishes. L2 upcharge \$169 L3 upcharge \$337	7th Option: Lock: L Standard Lock X Omit Lock Core (Deduct \$20 per lock)
Y P	P R 6	P

Example: YPCLP652418LL.BX.APR0.PJW.LVT1VT.X

For specification information see page 24.

GSA SIN PENDING



00000

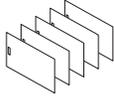

Description	Model	List Price
Digital Lock Keys and Accessories		
Programming Key	YPLDIGPRG	\$ 340
Manager Key	YPLDIGMGR	\$ 263
5pk RFID Stickers	YPLRFID5S	\$ 113
5pk RFID Cards	YPLRFID5C	\$ 226
25pk RFID Stickers	YPLRFID25S	\$ 537
25pk RFID Cards	YPLRFID25C	\$ 1074

METAL STORAGE

How to specify —

Select the Model Number from above.

Y | P | L | | | | | | | | | |

Examples: YPLDIGPRG YPLRFID5S

TOPS

GRADE L1

ABSTRACTS

Ash.....	LT3B
Silver Mesh.....	LT8D
Handspun Pear.....	LAHP
Handspun Dove.....	LAHD
Handspun Slate.....	LAHS
Handspun Chestnut.....	LAHC

SOLID

Black.....	P
Brownstone.....	LM13
Designer White 15051.....	LDW1
Flint.....	LM16
Fossil Shale.....	LEH1
Loft.....	LM11
Muslin.....	LM15
Titanium.....	LTI1

WOODGRAIN

Belair.....	LWBA
Bourbon Cherry.....	H
Field Elm.....	LWFE
Florence Walnut.....	LFW1
Kingswood Walnut.....	LK11
Natural Maple.....	LWD
NeoWalnut.....	LNU1
Pinnacle.....	PINC
Shaker Cherry.....	LW7C

GRADE L2

Beigewood.....	LWBE
Fawn Cypress.....	LFC1
Lowell Ash.....	LLA1
Mangalore Mango.....	LMM1
Natural Recon.....	LNR1
Phantom Charcoal.....	LPC1
Phantom Ecru.....	LPE1
Portico Teak.....	LPT1
Skyline Walnut.....	LSW1
Veranda Teak.....	LVT1

GRADE L3

Natural Walnut.....	LWNW
---------------------	------

CHASSIS

GRADE L1

SOLID

Black.....	P
Brownstone.....	LM13
Designer White 15051.....	LDW1
Flint.....	LM16
Fossil Shale.....	LEH1
Loft.....	LM11
Muslin.....	LM15

WOODGRAIN

Belair.....	LWBA
Bourbon Cherry.....	H
Field Elm.....	LWFE
Florence Walnut.....	LFW1
Kingswood Walnut.....	LK11
Natural Maple.....	LWD
NeoWalnut.....	LNU1
Pinnacle.....	PINC
Shaker Cherry.....	LW7C

GRADE L2

Beigewood.....	LWBE
Fawn Cypress.....	LFC1
Lowell Ash.....	LLA1
Mangalore Mango.....	LMM1
Natural Recon.....	LNR1
Phantom Charcoal.....	LPC1
Phantom Ecru.....	LPE1
Portico Teak.....	LPT1
Skyline Walnut.....	LSW1
Veranda Teak.....	LVT1

GRADE L3

Natural Walnut.....	LWNW
---------------------	------

EDGE

Beigewood.....	DE
Belair.....	BA
Black.....	E4
Bourbon Cherry.....	H
Brownstone.....	EY
Designer White.....	DW
Fawn Cypress.....	FC
Field Elm.....	FE
Flint.....	E9
Florence Walnut.....	FW
Fossil.....	EH
Kingswood Walnut.....	KI
Loft.....	EV
Lowell Ash.....	DL
Mangalore Mango.....	MM
Muslin.....	EU
Natural Maple.....	DD
Natural Recon.....	NR
Natural Walnut.....	DN
NeoWalnut.....	NU
Phantom Charcoal.....	PC
Phantom Ecru.....	PE
Pinnacle.....	PI
Portico Teak.....	DP
Shaker Cherry.....	DF
Skyline Walnut.....	SW
Veranda Teak.....	VT

Storage Islands are a new application for Align and Essentials Storage Lines.

***Essentials 3H Storage and Align 42½"H Lockers and Wardrobes**

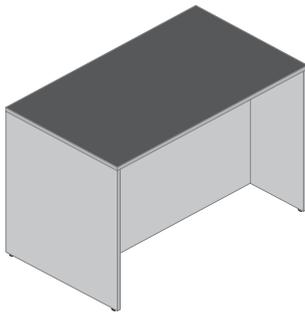

Top: (pages 96-99)

- Available in 18"D and 36"D.
- Tops made of 1¼" particle board with 2mm edgeband, High Pressure laminate on one side and paper back on the other. Grain direction on all tops runs horizontal.
- Tops specified specific to the application.
Example: Storage island tops with end panels will have proper pilot holes in the top to accept attachment hardware.
- External Support Channel should be used in applications where +48"W tops are unsupported.

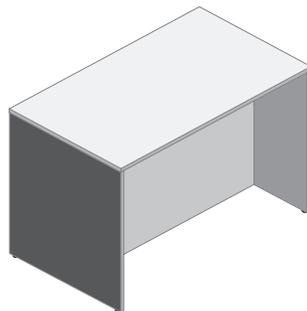

End Panel: (page 100)

- Panels made of 1¼" particle board with 2mm edgeband and High-Pressure Laminate on both sides.
- Grain direction on all End Panels runs vertical.
- End Panels are shipped with mounting hardware.
- All 36"D End Panels and Tops accept a septum, however, it is not necessary to put one in for all applications.

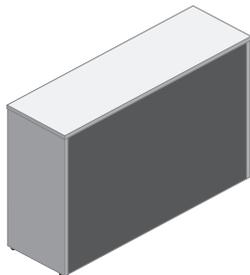

Back/Septum: (page 100)

- Model is considered a back when used in 18"D configurations to encase back of storage units.
- Model is considered septum when used in 36"D configurations to create division down the center of 36"D top.
- Backs/septums are made of ¾" particle board with 0.5mm edgeband and High-Pressure Laminate on both sides.
- Grain direction on all backs/septums runs horizontal.
- Ship with mounting hardware.
- The width and number of units spanned on the septum must match the width and number of units spanned on the top.

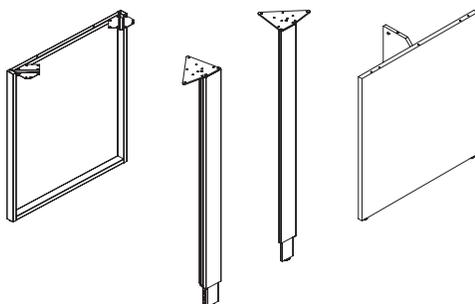
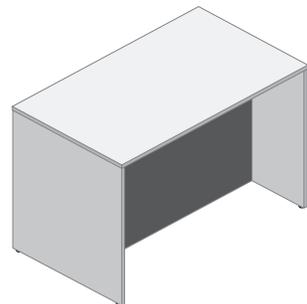

End of Run Supports: (pages 101-102)

- O-legs installed in peninsula application are centered front to back on the worksurface. The O-leg will be ½" inset from the edge of the worksurface.
- When specifying a peninsula application, at least one side of the open worksurface span must be supported with undersurface storage. Island tops cannot be specified with only O-leg, Stride Post Legs, or Laminate Return Panel supports.
- Stride Legs are height-adjustable and able to be used with Align or Essentials platforming.
- End of Run laminate supports can be specified as a "waterfall" return on peninsula applications.

Working with Storage Islands

Top Sizes: (pages 96-99)

Top models are decided by what is needed in the application. If a storage island is specifying end panels, a different top model is needed than when a non-paneled island is configured. Storage Island Tops for use with End Panels are dimensionally larger to accommodate the needed attachment. The below chart highlights how the depth changes when panels and backs are specified.

<div style="display: flex; align-items: center; justify-content: center;"> <div style="border: 1px solid black; width: 150px; height: 100px; margin-right: 10px;"></div> <div style="text-align: center;"> <p>Width</p> <p>Depth</p> </div> </div>	Depths	
	18"D No Back, No End panels	18.190
	18"D No Back, With End panels	18.440
	18"D Back and End Panels	19.455
	36"D No Back, No End Panels	36.690
36"D End Panels		

End Panel sizes: (pages 100-102)

Storage islands can be designed using Essentials and Align. These storage platforms have a 2" variance making storage island dimensions different depending on storage platform used. See the chart to the right for dimensions of end panels.

*Recommend usage of panels when top is specified and storage sides are exposed. Storage will have gap between back-to-back units if top is flush with storage units.

	Depths	Height
18"D No Back, Align	18.190	40.8
18"D No Back, Essentials		38.8
18"D With Back, Align	19.204	40.8
18"D With Back, Essentials		38.8
36"D End Panels, Align	36.440	40.8
36"D End Panels, Essentials		38.8

As the storage island configuration grows, the top width also increases. The below chart outlines how to calculate these dimensions when considering how many units are spanned and if end panels are specified. When specifying your model for the storage island top, the model will end with the correlating span. These spanning guidelines assume all storage units are the same model and does not take into account mixing and matching of units. When mixing and matching of storage units, use the below chart to find required top dimensions and pick top model with this information. Spanning indicated on model may not be indicative of configuration when mixing and matching.

	Width Sizes						
	Span 1	Span 2	Span 3	Span 4	Span 5	Span 6	Span 7
No End Panels	Listed Model Dimensions	Span 1 + 0.125	Span 1 + 0.25	Span 1 + 0.375	Span 1 + 0.5	Span 1 + 0.625	Span 1 + 0.75
1 End Panel	Listed Model Dimensions + 1.372						
2 End Panels	Listed Model Dimensions + 2.744						

Span 1 tops indicate it will only cover a single storage unit. Start with the span 1 number displayed in the table above. Depending on your Islands configuration, the top width increases accordingly based on the 2 factors below.

- 1). The number of end panels you attach to the worksurface. As you add end panels, 1.372" is also added to the top dimensions per end panel specified.
- 2). The number of side-to-side storage units the surface spans. The spanning from one unit to another takes into account .125" gap between each storage unit.

*Be sure to use the width of the worksurface you select. Models correspond to the correct surface width.

*Span represents the total number of side-to-side units. Front-to-back units do not factor into number of units spanned.

Example: Two 24" W laterals are specified side-to-side. The top will span across two units making it a "S2." The configuration will also include two end panels, so the overall width of the configuration is $48" + 2.744" + .125" = 50.869"$ W.

Working with Storage Islands

Application Overview

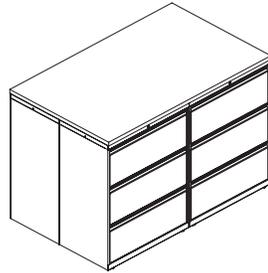

Simple Storage Island:

Simple Storage Islands only consist of adding a top to Align or Essentials storage configurations. Simple Storage Islands allow users to flex storage spaces into usable spaces.

Fully Shrouded Storage Island:

Fully Shrouded Storage Islands consist of adding a top, back/septum, and end panels. Single- (18"D top) or double-sided (36"D top) applications can be specified as fully shrouded. By adding these additional parts and pieces to Essentials or Align Storage platforms users can create more permanent and visually appealing storage spaces.

- When specifying like applications, both end panels must be specified with the back. The back piece cannot connect to another back.
- In a counter top application, the unsupported 18"D surface will require an external stiffener based on the unsupported width.

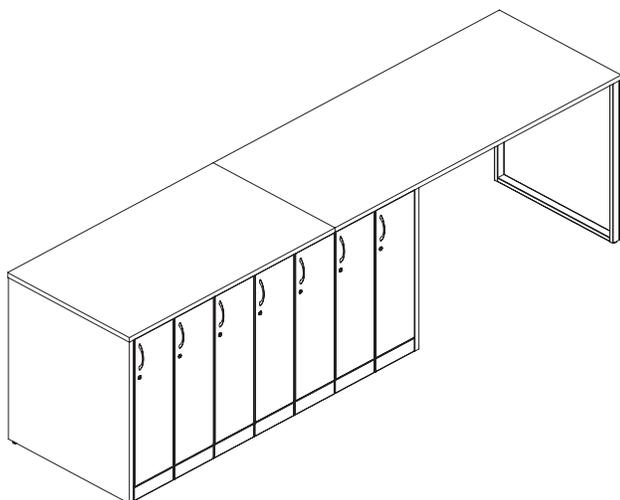
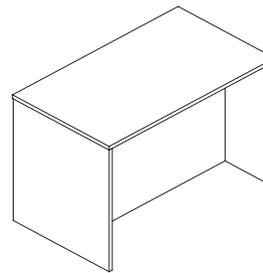

Collaborative Storage Peninsula:

Collaborative Storage Peninsulas consist of tops, septum, end panels, and end of run supports. Peninsulas create usable storage spaces and collaborative work areas all in one configuration.

- Peninsula applications can only be completed with 36"D worksurfaces and end panels.
- Back to back storage specified without an end panel will result in a $\sim\frac{3}{8}$ " gap between storage units.
- In a peninsula application, one end of the worksurface must be supported by undersurface storage. The opposing end can be supported with an O-leg, Stride Post Legs, or laminate return panel.

For specification information see pages 93-95.

GSA SIN 33721

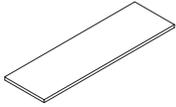

Description	Model	L1 List Price	L2 List Price	L3 List Price
18" D Storage Island Tops: For use with non-paneled storage island				
24" W S1	ISLAUTNPB2418S1	\$ 273	\$ 285	\$ 295
30" W S1	ISLAUTNPB3018S1	\$ 300	\$ 312	\$ 324
36" W S1	ISLAUTNPB3618S1	\$ 340	\$ 355	\$ 368
36" W S3	ISLAUTNPB3618S3	\$ 360	\$ 376	\$ 389
42" W S1	ISLAUTNPB4218S1	\$ 368	\$ 384	\$ 398
48" W S1	ISLAUTNPB4818S1	\$ 400	\$ 417	\$ 432
48" W S2	ISLAUTNPB4818S2	\$ 410	\$ 427	\$ 443
48" W S4	ISLAUTNPB4818S4	\$ 418	\$ 436	\$ 451
60" W S1	ISLAUTNPB6018S1	\$ 424	\$ 442	\$ 458
60" W S2	ISLAUTNPB6018S2	\$ 436	\$ 454	\$ 470
60" W S5	ISLAUTNPB6018S5	\$ 452	\$ 471	\$ 488
72" W S1	ISLAUTNPB7218S1	\$ 461	\$ 480	\$ 498
72" W S2	ISLAUTNPB7218S2	\$ 507	\$ 528	\$ 548
72" W S3	ISLAUTNPB7218S3	\$ 524	\$ 545	\$ 566
72" W S6	ISLAUTNPB7218S6	\$ 565	\$ 588	\$ 610
84" W S1	ISLAUTNPB8418S1	\$ 606	\$ 630	\$ 654
84" W S2	ISLAUTNPB8418S2	\$ 620	\$ 645	\$ 669
84" W S7	ISLAUTNPB8418S7	\$ 668	\$ 695	\$ 721
90" W S1	ISLAUTNPB9018S1	\$ 692	\$ 720	\$ 747
90" W S3	ISLAUTNPB9018S3	\$ 718	\$ 747	\$ 775

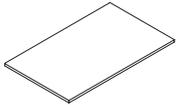

36" D Storage Island Tops: For use with non-paneled storage island				
24" W S1	ISLAUTNPB2436S1	\$ 459	\$ 478	\$ 496
30" W S1	ISLAUTNPB3036S1	\$ 507	\$ 528	\$ 548
36" W S1	ISLAUTNPB3636S1	\$ 572	\$ 595	\$ 618
36" W S3	ISLAUTNPB3636S3	\$ 603	\$ 627	\$ 651
42" W S1	ISLAUTNPB4236S1	\$ 620	\$ 645	\$ 669
48" W S1	ISLAUTNPB4836S1	\$ 674	\$ 701	\$ 728
48" W S2	ISLAUTNPB4836S2	\$ 691	\$ 719	\$ 746
48" W S4	ISLAUTNPB4836S4	\$ 703	\$ 731	\$ 759
60" W S1	ISLAUTNPB6036S1	\$ 714	\$ 743	\$ 771
60" W S2	ISLAUTNPB6036S2	\$ 734	\$ 764	\$ 792
60" W S5	ISLAUTNPB6036S5	\$ 761	\$ 791	\$ 821
72" W S1	ISLAUTNPB7236S1	\$ 775	\$ 806	\$ 836
72" W S2	ISLAUTNPB7236S2	\$ 855	\$ 889	\$ 922
72" W S3	ISLAUTNPB7236S3	\$ 880	\$ 916	\$ 950
72" W S6	ISLAUTNPB7236S6	\$ 949	\$ 987	\$ 1024
84" W S1	ISLAUTNPB8436S1	\$ 1019	\$ 1060	\$ 1100
84" W S2	ISLAUTNPB8436S2	\$ 1044	\$ 1086	\$ 1127
84" W S7	ISLAUTNPB8436S7	\$ 1122	\$ 1167	\$ 1211
90" W S1	ISLAUTNPB9036S1	\$ 1165	\$ 1212	\$ 1257
90" W S3	ISLAUTNPB9036S3	\$ 1209	\$ 1257	\$ 1304

<p>How to specify — Select the Model Number from above.</p>	<p>1st Option: FSC Certified Wood: F FSC Certified X No FSC</p>	<p>2nd Option: Laminate (if applicable): See page 92 for finishes.</p>	<p>3rd Option: Edgeband (if applicable): See page 92 for finishes.</p>
<p>Example: ISLAUTNPB2418S1.LM16.E9</p>			

For specification information see pages 93-95.

GSA SIN 33721

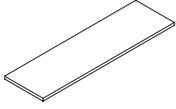

Description	Model	L1 List Price	L2 List Price	L3 List Price
18"D Storage Island Tops: For use with 2 end panels				
24"W S1	ISLAUT2PNB2418S1	\$ 300	\$ 312	\$ 324
30"W S1	ISLAUT2PNB3018S1	\$ 331	\$ 346	\$ 358
36"W S1	ISLAUT2PNB3618S1	\$ 375	\$ 391	\$ 405
36"W S3	ISLAUT2PNB3618S3	\$ 396	\$ 413	\$ 428
42"W S1	ISLAUT2PNB4218S1	\$ 405	\$ 422	\$ 437
48"W S2	ISLAUT2PNB4818S2	\$ 452	\$ 471	\$ 488
48"W S4	ISLAUT2PNB4818S4	\$ 459	\$ 478	\$ 496
60"W S2	ISLAUT2PNB6018S2	\$ 479	\$ 499	\$ 517
60"W S5	ISLAUT2PNB6018S5	\$ 496	\$ 516	\$ 537
72"W S2	ISLAUT2PNB7218S2	\$ 557	\$ 579	\$ 602
72"W S3	ISLAUT2PNB7218S3	\$ 576	\$ 599	\$ 622
72"W S6	ISLAUT2PNB7218S6	\$ 620	\$ 645	\$ 669
84"W S2	ISLAUT2PNB8418S2	\$ 682	\$ 710	\$ 736
84"W S7	ISLAUT2PNB8418S7	\$ 734	\$ 764	\$ 792
90"W S3	ISLAUT2PNB9018S3	\$ 789	\$ 820	\$ 851

<p>How to specify — Select the Model Number from above.</p>	<p>1st Option: FSC Certified Wood: F FSC Certified X No FSC</p>	<p>2nd Option: Laminate (if applicable): See page 92 for finishes.</p>	<p>3rd Option: Edgeband (if applicable): See page 92 for finishes.</p>
<p>_____ . _____ .</p>	<p>_____ .</p>	<p>_____ .</p>	<p>_____ .</p>

Example: ISLAUT2PNB2418S1.LM16.E9

For specification information see pages 93-95.

GSA SIN 33721

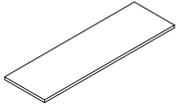

Description	Model	L1 List Price	L2 List Price	L3 List Price
18"D Storage Island Tops: For use with 2 end panels and back panel				
48"W S2	ISLAUT2PYB4818S2	\$ 496	\$ 516	\$ 537
48"W S4	ISLAUT2PYB4818S4	\$ 505	\$ 526	\$ 546
60"W S2	ISLAUT2PYB6018S2	\$ 527	\$ 548	\$ 570
60"W S5	ISLAUT2PYB6018S5	\$ 546	\$ 568	\$ 590
72"W S2	ISLAUT2PYB7218S2	\$ 613	\$ 637	\$ 662
72"W S3	ISLAUT2PYB7218S3	\$ 634	\$ 659	\$ 684
72"W S6	ISLAUT2PYB7218S6	\$ 682	\$ 710	\$ 736
84"W S2	ISLAUT2PYB8418S2	\$ 750	\$ 780	\$ 809
84"W S7	ISLAUT2PYB8418S7	\$ 808	\$ 840	\$ 872
90"W S3	ISLAUT2PYB9018S3	\$ 869	\$ 903	\$ 937

<p>How to specify — Select the Model Number from above.</p>	<p>1st Option: FSC Certified Wood: F FSC Certified X No FSC</p>	<p>2nd Option: Laminate (if applicable): See page 92 for finishes.</p>	<p>3rd Option: Edgeband (if applicable): See page 92 for finishes.</p>
<p>_____ . _____ .</p>	<p>_____ .</p>	<p>_____ .</p>	<p>_____ .</p>

Example: ISLAUT2PYB4818S2.LM16.E9

For specification information see pages 93-95.

GSA SIN 33721

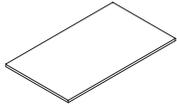

Description	Model	L1 List Price	L2 List Price	L3 List Price
36"D Storage Island Tops: For use with 1 end panel and septum				
48"W S2	ISLAUT1PYB4836S2	\$ 828	\$ 861	\$ 894
48"W S4	ISLAUT1PYB4836S4	\$ 843	\$ 876	\$ 910
60"W S2	ISLAUT1PYB6036S2	\$ 880	\$ 916	\$ 950
60"W S5	ISLAUT1PYB6036S5	\$ 911	\$ 948	\$ 983
72"W S2	ISLAUT1PYB7236S2	\$ 1026	\$ 1068	\$ 1107
72"W S3	ISLAUT1PYB7236S3	\$ 1054	\$ 1097	\$ 1137
72"W S6	ISLAUT1PYB7236S6	\$ 1138	\$ 1184	\$ 1228
84"W S2	ISLAUT1PYB8436S2	\$ 1252	\$ 1302	\$ 1350
84"W S7	ISLAUT1PYB8436S7	\$ 1345	\$ 1399	\$ 1452
90"W S3	ISLAUT1PYB9036S3	\$ 1447	\$ 1504	\$ 1562
36"D Storage Island Tops: For use with 2 end panels and septum				
48"W S2	ISLAUT2PYB4836S2	\$ 836	\$ 869	\$ 902
48"W S4	ISLAUT2PYB4836S4	\$ 853	\$ 887	\$ 920
60"W S2	ISLAUT2PYB6036S2	\$ 890	\$ 926	\$ 961
60"W S5	ISLAUT2PYB6036S5	\$ 917	\$ 954	\$ 990
72"W S2	ISLAUT2PYB7236S2	\$ 1037	\$ 1079	\$ 1119
72"W S3	ISLAUT2PYB7236S3	\$ 1064	\$ 1107	\$ 1148
72"W S6	ISLAUT2PYB7236S6	\$ 1149	\$ 1195	\$ 1240
84"W S2	ISLAUT2PYB8436S2	\$ 1266	\$ 1316	\$ 1365
84"W S7	ISLAUT2PYB8436S7	\$ 1358	\$ 1412	\$ 1465
90"W S3	ISLAUT2PYB9036S3	\$ 1462	\$ 1520	\$ 1578

<p>How to specify — Select the Model Number from above.</p>	<p>1st Option: FSC Certified Wood: F FSC Certified X No FSC</p>	<p>2nd Option: Laminate (if applicable): See page 92 for finishes.</p>	<p>3rd Option: Edgeband (if applicable): See page 92 for finishes.</p>
<p>Example: ISLAUT1PYB4836S2.LM16.E9</p>			

For specification information see pages 93-95.

GSA SIN 33721

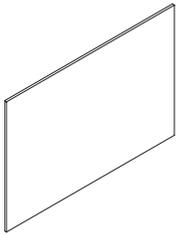

Description	Model	L1 List Price	L2 List Price	L3 List Price
42"H Storage Island Septum/Back: For use with Align Storage				
48"W S2	ISLAAB2P4842S2	\$ 682	\$ 710	\$ 736
48"W S4	ISLAAB2P4842S4	\$ 682	\$ 710	\$ 736
60"W S5	ISLAAB2P6042S5	\$ 734	\$ 764	\$ 792
72"W S3	ISLAAB2P7242S3	\$ 788	\$ 819	\$ 850
72"W S6	ISLAAB2P7242S6	\$ 847	\$ 880	\$ 914
84"W S7	ISLAAB2P8442S7	\$ 912	\$ 949	\$ 984

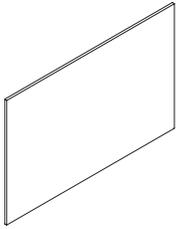

40"H Storage Island Septum/Back: For use with Essential Storage				
60"W S2	ISLAEB2P6040S2	\$ 734	\$ 764	\$ 792
72"W S2	ISLAEB2P7240S2	\$ 788	\$ 819	\$ 850
84"W S2	ISLAEB2P8440S2	\$ 912	\$ 949	\$ 984
90"W S3	ISLAEB2P9040S3	\$ 980	\$ 1020	\$ 1058



42"H Storage Island End Panel: For use with Align Storage				
18"D	ISLAAENB1842	\$ 455	\$ 474	\$ 492
18"D LH (Use with back)	ISLAAEYB1842L	\$ 455	\$ 474	\$ 492
18"D RH (Use with back)	ISLAAEYB1842R	\$ 455	\$ 474	\$ 492
36"D (Use with septum)	ISLAAEYB3642	\$ 635	\$ 660	\$ 685



40"H Storage Island End Panel: For use with Essential Storage				
18"D	ISLAEENB1842	\$ 455	\$ 474	\$ 492
18"D LH (Use with back)	ISLAEYB1842L	\$ 455	\$ 474	\$ 492
18"D RH (Use with back)	ISLAEYB1842R	\$ 455	\$ 474	\$ 492
36"D (Use with septum)	ISLAEYB3642	\$ 635	\$ 660	\$ 685

METAL STORAGE

<p>How to specify — Select the Model Number from above.</p>	<p><i>1st Option:</i> FSC Certified Wood: F FSC Certified X No FSC</p>	<p><i>2nd Option:</i> Laminate (if applicable): See page 92 for finishes.</p>	<p><i>3rd Option:</i> Edgeband (if applicable): See page 92 for finishes.</p>
<p>Example: ISLAAB2P4842S2.LM16.E9</p>			

For specification information see pages 93-95.

GSA SIN 33721

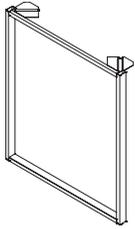

O-Leg

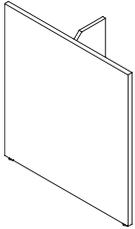

Support End Panel

Description	Model	L1 List Price	L2 List Price	L3 List Price
For use with Align Storage, 36"D x 42"H				
End Panel, Use w/supp	ISLAAESP3642	\$ 635	\$ 660	\$ 685
O-leg	ISLAAO3642	\$ 1348		
For use with Essential Storage, 36"D x 40"H				
End Panel, Use w/supp	ISLAEESP3642	\$ 635	\$ 660	\$ 685
O-leg	ISLAEO3642	\$ 1348		

<p>How to specify — Select the Model Number from above.</p>	<p><i>1st Option:</i> FSC Certified Wood: F FSC Certified X No FSC</p>	<p><i>2nd Option:</i> Laminate (if applicable): See page 92 for finishes.</p>	<p><i>3rd Option:</i> Edgeband (if applicable): See page 92 for finishes.</p>	<p><i>4th Option:</i> Paint: P1 P2 P3 See page 30 for finishes. P2 upcharge \$23 P3 upcharge \$29</p>
--	---	--	--	--

Example: ISLAAESP3642.LM16.E9



Description	Model	P1 List Price	P2 List Price	P3 List Price
For use with Essentials or Align Storage 37½"H-43½"H Post Legs — Height Adjustable for Flat/Square Edge Worksurfaces — Pair	Z6PL40HP	\$ 1078	\$ 1128	\$ 1177

<p>How to specify — Select the Model Number from above.</p>	<p><i>1st Option:</i> Paint: P1 P2 P3 See page 30 for finishes. P2 upcharge \$50 P3 upcharge \$99</p>
--	--

Example:

For specification information see pages 93-95.

GSA SIN PENDING



Description	Model	List Price
For use with open, non-supported tops		
External Worksurface Support Channel (no color option for stiffener) — 1½"H		
• You must specify external worksurface support channel when an unsupported 48"W Worksurface is specified.		
30"W for use on 42"W Worksurface	Z5SC42 <input type="checkbox"/>	\$ 86
36"W for use on 48"W Worksurface	Z5SC48 <input type="checkbox"/>	\$ 89
42"W for use on 54"W Worksurface	Z5SC54 <input type="checkbox"/>	\$ 102
48"W for use on 60"W Worksurface	Z5SC60	\$ 110
54"W for use on 66"W Worksurface	Z5SC66	\$ 128
60"W for use on 72"W Worksurface	Z5SC72	\$ 137
66"W for use on 78"W Worksurface	Z5SC78	\$ 150
72"W for use on 84"W Worksurface	Z5SC84	\$ 165
Flat Brackets (no color option)		
For 12"D	T612FB <input type="checkbox"/>	\$ 70

METAL STORAGE

How to specify —
 Select the Model Number from above.

Example: Z6PL40HP

Essentials™ Metal Storage

- Finishes 104
- Working with Essentials Metal Storage 105-110
- Essentials Metal Pedestals and Accessories..... 111-113
- Essentials Metal Lateral Files 114
- Essentials Metal Combination Files 115
- Essentials Metal Storage Cabinets..... 116
- Essentials Metal Bookcases 117

Essentials Metal Storage

PAINTED METAL FINISHES

GRADE P1

Black.....	P27
Brownstone.....	P7D
Bungalow.....	P7C
Cinder.....	P7Q
Cove.....	P096
Designer White.....	PJW
Dune.....	P094
Flint.....	P02
Fossil.....	P28
Harbor.....	P097
Loft.....	P7B
Muslin.....	P4J
Parchment.....	P93
Pebble.....	P8R
Pewter.....	P8D
Sage.....	P095
Salt.....	P8C
Titanium.....	P8T

GRADE P2

Champagne Metallic.....	PR5
Gunmetal Metallic.....	PR3
Platinum Metallic.....	PR2
Silver**.....	PR6
Solar Black.....	P8X

**PR6 no upcharge on Involve; available as a Grade P2 color on stanchions. PR6 & P8X are not available on Concensys, Essentials bookcase, and vertical files.

GRADE P3

Atom.....	P8S
Blossom***.....	P8K
Bullseye.....	PJF
Ember.....	P8P
Ion.....	P8N
Iris.....	P8J
Krypton.....	P8F
Ochre***.....	P093
Regatta.....	P8M
Sienna***.....	P092
Succulent***.....	P8A

Metallic paints, due to varying reflectance, may appear to have less visual color consistency than other paint finishes, even when LIA/B values are exactly the same. (LIA/B — measurable aspects of color — values are maintained within a specified range, to ensure consistent appearance of paint colors.)

****These colors are intended to be an inspirational option for the trending market. Product application is limited and color availability is approximately two years to coincide with evolving workplace trends.*

METAL STORAGE PULLS

Black (Bar or Arch Pull) ... E4/P71 (Radii)
Designer White (Bar pull only).....
.....PJW (Radii only)
Silver..... EL/PR6

LAMINATES

GRADE L1

SOLID COLORS

Black.....	P
Brownstone.....	LM13
Bungalow.....	LM12
Designer White.....	LDW1
Flint.....	LM16
Fossil Shale.....	LEH1
Loft.....	LM11
Muslin.....	LM15
Titanium.....	LT11

ABSTRACT

Ash.....	LT3B
Handspun Pearl.....	LAHP
Handspun Dove.....	LAHD
Handspun Slate.....	LAHS
Handspun Chestnut.....	LAHC
Silver Mesh.....	LT8D

WOODGRAIN

Belair.....	LWBA
Bourbon Cherry.....	H
Field Elm.....	LWFE
Florence Walnut.....	LFW1
Kingswood Walnut.....	LK11
Natural Maple.....	LWD
NeoWalnut.....	LNU1
Pinnacle.....	PINC
Shaker Cherry.....	LW7C

GRADE L2

Beigewood.....	LWBE
Fawn Cypress.....	LFC1
Lowell Ash.....	LLA1
Mangalore Mango.....	LMM1
Natural Recon.....	LNR1
Phantom Charcoal.....	LPC1
Phantom Ecu.....	LPE1
Portico Teak.....	LPT1
Skyline Walnut.....	LSW1
Veranda Teak.....	LVT1

GRADE L3

Natural Walnut.....	LWNW
---------------------	------

LAMINATE EDGE COLORS

Beigewood.....	DE
Belair.....	BA
Black.....	E4
Bourbon Cherry.....	H
Brownstone.....	EY
Bungalow.....	EX
Designer White.....	DW
Fawn Cypress.....	FC
Field Elm.....	FE
Flint.....	E9
Florence Walnut.....	FW
Fossil.....	EH
Kingswood Walnut.....	KI
Loft.....	EV
Lowell Ash.....	DL
Mangalore Mango.....	MM
Muslin.....	EU
Natural Maple.....	DD
Natural Recon.....	NR
Natural Walnut.....	DN
NeoWalnut.....	NU
Parchment.....	EN
Phantom Charcoal.....	PC
Phantom Ecu.....	PE
Pinnacle.....	PI
Platinum Metallic.....	EP
Plyband.....	PL
Portico Teak.....	DP
Shaker Cherry.....	DF
Skyline Walnut.....	SW
Titanium.....	TI
Veranda Teak.....	VT

[GSA Reference Page](#)

Essentials Pedestals

- File drawers can accommodate front-to-back filing on all models, and side-to-side filing on 22 $\frac{1}{2}$ "D and 28 $\frac{1}{2}$ "D models.
- Support pedestals of a maximum depth, relative to the worksurface depth, result in one panel receptacle position being inaccessible.
- 22 $\frac{1}{2}$ "D units cannot be used with 24"D Concensys® Freestanding.
- 28 $\frac{1}{2}$ "D units cannot be used with any 30"D Concensys Freestanding or any 24"D panel-hung worksurface.
- For locking specifications, see pages [332-334](#).
- Leveling capacity is 2" on 28"H pedestals.

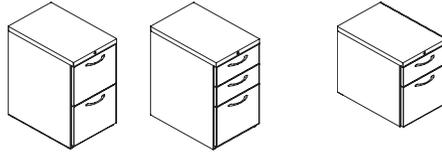

Support pedestals can support one end of a panel-attached worksurface, in lieu of other worksurface supports by using a 28"H support pedestal but cannot be used to support freestanding desking without an end panel.

Suspended pedestals mount to the underside of the worksurface using keyhole slots in top of pedestals. Do not mount suspended pedestals on bridges or peninsulas. Always mount suspended pedestals at end of worksurfaces.

When using suspended units on systems, a return panel should extend 18" minimum beyond leading edge of worksurface on which unit(s) is mounted.

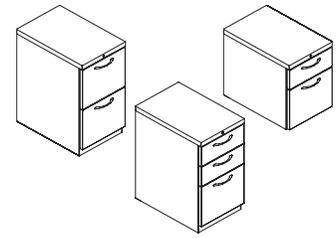

Mobile Pedestals can be used to provide flexible storage. The nominal height of a mobile pedestal is equal to that of a freestanding pedestal of equivalent design. There is no need to add extra height for the casters.

Both 26 $\frac{1}{2}$ "H and 28"H mobile pedestals can be nested under worksurfaces mounted at 29 $\frac{1}{2}$ "H. If using 28"H Essentials mobile pedestals underneath a panel mounted worksurface on Stride®, Terrace®, or Optimize™ the panel glides will need to be extended a minimum of $\frac{3}{4}$ " to allow for the mobile pedestals to slide underneath the worksurface.

Mobile pedestals cannot be leveled. Take this into consideration when planning offices which may have uneven floors.

Pedestal Compatibility with Cadence® Desking and Systems Worksurfaces

Pedestal Depth	Freestanding		Systems Panel-hung Worksurfaces	
	24" Deep	30" Deep	24" Deep	30" Deep
18"	Yes	Yes	Yes	Yes
19 $\frac{1}{2}$ "	Yes*	Yes	Yes*	Yes
22 $\frac{1}{2}$ "		Yes	Yes*	Yes
28 $\frac{1}{2}$ "				Yes*

*Wire management grommet is blocked in these applications.

Note: Pedestal placement may affect access to receptacles in base pathway.

Essentials storage pedestals are available in 5 styles:

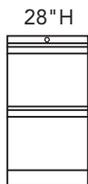

Worksurface height mobile and worksurface supporting pedestals have a taller base plate, resulting in a taller overall cabinet height. Consideration must be made to ensure that units align visually with each other and with selected Essentials lateral files. The accompanying chart will help you select the correct pedestal for your application.

Essentials Pedestal Model begins with	Style	Overall Height	Base Height	Spacer required below worksurface	Units align with these Essentials Lateral Models begin with
xx11	Seat height	22 $\frac{1}{2}$ "	2"	N/A	N/A
xx14	Suspended	19 $\frac{1}{2}$ "	N/A	N/A	N/A
xx18, xx38	Worksurface height mobile	28" **	3 $\frac{1}{4}$ "	N/A	ELF8 (2-high only)
xx19, xx39	Worksurface supporting*	28"	3 $\frac{1}{4}$ "	No	ELF8 (2-high only)

*Units will support conventional 29 $\frac{1}{2}$ " high worksurfaces.

**When using 28"H Essentials mobile pedestals underneath a panel mounted worksurface on Stride or Terrace, the panel glides need to be extended a minimum of $\frac{3}{4}$ " to allow for the mobile pedestals to slide underneath the worksurface.

Essentials™ Pedestals

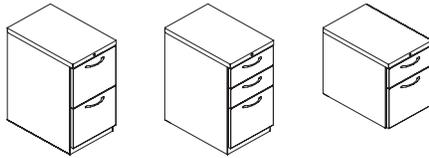

Essentials Support and Suspended Pedestals (page 111)

- Steel, ball-bearing slide suspension with full-extension on file drawers.
- File drawer has high sides to allow front-to-back filing.
- Side-to-side filing utilizes follower block and cross rail.
- Follower block (APFB80) sold separately.
- Cross rail is standard in all pedestals.
- Pencil tray included — one per pedestal with box drawers.
- For improved aesthetics on 28"H pedestals, order flush mount kick plates.
- Support units have four leveling glides.
- Counterweight is standard in mobile pedestals.
- Support pedestals not used to support a worksurface require a counterweight kit — order separately.
- Box drawers have adjustable divider.
- Caster package available to field convert support pedestals to mobile.
- Standard core removable locks.

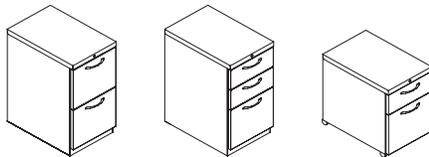

Essentials Mobile Pedestals (page 111)

- Steel, ball-bearing slide suspension with full-extension on file drawers.
- File drawer has high sides to allow front-to-back filing.
- Side-to-side filing utilizes follower block and cross rail.
- Follower block (APFB80) sold separately.
- Cross rail is standard in all pedestals.
- Pencil tray included — one per pedestal with box drawers.
- Counterweight is standard in mobile pedestals.
- Box drawers have adjustable divider.
- Rear casters swivel, front casters are fixed.
- Standard core removable locks.
- If using 28"H Essentials mobile pedestals underneath a panel mounted worksurface on Stride®, Terrace®, or Optimize™ the panel glides will need to be extended a minimum of 3/4" to allow for the mobile pedestals to slide underneath the worksurface.
- Adjustable glide kit available to field convert mobile pedestals to freestanding.
- Casters on box/file mobile pedestal require installation.
- For improved aesthetics on 28"H pedestals, order flush mount kick plates.

Essentials™ Pedestals

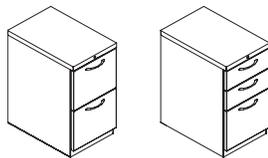
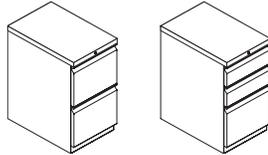
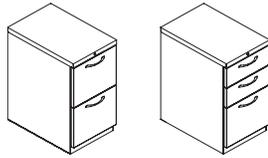

Essentials Basic Support Pedestals (page 112)

- Support pedestals have fully enclosed tops.
- Steel, ball-bearing slide suspension with full extension.
- Follower block (APFB80), pencil tray (A2280-000), and adjustable divider (PD80) for box drawers sold separately.
- Side-to-side filing utilizes two cross rails (AP519495) sold separately.
- File drawer has high sides to allow front-to-back filing.
- Support pedestals not used to support a worksurface require a counterweight kit sold separately.
- Caster package available to field convert support pedestals to mobile.
- Standard core removable locks.
- Adjustable Glide Kit available to field convert mobile pedestals to freestanding.
- For improved aesthetics on 28" H pedestals, order flush mount kick plates.

Essentials Basic Mobile Pedestals (page 112)

- Steel, ball-bearing slide suspension with full extension.
- Follower Block (APFB80), pencil tray (A2280-000), and adjustable divider (PD80) for box drawers sold separately.
- Side-to-side filing utilizes two cross rails (AP519495) sold separately.
- File drawer has high sides to allow front-to-back filing.
- Counterweight is standard in mobile pedestals.
- Support pedestals not used to support a worksurface require a counterweight kit sold separately.
- Caster package available to field convert support pedestals to mobile.
- Standard core removable locks.
- If using 28" H Essentials mobile pedestals underneath a panel mounted worksurface on Stride®, Terrace®, or Optimize™ the panel glides will need to be extended a minimum of ¼" to allow for the mobile pedestals to slide underneath the worksurface.
- Adjustable glide kit available to field convert 26½" H – 28" H mobile pedestals to freestanding.
- For improved aesthetics on 28" H pedestals, order flush mount kick plates.

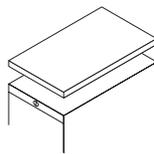

ASPT-24SC

Essentials Seat Cushion (page 113)

- Seat cushion provides quick and convenient additional seating.
- Seat cushion adds approximately 2" H to pedestal.
- YPPA prefix models have stitched corners and bumpers on bottom.
- ASPT prefix models have wrap around corners and attach with double-sided tape.
- COM yardage for seat cushion is ⅔ yard.

Dual-side Locking

Drawers and doors lock on both sides to prevent being pried open.

Interlock System

This mechanism inhibits roll-out of more than one drawer or shelf, either sequentially or simultaneously.

Fully Enclosed Bottom

Double bottoms are welded into all files for added rigidity.

Four Hex-head Leveling Glides

Leveling glides can be adjusted from outside or inside the case. Because of the hex-head design of the stem, leveling can be done even when the file is fully loaded. Range is 1".

Suspension

Telescoping, ball-bearing slides.

Core Removable Locks

Core removable lock feature allows key numbers to be easily changed in the field which facilitates installation.

Omit Lock Core

Files can be shipped with lock cores removed; cores can then be installed after files are placed. Laterals can be keyed alike with pedestals and overhead cabinets.

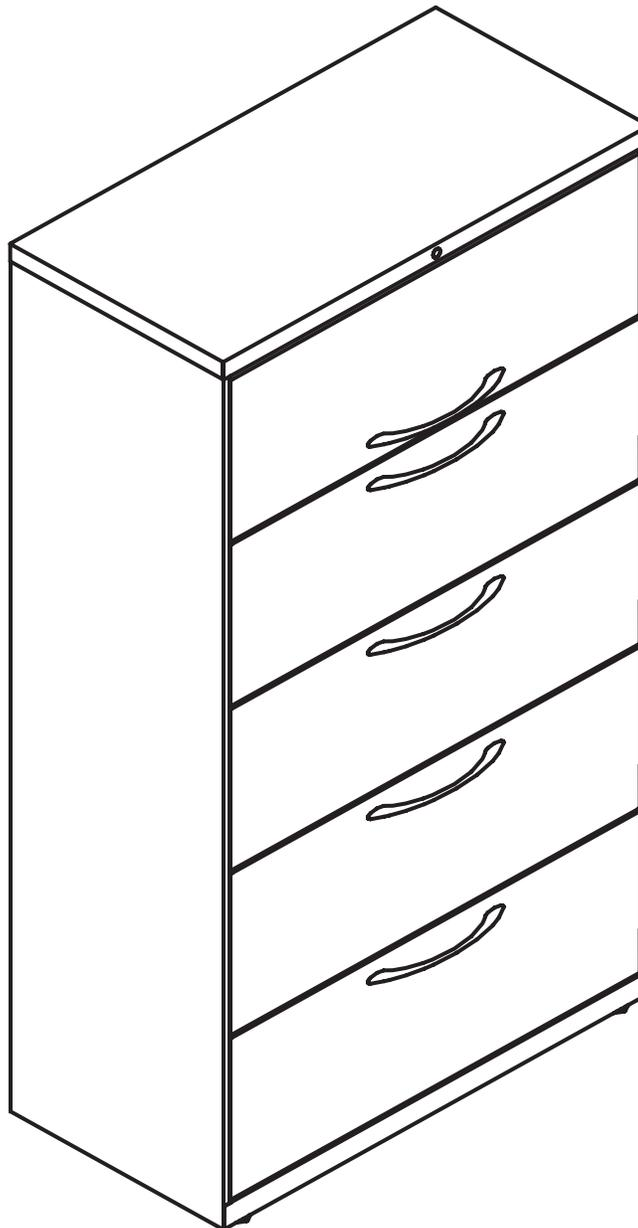

Four Pull Styles

Choice of four pull styles, also available on Essentials pedestals, allows for total design coordination on projects.

Side Knockouts

Files have knockouts on each side to allow easy ganging of freestanding units to inhibit tipping.

Inset Drawer Design

Drawers are inset inside the case. Base plate is flush with drawer fronts.

Paint Finish

Durable baked enamel finish is applied over rust-inhibiting phosphate pre-treatment.

Hanging Frames

Side-to-side come standard. Front-to-back filing option — hang rails are required.

Counterweights

Counterweights included and factory installed as required.

Drawer Interiors

Interiors and all accessories painted gray.

Essentials Lateral Files and Combination Files

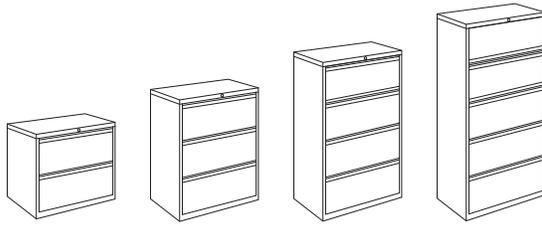

Essentials Lateral Files (page 114)

- Available in four pull options — arch, square, integral, and beveled pulls.
- Load capacities per 12" opening per current ANSI/BIFMA Standards:
 - 30"W..... 86 lbs.
 - 36"W..... 105 lbs.
 - 42"W..... 124 lbs.
- Clearance Dimensions – H x W 30 / 36 / 42" x D
 - Roll-out drawer..... 11¼" x 27⅞" / 33⅞" / 39⅞" x 16½"
 - Roll-out shelf..... 10½" x 27⅞" / 33⅞" / 39⅞" x 16½"
- For locking specifications, see pages 332-334.
- All files are 18" deep.
- Laminate and veneer tops are available — order separately.
- Support-only 2H Lateral does not include a counterweight and must be positioned under a panel-attached worksurface, ganged to an adjacent file, bracketed to a panel, or bolted to the floor or wall. It may not be used in a freestanding manner.

Note: Counterweights are included and factory installed as required except in the case of the 2H support-only lateral.

- Starting in July — Magnetic Label Holders available as an accessory model. Units will no longer include label holders.

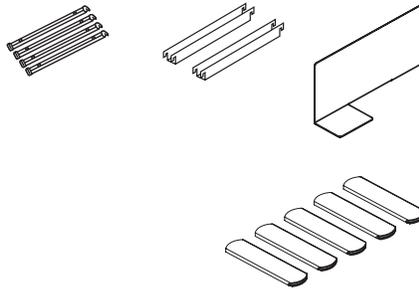

Essentials Accessories (page 114)

- All accessories are gray.
- Model L919491 used for front-to-back filing of all paper sizes in all drawer sizes except — letter in a 42"W case.

Magnetic Label Holder - Available July 2021 (page 114)

- 5 pack of magnetic label holders.

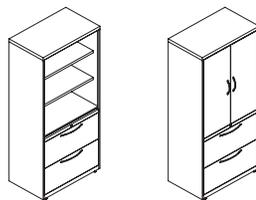

Essentials Combination Files (page 115)

- Combination cabinets match height of Essentials 5H laterals and storage cabinets.
- Combination cabinets are 30"W or 36"W and available as open shelves or hinged doors.
- Shelves are adjustable in 2" increments and are 15¼"D.
- Available in four pull styles — arch, square, integral, and beveled pulls.
- 64¼" combination cabinet has one fixed shelf and two adjustable shelves.
- Cabinets are fully assembled.
- Drawers feature three-part, telescoping, steel ball-bearing slides.
- Mechanical interlock inhibits opening more than one drawer at a time.
- For locking specifications, see pages 332-334.

Essentials Storage Cabinets and Bookcases

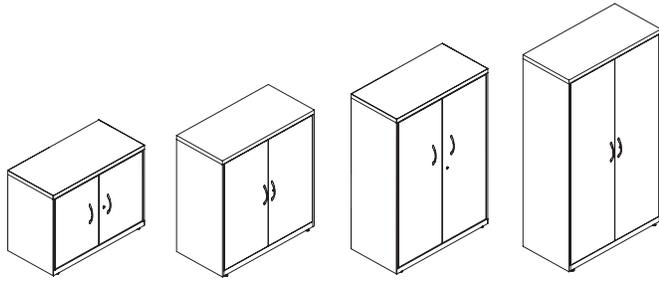

Essentials Storage Cabinets (page 116)

- Storage cabinet matches height of Essentials laterals and combination files.
- Cabinets are 30" W or 36" W and are available in four heights.
- Shelves are adjustable in 2" increments and are 15¼" D.
- Available in four pull styles — arch, square, integral, and beveled pulls.
- Storage cabinets have the following number of adjustable shelves:

27¼" H.....	1	52½" H.....	3
39¾" H.....	2	64¼" H.....	4
- Cabinets are fully assembled.
- For locking specifications, see pages 332-334.

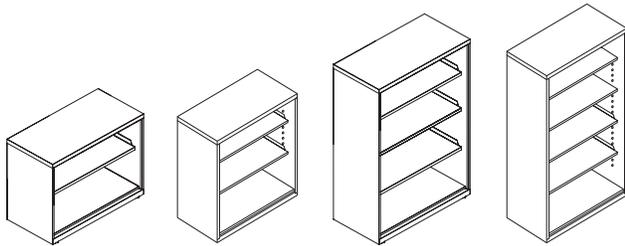

Essentials 18"D Bookcases (page 117)

- Essentials 18" D bookcases are same height as 2H, 3H, 4H, or 5H Essentials laterals and storage cabinets.
- Essentials 18" D Bookcases are 30" W or 36" W with open shelves.
- Shelves are 1" thick. Interior height 34½" H or 59" H.
- Shelves adjust in 2" increments. Shelf load capacity 107 lbs.
- 27¼" H units have 1 adjustable shelf. 39¾" H units have 2 adjustable shelves. 52½" H units have 3 adjustable shelves. 64¼" H units have 4 adjustable shelves.
- Inside shelf dimension 34½" W x 15½" D.
- Bookcases are fully assembled.
- Bookcases include leveling glides with 1" of adjustment.

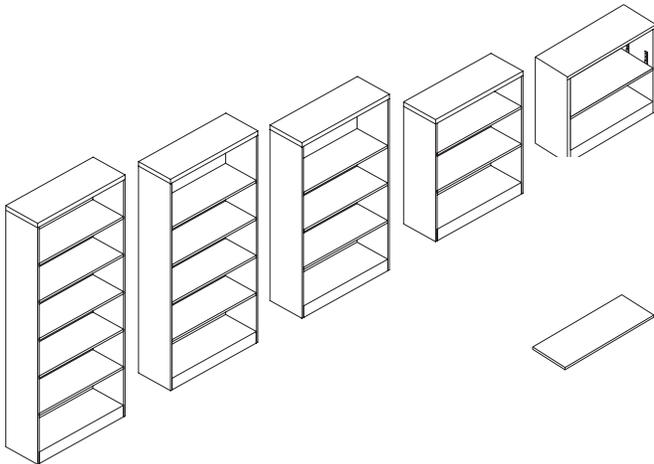

Essentials 12½"D Bookcases (page 117)

- Available in five heights from 29" to 81".
- All units case dimensions are 33⅞" W x 12⅞" D.
- Inside shelf dimension depth is 12⅞" D.
- Shelves adjust in ½" increments. Shelf load capacity 87 lbs.
- Bookcases have the following number of adjustable shelves:

29" high	1	71" high	4
41" high	2	81" high	4
59" high	3		
- Shelves are ¾" thick. Interior 4¼" less than height.
- Meets or exceeds ANSI/BIFMA and ISTA performance standards.
- Bookcases do not include leveling glides.

Essentials™ Metal Storage

Support, Suspended, and Mobile Pedestals

For specification information see pages 105-107.

Ball-Bearing Suspension

GSA SIN 33721

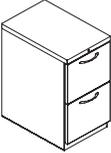
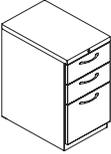
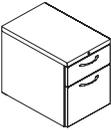
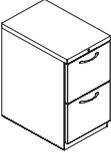
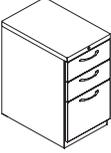
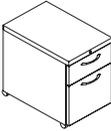
	Description	Model	P1 Paint List Price
	Support Pedestals 28"H — File/File		
	18"D x 15"W*	PF198-182 □	\$ 1211
	22½"D x 15"W	PF198-232 □	\$ 1269
	28¾"D x 15"W	PF198-302 □	\$ 1308
	Note: 28"H pedestals have a higher base plate resulting in a taller overall cabinet height. Consideration must be given to ensure that units align visually with each other and selected laterals.		
	Support Pedestals 28"H — Box/Box/File		
	18"D x 15"W*	PF197-183 □	\$ 1211
	22½"D x 15"W	PF197-233 □	\$ 1269
	28¾"D x 15"W	PF197-303 □	\$ 1308
	Suspended Pedestals 19½"H — Box/File		
	22½"D x 15"W	PH149-232 □	\$ 1060
	Mobile Pedestal 28"H — File/File		
	18"D x 15"W*	PM188-182 □	\$ 1262
	22½"D x 15"W	PM188-232 □	\$ 1316
	28¾"D x 15"W	PM188-302 □	\$ 1355
	Mobile Pedestal 28"H — Box/Box/File		
	18"D x 15"W*	PM187-183 □	\$ 1269
	22½"D x 15"W	PM187-233 □	\$ 1316
	28¾"D x 15"W	PM187-303 □	\$ 1355
	Note: 28"H pedestals have a higher base plate resulting in a taller overall cabinet height. Consideration must be given to ensure that units align visually with each other and selected laterals.		
	Mobile Pedestal 22½"H — Box/File		
	22½"D x 15"W	PM119-232 □	\$ 1077

*18"D Pedestals do not accommodate legal size filing.

<p>How to specify — Select the Model Number from above.</p>	<p>1st Option: Drawer Pull: A Arch B Beveled I Integral S Square</p>	<p>2nd Option: Paint: P1 P2 P3 See page 104 for finishes. P2 upcharge \$68 P3 upcharge \$91</p>	<p>3rd Option: Pull Color: Arch Pull EL Matte Silver E4 Black Square Pull EL Matte Silver</p>	<p>4th Option: Lock Option: STD Standard OMT Omit Lock Core (Deduct \$20)</p>
	<p>P 1 - .</p>	<p>. P .</p>	<p>. P .</p>	<p>. . . .</p>

Examples: PH149-232B.P02.STD PF197-233A.P27.EL.STD

Casegoods & Storage – 02/2024 PM187-233B.P02.STD PM187-233A.P4J.E4.STD

For specification information see pages 105-107.

GSA SIN 33721

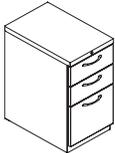
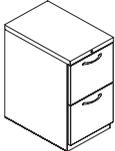
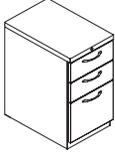
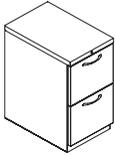

Description	Model	P1 Paint List Price
Support Pedestals 28"H — File/File		
19 7/8"D x 15"W	AF398-202 □	\$ 1095
22 7/8"D x 15"W	AF398-232 □	\$ 1133
Support Pedestals 28"H — Box/Box/File		
19 7/8"D x 15"W	AF397-203 □	\$ 1095
22 7/8"D x 15"W	AF397-233 □	\$ 1133
Mobile Pedestal 28"H — File/File		
19 7/8"D x 15"W	AM388-202 □	\$ 1114
22 7/8"D x 15"W	AM388-232 □	\$ 1157
Mobile Pedestal 28"H — Box/Box/File		
19 7/8"D x 15"W	AM387-203 □	\$ 1114
22 7/8"D x 15"W	AM387-233 □	\$ 1157

How to specify —
Select the Model Number from above.

1st Option:
Drawer Pull:

- A Arch
- B Beveled
- I Integral
- S Square

Partial top models limited to "B" Beveled pulls.

2nd Option:

Paint:

- P1
- P2
- P3

See page 104 for finishes.

P2 upcharge \$68
P3 upcharge \$91

3rd Option:

Pull Color:

- Arch Pull
- EL Matte Silver
- E4 Black

Square Pull

- EL Matte Silver

4th Option:

Lock Option:

- STD Standard
- OMT Omit Lock Core (Deduct \$20)

Examples: AF397-203B.P27.STD
AM387-203I.P27.STD

AF398-232A.P02.E4.STD
AM388-232A.P02.EL.STD

Essentials™ Metal Storage

Tops and Accessories

For specification information see pages 105-107.
(See page 336 for COM pricing on upholstery grades 13-22.)

GSA SIN 33721

Description	Model	List Price
Accessories		
Pencil Tray (Black only)	A2280-000 <input type="checkbox"/>	\$ 50
Follower Block — 1 Pack	APFB80 <input type="checkbox"/>	\$ 52
Box Drawer Divider — 2 Pack	PD80 <input type="checkbox"/>	\$ 43
Hanging File Cross Rails — 2 Pack (for side-to-side filing)	AP519495 <input type="checkbox"/>	\$ 41
Adjustable Glides — 4 Pack for 26½"H – 28"H Mobile Pedestals	AP20040AG <input type="checkbox"/>	\$ 79
Field-installable Hardware included		
Caster Package — Field Installable Four Casters (2 swivel, 2 fixed)	AP1050CST <input type="checkbox"/>	\$ 52
Counterweights for 22½"H and 26½"H Pedestals (do not specify color)	2282-300	\$ 254
Counterweights for 28"H Pedestals (do not specify color)	2282-400	\$ 278
Flush Front Kick Plate for 28"H Pedestals	ETKP28H	\$ 139

Description	Model	L1 List Price	L2 List Price	L3 List Price
Laminate Tops – Flat Edge (for mobile and freestanding pedestals)				
19½"D x 15"W x 1¼" Thick	PT17-20TTP <input type="checkbox"/>	\$ 289	\$ 302	\$ 312
22½"D x 15"W x 1¼" Thick	PT17-23TTP <input type="checkbox"/>	\$ 331	\$ 346	\$ 356
28½"D x 15"W x 1¼" Thick	PT17-29TTP <input type="checkbox"/>	\$ 389	\$ 407	\$ 419

Description	Model	List Price											
		Grade 1	Grade 2	Grade 3	Grade 4	Grade 5	Grade 6	Grade 7	Grade 8	Grade 9	Grade 10	Grade 11	Grade 12
Seat Cushion — For Metal Mobile Pedestals only (Specify seating fabric — no leathers)													
23½"D	ASPT-24SC	\$ 309	\$ 325	\$ 339	\$ 354	\$ 374	\$ 393	\$ 412	\$ 432	\$ 452	\$ 470	\$ 491	\$ 510
29½"D	ASPT-30SC	\$ 323	\$ 339	\$ 353	\$ 368	\$ 388	\$ 407	\$ 426	\$ 446	\$ 466	\$ 484	\$ 505	\$ 524
17"D	YPPA1815SC	\$ 263	\$ 279	\$ 293	\$ 308	\$ 328	\$ 347	\$ 366	\$ 386	\$ 406	\$ 424	\$ 445	\$ 464
23"D	YPPA2415SC	\$ 314	\$ 330	\$ 344	\$ 359	\$ 379	\$ 398	\$ 417	\$ 437	\$ 457	\$ 475	\$ 496	\$ 515
29"D	YPPA3015SC	\$ 329	\$ 345	\$ 359	\$ 374	\$ 394	\$ 413	\$ 432	\$ 452	\$ 472	\$ 490	\$ 511	\$ 530

ASPT- cushions have a rounded corner and the YPPA-cushions have a square corner.

<p>How to specify — Select the Model Number from above.</p>	<p>1st Option: Laminate (Tops only): See page 104 for finishes.</p>	<p>2nd Option: Edge Color (Flat and T-Mold Edge only): See page 104 for finishes.</p>	<p>3rd Option: Paint: <input type="checkbox"/> P1 <input type="checkbox"/> P2 <input type="checkbox"/> P3 Kick Plate only. See page 104 for finishes. P2 upcharge \$12 P3 upcharge \$23</p>	<p>Only Option for Seat Cushion: Upholstery: Specify seating upholstery.</p>
<p>_____ .</p>	<p>_____ .</p>	<p>_____</p>	<p>P _____ .</p>	<p>_____</p>

Examples: PT17-20TTP.TM20.E4 YPPA2415SC.CU62

Shippable by small-package carrier.

Essentials™ Metal Storage

Lateral Files

For specification information see pages 108-109.

GSA SIN 33721



Exterior Width	Model	P1 Paint List Price	P2 Paint List Price	P3 Paint List Price
28"H; two 12" drawers with hanging frames side-to-side — 2-High Support-Only Lateral (No Counterweight)				
30"W x 18"D	ELF830S □	\$ 1367	\$ 1424	\$ 1502
36"W x 18"D	ELF836S □	\$ 1520	\$ 1577	\$ 1655
42"W x 18"D	ELF842S □	\$ 1770	\$ 1827	\$ 1905

Note: 28"H worksurface supporting laterals have a taller base plate resulting in a taller overall cabinet height. Consideration must be made to ensure that units align visually within the workstation.



28"H; two 12" drawers with hanging frames side-to-side — 2-High Freestanding Lateral				
30"W x 18"D	ELF830N □	\$ 1513	\$ 1570	\$ 1648
36"W x 18"D	ELF836N □	\$ 1673	\$ 1730	\$ 1808
42"W x 18"D	ELF842N □	\$ 1939	\$ 1996	\$ 2074

Note: 28"H worksurface supporting laterals have a taller base plate resulting in a taller overall cabinet height. Consideration must be made to ensure that units align visually within the workstation.



39½"H; three 12" drawers with hanging frames side-to-side — 3-High				
30"W x 18"D	ELF330N □	\$ 1869	\$ 1926	\$ 2004
36"W x 18"D	ELF336N □	\$ 2111	\$ 2168	\$ 2246
42"W x 18"D	ELF342N □	\$ 2437	\$ 2494	\$ 2572

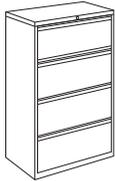

52½"H; four 12" drawers with hanging frames side-to-side — 4-High				
30"W x 18"D – No posting shelf	ELF430N □	\$ 2380	\$ 2493	\$ 2634
36"W x 18"D – No posting shelf	ELF436N □	\$ 2704	\$ 2817	\$ 2958
42"W x 18"D – No posting shelf	ELF442N □	\$ 3100	\$ 3213	\$ 3354

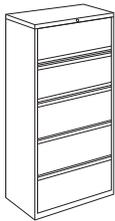

64¼"H; 12" roll-out shelf with receding door top opening, balance 12" drawers and hanging frames side-to-side — 5-High				
30"W x 18"D – No posting shelf	ELF530N □	\$ 3012	\$ 3125	\$ 3266
36"W x 18"D – No posting shelf	ELF536N □	\$ 3390	\$ 3503	\$ 3644
42"W x 18"D – No posting shelf	ELF542N □	\$ 3944	\$ 4057	\$ 4198

ESSENTIALS



Description	Model	List Price
Single-Rail Hanging File Racks (4/pack)	L919491 S	\$ 67

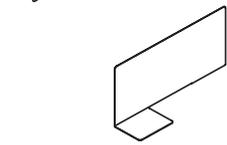

File Drawer Dividers — 2 pack	YPCAFD02 S	\$ 91
File Drawer Dividers — 10 pack	YPCAFD10 S	\$ 352

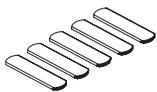

Magnetic Label Holder (5 pack)	ASISLABEL5	\$ 38
--------------------------------	------------	-------

How to specify —
Select the Model Number from above.

1st Option:
Pull
(if applicable):
A Arch
B Beveled
I Integral
S Square

2nd Option:
Paint
(if applicable):
P1 P2 P3
See page 104 for finishes.

3rd Option:
Pull Color
(if applicable):
Arch Pull
EL Matte Silver
E4 Black
Square Pull
EL Matte Silver

4th Option:
Lock Option
(if applicable):
STD Standard —
Random Keyed
OMT Omit Lock Core
(Deduct \$20 per lock)

Examples: ELF830NB.P02.STD L919491

For specification information see pages 109-110.

GSA SIN 33721

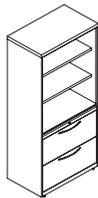

ECF536N

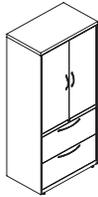

Description	Model	Number of Adj. Shelves	P1 Paint List Price
64 1/4" H Combination Files w/Open Shelves — 18"D — 5-High			
30"W	ECF530N □	2	\$ 2585
36"W	ECF536N □	2	\$ 2935
64 1/4" H Combination Files w/Hinged Doors — 18"D — 5-High			
30"W	ECF530H □	2	\$ 2824
36"W	ECF536H □	2	\$ 3207

<p>How to specify — Select the Model Number from above.</p> <p>_____ .</p>	<p>1st Option: Drawer Pull (if applicable):</p> <p>A Arch B Beveled I Integral S Square</p> <p>_____ .</p>	<p>2nd Option: Paint:</p> <p>P1 P2 P3</p> <p>See page 104 for finishes. P2 upcharge \$113 P3 upcharge \$254</p> <p>P _____ .</p>	<p>3rd Option: Pull Color (if applicable):</p> <p>Arch Pull only EL Matte Silver E4 Black</p> <p>Square Pull EL Matte Silver</p> <p>_____ .</p>	<p>4th Option: Lock Type (if applicable):</p> <p>STD Standard OMT Omit Lock Core, not available on overfile cabinets (Deduct \$20 per lock)</p> <p>_____ .</p>
---	--	--	--	--

Examples: ECF530NA.P02.EL.STD EOF3018.P27

Essentials™ Metal Storage

Storage Cabinets

For specification information see pages 109-110.

GSA SIN 33721

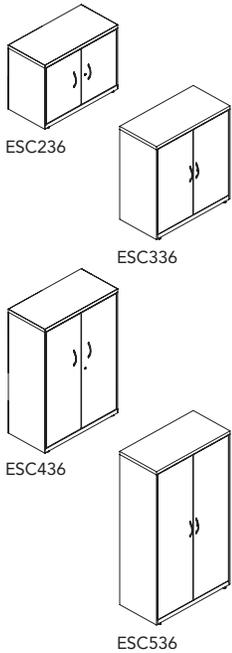

Description	Model	Number of Adj. Shelves	P1 Paint List Price	P2 Paint List Price	P3 Paint List Price
28"H Storage Cabinets					
30"W x 18"D	ESC230 □	1	\$ 1314	\$ 1371	\$ 1449
36"W x 18"D	ESC236 □	1	\$ 1462	\$ 1519	\$ 1597
39"H Storage Cabinets					
30"W x 18"D	ESC330 □	2	\$ 1574	\$ 1631	\$ 1709
36"W x 18"D	ESC336 □	2	\$ 1658	\$ 1715	\$ 1793
52½"H Storage Cabinets					
36"W x 18"D	ESC436 □	3	\$ 2036	\$ 2149	\$ 2290
64"H Storage Cabinets					
30"W x 18"D	ESC530 □	4	\$ 2205	\$ 2318	\$ 2459
36"W x 18"D	ESC536 □	4	\$ 2426	\$ 2539	\$ 2680

How to specify —
Select the Model Number from above.

1st Option:
Pull
(if applicable):
A Arch
B Beveled
I Integral
S Square

2nd Option:
Paint:
P1 P2 P3
See page 104 for finishes.

3rd Option:
Pull Color
(if applicable):
Arch Pull only
EL Matte Silver
E4 Black
Square Pull
EL Matte Silver

4th Option:
Lock Type
(if applicable):
STD Standard
OMT Omit Lock Core, not available on overfile cabinets (Deduct \$20)

_____ .

P _____ .

_____ .

Example: ESC336A.P27.E4.STD

Essentials™ Metal Storage

Bookcases

For specification information see pages 109-110.

GSA SIN 33721

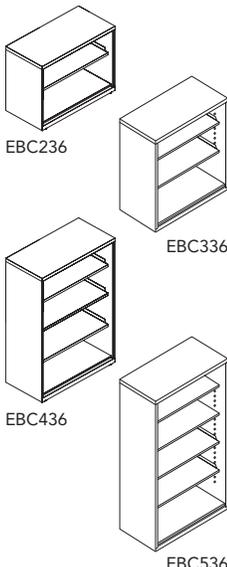

Description	Model	Number of Adj. Shelves	P1 Paint List Price	P2 Paint List Price
28"H Bookcases				
30"W x 18"D	EBC230	1	\$ 1060	\$ 1094
36"W x 18"D	EBC236	1	\$ 1192	\$ 1226
39 1/2"H Bookcases				
30"W x 18"D	EBC330	2	\$ 1138	\$ 1172
36"W x 18"D	EBC336	2	\$ 1283	\$ 1317
52 1/2"H Bookcases				
36"W x 18"D	EBC436	3	\$ 1545	\$ 1597
64 1/2"H Bookcases				
30"W x 18"D	EBC530	4	\$ 1629	\$ 1681
36"W x 18"D	EBC536	4	\$ 1844	\$ 1896

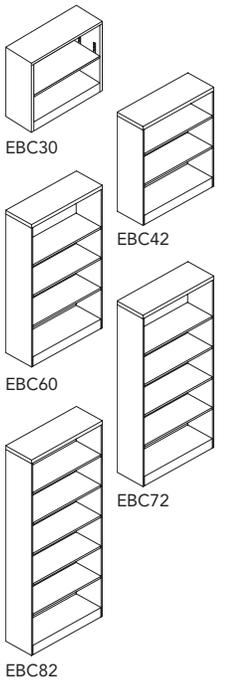

Bookcases — 34 1/2"W x 12 1/4"D				
29"H	EBC30	1	\$ 1017	\$ 1051
41"H	EBC42	2	\$ 1226	\$ 1260
59"H	EBC60	3	\$ 1517	\$ 1569
71"H	EBC72	4	\$ 1585	\$ 1637
81"H	EBC82	4	\$ 1640	\$ 1692

How to specify —
Select the Model Number from above.

1st Option:
Paint:
P1
P2
 See page 104 for finishes.

P

Examples: EBC230.P02 EBC30.P27

Notes

Vertical Metal Storage

Finishes	120
Working with Vertical Files	121
A990 / A940 Series Vertical Files.....	122

Vertical Metal Storage

PAINTED METAL FINISHES

GRADE P1

Black	P27
Brownstone	P7D
Bungalow	P7C
Cinder	P7Q
Designer White	PJW
Flint	P02
Fossil	P28
Loft	P7B
Muslin	P4J
Parchment	P93
Pebble	P8R
Pewter	P8D
Salt	P8C
Titanium	P8T

GRADE P2

Champagne Metallic	PR5
Gunmetal Metallic	PR3
Platinum Metallic	PR2

LOCKS

Black	E4
Chrome	ordered by base model
Matte Silver	EL

NOTE: Refer to individual product pages for upcharges.

Vertical Files

The A990 and A940 vertical files offer two contemporary solutions to your filing needs. Both series are built to handle the demands of today's busy office. From rugged, full-extension, ball-bearing suspensions, to reinforced frames and kickplates, these files set the standard for reliability, efficiency, and durability. Whisper-like drawer action is quiet testimony to the three-part telescoping, ball-bearing slide suspension, which generate almost effortless movement. Locks can be keyed alike (optional). See pages 332-334.

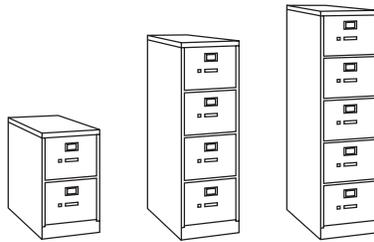

A990 Series Vertical Files (page 122)

- High capacity files with heavy-duty suspensions.
- 28½" D case depth with 27 front-to-back filing inches per drawer.
- Letter or legal sizes available.
- Three-part telescoping, ball-bearing slide suspension.
- Bright aluminum drawer pulls, label holders, and thumb latch.
- Standard interchangeable core removable locks.
- Accepts hanging files. High drawer sides hold hanging file folders without use of hangrails.
- Adjustable follower block.
- 7-point case reinforcement (6 vertical uprights, plus kickplate).
- Baked enamel finish over rust-inhibiting phosphate pre-treatment.
- Models meet or exceed ANSI/BIFMA 5.3-2012 and ISTA performance standards.

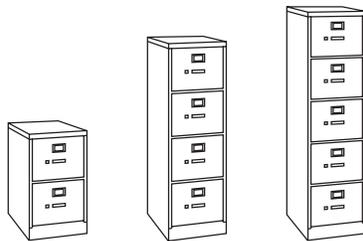

A940 Series Vertical Files (page 122)

- Files with heavy-duty suspensions.
- 26½" D case depth with 25 front-to-back filing inches per drawer.
- Letter or legal sizes available.
- Three-part telescoping, ball-bearing slide suspension.
- Bright aluminum drawer pulls, label holders, and thumb latch.
- Baked enamel finish over rust-inhibiting phosphate pre-treatment.
- Models meet or exceed ANSI/BIFMA 5.3-2012 and ISTA performance standards.
- Standard interchangeable core removable locks.
- Accepts hanging files. High drawer sides hold hanging file folders without use of hangrails.
- Adjustable follower block.
- 5-point case reinforcement (4 vertical uprights, plus kickplate).

Vertical Metal Storage

A990 / A940 Series Vertical Files

For specification information see page 121.

GSA SIN 33721

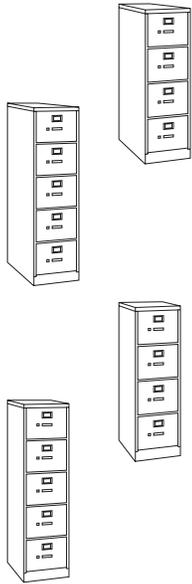

Exterior Width	Model	P1 Paint List Price	P2 Paint List Price
52"H 4 Drawer, 28½"D — A990 Series			
15"W Letter	A994 (<i>De-emphasized</i>)	\$ 1712	\$ 1780
60"H 5 Drawer, 28½"D — A990 Series			
15"W Letter	A995 (<i>De-emphasized</i>)	\$ 2282	\$ 2350
18¼"W Legal	A995C (<i>De-emphasized</i>)	\$ 2537	\$ 2605
52"H 4-Drawer, 26½"D — A940 Series			
15"W Letter	A944	\$ 1062	\$ 1130
60"H 5-Drawer, 26½"D — A940 Series			
15"W Letter	A945	\$ 1549	\$ 1617

How to specify —
Select the Model Number from above.

1st Option:
Paint:
P1 P2
See page 120 for finishes.

_____ .

P _____ .

Example: A944.P27

Shippable by small-package carrier.

Metal Overheads & Shelves

- Finishes 124
- Working with Terrace Overheads, Shelves, and Hutches.....125-128
- Overhead Cabinets, Shelves, and Up-mount Kits129-130
- Hutches, Tackboards, and Accessories 131

Metal Overheads & Shelves

PAINTED METAL FINISHES

GRADE P1

Black	P27
Brownstone	P7D
Bungalow	P7C
Cinder	P7Q
Designer White	PJW
Flint	P02
Fossil	P28
Loft	P7B
Muslin	P4J
Parchment	P93
Pebble	P8R
Pewter	P8D
Salt	P8C
Titanium	P8T

GRADE P2

Champagne Metallic	PR5
Gunmetal Metallic	PR3
Platinum Metallic	PR2
Silver**	PR6
Solar Black	P8X

**PR6 no upcharge on Involve; available as a Grade P2 color on stanchions. PR6 & P8X are not available on Concensys, Essentials bookcase, and vertical files.

GRADE P3

Atom	P8S
Blossom***	P8K
Bullseye	PJF
Ember	P8P
Ion	P8N
Iris	P8J
Krypton	P8F
Ochre***	P093
Regatta	P8M
Sienna***	P092
Succulent***	P8A

Metallic paints, due to varying reflectance, may appear to have less visual color consistency than other paint finishes, even when L/A/B values are exactly the same. (L/A/B — measurable aspects of color — values are maintained within a specified range, to ensure consistent appearance of paint colors.)

****These colors are intended to be an inspirational option for the trending market. Product application is limited and color availability is approximately two years to coincide with evolving workplace trends.*

METAL STORAGE PULLS

Black (Bar or Arch Pull)	E4/P71
Designer White (Bar pull only)	PJW
Silver	EL/PR6

PAINTED WOOD FINISHES

Brownstone	M13
Bungalow	M12
Designer White	M17
Flint	M16
Loft	M11
Muslin	M15

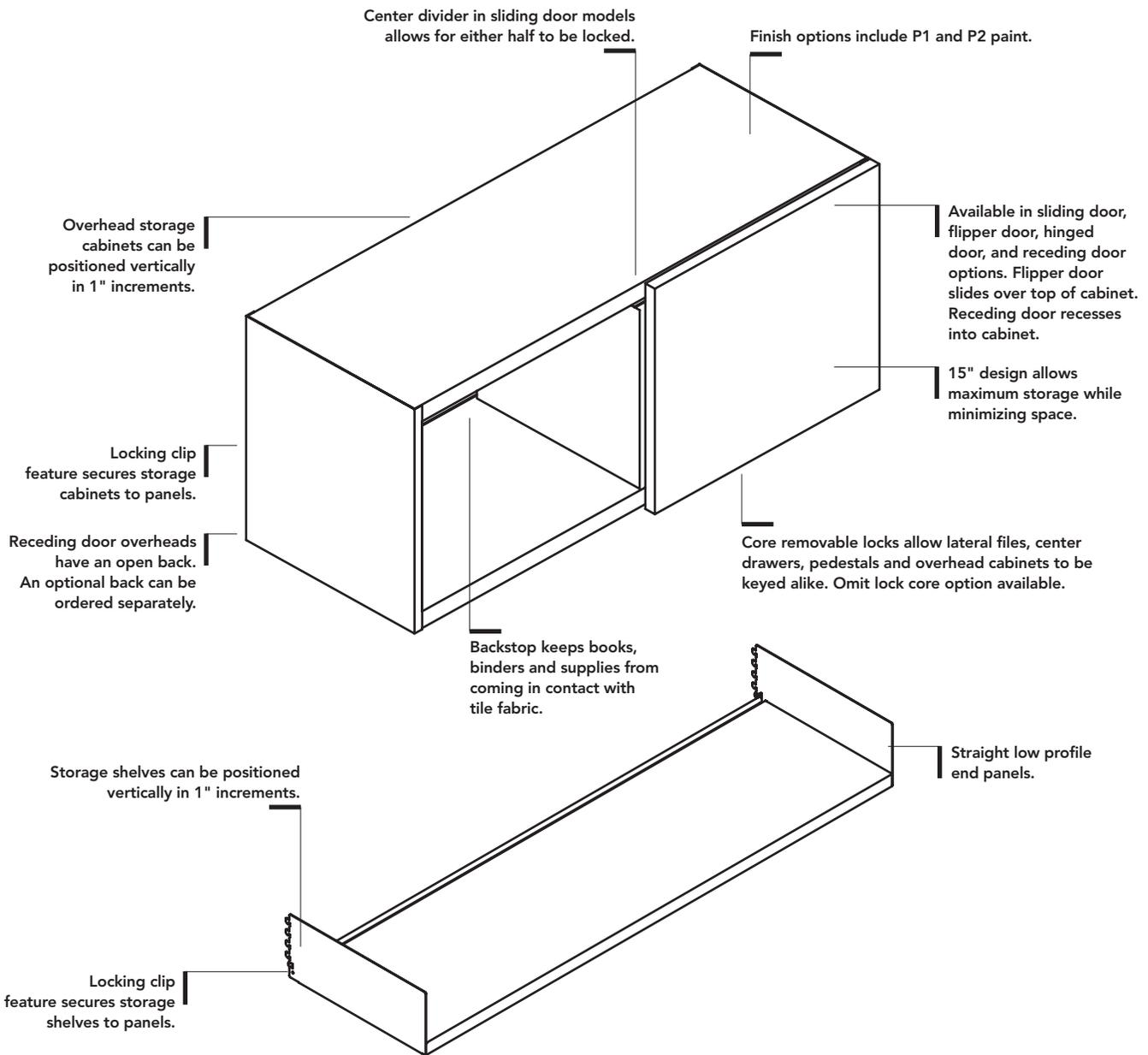

Product dimensions

Overhead Storage Cabinet

Width 24", 30", 36", 42", 48", 60"

Inside width Flipper or 24"-36" W Hinged door — 3/8" less than width
42"-48" W Hinged or Sliding door — two compartments that are half of 3/8" less than width

Depth 14 1/4" RTA models 12"

Inside depth 12 7/8" Receding door 12 1/8" RTA models 11 5/8"

Height 15"

Inside height 12 3/4" Receding door 11 5/8" RTA models 12 3/4"

Open Shelf

Width 24", 30", 36", 42", 48", 60"

Depth 12 7/8" RTA models 11 1/2"

Height 4 5/8" RTA models 5 5/8"

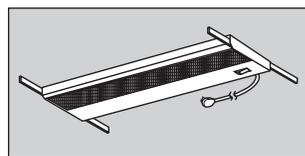

- **Task lights** can be mounted beneath storage shelves and overhead storage cabinets.
- Additional panel hung and freestanding lighting options are available.

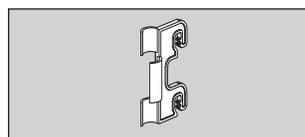

- **Cord retainer clips** fasten into panel slots to anchor power cords.
- Available in black only.
- Clips are provided with under-shelf mounted task lights. Additional clips can be purchased separately.

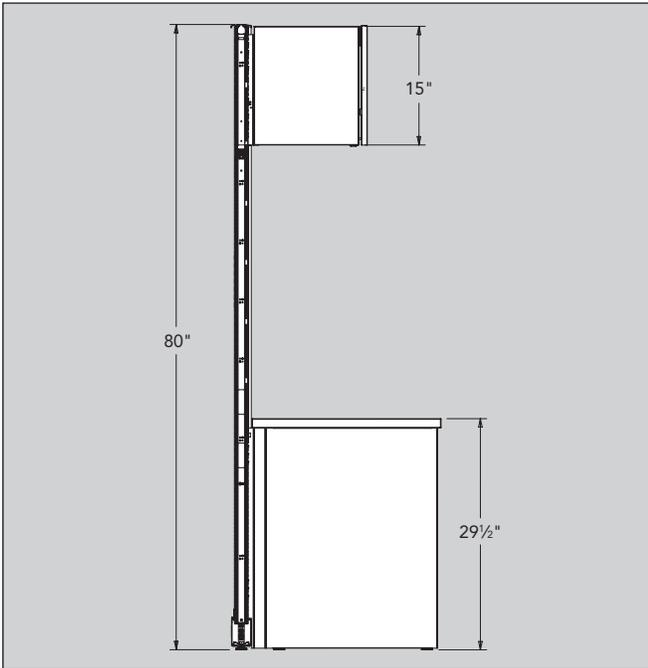
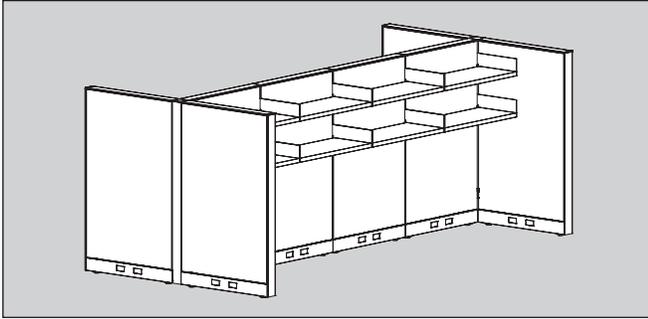

Specification Guidelines

- In a panel run, only two overhead storage cabinets or open storage shelves are recommended per panel side.
- Do not suspend more than one overhead storage unit per side from panels in a panel run which is mounted, at one or both ends, with an off-module connector kit.
- Overhead storage cabinets and open storage shelves can be mounted on Terrace structural and stacking panels to a maximum height of 80"H.
- When mounting an overhead on a 57½"H base panel frame, select the option for Z57 bracket.
- For all other base panel frame and base panel frames with stacking frames the YZ bracket should be selected.
- Base panel frames with stacking frames that have an overall height of 57½" also use the YZ bracket.

When overhead storage units are suspended from stacking frames, the following guidelines should be adhered to:

- Stacking frames should be added to all the parent run panels, and to, at least the first panel of each return-panel run. Stacking panels added to return panel must match the parent run configuration.
- A maximum of two overhead storage units should be suspended from each side of stacking frames on any given panel.
- With Terrace, a full height panel end cover is required for adequate stability when using overhead storage on the end of a run, or on a return panel.

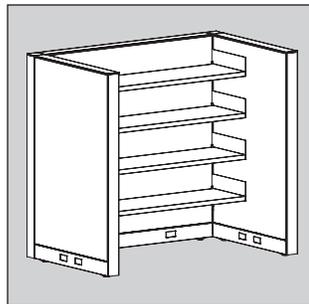

- No limitation to the number of units on structural frames when run is supported with return panels on each side of storage shelves or overhead storage cabinets.

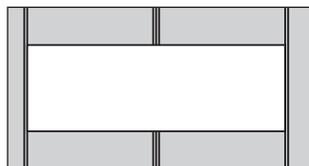

- **Storage shelf, receding door overhead, RTA overhead, and RTA shelf width** must correspond with width of panel(s).
- It is possible to span two panels when combined panel width equals cabinet or shelf width.

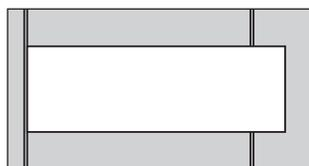

- **Terrace assembled metal overhead cabinets** can be mounted on a panel equal to or up to 18" narrower than cabinet using provided panel attachment brackets. Overhead cabinets can also be mounted on panels wider than the overhead cabinet when using off-module kit Z2MN. One side of overhead must be held on-module.

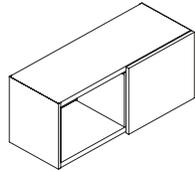

Sliding Door Overhead

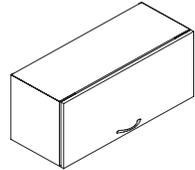

Flipper Door Overhead

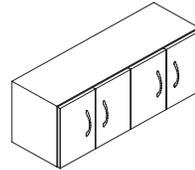

Hinged Door Overhead

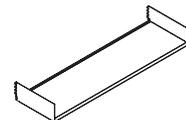

Open Shelf

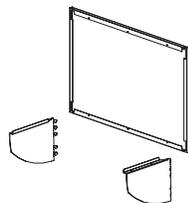

Upmount Kit for Overhead Cabinets

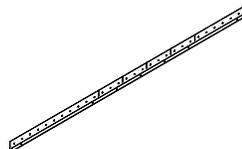

Horizontal Wall Track

Overhead Storage Cabinet (page 129)

- Steel cabinet with backstop.
- Available with sliding, hinged, or flipper door(s).
- Easy-Assist flipper door optional — requires minimal assistance in opening and closing. Not available on 60"W cabinets, specify 2–30"W cabinets with Easy-Assist.
- Self-engaging safety latch to secure cabinet to panel.
- Width can correspond with width of panel, or 2 panels joined without a connector.
- Arch or square pull optional on flipper and hinged doors.
- 60"W flipper door cabinet has 2–30"W doors with 2 independent locks.
- 24"-36"W hinged door cabinets have 1 lock and 2 optional pulls, 42"-48"W have 2 locks and 4 optional pulls.
- Accommodates recessed task lighting (specified separately).
- For locking specifications, see pages 332-334.
- Cabinets are 14¼"D x 15"H.
- 15"H cabinets can also be mounted on a panel equal to or up to 18" narrower than cabinet using provided panel attachment brackets.
- Sliding doors have a built in pull.
- Sliding, hinged, and flipper door overhead weight limits:

24"W	59 lbs.	42"W	105 lbs.
30"W	74 lbs.	48"W	121 lbs.
36"W	90 lbs.	60"W	152 lbs.
- When mounting an overhead on a 57½"H base panel frame, select the option for Z57 bracket. For all other base panel frame and base panel frames with stacking frames the YZ bracket should be selected. Base panel frames with stacking frames that have an overall height of 57½"H also use the YZ bracket.

Open Shelf (page 129)

- Metal shelf with back stop.
- Locking clips (2) standard.
- Will accommodate recessed task lighting — ordered separately.
- Weight Limits:

24"W	61 lbs.	42"W	108 lbs.
30"W	77 lbs.	48"W	124 lbs.
36"W	93 lbs.	60"W	155 lbs.

Upmount Kits for Assembled Overhead Cabinets (page 129)

- Consists of two upmount brackets, full back panel and required installation hardware.
- Allows mounting of an assembled overhead cabinet up to 15" above height of panel.
- Specify "Z2" prefix model number upmount kits with 15"H, 30"H, 35"H, 50"H, or 65"H frames; and "Z4" prefix model numbers for use with 22½"H, 42½"H, or 57½"H frames.
- Brackets require a clearance of 6½" below bottom of overhead cabinet.
- Width must correspond with width of panel frame or 2 panel frames joined directly in-line.
- Full back panel adds ½" to depth of overhead case. Full back panel only used when upmounting cabinet.
- Cannot be used with RTA models.

Horizontal Wall Track (page 129)

- Allows mounting overheads on permanent wall structures only.
- Cannot be used with RTA models.
- Track is 60"W and notched at 6" intervals as a guide for field cutting.
- For use with 15"H sliding door overhead, field modification is necessary.
- Available in Black only.
- Attachment hardware not included.

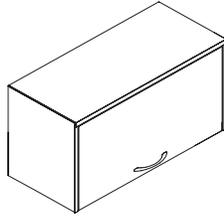

Receding Door Overhead

Receding Door Overhead Storage Cabinet (page 130)

- Steel cabinet with open back. Optional back can be ordered separately.
- Arch or Square pull optional.
- 60"W cabinet has 2 30"W doors with 2 independent locks.
- Accommodates recessed task lighting — ordered separately.
- For locking specifications, see pages 332-334.
- Cabinets are 13¼"D x 15"H. When door is recessed, interior dimensions are 12⅝"D x 11⅝"H.
- Weight Limits:

30"W	70 lbs.	48"W	110 lbs.
36"W	85 lbs.	60"W	138 lbs.
42"W	100 lbs.		

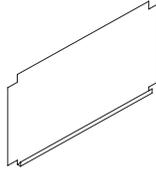

Receding Door Overhead Back

Receding Door Overhead Back (page 130)

- Optional for use with receding door overhead.
- Order width to match overhead cabinet.

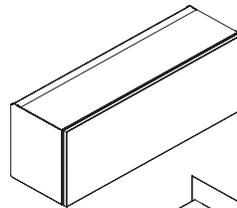

Ready to Assemble (RTA) Flipper Door Overhead (page 130)

- Steel cabinet with open back.
- 60"W and 72"W cabinets have 2 doors with independent locks.
- Accommodates recessed task lighting — ordered separately.
- Random keying, for locking specifications see pages 332-334.
- Cabinets are 12"D x 15"H. Interior dimensions 11⅝"D x 12¾"H.

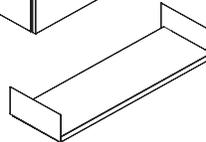

Ready to Assemble (RTA) Shelf (page 130)

- Metal shelf with locking clips.
- Accommodates recessed task lighting — ordered separately.

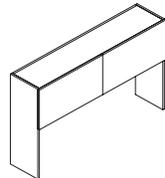

Stack-On Hutch

Stack-on Hutch (page 131)

- Have flipper doors with square horizontal edges.
- Universal model can be converted to open hutch.
- Doors are standard with a core removable lock (60"W, 66"W and 72"W have two doors and two locks.)
- Attachment tape provided.
- Order hutch to match width of worksurface(s) it covers.
- Hutches have clearance of 19¼" for computers, etc.
- Ship easy to assemble.
- Depth dimensions shown includes thickness of door.
- Universal model inside depth dimension is 12¾"
- Stack-on hutches accommodate recessed task lighting.
- For locking specification see pages 332-334.
- Chicago task light cords cannot be routed through the Hutch end panels, due to the large size of the fused plugs.

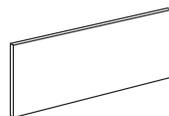

Tackboards for Hutches

Tackboards (page 131)

- Use tackboard to close the back of stack-on or hutch below storage unit.
- Due to width of fabric roll, 72"W tackboards are available in railroad cut only.
- Back of tackboard is painted steel, a finished surface.

Metal Overheads

Terrace® — Overheads / Shelves and Mounting Kits

For specification information see pages 125-128.

GSA SIN 33721

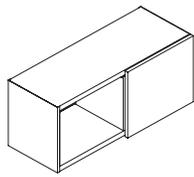

Description	Model	P1 Paint List Price	P2 Paint List Price	P3 Paint List Price
15"H x 14 1/4"D Sliding Single Door Overhead Cabinets				
24"W	OH1524SD	\$ 1041	\$ 1120	\$ 1197
30"W	OH1530SD	\$ 1064	\$ 1143	\$ 1220
36"W	OH1536SD	\$ 1116	\$ 1195	\$ 1272
42"W	OH1542SD	\$ 1166	\$ 1245	\$ 1322
48"W	OH1548SD	\$ 1219	\$ 1298	\$ 1375
60"W	OH1560SD	\$ 1609	\$ 1688	\$ 1765

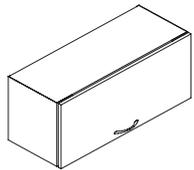

15"H x 14 1/4"D Flipper Door Overhead Cabinets				
24"W	OH1524FD	\$ 1041	\$ 1120	\$ 1197
30"W	OH1530FD	\$ 1064	\$ 1143	\$ 1220
36"W	OH1536FD	\$ 1116	\$ 1195	\$ 1272
42"W	OH1542FD	\$ 1166	\$ 1245	\$ 1322
48"W	OH1548FD	\$ 1219	\$ 1298	\$ 1375
60"W	OH1560FD	\$ 1609	\$ 1688	\$ 1765

Note: Add suffix **A** for arch pull or **S** for square pull to model number — add \$42 per pull.
For "Easy-Assist" on 24"W-48"W change FD suffix to FE — add \$240

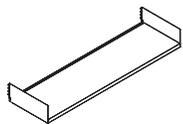

Open Shelf (to line up with 15"H Overheads) — 12 1/2"D					
24"W	ZS24	<input type="checkbox"/> S	\$ 444	\$ 472	\$ 497
30"W	ZS30	<input type="checkbox"/> S	\$ 482	\$ 510	\$ 535
36"W	ZS36	<input type="checkbox"/> S	\$ 508	\$ 536	\$ 561
42"W	ZS42	<input type="checkbox"/> S	\$ 532	\$ 560	\$ 585
48"W	ZS48	<input type="checkbox"/> S	\$ 558	\$ 586	\$ 611
60"W	ZS60		\$ 679	\$ 707	\$ 732

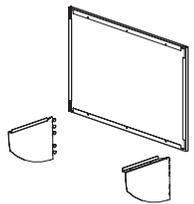

Upmount Kits for Overhead Cabinets					
Specify "Z4" prefix models with 22 1/2"H, 42 1/2"H, or 57 1/2"H frames; "Z2" prefix for other heights.					
24"W	Z <input type="checkbox"/> UP24		\$ 269	\$ 298	\$ 324
30"W	Z <input type="checkbox"/> UP30		\$ 282	\$ 311	\$ 337
36"W	Z <input type="checkbox"/> UP36		\$ 290	\$ 319	\$ 345
42"W	Z <input type="checkbox"/> UP42		\$ 305	\$ 334	\$ 360
48"W	Z <input type="checkbox"/> UP48		\$ 320	\$ 349	\$ 375
60"W	Z <input type="checkbox"/> UP60		\$ 342	\$ 371	\$ 397



Shelf Dividers					
Package of 6	T7DV	<input type="checkbox"/> S	\$ 144	\$ 162	\$ 173

Note: Not compatible with RTA models.

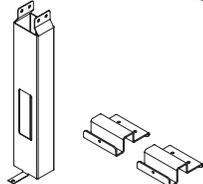

Off-Modular Overhead Bracket Kit					
Mounting Kit	Z2NM	<input type="checkbox"/> S	\$ 255	\$ 284	\$ 310

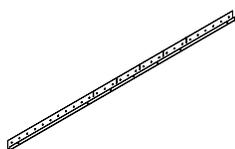

Horizontal Wall Track					
60"W Track	TWTH		\$ 135	N/A	N/A

<p>How to specify — Select the Model Number from above.</p>	<p>1st Option: Pull (if applicable):</p> <p>A Arch pull, add \$42 per pull S Square pull, add \$42 per pull</p>	<p>2nd Option: System (if applicable):</p> <p>YZ Terrace, Stride®, or Optimize™ Z57 57"H Terrace or Stride</p>	<p>3rd Option: Paint:</p> <p><input type="checkbox"/> P1 <input type="checkbox"/> P2 <input type="checkbox"/> P3 See page 124 for finishes.</p>	<p>4th Option: Pull Color (if applicable):</p> <p>Arch: E4 Black EL Matte Silver</p> <p>Square: EL Matte Silver</p>	<p>5th Option: Lock Type:</p> <p>STD Standard — Random Keyed OMT Omit Lock Core (Deduct \$20 per lock)</p>
<p>_____</p>	<p>_____ .</p>	<p>_____ .</p>	<p>P _____ .</p>	<p>E _____ .</p>	<p>_____</p>

Examples: OH1536FEA.YZ.P01.E4.STD OH1548FDS.YZ.P27.EL.OMT

Shippable by small-package carrier.

Metal Overheads

Terrace® — Overheads

For specification information see pages 125-128.

GSA SIN 33721

METAL OVERHEADS & SHELVES

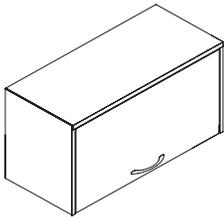

Description	Model	P1 Paint List Price	P2 Paint List Price	P3 Paint List Price
15"H x 13½"D Receding Door Overheads (Inside dimensions with door recessed — 11½"H x 12½"D)				
30"W	OH1530RD	\$ 1221	\$ 1300	\$ 1377
36"W	OH1536RD	\$ 1288	\$ 1367	\$ 1444
42"W	OH1542RD	\$ 1368	\$ 1447	\$ 1524
48"W	OH1548RD	\$ 1483	\$ 1562	\$ 1639
60"W	OH1560RD	\$ 2243	\$ 2322	\$ 2399

Note: Add Suffix **A** for arch pull or **S** for square pull option — add \$42 per pull.

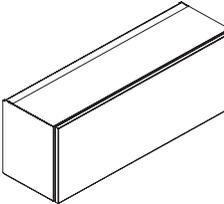

15"H x 12"D Ready to Assemble (RTA) Flipper Door Overhead (Inside dimensions 12¼"H x 11½"D)				
36"W RTA — Flipper Door	POHRTA1536FD	\$ 875	\$ 954	\$ 1031
42"W RTA — Flipper Door	POHRTA1542FD	\$ 914	\$ 993	\$ 1070
48"W RTA — Flipper Door	POHRTA1548FD	\$ 953	\$ 1032	\$ 1109

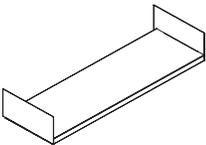

5½"H x 12"D Ready to Assemble (RTA) Shelf				
36"W RTA — Shelf	POHRTA36S	\$ 456	\$ 483	\$ 506
48"W RTA — Shelf	POHRTA48S	\$ 501	\$ 528	\$ 551

<p>How to specify — Select the Model Number from above.</p> <p>_____</p> <p>_____</p>	<p>1st Option: Receding Door Pull (if applicable): A Arch Pull, add \$42 per pull S Square Pull, add \$42 per pull</p> <p>_____ .</p>	<p>2nd Option: System for Receding Door Overhead (if applicable): YZ Terrace, Stride®, Optimize™, or Concensys® Z57 57½"H Stride or Terrace</p> <p>_____ .</p>	<p>3rd Option: Paint: P1 P2 P3 See page 124 for finishes.</p> <p>P _____</p>	<p>4th Option: Receding Door Pull Color (if applicable): Arch: E4 Black EL Silver Square: EL Silver</p> <p>E _____ .</p>	<p>5th Option: Receding Door Lock (if applicable): STD Standard OMT Omit Lock Core (Deduct \$20 per lock)</p> <p>_____</p>
--	---	--	--	--	--

Examples: OH1560RD.YZ.P7C.STD OH1536RDA.Z57.P27.E4.OMT POHRTA1536FD.P27

Metal Hutches

Terrace® — Hutches, Tackboards, and Accessories

For specification information see pages 125-128.

GSA SIN 33721

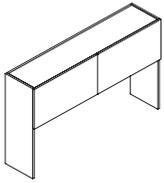

Description	Universal Hutch Model	P1 Paint List Price	P2 Paint List Price	P3 Paint List Price
Hutch w/Square Flipper Doors and Lock — 14½"D, Universal 35"H				
36"W	UH6536FD	\$ 1200	\$ 1282	\$ 1362
42"W	UH6542FD	\$ 1255	\$ 1337	\$ 1417
48"W	UH6548FD	\$ 1297	\$ 1379	\$ 1459
60"W	UH6560FD	\$ 1838	\$ 1920	\$ 2000
66"W	UH6566FD	\$ 1928	\$ 2010	\$ 2090
72"W	UH6572FD	\$ 2020	\$ 2102	\$ 2182

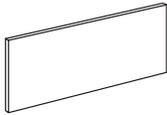

Description	Universal Hutch Model	P1 Paint List Price — Fabric			P2 Paint List Price — Fabric			P3 Paint List Price — Fabric		
		Grades A/B	Grades C/D	Grades E/F	Grades A/B	Grades C/D	Grades E/F	Grades A/B	Grades C/D	Grades E/F
20"H Tackboards for Stack-on Hutches										
36"W Tackboard	UHTB36	\$ 540	\$ 637	\$ 798	\$ 567	\$ 664	\$ 825	\$ 590	\$ 687	\$ 848
42"W Tackboard	UHTB42	\$ 567	\$ 669	\$ 837	\$ 594	\$ 696	\$ 864	\$ 617	\$ 719	\$ 887
48"W Tackboard	UHTB48	\$ 618	\$ 734	\$ 924	\$ 645	\$ 761	\$ 951	\$ 668	\$ 784	\$ 974
60"W Tackboard	UHTB60	\$ 692	\$ 837	\$ 1077	\$ 719	\$ 864	\$ 1104	\$ 742	\$ 887	\$ 1127
66"W Tackboard	UHTB66	\$ 728	\$ 886	\$ 1149	\$ 755	\$ 913	\$ 1176	\$ 778	\$ 936	\$ 1199
72"W Tackboard	UHTB72	\$ 767	\$ 924	\$ 1184	\$ 794	\$ 951	\$ 1211	\$ 817	\$ 974	\$ 1234



Description	Model	P1 Paint List Price	P2 Paint List Price	P3 Paint List Price
Shelf Dividers				
Package of 6	T7DV	\$ 144	\$ 162	\$ 173

Note: Not compatible with RTA models.

METAL OVERHEADS & SHELVES

<p>How to specify — Select the Model Number from above.</p>	<p>1st Option: Pull (if applicable): Add \$42 per pull. A Arch Pull S Square Pull</p>	<p>2nd Option: Paint: P1 P2 P3 See page 124 for finishes.</p>	<p>3rd Option: Fabric (if applicable): See page 15 for fabrics.</p>	<p>3rd Option: Lock Type (if applicable): STD Standard — Random Keyed OMT Omit Lock Core (Deduct \$20 per lock)</p>	<p>4th Option: Railroad Cut (Tackboard only): (Only applicable to 72"W Fabric Tackboards.)</p>
_____	_____	_____	_____	_____	_____

Examples: UH6536FDA.P27.STD UHTB66.P27.CS918.RR

Shippable by small-package carrier.

Notes

METAL OVERHEADS & SHELVES

- Finishes 134
- Digital Lock Specifications..... 135
- Pedestal Functionality with Work Tools 136
- Freestanding and Mobile Pedestals 137-140
- Pedestal Functionality with Work Tools 141
- Undermount, L-Cube, and Work Tools 142-144
- Caddy..... 145
- Digital Lock Keys and Accessories 146

PAINTED METAL FINISHES

GRADE P1

Black	P71
Brownstone	P7D
Bungalow	P7C
Cinder	P7Q
Cove	P096
Designer White	PJW
Dune	P094
Flint	P02
Fossil	P28
Harbor	P097
Loft	P7B
Muslin	P4J
Parchment	P93
Pebble	P8R
Pewter	P8D
Sage	P095
Salt	P8C
Textured Designer White	PK7
Textured Flint	P7A
Titanium	P8T

GRADE P2

Champagne Metallic	PR5
Gunmetal Metallic	PR3
Silver**	PR6
Solar Black	P8X

**PR6 no upcharge on Involve; available as a Grade P2 color on stanchions. PR6 & P8X are not available on Concensys, Essentials bookcase, and vertical files.

GRADE P3

Atom	P8S
Blossom***	P8K
Bullseye	PJF
Ember	P8P
Ion	P8N
Iris	P8J
Krypton	P8F
Ochre***	P093
Regatta	P8M
Sienna***	P092
Succulent***	P8A

Metallic paints, due to varying reflectance, may appear to have less visual color consistency than other paint finishes, even when L/A/B values are exactly the same. (L/A/B — measurable aspects of color — values are maintained within a specified range, to ensure consistent appearance of paint colors.)

****These colors are intended to be an inspirational option for the trending market. Product application is limited and color availability is approximately two years to coincide with evolving workplace trends.*

METAL STORAGE PULLS

BEAM

Designer White	PJW
Silver	PR6
Pyrite	PJE
Solar Black	P8X

HALO

Designer White	PJW
Silver	PR6
Pyrite	PJE
Solar Black	P8X

BAR

Designer White	PJW
Black	P27
Silver	PR6

SQUARE

Designer White	PJW
Flint	P02
Loft	P7B
Matte Silver	EL
Pyrite	PJE
Solar Black	P8X

RADII CONSOLE—POLY LINER

Cool Grey	CGR
-----------------	-----

RADII USB

Designer White	DW
Flint	E9
Storm	STRM

LOCKS

Black	E4
Chrome	ordered by base model
Matte Silver	EL

NOTE: Refer to individual product pages for upcharges.

RADII WORKTOOLS COLOR OPTIONS

DW- Designer White
E9- Flint

RADII STORAGE

Available on Align (Pedestals, Credenzas, Towers) and Radii Products

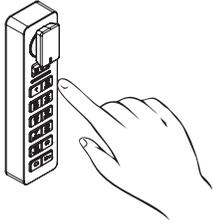

The digital keypad lock options support applications where workstations or storage banks are shared by multiple users. This is an alternative to a standard key lock. This feature facilitates the use of storage by multiple users through eliminating the need to keep and hand-off physical keys. These locks ship in “shared mode” by default; shared mode indicates that the lock will “forget” the paired 4-digit code, allowing the unit to be used by multiple users.

Digital keypad locks:

- Ship factory installed
- Offered in a polished silver finish
- Digital keypad lock requires input of a user-selected 4-digit code
- Digital keypad powered using 2 premium lithium CR2450 batteries
- Battery life is dependent on the frequency of operation but can last up to 5-7 years
- Digital keypad locks are installed horizontally on Align pedestals, credenzas, and towers

Additional information about setup and common troubleshooting problems can be found here: [Digital Lock Overview](#).

Programming Key

- A Programming Key is a device used to initialize locks out of factory default mode and register Manager Keys to the locks.
- Only one Programming Key should be specified per installation site because multiple Programming Keys are not compatible with each other.
- Once a programming key is used with a unit, it is tied to that lock. Another programming key can not be used.
- Add-on digital lock orders should be programmed with the original programming key.

Manager Key

- A Manager Key is used to bypass a locked unit; this operates as the “master” key and it is recommended that building facilitators have at least one Manager Key.
- Up to 6 Manager Keys may be registered to each lock.
- Manager Keys provide external power to locks in case of battery failure.

Description	Model	List Price
Digital Lock Keys and Accessories		
Programming Key	YPLDIGPRG	\$ 340
Manager Key	YPLDIGMGR	\$ 263

*Digital Lock users must purchase a programming key to operate. Programming keys and manager keys are purchased separately from locks.

Radii is a new generation of metal storage pedestals, undermounts, and Work Tools designed to accommodate more personal items and less paper. In the evolving digital age, the need to store paper files dwindles, people archive fewer documents, while the need to stow personal belongings grows. Conventional storage options that were designed for lateral paper filing don't adequately accommodate items employees stow, such as a backpack, purse, gym shoes, office supplies, or other everyday essentials workers want to keep within reach.

The desire for products to do more with less is quickly becoming a necessity. Radii delivers efficiency that is obvious in a solution that succinctly stows today's objects in a user-customizable way.

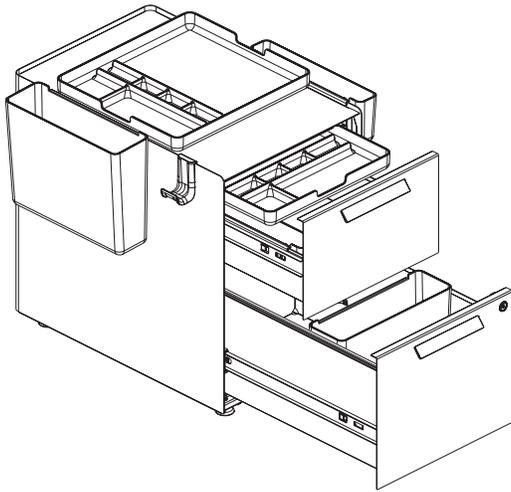

Pedestals

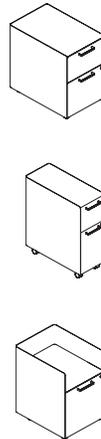

- Available with casters or glides
- Casters allow clearance for pedestal to straddle Altitude foot.
- Rear casters swivel, front casters are fixed, casters do not lock.
- Freestanding pedestals are not meant to support worksurfaces.
- Drawer slides are not full extension.
- Counterweight installed when required. No additional counterweight is required.
- Case wrapper creates a utility lip at top of case from which Work Tools can hang.
- 15"W pedestals can fit a Hot File Bin sideways in drawer to serve as a space divider.
- Hot File and Side Saddle can hang on inside file drawer lip.
- Alcove unit has a single drawer with open enclosure at top to stow backpack or other personal items.
- Drawers are labeled as "Box"/"Box +" and "File"/"File +"; see dimension table below.
- Drawers labeled as "+" have a taller drawer front and added space above the drawer body that can either accept the hidden Radii accessory tray or allow for the drawer to stow larger items, such as a backpack.
- All pedestals with a drawer marked "+" ship with one accessory tray, additional trays may be purchased separately (20³/₈"H unit does not ship with or accept hidden tray).
- Radii pedestals offered with a digital locking option
- Slim peds (10"W) with digital locking only accept Square Pull.
- Manager and programming key purchased separately, see page 24.

Pedestal Functionality Represented by
 Freestanding Pedestal 21½"H
 15"W x 23"D Box with Tray/File.
 Additional Work Tools ordered separately.

Drawer Type	Exterior Drawer Height	Accepts Tray	Filing	
			15"W Pedestal	10"W Pedestal
Box	6"	No	No	No
Box +	9"	Yes	No	No
File	12"	No	Front-to-Back Only, Letter Only	Side-to-Side Only, Letter or Legal
File +	15"	Yes	Front-to-Back Only, Letter Only	Side-to-Side Only, Letter or Legal

Drawer Type	Drawer Capacity*	
	15"W Pedestal	10"W Pedestal
Box	4¼"H x 12½"W x 17¾"D (19"D Pedestals) or 21¾"D (23"D Pedestals)	4¼"H x 7½"W x 21¾"D
Box +	7¼"H x 12½"W x 17¾"D (19"D Pedestals) or 21¾"D (23"D Pedestals)	7¼"H x 7½"W x 21¾"D
File	10¾"H x 12½"W x 17¾"D (19"D Pedestals) or 21¾"D (23"D Pedestals)	10¾"H x 7½"W x 21¾"D
File +	13⅝"H x 12½"W x 17¾"D (19"D Pedestals) or 21¾"D (23"D Pedestals)	13⅝"H x 7½"W x 21¾"D

*If using hidden tray in + drawer, subtract approximately 3" from usable height

RADI STORAGE

For specification information see page 136.

GSA SIN 33721

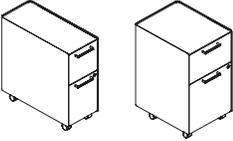
Description	Model	P1 List Price	
	Mobile Box and File + Pedestal 23½"H		
	15"W x 19"D with Tray	APMBP186NPT	\$ 1044
	15"W x 23"D with Tray	APMBP246NPT	\$ 1111
	Mobile Box + and File + Pedestal 26½"H		
	10"W x 23"D with Tray	APMCS249TPN	\$ 1113
	15"W x 19"D with Tray	APMCP189TPN	\$ 1085
	15"W x 23"D with Tray	APMCP249TPN	\$ 1130

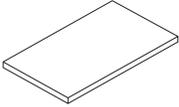
Description	Model	Base								
		List Price	2	3	4	5	6	7	8	
	Seat Cushion									
	15"W x 19"D	AESC18	\$ 255	\$ 271	\$ 285	\$ 300	\$ 320	\$ 339	\$ 358	\$ 378
	15"W x 23"D	AESC24	\$ 300	\$ 316	\$ 330	\$ 345	\$ 365	\$ 384	\$ 403	\$ 423

RADI STORAGE

<p>How to specify — Select the Model Number from above.</p>	<p><i>1st Option:</i> Pull Type (if applicable):</p> <p>M Beam O Halo B Bar S Square See matrix on page 21.</p>	<p><i>2nd Option:</i> Pull Color (if applicable):</p> <p>M Beam / O Halo P2 upcharge +\$18/pull</p> <p>PJW Designer White PR6 Silver PJE Pyrite P8X Solar Black P2 upcharge +\$18/pull</p> <p>B Bar P27 Black PJW Designer White PR6 Silver S Square PJW Designer White EL Matte Silver P02 Flint P7B Loft PJE Pyrite P8X Solar Black P2 upcharge +\$18/pull</p>	<p><i>3rd Option:</i> Paint: P1 P2 P3 See page 134 for finishes. P2 add \$46 P3 add \$91</p>
A .			P .

Continued below ▼

<p><i>4th Option:</i> Front Paint: P1 P2 P3 See page 134 for finishes. NA Match Case P1 add \$12 P2 add \$34 P3 add \$57</p>	<p><i>5th Option:</i> Tray Color: DW Designer White E9 Flint</p>	<p><i>6th Option:</i> Lock Option: STD Standard OMT Omit Lock Core (deduct \$20 per lock)</p>
P .	DW .	.

Examples: APGCS249TPN.BP27.PR6.PR6.DW.STD APMCP189TPN.BP27.PJW.PJW.DW.OMT

<p>How to specify — Select the Seat Cushion Model Number from above.</p>	<p><i>1st Option:</i> Upholstery: See page 13 for fabrics.</p>
A E S C .	.

Example: AESC18.CU10

For specification information see page 136.

GSA SIN 33721

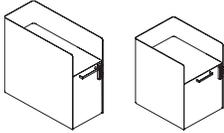
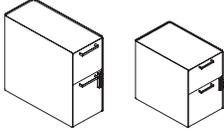
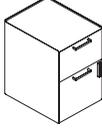
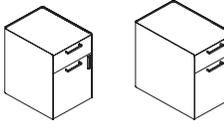
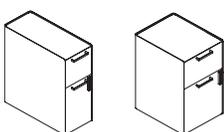
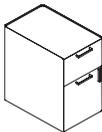
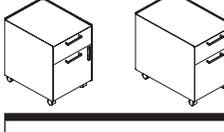
		Description	Model	P1 List Price
	Freestanding Alcove and File + Pedestal 21½"H with Digital Lock			
		10"W x 23"D with Tray	APGBS24SNPTE	\$ 951
		15"W x 19"D with Tray	APGBP18SNPTE	\$ 984
	Freestanding Box + and File Pedestal 21½"H with Digital Lock			
		10"W x 23"D with Tray	APGBS249TFNE	\$ 1015
		15"W x 19"D with Tray	APGBP189TFNE	\$ 1044
		15"W x 23"D with Tray	APGBP249TFNE	\$ 1111
				
	Freestanding Box and File + Pedestal 21½"H with Digital Lock			
		15"W x 19"D with Tray	APGBP186NPTE	\$ 1044
		15"W x 23"D with Tray	APGBP246NPTE	\$ 1111
	Freestanding Box + and File + Pedestal 24½"H with Digital Lock			
		10"W x 23"D with Tray	APGCS249TPNE	\$ 1113
		15"W x 19"D with Tray	APGCP189TPNE	\$ 1085
		15"W x 23"D with Tray	APGCP249TPNE	\$ 1130
				
	Mobile Box and File Pedestal 20¾"H with Digital Lock			
		15"W x 19"D Does not accommodate Work Tool Tray	APMAP186NFNE	\$ 973
		15"W x 23"D Does not accommodate Work Tool Tray	APMAP246NFNE	\$ 1021

RADI STORAGE

How to specify — Select the Model Number from above.	1st Option: Pull Type (if applicable): M Beam O Halo B Bar S Square See matrix on page 21.	2nd Option: Pull Color (if applicable): M Beam / O Halo PJW Designer White PR6 Silver PJE Pyrite P8X Solar Black P2 upcharge +\$18/pull	3rd Option: Paint: P1 P2 P3 See page 134 for finishes. P2 add \$46 P3 add \$91
	A P .	.	B Bar P27 Black PJW Designer White PR6 Silver S Square PJW Designer White EL Matte Silver P02 Flint P7B Loft PJE Pyrite P8X Solar Black P2 upcharge +\$18/pull

Continued below ▼

4th Option: Front Paint: P1 P2 P3 See page 134 for finishes. NA Match Case P1 add \$12 P2 add \$34 P3 add \$57 P .	5th Option: Tray Color: DW Designer White E9 Flint .	6th Option: Lock Option: EBNL Digital Lock add \$422 See page 146 for required programming key and manager key.
--	--	--

Example: APGBS24NPTE.SPR6.PDW.PDW.E9.EBNL

For specification information see page 136.

GSA SIN 33721

RADII STORAGE

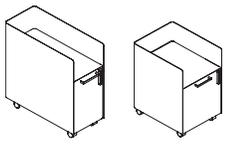
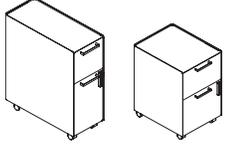
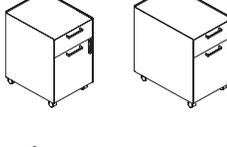
	Description	Model	P1 List Price
	Mobile Alcove/File + Pedestal 23³/₈"H with Digital Lock		
	10"W x 23"D Alcove/File with Tray	APMBS245NPTE	\$ 951
	15"W x 19"D Alcove/Tray-File	APMBP185NPTE	\$ 984
	Mobile Box + and File Pedestal 23³/₈"H with Digital Lock		
	10"W x 23"D with Tray	APMBS249TFNE	\$ 1015
	15"W x 19"D with Tray	APMBP189TFNE	\$ 1044
	15"W x 23"D with Tray	APMBP249TFNE	\$ 1111
	Mobile Box and File + Pedestal 23³/₈"H with Digital Lock		
	15"W x 19"D with Tray	APMBP186NPTE	\$ 1044
	15"W x 23"D with Tray	APMBP246NPTE	\$ 1111
	Mobile Box + and File + Pedestal 26³/₈"H with Digital Lock		
	10"W x 23"D with Tray	APMCS249TPNE	\$ 1113
	15"W x 19"D with Tray	APMCP189TPNE	\$ 1085
	15"W x 23"D with Tray	APMCP249TPNE	\$ 1130

<p>How to specify — Select the Model Number from above.</p> <p>A P .</p>	<p><i>1st Option:</i> Pull Type (if applicable):</p> <p>M Beam O Halo B Bar S Square</p> <p>See matrix on page 21.</p>	<p><i>2nd Option:</i> Pull Color (if applicable):</p> <p>M Beam / O Halo P2 upcharge +\$18/pull</p> <p>PJW Designer White PR6 Silver PJE Pyrite P8X Solar Black</p> <p>B Bar P27 Black PJW Designer White PR6 Silver</p> <p>S Square PJW Designer White EL Matte Silver P02 Flint P7B Loft PJE Pyrite P8X Solar Black P2 upcharge +\$18/pull</p>	<p><i>3rd Option:</i> Paint:</p> <p>P1 P2 P3</p> <p>See page 134 for finishes.</p> <p>P2 add \$46 P3 add \$91</p> <p>P .</p>
---	---	---	---

Continued below ▼

<p><i>4th Option:</i> Front Paint:</p> <p>P1 P2 P3</p> <p>See page 134 for finishes.</p> <p>NA Match Case P1 add \$12 P2 add \$34 P3 add \$57</p> <p>P .</p>	<p><i>5th Option:</i> Tray Color:</p> <p>DW Designer White E9 Flint</p> <p> .</p>	<p><i>6th Option:</i> Lock Option:</p> <p>EBNL Digital Lock add \$422</p> <p>See page 146 for required programming key and manager key.</p> <p> </p>
---	---	---

Example: APGBS24NPTE.SPR6.PDW.PDW.E9.EBNL

Representative Image

Space Claim

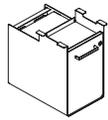

AUFD

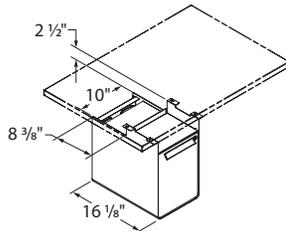

Flush Undermount
Pull-Out Drawer

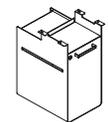

AUFH
FH HD-Flush

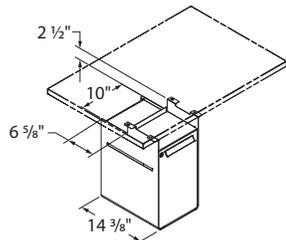

Flush Undermount
RH Hinged Door

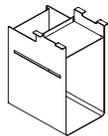

AUFO
Open-Flush

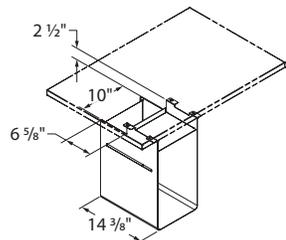

Flush Undermount
Open Bin

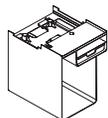

AUCL
L Shelf-Console

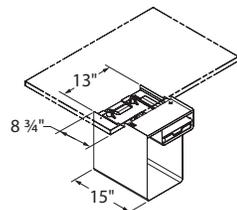

Console Undermount
Open L-Cube

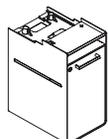

AUCH
RH HD-Console

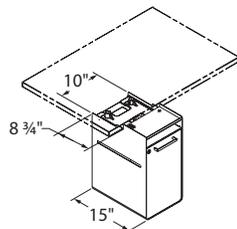

Console Undermount
RH Hinged Door Bin

Undermounts

- Undermount units are mounted inset from the left or right edge of the worksurface dependent on table supports.
- Compatible with all Allsteel benching and desking applications, except where noted.
- Can accommodate 2 Hot File units within interior sitting side-by-side.
- Slim tray fits in the Drawer and Open L units only.
- Ensure weight limit of height adjustable table system is considered before adding undermount storage (see table for unit weight and storage capacity).
- Standard BIFMA loading standards based on open volume of storage area.
- For undermount applications with Altitude tables, see the matrix on page 143.
- Manager and programming key purchased separately, see page 135.
- Radii pedestals offered with a digital locking option.
- Slim peds (10" W) with digital locking only accept Square Pull.

Flush Undermounts

- Unit to be mounted under worksurface using hardware supplied with unit.
- Unit mounts flush to front edge of worksurface.
- Open and hinged door units contain side slot which can be used to hang Work Tools.
- Open and hinged door units do not fit Work Tool Trays.
- Drawer unit ships with hangrail to accommodate side-to-side filing.

Console Undermounts

- Open L unit comes with Work Tool Tray, console soft touch pad, and bottom soft touch liner.
- Hinged Door Console Unit comes with console soft touch pad ONLY.
- Unit available with or without USB. Either version ships with soft touch pad for console and contains a perforation for easy cord routing.
- Slots built into upper portion of case for Work Tools Hook to hang from.
- Unit mounts under worksurface with easy locating interface bracket. Bracket screws to worksurface, unit snaps onto bracket.
- Unit protrudes 6" from front of worksurface.

Work Tools

- Side Saddle and Hot File work on Stride and Terrace Tool Tiles and Tool Rails.
- Bag Hook weight limit 20 lbs.

For specification information see page 136.

GSA SIN 33721

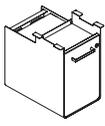
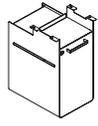
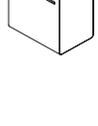
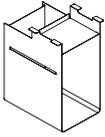
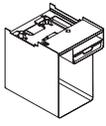
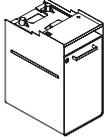
		Description	Model	P1 List Price
		Flush Undermount Pull-Out Drawer 18"H (Ships with Work Tool Tray)		
		10"W x 16½"D	AUFD15N	\$ 741
		Flush Undermount Right-Hinged Door 20"H		
		10"W x 14½"D	AUFH15N	\$ 735
		Flush Undermount Left-Hinged Door 20"H		
		10"W x 14½"D	AUFHL15N	\$ 697
		Flush Undermount Open Bin 20"H		
		10"W x 14½"D	AUFO15N	\$ 589
		Console Undermount Open L-Cube 16"H (Ships with Work Tool Tray)		
		13"W x 15"D with Non-USB Console	AUCL15N	\$ 822
		13"W x 15"D with USB Console	AUCL15U	\$ 948
		Console Undermount Right Hinged Door Bin 20"H		
		10"W x 15"D with Non-USB Console	AUCH15N	\$ 811
		10"W x 15"D with USB Console	AUCH15U	\$ 966
	Console Undermount Left Hinged Door Bin 20"H			
		10"W x 15"D with Non-USB Console	AUCHL15N	\$ 811
		10"W x 15"D with USB Console	AUCHL15U	\$ 966

Work Tools		Description	Model	List Price
		Large Tray for 15"W models		
		1½"H x 13½"W x 14½"D	AELT	\$ 84
		Small Tray for 10"W models		
		1½"H x 8½"W x 14½"D	AEST	\$ 64
		Hot File		
		9½"H x 12¼"W x 3½"D	AEHF	\$ 64
		Side Saddle		
		4"H x 12¼"W x 2½"D	AESS	\$ 53
		Bag or Coat Hook		
		3¼"H x 1½"W x 2¼"D	AECH	\$ 41

How to specify — Select the Model Number from above.	1st Option: Pull Type (if applicable): M Beam O Halo B Bar S Square See matrix on page 21.	2nd Option: Pull Color (if applicable): M Beam / O Halo P JW Designer White P R6 Silver P JE Pyrite P 8X Solar Black P2 upcharge +\$18/pull	3rd Option: Paint: P1 P2 P3 See page 134 for finishes. P2 add \$34 P3 add \$68	4th Option: Front Paint: P1 P2 P3 See page 134 for finishes. NA Match Case P1 add \$12 P2 add \$29 P3 add \$46
	A .	.	B Bar P 27 Black P JW Designer White P R6 Silver S Square P JW Designer White EL Matte Silver P 02 Flint P 7B Loft P JE Pyrite P 8X Solar Black P2 upcharge +\$18/pull	P .

Continued below ▼

5th Option: Tray and Accessories Color (if applicable): DW Designer White E9 Flint	6th Option: Console Poly Liner: PL (if applicable)	7th Option: Console Color (if applicable): CGR Cool Grey	8th Option: Lock Option: STD Standard OMT Omit Lock Core (deduct \$20)	9th Option: USB Color (if applicable): STRM Storm
.	P L	C G R .		S T R M

Examples: AUFH15N.OPR6.PJW.STD AUCL15U.PR6.DW.PLCGR.STRM AELT.DW

Model Number	Unit Weight		Storage Capacity (lb.)		Weight + Capacity (added weight to table)		Internal	
					Height	Width	Depth	
AUFD15N	25	29	54	10"	7 $\frac{1}{8}$ "	14 $\frac{1}{8}$ "		
AUFH15N	22	42	64	16 $\frac{1}{4}$ "	9 $\frac{7}{8}$ "	13 $\frac{3}{8}$ "		
AUFHL15H	22	42	64	16 $\frac{1}{4}$ "	9 $\frac{7}{8}$ "	13 $\frac{3}{8}$ "		
AUFO15N	17	42	59	16 $\frac{1}{4}$ "	9 $\frac{7}{8}$ "	13 $\frac{3}{8}$ "		
AUCL15N	22	43	65	11 $\frac{1}{8}$ "	9 $\frac{7}{8}$ "	14 $\frac{1}{4}$ "		
AUCL15U	22	43	65	11 $\frac{1}{8}$ "	9 $\frac{7}{8}$ "	14 $\frac{1}{4}$ "		
AUCH15U	25	48	73	17"	9 $\frac{7}{8}$ "	14"		
AUCH15N	25	48	73	17"	9 $\frac{7}{8}$ "	14"		
AUCL15U	25	48	73	17"	9 $\frac{7}{8}$ "	14"		
AUCL15N	25	48	73	17"	9 $\frac{7}{8}$ "	14"		

		A6 (T-Leg)		A6 (C-Leg)	
		24"D	30"D	24"D	30"D
AUFD15N	Flush Undermount Pull-Out Drawer	○	○	○	●
AUFH15N/AUFHL15N	Flush Undermount RH/LH Hinge Door	○	○	○	●
AUFO15N	Flush Undermount Open Bin	○	○	○	●
AUCL15N/AUCL15U	Console Undermount L-Cube	○	○	○	○
AUCH15N/AUCH15U	Console Undermount RH Hinge Door	○	○	○	○
AUCL15N/AUCL15U	Console Undermount LH Hinge Door	○	○	○	○

Legend

●	Works, unit may sit flush to LH or RH edge of work surface
○	Works, unit must sit inset of height-adjustable leg
X	Does not work

For specification information see page 136.

GSA SIN 33721

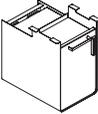
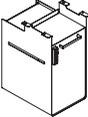
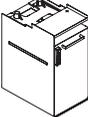
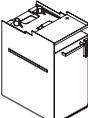
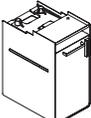
		Description	Model	P1 List Price
		Flush Undermount Pull-Out Drawer 18"H (Ships with Work Tool Tray) with Digital Lock 10"W x 16½"D	AUFD15NE	\$ 741
		Flush Undermount Right-Hinged Door 20"H with Digital Lock 10"W x 14½"D	AUFH15NE	\$ 709
		Flush Undermount Left-Hinged Door 20"H with Digital Lock 10"W x 14½"D	AUFHL15NE	\$ 697
		Console Undermount Right Hinged Door Bin 20"H with Digital Lock 10"W x 15"D, Non-USB Console 10"W x 15"D, USB Console	AUCH15NE AUCH15UE	\$ 811 \$ 966
		Console Undermount Left Hinged Door Bin 20"H with Digital Lock 10"W x 15"D, Non-USB Console 10"W x 15"D, USB Console	AUCL15NE AUCL15UE	\$ 811 \$ 966

RADI STORAGE

<p>How to specify — Select the Model Number from above.</p>	<p>1st Option: Pull Type (if applicable):</p> <p>M Beam O Halo B Bar S Square</p> <p>Slim Peds (10"W) only accept Square Pull. See matrix on page 21.</p>	<p>2nd Option: Pull Color (if applicable):</p> <p>M Beam / O Halo PJV Designer White PR6 Silver PJE Pyrite P8X Solar Black P2 upcharge +\$18/pull</p>	<p>B Bar P27 Black P JW Designer White PR6 Silver S Square P JW Designer White EL Matte Silver P02 Flint P7B Loft PJE Pyrite P8X Solar Black P2 upcharge +\$18/pull</p>	<p>3rd Option: Paint: P1 P2 P3 See page 134 for finishes. P2 add \$34 P3 add \$68</p>	<p>4th Option: Front Paint: P1 P2 P3 See page 134 for finishes. NA Match Case P1 add \$12 P2 add \$29 P3 add \$46</p>
	A .			P	P

Continued below ▼

<p>5th Option: Tray and Accessories Color (if applicable): DW Designer White E9 Flint</p>	<p>6th Option: Console Poly Liner: PL (if applicable)</p>	<p>7th Option: Console Color (if applicable): CGR Cool Grey</p>	<p>8th Option: Lock Option: EBNL Digital Lock add \$422 See page 146 for required programming key and manager key.</p>	<p>9th Option: USB Color (if applicable): STRM Storm</p>
	P L	C G R		S T R M

Example: AUCL15NE.SPR6.PDW.PDW.E9.PLCGR.EBNL

For specification information see page 136.

GSA SIN 33721

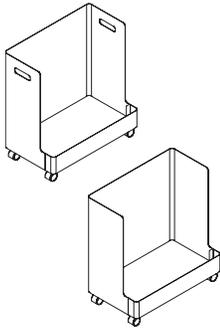

Description	Model	List Price
Radii Caddy No Shelf 22 7/8"H x 12 1/2"W x 21"D	ACMCM21O	\$ 763

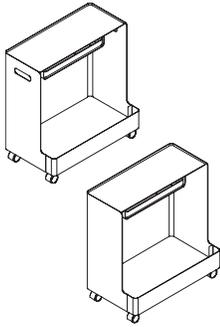

Radii Caddy with Shelf 22 7/8"H x 12 1/2"W x 21"D	ACMCM21T	\$ 914
---	----------	--------

Notes: Paint 1 for case color and Paint 2 for top and bottom shelf color
 Handle options: YHDL for handle cutout and NHDL for no handle cutout
 Radii work tools available in Designer White-DW or Flint-E9
 Casters only
 Accepts Radii work tools

RADI STORAGE

<p>How to specify — Select the Model Number from above.</p> <p>ACMCM21 .</p>	<p>1st Option: Handle: YHDL Handle Cutout NHDL No Handle Cutout</p> <p> .</p>	<p>2nd Option: Case Color (if applicable): P1 P2 See page 134 for finishes.</p> <p> .</p>	<p>3rd Option: Top and Bottom Shelf Paint: P1 P2 See page 134 for finishes.</p> <p> .</p>	<p>4th Option: Tray and Accessories Color (if applicable): DW Designer White E9 Flint</p> <p> </p>
---	--	--	--	--

Examples: ACMCM21O.YHDL.PJW.P02 ACMCM21T.NHDL.PR6.PR6.DW

For specification information see page 135.

GSA SIN PENDING



Description	Model	List Price
Digital Lock Keys and Accessories		
Programming Key	YPLDIGPRG	\$ 340
Manager Key	YPLDIGMGR	\$ 263

RADI STORAGE

How to specify —

Select the Model Number from above.

Y | P | L | | | | | | | | | |

Examples: YPLDIGPRG YPLRFID5S

Overview.....	147-172
Introduction	148
Approach Statement of Line.....	149-152
Typicals	153-158
Grain Direction	159
Features and Dimensions	160-170
Locks on Approach Storage	171
Filing Capacity	172
Finishes	173
Laminate Storage Brackets.....	174
Approach and Involve Laminate Wood Storage.....	175-176
Storage Open Plan Supports.....	177-178
Working with Approach.....	179-201
Desks.....	202-204
Pedestals.....	205-206
Credenzas.....	207-217
Storage Back Panels.....	218
Lateral Files.....	219
Bookcases.....	220
False Peds / Wall Access Panels / Bridges	221
Table Tops.....	222
Worksurfaces and Supports.....	223-226
Modesty Panels — Laminate.....	227
Towers and Wardrobes.....	228-237
Overheads and Stack on Storage	238-241
Tackboards & Writable Boards.....	242-243
Counterweights & Accessories.....	244
Altitude Height-Adjustable	245-248

A new way to optimize the private office.

Many executives spend more time outside their offices than in them. When they do touch down for focused work, they want to feel like they've reached home base. An office for the way they work. Confidential files stored securely, coffee mug in its rightful place.

Offices may be getting smaller, but they can't be less functional. Approach provides a portfolio of modular options that inspires you to rethink how the private office can be designed to address today's needs, change over time, and even serve more than one purpose.

Approach complements Allsteel's open-plan solutions for a cohesive aesthetic throughout the space.

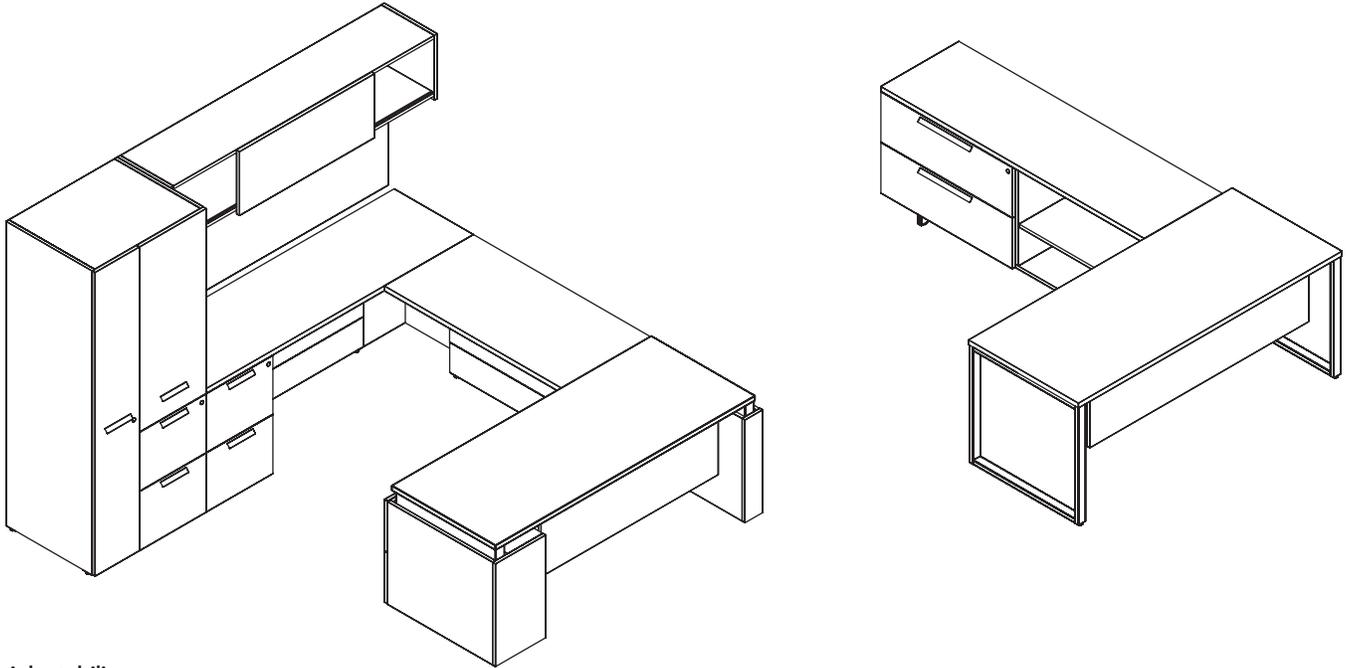

Adaptability

Two planning dimensions – 18" and 24" deep worksurfaces – allow you to design Approach to fit the space. Unique configurability options, like the ability to expand a simple "L" setup or change an "L" to a "U" setup, make it easy to efficiently use a single set of components throughout the workspace.

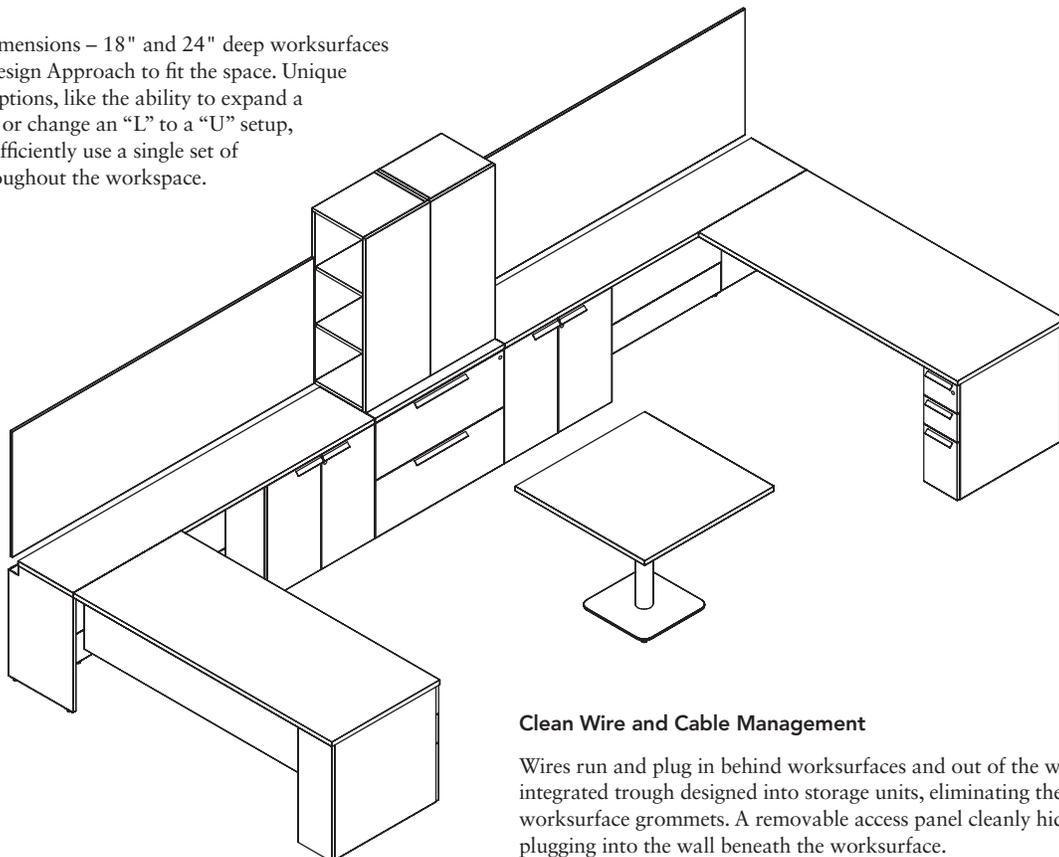

Clean Wire and Cable Management

Wires run and plug in behind worksurfaces and out of the way in an integrated trough designed into storage units, eliminating the need for worksurface grommets. A removable access panel cleanly hides cords plugging into the wall beneath the worksurface.

Approach Pre-configured Desks & Tables — height-adjustable 27 $\frac{3}{4}$ "-47 $\frac{3}{4}$ "H, fixed height 29 $\frac{1}{2}$ "H, left and right configurations

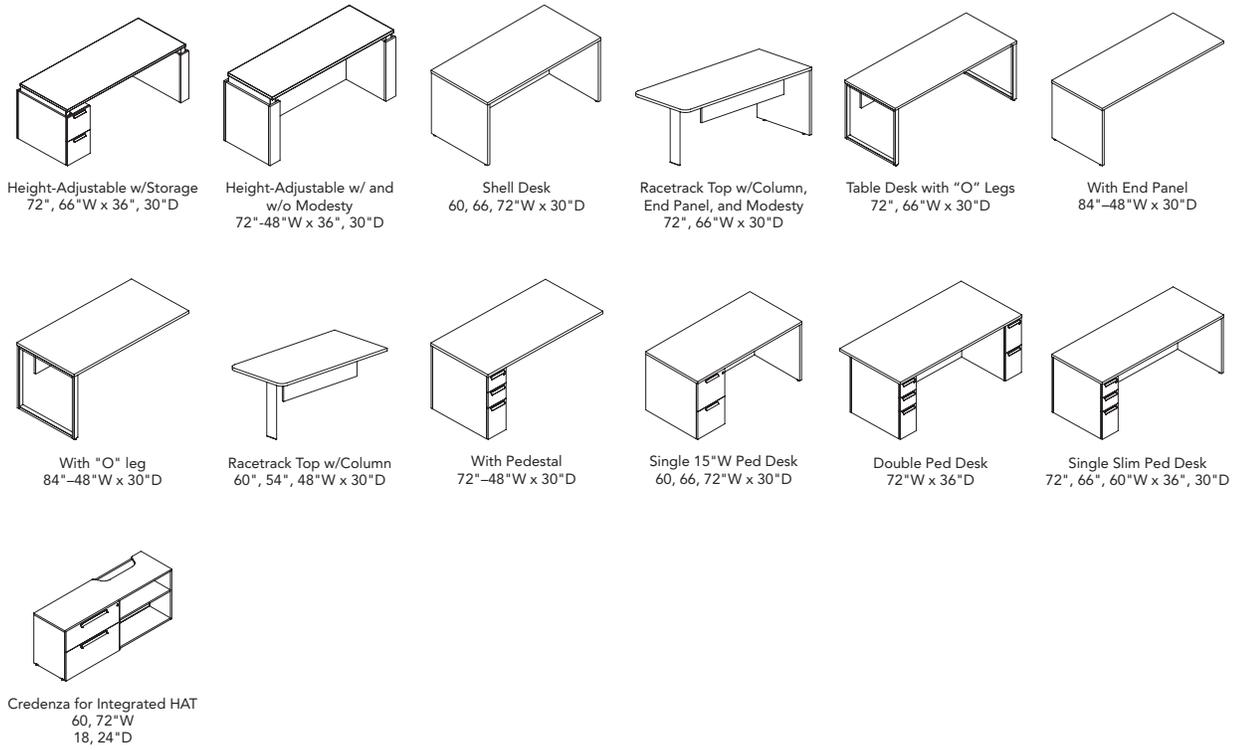

Approach Credenzas — 28"H (shown) x 18"D or 24"D, 24"H x 18"D; most available to-the-floor base or feet with or without troughs.

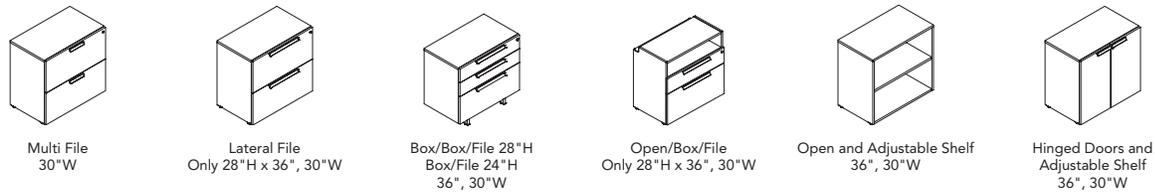

Approach 28"H Double Credenzas — 18" or 24"D, left and right configurations, available to-the-floor base or feet with or without troughs.

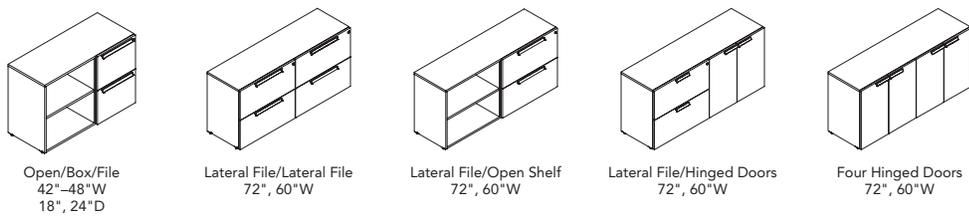

Approach 24"H Double Credenzas — 24"H x 18"D; left and right configurations, most available to-the-floor base or feet with or without troughs.

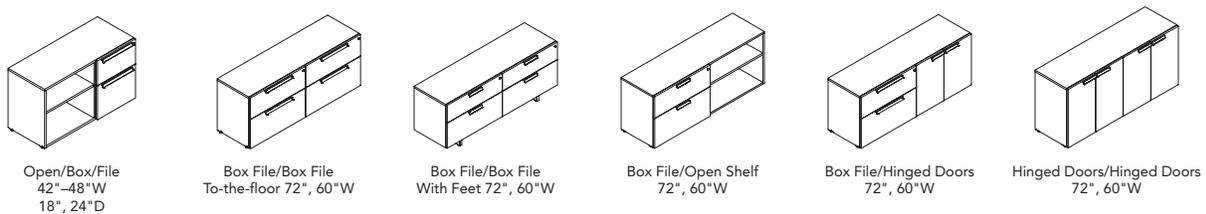

Approach Pedestals — Mobile models have recessed casters



Mobile Box/File
21½"H x 16"W x 20"D

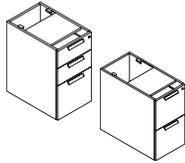

Support Pedestal
w/o Trough
28"H x 15"W
24, 30"D



Support Box/File
24"H x 18"W x 18"D

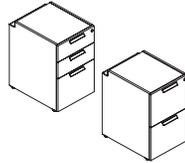

Support Box/Box/File and
File/File w/Troughs
28"H x 18"W x 18", 24"D

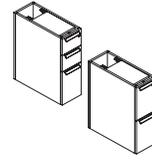

Support Slim Box/Box/File
and File/File w/Back Panel
28"H x 9½"W x 24", 30"D

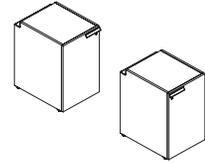

Support Left- and Right-Hand
Hinged Door w/Troughs
28"H x 18"W x 18", 24"D

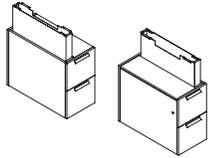

Height-Adjustable Slim
Ped & Shroud Kit
14½"W x 30"D

Approach False Peds, Wall Access Panels, Bridges, and Back Panels



Height-Adjustable Shroud Kit
Non-handed
5¼"W x 30"D
27½"-47½"H



False Ped Left/Right
28"H x 12"W x
14, 18", 24"D



Wall Access Panel
28"H x 18", 24", 30", 36",
42", 48"W

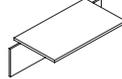

Bridge w/14"H Modesty
42", 48"W x 24"D



Back Panels 28", 24", 20"H
18", 30", 36", 60" 72"W

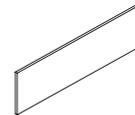

Modesty Panels
14"H x 30"-72"W

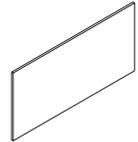

Full Height Modesty
42"-72"W

Approach Tops, Worksurfaces, and Supports — End Panels left- and right-handed



Cushion Tops for Mobile Ped
& Credenzas
16"x 20" / 30", 36"x 18"

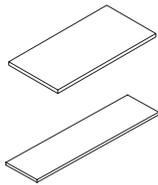

True and Shortened Depth
Laminate Tops
18"D, 24"D x 18"W-96"W

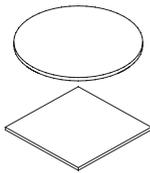

Round & Square Table Tops
36" / 42" / 48"

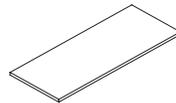

Laminate Worksurfaces
24"D, 30"D x 30"W-96"W
36"D x 72"W-84"W

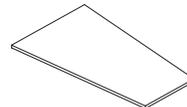

Double Sight line Wksfc.
36"-24"D x 60"-72"W
42"-30"D x 60"-72"W

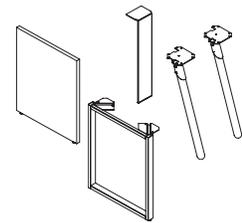

End Panels, O-Legs, Column &
Splay Leg Supports 28"H
14", 24", 30", 36"D



Stanchions & Support
Channel
3"H, 4"H x 12"D, 18"D
& 30"W-72"W

Approach Lateral Files, Bookcases, and Cubby — Laterals are 30" or 36"W x 18½"D, Bookcases are 30"W x 14¼"D, Cubby 7"H x 14"D



2-Drawer Lateral
29½"H



3-Drawer Lateral
42¼"H

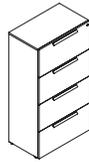

4-Drawer Lateral
56½"H

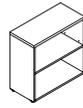

2-High Bookcase
29½"H



3-High Bookcase
42¼"H



4-High Bookcase
56½"H



5-High Bookcase
71½"H



Cubby Storage
18", 24", 30"W



8"D Floating Shelf
30"-78"

Approach Towers & Stack-On Storage — Towers 18"D, 24"D; Storage w/doors & Side Access 15"D, Open units 14½"D

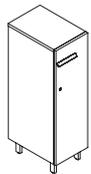

Wardrobe
42"-72"H
12", 18", 24"W
18", 24"D



Side Access
42"-72"H
18", 24"W
18", 24"D

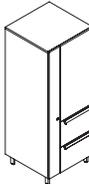

Combination
42"-72"H
18", 24"W
18", 24"D

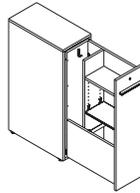

Pull Out Towers
42", 50"H
24", 30"D

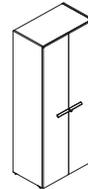

Tower w/Hinged Doors
30"W x 57½", 72"H

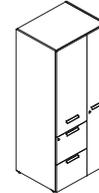

Combo Tower File/File
L- and R-Handed
30"W x 72"H

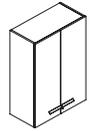

Stack-On w/Doors
18", 30", 36"W
x 29½, 42¼"H

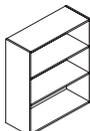

Stack-On Open
18", 30", 36"W
x 29½, 42¼"H

Approach Overhead Storage — 15½"H x 15½"D with doors, open units 15½"D

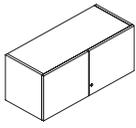

Hinged Doors
30"-78"W

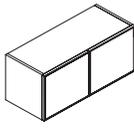

Writable Doors
30", 36", 60", 72"W

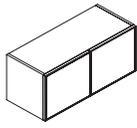

Frosted Glass Doors
30"-78"W

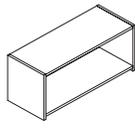

Open
30", 36"W

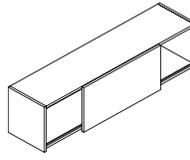

Sliding Door
48"-78"W



Overhead Mounting Kit
for Beyond Walls

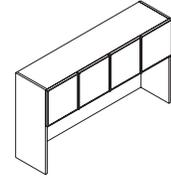

35"H Hutch
Lam. or Frosty Doors
48"-72"W

Approach Tackboards, Writable Boards, and Accessories — Tackboards and Writable Boards 30", 34", 45", 49"H

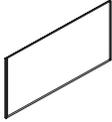

Tackboards for Hutches
48"W-72"W

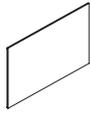

Tackboards
30"W-96"W

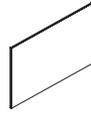

Writable Boards
30"W-96"W

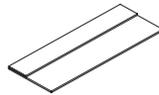

Counterweights
25, 35, 50, 60 lbs.

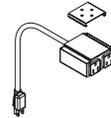

Mini Tap Power
6' Cord



End Cap

Altitude® Height-Adjustable Tops, Bases, and Accessories for Approach

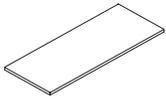

Altitude Tops
24", 30", 36"D x
48"-72"W

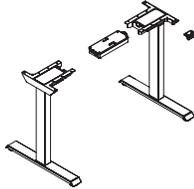

A6 T-leg Base 2-stage
22½"H-48½"H for
24"-30"D x 48"-84"W Tops

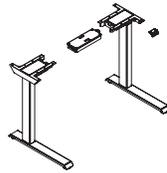

A6 C-leg Base 2-stage
27½"H-47½"H for
24"-30"D x 48"-72"W Tops

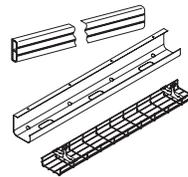

Cable Management
Channel, Tray, and Trough

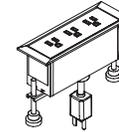

Power Modules
Power & USB

Extensions for Approach

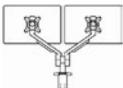

Monitor Arms
21"

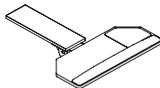

Articulating Keyboard
25"W x 10½"D



CPU Hammock
CPU 3-6"W x 16-23"H

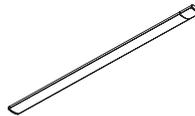

Under Cabinet LED Lights
17" & 31"

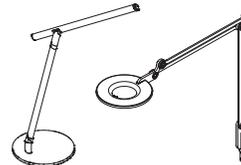

Link™ and Wand™ LED Lights
Base or Clamp

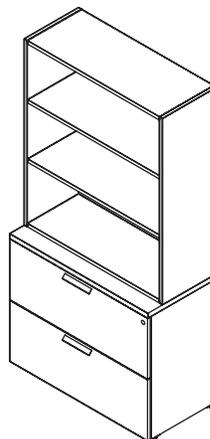
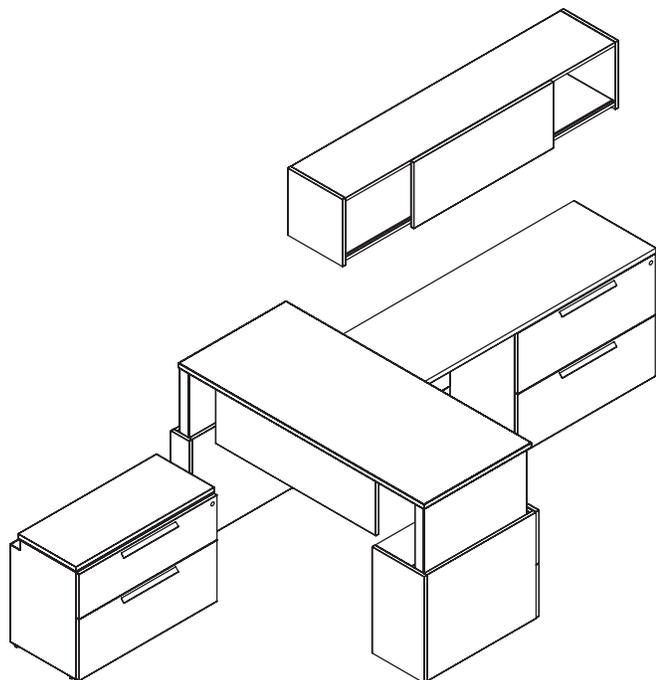

Functional Design

Sit-to-stand worksurfaces enable users to vary their posture throughout the day, while promoting wellness in the workplace. Height-adjustable legs are concealed within a shroud or pedestal storage. Smart storage, like a side-access tower, credenzas in multiple configurations at two heights, stack-ons and wall-mounted overheads with marker board fronts, and a slim pedestal, provide options for any storage need.

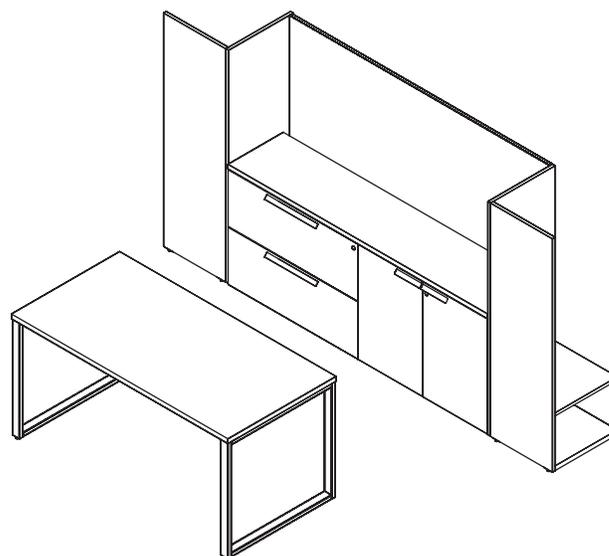
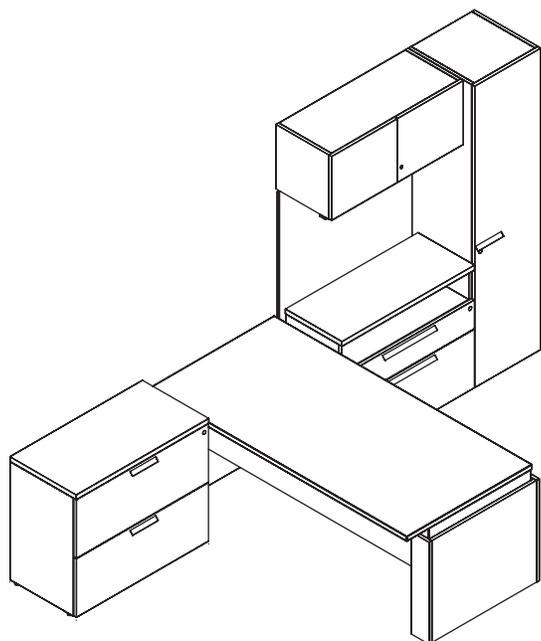
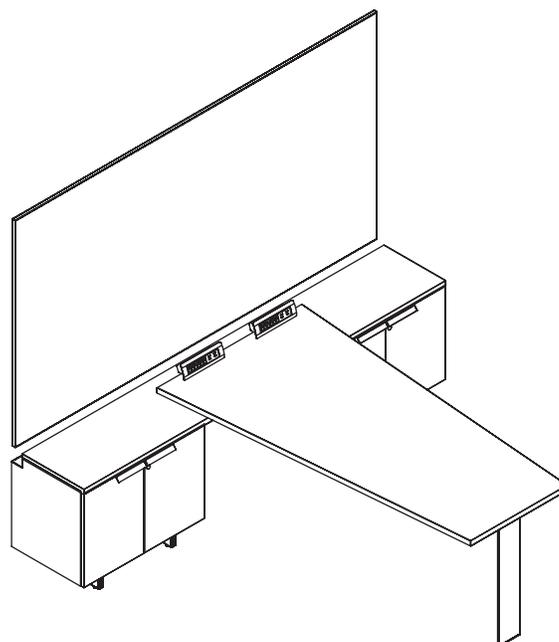

Aesthetic Choices

Approach offers a to-the-floor base or a lighter-scale footed design. Choose from eight solid and woodgrain laminate colors, numerous fabrics for tackboards and pedestal seat cushions, and five storage pull styles. Approach offers a mix of materials to support the design vision.

APPROACH

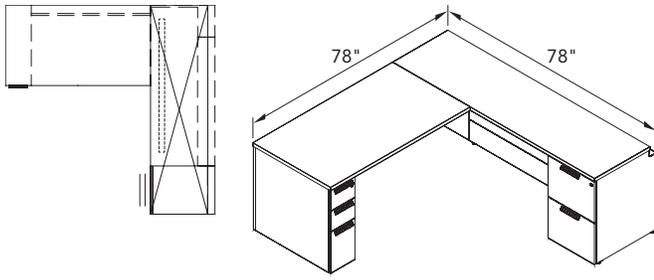

Traditional L — Desking Runoff & Ped 78" x 78"

Line Item	Product Description	Model Number	List Price
1	Desking Runoff 54"W x 30"D LH w/BBF Half Mod Panel	WKDRFN295430LH-BBF	\$ 3289
2	False Ped 12"W x 24"D LH	WKFPFN281224LH	\$ 1025
3	Wall Access Panel 28"H x 48"W Full Height	WKHP2848	\$ 1221
4	Support Ped 18"W x 24"D FF w/Trough Cut No Bk Panel	WKPSFN281824-FF	\$ 2075
5	Credenza Top 78"W x 24"D for use w/Trough	WKWSCW7824	\$ 887
6	48"W External Support Channel for 60"W Worksurface	Z5SC60	\$ 110
TOTAL			\$ 8,607

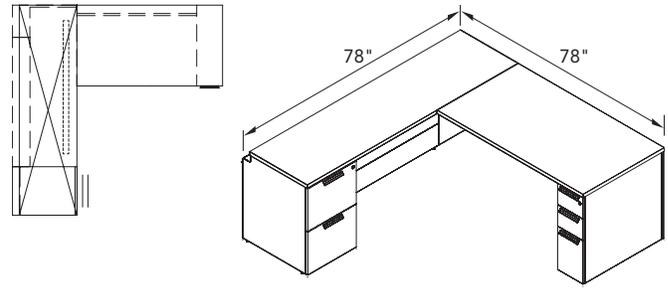

Traditional L — Desking Runoff & Ped 78" x 78"

Line Item	Product Description	Model Number	List Price
1	Desking Runoff 54"W x 30"D RH w/BBF Half Mod Panel	WKDRFN295430RH-BBF	\$ 3289
2	False Ped 12"W x 24"D RH	WKFPFN281224RH	\$ 1025
3	Wall Access Panel 28"H x 48"W Full Height	WKHP2848	\$ 1221
4	Support Ped 18"W x 24"D FF w/Trough Cut No Bk Panel	WKPSFN281824-FF	\$ 2075
5	Credenza Top 78"W x 24"D for use w/Trough	WKWSCW7824	\$ 887
6	48"W External Support Channel for 60"W Worksurface	Z5SC60	\$ 110
TOTAL			\$ 8,607

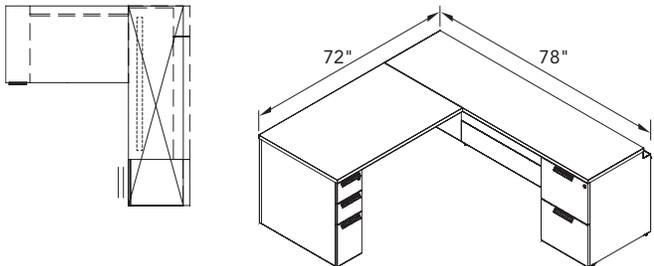

Traditional L — Desking Runoff & Ped 72" x 78"

Line Item	Product Description	Model Number	List Price
1	Desking Runoff 48"W x 30"D LH w/BBF Half Mod Panel	WKDRFN294830LH-BBF	\$ 3176
2	False Ped 12"W x 24"D LH	WKFPFN281224LH	\$ 1025
3	Wall Access Panel 28"H x 48"W Full Height	WKHP2848	\$ 1221
4	Support Ped 18"W x 24"D FF w/Trough Cut No Bk Panel	WKPSFN281824-FF	\$ 2075
5	Credenza Top 78"W x 24"D for use w/Trough	WKWSCW7824	\$ 887
6	48"W External Support Channel for 60"W Worksurface	Z5SC60	\$ 110
TOTAL			\$ 8,494

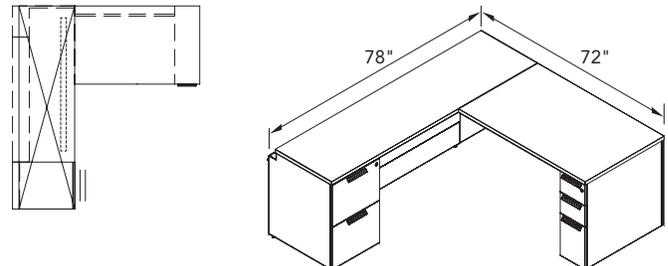

Traditional L — Desking Runoff & Ped 78" x 72"

Line Item	Product Description	Model Number	List Price
1	Desking Runoff 48"W x 30"D RH w/BBF Half Mod Panel	WKDRFN294830RH-BBF	\$ 3176
2	False Ped 12"W x 24"D RH	WKFPFN281224RH	\$ 1025
3	Wall Access Panel 28"H x 48"W Full Height	WKHP2848	\$ 1221
4	Support Ped 18"W x 24"D FF w/Trough Cut No Bk Panel	WKPSFN281824-FF	\$ 2075
5	Credenza Top 78"W x 24"D for use w/Trough	WKWSCW7824	\$ 887
6	48"W External Support Channel for 60"W Worksurface	Z5SC60	\$ 110
TOTAL			\$ 8,494

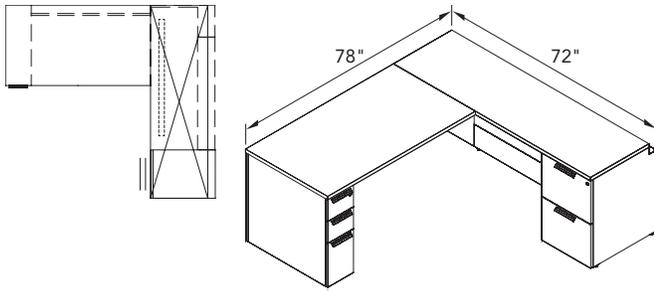

Traditional L — Desking Runoff & Ped 78" x 72"

Line Item	Product Description	Model Number	List Price
1	Desking Runoff 54"W x 30"D LH w/BBF Half Mod Panel	WKDRFN295430LH-BBF	\$ 3289
2	False Ped 12"W x 24"D LH	WKFPFN281224LH	\$ 1025
3	Wall Access Panel 28"H x 42"W Full Height	WKHP2842	\$ 1173
4	Support Ped 18"W x 24"D FF w/Trough Cut No Bk Panel	WKPSFN281824-FF	\$ 2075
5	Credenza Top 72"W x 24"D for use w/Trough	WKWSCW7224	\$ 819
6	42"W External Support Channel for 54"W Worksurface	Z5SC54	\$ 102
TOTAL			\$ 8,483

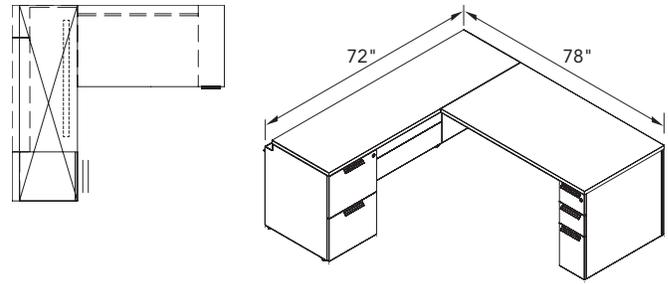

Traditional L — Desking Runoff & Ped 72" x 78"

Line Item	Product Description	Model Number	List Price
1	Desking Runoff 54"W x 30"D RH w/BBF Half Mod Panel	WKDRFN295430RH-BBF	\$ 3289
2	False Ped 12"W x 24"D RH	WKFPFN281224RH	\$ 1025
3	Wall Access Panel 28"H x 42"W Full Height	WKHP2842	\$ 1173
4	Support Ped 18"W x 24"D FF w/Trough Cut No Bk Panel	WKPSFN281824-FF	\$ 2075
5	Credenza Top 72"W x 24"D for use w/Trough	WKWSCW7224	\$ 819
6	42"W External Support Channel for 54"W Worksurface	Z5SC54	\$ 102
TOTAL			\$ 8,483

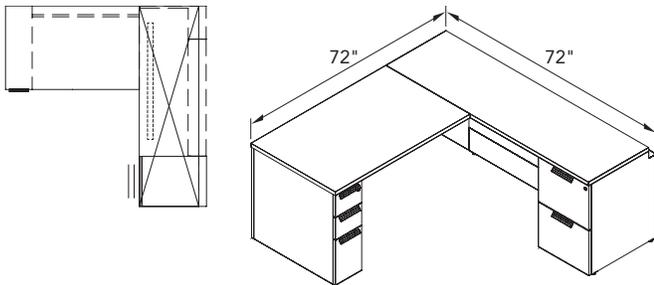

Traditional L — Desking Runoff & Ped 72" x 72"

Line Item	Product Description	Model Number	List Price
1	Desking Runoff 48"W x 30"D LH w/BBF Half Mod Panel	WKDRFN294830LH-BBF	\$ 3176
2	False Ped 12"W x 24"D LH	WKFPFN281224LH	\$ 1025
3	Wall Access Panel 28"H x 42"W Full Height	WKHP2842	\$ 1173
4	Support Ped 18"W x 24"D FF w/Trough Cut No Bk Panel	WKPSFN281824-FF	\$ 2075
5	Credenza Top 72"W x 24"D for use w/Trough	WKWSCW7224	\$ 819
6	42"W External Support Channel for 54"W Worksurface	Z5SC54	\$ 102
TOTAL			\$ 8,370

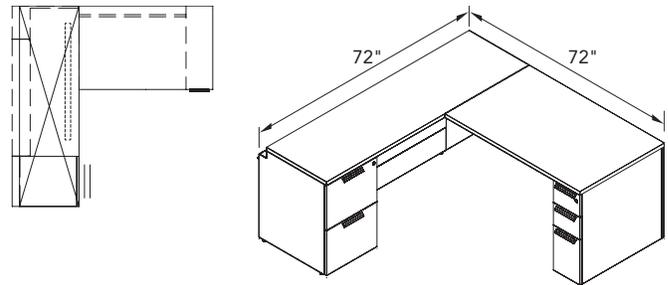

Traditional L — Desking Runoff & Ped 72" x 72"

Line Item	Product Description	Model Number	List Price
1	Desking Runoff 48"W x 30"D RH w/BBF Half Mod Panel	WKDRFN294830RH-BBF	\$ 3176
2	False Ped 12"W x 24"D RH	WKFPFN281224RH	\$ 1025
3	Wall Access Panel 28"H x 42"W Full Height	WKHP2842	\$ 1173
4	Support Ped 18"W x 24"D FF w/Trough Cut No Bk Panel	WKPSFN281824-FF	\$ 2075
5	Credenza Top 72"W x 24"D for use w/Trough	WKWSCW7224	\$ 819
6	42"W External Support Channel for 54"W Worksurface	Z5SC54	\$ 102
TOTAL			\$ 8,370

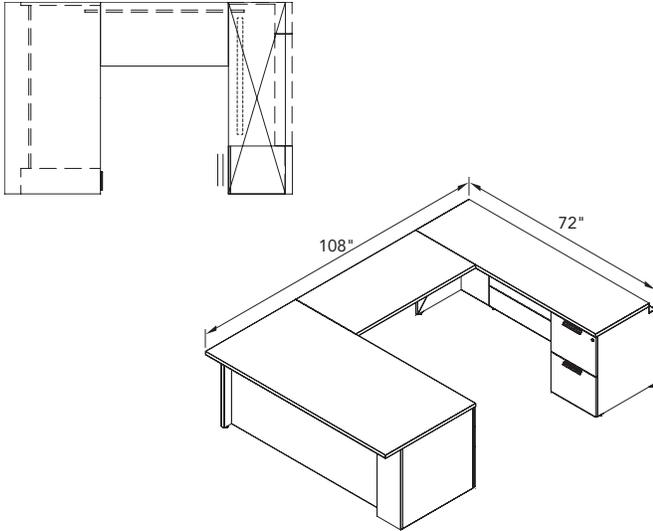

Traditional U — Single Ped Desk & Credenza 108" x 72"

Line Item	Product Description	Model Number	List Price
1	Single Ped Desk 72"W x 36"D LH BBF w/Mod Panel	WKDUFN297236LH-BBF	\$ 4376
2	Bridge 48"W x 24"D w/Half Mod Panel	WKAUBG4824	\$ 1295
3	Support Ped 18"W x 24"D FF w/Trough Cut No Back Panel	WKPSFN281824-FF	\$ 2075
4	False Ped 12"W x 24"D LH	WKFPFN281224LH	\$ 1025
5	Wall Access Panel 28"H x 42"W Full Ht	WKHP2842	\$ 1173
6	Credenza Top 72"W x 24"D for use w/Trough	WKWSCW7224	\$ 819
7	42"W External Support Channel for 54"W Worksurface	Z5SC54	\$ 102
TOTAL			\$ 10,865

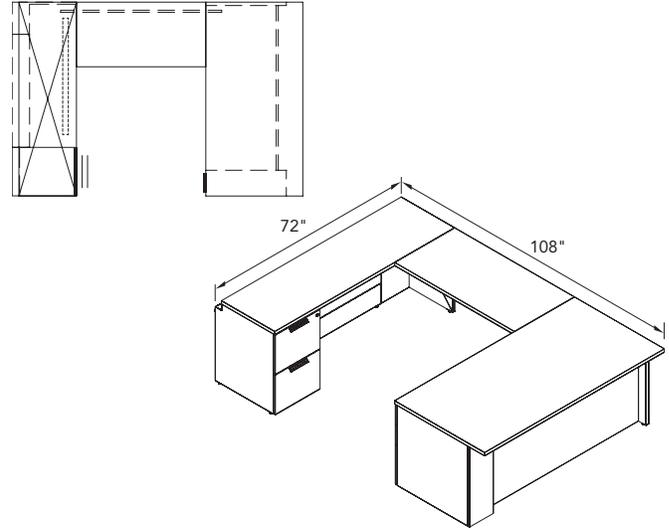

Traditional U — Single Ped Desk & Credenza 72" x 108"

Line Item	Product Description	Model Number	List Price
1	Single Ped Desk 72"W x 36"D RH BBF w/Mod Panel	WKDUFN297236RH-BBF	\$ 4376
2	Bridge 48"W x 24"D w/Half Mod Panel	WKAUBG4824	\$ 1295
3	Support Ped 18"W x 24"D FF w/Trough Cut No Back Panel	WKPSFN281824-FF	\$ 2075
4	False Ped 12"W x 24"D RH	WKFPFN281224RH	\$ 1025
5	Wall Access Panel 28"H x 42"W Full Ht	WKHP2842	\$ 1173
6	Credenza Top 72"W x 24"D for use w/Trough	WKWSCW7224	\$ 819
7	42"W External Support Channel for 54"W Worksurface	Z5SC54	\$ 102
TOTAL			\$ 10,865

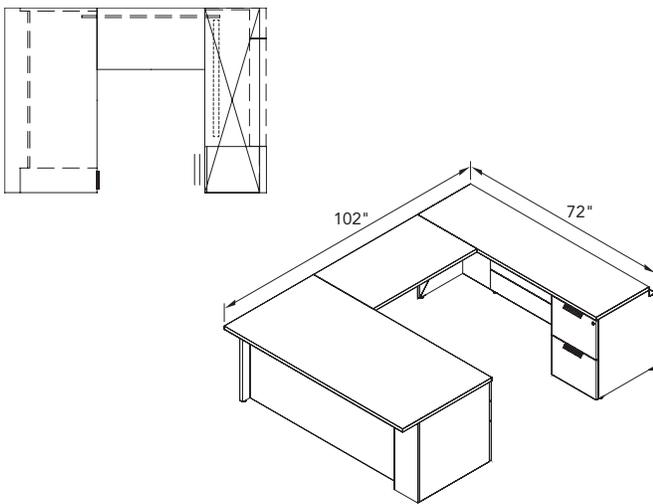

Traditional U — Single Ped Desk & Credenza 102" x 72"

Line Item	Product Description	Model Number	List Price
1	Single Ped Desk 72"W x 36"D LH BBF w/Mod Panel	WKDUFN297236LH-BBF	\$ 4376
2	Bridge 42"W x 24"D w/Half Mod Panel	WKAUBG4224	\$ 1246
3	Support Ped 18"W x 24"D FF w/Trough Cut No Back Panel	WKPSFN281824-FF	\$ 2075
4	False Ped 12"W x 24"D LH	WKFPFN281224LH	\$ 1025
5	Wall Access Panel 28"H x 42"W Full Ht	WKHP2842	\$ 1173
6	Credenza Top 72"W x 24"D for use w/Trough	WKWSCW7224	\$ 819
7	42"W External Support Channel for 54"W Worksurface	Z5SC54	\$ 102
TOTAL			\$ 10,816

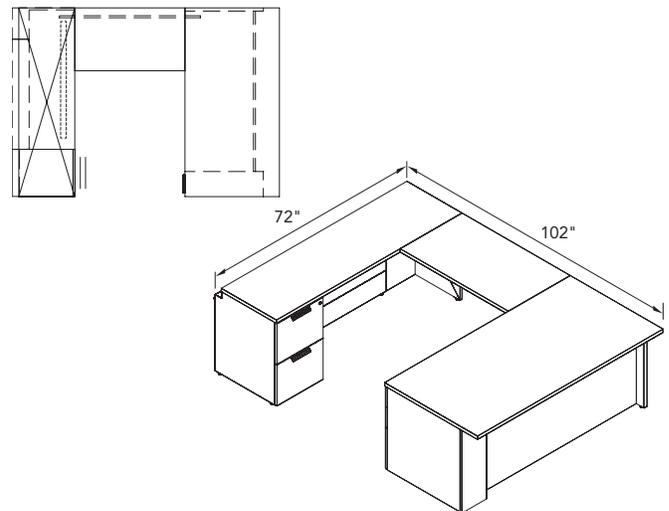

Traditional U — Single Ped Desk & Credenza 72" x 102"

Line Item	Product Description	Model Number	List Price
1	Single Ped Desk 72"W x 36"D RH BBF w/Mod Panel	WKDUFN297236RH-BBF	\$ 4376
2	Bridge 42"W x 24"D w/Half Mod Panel	WKAUBG4224	\$ 1246
3	Support Ped 18"W x 24"D FF w/Trough Cut No Back Panel	WKPSFN281824-FF	\$ 2075
4	False Ped 12"W x 24"D RH	WKFPFN281224RH	\$ 1025
5	Wall Access Panel 28"H x 42"W Full Ht	WKHP2842	\$ 1173
6	Credenza Top 72"W x 24"D for use w/Trough	WKWSCW7224	\$ 819
7	42"W External Support Channel for 54"W Worksurface	Z5SC54	\$ 102
TOTAL			\$ 10,816

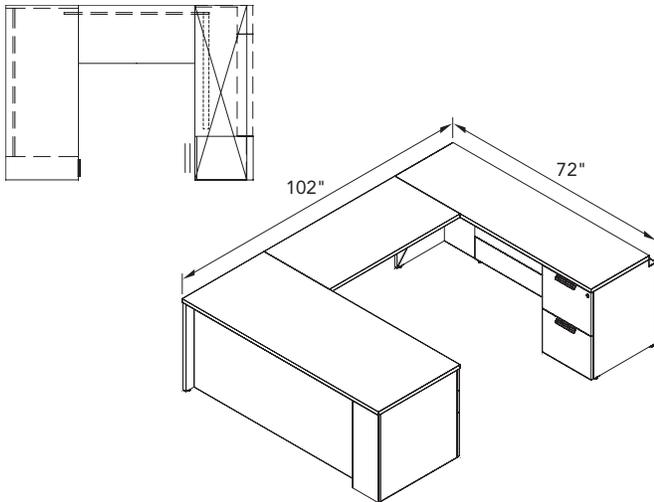

Traditional U — Single Ped Desk & Credenza 102" x 72"

Line Item	Product Description	Model Number	List Price
1	Single Ped Desk 72"W x 30"D LH BBF w/Mod Panel	WKDUFN297230LH-BBF	\$ 4099
2	Bridge 48"W x 24"D w/Half Mod Panel	WKAUBG4824	\$ 1295
3	Support Ped 18"W x 24"D FF w/Trough Cut No Back Panel	WKPSFN281824-FF	\$ 2075
4	False Ped 12"W x 24"D LH	WKFPFN281224LH	\$ 1025
5	Wall Access Panel 28"H x 42"W Full Ht	WKHP2842	\$ 1173
6	Credenza Top 72"W x 24"D for use w/Trough	WKWSCW7224	\$ 819
7	42"W External Support Channel for 54"W Worksurface	Z5SC54	\$ 102
TOTAL			\$ 10,588

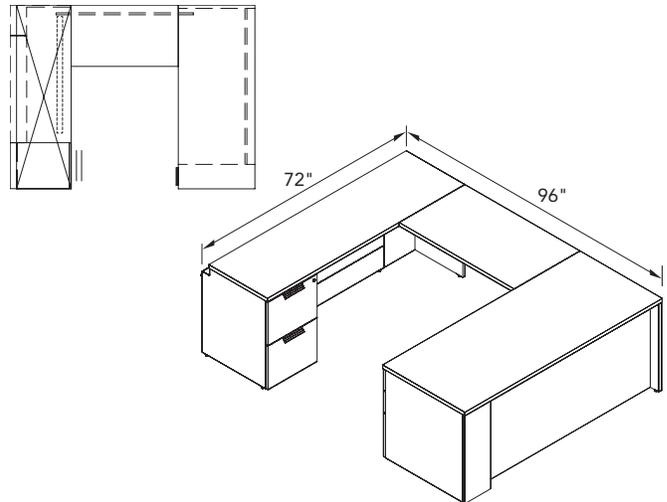

Traditional U — Single Ped Desk & Credenza 72" x 96"

Line Item	Product Description	Model Number	List Price
1	Single Ped Desk 72"W x 30"D RH BBF w/Mod Panel	WKDUFN297230RH-BBF	\$ 4099
2	Bridge 42"W x 24"D w/Half Mod Panel	WKAUBG4224	\$ 1246
3	Support Ped 18"W x 24"D FF w/Trough Cut No Back Panel	WKPSFN281824-FF	\$ 2075
4	False Ped 12"W x 24"D RH	WKFPFN281224RH	\$ 1025
5	Wall Access Panel 28"H x 42"W Full Ht	WKHP2842	\$ 1173
6	Credenza Top 72"W x 24"D for use w/Trough	WKWSCW7224	\$ 819
7	42"W External Support Channel for 54"W Worksurface	Z5SC54	\$ 102
TOTAL			\$ 10,539

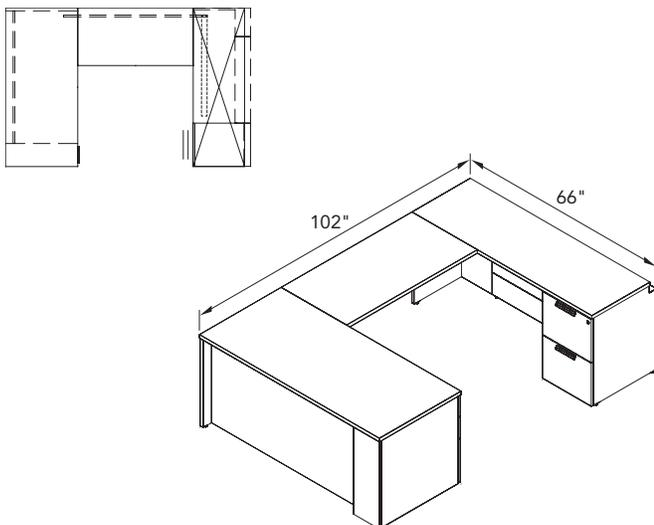

Traditional U — Single Ped Desk & Credenza 102" x 66"

Line Item	Product Description	Model Number	List Price
1	Single Ped Desk 66"W x 30"D LH BBF w/Mod Panel	WKDUFN296630LH-BBF	\$ 4039
2	Bridge 48"W x 24"D w/Half Mod Panel	WKAUBG4824	\$ 1295
3	Support Ped 18"W x 24"D FF w/Trough Cut No Back Panel	WKPSFN281824-FF	\$ 2075
4	False Ped 12"W x 24"D LH	WKFPFN281224LH	\$ 1025
5	Wall Access Panel 28"H x 36"W Full Ht	WKHP2836	\$ 1136
6	Credenza Top 66"W x 24"D for use w/Trough	WKWSCW6624	\$ 773
7	36"W External Support Channel for 48"W Worksurface	Z5SC48	\$ 89
TOTAL			\$ 10,432

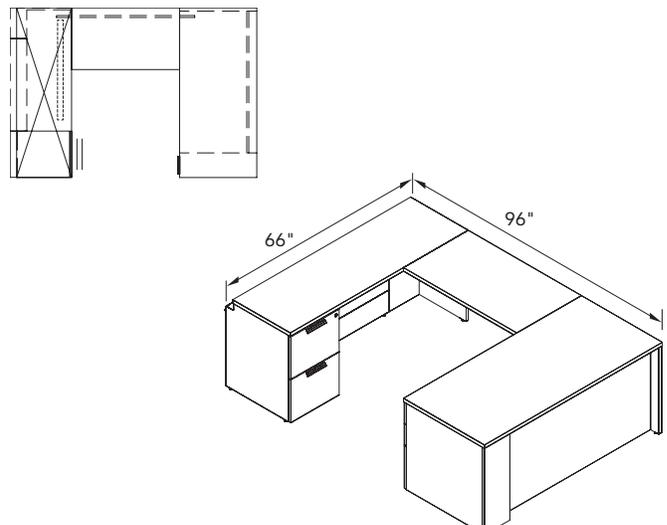

Traditional U — Single Ped Desk & Credenza 96" x 66"

Line Item	Product Description	Model Number	List Price
1	Single Ped Desk 66"W x 30"D RH BBF w/Mod Panel	WKDUFN296630RH-BBF	\$ 4039
2	Bridge 42"W x 24"D w/Half Mod Panel	WKAUBG4224	\$ 1246
3	Support Ped 18"W x 24"D FF w/Trough Cut No Back Panel	WKPSFN281824-FF	\$ 2075
4	False Ped 12"W x 24"D RH	WKFPFN281224RH	\$ 1025
5	Wall Access Panel 28"H x 36"W Full Ht	WKHP2836	\$ 1136
6	Credenza Top 66"W x 24"D for use w/Trough	WKWSCW6624	\$ 773
7	36"W External Support Channel for 48"W Worksurface	Z5SC48	\$ 89
TOTAL			\$ 10,383

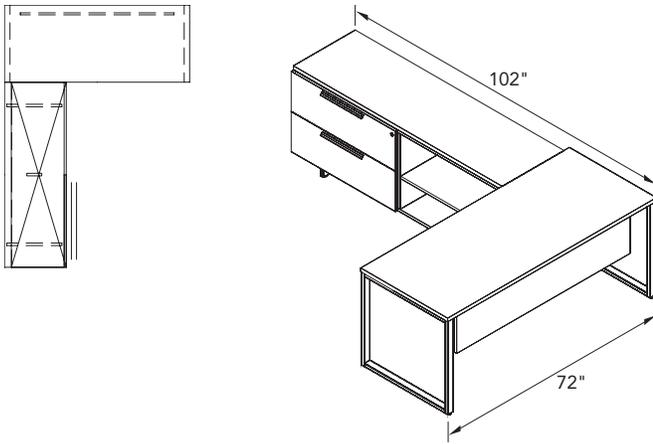

Light Scale L — Table Desk & Credenza 102" x 72"

Line Item	Product Description	Model Number	List Price
1	Table Desk 72"W x 30"D with O-Legs	WKTDOL297230	\$ 3209
2	Credenza 72"W x 24"D Lateral File / Open Shelf w/Trough	WKCUFY287224-LFOS	\$ 4530
3	Credenza Top 72"W x 24"D for use w/Trough	WKWSCW7224	\$ 819
TOTAL			\$ 8,558

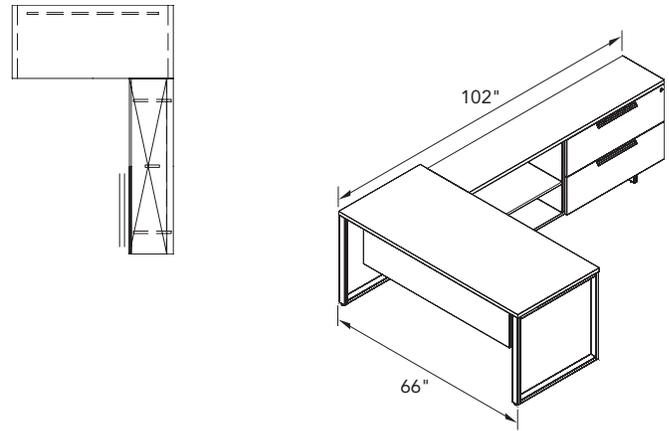

Light Scale L — Table Desk & Credenza 66" x 102"

Line Item	Product Description	Model Number	List Price
1	Table Desk 66"W x 30"D with O-Legs	WKTDOL296630	\$ 3119
2	Credenza 72"W x 18"D Open Shelf / Lateral File w/Trough	WKCUFY287218-OSLF	\$ 4423
3	Credenza Top 72"W x 18"D for use w/Trough	WKWSCW7218	\$ 773
TOTAL			\$ 8,315

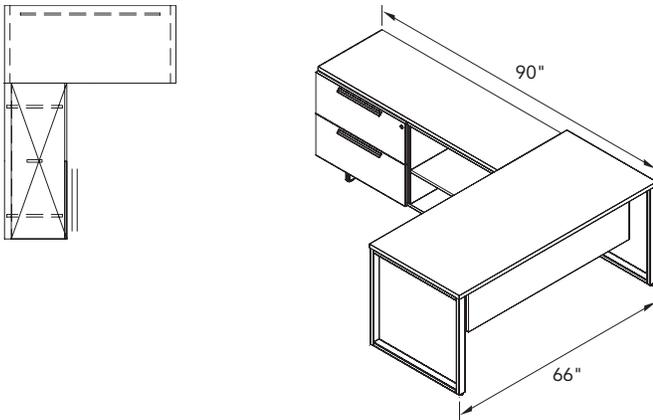

Light Scale L — Table Desk & Credenza 90" x 66"

Line Item	Product Description	Model Number	List Price
1	Table Desk 66"W x 30"D with O-Legs	WKTDOL296630	\$ 3119
2	Credenza 60"W x 24"D Lateral File / Open Shelf w/Trough	WKCUFY286024-LFOS	\$ 4377
3	Credenza Top 60"W x 24"D for use w/Trough	WKWSCW6024	\$ 743
TOTAL			\$ 8,239

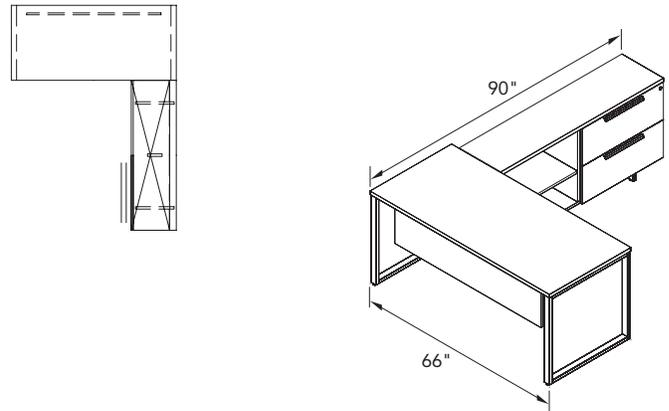

Light Scale L — Table Desk & Credenza 66" x 90"

Line Item	Product Description	Model Number	List Price
1	Table Desk 66"W x 30"D with O-Legs	WKTDOL296630	\$ 3119
2	Credenza 60"W x 18"D Open Shelf / Lateral File w/Trough	WKCUFY286018-OSLF	\$ 4272
3	Credenza Top 60"W x 18"D for use w/Trough	WKWSCW6018	\$ 704
TOTAL			\$ 8,095

Grain direction of woodgrain laminate is indicated below.

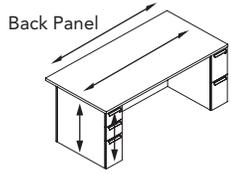

Desks

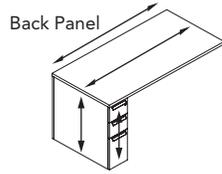

Desking Runoff

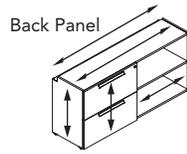

Credenzas

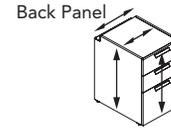

Pedestals



Wall Access Panel

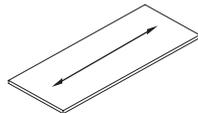

Tops & Shelf

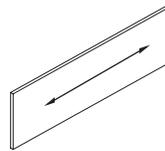

Modesty Panels
& Finished Backs

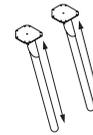

Wood
Splay Legs

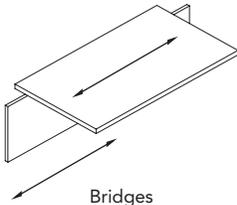

Bridges

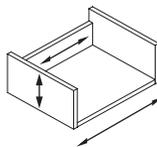

Cubby Storage

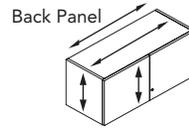

Wall Cabinet
Overheads

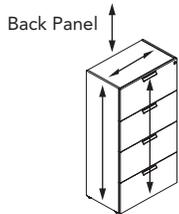

Lateral Files

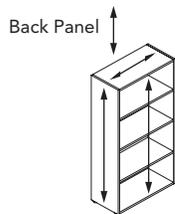

Bookcases

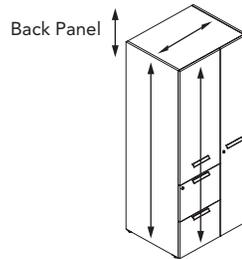

Towers

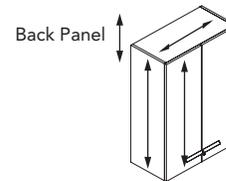

Stack-On Storage

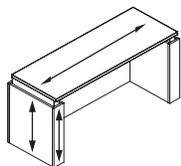

Height-Adjustable
Shrouded Desk

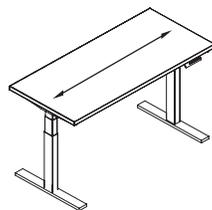

Height-Adjustable
Table

APPROACH DIMENSIONS		EXTERNAL DIMENSIONS			INTERNAL DIMENSIONS						
Description	Style	Height	Width	Depth	Location	Height	Width	Depth			
Shell Desk		29"	60"	30"		57½"	27⅞"	26⅞"			
		29"	66"	30"		63½"	27⅞"	26⅞"			
		29"	72"	30"		69½"	27⅞"	26⅞"			
Credenza Full Height Non-footed	Open/Hinged Door	28⅞"	30" / 60"*	17¼" / 18"	Total	26⅞"	28⅞"	14⅞"			
			36" / 72"*	23¼" / 24"	Above shelf	12⅞"	34⅞"	19"			
					Below shelf	12¼"					
		28⅞"	42"*	18"	Total	26⅞"	22½"	16⅞"			
					Above Shelf	12¼"					
					Below Shelf	12¼"					
							24"		22⅞"		
						48"*	18"	Total	26⅞"	28½"	16⅞"
								Above Shelf	12¼"		
				24"	Below Shelf	12¼"					
Lateral File	28⅞"	30" / 60"*	18"	Top Drawer (Lat)	12⅞"	26⅞"	12⅞"				
			24"	Bottom Drawer (Lat)	12⅞"	32⅞"	15"				
			28⅞"	42"* / 48"*	18" / 24"	Top Drawer (File)	8¾"	14⅞"	12⅞"		
						Bottom Drawer (File)	8¾"	14⅞"	12⅞"		
			Multi File	28⅞"	30" (Shelf)	18" (Shelf)	Cubby Shelf	6⅞"	13⅞"	14⅞"	
						24" (Shelf)				19"	
30" (Drawers)	Box	Top Drawer (Box)				5⅞"	26⅞"	13"			
	18" (Lat)	Bottom Drawer (Lat)				12⅞"		12⅞"			
	24" (Lat)								15"		
Open shelf/Box/File	28⅞"	30" (Shelf)	18" (Shelf)	Top shelf	6⅞"	28½"	14½"				
			24" (Shelf)				19"				
			30" (Drawers)	Box	Top Drawer (Box)	5⅞"	26⅞"	13"			
				18" (Lat)	Bottom Drawer (Lat)	12⅞"	32⅞"	12"			
				24" (Lat)					15"		
Credenza Full Height Footed	Open/Hinged Door	28⅞"	30" / 60"*	17¼" / 18"	Total	22½"	28½"	14½"			
			36" / 72"*	23¼" / 24"	Above shelf	10⅞"	34½"	19"			
					Below shelf	10⅞"					
		28⅞"	42"*	18"	Total	22⅞"	22½"	16⅞"			
					Above Shelf	11"					
					Below Shelf	11"					
							24"		22⅞"		
							18"	Total	22⅞"	28½"	16⅞"
								Above Shelf	11"		
				48"*	Below Shelf	11"					
Lateral File	28⅞"	30" / 60"*	18"	Top Drawer (Lat)	10⅞"	26⅞"	12"				
			24"	Bottom Drawer (Lat)	10⅞"	32⅞"	15"				
			28⅞"	42"* / 48"*	18" / 24"	Top Drawer (File)	8¾"	14⅞"	12⅞"		
						Bottom Drawer (File)	8¾"	14⅞"	12⅞"		
			Box/Box/File	28⅞"	30"	Box	Top Drawer (Box)	4⅞"	26⅞"	13"	
						36"	Middle Drawer (Box)	4⅞"	32⅞"		
		18" (Lat)				Bottom Drawer (Lat)	10⅞"		12"		
		24" (Lat)							15"		
	28⅞"	30" (Shelf)				18" (Shelf)	Cubby Shelf	4⅞"	13⅞"	14½"	
						24" (Shelf)				19"	
		30" (Drawers)	Box	Top Drawer (Box)	4⅞"	26⅞"	13"				
			18" (Lat)	Bottom Drawer (Lat)	10⅞"		12"				
			24" (Lat)				15"				

*On 42"W, 48"W, 60"W, & 72"W units internal dimensions apply to each side of center support.

APPROACH DIMENSIONS		EXTERNAL DIMENSIONS			INTERNAL DIMENSIONS			
Description	Style	Height	Width	Depth	Location	Height	Width	Depth
Credenza Layered Height Non-Footed	Open/Hinged Door	24¾"	30" / 60"*	17¼" / 18"	Total	22½"	28½"	14½"
					Above shelf	9"	34½"	
					Below shelf	12¼"		
		24¾"	42"*	18"	Total	22⅝"	22½"	16⅝"
					Above Shelf	9⅝"		
					Below Shelf	12¼"		
				24"				22⅝"
			48"*	18"	Total	22⅝"	28½"	16⅝"
					Above Shelf	9⅝"		
					Below Shelf	12¼"		
	Lateral File	24¾"	42"* / 48"*	18"	24"	Top Drawer (Box)	2⅞"	14⅜"
Bottom Drawer (File)						8¾"	14⅜"	12⅞"
Box/File	24¾"	30" / 60"* (Drawers)	Box	18" (Lat)	Top Drawer (Box)	8⅝"	26⅝"	13"
					Bottom Drawer (Lat)	12⅝"	32⅝"	12"
Multi File	24¾"	30" (Shelf)	18" (Shelf)	Depth	Cubby Shelf	4⅞"	13¼"	14⅝"
					Top Drawer (Box)	3¼"	26⅝"	13"
Box/File / Pullout drawer	24¾"	30"	18"	18" (Lat)	Bottom Drawer (Lat)	12⅝"		12"
					Top Drawer (Box)	8⅞"	14¼"	12"
					Bottom Drawer (File)	12"	14¼"	12"
					Pullout Drawer	21½"	8"	15"
	24¾"	36"	18"		Top Drawer (Box)	8⅞"	19¼"	12"
					Bottom Drawer (File)	12"	19¼"	12"
					Pullout Drawer	21½"	8"	15"
					Total	22½"	16½"	16¼"
Open Shelf / Pullout Drawer	24¾"	30"	18"		Above Shelf	9¼"	16½"	16¼"
					Below Shelf	12½"	16½"	16¼"
					Pullout Drawer	21½"	8"	15"
					Total	22½"	22½"	16¼"
					Above Shelf	9⅞"	22½"	16¼"
					Below Shelf	12½"	22½"	16¼"
					Pullout Drawer	21½"	8"	15"
					Total	22½"	10½"	14¼"
Box/File / Hinged Door	24¾"	30"	18"		Top Drawer (Box)	8⅞"	14¼"	12"
					Bottom Drawer (File)	12"	14¼"	12"
					Hinged Door	22½"	10½"	14¼"
					Top Drawer (Box)	8⅞"	19¼"	12"
					Bottom Drawer (File)	12"	19¼"	12"
					Hinged Door	22½"	10½"	14¼"
Open Shelf / Hinged Door	24¾"	30"	18"		Total	22½"	16½"	14¼"
					Above Shelf	9¼"	16½"	14¼"
					Below Shelf	12½"	16½"	14¼"
					Hinged Door	22½"	10½"	14¼"
	24¾"	36"	18"		Total	22½"	22½"	14¼"
					Above Shelf	9⅞"	22½"	14¼"
					Below Shelf	12½"	22½"	14¼"
					Hinged Door	22½"	10½"	14¼"
Box/File / Open Cubby	24¾"	30"	18"		Top Drawer (Box)	8⅞"	14¼"	12"
					Bottom Drawer (File)	12"	14¼"	12"
					Open Cubby	22½"	10½"	14¼"
					Top Drawer (Box)	8⅞"	19¼"	12"
					Bottom Drawer (File)	12"	19¼"	12"
					Open Cubby	22½"	10½"	14¼"
Open Shelf / Open Cubby	24¾"	30"	17¼"		Total	22½"	16½"	14¼"
					Above Shelf	9¼"	16½"	14¼"
					Below Shelf	12½"	16½"	14¼"
					Open Cubby	22½"	10½"	14¼"
	24¾"	36"	17¼"		Total	22½"	22½"	14¼"
					Above Shelf	9¼"	22½"	14¼"
					Below Shelf	12½"	22½"	14¼"
					Open Cubby	22½"	10½"	14¼"
					Total	22½"	10½"	14¼"
					Above Shelf	9¼"	22½"	14¼"
					Below Shelf	12½"	22½"	14¼"
					Open Cubby	22½"	10½"	14¼"

*On 42"W, 48"W, 60"W, & 72"W units internal dimensions apply to each side of center support.

APPROACH DIMENSIONS		EXTERNAL DIMENSIONS			INTERNAL DIMENSIONS				
Description	Style	Height	Width	Depth	Location	Height	Width	Depth	
Credenza Layered Height Footed	Open/Hinged Door	24 ³ / ₄ "	30" / 60"*	17 ¹ / ₄ " / 18"	Total	19"	28 ¹ / ₂ "	14 ³ / ₈ "	
			36" / 72"*		Above shelf	7 ¹ / ₄ "	34 ¹ / ₂ "		
					Below shelf	10 ⁷ / ₈ "			
			24 ³ / ₄ "	42"*	18"	Total	19"	22 ¹ / ₂ "	16 ³ / ₈ "
						Above Shelf	7 ¹ / ₄ "		
						Below Shelf	11"		
					24"				22 ³ / ₈ "
				48"*	18"	Total	19"	28 ¹ / ₂ "	16 ³ / ₈ "
						Above Shelf	7 ¹ / ₄ "		
						Below Shelf	11"		
					24"				22 ³ / ₈ "
	Lateral File		24 ³ / ₄ "	42"* / 48"*	18"	Top Drawer (Box)	2 ⁷ / ₈ "	14 ³ / ₈ "	12 ³ / ₈ "
					Bottom Drawer (File)	8 ³ / ₄ "	14 ³ / ₈ "	12 ³ / ₈ "	
Box/File		24 ³ / ₄ "	30" / 60"* (Drawers)	Box	Top Drawer (Box)	6"	26 ³ / ₈ "	13"	
			36" / 72"* (Drawers)	18" (Lat)	Bottom Drawer (Lat)	10 ³ / ₈ "	32 ³ / ₈ "	12"	
Credenza for Integrated HAT Full Height Non-footed	Open Shelf Portion	24 ³ / ₄ "	60"*	18"	Open Shelf Total	21 ⁷ / ₈ "	28 ¹ / ₂ "	10 ¹ / ₂ "	
					Above Shelf	8"			
					Below Shelf	12 3/8"			
				24"				16 ¹ / ₂ "	
				72"*	18"	Open Shelf Total	21 ⁷ / ₈ "	34 ¹ / ₂ "	10 ¹ / ₂ "
						Above Shelf	8"		
						Below Shelf	12 ³ / ₈ "		
				24"				16 ¹ / ₂ "	
	Box/File Portion	24 ³ / ₄ "	60"*	18"/24"	Top Drawer (Box)	2 ⁷ / ₈ "	26 ³ / ₈ "	13"	
					Bottom Drawer (File)	8 ⁷ / ₈ "	25 ⁷ / ₈ "	12"	
			72"*	18"/24"	Top Drawer (Box)	2 ⁷ / ₈ "	32 ³ / ₈ "	13"	
				Bottom Drawer (File)	8 ⁷ / ₈ "	31 ⁷ / ₈ "	12"		
Approach Dimensions	Pullout Drawer	24 ³ / ₄ "	18"	17 ¹ / ₄ "	Pullout Drawer	21 ¹ / ₂ "	8"	15"	
	Hinged Door	24 ³ / ₄ "	18"	17 ¹ / ₄ "	Hinged Door	22 ¹ / ₂ "	10 ¹ / ₂ "	14 ¹ / ₄ "	
	12"W Pedestal	24 ³ / ₄ "	18"	17 ¹ / ₄ "	Open Cubby	22 ¹ / ₂ "	10 ¹ / ₂ "	14 ¹ / ₄ "	
Skinny Pedestals	File/File	28 ³ / ₈ "	9 ¹ / ₂ "	23 ³ / ₄ " (File)	Top Drawer (File)	11 ¹ / ₂ "	5 ³ / ₄ "	15 ¹ / ₂ "	
				29 ³ / ₄ " (File)	Bottom Drawer (File)	12 ³ / ₄ "		25 ³ / ₈ "	
	Box/Box/File	28 ³ / ₈ "	9 ¹ / ₂ "	Box	Top Drawer (Box)	5 ¹ / ₄ "	5 ³ / ₄ "	15 ¹ / ₂ "	
				23 ³ / ₄ " (File)	Middle Drawer (Box)	6"		15 ¹ / ₂ "	
				29 ³ / ₄ " (File)	Bottom Drawer (File)	12 ³ / ₄ "		25 ³ / ₈ "	
15"W Support Ped	File/File - Non-Footed	28"	15"	24"	Top Drawer (File)	12 ³ / ₈ "	12"	15"	
					Bottom Drawer (File)	12 ³ / ₈ "	12"	15"	
	File/File - Footed	24"	15"	24"	Top Drawer (File)	10 ³ / ₈ "	12"	15"	
					Bottom Drawer (File)	10 ³ / ₈ "	12"	15"	
	Box/Box/File Non-Footed	28"	15"	24"	Top Drawer (Box)	5 ¹ / ₄ "	12"	15"	
					Mid Drawer (Box)	6"	12"	15"	
					Bottom Drawer (File)	12 ³ / ₈ "	12"	15"	
	Box/Box/File Footed	24"	15"	24"	Top Drawer (Box)	4 ³ / ₈ "	12"	15"	
				Mid Drawer (Box)	5"	12"	15"		
				Bottom Drawer (File)	10 ³ / ₈ "	12"	15"		

*On 42"W, 48"W, 60"W, & 72"W units internal dimensions apply to each side of center support.

APPROACH DIMENSIONS		EXTERNAL DIMENSIONS			INTERNAL DIMENSIONS			
Description	Style	Height	Width	Depth	Location	Height	Width	Depth
Height-Adjustable	File/File	24"	14¼"	30"	See Skinny Ped			
Fixed Laminate	48"W Modesty	24"	37.359"					
Modesty and	54"W Modesty		43.359"					
Metal Hanging	60"W Modesty		49.359"					
Modesty for HAT	66"W Modesty		55.359"					
	72"W Modesty		61.359"					
Note: Metal modesty is ½" less in width than shown above.								
Ped Desk w/ 15"W Ped		29"	60" 66" 72"	30"	See 15"W Pedestal for Configuration	27⅞" 42⅞" 54⅞"	42⅞" 48⅞" 54⅞"	26⅞" 26⅞" 26⅞"
Pedestals 18"W – Full Height	Hinged Door	28⅞"	18"	18" 24"	Total Above shelf Below shelf	26¼" 12⅞" 12¾"	16½"	14⅞" 19"
	File/File	28⅞"	18"	18" 24"	Top Drawer (File) Bottom Drawer (File)	12⅞" 12¼"	14⅞"	12" 15"
	Box/Box/File	28⅞"	18"	18" (Box) 24" (Box) 18" (File) 24" (File)	Top Drawer (Box) Middle Drawer (Box) Bottom Drawer (File)	5⅞" 6" 12¼"	14⅞"	12" 15" 12" 15"
Ped 18"W – Layered Height	Box/File	24¾"	18"	18" (Box) 18" (File)	Top Drawer (Box) Bottom Drawer (File)	8½" 12¼"	14⅞"	12" 12"
Mobile Ped	Box/File	21½"	15¾"	20⅞" (Box) 20¼" (File)	Top Drawer (Box) Bottom Drawer (File)	4½" 10⅞"	12"	14⅞" 15"
Full-Height Modesty	¾" Thick	28"	48" 54" 60" 66" 72"	¾"				
Pull-Out Tower		42"	12"	24"	Wardrobe File Bottom Shelf (Adjustable) Top Shelf (Fixed)	35¼" 10⅞" 12" 6"	8⅞" 7½" 8⅞" 8⅞"	6" 12⅞" 15½" 15½"
		50"			Wardrobe File Bottom Shelf (Adjustable) Mid Shelf (Adjustable) Top Shelf (Fixed)	36" 10⅞" 8" 8" 6"	8⅞" 7½" 8⅞" 8⅞" 8⅞"	6" 12⅞" 15½" 15½" 21¼"
		42"		30"	Wardrobe File Bottom Shelf (Adjustable) Top Shelf (Adjustable)	35¼" 10⅞" 12" 6"	8⅞" 7½" 8⅞" 8⅞"	8" 12⅞" 19¼" 19¼"
		50"			Wardrobe File Bottom Shelf (Adjustable) Mid Shelf (Adjustable) Top Shelf (Fixed)	36" 10⅞" 8" 8" 6"	8⅞" 7½" 8⅞" 8⅞" 8⅞"	8" 12⅞" 19¼" 19¼" 27¼"

APPROACH DIMENSIONS		EXTERNAL DIMENSIONS			INTERNAL DIMENSIONS			
Description	Style	Height	Width	Depth	Location	Height	Width	Depth
Towers	Non-footed	42½"	12"	18"	3H - Bottom Shelf	14⅞"	10⅞"	16⅝"
Hinged Door		42½"	18"	18"	3H - Second Shelf (Adjustable)	12⅜"	16⅜"	16⅝"
		42½"	24"	18"	3H - Top Shelf (Fixed)	11"	22⅝"	16⅝"
		42½"	12"	24"		10⅞"	22⅝"	
		42½"	18"	24"		16⅜"	22⅝"	
		42½"	24"	24"		22⅝"	22⅝"	
		50"	12"	18"	3H - Bottom Shelf	17⅞"	10⅞"	16⅝"
		50"	18"	18"	3H - Second Shelf (Adjustable)	12⅜"	16⅜"	16⅝"
		50"	24"	18"	3H - Top Shelf (Fixed)	15"	22⅝"	16⅝"
		50"	12"	24"		10⅞"	22⅝"	
		50"	18"	24"		16⅜"	22⅝"	
		50"	24"	24"		22⅝"	22⅝"	
		57½"	12"	18"	4H - Bottom Shelf	17½"	10⅞"	16⅝"
		57½"	18"	18"	4H - Second Shelf (Adjustable)	11⅜"	16⅜"	16⅝"
		57½"	24"	18"	4H - Third Shelf (Adjustable)	11⅜"	22⅝"	16⅝"
		57½"	12"	24"	4H - Top Shelf (Fixed)	11"	10⅞"	22⅝"
		57½"	18"	24"		16⅜"	22⅝"	
		57½"	24"	24"		22⅝"	22⅝"	
		65"	12"	18"	5H - Bottom Shelf	17½"	10⅞"	16⅝"
		65"	18"	18"	5H - Second Shelf (Adjustable)	11⅜"	16⅜"	16⅝"
		65"	24"	18"	5H - Third Shelf (Adjustable)	11⅜"	22⅝"	16⅝"
		65"	12"	24"	5H - Fourth Shelf (Fixed)	7⅞"	10⅞"	22⅝"
		65"	18"	24"	5H - Top Shelf (Adjustable)	11"	16⅜"	22⅝"
		65"	24"	24"		22⅝"	22⅝"	
		72½"	12"	18"	5H - Bottom Shelf	17½"	10⅞"	16⅝"
		72½"	18"	18"	5H - Second Shelf (Adjustable)	11⅜"	16⅜"	16⅝"
		72½"	24"	18"	5H - Third Shelf (Adjustable)	11⅜"	22⅝"	16⅝"
		72½"	12"	24"	5H - Fourth Shelf (Fixed)	11⅜"	10⅞"	22⅝"
		72½"	18"	24"	5H - Top Shelf (Adjustable)	11"	16⅜"	22⅝"
		72½"	24"	24"		22⅝"	22⅝"	
Footed		42½"	12"	18"	3H - Bottom Shelf	10¾"	10⅞"	16⅝"
		42½"	18"	18"	3H - Second Shelf (Adjustable)	12⅜"	16⅜"	16⅝"
		42½"	24"	18"	3H - Top Shelf (Fixed)	11"	22⅝"	16⅝"
		42½"	12"	24"		10⅞"	22⅝"	
		42½"	18"	24"		16⅜"	22⅝"	
		42½"	24"	24"		22⅝"	22⅝"	
		50"	12"	18"	3H - Bottom Shelf	14¼"	10⅞"	16⅝"
		50"	18"	18"	3H - Second Shelf (Adjustable)	12⅜"	16⅜"	16⅝"
		50"	24"	18"	3H - Top Shelf (Fixed)	14⅞"	22⅝"	16⅝"
		50"	12"	24"		10⅞"	22⅝"	
		50"	18"	24"		16⅜"	22⅝"	
		50"	24"	24"		22⅝"	22⅝"	
		57½"	12"	18"	4H - Bottom Shelf	13⅞"	10⅞"	16⅝"
		57½"	18"	18"	4H - Second Shelf (Adjustable)	11⅜"	16⅜"	16⅝"
		57½"	24"	18"	4H - Third Shelf (Adjustable)	11⅜"	22⅝"	16⅝"
		57½"	12"	24"	4H - Top Shelf (Fixed)	11"	10⅞"	22⅝"
		57½"	18"	24"		16⅜"	22⅝"	
		57½"	24"	24"		22⅝"	22⅝"	
		65"	12"	18"	5H - Bottom Shelf	13⅞"	10⅞"	16⅝"
		65"	18"	18"	5H - Second Shelf (Adjustable)	11⅜"	16⅜"	16⅝"
		65"	24"	18"	5H - Third Shelf (Adjustable)	11⅜"	22⅝"	16⅝"
		65"	12"	24"	5H - Fourth Shelf (Fixed)	6⅞"	10⅞"	22⅝"
		65"	18"	24"	5H - Top Shelf (Adjustable)	13"	16⅜"	22⅝"
		65"	24"	24"		22⅝"	22⅝"	
		72½"	12"	18"	5H - Bottom Shelf	13⅞"	10⅞"	16⅝"
		72½"	18"	18"	5H - Second Shelf (Adjustable)	11⅜"	16⅜"	16⅝"
		72½"	24"	18"	5H - Third Shelf (Adjustable)	11⅜"	22⅝"	16⅝"
		72½"	12"	24"	5H - Fourth Shelf (Fixed)	11⅜"	10⅞"	22⅝"
		72½"	18"	24"	5H - Top Shelf (Adjustable)	13"	16⅜"	22⅝"
		72½"	24"	24"		22⅝"	22⅝"	

*Blanks are replicas of the same tower height 18"D model above.

APPROACH DIMENSIONS		EXTERNAL DIMENSIONS			INTERNAL DIMENSIONS				
Description	Style	Height	Width	Depth	Location	Height	Width	Depth	
Towers	Combination Non-Footed	50"	18"	18"	Fixed Shelf	6 ³ / ₈ "	16 ³ / ₈ "	16 ³ / ₈ "	
		50"	18"	24"		22 ³ / ₈ "			
	File/File & Box/Box/File available, see ped specs for details	50"	24"	18"	Adjustable Shelf	12 ³ / ₈ "	16 ³ / ₈ "	16 ³ / ₈ "	
			24"	24"		22 ³ / ₈ "			
		50"	Wardrobe (24" W ONLY)			47"	5 ¹ / ₄ "	16 ³ / ₈ "	
								22 ³ / ₈ "	
		LH/RH Versions available	57 ¹ / ₂ "	18"	18"	Fixed Shelf	14 ³ / ₈ "	16 ³ / ₈ "	16 ³ / ₈ "
			57 ¹ / ₂ "	18"	24"				22 ³ / ₈ "
			57 ¹ / ₂ "	24"	18"	Adjustable Shelf	12 ³ / ₈ "	16 ³ / ₈ "	16 ³ / ₈ "
			57 ¹ / ₂ "	24"	24"				22 ³ / ₈ "
			Wardrobe (24" W ONLY)			54 ¹ / ₂ "	5 ¹ / ₄ "	16 ³ / ₈ "	
								22 ³ / ₈ "	
		Footed	50"	18"	18"	Fixed Shelf	8 ³ / ₈ "	16 ³ / ₈ "	16 ³ / ₈ "
				18"	24"				22 ³ / ₈ "
	50"		24"	18"	Adjustable Shelf	12 ³ / ₈ "	16 ³ / ₈ "	16 ³ / ₈ "	
			24"	24"				22 ³ / ₈ "	
	Wardrobe (24" W ONLY)			47"	5 ¹ / ₄ "	16 ³ / ₈ "			
						22 ³ / ₈ "			
	RH/LH Models available		57 ¹ / ₂ "	18"	18"	Fixed Shelf	14 ³ / ₈ "	16 ³ / ₈ "	16 ³ / ₈ "
			57 ¹ / ₂ "	18"	24"				22 ³ / ₈ "
			57 ¹ / ₂ "	24"	18"	Adjustable Shelf	12 ³ / ₈ "	16 ³ / ₈ "	16 ³ / ₈ "
			57 ¹ / ₂ "	24"	24"				22 ³ / ₈ "
			Wardrobe (24" W ONLY)			54 ¹ / ₂ "	5 ¹ / ₄ "	16 ³ / ₈ "	
								22 ³ / ₈ "	
Footed	65"	18"	18"	Fixed Shelf	8 ³ / ₈ "	16 ³ / ₈ "	16 ³ / ₈ "		
		18"	24"				22 ³ / ₈ "		
	65"	24"	18"	Lower Adjustable Shelf	12 ³ / ₄ "	16 ³ / ₈ "	16 ³ / ₈ "		
		24"	24"				22 ³ / ₈ "		
	Upper Adjustable Shelf			12 ³ / ₈ "	16 ³ / ₈ "	16 ³ / ₈ "			
						22 ³ / ₈ "			
	Wardrobe (24" W ONLY)			62"	5 ¹ / ₄ "	16 ³ / ₈ "			
						22 ³ / ₈ "			
	Footed	72 ¹ / ₂ "	18"	18"	Fixed Shelf	16 ³ / ₈ "	16 ³ / ₈ "	16 ³ / ₈ "	
			18"	24"				22 ³ / ₈ "	
		72 ¹ / ₂ "	24"	18"	Lower Adjustable Shelf	12 ³ / ₄ "	16 ³ / ₈ "	16 ³ / ₈ "	
			24"	24"				22 ³ / ₈ "	
Upper Adjustable Shelf			12 ³ / ₈ "	16 ³ / ₈ "	16 ³ / ₈ "				
					22 ³ / ₈ "				
Wardrobe (24" W ONLY)			69 ¹ / ₂ "	5 ¹ / ₄ "	16 ³ / ₈ "				
					22 ³ / ₈ "				

*Blanks are replicas of the same tower height 18"D model above.

APPROACH DIMENSIONS		EXTERNAL DIMENSIONS			INTERNAL DIMENSIONS				
Description	Style	Height	Width	Depth	Location	Height	Width	Depth	
Side Access	Non-Footed	50"	18"	18"	Worksurface Height Shelf	5½"	17¼"	16⅜"	
Towers	File/File & Box/Box/File available, see ped specs for details	50"	18"	24"				22⅜"	
		50"	24"	18"	Adjustable Shelf	12⅝"	17¼"	16⅜"	
					Wardrobe (24" W ONLY)	47"	5¼"	16⅜"	
								22⅜"	
			57½"	18"	18"	Worksurface Height Shelf	13"	17¼"	16⅜"
			57½"	18"	24"				22⅜"
			57½"	24"	18"	Adjustable Shelf	12⅝"	17¼"	16⅜"
			57½"	24"	24"				22⅜"
						Wardrobe (24" W ONLY)	54½"	5¼"	16⅜"
									22⅜"
			65"	18"	18"	Worksurface Height Shelf	7½"	17¼"	16⅜"
			65"	18"	24"				22⅜"
			65"	24"	18"	Lower Adjustable Shelf	12¼"	17¼"	16⅜"
			65"	24"	24"				22⅜"
						Upper Adjustable Shelf	12⅝"	17¼"	16⅜"
									22⅜"
						Wardrobe (24" W ONLY)	62"	5¼"	16⅜"
									22⅜"
			72½"	18"	18"	Worksurface Height Shelf	15"	17¼"	16⅜"
			72½"	18"	24"				22⅜"
		72½"	24"	18"	Lower Adjustable Shelf	12¼"	17¼"	16⅜"	
		72½"	24"	24"				22⅜"	
					Upper Adjustable Shelf	12⅝"	17¼"	16⅜"	
								22⅜"	
					Wardrobe (24" W ONLY)	69½"	5¼"	16⅜"	
								22⅜"	
Footed	File/File & Box/Box/File available, see ped specs for details	50"	18"	18"	Worksurface Height Shelf	5½"	17¼"	16⅜"	
		50"	18"	24"				22⅜"	
			50"	24"	18"	Adjustable Shelf	12⅝"	17¼"	16⅜"
			50"	24"	24"				22⅜"
						Wardrobe (24" W ONLY)	47"	5¼"	16⅜"
								22⅜"	
			57½"	18"	18"	Worksurface Height Shelf	13"	17¼"	16⅜"
			57½"	18"	24"				22⅜"
			57½"	24"	18"	Adjustable Shelf	12⅝"	17¼"	16⅜"
			57½"	24"	24"				22⅜"
						Wardrobe (24" W ONLY)	54½"	5¼"	16⅜"
									22⅜"
			65"	18"	18"	Worksurface Height Shelf	7½"	17¼"	16⅜"
			65"	18"	24"				22⅜"
			65"	24"	18"	Lower Adjustable Shelf	12¼"	17¼"	16⅜"
			65"	24"	24"				22⅜"
						Upper Adjustable Shelf	12⅝"	17¼"	16⅜"
									22⅜"
						Wardrobe (24" W ONLY)	62"	5¼"	16⅜"
									22⅜"
		72½"	18"	18"	Worksurface Height Shelf	15"	17¼"	16⅜"	
		72½"	18"	24"				22⅜"	
		72½"	24"	18"	Lower Adjustable Shelf	12¼"	17¼"	16⅜"	
		72½"	24"	24"				22⅜"	
					Upper Adjustable Shelf	12⅝"	17¼"	16⅜"	
								22⅜"	
					Wardrobe (24" W ONLY)	69½"	5¼"	16⅜"	
								22⅜"	
Stack-On Storage	Hinged Door	29⅝"	18"	15"	4H – Top Shelf	12⅝"	16½"	13⅝"	
					4H – Bottom Shelf	12⅝"	28½"		
					5H – Top Shelf	12⅝"	34½"		
					5H – Middle Shelf	12⅝"			
					5H – Bottom Shelf	13¼"			

*Blanks are replicas of the same tower height 18"D model above.

APPROACH DIMENSIONS		EXTERNAL DIMENSIONS			INTERNAL DIMENSIONS				
Description	Style	Height	Width	Depth	Location	Height	Width	Depth	
Stack-On		29 ⁷ / ₈ "	18"	14 ¹ / ₄ "	4H – Top Shelf	12 ⁵ / ₈ "	16 ¹ / ₂ "	13 ³ / ₈ "	
Storage					4H – Bottom Shelf	12 ⁵ / ₈ "	28 ¹ / ₂ "		
Open Shelf		42 ¹ / ₈ "	36"		5H – Top Shelf	12 ⁵ / ₈ "	34 ¹ / ₂ "		
					5H – Middle Shelf	12 ⁵ / ₈ "			
					5H – Bottom Shelf	13 ³ / ₄ "			
Stack-On		29 ⁷ / ₈ "	18"	15"	4H – Top Shelf	13"	17 ¹ / ₄ "	13 ³ / ₈ "	
Storage					4H – Bottom Shelf	11 ¹ / ₄ "			
Side Access		42 ¹ / ₈ "			5H – Top Shelf	13"			
					5H – Middle Shelf	13"			
					5H – Bottom Shelf	13"			
Hutch	Hinged Doors Available in Laminate and Frosted Glass Doors	35"	48"	14"	Workspace Clearance	20"	46 ³ / ₈ "	13 ³ / ₈ "	
					Left Storage Area	12 ⁵ / ₈ "	30 ³ / ₈ "	13 ³ / ₈ "	
						Right Storage Area	12 ⁵ / ₈ "	14 ⁵ / ₈ "	13 ³ / ₈ "
					Workspace Clearance	20"	58 ³ / ₈ "	13 ³ / ₈ "	
					Left Storage Area	12 ⁵ / ₈ "	28 ³ / ₈ "	13 ³ / ₈ "	
					Right Storage Area	12 ⁵ / ₈ "	28 ³ / ₈ "	13 ³ / ₈ "	
			35"	66"	14"	Workspace Clearance	20"	64 ³ / ₈ "	13 ³ / ₈ "
						Left Storage Area	12 ⁵ / ₈ "	31 ³ / ₈ "	13 ³ / ₈ "
						Right Storage Area	12 ⁵ / ₈ "	31 ³ / ₈ "	13 ³ / ₈ "
			35"	72"	14"	Workspace Clearance	20"	70 ³ / ₈ "	13 ³ / ₈ "
					Left Storage Area	12 ⁵ / ₈ "	34 ³ / ₈ "	13 ³ / ₈ "	
					Right Storage Area	12 ⁵ / ₈ "	34 ³ / ₈ "	13 ³ / ₈ "	
Floating Shelf	Laminate shelf without exposed brackets	1 ¹ / ₈ "	30"	8"					
		1 ¹ / ₈ "	36"	8"					
		1 ¹ / ₈ "	42"	8"					
		1 ¹ / ₈ "	48"	8"					
		1 ¹ / ₈ "	54"	8"					
		1 ¹ / ₈ "	60"	8"					
		1 ¹ / ₈ "	66"	8"					
		1 ¹ / ₈ "	72"	8"					
		1 ¹ / ₈ "	78"	8"					
Lateral Files	2H	29 ¹ / ₂ "	30"	18 ³ / ₈ "	2H – Top Drawer	13"	26 ³ / ₈ "	12"	
					2H – Top Drawer	12 ³ / ₈ "	32 ³ / ₈ "	15"	
	3H	42 ¹ / ₄ "	30"	18"	3H – Top Drawer	12 ¹ / ₄ "	26 ³ / ₈ "	12"	
					3H – Middle Drawer	12 ³ / ₈ "	32 ³ / ₈ "	15"	
					3H – Bottom Shelf	12 ³ / ₈ "			
	4H	56 ³ / ₈ "	30"	18"	4H – Top Drawer	12 ³ / ₈ "	26 ³ / ₈ "	12"	
4H – 2nd Drawer					12 ³ / ₈ "	32 ³ / ₈ "	15"		
4H – 3rd Drawer					13"				
				4H – Bottom Drawer	12 ³ / ₈ "				
Bookcases Open Shelf	2H	29 ¹ / ₂ "	30"	14 ¹ / ₄ "	2H – Top Shelf	13 ³ / ₈ "	28 ¹ / ₂ "	13 ³ / ₈ "	
					2H – Bottom Shelf	13 ³ / ₈ "			
	3H	42 ¹ / ₄ "	30"	14 ¹ / ₄ "	3H – Top Shelf	11 ⁷ / ₈ "	28 ¹ / ₂ "	13 ³ / ₈ "	
					3H – Middle Shelf	13 ¹ / ₂ "			
					3H – Bottom Shelf	13 ³ / ₈ "			
	4H	56 ³ / ₈ "	30"	14 ¹ / ₄ "	4H – Top Shelf	12 ³ / ₈ "	28 ¹ / ₂ "	13 ³ / ₈ "	
					4H – 2nd Shelf	12 ⁷ / ₈ "			
					4H – 3rd Shelf	13 ¹ / ₂ "			
					4H – Bottom Shelf	13 ³ / ₈ "			
	5H	71 ¹ / ₈ "	30"	14 ¹ / ₄ "	5H – Top Shelf	12 ⁵ / ₈ "	28 ¹ / ₂ "	13 ³ / ₈ "	
5H – 2nd Shelf					12 ³ / ₈ "				
5H – 3rd Shelf					14 ¹ / ₂ "				
5H – 4th Shelf					13 ¹ / ₂ "				
5H – Bottom Shelf					13 ³ / ₈ "				
Overheads Hinged Door & Open Shelf	Hinged 15"D	15"	30"	See depth dimensions by style at left		12 ⁵ / ₈ "	28 ³ / ₈ "	13 ³ / ₈ "	
	Glass 15 ¹ / ₄ "D		36"			34 ³ / ₈ "			
	Open 14 ³ / ₈ "D		42"			40 ³ / ₈ "			
			48"			45 ¹ / ₄ "			
			60"*			28 ¹ / ₂ "			
			66"*			31 ¹ / ₂ "			
			72"*			34 ¹ / ₂ "			
	78"*		37 ¹ / ₂ "						

*Blanks are replicas of the same tower height 18"D model above.

APPROACH DIMENSIONS		EXTERNAL DIMENSIONS			INTERNAL DIMENSIONS			
Description	Style	Height	Width	Depth	Location	Height	Width	Depth
Sliding Door	Sliding 15"D	15"	48"*			12 ⁵ / ₈ "	22 ³ / ₄ "	12 ¹ / ₄ "
			60"*				28 ³ / ₄ "	
			66"*				31 ³ / ₄ "	
			72"*				34 ³ / ₄ "	
			78"*				37 ³ / ₄ "	

*Wider units internal dimensions apply to each side of center support.

Load Capacity for Approach Laminate Wood Storage

Unit	Style	Height	Width	Depth	Load Capacity	Location	
28"H Credenza Non-Footed	Open/ Hinged Door	28	30	18	88 lbs.	Shelf	
				24	117 lbs.	Shelf	
		36	18	107 lbs.	Shelf		
			24	142 lbs.	Shelf		
		42	18	79 lbs.	Top Shelf		
			24	109 lbs.	Top Shelf		
		48	18	101 lbs.	Top Shelf		
			24	138 lbs.	Top Shelf		
		Lateral File	28	30	18	66 lbs.	File
					24	82 lbs.	File
	36		18	81 lbs.	File		
			24	100 lbs.	File		
	42		18	36 lbs.	File		
			24	36 lbs.	File		
	48		18	36 lbs.	File		
			24	36 lbs.	File		
	Multi-File	28	30	18	21 lbs.	Cubby shelf	
				24	28 lbs.	Cubby shelf	
				18	30 lbs.	Box	
				24	30 lbs.	Box	
				18	67 lbs.	File	
				24	83 lbs.	File	
		28	30	18	43 lbs.	Top Shelf	
				24	57 lbs.	Top Shelf	
36				18	52 lbs.	Top Shelf	
				24	69 lbs.	Top Shelf	
30				18	30 lbs.	Box	
				24	30 lbs.	Box	
Open Shelf/ Box/File	36	18	37 lbs.	Box			
			24	37 lbs.	Box		
	30	18	67 lbs.	File			
		24	83 lbs.	File			
	36	18	82 lbs.	File			
		24	102 lbs.	File			
28"H Full-Height Footed	Open/ Hinged Door	28	30	18	75 lbs.	Shelf	
				24	100 lbs.	Shelf	
		36	18	91 lbs.	Shelf		
			24	121 lbs.	Shelf		
		42	18	68 lbs.	Top Shelf		
			24	93 lbs.	Top Shelf		
	48	18	86 lbs.	Top Shelf			
		24	118 lbs.	Top Shelf			
	Lateral File	28	30	18	56 lbs.	File	
				24	70 lbs.	File	
		36	18	69 lbs.	File		
			24	86 lbs.	File		
		42	18	31 lbs.	File		
			24	31 lbs.	File		
	48	18	31 lbs.	File			
		24	31 lbs.	File			
	Box/Box/File	28	30	18	25 lbs.	Box	
				24	25 lbs.	Box	
36		18	31 lbs.	Box			
		24	31 lbs.	Box			
30		18	56 lbs.	File			
		24	70 lbs.	File			
36		18	69 lbs.	File			
		24	86 lbs.	File			
Multi-File		28	30	18	15 lbs.	Cubby Shelf	
				24	20 lbs.	Cubby shelf	
	18	26 lbs.	Box				
		24	26 lbs.	Box			
	18	56 lbs.	File				
		24	70 lbs.	File			

Unit	Style	Height	Width	Depth	Load Capacity	Location	
24"H Credenza Non-Footed	Open/ Hinged Door	24	30	18	63 lbs.	Shelf	
				18	76 lbs.	Shelf	
				18	57 lbs.	Shelf	
				18	72 lbs.	Shelf	
	Box/File	24	30	18	50 lbs.	Box	
					61 lbs.	Box	
					25 lbs.	Box	
					25 lbs.	Box	
					67 lbs.	File	
					82 lbs.	File	
					36 lbs.	File	
					36 lbs.	File	
	Multi-File	24	30	18	15 lbs.	Cubby Shelf	
					19 lbs.	Box	
					67 lbs.	File	
					67 lbs.	File	
	24"H Credenza Footed	Open Shelf/ Hinged Door	24	30	18	50 lbs.	Shelf
					18	61 lbs.	Shelf
18					45 lbs.	Shelf	
18					57 lbs.	Shelf	
Box/File		24	30	18	35 lbs.	Box	
					43 lbs.	Box	
					20 lbs.	Box	
					20 lbs.	Box	
					56 lbs.	File	
					69 lbs.	File	
					31 lbs.	File	
					31 lbs.	File	
Slim 28"H File/File	28	9.5	24	18 lbs.	File		
				29 lbs.	File		
	28	9.5	24	8 lbs.	Box		
				31 lbs.	File		
	Pedestals	18"W x 28"H Hinged Door	28	18	18	51 lbs.	Shelf
					24	68 lbs.	Shelf
18"W x 28"H File/File		28	18	18	36 lbs.	File	
				24	45 lbs.	File	
18"W x 28"H Box/Box/File		28	18	18	15 lbs.	Box	
				24	19 lbs.	Box	
Overheads and Stack-Ons	Hinged Door & Open Shelf	15	30	15	81 lbs.		
					98 lbs.		
					115 lbs.		
					66 lbs.		
					82 lbs.		
					90 lbs.		
	Sliding Door	15	48	15	60 lbs.		
					76 lbs.		
					84 lbs.		
					92 lbs.		
					99 lbs.		
					99 lbs.		
Cubby	18"W	7	18	14	23 lbs.		
					31 lbs.		
					39 lbs.		

Unit	Style	Height	Width	Depth	Load Capacity	Location			
HAT Integrated Credenzas	Open Shelf	24	30	18	42 lbs.	Shelf			
			36	18	51 lbs.	Shelf			
			30	24	66 lbs.	Shelf			
			36	24	80 lbs.	Shelf			
	Box/File	24	30	18	45 lbs.	Box			
			36	18	57 lbs.	Box			
			30	18	31 lbs.	File			
			36	18	80 lbs.	File			
			30	24	31 lbs.	Box			
			36	24	57 lbs.	Box			
			30	24	45 lbs.	File			
			36	24	80 lbs.	File			
	Wardrobe Towers		42½	12	18	34 lbs.	Fixed & Adjustable Shelf		
			50		24	47 lbs.			
		57½	18	18	54 lbs.				
		65		24	74 lbs.				
		72½	24	18	74 lbs.				
Combo/Side Access Towers	Open Shelf	50	18	18	57 lbs.	Adjustable Shelf			
					77 lbs.				
					57½		24	18	57 lbs.
					72½		24	77 lbs.	
	Box/File		18 & 24	18	36 lbs.	File			
					45 lbs.	File			
					15 lbs.	Box			
					19 lbs.	Box			
					36 lbs.	File			
					45 lbs.	File			
Open Access Towers		57½	18	18	57 lbs.	Shelf			
		72½		24	77 lbs.				
Hutches	Left Storage	12⅝	48	13⅝	88 lbs.	Shelf			
	Right Storage	12⅝			42 lbs.	Shelf			
	Left Storage	12⅝	60	13⅝	82 lbs.	Shelf			
	Right Storage	12⅝			82 lbs.	Shelf			
	Left Storage	12⅝	66	13⅝	91 lbs.	Shelf			
	Right Storage	12⅝			91 lbs.	Shelf			
	Left Storage	12⅝	72	13⅝	99 lbs.	Shelf			
	Right Storage	12⅝			99 lbs.	Shelf			

Product	Style	9½"W	12"W	18"W	24"W	30"W	36"W	42"W	48"W	60"W	66"W	72"W	
28"H Credenzas	Open Shelves					N/A	N/A						
	Box/Box/File						1 lock						
	Hinged Door					1 lock	1 lock						
	Hinged Door / Hinged Door									2 locks		2 locks	
	Hinged Door / Lateral File									2 locks		2 locks	
	Lateral File					1 lock	1 lock						
	Lateral File / Hinged Door									2 locks		2 locks	
	Lateral File / Lateral File									2 locks		2 locks	
	Lateral File / Open Shelves								1 lock	1 lock	1 lock		1 lock
	Multi File						1 lock						
	Open Shelves / Box File						1 lock	1 lock					
	Open Shelves / Lateral File								1 lock	1 lock	1 lock		1 lock
24"H Credenzas	Open Shelves												
	Box/Box/File						1 lock						
	Box/File					1 lock	1 lock						
	Box File / Box File									2 locks		2 locks	
	Box File / Hinged Door									2 locks		2 locks	
	Box File / Open Shelves							1 lock	1 lock	1 lock		1 lock	
	Hinged Door					1 lock	1 lock						
	Hinged Door / Box File									2 locks		2 locks	
	Lateral File					1 lock	1 lock						
	Multi File					1 lock							
	Open Shelves / Box File								1 lock	1 lock	1 lock		1 lock
	Box/File / Pullout drawer						2 locks	2 locks					
	Open Shelf / Pullout Drawer						1 lock	1 lock					
	Box/File / Hinged Door						2 locks	2 locks					
	Open Shelf / Hinged Door						1 lock	1 lock					
Box/File / Open Cubby						1 lock	1 lock						
Open Shelf / Open Cubby													
Desks	Box/Box/File					1 lock							
	File/File					1 lock							
	Box Box File / File File					2 locks							
Laterals	2-High					1 lock	1 lock						
	3-High					1 lock	1 lock						
	4-High					1 lock	1 lock						
24"H Pedestals	Box/File			1 lock									
	Mobile Box/File		1 lock										
	Pullout Drawer		1 lock										
	Hinged Door		1 lock										
	Open Cubby												
28"H Support Pedestals	Box/Box/File	1 lock		1 lock									
	File/File	1 lock		1 lock									
	False Pedestal												
Hinged Door Towers Height – 42½", 50", 57½", 65½", 72½"	Hinged Door Laminate			1 lock	1 lock								
	Hinged Door Writable												
Depth – 18", 24"													
Side Access and Combo Towers	Side Access Laminate			1 lock	2 locks								
	Side Access Writable												
Heights – 50", 57½", 65", 72½"	Combo Tower Laminate												
	Combo Tower Writable												
Depths – 18", 24"													
Hutches Heights – 35" Widths – 48", 60", 66", 72"	Laminate Door								1 lock	2 locks	2 locks	2 locks	
	Frosted Door												

Product	Style	30"W	36"W	42"W	48"W	60"W	66"W	72"W	78"W
Overheads	Hinged Door Laminate (HDL)	1 lock	1 lock	1 lock	1 lock	2 locks	2 locks	2 locks	2 locks
	Hinged Door Writable (HDM)								
	Hinged Door Glass Front (HDG)								
	Open Shelf, No Door Laminate (NDL)								
	Sliding Door Laminate (SDL)				1 lock	1 lock	1 lock	1 lock	1 lock

CREDENZAS

30"W or 60" W (2-30"W columns)

36"W or 72"W (2-36"W columns)

Front-to-Back Filing*

Outside tabs of folders rest on drawer sides.
Inside tabs of folders rest on filing bars included with unit.

Letter Size Hanging File Folders
(8½ x 11" documents)

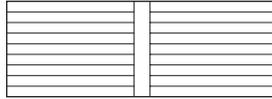

18"D Units – 24" of letter filing.
24"D Units – 30" of letter filing.

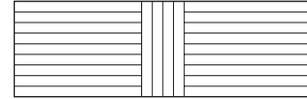

18"D Units – 24" of letter front-to-back filing, plus 8" of letter side-to-side filing.
24"D Units – 30" of letter front-to-back filing, plus 8" of legal side-to-side filing.

Legal Size Hanging File Folders
(8½ x 14" documents)

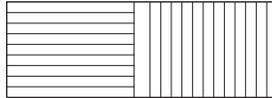

18"D Units – 12" of legal filing, plus 11" of letter side-to-side filing.
24"D Units – 26" of legal filing both front-to-back and side-to-side.

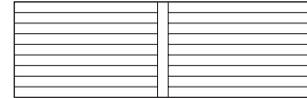

18"D Units – 24" of legal filing.
24"D Units – 30" of legal filing.

Side-to-Side Filing

Front folder tabs rest on drawer front. Back folder tabs rest on back of drawer on 18"D units for letter and 24"D units for legal; letter filing on 24"D, tabs rest on 2-12" filing bars resting on front-to-back bars (all 4 filing bars included with unit).

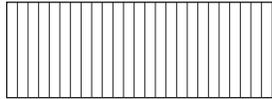

18"D Units – 26⅔" of letter filing.
24"D Units – 24" of letter or 26⅔" of legal filing.

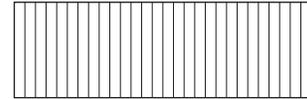

18"D Units – 32⅔" of letter filing.
24"D Units – 24" of letter or 32⅔" of legal filing.

PEDESTALS

Side-to-Side Filing

15" W

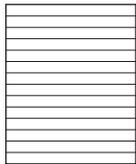

Letter Front-to-Back
18"D Mobile – 14½" of filing
24"D Support – 19" of filing

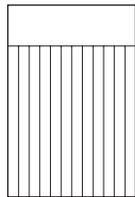

Legal Side-to-Side
24"D Support – 12" of filing

Slim 24"D

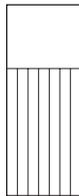

5¼" of letter filing
5¾" of legal filing

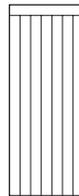

18"W x 18"D

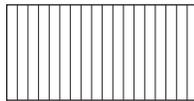

18"D Units – 14⅔" of letter filing

Slim 30"D



11½" of letter filing
5¾" of legal filing

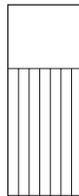

18"W x 24"D

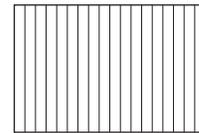

24"D Units – 14⅔" of letter or legal filing

Front-to-Back Filing

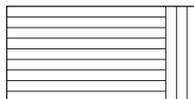

18"D Units – 12" of letter filing,
plus 2" of side-to-side letter filing

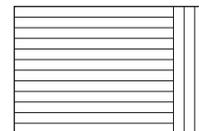

24"D Units – 15" of letter filing,
plus 2" of legal side-to-side filing

PAINT FINISHES

GRADE P1

Black*	P27
Brownstone	P7D
Bungalow	P7C
Cinder	P7Q
Designer White*	PJW
Flint	P02
Fossil	P28
Loft	P7B
Muslin	P4J
Parchment	P93
Pebble	P8R
Pewter	P8D
Salt	P8C
Titanium	P8T
White	PD8

GRADE P2

Champagne Metallic	PR5
Gunmetal Metallic	PR3
Night Bronze	P8B
Platinum Metallic	PR2
Pyrite	PJE
Silver*	PR6
Solar Black	P8X

GRADE P3

Atom	P8S
Blossom***	P8K
Bullseye	PJF
Ember	P8P
Ion	P8N
Iris	P8J
Krypton	P8F
Ochre	P093
Regatta	P8M
Sienna	P092
Succulent***	P8A

*Column, End Cap, Foot, and Leg models are only available in these three colors.

*** These colors are intended to be an inspirational option for the trending market. Product application is limited and color availability is approximately two years to coincide with evolving workplace trends.

Metallic paints, due to varying reflectance, may appear to have less visual color consistency than other paint finishes, even when L/A/B values are exactly the same. (L/A/B — measurable aspects of color — values are maintained within a specified range, to ensure consistent appearance of paint colors.)

FOOT

FOOT TYPE

Blade Foot	BF
Black	P27
Designer White	PJW
Silver	PR6
Post Foot	PF
Designer White	PJW
Flint	P02
Loft	P7B
Silver	PR6
Pyrite	PJE
Solar Black	P8X

LAMINATES

SOLID COLORS

GRADE L1

Black	P
Designer White	LDW1
Flint	LM16
Loft	LM11

WOODGRAIN

GRADE L1

Bourbon Cherry	H
Cognac	COGN
Field Elm	LWFE
Florence Walnut	LFW1
Harvest	C
Kingswood Walnut	LKI1
Mocha	MOCH
Natural Maple	LWD
Neo Walnut	LNU1
Pinnacle	PINC
Shaker Cherry	F
Sterling Ash	LSA1

GRADE L2

Beigewood	LWBE
Fawn Cypress	LFC1
Lowell Ash	LLA1
Natural Recon	LNR1
Phantom Ecu	LPE1
Portico Teak	LPT1
Skyline Walnut	LSW1
Veranda Teak	LVT1

PLASTIC GROMMETS

FOR WORKSURFACES

Black	E4
Brownstone	EY
Designer White	DW
Flint	E9
Fossil	EH
Loft	EV
Muslin	EU

PLASTIC GROMMETS WITH WOODGRAIN EDGE

If woodgrain edge is specified, the plastic grommet color is predetermined, based on finish selection.

Kingswood Walnut and Neowalnut	Brownstone EY
Fawn Cypress and Natural Recon	Muslin EU
Phantom Ecu	Loft EV
Portico Teak	Fossil EH
Skyline Walnut	Flint E9
All other woodgrains options	Black E4

LAMINATE EDGE COLORS

Beigewood	DE
Black	E4
Bourbon Cherry	H
Cognac	CN
Designer White	DW
Fawn Cypress	FC
Field Elm	FE
Flint	E9
Florence Walnut	FW
Harvest	XEDC
Kingswood Walnut	KI
Loft	EV
Lowell Ash	DL
Mocha	MO
Natural Maple	DD
Natural Recon	NR
Neo Walnut	NU
Phantom Ecu	PE
Pinnacle	PI
Portico Teak	DP
Shaker Cherry	DF
Skyline Walnut	SW
Sterling Ash	SA
Veranda Teak	VT

NOTE: Refer to individual product pages for upcharges.

FSC Certified Wood at Allsteel

See page 336 for more information.

Laminate Storage Brackets

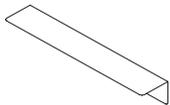
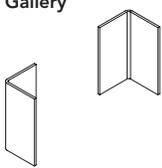
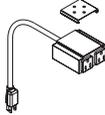
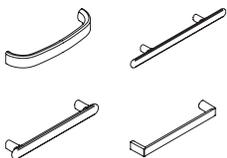
WORKING WITH LAMINATE BRACKETS		
Product Line	Brackets Which Work with All Laminate and Wood Storage	Model:
Involve 	Panel mounting kit – Compatible with all laminate storage with inset back	K6__PBK__
Involve 	O-Leg to Panel bracket – Compatible any 28"H O-Legs	KOLGBRK_FT
Terrace 	Flat Bracket 12D, 24D, or 30D – Compatible with all laminate storage	T6__FB
Product Line	Brackets Which Potentially Work with Multiple Lines	Model:
Stride 	"L" Bracket for Worksurface connections – Stride & Further have pilot holes, theoretically could be used with all laminate storage.	Z6LB
Gallery 	Storage to Gallery Panel ganging kit – Involve finished back units have pilot holes, theoretically could be used with all finished back laminate storage.	GSGKL
Product Line	Brackets Which Work with All Laminate and Wood Storage	Model:
Involve	Involve Tower to Overhead kit – Involve and Stride overheads as they have flat base panels, not Approach as it has a recessed bottom for integrated lighting.	K6TBK
Approach 	Approach mini tap bracket – Made for use with Approach Mini Tap – could be used to attach the Mini Tap to other storage products. <i>Note:</i> Any other storage units do not have pilot holes.	WKMTMB
	Individual pull packs include 2 or 3 pulls and hardware compatible with Approach, Involve, Further, Align, and Raddii.	YPPULL2/3

Approach and Involve Laminate Wood Storage Storage with Panel Frames

Leg or plinth base models available. Leg base units are shown below.

GSA Reference Page

Side-mounted Credenzas

Use 1 storage-to-panel bracket per credenza — 1 LH and 1 RH.

The minimum credenza size is 24"H x 36"W x 18"D.

With a mid-run floor support, the maximum panel run is 144".

Without a mid-run floor support, the maximum panel run is 96".

Overheads and shelves cannot be used with 24"H side mounted credenzas.

Worksurfaces (if specified) must be mounted on the same side of the parent run as the credenzas.

Panel frame maximum height is 65".

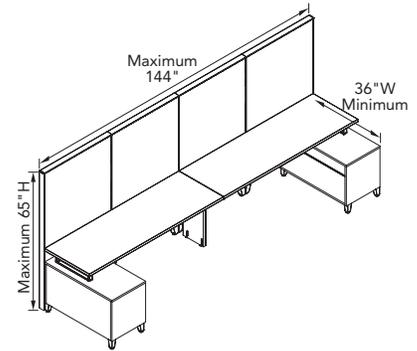

Back-mounted Credenzas — Modular

Use 2 storage-to-panel brackets per credenza — 1 LH and 1 RH.

The minimum credenza size is 24"H x 36"W x 24"D.

The maximum panel run between back-mounted credenzas is 72".

Overheads and shelves cannot be used with 24"H back mounted credenzas.

Worksurfaces (if specified) must be mounted on the same side of the parent run as the credenzas.

Panel frame maximum height is 65".

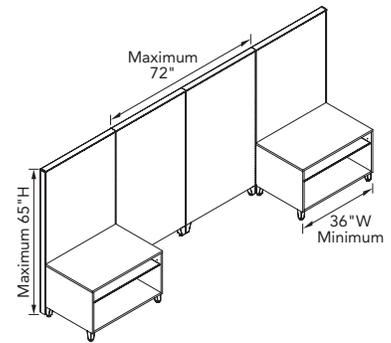

Back-mounted Credenzas — Off-Modular Ends

Use 1 storage-to-panel bracket per credenza — 1 LH and 1 RH.

The minimum credenza size is 24"H x 36"W x 24"D.

With a mid-run floor support, the maximum panel run is 144"

Without a mid-run floor support, the maximum panel run is 96".

Overheads and shelves cannot be used with 24"H back mounted credenzas.

Worksurfaces (if specified) must be mounted on the same side of the parent run as the credenzas.

Panel frame maximum height is 65".

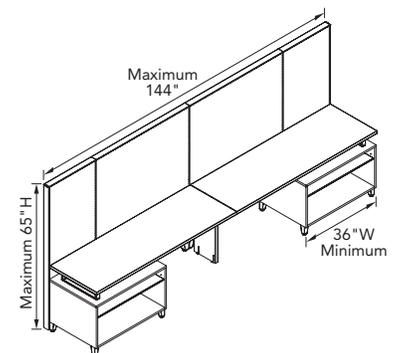

Note: Storage with unfinished metal backs require storage-to-panel bracket kit in order to mount to a panel. Left- or right-handed storage-to-panel bracket is determined by slots on panel — left-handed bracket required when attaching to left panel slots and right-handed bracket required when attaching to right panel slots.

Involve storage with unfinished backs require **storage-to-panel bracket kit** in order to mount to a panel.

Optional laminate back is available (ordered separately) for use when the back of the unit will be exposed.

Plinth base units require a different laminate back model than leg base units.

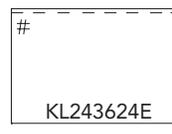
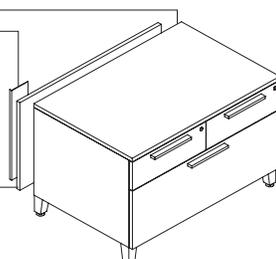

An example of a 2D CAD symbol for Involve is shown at left. Note the dashed line that represents the unfinished metal back. The pound sign indicates that counterweight kits may need to be added depending on the application. See page 266 for counterweight specification rules.

APPROACH

Approach and Involve Laminate Wood Storage Storage with Panel Frames

Leg or Plinth Base models available. Leg base units are shown below.

GSA Reference Page

Side-mounted Credenzas — Modular for Overheads and Worksurfaces

Use 2 storage-to-panel brackets per credenza — 1 LH and 1 RH.

The minimum credenza size is 28"H x 36"W x 24"D.

28"H side mounted credenzas must be mounted modular when using overheads and worksurfaces on panels.

With a mid-run floor support, the maximum panel run is 144".

Without a mid-run floor support, the maximum panel run is 96".

Overheads, shelves, and worksurfaces must be mounted on the same side of the parent run as the credenzas.

Maximum overhead height is 15".

Panel frame maximum height is 65".

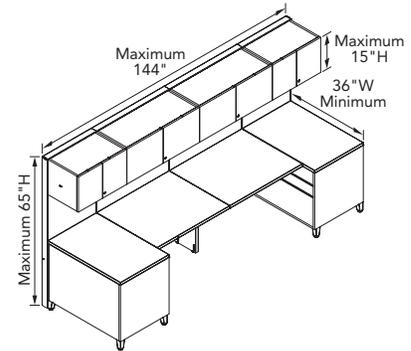

Back-mounted Credenzas — Modular for Overheads and Worksurfaces

Use 2 storage-to-panel brackets per credenza — 1 LH and 1 RH.

The minimum credenza size is 28"H x 36"W x 24"D.

Full back units without trough due to stability, only troughless Approach or Involve allowed.

With a mid-run floor support, the maximum panel run is 144".

Without a mid-run floor support, the maximum panel run is 96".

The maximum panel run between back-mounted credenzas is 72".

Overheads, shelves, and worksurfaces must be mounted on the same side of the parent run as the credenzas.

Maximum overhead height is 15".

Panel frame maximum height is 65".

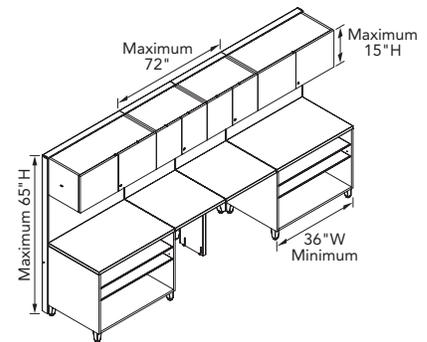

Side-mounted Credenzas — with Return Panel

Use 1 storage-to-panel bracket on credenza.

The minimum credenza size is 24"H x 36"W x 18"D.

The minimum size for panel return is 35"H x 36"W.

With a mid-run floor support, the maximum panel run is 144".

Without a mid-run floor support, the maximum panel run is 96".

Overheads and shelves cannot be used with 24"H side mounted credenzas.

Worksurfaces (if specified) must be mounted on the same side of the parent run as the credenzas.

Panel frame maximum height is 65".

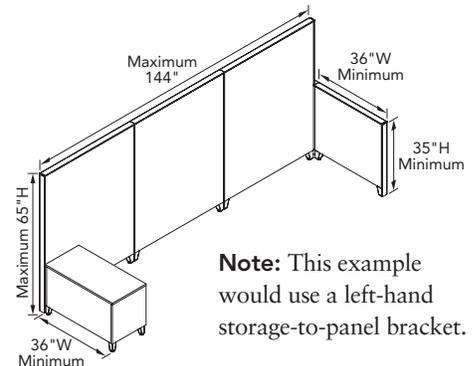

Side-mounted Credenzas — Modular for Overheads and Worksurfaces

Use 2 storage-to-panel brackets per credenza — 1 LH and 1 RH.

The minimum credenza size is 28"H x 36"W x 24"D.

The minimum size for panel return is 50"H x 36"W.

28"H side mounted credenzas must be mounted modular when using overheads and worksurfaces on panels.

With a mid-run floor support, the maximum panel run is 144".

Without a mid-run floor support, the maximum panel run is 72".

Overheads, shelves, and worksurfaces must be mounted on the same side of the parent run as the credenzas.

Maximum overhead height is 15".

Panel frame maximum height is 65".

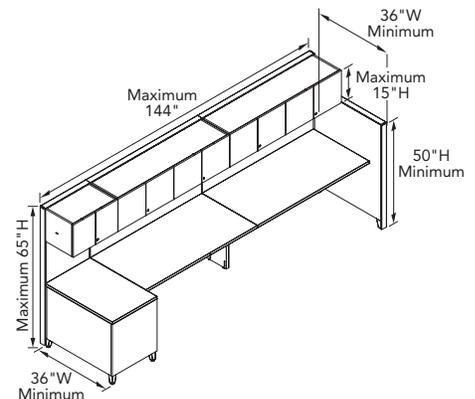

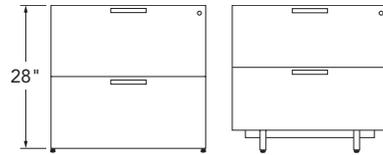

Approach components utilize Involve storage to panel brackets to tie storage into panel slotted standards. (Will not attach to Concensys panel system.)

28"H BACK-MOUNTED CREDENZAS

28"H Plinth Base
Finished Back
No Trough
K630PBKL + K630PBKR

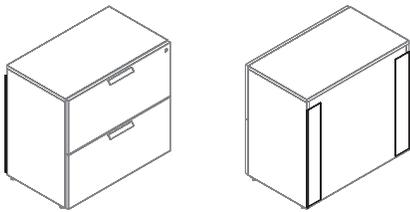

28"H Footed
Finished Back
No Trough
K624PBKL + K624PBKR

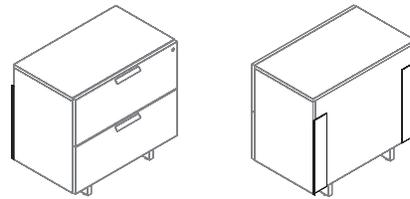
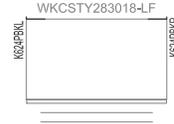

28"H Plinth Base
Un-Finished Back
With Trough
K630PBKML + K630PBKMR

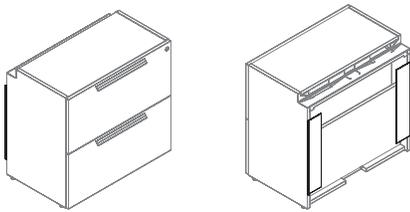
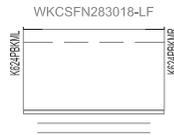

28"H Footed
Un-Finished Back
With Trough
K624PBKML + K624PBKMR

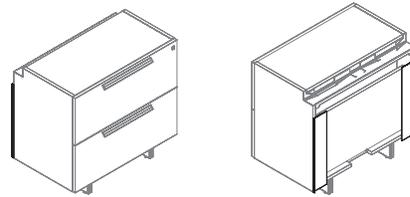
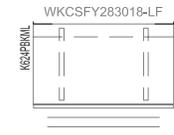

28"H SIDE-MOUNTED CREDENZAS

28"H Plinth Base
Finished Back
With Trough
K630PBKL + K630PBKR

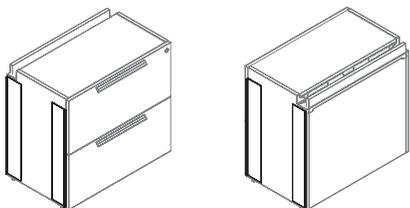
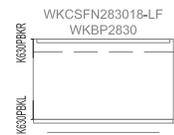

28"H Footed
Finished Back
With Trough
K624PBKL + K624PBKR

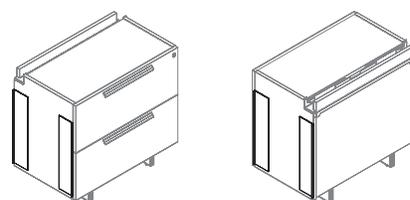
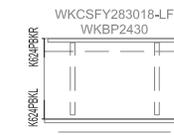

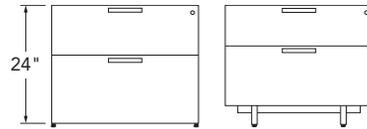

Approach components utilize Involve storage to panel brackets to tie storage into panel slotted standards. (Will not attach to Concensys panel system.)

24"H BACK-MOUNTED CREDENZAS

24"H Plinth Base
Finished Back
No Trough
K624PBKL + K624PBKR

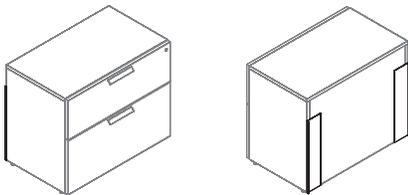

24"H Footed
Finished Back
No Trough
K624PBKL + K624PBKR

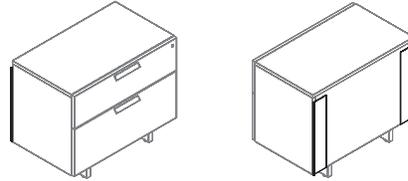
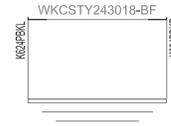

24"H Plinth Base
Un-Finished Back
With Trough
K624PBKML + K624PBKMR

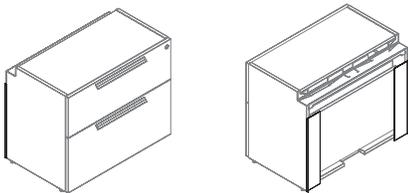

24"H Footed
Un-Finished Back
With Trough
K624PBKML + K624PBKMR

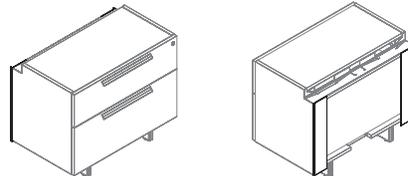
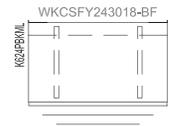

APPROACH

24"H SIDE-MOUNTED CREDENZAS

24"H Plinth Base
Finished Back
With Trough
K624PBKL + K624PBKR

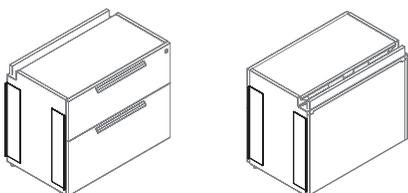
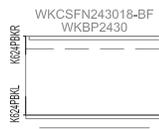

24"H Footed
Finished Back
With Trough
K624PBKL + K624PBKR

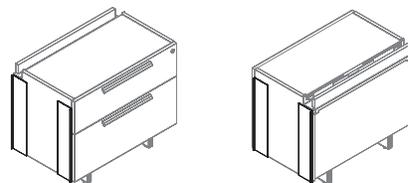
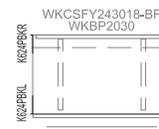

Approach General Construction

- Cases are made of ¾" particle board with 0.5mm edgeband. Worksurfaces and end supports are made of 1½" particle board with 2mm edgeband and laminate on both sides of all surfaces.
- Matching laminate fronts — all vertically stacked sets have grain matched parts. Horizontally adjacent units do not match.
- Box and file drawers are miter fold, ½" thick particle board.
- All Drawers lock
 - Lock is located in the top right corner of upper drawer on credenzas, desks, and skinny peds. Drawer locks all drawers in the vertical stack.
 - Mobile ped lock is in upper right corner of bottom drawer.
 - Omit core and keyed alike options. Omit core option ships with standard lock cores installed, customer is credited to order keyed alike cores to be replaced at installation.
 - Lock core color is Matte Silver.
- For door-locking, see product categories for details.
- All drawer units have holes drilled for pulls
 - User selects pull choice of beam, halo, square, arch, or bar. Beam and Halo available in Designer White, Silver, Pyrite, and Solar Black. Square pull available in Designer White, Flint, Loft, Matte Silver, Pyrite, and Solar Black. Bar pull available in Designer White, Silver, or Black.
 - Pulls are 1" to hole center from top of drawer.
 - Drawer bodies are light woodgrain finish with Black hangrails.
- Adjustable shelves are ¾" laminate and have 3 hole adjustable positions with 1¼" (32mm) hole spacing. One above and one below location specified in internal dimensioning table.
- Left-hand (LH) hinged units have hinges located on the left of the unit, right-hand (RH) hinged units have hinges on the right.
- Case end panels are the same depth regardless if fronts are assembled.
- Some models require counterweight — see specification table on pages [180-181](#).

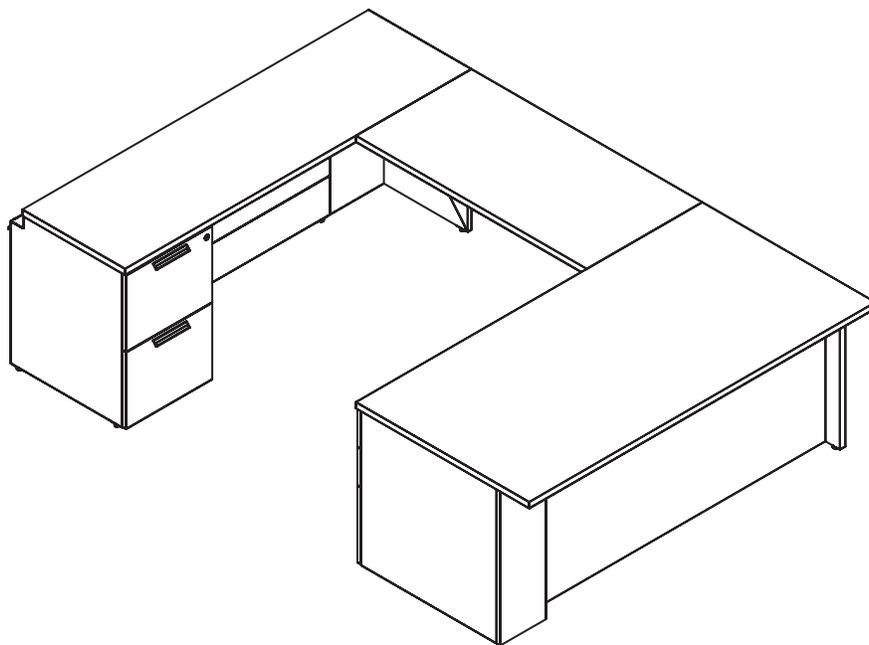

Counterweights

Counterweight(s) may need to be added to Approach credenzas and storage depending on configuration and usage. Models that may require counterweights are flagged with a number sign # following the model number in the pricing section. Reference model and intended usage column in chart below. Some models require two counterweights. Open shelf and hinged door models do not require counterweights and are not listed.

Approach Counterweight Kits — See page 244

Model	Description	List Price
WKCACW25	25 lb. Counterweight Kit	\$ 314
WKCACW35	35 lb. Counterweight Kit	\$ 420
WKCACW50	50 lb. Counterweight Kit	\$ 472
WKCACW65	65 lb. Counterweight Kit	\$ 559

Model #	*Freestanding Unit Needs	**Freestanding With Worksurface Needs	***Connected by Worksurface Needs
Full-Height Single Credenzas (28"H x 30"W)			
WKCST □ WKCSFN283018-LF	50	50	
WKCST □ WKCSFN283018-MF	50	35	
WKCST □ WKCSFN283018-OSBF	65	50	
WKCST □ WKCSFY283018-BBF	65+50	50+50	
WKCST □ WKCSFY283018-LF	50+50	50+35	
WKCST □ WKCSFY283018-MF	50	35	
WKCST □ WKCSFN283024-LF	65	50	
WKCST □ WKCSFN283024-MF	50	35	
WKCST □ WKCSFN283024-OSBF	65	50	
WKCST □ WKCSFY283024-BBF	50+35	50+25	
WKCST □ WKCSFY283024-LF	35	25	
WKCST □ WKCSFY283024-MF	50	35	
Full-Height Single Credenzas (28"H x 36"W)			
WKCST □ WKCSFN283618-LF	50	35	
WKCST □ WKCSFN283618-OSBF	50	35	
WKCST □ WKCSFY283618-BBF	65+50	50+50	
WKCST □ WKCSFY283618-LF	50	35	
WKCST □ WKCSFN283624-LF	60	50	
WKCST □ WKCSFN283624-OSBF	50	35	
WKCST □ WKCSFY283624-BBF	50+35	50+25	
WKCST □ WKCSFY283624-LF	65	50	
Full-Height Double Credenzas (28"H x 60"W)			
WKCUT/WKCUFN286018-HDLF	25	25	
WKCUT/WKCUFN286018-LFHD	25	25	
WKCUT/WKCUFN286018-LFLF	50+50	65	
WKCUT/WKCUFN286018-LFOS	25	25	
WKCUT/WKCUFN286018-OSLF	25	25	
WKCUT/WKCUFY286018-HDLF	35	25	
WKCUT/WKCUFY286018-LFHD	35	25	
WKCUT/WKCUFY286018-LFLF	50+50	50+35	25
WKCUT/WKCUFY286018-LFOS	35	25	
WKCUT/WKCUFY286018-OSLF	35	25	
WKCUT/WKCUFN286024-HDLF	25	25	
WKCUT/WKCUFN286024-LFHD	25	25	
WKCUT/WKCUFN286024-LFLF	65	50	
WKCUT/WKCUFN286024-LFOS	25	25	
WKCUT/WKCUFN286024-OSLF	25	25	
WKCUT/WKCUFY286024-HDLF	25		
WKCUT/WKCUFY286024-LFHD	25		
WKCUT/WKCUFY286024-LFLF	65+65	50+25	25
WKCUT/WKCUFY286024-LFOS	25		
WKCUT/WKCUFY286024-OSLF	25		

* Freestanding unit is considered a unit only in contact with the floor via the glides/feet

** Freestanding with worksurface is considered a freestanding unit with a worksurface the same width and depth as the unit itself. (i.e., 30W x 24D unit with a 30W x 24D credenza worksurface applied to the top.

*** Connected by worksurface refers to a 30/36W credenza unit, connected to another credenza unit that is non-drawerred via properly installed worksurface.

For No-Trough Units (WKCSTXXXXXXXX-XXXX and WKCUTXXXXXXXX-XXXX), reduce counterweights by 25 lbs. Round up to closest counterweight set if needed, unless zero. Troughless 42" - 48" wide credenzas do not require counterweight.

Model #	*Freestanding Unit Needs	**Freestanding With Worksurface Needs	***Connected by Worksurface Needs
Full-Height Double Credenzas (28"H x 72"W)			
WKCUT/WKCUFN287218-HDLF	25	25	
WKCUT/WKCUFN287218-LFHD	25	25	
WKCUT/WKCUFN287218-LFLF	50+25	50	
WKCUT/WKCUFN287218-LFOS	25	25	
WKCUT/WKCUFN287218-OSLF	25	25	
WKCUT/WKCUFY287218-HDLF	25	25	
WKCUT/WKCUFY287218-LFHD	25	25	
WKCUT/WKCUFY287218-LFLF	65+65	50+50	25
WKCUT/WKCUFY287218-LFOS	25	25	
WKCUT/WKCUFY287218-OSLF	25	25	
WKCUT/WKCUFN287224-HDLF	25	25	
WKCUT/WKCUFN287224-LFHD	25	25	
WKCUT/WKCUFN287224-LFLF	50+25	50	
WKCUT/WKCUFN287224-LFOS	25	25	
WKCUT/WKCUFN287224-OSLF	25	25	
WKCUT/WKCUFY287224-HDLF	25	25	
WKCUT/WKCUFY287224-LFHD	25	25	
WKCUT/WKCUFY287224-LFLF	50+50	65	25
WKCUT/WKCUFY287224-LFOS	25	25	
WKCUT/WKCUFY287224-OSLF	25	25	
Low-Height Single Credenzas (24"H x 30-36"W)			
WKCST/WKCSFN243018-BF	50	35	
WKCST/WKCSFN243018-MF	65	50	
WKCST/WKCSFN243618-BF	50+25	65	
WKCST/WKCSFY243018-BF	35+25	50	
WKCST/WKCSFY243618-BF	35+25	50	
WKCUT/WKCUFY246018-OSBF	50	35	
Low-Height Double Credenzas (24"H x 60"W)			
WKCUT/WKCUFN246018-BFBF	50+50	65	25
WKCUT/WKCUFN246018-BFHD	35	25	
WKCUT/WKCUFN246018-BFOS	35	25	
WKCUT/WKCUFN246018-HDBF	35	25	
WKCUT/WKCUFN246018-OSBF	35	25	
WKCUT/WKCUFY246018-BFBF	65+65	50+50	25
WKCUT/WKCUFY246018-BFHD	50	35	
WKCUT/WKCUFY246018-BFOS	50	35	
WKCUT/WKCUFY246018-HDBF	50	35	
Low-Height Double Credenzas (24"H x 72"W)			
WKCUT/WKCUFN247218-BFBF	65+65	50+50	25
WKCUT/WKCUFN247218-BFHD	25	25	
WKCUT/WKCUFN247218-BFOS	25	25	
WKCUT/WKCUFN247218-HDBF	25	25	
WKCUT/WKCUFN247218-OSBF	25	25	
WKCUT/WKCUFY247218-BFBF	65+65	50+50	25
WKCUT/WKCUFY247218-BFHD	35	25	
WKCUT/WKCUFY247218-BFOS	35	25	
WKCUT/WKCUFY247218-HDBF	35	25	
WKCUT/WKCUFY247218-OSBF	35	25	
Pedestals (28"H x 18"W)			
WKPSFN281818-BBF	25		
WKPSFN281824-BBF	25		
WKPSFN281818-FF	25		
WKPSFN281824-FF	25		

* Freestanding unit is considered a unit only in contact with the floor via the glides/feet

** Freestanding with worksurface is considered a freestanding unit with a worksurface the same width and depth as the unit itself. (i.e., 30W x 24D unit with a 30W x 24D credenza worksurface applied to the top.

*** Connected by worksurface refers to a 30/36W credenza unit, connected to another credenza unit that is non-drawerred via properly installed worksurface.

For No-Trough Units (WKCSTXXXXXXXX-XXXX and WKCUTXXXXXXXX-XXXX), reduce counterweights by 25 lbs. Round up to closest counterweight set if needed, unless zero. Troughless 42" - 48" wide credenzas do not require counterweight.

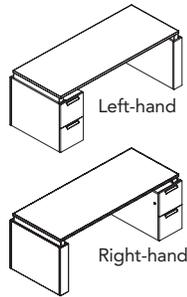

Pedestal/Shroud Height-Adjustable Desk (page 202)

- New models available April 2021 for A6 2 stage compatibility, see specification page for model transition.
- Available in RH and LH orientations, hand is determined by location of ped, RH Ped = RH Desk.
- 72" W x 36" D, 72" W x 30" D, and 66" W x 30" D desks available.
- Both depths include same 30" D support shroud and RH or LH pedestal shroud.
- Desk footprint dimensions are nominal. Example: 72" W x 30" D required for space planning. Worksurfaces are undersized by 1" on all sides to prevent pinch points when raising and lowering worksurface.
- Load capacity is 250 pounds, including the worksurface and metal shrouds.
- Laminate finish options include top, chassis, and front.
- User can specify grommet locations (L Left, R Right, B Both, C Centered, X None). See page 186.
- No slide glide option due to application.
- Single order desk models include HAT bases which are PR6 silver.
- Laminate shroud remains on the ground with 2" of leveling.
- Metal shroud, available in standard paint colors, attaches to and rises with worksurface.
- Laminate File/File ped is fixed with 3/4" of leveling.
- Both drawers lock via side lock.
- Height-adjustable mechanism provides 27 3/4" -47 3/8" min/max adjustability.
- Height-adjustable mechanism is same as used on A6 Altitude® tables. Reference the Altitude series in Desking and Tables price list for additional specification information.
- Standard up/down control shipped with unit.
- Memory Controls are now a .option.
- Up/Down: Basic Up/Down control.
- Memory Control: 4 memory pre-set options allow the user to adjust their height to their preferred heights.
- Paddle: Simple, aesthetic control with 1 memory pre-set option and reminder mode.
- Foot Control: Basic up/down wireless, hands free control. Can be paired with hand controls for multi-control option.
- Ships flat in multiple cartons for field assembly.
- Specify optional floating worksurface modesty panel 24" shorter than worksurface width.
- Modesties are non-handed and mount to the external stiffener included with the unit.
- Anti collision available on desking models April 2021.

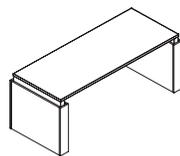

Double Shroud Height-Adjustable Desk (page 202)

- New models available April 2021 for A6 2 stage compatibility, see specification page for model transition.
- 72" W x 36" D, 72" W x 30" D, and 66" W x 30" D desks available.
- Both depths use same 30" D support shroud.
- Desk footprint dimensions are nominal. Example: 72" W x 30" D required for space planning. Worksurfaces are undersized by 1" on all sides to prevent pinch points when raising and lowering worksurface.
- Laminate finish options include top, chassis, and front.
- User can specify grommet locations (L Left, R Right, B Both, C Centered, X None). See page 186.
- Laminate shroud is fixed with 2" of leveling.
- Metal shrouds available in standard paint colors, attach to and rise with worksurface.
- Height-adjustable mechanism provides 27 3/4" -47 3/8" min/max adjustability.
- Height-adjustable mechanism is same as used on A6 Altitude® tables. Reference the Altitude series in Tables and Desking price list for additional specification information.
- Standard up/down control shipped with unit.
- Memory Controls are now a .option.
- Up/Down: Basic Up/Down control.

- Memory Control: 4 memory pre-set options allow the user to adjust their height to their preferred heights.
- Paddle: Simple, aesthetic control with 1 memory pre-set option and reminder mode.
- Foot Control: Basic up/down wireless, hands free control. Can be paired with hand controls for multi-control option.
- Ships flat in multiple cartons for field assembly.
- Specify optional floating worksurface modesty panel 12" shorter than worksurface width.
- Modesties are non-handed and mount to the external stiffener included with the unit.
- Anti collision available on desking models April 2021.

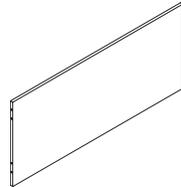

Fixed Layered Height Modesty For Height Adjustable Desks:

- Fixed laminate modesty for height adjustable table (24"H AFF) and metal hanging backdrop modesty compatible with double shroud height adjustable desks.
- Fixed laminate modesty for height adjustable tables is inset 3" between standard shrouds with a bracket visible under the work surface on the user side.
- Connection bracket is available in Allsteel standard paints.

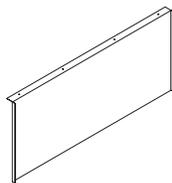

Metal Hanging Modesty for Height Adjustable Desks:

- Metal hanging modesty (offered in Flint) mounts to the worksurface nested to the stiffener and has 1" distance from fixed laminate modesty.
- Metal hanging modesty is 8¼" less in width than the worksurface to avoid interference has reveal on each side between shroud metal and metal modesty.
- Metal modesty has bent side folds for a clean curved aesthetic from the guest side.

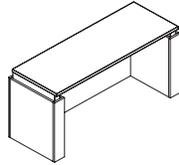

24" D Height-Adjustable Work Wall Desk with Full-Height Modesty Panel (page 202)

- New models available April 2021 for A6 2 stage compatibility, see specification page for model transition.
- Specifically designed for wall facing application to keep cords hidden from sight.
- True shroud depth of 22" and worksurface depth of 21".
- 48", 54", 60", 66", and 72" W desks available.
- Desk footprint dimensions are nominal. Example: 72" W x 24" D required for space planning. Worksurfaces are undersized by 1" on all sides to prevent pinch points when raising and lowering worksurface.
- Laminate finish options include top, chassis, and front.
- User can specify grommet locations (L Left, R Right, B Both, C Centered, X None). See page 186.
- Includes laminate shrouds fixed with 2" of leveling.
- Metal shrouds available in all standard Allsteel paint colors attach to and rise with worksurface.
- Laminate modesty ties into the laminate shrouds and remains on the ground. Modesty has unfinished back and is intended to be used against a wall.
- Metal modesty (Flint only) attaches and rises with the worksurface.
- Height-adjustable mechanism provides 27¼"-47½" min/max adjustability.
- Height-adjustable mechanism is same as used on A6 Altitude® tables. Reference the Altitude series in Desking and Benching price list for additional specification information.
- Standard up/down control shipped with unit.
- Memory Controls are now a .option.
- Up/Down: Basic Up/Down control.
- Memory Control: 4 memory pre-set options allow the user to adjust their height to their preferred heights.
- Paddle: Simple, aesthetic control with 1 memory pre-set option and reminder mode.
- Foot Control: Basic up/down wireless, hands free control. Can be paired with hand controls for multi-control option.
- Ships flat in multiple cartons for field assembly.
- Anti collision available on desking models April 2021.

Credenza for Integrated Height Adjustable Table (page 207)

- 60" W and 72" W x 18" D and 24" D sizes available.
- Laminate finish options include top, chassis, and front.
- Credenzas for HAT are non-handed and configurable at installation. The three units included in these Credenzas are shipped separately (open credenza, box/file credenza, and top).
- User can adjust credenza orientation by reversing top and credenzas of base model at install. Example: Top scallop and open file on right side or top scallop and open file on left side.
- Credenzas for HAT compatible with 2-stage C and T base HAT tables to be ordered separately.
- Height-adjustable mechanism chosen should provide 27¼" as it's minimum.
- Altitude tables height-adjustable mechanism is compatible. Reference the Altitude series in Tables price list for additional specification information.
- Credenzas for HAT are non-footed with finished backs and no trough.
- Drawer stacked units have mechanical interlock, allowing only one drawer to open at a time.
- Shortest distance from edge of scallop is consistent across all tops. Scallop dimensions the same across all HAT tops. Depth of Scallop is 5".
- Compatible with A6
- Footed units come with a black recessed center foot.

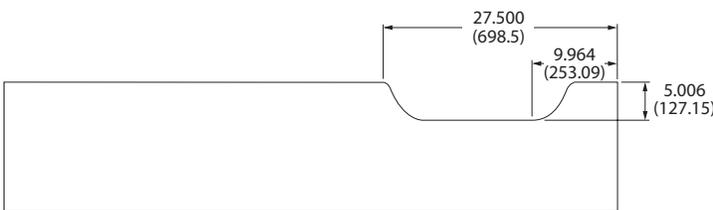
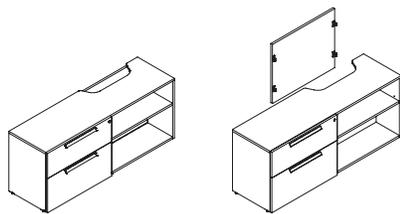

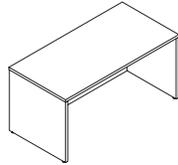

Shell Desks (page 203)

- Units ship knocked down for field assembly.
- Units are 29"H x 30"D, available in 60", 66" and 72"W.
- Laminate finish is the same for top, end panels and modesty.
- Only full-height modesty options available.
- Standard worksurface grommet options and placement.
- Full height laminate modesty is inset 3½" on guest side.

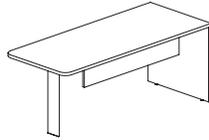

Racetrack Top Desks with End Panel, Half-Height Modesty, and Column Base (page 203)

- 30"D, non-handed.
- 72" and 66"W models have end panel support, 29½"H support column, and bracket to attach to a worksurface or desk.
- 48", 54", and 60"W models have 29½"H support column.
- Column support end has 3" round corners.
- Racetrack modesty is 18" shorter than worksurface length.
- Ships flat in multiple cartons for field assembly.

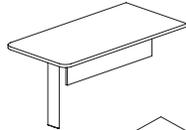

O-leg Table Desks (page 203)

- 30"D x 66" or 72"W.
- A variety of standard Allsteel paint colors.
- User can specify grommet locations (L Left, R Right, B Both, C Centered, X None). See page 186.
- O-legs installed on both ends of worksurface are inset ¼" from end of worksurface.
- See notes on O-leg for leveling and dimensions.
- 14"H half-height modesty is 12" shorter than worksurface width. Attaches to external stiffener on worksurface.
- Ships flat in multiple cartons for field assembly.

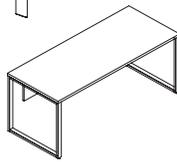

Double Ped Desk (page 204)

- 36"D x 72"W, ped base is 29¼"D.
- Laminate finish options include top, chassis, and front.
- User can specify grommet locations (L Left, R Right, B Both, C Centered, X None). See page 186.
- Box/Box/File on left and File/File on right from main user view.
- Full height modesty, ties into both ped end panels 9" from back of worksurface. Modesties go to the floor and match end panel height.

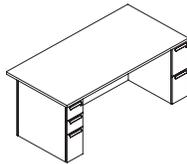

Single Ped Desks (page 204)

- Right- and left-hand versions
- RH = ped on right side from main user view
- LH = ped on left side from main user view
- Laminate finish options include top, chassis, and front.
- User can specify grommet locations (L Left, R Right, B Both, C Centered, X None). See page 186.
- Ped Desks available with 9"W and 15"W Ped Options.
- Box/Box/File only — slim peds (9½" width), see notes on slim peds for dimensions and leveling.
- Box/Box/File and File/File configurations available for the 15"W Pedestal.
- Panel base (1½" thick) is opposite the storage.
- 14"H half- or full-height modesty panel options, designated by dot option. Modesty panel ties into both end panel and pedestal.
- 30"D x 60", 66", or 72"W
 - Ped and panel base are both 29¼" in depth.
 - Modesty panel is 3" from back of worksurface.
- 36"D x 72"W
 - 36"D X 72"W available with 9"W Ped ONLY.
 - Ped base is 29¼" deep. Panel base is 35¼" deep.
 - Modesty panel is 9" from back of worksurface.

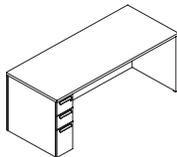

GROMMET SPECIFICATIONS



Grommets

Plastic grommets are made of durable ABS plastic and match edge color of laminate worksurfaces. Metal grommets are available in oval or square in Matte Silver.

Grommet Position Option Codes

- B** Both Left and Right — Pair of grommets each 10" from side edge – 5/8" from approach side to grommet edge; 7/4" from rear to grommet center.
- C** Centered Side-to-Side — One grommet 5/8" from approach side to grommet edge; 7/4" from approach side to grommet center.
- L** 10" from Left Side — 5/8" from approach side to grommet edge; 7/4" from approach side to grommet center.
- R** 10" from Right Side — 5/8" from approach side to grommet edge; 7/4" from approach side to grommet center.
- X** No grommet.

Note: On 36"D tops, approach side to grommets is 11 3/8". See 36"D illustration below.

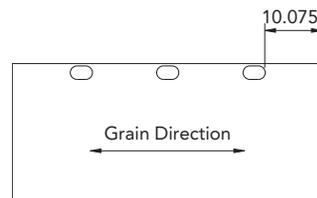
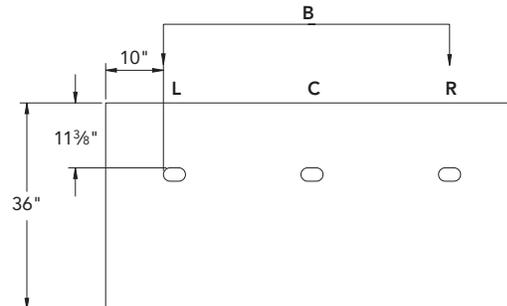
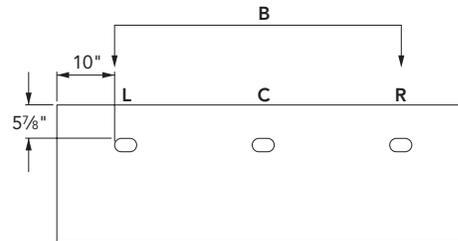

Credenza Top

Grommet positions other than those shown above are considered non-standard. Location allows ease of install for offered support, i.e. O-Leg, Column, and Panel.

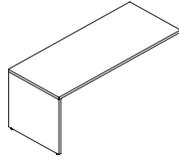

Support Panel Run-off Desks (page 203)

- 30"D x 48", 54", 60", 66", and 72"W
- Right- and left-hand models.
- Laminate finish options include top and chassis.
- User can specify grommet locations (L Left, R Right, B Both, C Centered, X None). See page 186.
- Support Panel is 1½" thick.
- 14"H half-height modesty attaches to end panel, 3" from back of worksurface. Modesty is ¼" short on opposite end of support.
- Run-off desks are able to attach to existing single ped desk or racetrack top desk with end panel.
- Ships flat in multiple cartons for field assembly.

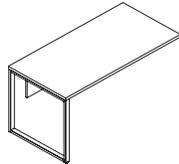

O-leg Run-off Desks (page 203)

- 30"D x 48", 54", 60", 66", 72", 78", and 84"W
- Non-handed, O-leg can be installed on either side of worksurface.
- Laminate finish options include top and chassis.
- User can specify grommet locations (L Left, R Right, B Both, C Centered, X None). See page 186.
- See notes on O-leg for leveling and dimensions.
- 14"H half-height modesty is 12" shorter than worksurface width. Attaches to external stiffener included with worksurface.
- Ships flat in multiple cartons for field assembly.

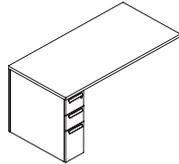

Pedestal Run-off Desks (page 204)

- 30"D x 48", 54", 60", 66", or 72"W
- Right- and left-hand models.
- Laminate finish options include top, chassis, and front.
- User can specify grommet locations (L Left, R Right, B Both, C Centered, X None). See page 186.
- Box/Box/File only — slim peds (9½" width), see notes on slim peds for dimensions and leveling.
- 14"H half-height modesty panel attaches to ped end of panel 3" in from back of worksurface. Modesty is ¼" short on opposite end of support.
- Run-off desk can attach to existing single ped desk or racetrack top desk with end panel.

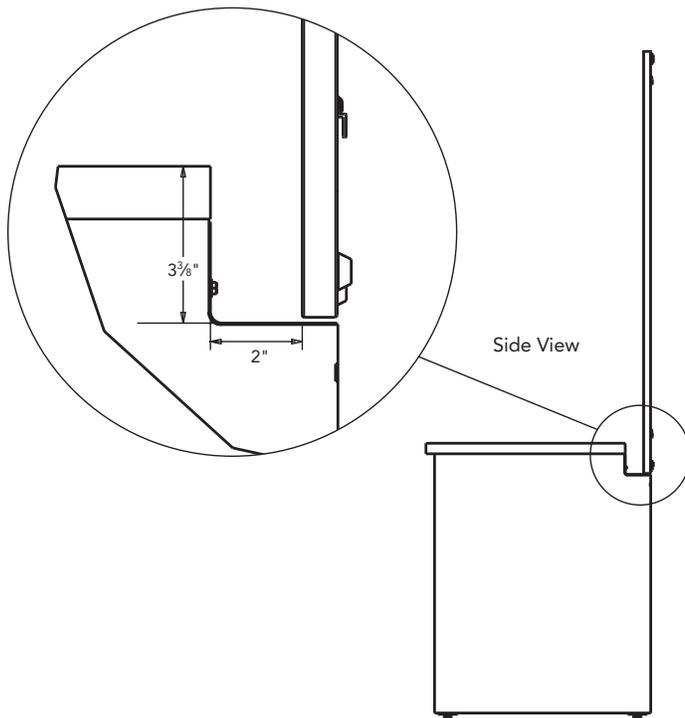
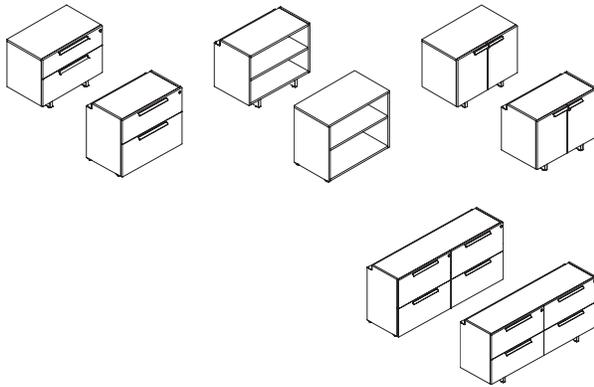

Credenzas (pages 207-215)

- 30" W and 36" W units contain single column of drawers, open cavity or hinged doors. 42", 48", 60", and 72" W units contain two columns of drawers, open cavities, hinged doors, or a combination of both.
- Full height 28 3/8" H, footed and non-footed, 18" D and 24" D. 29 1/2" H with added credenza worksurface.
- Layered height 24 3/4" H, footed and non-footed, 18" D. 25 5/8" H with added credenza worksurface.
- Trough credenzas have inset top construction where no-trough credenzas have top over construction.
- Laminate finish options include chassis and front.
- Multi File units feature a cubby at the top left of the top project drawer with lateral drawer front. This allows for many applications and concealed storage.
- All credenza units contain 1 1/2" adjustable glides
- All units can be standalone with or without credenza top.
- Full extension file drawers extend 13 1/4" on 18" D models, and 17 1/4" on 24" D models.
- Some models require counterweight – see specification table on pages 180-181.
- Vertically stacked units have mechanical interlock, allowing only one drawer to open at a time. Exception is Box/Box/File which allows bottom file drawer and top box drawers to open at the same time.
- Trough available for power application and no-trough available for open plan applications.
- Wire management trough
 - Trough is 2" D x 3 3/8" H with tackboard, see illustration at left.
 - Accessories available (ordered separately): Byrne mini tap, monitor arm, clamp style, light.
- No-trough credenzas have top over construction and have finished backs.
- Finish height is consistent across both trough and no-trough units, example both troughed and no-trough 28" H units are the same height.
- All other credenza models have a finished back option available for order. See page 218.
- Two styles of feet are available, post and blade feet.
 - Blade Feet are recessed 6" in from each side on 30" and 36" units, and 8 1/2"-9 1/2" in from each side on 42"-72" units.
 - Post feet are inset 1 1/8" from each side of unit across all units.
- Center stability foot is included on units 60" W and larger.
- No ganging option available.
- Unit's ship assembled except for feet and pulls.



Mobile Pedestal (page 205)

- 21 1/2" H x 15 3/4" W x 20" D.
- Laminate finish options include chassis and front.
- Box/File drawer configuration.
- Front-to-back filing capable without use of rails.
- Side-to-side filing available with use of file hangrails (included).
- Casters are recessed to provide clean aesthetic.
- Units ship assembled except casters and pulls.



24" H Pedestal (page 205)

- 24 3/4" H x 18" W x 18" D.
- 25 5/8" H with added laminate worksurface.
- Laminate finish options include chassis and front.
- Box/File drawer configuration.
- Front-to-back letter filing capable with use of file hangrail (included).
- Side-to-side letter filing available without use of rails.
- No interlock between drawers.
- Counterweight may be needed. See pages 180-181.
- Finished backs available, see page 218.
- Units ship assembled except pulls.

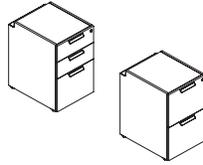

Support Pedestals (page 205)

- 28³/₈"H x 18"W x 18" or 24"D.
- Box/Box/File and File/File drawer configurations.
- Laminate finish options include chassis and front.
- Same construction as credenza units.
- Support Pedestals with wire management trough do not have back panels.
- No interlock between drawers.
- Counterweight may be needed. See pages 180-181.
- Finished backs available, see page 218.
- Units ship assembled except pulls.

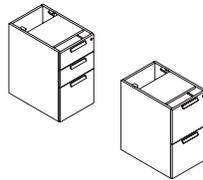

15"W Support Pedestal (page 206)

- 28³/₈"H x 15"W x 24" or 30"D.
- Box/Box/File or File/File configurations available.
- Laminate finish options include chassis & front.
- Units must be mounted under worksurface, hardware included.
- Units have finished backs.
- Footed & Non-Footed configurations available. Overall Heights remain the same.
- No interlock between drawers.
- Glides provide 1¹/₂" adjustment.
- Units Ship assembled except pulls.

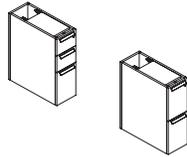

Slim Pedestals for Freestanding Desks (page 205)

- 28³/₈"H x 9¹/₂"W x 24" or 30"D.
- Box/Box/File and File/File drawer configurations.
- Laminate finish options include chassis and front.
- Units must be mounted under worksurface, hardware included.
- Support Pedestals without wire management trough have back panels.
- Side-to-side filing available with hangrail (included). Narrow width does not permit front-to-back filing.
- Glides provide ³/₄" of adjustment
- Units ship assembled except pulls.

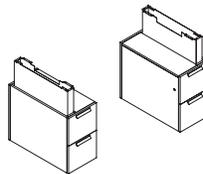

Slim Pedestal Shroud Kits (page 205)

- New models available April 2021 for A6 2 stage compatibility, see specification page for model transition.
- File/File only drawer configuration, available in left- and right-hand options determined from the primary user perspective.
- Both drawers lock via side lock.
- Includes laminate pedestal that remains on the ground and metal shroud, available in all standard Allsteel paint colors, that rises with the worksurface. Requires Altitude® 2-stage, A6 C-leg or A6 T-leg electric powered base purchased separately, see page 246.
- Pedestal is 14¹/₄"W x 30"D x 24"H with ³/₄" of leveling.
- Metal shroud elevates with worksurface 27³/₄"–47³/₈"H.
- Can be used in any combination of supports: Open T-Leg, C-Leg, Laminate Shroud, Slim Pedestal Shroud.
- The shroud fits over the height-adjustable leg of a 2" x 3" column.

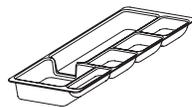

15W Box Drawer Pedestals and Accessory (page 206)

- Box drawers do not include pencil tray.
- Order pencil tray separately - A2280-000

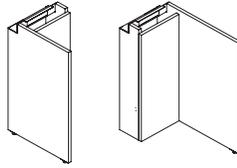

False Ped (page 221)

- 12" W x 28³/₈" H
- End panel depth is 14", 18", or 24" D.
- LH and RH options.
- Designed to be used adjacent to wall access panel.
- Aligns with wall access panel.
- Used to continue wire trough and to support the end of credenza top.
- 14" D false ped worksurface must be supported on opposite end by a full-depth support.
- Maximum unsupported worksurface span is 48" with 14" D models, and 72" with 18" D and 24" D models.
- Metal wire trough ships separately and attaches directly to worksurface.

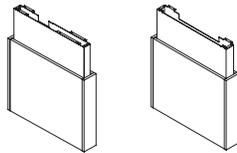

Height-Adjustable Shroud Kits (page 246)

- New models available April 2021 for A6 2 stage compatibility, see specification page for model transition.
- Available in non-handed for simple specification and optimal reconfigurability.
- Includes laminate shroud that remains on the ground and metal shroud, available in standard Allsteel paints, that rises with the worksurface. Requires Altitude® 2-stage, A6 C-leg or A6 T-leg electric powered base purchased separately, see page 246.
- Laminate shroud is 5⁵/₈" x 30" D x 24" H with 2" of leveling.
- Metal shroud elevates with worksurface 27³/₄"–47³/₈" H.
- Can be used in any combination of supports: Open T-Leg, C-Leg, Laminate Shroud, Slim Pedestal Shroud.
- The shroud fits over the height-adjustable leg of a 2" x 3" column purchased separately.
- Models available April 2021 for A6 height adjustable 2-stage bases.

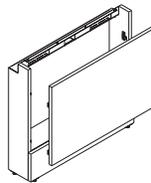

Wall Access Panel (page 221)

- Designed to be used adjacent to false ped or supported by another unit such as tower or credenza and is non-handed.
- 18-48" W x 6¹/₂" D x 28³/₈" H.
- ³/₄" removable front.
- Metal wire trough ships separately and attaches directly to worksurface.

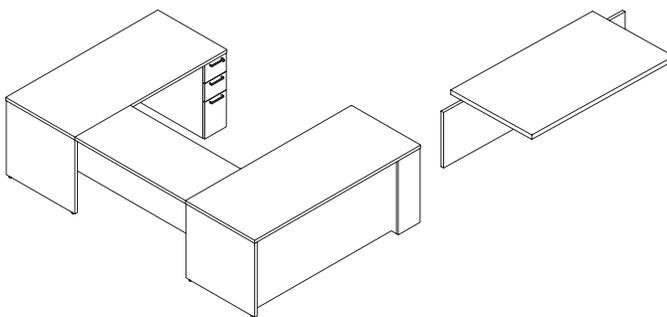

Bridge (page 221)

- 24" D x 42" W or 48" W.
- 48" W bridge ships with external support stiffener.
- Comes with 14" H half-height modesty panel, which is 12" wider than the worksurface.
- Flat brackets onto both sides of fixed height adjacent units.
- To mount, use a flat bracket on both sides fixed to an adjacent unit. Flat brackets are included for ease of installation.



Back Panels (page 218)

- All credenzas have a finished back option available for order, see page 218.
 - All back panels are inset of credenza end panels.
 - Back panels include a filler piece for a clean back. Specify color options at time of order entry (colors are Black, Designer White and Silver to match pull or feet colors).
- 3 Heights available.
 - 20" is used on 24"H footed models, ex: **WKCSFY243018-BF**
 - 24" is used on 24"H non-footed models, ex: **WKCSFN243018-BF**
 - 24" is used on 28"H footed models, ex: **WKCSFY283624-LF**
 - 28" is used on 28"H non-footed models, ex: **WKCSFN283624-LF**

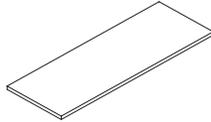

Credenza and Pedestal Tops (page 216)

- Tops are 1½" thick with 2mm Edgeband.
- Tops ship with double sided tape supplied in hardware packs.
- Double sided tape attach tops to top of credenza and pedestal units.
- Tops must cover at least one storage unit and may span multiple.
- External stiffeners need to be added to credenza tops if they are spanning a distance greater than 60".
- Shortened Tops for Trough Units
 - Depth is shortened by 2½" less than listed to accommodate wire management trough.
 - 18"D models are 15½"D (2½" less than actual).
 - 24"D models are 21½"D (2½" less than actual).
- Full Depth Tops
 - Width & Depth is nominal to size, (example 24"–24.0").
 - Optional Grommet locations allow user access to the trough.
 - 18"–36" W tops have center grommet option only.
 - 42"–96" W tops can specify grommet locations (L Left, R Right, B Both, C Center, X None).
 - Grommets available in Oval plastic, Square Metal, or Oval Metal.
 - Use for covering trough or top for troughless units.

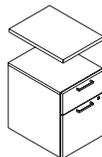

Credenza and Pedestal Cushions (page 216)

- A seat cushion can be placed on top of credenzas or 20"D mobile pedestals.
- Designed to fit flush with front of drawer fronts.
- Credenza cushions are undersized by 3" in depth to accommodate wire management trough, 18"D are actually 15"D.
- Seat cushion adds approximately 2"H to credenza or pedestal.

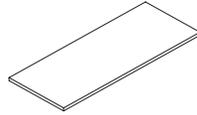

Primary Worksurfaces (page 224)

- All Worksurfaces are 1 1/8" thick with 2MM edgeband.
- Width and depth are nominal to size, (example 24" W or 24" D = 24.000").
- Units 48" W or greater ship with external support stiffener.
- User can specify grommet locations (L Left, R Right, B Both, C Centered, X None). See page 186.
- User can specify grommet material (Plastic Oval, Metal Oval, Metal Rectangular).
- Plastic oval grommets automatically match worksurface edgeband selection.
- Includes pilot holes for standard supports and modesty panel locations.

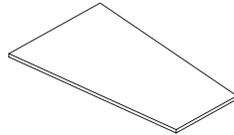

Double Sightline Surfaces (page 223)

- Double Sightline Surfaces: 6 sizes, measure as (Width, Depth 1, Depth 2).
- Reference the table base specifications in Seating, Collaboration & Tables price list for applicable models and size limitations
- Utilized mainly in team spaces, collaboration touch points, and/or a useful space division in the workplace if set with O-Leg or end-panel supports from a storage support.

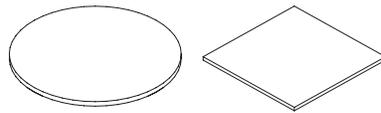
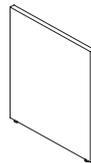

Table Top Worksurfaces (page 222)

- All Worksurfaces are 1 1/8" thick with 2MM Edgeband
- Reference table base specifications in Seating, Collaboration & Tables price list for applicable models and size limitations
- Square Surfaces: 36", 42", and 48" available.
- Round Surfaces: 36", 42", and 48" available.
- Approved with splay legs.



End Panels (page 227)

- 1 1/8" particleboard with laminate on both surfaces.
- 2MM edge band on all edges.
- End panels are used to create run-off set-ups.
- 14", 24", 30", and 36" depths. Actual depths are 13 3/4", 23 3/4", 29 3/4", and 35 3/4" D.
- RH and LH options used separately. Model supports one side of a worksurface, not both unless using a full height modesty.
- 14" D end panels can only be used with 24" D primary worksurfaces.
- 24" D, 30" D and 36" end panels require primary worksurface depths to match the end panel.
- Maximum worksurface length is 48" with 14" end panel, and 72" with 24", 30" and 36" end panels.
- Attaches to worksurface with cam/pin/dowel mechanical fastener, providing strength and stability to desking application.
- Must order same hand modesty panel to tie into support and worksurface.

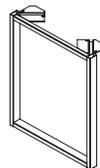
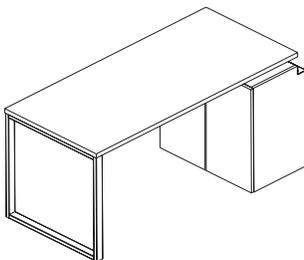

O-legs (page 225)

- 28 3/8" H x 24" D or 30" D.
- 1" x 2" steel tube construction welded to mounting brackets.
- Leveling glides with 2" of adjustability.
- Actual Depth is 23 3/4" and 29 3/4".
- Mounting plate width is 6", visual width is 2".

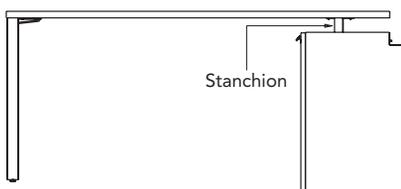

Stanchions (page 226)

- 12" and 18" D in two heights:
 - 24" D worksurface uses 12" D stanchion.
 - 30" D worksurface uses 18" D stanchion.
 - 36" D worksurface uses 2–12" D stanchions.
 - 4" H — credenza to primary worksurface
 - 3" H — credenza with top to primary worksurface
- Formed sheet metal construction, P02 Flint only.
- Attaches to upper worksurface with screws and industrial VHB tape to lower worksurface/credenza. See illustration at left. Stanchion is centered on credenza and when paired with a blade foot gives a floating aesthetic.

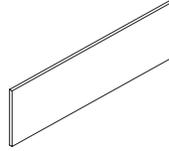

Modesty Panels (page 227)

- Horizontal Grain Direction:
 - 14"H x 30", 36", 42", 48", 54", 60", 66", and 72"W.
 - 28"H x 48", 54", 60", 66", 72"W.
- 14"H Modular, RH modesty panel and LH modesty panel version for laminate end panel, non-handed 14"H modesties used in all other applications.
- 14"H Modular mounts to worksurface stiffener with worksurface.
- RH and LH modesty panels must attach to RH or LH laminate end panel. Specify same hand as end panel.
- 28"H Modular, non-handed modesty panel version for laminate left and right end panel.

Splay Legs

Wood Splay Legs (page 225)

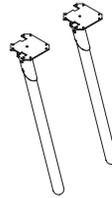

- Includes pair of legs (non-handed, mounted to top plate) and attaching hardware.
- Available in oak and walnut toned wood.
- Natural wood has variance between color and wood grain which is not the same visual as woodgrain laminate. Allsteel does not guarantee the exact matching of grain, pattern or color.
- Shroud available in standard paint selection.
- Used to support one corner of a worksurface or table.
- Standard worksurface support height
- Height adjustable legs provide a 1 7/8" range of adjustment.
- Splay legs are for use on worksurface spans up to 72"W.
- Height adjustable leveling feature requires common tools to adjust height.
- Optional push-pin glide and felt pad included in hardware pack.

Metal Splay Legs (page 225)

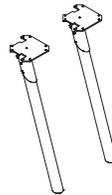

- Includes pair of legs (non-handed, mounted to top plate) and attaching hardware.
- Standard paint finish options include leg and shroud.
- Used to support one corner of a worksurface or table.
- Standard worksurface support height.
- Height adjustable legs provide a 1 7/8" range of adjustment.
- Splay legs are for use on worksurface spans up to 72"W.
- Height adjustable leveling feature requires common tools to adjust height.
- Floor protection provides 1/2" of additional adjustment.
- Approved for runoff or freestanding applications up to 72"W.

Freestanding Laterals (page 219)

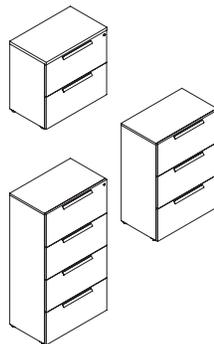

- Laminate finish options include chassis and front.
- Ships assembled except for pulls.
- No footed option available.
- Outside overall dimensions:
 - Heights: 2H = 29 1/2"H, 3H = 42 1/4"H, 4H = 56 1/8"H
 - Widths and Depths: 30"W and 36"W; 18"D and 24"D with the exception of 2H which is 18 3/8"D and 24 1/8"D.
- 2H has 1 1/8" top built-in to case construction. Cannot be used under a spanning top workwall of 28"H units.
- All units include interlock drawers.
- Inner drawer dimensions and filing configurations are the same as credenzas. See page 172.
- Full extension file drawers: 13 1/4"D on 18"D, and 17 1/4"D on 24"D models.
- Drawer unit ships with hangrail to accommodate side-to-side filing.

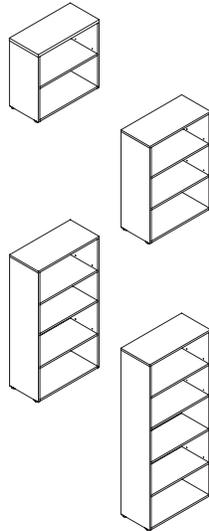

Freestanding Bookcase (page 220)

- Laminate finish options include chassis.
- Outside overall dimensions:
 - Width is nominal to dimension (i.e. 30"W = 30") with the exception of 2H which is 30.04"W
 - Heights: 2H = 29½"H, 3H = 42¼"H, 4H = 56⅝"H, 5H = 71⅝"H.
 - Depth: 15"D = 14¼"D actual.
- Shelves:
 - 2H – 1 adjustable shelf
 - 3H – 2 adjustable shelves
 - 4H – 2 adjustable, 1 fixed shelf at worksurface height
 - 5H – 3 adjustable, 1 fixed shelf at worksurface height
 - Internal shelves are ¾" laminate and adjustable to three levels.
- 2H bookcase has built-in 1⅝" top. Cannot be used under a spanning top workwall of 28"H units.
- 1½" adjustable glides
- Pin-and-cam fasteners visible from the front are covered with cam covers.
- No footed option available for bookcases.

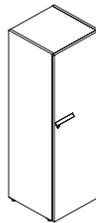

All Towers (page 237)

- Laminate finish options include chassis and front.
- Ships assembled except for pulls and side access towers which are assembled in field.
- 1½" adjustable glides on all except Open Access which have ½" adjustment.
- Footed and Non Footed Options Available.
 - Tower/Wardrobe models ending in HDL/H-HDL/CFL are available without feet only.
- 24"D x 24"W and 24"D x 30"W non-footed wardrobes and towers can be freestanding. Pullout towers can also be freestanding. All other wardrobes and towers are not for use in freestanding applications and must be ganged to adjoining units. All footed wardrobes and towers must be ganged to adjoining units.
 - Use included attachment hardware pack to attach through adjoining end panels utilizing the pilot holes underneath bottom-most shelf of wardrobe tower.
 - See instruction manual for installation steps.

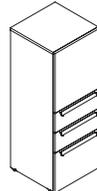

Left

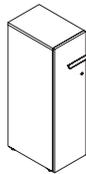

Left

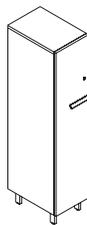

Left



Left

- Hinged door
 - Sizes Available:
 - Heights – 42½", 50", 57½", 65½", 72"
 - Widths – 12", 18" & 24"
 - Depths – 18" & 24"
 - 18"D Towers have 2 coat hooks in unit
 - 24"D Towers have a coat rod in unit, except models ending in HDL
 - 12" & 18" Wide have RH and LH configurations
 - 12" & 18" Wide towers have single door, 24" Wide has two doors non-handed
 - Shelving:
 - 42½" & 50" – 1 adjustable, 1 fixed
 - 57½" – 2 adjustable, 1 fixed
 - 65" & 72" – 3 adjustable, 1 fixed
 - Refer to page 164 for interior dimensions.

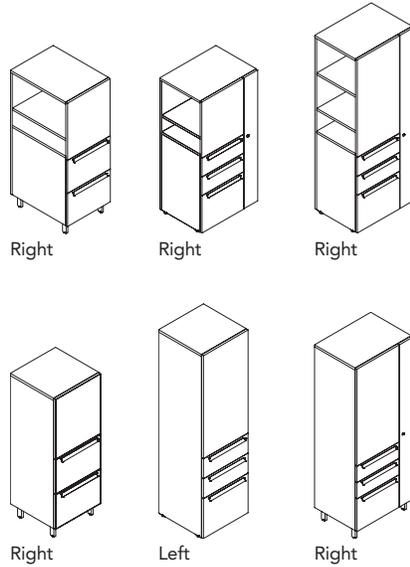

Towers—continued (pages 229-232 and 237)

- Personal Combination and Side Access
 - Sizes:
 - Heights – 50", 57½", 65½", 72"
 - Widths – 18", 24"
 - Depths – 18", 24"
 - Personal combination and side access towers 24"W coat hanging options under fixed shelf are two coat hooks in 18"D models and a coat rod in 24"D units for hangers.
 - Available in right-hand and left-hand configurations
 - Push latch wardrobe door on 18 and 24 wide combo and side access units
 - Side access opening is at 29½" to line up with worksurface
 - 2 adjustable shelves behind hinged door
 - Shelving behind hinged door or in open cavity:
 - 50" & 57½" – 1 Shelf
 - 65½" & 72" – 2 shelves
 - Refer to pages 165-166 for interior dimensions.
 - Combo Towers have hinged door on front of unit
 - Side Access Towers have open shelving on side of unit
 - File drawer interior dimensions and filing are the same as 18"W ped
 - Box/Box/File and File/File configurations available
 - 30"W Combo tower has File/File configuration only with pulls on all doors and drawers
 - Interior Dimensions for Box/Box/File and File/File are the same as 18"W Ped
- 30"W Wardrobe
 - 5H only
 - Depth: 24"D.
 - Shelves:
 - 3 adjustable, 1 fixed
 - Refer to page 164 for interior dimensions.



Cubby Storage (page 233)

- 7"H x 14"D x 18", 24", or 30"W.
- Installs under a worksurface, hardware included.
- Ships flat for field assembly.

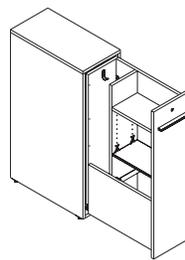

RH

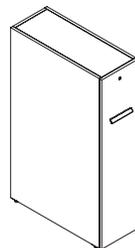

Pullout Towers (page 228)

- Tower ships fully assembled.
- Laminate finish options include chassis, front, and drawer.
 - Drawer finish options limited to Loft, Flint, and Designer White
- Sizes Available:
 - Heights – 42½", 50"
 - Widths – 12"
 - Depths – 24", 30"
- LH & RH configurations available.
- Tower Drawer contains two coat hooks.
- Shelving (See page 167 for specifications):
 - 42½"H – 1 adjustable & 1 fixed shelf
 - Adjustable shelf has 2½" height adjustment
 - 50"H – 2 adjustable & 1 fixed shelf
 - Bottom adjustable shelf has 4⅞" adjustment
 - Top adjustable shelf has 2½" adjustment
- Tower Drawer contains file capabilities (See page 163 for specifications).
- Case height contains 1½" adjustable glides.
- Tower Drawer contains 1½" adjustable caster.

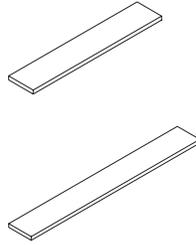

Floating Shelf (page 239)

- 30"-78" Widths available.
- Shelf is 8" in depth.
- Brackets ship with shelf.
- Maximum 10 lbs. per linear foot load capacity. Shelf can be mounted to any surface. Hardware to mount shelf not included and specified by contractor.

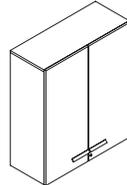

Stack-On Storage (pages 239-241)

- Ships assembled except for pulls.
- Outside overall dimensions:
 - Width is nominal to dimension (i.e. 18"W = 18")
 - Heights: 4H = 29¹/₈", 5H = 42¹/₈"
 - Depths: 15"D = 15" from drawer front to rear edge of end panel. Open shelf units subtract 3/4" for front thickness.
- Laminate finish options include chassis and front on hinged door units and chassis on open and side access units.
- Shelves:
 - 4H = 1 adjustable
 - 5H = 2 adjustable
- Pin-and-cam fasteners visible from the front are covered with cam covers
- 18"W hinged door available in right- and left-hand configurations.
- Side access available in right- and left-hand configurations.
- Writable front models available.
- Units must be placed on top of 1/4" thick worksurface and are attached with industrial VHB tape.

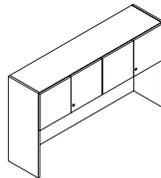
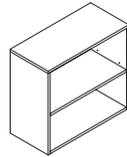

Hutches (page 241)

- Sizes:
 - Height - 35"
 - Width - 48", 60", 66", 72", 78"
 - Depth - 14"
- Fully enclosed back; includes a 1/4", full width pass-through for 3-prong electrical plugs; facilitates routing cords and reaching wall electrical outlets.
- Lower back panel can be attached with cord pass-through at bottom next to the worksurface or at top for close proximity to task light cord.
- Lower back panel can be removed to facilitate collaboration in teaming configurations.
- Valance hides task light.
- Vertical clearance for computer monitor is 20".
- Available with laminate or frosted glass/silver doors.
- Units are equipped with self-closing, adjustable hinges.
- Laminate hinged door units are available with or without a lock.
- For tackboards, see page 241.
- For task lights, see page 326.
- Units attach to worksurface using double sided tape.

Overheads (page 238)

- Ship fully assembled.
- Laminate finish options include chassis and front.
- Wall mounted - standard - ships with hardware for unit connection to bracket. Hardware for bracket connection to wall is not included.
- Outside overall dimensions:
 - Widths: 30"W = 29⁷/₈", 36"W = 35⁷/₈", 60"W = 59⁷/₈", 72"W = 71⁷/₈".
 - Heights: 15"H = 15¹/₈"
 - Depths: 15"H = 15¹/₈" open case depth; 15¹/₈" for overheads with doors.
- Pin-and-cam fasteners visible from the front are covered with cam covers

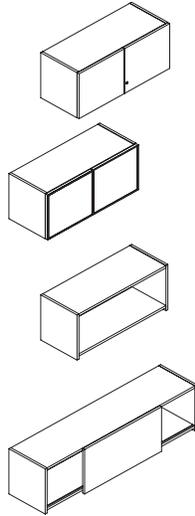

- Hinged door — laminate
 - 30"W, 36"W and 42"W (2 doors, 1 lock)
 - 48"W (3 doors, 1 lock)
 - 60"W, 66"W, 72"W and 78"W (4 doors, 2 locks)
 - Locking — standard, omit, and non-locking options.
- Hinged door with frosted glass
 - 30"W, 36"W and 42"W (2 doors)
 - 48"W (3 doors)
 - 60"W, 66"W, 72"W and 78"W (4 doors)
 - Non-locking
- Open
 - 30"W and 36"W
- Sliding door — one half-width laminate door
 - 48"W, 60"W, 66"W, 72"W, and 78"W cabinets.
 - Locking on left side only.
- Specify low profile LED task lights to mount beneath laminate overhead cabinets. See pages [323-326](#).



Overhead Mounting Kit for Beyond Walls (page [238](#))

- Able to mount Approach overheads onto beyond frame wall.
- Need to order beyond slotted standard bracket, model **BFSFHB.L.**
- Able to mount off-modular, maximum 6" total for 30"–48"W units, and 12" total for 60"–78"W overheads.
- WKOHBW30AK includes 2 brackets.
- WKOHBW60AK includes 3 brackets. Required for 78" overheads and any setup that spans 2 or more glass sections.

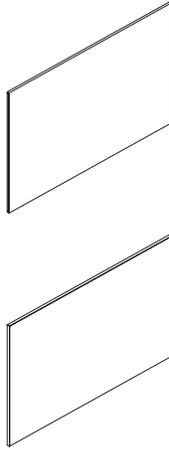

Tackboards and Writable Boards (pages 242-243)

- Available in upholstered tackboards and writable surface boards.
- Available to match 4H and 5H storage heights at layered and full height applications.
- Available 30"W - 96"W at 6" increments.
- Models greater than 60"W consist of multiple segments.
- If 4H tower unit is specified then use 4H board. Select height based on layered or full height credenza. See illustration at bottom.
- If 5H tower unit is specified then use 5H board. Select height based on layered or full height credenza. See illustration at bottom.
- If 5H tower unit is specified with an overhead unit then use 4H board. Select height based on layered or full height credenza. See illustration at bottom.
- Units are wall mounted using 'Z-Mounting' bracket.
- Tackboards and writable surface boards are not meant to be used with finished back credenza kits.
- Tackboards and writable board heights are in alignment with Trough heights.
- Troughless units are for open plan/workstations and will need tackboard to raise 3" or set behind credenza. Or contact tailored products group.

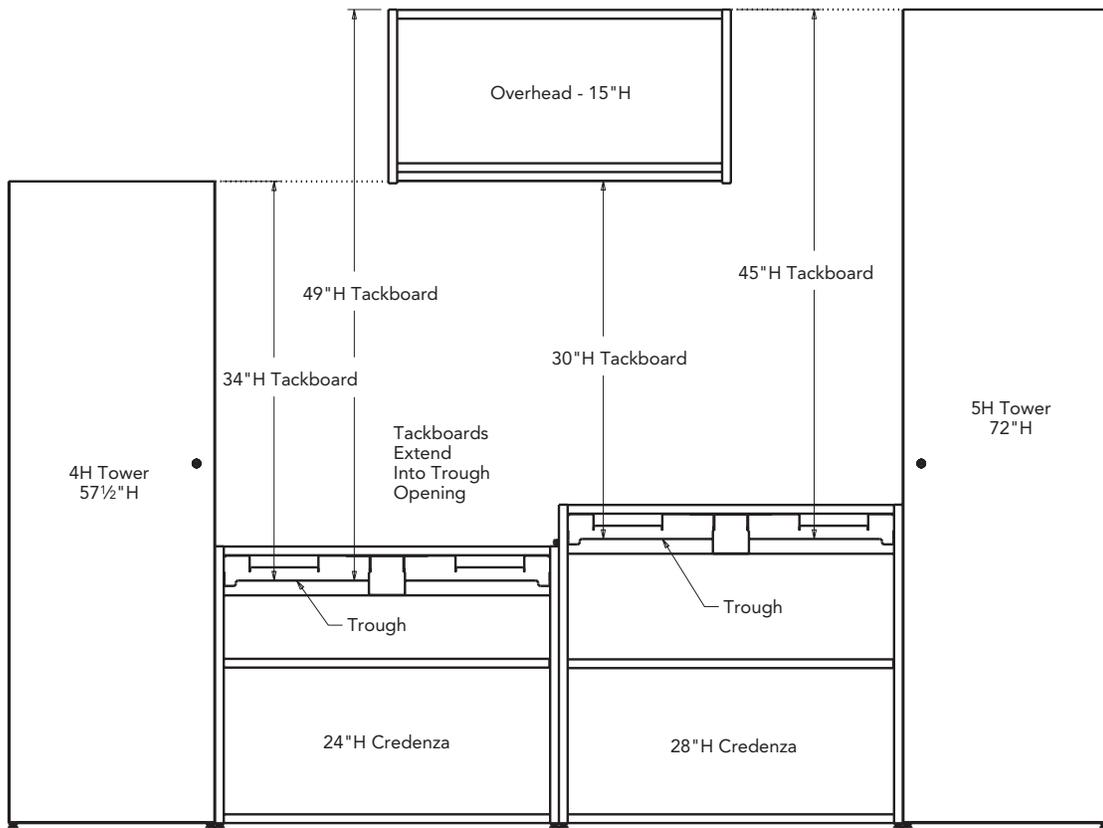

APPROACH

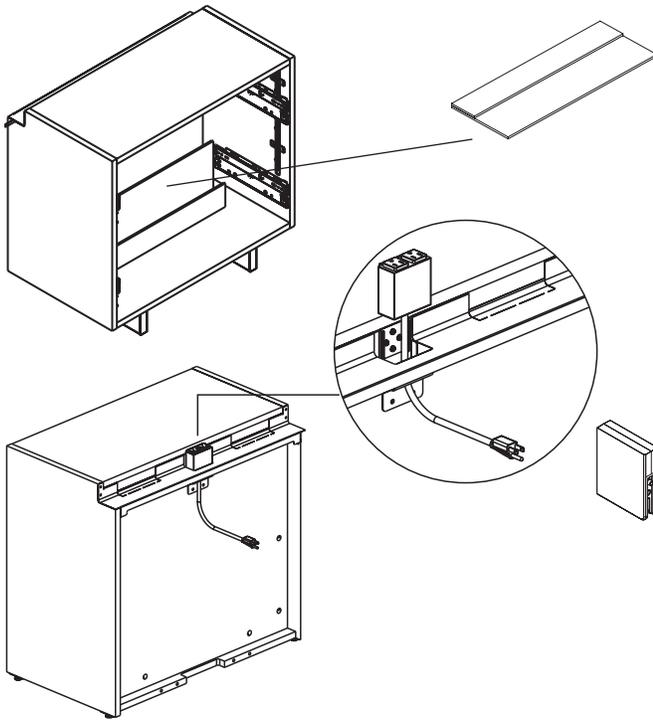

Counterweight Kits (page 244)

- Counterweight is attached to the back of a pedestal or credenza to inhibit tipping. See illustration at left.
- Kits must be ordered separately (see pages 180-181) based on type and depth of unit and are field-installed.
- Units that may require counterweight kits, depending on how they are configured, are flagged with a pound sign # after the model number listing on pages 205 and 213.

Mini-tap Power (page 244)

- Installs into back bracket of unit on 18"D models. See illustration at left. Includes 6' black power cord.
- Units available as 2 Power or 1 Power/1 USB.
- Requires additional mounting bracket WKMTMB (ordered separately) on 24"D models and wall access panels.
- 12"W, 18"W, 24"W, 30"W, and 36"W units have 1 knockout; 42"W, 48"W, 60"W, and 72"W units have 2 knockouts for mini-tap power modules.

End Cap (page 244)

- Used to finish trough at end of run.
 - Branded with Allsteel Logo.
 - Available in Black, Designer White, and Silver.
 - Specify Full Height or Enclosed Height end caps based on top specified.
 - **Credenza Top is required.**
 - For Open Trough Tops specify Full Height End Caps.
 - For Closed Trough Tops specify enclosed Shortened Height End Caps.
- *Note: Top will cover top of end cap.

Wire Manager for Height-Adjustable Trough (page 244)

- 30"W, Flint only.
- Installs onto height-adjustable laminate shroud. See below.
- Spans two credenzas on either end of height-adjustable desk.
- Height-adjustable table must be perpendicular to wall.

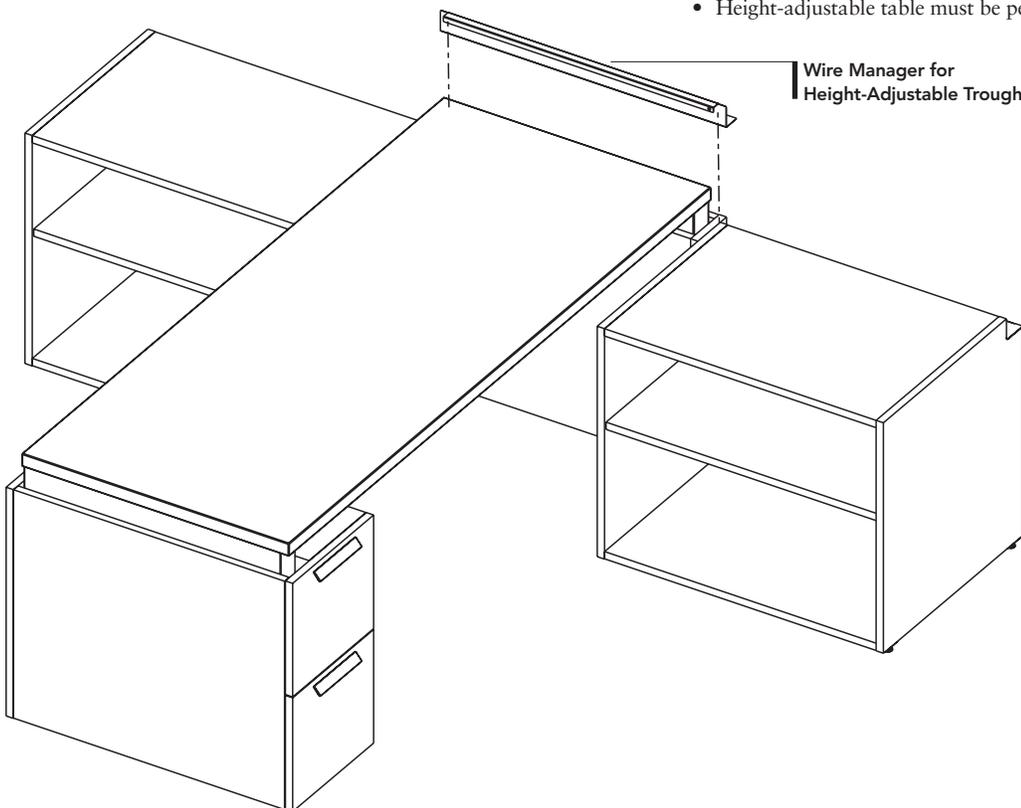

Altitude height-adjustable bases are available in two styles for Approach:

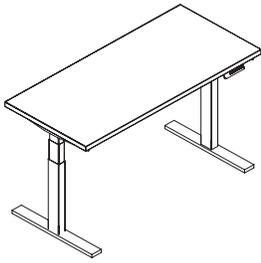

A6 T & C Electric Base
with Rectangular Worksurface

Compatible with Credenza
for Integrated leg new shroud
models available April 2021

Clearance Dimensions

Rectangle

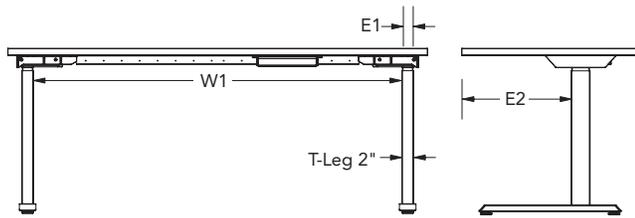

Bottom Views

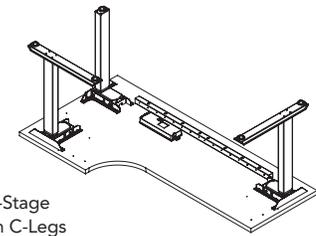
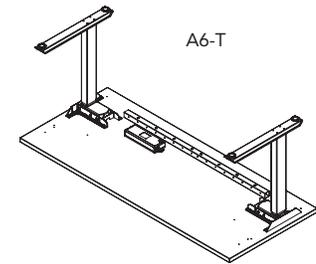

Base Style:	A6 T Base			A5 2-Stage C-Leg Base				
	Dimension Location:	E1	W	E2	E1	W1	W2	E2
Altitude Top: (Surface dimensions are nominal. Actual widths are reduced by 2")	Edge of table to outside of leg	Between legs	Edge of table to the outside of leg	Edge of table to outside of leg	Between legs	Between legs	Edge of table to the outside of leg	
24" x 48" Rectangle*	—	—	—	2"	38"	—	12 ⁷ / ₈ "	
24" x 54" Rectangle	2 ¹ / ₂ "	41 ¹ / ₄ "	10 ³ / ₈ "	2"	44"	—	12 ⁷ / ₈ "	
24" x 60" Rectangle	2 ¹ / ₂ "	47 ¹ / ₄ "	10 ³ / ₈ "	2"	50"	—	12 ⁷ / ₈ "	
24" x 66" Rectangle	2 ¹ / ₂ "	53 ¹ / ₄ "	10 ³ / ₈ "	2"	56"	—	12 ⁷ / ₈ "	
24" x 72" Rectangle	2 ¹ / ₂ "	59 ¹ / ₄ "	10 ³ / ₈ "	2"	62"	—	12 ⁷ / ₈ "	
30" x 48" Rectangle	—	—	—	2"	38"	—	17 ⁷ / ₈ "	
30" x 54" Rectangle	2 ¹ / ₂ "	41 ¹ / ₄ "	13 ³ / ₈ "	2"	44"	—	17 ⁷ / ₈ "	
30" x 60" Rectangle	2 ¹ / ₂ "	47 ¹ / ₄ "	13 ³ / ₈ "	2"	50"	—	17 ⁷ / ₈ "	
30" x 66" Rectangle	2 ¹ / ₂ "	53 ¹ / ₄ "	13 ³ / ₈ "	2"	56"	—	17 ⁷ / ₈ "	
30" x 72" Rectangle	2 ¹ / ₂ "	59 ¹ / ₄ "	13 ³ / ₈ "	2"	62"	—	17 ⁷ / ₈ "	

APPROACH

Height-Adjustable Worksurfaces, Bases, and Controls

Height-Adjustable Worksurfaces (page 245)

- Height-adjustable worksurfaces are available in laminate with flat edge and rectangular veneer with matching square edge.
- Worksurface dimensions are nominal. Actual widths are reduced by 2" (1" each side). Corner cove depth is nominal, actual is 1" less.
- Altitude worksurfaces are pre-drilled with mounting location for bases.
- Any open span 60" and greater requires an external support channel.
- Altitude 66"-72"W rectangular worksurfaces include an external support channel.
- Rectangular worksurface grommet location is limited to center location due to mounting of worksurface supports at each end of the worksurface.
- C-Leg load capacity is 300 pounds for 2-leg model including weight of worksurface. A3-T load capacity is 250 pounds for 2-leg model including weight of worksurface.

Height-Adjustable Bases (page 246)

- Electric height-adjustable base units are available in two styles for Approach: A6 with T-Leg or A6 with C-Leg.
- A6 models are available in Black, Brownstone, Cinder, Designer White, Flint, Fossil, Loft, Muslin, Nickel, Parchment, Pebble, Pewter, Salt, Titanium, Champagne Metallic, Gunmetal Metallic, Night Bronze, Platinum Metallic, and Silver.
- A6 models travel at 1.2" per second. Motor devices have a continuous cycle time of 2 minutes with an 18 minute rest period before it can be cycled again.
- Control box is powered by 110-120V/60Hz/4A. Standby power is <0.1 Watts. Power cords on A6-T models are 10'.
- Pedestals taller than 24½" for 2-stage models and 19½" for 3-stage models when placed under table will limit range in lower position.
- Mobile box/file pedestals will clear feet on height adjustable base but will extend past edge of worksurface in that position. See chart on page 163.
- Moving worksurfaces can collide with other components. It is important to ensure free range of motion prior to operating the table.
- All tables have adjustable glides providing ½" adjustment on A6.
- Altitude A6 tables feature anti-collision, a feature designed to stop table travel when the table detects an obstacle.
- Altitude A6 bases specified with a worksurface 60"W and greater require the use of an external stiffener. An external stiffener is included in Altitude worksurface models 60"W and greater. If a non-Altitude worksurface is being used, an external stiffener may need to be specified separately.
- A6 2-stage models (2-leg and 3-leg) can be used with shrouds.

Shrouds (page 246)

- A6 2-stage models (2-leg and 3-leg) can be used with shrouds.
- A6 3-stage standard and Max bases cannot be used with shrouds. The shrouds interfere with the reset of the base as it is not able to reach its lowest setting.

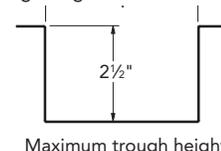
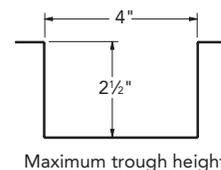
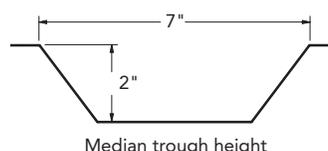
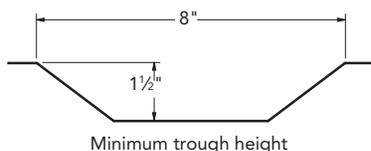

Cable & Wire Management

Cable Management Tray (page 245)

- Attaches under the worksurface to contain cables.
- Metal tray shelf is 4" deep. Can hold electrical power strip and/or surge protector.
- 24" and 36" lengths, use multiple units for larger worksurfaces.
- Attachment hardware included, paint option is black only.
- Zip tie attachment points located in base of tray. Zip ties not included.

Wire Management Channel (page 245)

- Self adhesive backing to attach to panels and underside of worksurfaces.
- Flexible strips allow cabling to enter/exit and can be contained inside the 2-cavity profile.
- Each cavity provides space for a maximum of six .22" dia. cables. Total capacity = 1 sq. in.

Cord Management Chain (page 245)

- Works with Approach and Altitude A3 and A5-Series product.
- Used to route and conceal power/data cables from control box and other devices. Includes all mounting hardware and a plate to secure to a leveling glide.
- Houses 6 cables @ 0.300" diameter.
- Made of plastic chain with plastic attachment brackets at each end. Only comes in Black finish.

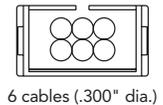

Under Worksurface Trough (page 245)

- Used to conceal wires and control box below worksurfaces. Trough can be configured at various height/width combinations to meet capacity needs — see illustrations below.
- On 48"W and 54"W worksurfaces use one 17"W trough. 54"W has space to use 2 – 17"W, if necessary.
- On 60"W, 66"W, and 72"W worksurfaces use the 36" trough.
- On 84"W worksurface use 2 – 17"W troughs.

Cross-sectional Area Inside Under Worksurface Troughs

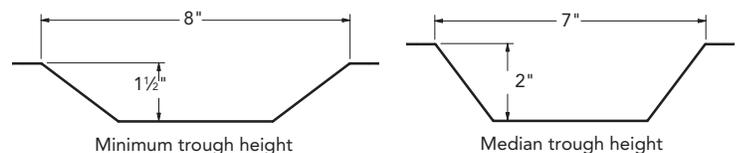

For specification information see pages 182-187.

GSA SIN 33721

Description	Model	Locks	L1 Laminate List Price	UPCHARGES*		
				Top	L2 Laminate Chassis	Front
Desk w/Height-Adjustable Top (27¼"– 47½"H) and File/File Storage Left						
72"W x 36"D	WKDAFNJ297236LH-FF	1	\$ 9488	\$ 190	\$ 97	\$ 47
72"W x 30"D (shown)	WKDAFNJ297230LH-FF	1	\$ 9211	\$ 187	\$ 97	\$ 47
66"W x 30"D	WKDAFNJ296630LH-FF	1	\$ 9147	\$ 186	\$ 97	\$ 47
*Half height modesty option only						
Desk w/Height-Adjustable Top (27¼"– 47½"H) and File/File Storage Right						
72"W x 36"D	WKDAFNJ297236RH-FF	1	\$ 9488	\$ 190	\$ 97	\$ 47
72"W x 30"D (shown)	WKDAFNJ297230RH-FF	1	\$ 9211	\$ 187	\$ 97	\$ 47
66"W x 30"D	WKDAFNJ296630RH-FF	1	\$ 9147	\$ 186	\$ 97	\$ 47
*Half height modesty option only						
Desk w/Height-Adjustable Shrouds (27¼"– 47½"H) and No Modesty Panel						
72"W x 36"D	WKDAFNJ297236	—	\$ 7055	\$ 190	\$ 57	N/A
72"W x 30"D (shown)	WKDAFNJ297230	—	\$ 6778	\$ 187	\$ 57	N/A
66"W x 30"D	WKDAFNJ296630	—	\$ 6714	\$ 186	\$ 57	N/A
*Half height modesty option within model or modular 24"H modesty see page 227						
Wall Bridge w/Height-Adjustable Shrouds (27¼"– 47½"H) and Full-Height Modesty Panel Only						
72"W x 24"D	WKDAFNJ297224	—	\$ 6976	\$ 99	\$ 59	N/A
66"W x 24"D	WKDAFNJ296624	—	\$ 6891	\$ 99	\$ 58	N/A
60"W x 24"D (shown)	WKDAFNJ296024	—	\$ 6785	\$ 97	\$ 57	N/A
54"W x 24"D	WKDAFNJ295424	—	\$ 6678	\$ 96	\$ 56	N/A
48"W x 24"D	WKDAFNJ294824	—	\$ 6596	\$ 95	\$ 55	N/A
*Nominal depth of shroud is 22" and worksurface is 21" deep						
*Bridge models are for wall facing applications.						
*Upcharges are added to L1 Laminate List Price depending on woodgrain laminate selection.						
*New anti collision control on new models						

<p>How to specify — Select the Model Number from above.</p> <p>WKDAFNJ29</p>	<p><i>1st Option:</i> FSC Certified Wood: F FSC Certified X No FSC</p>	<p><i>2nd Option:</i> Top Laminate and Predefined Edge (if applicable): See page 173 for finishes.</p>	<p><i>3rd Option:</i> Chassis Laminate and Predefined Edge: See page 173 for finishes.</p>	<p><i>4th Option:</i> Front Laminate and Predefined Edge (if applicable):</p>	<p><i>5th Option:</i> Pull Type (if applicable): MP Beam OP Halo AP Arch BP Bar SP Square See matrix on page 21.</p>

<p><i>5th Option (continued):</i> Pull Color (if applicable): MP Beam / OP Halo P JW Designer White PR6 Silver P JE Pyrite P8X Solar Black AP Arch PR0 Anodized Silver P2 upcharge +\$18/pull BP Bar P27 Black P JW Designer White PR6 Silver SP Square P JW Designer White EL Matte Silver P02 Flint P7B Loft P JE Pyrite P8X Solar Black P2 upcharge +\$18/pull</p>	<p><i>6th Option:</i> Grommet Location (if applicable): See page 186. B Both Left and Right C Centered L Left R Right X No Grommet</p>	<p><i>7th Option:</i> Grommet Type (if applicable): P Oval Plastic (will match edge trim) M Oval Metal (Add \$13 per grommet) S Square Metal (Add \$13 per grommet) Grommet Color (Metal only) (if applicable): EL Matte Silver</p>	<p><i>8th Option:</i> Metal Sleeve Paint (if applicable): P1 P2 P3 See page 173 for finishes. P2 \$17/shroud P3 \$40/shroud</p>	<p><i>9th Option:</i> Height Adjustable Base (if applicable): P R 6</p>	<p><i>10th Option:</i> Height Adjustable Base Keypad (if applicable): UD Basic Up/Down MEM Memory Preset PDL Paddle</p>	<p><i>11th Option:</i> Lock (if applicable): STD Standard OMT Omit Lock Core (Deduct \$20 per lock)</p>

Example: WKDAFNJ297236RH-FF.X.LM14EW.LSW1SW.OPP8X.STD

For specification information see pages 188-191.
 First, select Trough (F) or Troughless (T). If trough, add \$100 from listed price.
 Next, select Footed (Y) or Non-footed (N). If footed, add \$100 from listed price.

GSA SIN 33721

Description	Troughless only Model	Locks	L1 Laminate List Price	UPCHARGES*	
				L2 Laminate Chassis	Front
Support Pedestal 28"H — Box / Box/File without a trough					
15"W x 24"D BBF*	WK □ SP281524-BBF	1	\$ 1572	\$ 23	\$ 18
15"W x 30"D BBF*	WK □ SP281530-BBF	1	\$ 1888	\$ 21	\$ 21
*15W Box drawers compatible with A2280-000 pencil tray.					
Support Pedestal 28"H — File / File without a trough					
15"W x 24"D FF	WK □ SP281524-FF	1	\$ 1416	\$ 17	\$ 17
15"W x 30"D FF	WK □ SP281530-FF	1	\$ 1730	\$ 20	\$ 20
24"H Support Pedestal — Hinged Door					
12"W x 18"D	WKPL □ N241218RH-HD	1	\$ 1532	\$ 41	\$ 18
12"W x 18"D	WKPL □ N241218LH-HD	1	\$ 1532	\$ 41	\$ 18
24"H Support Pedestal — Open Cubby					
12"W x 18"D	WKPL □ N241218-OC	1	\$ 1259	\$ 46	N/A
*Upcharges are added to L1 Laminate List Price depending on woodgrain laminate selection.					

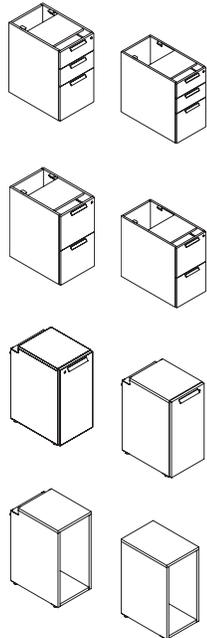

Description	Model	List Price
Box Drawer Accessories		
Pencil Tray (Black only)	A2280-000 <input type="checkbox"/>	\$ 50

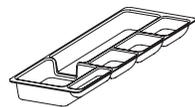

APPROACH

How to specify — Select the Model Number from above. WK	1st Option: FSC Certified Wood: F FSC Certified X No FSC	2nd Option: Chassis Laminate and Predefined Edge: See inside front cover for finishes.	3rd Option: Front Laminate and Predefined Edge:
	.	.	.

4th Option: Pull Type (if applicable): MP Beam OP Halo AP Arch BP Bar SP Square See matrix on page 21.	5th Option: Pull Color (if applicable): MP Beam / OP Halo PJW Designer White PR6 Silver PJE Pyrite P8X Solar Black AP Arch PRO Anodized Silver P2 upcharge +\$18/pull	6th Option: Foot Type (if applicable): PF Post Foot Foot Color (if applicable): PJW Designer White PR6 Silver P02 Flint P7B Loft PJE Pyrite P8X Solar Black	7th Option: Lock (if applicable): STD Standard OMT Omit Lock Core (Deduct \$20 per lock)
.	.	.	.

Examples: WKYSP281530-BBF.X.LM14EW.LSW1SW.APPR6.PFPJE.STD
 WKPLCDFN241218RH-HD.X.LSW1SW.LSW1SW.MPPJE.STD

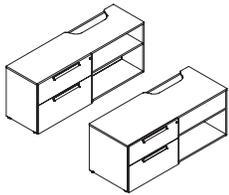

Description	Model	Locks	L1 Laminate List Price	UPCHARGES*		
				Top	L2 Laminate Chassis	Front
24"H Credenza for Integrated HAT Leg Troughless and Non-Footed Available						
60"W x 18"D (shown)	WKHATN246018	1	\$ 5188	\$ 94	\$ 64	\$ 25
60"W x 24"D (shown)	WKHATN246024	1	\$ 5349	\$ 96	\$ 65	\$ 27
72"W x 18"D	WKHATN247218	1	\$ 5395	\$ 97	\$ 66	\$ 27
72"W x 24"D	WKHATN247224	1	\$ 5562	\$ 101	\$ 67	\$ 27

*Upcharges are added to L1 Laminate List Price depending on woodgrain laminate selection.

*Compatible with 2-stage T-Leg A6 height adjustable tables. All height adjustable bases are purchased separately.

*Universal top finished on both sides makes models non-handed.

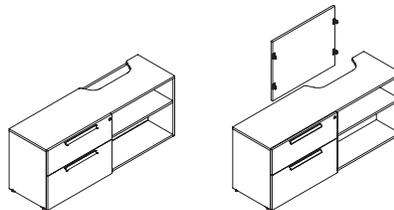
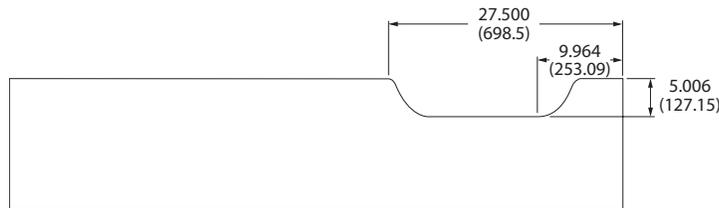

<p>How to specify — Select the Model Number from above.</p> <p>WKHATN24</p> <p>_____ .</p>	<p>1st Option: FSC Certified Wood: F FSC Certified X No FSC</p> <p>_____ .</p>	<p>2nd Option: Top Laminate and Predefined Edge (if applicable): See page 173 for finishes.</p> <p>_____ .</p>	<p>3rd Option: Chassis Laminate and Predefined Edge (if applicable): See page 173 for finishes.</p> <p>_____ .</p>
---	--	--	--

<p>4th Option: Front Laminate and Predefined Edge:</p> <p>_____ .</p>	<p>5th Option: Pull Type (if applicable): MP Beam OP Halo AP Arch BP Bar SP Square See matrix on page 21.</p> <p>_____ .</p>	<p>6th Option: Pull Color (if applicable): MP Beam / OP Halo PJV Designer White PR6 Silver PJE Pyrite P8X Solar Black AP Arch PRO Anodized Silver P2 upcharge +\$18/pull</p> <p>_____ .</p>	<p>7th Option: Lock (if applicable): STD Standard OMT Omit Lock Core (Deduct \$20 per lock)</p> <p>_____ .</p>
---	--	---	--

Example: WKHATN247218.X.LM14EW.LM14EW.LSW1SW.BPPR6.STD

For specification information see pages 188-191.
 First, select Trough (F) or Troughless (T). If trough, add \$100 from listed price.
 Next, select Footed (Y) or Non-footed (N). If footed, add \$100 from listed price.

Description	Model	Lock	L1 Laminate List Price Non-Footed Troughless	UPCHARGES*	
				L2 Laminate Chassis	Front
24"H Credenzas — Multi File					
30"W x 18"D (shown)	WKCS □ □ N243018-MF	1	\$ 2634	\$ 30	\$ 30
24"H Credenzas - Box/File Non-Footed Troughless					
36"W x 18"D	WKCS □ □ 243618-BF	1	\$ 2350	\$ 27	\$ 27
30"W x 18"D (shown)	WKCS □ □ 243018-BF	1	\$ 2289	\$ 25	\$ 25
24"H Credenzas — Open with Adjustable Shelf					
36"W x 18"D	WKCS □ □ 243618-OS	—	\$ 1814	\$ 21	N/A
30"W x 18"D (shown)	WKCS □ □ 243018-OS	—	\$ 1769	\$ 20	N/A
24"H Credenzas —Hinged Doors with Adjustable Shelf					
36"W x 18"D	WKCS □ □ 243618-HD	1	\$ 2187	\$ 24	\$ 24
30"W x 18"D (shown)	WKCS □ □ 243018-HD	1	\$ 2132	\$ 24	\$ 24

*Upcharges are added to L1 Laminate List Price depending on woodgrain laminate selection.

<p>How to specify — Select the Model Number from above.</p> <p>WKCS </p> <p> .</p>	<p>1st Option: FSC Certified Wood:</p> <p>F FSC Certified X No FSC</p> <p> .</p>	<p>2nd Option: Chassis Laminate and Predefined Edge:</p> <p>See page 173 for finishes.</p> <p> .</p>	<p>3rd Option: Front Laminate and Predefined Edge:</p> <p> .</p>
---	--	--	--

<p>4th Option: Pull Type (if applicable):</p> <p>MP Beam OP Halo AP Arch BP Bar SP Square</p> <p>See matrix on page 21.</p> <p> .</p>	<p>5th Option: Pull Color (if applicable):</p> <p>MP Beam / OP Halo P2 upcharge +\$18/pull</p> <p>PJW Designer White PR6 Silver PJE Pyrite P8X Solar Black</p> <p>BP Bar P27 Black PJW Designer White PR6 Silver</p> <p>SP Square PJW Designer White EL Matte Silver P02 Flint P7B Loft PJE Pyrite P8X Solar Black P2 upcharge +\$18/pull</p> <p> .</p>	<p>6th Option: Blade Foot: BF Color:</p> <p>PJW Designer White P27 Black PR6 Silver</p> <p>Post Foot: PF (+\$113) Color:</p> <p>PJW Designer White P02 Flint P7B Loft PR6 Silver PJE Pyrite (+\$13) P8X Solar Black (+\$13)</p> <p> .</p>	<p>7th Option: Lock (if applicable):</p> <p>STD Standard OMT Omit Lock Core (Deduct \$20 per lock)</p> <p> .</p>
---	---	---	--

Example: WKCSFY243618-BF.F.LM14EW.LSW1SW.APPR6.P27.STD

For specification information see pages 188-191.
 First, select Trough (F) or Troughless (T). If trough, add \$100 from listed price.
 Next, select Footed (Y) or Non-footed (N). If footed, add \$100 from listed price.

Description	Model	Locks	L1 Laminate List Price		UPCHARGES*	
			Non-footed	Troughless	L2 Laminate Chassis	Front
24"H Credenzas — Box/File / Open Shelf						
48"W x 18"D	WKCUT □ 244818-BFOS	1	\$ 3612		\$ 45	\$ 45
42"W x 18"D (shown)	WKCUT □ 244218-BFOS	1	\$ 3541		\$ 44	\$ 44
24"H Credenzas — Open Shelf / Box/File						
48"W x 18"D	WKCUT □ 244818-OSBF	1	\$ 3612		\$ 45	\$ 45
42"W x 18"D (shown)	WKCUT □ 244218-OSBF	1	\$ 3541		\$ 44	\$ 44
24"H Credenzas — Box/File / Box/File						
72"W x 18"D	WKCU □ □ 247218-BFBF	2	\$ 4183		\$ 46	\$ 46
60"W x 18"D (shown)	WKCU □ □ 246018-BFBF	2	\$ 4039		\$ 45	\$ 45
24"H Credenzas — Box/File / Open Shelf						
72"W x 18"D	WKCU □ □ 247218-BFOS	1	\$ 4019		\$ 45	\$ 45
60"W x 18"D (shown)	WKCU □ □ 246018-BFOS	1	\$ 3877		\$ 43	\$ 43

*Upcharges are added to L1 Laminate List Price depending on woodgrain laminate selection.

<p>How to specify — Select the Model Number from above.</p> <p>W K C U </p>	<p>1st Option: FSC Certified Wood:</p> <p>F FSC Certified X No FSC</p>	<p>2nd Option: Chassis Laminate and Predefined Edge:</p> <p>See page 173 for finishes.</p>	<p>3rd Option: Front Laminate and Predefined Edge:</p>
	<p> .</p>	<p> .</p>	<p> .</p>

<p>4th Option: Pull Type (if applicable):</p> <p>MP Beam OP Halo AP Arch BP Bar SP Square</p> <p>See matrix on page 21.</p>	<p>5th Option: Pull Color (if applicable):</p> <p>MP Beam / OP Halo P2 upcharge +\$18/pull</p> <p>PJW Designer White PR6 Silver PJE Pyrite P8X Solar Black</p>	<p>6th Option: Blade Foot: BF Color:</p> <p>PJW Designer White P27 Black PR6 Silver</p> <p>Post Foot: PF (+\$113) Color:</p> <p>PJW Designer White P02 Flint P7B Loft PR6 Silver PJE Pyrite (+\$13) P8X Solar Black (+\$13)</p>	<p>7th Option: Lock (if applicable):</p> <p>STD Standard OMT Omit Lock Core (Deduct \$20 per lock)</p>
<p> .</p>	<p> .</p>	<p> .</p>	<p> .</p>

Example: WKCUFY246018-BFBF.F.LM14EW.LSW1SW.BPPR6.P27.OMT

For specification information see pages 188-191.
 First, select Trough (F) or Troughless (T). If trough, add \$100 from listed price.
 Next, select Footed (Y) or Non-footed (N). If footed, add \$100 from listed price.

Description	Model	Locks	L1 Laminate		UPCHARGES*	
			List Price	Non-footed Troughless	L2 Laminate Chassis	Front
24"H Credenzas — Open Shelf / Box/File						
72"W x 18"D	WKCU □ □ 247218-OSBF	1	\$ 4019		\$ 45	\$ 45
60"W x 18"D (shown)	WKCU □ □ 246018-OSBF	1	\$ 3877		\$ 43	\$ 43
24"H Credenzas — Box/File / Hinged Doors						
72"W x 18"D	WKCU □ □ 247218-BFHD	2	\$ 4107		\$ 46	\$ 46
60"W x 18"D (shown)	WKCU □ □ 246018-BFHD	2	\$ 3962		\$ 44	\$ 44
24"H Credenzas — Hinged Doors / Box/File						
72"W x 18"D	WKCU □ □ 247218-HDBF	2	\$ 4107		\$ 46	\$ 46
60"W x 18"D (shown)	WKCU □ □ 246018-HDBF	2	\$ 3962		\$ 44	\$ 44
*Upcharges are added to L1 Laminate List Price depending on woodgrain laminate selection.						
24"H Credenzas — Hinged Doors with Adjustable Shelves						
72"W x 18"D	WKCU □ □ 247218-HDHD		\$ 4012		\$ 45	\$ 45
60"W x 18"D	WKCU □ □ 246018-HDHD		\$ 3908		\$ 44	\$ 44

How to specify — Select the Model Number from above. WKCU .	1st Option: FSC Certified Wood: F FSC Certified X No FSC	2nd Option: Chassis Laminate and Predefined Edge: See page 173 for finishes.	3rd Option: Front Laminate and Predefined Edge:
	.	.	.

4th Option: Pull Type (if applicable): MP Beam OP Halo AP Arch BP Bar SP Square See matrix on page 21.	5th Option: Pull Color (if applicable): MP Beam / OP Halo P JW Designer White P R6 Silver P JE Pyrite P 8X Solar Black AP Arch P R0 Anodized Silver P2 upcharge +\$18/pull	6th Option: Blade Foot: BF Color: P JW Designer White P 27 Black P R6 Silver Post Foot: PF (+\$113) Color: P JW Designer White P 02 Flint P 7B Loft P R6 Silver P JE Pyrite (+\$13) P 8X Solar Black (+\$13)	7th Option: Lock (if applicable): STD Standard OMT Omit Lock Core (Deduct \$20 per lock)
	.	.	

Example: WKCUFY246018-OSBF.F.LM14EW.LSW1SW.BPPR6.P27.OMT

For specification information see pages 188-191.
 First, select Trough (F) or Troughless (T). If trough, add \$100 from listed price.
 Next, select Footed (Y) or Non-footed (N). If footed, add \$100 from listed price.

Description	Model	Locks	L1 Laminate List Price		UPCHARGES*	
			Non-footed	Troughless	L2 Laminate Chassis	Front
28"H Credenzas — Multi File						
30"W x 18"D (shown)	WKCS □ □ 283018-MF	1	\$ 2693		\$ 30	\$ 30
30"W x 24"D	WKCS □ □ 283024-MF	1	\$ 2774		\$ 31	\$ 31
28"H Credenzas — Lateral File						
36"W x 18"D	WKCS □ □ 283618-LF	1	\$ 2398		\$ 27	\$ 27
36"W x 24"D	WKCS □ □ 283624-LF	1	\$ 2517		\$ 28	\$ 28
30"W x 18"D (shown)	WKCS □ □ 283018-LF	1	\$ 2339		\$ 27	\$ 27
30"W x 24"D	WKCS □ □ 283024-LF	1	\$ 2385		\$ 27	\$ 27
28"H Credenza — Box/Box/File (footed only)						
36"W x 18"D	WKCS □ Y283618-BBF #	1	\$ 2976		\$ 32	\$ 32
36"W x 24"D	WKCS □ Y283624-BBF #	1	\$ 2949		\$ 33	\$ 33
30"W x 18"D	WKCS □ Y283018-BBF #	1	\$ 2796		\$ 31	\$ 31
30"W x 24"D	WKCS □ Y283024-BBF #	1	\$ 2994		\$ 32	\$ 32
28"H Credenza — Open/Box/File						
36"W x 18"D	WKCS □ N283618-OSBF #	1	\$ 2704		\$ 30	\$ 30
36"W x 24"D	WKCS □ N283624-OSBF #	1	\$ 2791		\$ 31	\$ 31
30"W x 18"D	WKCS □ N283018-OSBF #	1	\$ 2638		\$ 30	\$ 30
30"W x 24"D	WKCS □ N283024-OSBF #	1	\$ 2722		\$ 30	\$ 30
28"H Credenzas — Open with Adjustable Shelf						
36"W x 18"D	WKCS □ □ 283618-OS	—	\$ 1842		\$ 21	N/A
36"W x 24"D	WKCS □ □ 283624-OS	—	\$ 1885		\$ 21	N/A
30"W x 18"D (shown)	WKCS □ □ 283018-OS	—	\$ 1796		\$ 21	N/A
30"W x 24"D	WKCS □ □ 283024-OS	—	\$ 1837		\$ 21	N/A
28"H Credenzas — Hinged Doors with Adjustable Shelf						
36"W x 18"D	WKCS □ □ 283618-HD	1	\$ 2228		\$ 25	\$ 25
36"W x 24"D	WKCS □ □ 283624-HD	1	\$ 2275		\$ 25	\$ 25
30"W x 18"D (shown)	WKCS □ □ 283018-HD	1	\$ 2177		\$ 24	\$ 24
30"W x 24"D	WKCS □ □ 283024-HD	1	\$ 2217		\$ 25	\$ 25

*Upcharges are added to L1 Laminate List Price depending on woodgrain laminate selection.

#Unit may require counterweight kits, see page 180.

<p>How to specify — Select the Model Number from above.</p> <p>WKCS </p> <p> </p>	<p>1st Option: FSC Certified Wood:</p> <p>F FSC Certified X No FSC</p>	<p>2nd Option: Chassis Laminate and Predefined Edge:</p> <p>See page 173 for finishes.</p>	<p>3rd Option: Front Laminate and Predefined Edge:</p>
---	---	---	---

<p>4th Option: Pull Type (if applicable):</p> <p>MP Beam OP Halo AP Arch BP Bar SP Square</p> <p>See matrix on page 21.</p>	<p>5th Option: Pull Color (if applicable):</p> <p>MP Beam / OP Halo P JW Designer White PR6 Silver PJE Pyrite P8X Solar Black</p> <p>AP Arch PRO Anodized Silver P2 upcharge +\$18/pull</p>	<p>6th Option: Blade Foot: BF Color:</p> <p>P JW Designer White P27 Black PR6 Silver</p> <p>Post Foot: PF (+\$113) Color:</p> <p>P JW Designer White P02 Flint P7B Loft PR6 Silver PJE Pyrite (+\$13) P8X Solar Black (+\$13)</p>	<p>7th Option: Lock (if applicable):</p> <p>STD Standard OMT Omit Lock Core (Deduct \$20 per lock)</p>
--	--	--	---

Example: WKCSFY283018-LF.F.LM14EW.LSW1SW.APPR6.P27.STD

For specification information see pages 188-191.

GSA SIN 33721

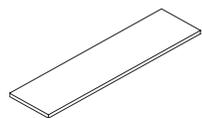

Description	Model	List Price	
		L1	L2
18"D Laminate Tops for use with Trough (Actual 15 3/8"D)			
18"W	WKWSPT1818	\$ 373	\$ 389
30"W	WKWSCW3018	\$ 485	\$ 504
36"W	WKWSCW3618	\$ 521	\$ 541
42"W	WKWSCW4218	\$ 555	\$ 576
48"W	WKWSCW4818	\$ 596	\$ 619
54"W	WKWSCW5418	\$ 641	\$ 665
60"W	WKWSCW6018	\$ 704	\$ 731
66"W	WKWSCW6618	\$ 730	\$ 757
72"W	WKWSCW7218	\$ 773	\$ 802
78"W	WKWSCW7818	\$ 839	\$ 869
84"W	WKWSCW8418	\$ 914	\$ 947
90"W	WKWSCW9018	\$ 983	\$ 1019
96"W	WKWSCW9618	\$ 1059	\$ 1097

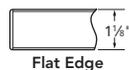
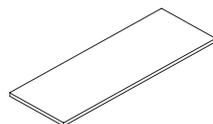

24"D Laminate Tops for use with Trough (Actual 21 3/8"D)			
18"W	WKWSPT1824	\$ 391	\$ 408
30"W	WKWSCW3024	\$ 514	\$ 534
36"W	WKWSCW3624	\$ 552	\$ 573
42"W	WKWSCW4224	\$ 589	\$ 611
48"W	WKWSCW4824	\$ 632	\$ 656
54"W	WKWSCW5424	\$ 683	\$ 708
60"W	WKWSCW6024	\$ 743	\$ 771
66"W	WKWSCW6624	\$ 773	\$ 802
72"W	WKWSCW7224	\$ 819	\$ 849
78"W	WKWSCW7824	\$ 887	\$ 919
84"W	WKWSCW8424	\$ 969	\$ 1003
90"W	WKWSCW9024	\$ 1043	\$ 1080
96"W	WKWSCW9624	\$ 1120	\$ 1161



Description	Model	List Price by Upholstery Grade							
		1	2	3	4	5	6	7	8
Seat Cushions — Specify Seating Upholstery (Credenza models are for use with trough, actual 15"D)									
30"W x 18"D Credenza	WKFC3018	\$ 432	\$ 470	\$ 507	\$ 544	\$ 594	\$ 644	\$ 693	\$ 743
36"W x 18"D Credenza	WKFC3618	\$ 476	\$ 522	\$ 567	\$ 610	\$ 670	\$ 731	\$ 791	\$ 849
16"W x 20"D Mobile Pedestal	WKFC1620	\$ 354	\$ 377	\$ 400	\$ 422	\$ 451	\$ 482	\$ 511	\$ 541

* Any unsupported span greater than 72" requires a floor support.

<p>How to specify — Select the Model Number from above.</p>	<p>1st Option: FSC Certified Wood (if applicable): F FSC Certified X No FSC</p>	<p>2nd Option: Top Laminate and Predefined Edge (if applicable): See page 173 for finishes.</p>	<p>3rd Option: Upholstery (if applicable): Specify Seating Upholstery</p>
WK . .			

Examples: WKWSCW3018.F.LM14EW WKWSCW3024.X.LM14EW WKFC1620.APN911

For specification information see pages 188-191.

GSA SIN 33721

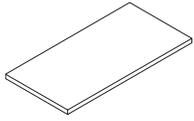

Description	Model	List Price	
		L1	L2
18"D Laminate Full Depth Tops for use without Trough			
18"W	WKWSCWFD1818	\$ 397	\$ 413
30"W	WKWSCWFD3018	\$ 514	\$ 534
36"W (shown)	WKWSCWFD3618	\$ 555	\$ 576
42"W	WKWSCWFD4218	\$ 592	\$ 614
48"W	WKWSCWFD4818	\$ 636	\$ 659
54"W	WKWSCWFD5418	\$ 679	\$ 704
60"W	WKWSCWFD6018	\$ 750	\$ 778
66"W	WKWSCWFD6618	\$ 778	\$ 807
72"W	WKWSCWFD7218	\$ 822	\$ 852
78"W	WKWSCWFD7818	\$ 892	\$ 924
84"W	WKWSCWFD8418	\$ 975	\$ 1011
90"W	WKWSCWFD9018	\$ 1047	\$ 1085
96"W	WKWSCWFD9618	\$ 1129	\$ 1171

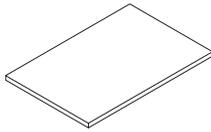

24"D Laminate Tops for use without Trough			
18"W	WKWSCWFD1824	\$ 416	\$ 432
30"W	WKWSCWFD3024	\$ 533	\$ 553
36"W (shown)	WKWSCWFD3624	\$ 576	\$ 597
42"W	WKWSCWFD4224	\$ 613	\$ 636
48"W	WKWSCWFD4824	\$ 659	\$ 683
54"W	WKWSCWFD5424	\$ 708	\$ 735
60"W	WKWSCWFD6024	\$ 776	\$ 805
66"W	WKWSCWFD6624	\$ 805	\$ 835
72"W	WKWSCWFD7224	\$ 852	\$ 883
78"W	WKWSCWFD7824	\$ 922	\$ 955
84"W	WKWSCWFD8424	\$ 1008	\$ 1045
90"W	WKWSCWFD9024	\$ 1084	\$ 1124
96"W	WKWSCWFD9624	\$ 1167	\$ 1210



Description	Model	List Price by Upholstery Grade							
		1	2	3	4	5	6	7	8
Credenza/Lateral Cushion — Specify Seating Upholstery									
30"W x 24"D Credenza	WKFC3024	\$ 565	\$ 588	\$ 611	\$ 633	\$ 662	\$ 693	\$ 723	\$ 752
36"W x 24"D Credenza	WKFC3624	\$ 678	\$ 706	\$ 733	\$ 760	\$ 796	\$ 832	\$ 867	\$ 902

* Any unsupported span greater than 72" requires a floor support.

APPROACH

<p>How to specify — Select the Model Number from above.</p>	<p>1st Option: FSC Certified Wood (if applicable): F FSC Certified X No FSC</p>	<p>2nd Option: Top Laminate and Predefined Edge (if applicable): See page 173 for finishes.</p>	<p>3rd Option: Grommet Location (if applicable): See page 186. B Both Left and Right C Centered L Left R Right X No Grommet Grommet Type (if applicable): P Oval Plastic (will match edge trim) M Oval Metal (+ \$13 per grommet) S Square Metal (+ \$13 per grommet) Grommet Color (Metal only) (if applicable): EL Matte Silver</p>	<p>4th Option: Upholstery (if applicable): See page 173 for finishes.</p>
WKW S CW . .				

Examples: WKWSCW3018.F.LM14EW WKWSCW3024.X.LM14EW WKFC1620.APN911

For specification information see pages 193-197.

GSA SIN 33721

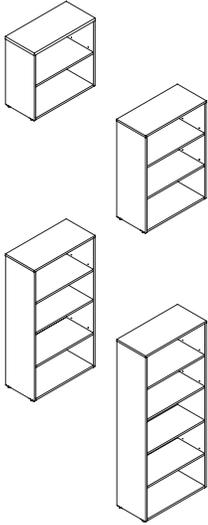

Description	Model	L1 Laminate List Price	UPCHARGES*		
			Top	L2 Laminate Chassis	Front
29½"H Bookcase with 1 Adjustable Shelf and Top Fin Back 30"W x 14¼"D (shown)	WKBKFN2H3015	\$ 1433	\$ 18	\$ 50	N/A
42¼"H Bookcase with 2 Adjustable Shelves 30"W x 14¼"D (shown)	WKBKFN3H3015	\$ 1673	N/A	\$ 58	N/A
56½"H Bookcase with 1 Fixed and 2 Adjustable Shelves 30"W x 14¼"D (shown)	WKBKFN4H3015	\$ 1917	N/A	\$ 66	N/A
71¼"H Bookcase with 1 Fixed and 3 Adjustable Shelves 30"W x 14¼"D (shown)	WKBKFN5H3015	\$ 2122	N/A	\$ 74	N/A

*Upcharges are added to L1 Laminate List Price depending on woodgrain laminate selection.

<p>How to specify — Select the Model Number from above.</p> <div style="border-bottom: 1px solid black; padding-bottom: 5px; margin-top: 20px;"> WK </div>	<p>1st Option: FSC Certified Wood: F FSC Certified X No FSC</p>	<p>2nd Option: Laminate and Predefined Edge:</p>	
--	---	--	--

Example: WKLFFN2H3018.X.LM14EW

For specification information see pages 188-191.

GSA SIN 33721

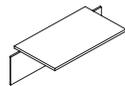
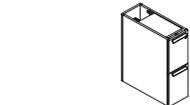
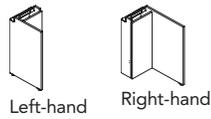

Description	Model	L1 Laminate List Price	UPCHARGES*		
			Top	L2 Laminate Chassis	Front
False Ped 28"H					
12"W x 14"D Left-hand	WKFFPN281214LH	\$ 986	N/A	\$ 37	N/A
12"W x 14"D Right-hand	WKFFPN281214RH	\$ 986	N/A	\$ 37	N/A
12"W x 18"D Left-hand (shown)	WKFFPN281218LH	\$ 1005	N/A	\$ 37	N/A
12"W x 18"D Right-hand	WKFFPN281218RH	\$ 1005	N/A	\$ 37	N/A
12"W x 24"D Left-hand	WKFFPN281224LH	\$ 1025	N/A	\$ 37	N/A
12"W x 24"D Right-hand (shown)	WKFFPN281224RH	\$ 1025	N/A	\$ 37	N/A
28"H Support Slim Pedestal — File / File with Back Panel					
9½"W x 24"D	WKPSFN28924-FF	1 \$ 1750	N/A	\$ 43	\$ 20
9½"W x 30"D	WKPSFN28930-FF	1 \$ 1791	N/A	\$ 45	\$ 21
Wall Access Panel 28"H					
18"W Full Height	WKHP2818	\$ 1015	N/A	\$ 37	N/A
24"W Full Height	WKHP2824	\$ 1050	N/A	\$ 38	N/A
30"W Full Height	WKHP2830	\$ 1107	N/A	\$ 41	N/A
36"W Full Height (shown)	WKHP2836	\$ 1136	N/A	\$ 42	N/A
42"W Full Height	WKHP2842	\$ 1173	N/A	\$ 43	N/A
48"W Full Height	WKHP2848	\$ 1221	N/A	\$ 44	N/A
Bridge 24"D with 14"H Half-Height Modesty Panel					
42"W	WKAUBG4224	\$ 1246	N/A	\$ 46	\$ 46
48"W	WKAUBG4824	\$ 1295	N/A	\$ 49	\$ 49

<p>How to specify — Select the Model Number from above.</p> <p>WK </p>	<p>1st Option: FSC Certified Wood: F FSC Certified X No FSC</p>	<p>2nd Option: Top Laminate and Predefined Edge (if applicable): See page 173 for finishes.</p>	<p>3rd Option: Pull Type (if applicable): MP Beam OP Halo AP Arch BP Bar SP Square See matrix on page 21.</p>	<p>4th Option: Pull Color (if applicable): MP Beam / OP Halo PJW Designer White PR6 Silver PJE Pyrite P8X Solar Black AP Arch PRO Anodized Silver P2 upcharge +\$18/pull</p>	<p>BP Bar P27 Black PJW Designer White PR6 Silver SP Square PJW Designer White EL Matte Silver P02 Flint P7B Loft PJE Pyrite P8X Solar Black P2 upcharge +\$18/pull</p>
<p>5th Option: Grommet Location (if applicable): See page 186. B Both Left and Right C Centered L Left R Right X No Grommet</p>	<p>6th Option: Grommet Type (if applicable): P Oval Plastic (will match edge trim) M Oval Metal (Add \$13 per grommet) S Square Metal (Add \$13 per grommet)</p>	<p>7th Option: Grommet Color (Metal only) (if applicable): EL Matte Silver</p>	<p>8th Option: Chassis Laminate and Predefined Edge (if applicable):</p>	<p>9th Option: Front Laminate and Predefined Edge (if applicable):</p>	

Examples: WKFFPN281218LH.F.LM14EW WKAUBG4224.LM16E9.LM16E9

For specification information see page 192.

GSA SIN 33721

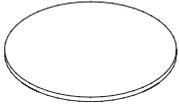

Description	Model	List Price	
		L1	L2
Round Laminate Table Tops with Flat Edge			
36" Diameter	WKTRD36	\$ 965	\$ 1001
42" Diameter	WKTRD42	\$ 1162	\$ 1204
48" Diameter	WKTRD48	\$ 1288	\$ 1334

Note: Reference table base specifications in Seating, Collaboration & Tables price list for applicable models and size limitations.

<p>How to specify — Select the Model Number from above.</p>	<p><i>1st Option:</i> FSC Certified Wood <i>(if applicable):</i> F FSC Certified X No FSC</p>	<p><i>2nd Option:</i> Top Laminate and Predefined Edge <i>(if applicable):</i> See page 173 for finishes.</p>
<p>W K T T . .</p>		<p> </p>

Example: WKTRD36.F.LM14EW

For specification information see page 192. Grommet location information on page 186.

GSA SIN 33721

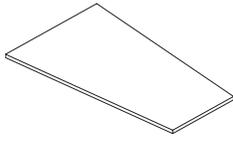

Description	Model	List Price	
		L1	L2
Double Sightline Laminate Worksurfaces (non-handed and no grommet option)			
60"W x 36"D - 24"D	WKWSDS6024	\$ 1364	\$ 1412
66"W x 36"D - 24"D	WKWSDS6624	\$ 1227	\$ 1271
72"W x 36"D - 24"D	WKWSDS7224	\$ 1613	\$ 1669
60"W x 42"D - 30"D	WKWSDS6030	\$ 1447	\$ 1497
66"W x 42"D - 30"D	WKWSDS6630	\$ 1299	\$ 1345
72"W x 42"D - 30"D	WKWSDS7230	\$ 1706	\$ 1765

<p>How to specify — Select the Model Number from above.</p>	<p>1st Option: FSC Certified Wood: F FSC Certified X No FSC</p>	<p>2nd Option: Top Laminate and Predefined Edge: See page 173 for finishes.</p>
<p>WKWS . .</p>		

Example: WKWSDS7230.X.LM14EW

For specification information see pages 192-193.

GSA SIN 33721

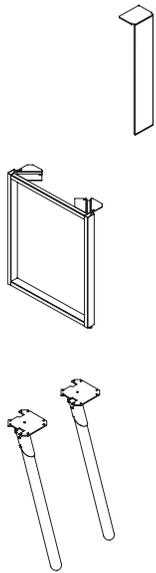

Description	Model	P1 Paint List Price	P2 Paint List Price	P3 Paint List Price
Support Column				
29"H	WKAUCB29	\$ 1235	\$ 1235	\$ 1235

O-Leg — 29"H (non-handed, painted metal)				
24"D	WKTBTTL2824	\$ 731	\$ 759	\$ 783
30"D	WKTBTTL2830	\$ 794	\$ 824	\$ 849

Splay Leg (sold in pairs, 2 legs per model)				
Approach Splay – Wood	WKSPLYWD	\$ 1259	\$ 1267	\$ 1277
Approach Splay Legs – Metal	WKSPLYMT	\$ 945	\$ 953	\$ 963

*Natural wood has inherent variations in color, grain, and texture Allsteel does not guarantee the exact matching of grain, pattern and color.

**Model includes a pair of legs with shroud included.

<p>How to specify — Select the Model Number from above.</p>	<p><i>1st Option:</i> Wood Toned Wood Legs (if applicable): LL302 Natural Oak Wood LL500 Natural Walnut Wood</p>	<p><i>2nd Option:</i> Shroud Paint: P1 P2 P3 See page 173 for finishes. P2 paint upcharge \$8 (except PR6) P3 paint upcharge \$18</p>	<p><i>3rd Option:</i> Metal Leg (if applicable): P1 P2 P3 See page 173 for finishes. P2 paint upcharge \$15 P3 paint upcharge \$34</p>
--	---	--	---

Example: WKTBTTL2824.PJW

For specification information see pages 192-193.

GSA SIN 33721



Description	Model	List Price
Worksurface Stanchions (non-handed; P02 Flint only, not specified)		
3"H x 12"D	WKST312	\$ 373
3"H x 18"D	WKST318	\$ 414
4"H x 12"DZ6PL40H	WKST412	\$ 395
4"H x 18"D	WKST418	\$ 431

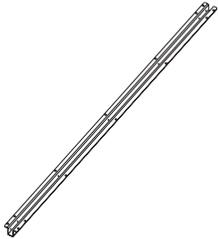

For use with open, non-supported tops		
External Worksurface Support Channel (no color option for stiffener) — 1½"H		
30"W for use on 42"W Worksurface	Z5SC42	\$ 86
36"W for use on 48"W Worksurface	Z5SC48	\$ 89
42"W for use on 54"W Worksurface	Z5SC54	\$ 102
48"W for use on 60"W Worksurface	Z5SC60	\$ 110
54"W for use on 66"W Worksurface	Z5SC66	\$ 128
60"W for use on 72"W Worksurface	Z5SC72	\$ 137
66"W for use on 78"W Worksurface	Z5SC78	\$ 150
72"W for use on 84"W Worksurface	Z5SC84	\$ 165

Note: Width of support channel may need to be reduced to accommodate width of storage.

How to specify —

Select the Model Number from above.



Examples: WKST312 Z5SC42

For specification information see pages 192-193.

GSA SIN 33721

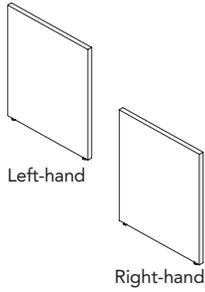

Description	Model	List Price	
		L1	L2
End Panel Supports — 28"H			
14"D Left-Hand	WKEP2814LH	\$ 582	\$ 605
14"D Right-Hand	WKEP2814RH	\$ 582	\$ 605
24"D Left-Hand	WKEP2824LH	\$ 610	\$ 633
24"D Right-Hand	WKEP2824RH	\$ 610	\$ 633
30"D Left-Hand	WKEP2830LH	\$ 672	\$ 697
30"D Right-Hand	WKEP2830RH	\$ 672	\$ 697
36"D Left-Hand	WKEP2836LH	\$ 781	\$ 810
36"D Right-Hand	WKEP2836RH	\$ 781	\$ 810

Note: Must order handed half modesty or full modesty panel. See below.

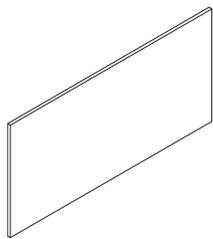

Description	Model	List Price	
		L1	L2
28"H Full-Height Laminate Modesty Panels (non-handed) <i>nominal height 27.861"</i>			
48" W	WKMP2848	\$ 907	\$ 940
54" W	WKMP2854	\$ 1019	\$ 1057
60" W (shown)	WKMP2860	\$ 1131	\$ 1173
66" W	WKMP2866	\$ 1246	\$ 1292
72" W	WKMP2872	\$ 1358	\$ 1408

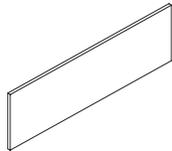

Description	MODEL – Handed Models: Add "L" for Left-hand model Add "R" for Right-hand model	List Price	
		L1	L2
14"H Half-Height Laminate Modesty Panels (non-handed)			
30"W*	WKMP1430	\$ 390	\$ 407
36"W*	WKMP1436	\$ 439	\$ 457
42"W	WKMP1442	\$ 494	\$ 514
48"W	WKMP1448	\$ 558	\$ 580
54"W	WKMP1454	\$ 605	\$ 628
60"W	WKMP1460	\$ 632	\$ 656
66"W	WKMP1466	\$ 661	\$ 686
72"W	WKMP1472	\$ 692	\$ 719

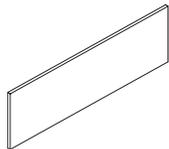

Left-hand

14"H Half-Height Laminate Modesty Panels (handed)			
36"W*	WKMP1436 □ H	\$ 453	\$ 472
42"W	WKMP1442 □ H	\$ 508	\$ 528
48"W	WKMP1448 □ H	\$ 570	\$ 592
54"W	WKMP1454 □ H	\$ 622	\$ 646
60"W	WKMP1460 □ H	\$ 651	\$ 676
66"W	WKMP1466 □ H	\$ 681	\$ 706
72"W	WKMP1472 □ H	\$ 710	\$ 737

Handed models are designed for use with laminate end panel supports, see above.

Example of left-hand model shown: **WKMP1448LH**

<p>How to specify — Select the Model Number from above.</p> <p>WK . .</p>	<p>1st Option: FSC Certified Wood (if applicable): F FSC Certified X No FSC</p>	<p>2nd Option: Top Laminate and Predefined Edge (if applicable):</p>	
--	--	---	--

Examples: **WKMP1430.F.LM14EW** **WKMP1436LH.X.LM14EW**

For specification information see pages 194-197.

GSA SIN PENDING, GSA SIN 33721

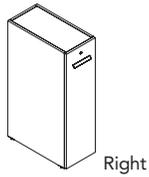

Right

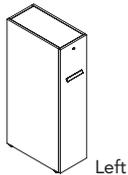

Left

Side View

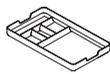
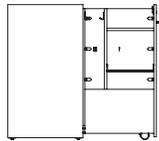

Description	Model	Lock	L1 Laminate List Price	UPCHARGES*	
				L2 Laminate Chassis	Front
12"W Pullout Tower					
42½"H x 24"D – Left	WKPT421224LH	1	\$ 3358	\$ 37	\$ 37
42½"H x 24"D – Right (shown)	WKPT421224RH	1	\$ 3358	\$ 37	\$ 37
42½"H x 30"D – Left	WKPT421230LH	1	\$ 3758	\$ 42	\$ 42
42½"H x 30"D – Right	WKPT421230RH	1	\$ 3758	\$ 42	\$ 42
50"H x 24"D – Left	WKPT501224LH	1	\$ 3998	\$ 44	\$ 44
50"H x 24"D – Right (shown)	WKPT501224RH	1	\$ 3998	\$ 44	\$ 44
50"H x 30"D – Left (shown)	WKPT501230LH	1	\$ 4476	\$ 48	\$ 48
50"H x 30"D – Right	WKPT501230RH	1	\$ 4476	\$ 48	\$ 48

Radii Small Tray for 10"W model available in Designer White (.DW) See page 142.

1½"H x 8½"W x 14¾"D	AEST	\$ 64
GSA SIN Pending		

How to specify — Select the Model Number from above.	1st Option: FSC Certified Wood: F FSC Certified X No FSC	2nd Option: Chassis Laminate and Predefined Edge:	3rd Option: Front Laminate and Predefined Edge:	4th Option: Drawer Laminate and Predefined Edge (if applicable): LM11 Loft LM16 Flint LDW1 Designer White
WK P T

5th Option: Pull Type (if applicable): MP Beam OP Halo AP Arch BP Bar SP Square See matrix on page 21.	6th Option: Pull Color (if applicable): MP Beam / OP Halo PJW Designer White PR6 Silver PJE Pyrite P8X Solar Black AP Arch PRO Anodized Silver P2 upcharge +\$18/pull	7th Option: Lock (if applicable): STD Standard OMT Omit Lock Core (Deduct \$20 per lock)
.	.	.

Examples: WKPT501224RH. X.LM14EW.LM14EW.LSW1SW.BPPJW.STD AEST.DW

For specification information see pages 194-197.
 First, select Post foot (Y) or Non-footed (N), if footed add \$100 to listed price.
 Next, select Left (L) or Right (R) before configuration of tower.

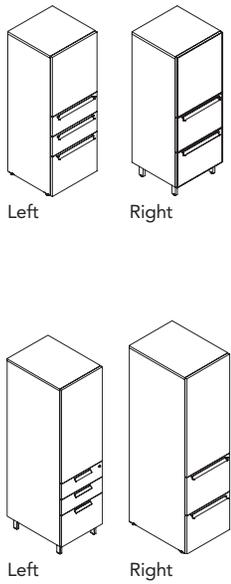

Description	Model	Lock	L1 Laminate List Price	UPCHARGES*	
				L2 Laminate Chassis	Front
50"H Personal Tower					
18"D Combination Tower L/R Door/Box/Box/File (shown)	WK □ T501818 □ BBF	1	\$ 3697	\$ 42	\$ 42
18"D Combination Tower L/R Door/File/File (shown)	WK □ T501818 □ FF	1	\$ 3617	\$ 41	\$ 41
24"D Combination Tower L/R Door/File/File	WK □ T501824 □ FF	1	\$ 3855	\$ 43	\$ 43
24"D Combination Tower L/R Door/Box/Box/File	WK □ T501824 □ BBF	1	\$ 4012	\$ 45	\$ 45
57½"H Personal Tower					
18"D Combination Tower L/R Door/Box/Box/File	WK □ T571818 □ BBF	1	\$ 3933	\$ 44	\$ 44
18"D Combination Tower L/R Door/File/File	WK □ T571818 □ FF	1	\$ 3776	\$ 42	\$ 42
24"D Combination Tower L/R Door/File/File	WK □ T571824 □ FF	1	\$ 4012	\$ 45	\$ 45
24"D Combination Tower L/R Door/Box/Box/File	WK □ T571824 □ BBF	1	\$ 4170	\$ 46	\$ 46
65"H Personal Tower					
18"D Combination Tower L/R Door/Box/Box/File (shown)	WK □ T651818 □ BBF	1	\$ 4248	\$ 47	\$ 47
18"D Combination Tower L/R Door/File/File	WK □ T651818 □ FF	1	\$ 4092	\$ 45	\$ 45
24"D Combination Tower L/R Door/File/File (shown)	WK □ T651824 □ FF	1	\$ 4328	\$ 48	\$ 48
24"D Combination Tower L/R Door/Box/Box/File	WK □ T651824 □ BBF	1	\$ 4484	\$ 49	\$ 49
72"H Personal Tower					
18"D Combination Tower L/R Door/Box/Box/File	WK □ T721818 □ BBF	1	\$ 4564	\$ 50	\$ 50
18"D Combination Tower L/R Door/File/File	WK □ T721818 □ FF	1	\$ 4564	\$ 50	\$ 50
24"D Combination Tower L/R Door/File/File	WK □ T721824 □ FF	1	\$ 4798	\$ 53	\$ 53
24"D Combination Tower L/R Door/Box/Box/File	WK □ T721824 □ BBF	1	\$ 4798	\$ 53	\$ 53

All units ship with hardware to gang as individual models must be connected to an adjacent unit.
 *Upcharges are added to L1 Laminate List Price depending on woodgrain laminate selection.

<p>How to specify — Select the Model Number from above.</p> <p>WK T .</p>	<p>1st Option:</p> <p>FSC Certified Wood:</p> <p>F FSC Certified X No FSC</p>	<p>2nd Option:</p> <p>Chassis Laminate and Predefined Edge:</p>	<p>3rd Option:</p> <p>Front Laminate and Predefined Edge:</p>
	<p> .</p>	<p> .</p>	<p> .</p>

<p>4th Option:</p> <p>Pull Type (if applicable):</p> <p>MP Beam OP Halo AP Arch BP Bar SP Square See matrix on page 21.</p> <p> .</p>	<p>5th Option:</p> <p>Pull Color (if applicable):</p> <p>MP Beam / OP Halo PJW Designer White PR6 Silver PJE Pyrite P8X Solar Black AP Arch PRO Anodized Silver P2 upcharge +\$18/pull</p> <p> .</p>	<p>6th Option:</p> <p>Foot Type (if applicable):</p> <p>PF Post Foot</p> <p>Foot Color (if applicable):</p> <p>PJW Designer White PR6 Silver P02 Flint P7B Loft PJE Pyrite (+\$13) P8X Solar Black (+\$13)</p> <p>P F P .</p>	<p>7th Option:</p> <p>Lock (if applicable):</p> <p>STD Standard OMT Omit Lock Core (Deduct \$20 per lock)</p> <p> .</p>
--	---	--	--

Example: WKYT651818RBBF.X.LM14EW.LM14EW.BPPJW.PFPJW.STD

For specification information see pages 194-197.
 First, select Post foot (Y) or Non-footed (N), if footed add \$100 to listed price.
 Next, select Left (L) or Right (R) before configuration of tower.

GSA SIN 33721

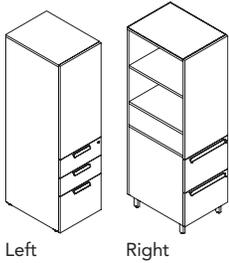
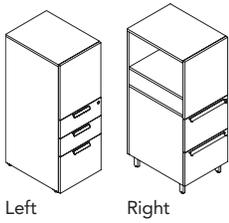

Description	Model	Lock	L1 Laminate List Price	UPCHARGES*	
				L2 Laminate Chassis	Front
50"H Side Access Tower					
18"D Combination Tower L/R Door/Box/Box/File (shown)	WK □ ST501818 □ BBF	1	\$ 3697	\$ 42	\$ 42
18"D Combination Tower L/R Door/File/File	WK □ ST501818 □ FF	1	\$ 3617	\$ 41	\$ 41
24"D Combination Tower L/R Door/File/File (shown)	WK □ ST501824 □ FF	1	\$ 3855	\$ 43	\$ 43
24"D Combination Tower L/R Door/Box/Box/File	WK □ ST501824 □ BBF	1	\$ 4012	\$ 45	\$ 45
57½"H Side Access Tower					
18"D Combination Tower L/R Door/Box/Box/File	WK □ ST571818 □ BBF	1	\$ 3933	\$ 44	\$ 44
18"D Combination Tower L/R Door/File/File	WK □ ST571818 □ FF	1	\$ 3776	\$ 42	\$ 42
24"D Combination Tower L/R Door/File/File	WK □ ST571824 □ FF	1	\$ 4012	\$ 45	\$ 45
24"D Combination Tower L/R Door/Box/Box/File	WK □ ST571824 □ BBF	1	\$ 4170	\$ 46	\$ 46
65"H Side Access Tower					
18"D Combination Tower L/R Door/Box/Box/File (shown)	WK □ ST651818 □ BBF	1	\$ 4248	\$ 47	\$ 47
18"D Combination Tower L/R Door/File/File	WK □ ST651818 □ FF	1	\$ 4092	\$ 45	\$ 45
24"D Combination Tower L/R Door/File/File (shown)	WK □ ST651824 □ FF	1	\$ 4328	\$ 48	\$ 48
24"D Combination Tower L/R Door/Box/Box/File	WK □ ST651824 □ BBF	1	\$ 4484	\$ 49	\$ 49
72"H Side Access Tower					
18"D Combination Tower L/R Door/Box/Box/File	WK □ ST721818 □ BBF	1	\$ 4564	\$ 50	\$ 50
18"D Combination Tower L/R Door/File/File	WK □ ST721818 □ FF	1	\$ 4564	\$ 50	\$ 50
24"D Combination Tower L/R Door/File/File	WK □ ST721824 □ FF	1	\$ 4798	\$ 53	\$ 53
24"D Combination Tower L/R Door/Box/Box/File	WK □ ST721824 □ BBF	1	\$ 4798	\$ 53	\$ 53

All units ship with hardware to gang as individual models must be connected to an adjacent unit.
 *Upcharges are added to L1 Laminate List Price depending on woodgrain laminate selection.

APPROACH

<p>How to specify — Select the Model Number from above.</p> <p>WK S T .</p>	<p>1st Option: FSC Certified Wood:</p> <p>F FSC Certified X No FSC</p>	<p>2nd Option: Chassis Laminate and Predefined Edge:</p>	<p>3rd Option: Front Laminate and Predefined Edge:</p>
	<p> .</p>	<p> .</p>	<p> .</p>

<p>4th Option: Pull Type (if applicable):</p> <p>MP Beam OP Halo AP Arch BP Bar SP Square See matrix on page 21.</p>	<p>5th Option: Pull Color (if applicable):</p> <p>MP Beam / OP Halo PJW Designer White PR6 Silver PJE Pyrite P8X Solar Black AP Arch PRO Anodized Silver P2 upcharge +\$18/pull</p>	<p>6th Option: Foot Type (if applicable):</p> <p>PF Post Foot</p> <p>Foot Color (if applicable): PJW Designer White PR6 Silver P02 Flint P7B Loft PJE Pyrite (+\$13) P8X Solar Black (+\$13)</p>	<p>7th Option: Lock (if applicable):</p> <p>STD Standard OMT Omit Lock Core (Deduct \$20 per lock)</p>
<p> .</p>	<p> .</p>	<p>P F P .</p>	<p> .</p>

Example: WKYST651824RBBF.X.LM14EW.LM14EW.BPPJW.PFP8X.STD

For specification information see pages 194-197.
 First, select Post foot (Y) or Non-footed (N), if footed add \$100 to listed price.
 Next, select Left (L) or Right (R) before configuration of tower.

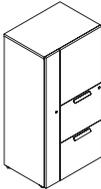
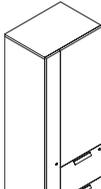
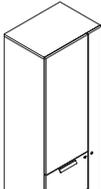
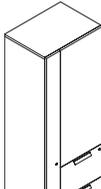
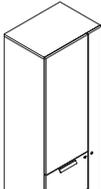
	Description	Model	Lock	L1 Laminate List Price	UPCHARGES*		
					L2 Laminate Chassis	L2 Laminate Front	
 Left	50"H Personal Tower						
	18"D Combination Tower L/R Door/Box/Box/File (shown)	WK □ T502418 □ BBF	2	\$ 3933	\$ 44	\$ 44	
	18"D Combination Tower L/R Door/File/File	WK □ T502418 □ FF	2	\$ 3933	\$ 44	\$ 44	
	24"D Combination Tower L/R Door/File/File (shown)	WK □ T502424 □ FF	2	\$ 4248	\$ 47	\$ 47	
 Right	24"D Combination Tower L/R Door/Box/Box/File	WK □ T502424 □ BBF	2	\$ 4363	\$ 48	\$ 48	
	57½"H Personal Tower						
	18"D Combination Tower L/R Door/Box/Box/File	WK □ T572418 □ BBF	2	\$ 4092	\$ 45	\$ 45	
	18"D Combination Tower L/R Door/File/File	WK □ T572418 □ FF	2	\$ 4092	\$ 45	\$ 45	
 Left	24"D Combination Tower L/R Door/File/File	WK □ T572424 □ FF	2	\$ 4404	\$ 48	\$ 48	
	24"D Combination Tower L/R Door/Box/Box/File	WK □ T572424 □ BBF	2	\$ 4564	\$ 50	\$ 50	
	65"H Personal Tower						
	18"D Combination Tower L/R Door/Box/Box/File (shown)	WK □ T652418 □ BBF	2	\$ 4404	\$ 48	\$ 48	
 Right	18"D Combination Tower L/R Door/File/File	WK □ T652418 □ FF	2	\$ 4404	\$ 48	\$ 48	
	24"D Combination Tower L/R Door/File/File (shown)	WK □ T652424 □ FF	2	\$ 5142	\$ 57	\$ 57	
	24"D Combination Tower L/R Door/Box/Box/File	WK □ T652424 □ BBF	2	\$ 5298	\$ 58	\$ 58	
	72"H Personal Tower						
 Left	18"D Combination Tower L/R Door/Box/Box/File	WK □ T722418 □ BBF	2	\$ 4721	\$ 52	\$ 52	
	18"D Combination Tower L/R Door/File/File	WK □ T722418 □ FF	2	\$ 4880	\$ 54	\$ 54	
	24"D Combination Tower L/R Door/File/File	WK □ T722424 □ FF	2	\$ 5349	\$ 58	\$ 58	
	24"D Combination Tower L/R Door/Box/Box/File	WK □ T722424 □ BBF	2	\$ 5349	\$ 58	\$ 58	
 Right	All units ship with hardware to gang as individual models must be connected to an adjacent unit. Exception: 24"D x 24"W <u>non-footed</u> units can be freestanding and do not require ganging.						
	*Upcharges are added to L1 Laminate List Price depending on woodgrain laminate selection.						
	All towers have a hang feature included, 18"D units have coat hooks and 24"D units have coat rods.						

<p>How to specify — Select the Model Number from above.</p> <p>WK T .</p>	<p>1st Option: FSC Certified Wood: F FSC Certified X No FSC</p>	<p>2nd Option: Chassis Laminate and Predefined Edge:</p>	<p>3rd Option: Front Laminate and Predefined Edge:</p>
<p>4th Option: Pull Type (if applicable): MP Beam OP Halo AP Arch BP Bar SP Square See matrix on page 21.</p>	<p>5th Option: Pull Color (if applicable): MP Beam / OP Halo P27 Designer White PR6 Silver PJE Pyrite P8X Solar Black AP Arch PRO Anodized Silver P2 upcharge +\$18/pull</p>	<p>6th Option: Foot Type (if applicable): PF Post Foot Foot Color (if applicable): P27 Designer White PR6 Silver P02 Flint P7B Loft PJE Pyrite (+\$13) P8X Solar Black (+\$13)</p>	<p>7th Option: Lock (if applicable): STD Standard OMT Omit Lock Core (Deduct \$20 per lock)</p>
<p> .</p>	<p> .</p>	<p> .</p>	<p> .</p>

Example: WKNT501824RBBF.X.LM14EW.LM14EW.LSW1SW.BPPJW.STD

For specification information see pages 194-197.
 First, select Post foot (Y) or Non-footed (N), if footed add \$100 to listed price.
 Next, select Left (L) or Right (R) before configuration of tower.

Description	Model	Lock	L1 Laminate List Price	UPCHARGES*	
				L2 Laminate Chassis	Front
50"H Side Access Tower					
18"D Combination Tower L/R Door/Box/Box/File (shown)	WK □ ST502418 □ BBF	2	\$ 3933	\$ 44	\$ 44
18"D Combination Tower L/R Door/File/File	WK □ ST502418 □ FF	2	\$ 3933	\$ 44	\$ 44
24"D Combination Tower L/R Door/File/File (shown)	WK □ ST502424 □ FF	2	\$ 4248	\$ 47	\$ 47
24"D Combination Tower L/R Door/Box/Box/File	WK □ ST502424 □ BBF	2	\$ 4363	\$ 48	\$ 48
57½"H Side Access Tower					
18"D Combination Tower L/R Door/Box/Box/File (shown)	WK □ ST572418 □ BBF	2	\$ 4092	\$ 45	\$ 45
18"D Combination Tower L/R Door/File/File	WK □ ST572418 □ FF	2	\$ 4092	\$ 45	\$ 45
24"D Combination Tower L/R Door/File/File (shown)	WK □ ST572424 □ FF	2	\$ 4404	\$ 48	\$ 48
24"D Combination Tower L/R Door/Box/Box/File	WK □ ST572424 □ BBF	2	\$ 4564	\$ 50	\$ 50
65"H Side Access Tower					
18"D Combination Tower L/R Door/Box/Box/File (shown)	WK □ ST652418 □ BBF	2	\$ 4404	\$ 48	\$ 48
18"D Combination Tower L/R Door/File/File	WK □ ST652418 □ FF	2	\$ 4404	\$ 48	\$ 48
24"D Combination Tower L/R Door/File/File (shown)	WK □ ST652424 □ FF	2	\$ 4721	\$ 52	\$ 52
24"D Combination Tower L/R Door/Box/Box/File	WK □ ST652424 □ BBF	2	\$ 4880	\$ 54	\$ 54
72"H Side Access Tower					
18"D Combination Tower L/R Door/Box/Box/File	WK □ ST722418 □ BBF	2	\$ 4721	\$ 52	\$ 52
18"D Combination Tower L/R Door/File/File	WK □ ST722418 □ FF	2	\$ 4880	\$ 54	\$ 54
24"D Combination Tower L/R Door/File/File	WK □ ST722424 □ FF	2	\$ 5349	\$ 58	\$ 58
24"D Combination Tower L/R Door/Box/Box/File	WK □ ST722424 □ BBF	2	\$ 5349	\$ 58	\$ 58

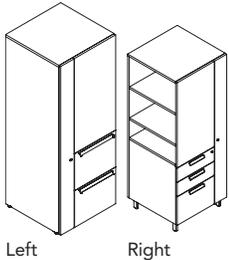
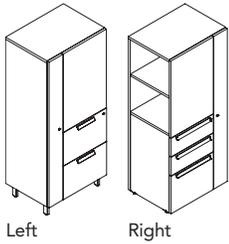
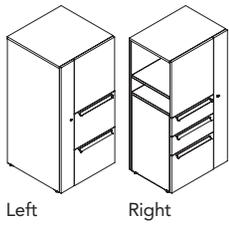

All units ship with hardware to gang as individual models must be connected to an adjacent unit. Exception: 24"D x 24"W non-footed units can be freestanding and do not require ganging.
 *Upcharges are added to L1 Laminate List Price depending on woodgrain laminate selection.
 All towers have a hang feature included, 18"D units have coat hooks and 24"D units have coat rods.

APPROACH

<p>How to specify — Select the Model Number from above.</p> <p>WK S T .</p>	<p>1st Option: FSC Certified Wood: F FSC Certified X No FSC</p>	<p>2nd Option: Chassis Laminate and Predefined Edge:</p>	<p>3rd Option: Front Laminate and Predefined Edge:</p>	<p>4th Option: Pull Type (if applicable): MP Beam OP Halo AP Arch BP Bar SP Square See matrix on page 21.</p>	<p>5th Option: Pull Color (if applicable): MP Beam / OP Halo P27 Designer White PR6 Silver PJE Pyrite P8X Solar Black AP Arch PRO Anodized Silver P2 upcharge +\$18/pull</p>	<p>6th Option: Foot Type (if applicable): PF Post Foot Foot Color (if applicable): P27 Designer White PR6 Silver P02 Flint P7B Loft PJE Pyrite (+\$13) P8X Solar Black (+\$13)</p>	<p>7th Option: Lock (if applicable): STD Standard OMT Omit Lock Core (Deduct \$20 per lock)</p>

Example: WKNST651824RBBF.X.LM14EW.LM14EW.BPPJW.STD

For specification information see pages 194-197.
Post Foot (Y/N) add \$100 to listed price on footed option.

GSA SIN 33721

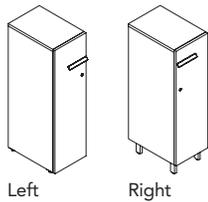

Left Right

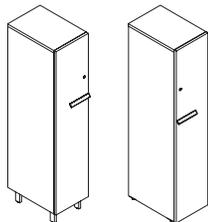

Left Right

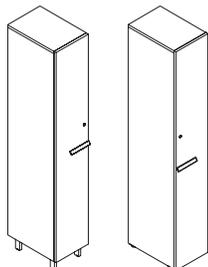

Left Right

Description	Model	Lock	L1 Laminate List Price	UPCHARGES*	
				L2 Laminate Chassis	Front
42½"H Wardrobe					
18"D Wardrobe Hinges on Left (shown)	WK □ T421218L	1	\$ 2620	\$ 29	\$ 29
18"D Wardrobe Hinges on Right (shown)	WK □ T421218R	1	\$ 2620	\$ 29	\$ 29
24"D Wardrobe Hinges on Left	WK □ T421224L	1	\$ 2660	\$ 30	\$ 30
24"D Wardrobe Hinges on Right	WK □ T421224R	1	\$ 2660	\$ 30	\$ 30
*Includes one adjustable shelf and location for a second adjustable shelf.					
50"H Wardrobe					
18"D Wardrobe Hinges on Left	WK □ T501218L	1	\$ 2698	\$ 30	\$ 30
18"D Wardrobe Hinges on Right	WK □ T501218R	1	\$ 2698	\$ 30	\$ 30
24"D Wardrobe Hinges on Left	WK □ T501224L	1	\$ 2754	\$ 31	\$ 31
24"D Wardrobe Hinges on Right	WK □ T501224R	1	\$ 2754	\$ 31	\$ 31
*Includes one adjustable shelf and location for a second adjustable shelf.					
57½"H Wardrobe					
18"D Wardrobe Hinges on Left (shown)	WK □ T571218L	1	\$ 2817	\$ 31	\$ 31
18"D Wardrobe Hinges on Right (shown)	WK □ T571218R	1	\$ 2817	\$ 31	\$ 31
24"D Wardrobe Hinges on Left	WK □ T571224L	1	\$ 2832	\$ 31	\$ 31
24"D Wardrobe Hinges on Right	WK □ T571224R	1	\$ 2832	\$ 31	\$ 31
*Includes two adjustable shelf locations and one fixed shelf 13" above base panel.					
65"H Wardrobe					
18"D Wardrobe Hinges on Left	WK □ T651218L	1	\$ 2856	\$ 32	\$ 32
18"D Wardrobe Hinges on Right	WK □ T651218R	1	\$ 2856	\$ 32	\$ 32
24"D Wardrobe Hinges on Left	WK □ T651224L	1	\$ 2871	\$ 32	\$ 32
24"D Wardrobe Hinges on Right	WK □ T651224R	1	\$ 2871	\$ 32	\$ 32
*Includes two adjustable shelf locations and one fixed shelf 13" above base panel.					
72"H Wardrobe					
18"D Wardrobe Hinges on Left (shown)	WK □ T721218L	1	\$ 2999	\$ 33	\$ 33
18"D Wardrobe Hinges on Right (shown)	WK □ T721218R	1	\$ 2999	\$ 33	\$ 33
24"D Wardrobe Hinges on Left	WK □ T721224L	1	\$ 3087	\$ 34	\$ 34
24"D Wardrobe Hinges on Right	WK □ T721224R	1	\$ 3087	\$ 34	\$ 34
*Includes three adjustable shelf locations and one fixed shelf 13" above base panel.					

All units ship with hardware to gang as individual models must be connected to an adjacent unit.
All towers have a hang feature included, 18"D units have coat hooks and 24"D units have coat rods.
*Upcharges are added to L1 Laminate List Price depending on woodgrain laminate selection.

APPROACH

How to specify — Select the Model Number from above.	1st Option: FSC Certified Wood: F FSC Certified X No FSC	2nd Option: Chassis Laminate and Predefined Edge:	3rd Option: Front Laminate and Predefined Edge:
	WK T .	.	.

4th Option: Pull Type (if applicable): MP Beam OP Halo AP Arch BP Bar SP Square See matrix on page 21.	5th Option: Pull Color (if applicable): MP Beam / OP Halo PJW Designer White PR6 Silver PJE Pyrite P8X Solar Black AP Arch PRO Anodized Silver P2 upcharge +\$18/pull	6th Option: Foot Type (if applicable): PF Post Foot Foot Color (if applicable): PJW Designer White PR6 Silver P02 Flint P7B Loft PJE Pyrite (+\$13) P8X Solar Black (+\$13)	7th Option: Lock (if applicable): STD Standard OMT Omit Lock Core (Deduct \$20 per lock)
.	.	P F P .	.

Example: WKYST651824RBBF.X.LM14EW.LM14EW.BPPJW.PFP8X.OMT

For specification information see pages 194-197.
Post Foot (Y/N) add \$100 to listed price on footed option.

GSA SIN 33721

Description	Model	Lock	L1 Laminate List Price	UPCHARGES*	
				Chassis	L2 Laminate Front
42½"H Wardrobe					
18"D Wardrobe Double Door	WK □ T422418	1	\$ 2990	\$ 33	\$ 33
24"D Wardrobe Double Door (shown)	WK □ T422424	1	\$ 3079	\$ 34	\$ 34
*Includes one adjustable shelf and location for a second adjustable shelf on right side of unit with left side being an open wardrobe.					
50"H Wardrobe					
18"D Wardrobe Double Door	WK □ T502418	1	\$ 2966	\$ 33	\$ 33
24"D Wardrobe Double Door	WK □ T502424	1	\$ 3055	\$ 34	\$ 34
*Includes one adjustable shelf and location for a second adjustable shelf on right side of unit with left side being an open wardrobe.					
57½"H Wardrobe					
18"D Wardrobe Double Door (shown)	WK □ T572418	1	\$ 3265	\$ 37	\$ 37
24"D Wardrobe Double Door (shown)	WK □ T572424	1	\$ 3362	\$ 38	\$ 38
*Includes two adjustable shelf locations and one fixed shelf 13" above base panel on right side of unit with left side being an open wardrobe.					
65"H Wardrobe					
18"D Wardrobe Double Door	WK □ T652418	1	\$ 3342	\$ 37	\$ 37
24"D Wardrobe Double Door	WK □ T652424	1	\$ 4182	\$ 46	\$ 46
*Includes two adjustable shelf locations and one fixed shelf 13" above base panel on right side of unit with left side being an open wardrobe.					
72"H Wardrobe					
18"D Wardrobe Double Door (shown)	WK □ T722418	1	\$ 3555	\$ 40	\$ 40
24"D Wardrobe Double Door (shown)	WK □ T722424	1	\$ 3663	\$ 41	\$ 41
*Includes three adjustable shelf locations and one fixed shelf 13" above base panel on right side of unit with left side being an open wardrobe.					

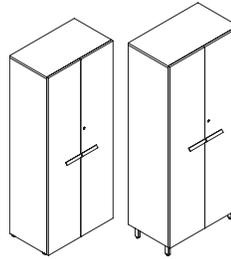
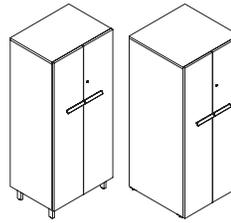
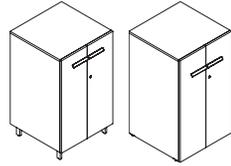

All units ship with hardware to gang as individual models must be connected to an adjacent unit. Exception: 24"D x 24"W non-footed units can be freestanding and do not require ganging.

All towers have a hang feature included, 18"D units have coat hooks and 24"D units have coat rods.

*Upcharges are added to L1 Laminate List Price depending on woodgrain laminate selection.

APPROACH

How to specify — Select the Model Number from above. WK T	1st Option: FSC Certified Wood: F FSC Certified X No FSC	2nd Option: Chassis Laminate and Predefined Edge:	3rd Option: Front Laminate and Predefined Edge:
	.	.	.

4th Option: Pull Type (if applicable): MP Beam OP Halo AP Arch BP Bar SP Square See matrix on page 21.	5th Option: Pull Color (if applicable): MP Beam / OP Halo PJW Designer White PR6 Silver PJE Pyrite P8X Solar Black AP Arch PRO Anodized Silver P2 upcharge +\$18/pull	6th Option: Foot Type (if applicable): PF Post Foot Foot Color (if applicable): PJW Designer White PR6 Silver P02 Flint P7B Loft PJE Pyrite (+\$13) P8X Solar Black (+\$13)	7th Option: Lock (if applicable): STD Standard OMT Omit Lock Core (Deduct \$20 per lock)
.	.	.	.

Example: WKYT572418R.X.LM14EW.LM14EW.BPP27.PFP8X.STD

For specification information see pages 194-197.

GSA SIN 33721

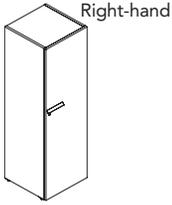

Description	MODEL – Handed Models: Add "L" for Left-hand model Add "R" for Right-hand model		Locks	L1 Laminate List Price	UPCHARGES*	
					L2 Laminate Chassis	Front
18"W Tower with Hinged Door (handed)						
56"H x 18"D Laminate Door	WKCLFN4H1818	H-HDL	1	\$ 2854	\$ 68	\$ 31
56"H x 24"D Laminate Door	WKCLFN4H1824	H-HDL	1	\$ 2911	\$ 72	\$ 32
71"H x 18"D Laminate Door	WKCLFN5H1818	H-HDL	1	\$ 2964	\$ 73	\$ 32
71"H x 24"D Laminate Door	WKCLFN5H1824	H-HDL	1	\$ 3015	\$ 74	\$ 33
Example of right-hand model shown: WKCLFN4H1818RH-HDL						

All units ship with hardware to gang as individual models must be connected to an adjacent unit.

*Upcharges are added to L1 Laminate List Price depending on woodgrain laminate selection.

*All doors and drawers have pulls.

For specification information see pages 179-201.

Select Post Foot "Y" or Non-footed "N" (add \$100 for footed option). Next (Handed Models): select left-hand "L" or right-hand "R."

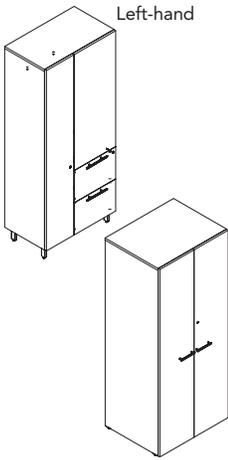

Description	MODEL – Handed Models: Add "L" for Left-hand model Add "R" for Right-hand model		Locks	L1 Laminate List Price	UPCHARGES*	
					L2 Laminate Chassis	Front
30"W Personal Tower (handed)						
72"H x 18"D Combination Tower L/R Door/File/File	WK	T723018	FF	2	\$ 4985	\$ 113 \$ 77
72"H x 24"D Combination Tower L/R Door/File/File	WK	T723024	FF	2	\$ 5607	\$ 128 \$ 85
Example of left-hand model shown: WKYT723018LFF						
30"W Wardrobe (non-handed)						
72"H x 18"D Laminate Front	WK	T723018		1	\$ 3832	\$ 87 \$ 58
72"H x 24"D Laminate Front	WK	T723024		1	\$ 3937	\$ 90 \$ 60
All units ship with hardware to gang as individual models must be connected to an adjacent unit. Exception: 24"D x 30"W non-footed units can be freestanding and do not require ganging.						

*Upcharges are added to L1 Laminate List Price depending on woodgrain laminate selection.

*All doors and drawers have pulls.

<p>How to specify — Select the Model Number from above.</p> <p>WK .</p>	<p>1st Option: FSC Certified Wood:</p> <p>F FSC Certified X No FSC</p> <p> .</p>	<p>2nd Option: Chassis Laminate and Predefined Edge:</p> <p> .</p>	<p>3rd Option: Front Laminate and Predefined Edge:</p> <p> .</p>
--	--	--	--

<p>4th Option: Pull Type (if applicable):</p> <p>MP Beam OP Halo AP Arch BP Bar SP Square</p> <p>See matrix on page 21.</p> <p> .</p>	<p>5th Option: Pull Color (if applicable):</p> <p>MP Beam / OP Halo P JW Designer White PR6 Silver P JE Pyrite P8X Solar Black AP Arch PR0 Anodized Silver P2 upcharge +\$18/pull</p> <p> .</p>	<p>6th Option: Foot Type (if applicable):</p> <p>PF Post Foot</p> <p>Foot Color (if applicable): P JW Designer White PR6 Silver P O2 Flint P7B Loft P JE Pyrite (+\$13) P8X Solar Black (+\$13)</p> <p>P F P .</p>	<p>7th Option: Lock (if applicable):</p> <p>STD Standard OMT Omit Lock Core (Deduct \$20 per lock)</p> <p> .</p>
---	---	--	--

Example: **WKCLFN4H1818LH-HDL.F.LM14EW.LM13EY.APPR6.STD**

For specification information see pages 196-197.

GSA SIN 33721

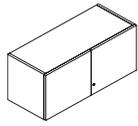

Description	Model	Locks	L1 Laminate List Price	UPCHARGES*	
				L2 Laminate Chassis	Front
Overhead Storage — Laminate Hinged Doors — 15 1/8"H x 15 1/8"D					
30"W with 2 Doors	WKOH153015-HDL	1	\$ 1778	\$ 45	\$ 21
36"W with 2 Doors	WKOH153615-HDL	1	\$ 1942	\$ 48	\$ 22
42"W with 2 Doors	WKOH154215-HDL	1	\$ 2178	\$ 54	\$ 25
48"W with 3 Doors	WKOH154815-HDL	1	\$ 2437	\$ 59	\$ 28
60"W with 4 Doors	WKOH156015-HDL	2	\$ 2669	\$ 65	\$ 30
66"W with 4 Doors	WKOH156615-HDL	2	\$ 2791	\$ 68	\$ 31
72"W with 4 Doors	WKOH157215-HDL	2	\$ 2917	\$ 72	\$ 32
78"W with 4 Doors	WKOH157815-HDL	2	\$ 3140	\$ 75	\$ 34

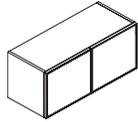

Overhead Storage — Frosted Glass Hinged Doors — 15 1/8"H x 15 1/8"D					
30"W with 2 Doors	WKOH153015-HDG	—	\$ 2669	\$ 65	N/A
36"W with 2 Doors	WKOH153615-HDG	—	\$ 2916	\$ 72	N/A
42"W with 2 Doors	WKOH154215-HDG	—	\$ 3254	\$ 80	N/A
48"W with 3 Doors	WKOH154815-HDG	—	\$ 3643	\$ 89	N/A
60"W with 4 Doors	WKOH156015-HDG	—	\$ 4003	\$ 96	N/A
66"W with 4 Doors	WKOH156615-HDG	—	\$ 4176	\$ 101	N/A
72"W with 4 Doors	WKOH157215-HDG	—	\$ 4376	\$ 106	N/A
78"W with 4 Doors	WKOH157815-HDG	—	\$ 4690	\$ 111	N/A

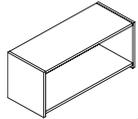

Overhead Storage — Open Bin — 15 1/8"H x 15 1/8"D					
30"W	WKOH153015-NDL	—	\$ 1424	\$ 34	N/A
36"W	WKOH153615-NDL	—	\$ 1414	\$ 36	N/A

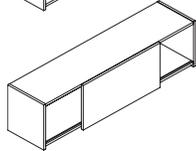

Overhead Storage — Laminate Sliding Door — 15 1/8"H x 15 1/8"D					
48"W with 1 Doors	WKOH154815-SDL	1	\$ 1999	\$ 48	\$ 23
60"W with 1 Doors	WKOH156015-SDL	1	\$ 2066	\$ 50	\$ 24
66"W with 1 Door	WKOH156615-SDL	1	\$ 2398	\$ 59	\$ 28
72"W with 1 Door	WKOH157215-SDL	1	\$ 2767	\$ 67	\$ 30
78"W with 1 Door	WKOH157815-SDL	1	\$ 3131	\$ 75	\$ 33

*Upcharges are added to L1 Laminate List Price depending on woodgrain laminate selection.

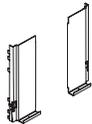

Description	Model	List Price P1
Overhead Mounting Kit for Beyond Wall		
For 30"W to 48"W	WKOHBW30AK	\$ 221
For 60"W to 78"W	WKOHBW60AK	\$ 335

*Compatible for use with overheads on Terrace and Stride panels, except 57.5"H panel due to flex point.

<p>How to specify — Select the Model Number from above.</p> <p>WKOH </p> <p>• •</p>	<p>1st Option: FSC Certified Wood (if applicable): F FSC Certified X No FSC</p>	<p>2nd Option: Chassis Laminate and Predefined Edge (if applicable):</p>	<p>3rd Option: Front Laminate and Predefined Edge (if applicable):</p>	<p>4th Option: Lock (if applicable): STD Standard OMT Omit Lock Core (Deduct \$20 per lock) LN No Lock HDL models only</p>	<p>5th Option: Paint (if applicable):</p>
--	--	---	---	---	--

Examples: WKOH153015-HDL.F.LM14EW.LSW1SW.STD WKOHBW30AK.P02

For specification information see pages 194-197.

GSA SIN 33721

Description	Model	Locks	List Price	
			L1	L2

28"H Credenzas

First, select Trough (F) or Troughless (T). If troughless, subtract \$100 from listed footed price.
Next, select Footed (Y) or Non-footed (N). If non-footed, subtract \$100 from listed footed price.

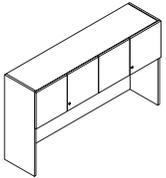

35"H Hutch

48"W Laminate Hinged Doors	WKOH3548-HDL	1	\$ 2303	\$ 2328
60"W Laminate Hinged Doors (shown)	WKOH3560-HDL	2	\$ 2578	\$ 2606
66"W Laminate Hinged Doors	WKOH3566-HDL	2	\$ 2622	\$ 2651
72"W Laminate Hinged Doors	WKOH3572-HDL	2	\$ 3087	\$ 3121

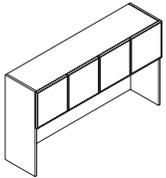

35"H Hutch

48"W Frosted Glass Hinged Doors	WKOH3548-HDG	—	\$ 2935	\$ 3042
60"W Frosted Glass Hinged Doors (shown)	WKOH3560-HDG	—	\$ 3296	\$ 3415
66"W Frosted Glass Hinged Doors	WKOH3566-HDG	—	\$ 3486	\$ 3611
72"W Frosted Glass Hinged Doors	WKOH3572-HDG	—	\$ 4107	\$ 4255

How to specify — Select the Model Number from above.	1st Option: FSC Certified Wood: F FSC Certified X No FSC	2nd Option: Chassis Laminate and Predefined Edge (if applicable):	3rd Option: Front Laminate and Predefined Edge:	4th Option: Lock (if applicable): STD Standard OMT Omit Lock Core (Deduct \$20) LN No Lock HDL models only
WK 	

Example: WKOH3560-HDG.X.LM14EW.LM14EW.STD

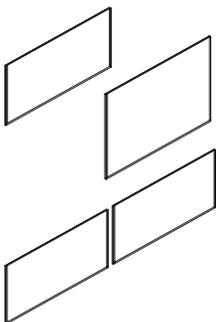

Description	Model	Grade A	Grade B	Grade C	Grade D	Grade E	Grade F	List Price			
								Grade A	Grade B	Grade C	Grade D
19"H Tackboards for Hutches (nested in a metal frame)											
48"W Nominal Width 44¾"W	WTKFT4H44-HA	\$ 390	\$ 419	\$ 447	\$ 476	\$ 513	\$ 551				
60"W Nominal Width 56¾"W	WTKFT4H56-HA	\$ 493	\$ 530	\$ 565	\$ 601	\$ 648	\$ 695				
66"W (2pc) Nominal Width 62¾"W	WTKFT4H62-HA	\$ 543	\$ 584	\$ 623	\$ 662	\$ 714	\$ 767				
72"W (2pc) Nominal Width 68¾"W	WTKFT4H68-HA	\$ 598	\$ 643	\$ 685	\$ 729	\$ 787	\$ 845				

How to specify — Select the Model Number from above.	1st Option: Tackboard Fabric (if applicable): See page 15 for fabrics.	2nd Option: Tackboard Frame Paint: P1 P2 P3 See page 173 for finishes. P2 paint upcharge \$33 (except PR6) P3 paint upcharge \$85
WK T K F T 4 H H A .	.	

Example: WTKFT4H56-HA.APN911.PR6

For specification information see pages 200-201.

GSA SIN 33721

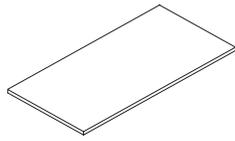

Description	Model	L1 Laminate List Price	UPCHARGES*	
			L1 Laminate	L2 Laminate
30"D Laminate Height-Adjustable Tops with Grommets — 29"D nominal				
66"W	WKAURS6630	\$ 925		\$ 186
72"W	WKAURS7230	\$ 989		\$ 187
Note: Actual top is undersized by 2" in width and 2" in depth to provide 1" clearance on each side of height-adjustable surface. Use listed dimension for space planning purposes.				
36"D Laminate Height-Adjustable Tops with Grommets — 35"D nominal				
72"W	WKAURS7236	\$ 1266		\$ 190
Note: Actual top is undersized by 2" in width and 2" in depth to provide 1" clearance on each side of height-adjustable surface. Use listed dimension for space planning purposes.				

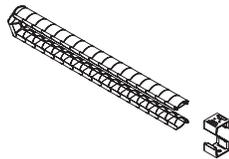
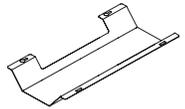
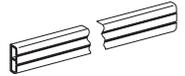
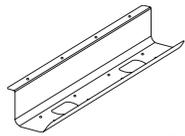

Description	Model	List Price
Cable Management Tray		
24" Tray	AJTRGH24 <input type="checkbox"/>	\$ 123
36" Tray	AJTRGH36 <input type="checkbox"/>	\$ 147
Note: Black only.		
Wire Management Channel (Black only)		
92" Long	AEV920 <input type="checkbox"/>	\$ 234
Under Worksurface Trough (Black Only)		
17"W — Single Pack	Z617UWTRGH	\$ 108
17"W — Ten Pack	Z61710UWTRGH	\$ 1085
36"W — Single Pack	Z636UWTRGH	\$ 189
36"W — Ten Pack	Z63610UWTRGH	\$ 1839
Cord Management Snake (Black Only)		
58"	WKSMMC	\$ 428

<p>How to specify — Select the Model Number from above.</p>	<p>1st Option: FSC Certified Wood (if applicable): F FSC Certified X No FSC</p>	<p>2nd Option: Paint Color (if applicable):</p>	<p>3rd Option: Top Laminate and Predefined Edge: See page 173 for finishes.</p>
WK . .			.

<p>4th Option: Grommet Location: See page 186. B Both Left and Right C Centered L Left R Right X No Grommet</p>	<p>5th Option: Grommet Type: P Oval Plastic M Oval Metal (Add \$13 per grommet) S Square Metal (Add \$13 per grommet)</p>	<p>Grommet Color: Metal is EL. Plastic grommet color is predetermined to match laminate.</p>

Examples: WKAURS6630.F.LM14EW.CMPR6
WKAURS7236.X.LM14EW.BP AJTRGH24.P AEV920
WKAURS7230.X.LM14EW.R.SEL

Shippable by small-package carrier.
allsteeloffice.com | 245

For specification information see pages 200-201.

Open Market/GSA SIN 33721

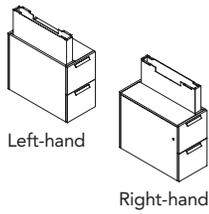

Description	Model	L1 Locks	L1 Laminate List Price	UPCHARGES*	
				L2 Laminate Chassis	Front
Height-Adjustable* Slim Pedestal & Shroud Kit — File / File					
14¼"W x 30"D Left-hand	WKPSFNJ2830LH-HS	1	\$ 3504	\$ 70	\$ 47
14¼"W x 30"D Right-hand	WKPSFNJ2830RH-HS	1	\$ 3504	\$ 70	\$ 47

Note: *27¼ – 47¾"H compatible. Requires 2-Stage T-Leg Powered Base purchased separately. See page 247.

*New models are compatible with A6 height adjustable bases

*Not compatible with fixed laminate or metal modesty due to width

Height-Adjustable Shroud Kits 27¼" – 47¾"H



Non-Handed

Description	Model	L1 Locks	L1 Laminate List Price	UPCHARGES*	
				L2 Laminate Chassis	Front
4¼"W x 30"D	WKEPFNJ2830-HS		\$ 1071	\$ 29	N/A

Note: *27¼ – 47¾"H compatible. Requires 2-Stage T-Leg Powered Base purchased separately. See page 247.

*New models are compatible with A6 height adjustable bases

<p>How to specify — Select the Model Number from above.</p> <p>_____</p> <p>_____ - _____ .</p>	<p>1st Option: FSC Certified Wood:</p> <p>F FSC Certified X No FSC</p> <p>_____ .</p>	<p>2nd Option: Chassis Laminate and Predefined Edge:</p> <p>See inside front cover for finishes.</p> <p>_____ .</p>	<p>3rd Option: Front Laminate and Predefined Edge:</p> <p>_____ .</p>
--	---	---	---

<p>4th Option: Pull Type (if applicable):</p> <p>MP Beam OP Halo AP Arch BP Bar SP Square See matrix on page 21.</p> <p>_____</p>	<p>5th Option: Pull Color (if applicable):</p> <p>MP Beam / OP Halo P2 upcharge +\$18/pull</p> <p>PJW Designer White PR6 Silver PJE Pyrite P8X Solar Black</p> <p>AP Arch PRO Anodized Silver P2 upcharge +\$18/pull</p> <p>_____ .</p>	<p>6th Option: Metal Sleeve Paint (if applicable):</p> <p>P1 P2 P3 See page 173 for finishes. P2 \$17/shroud P3 \$40/shroud</p> <p>_____ .</p>	<p>7th Option: Height Adjustable Base (if applicable):</p> <p>_____ .</p>	<p>8th Option: Height Adjustable Base Keypad (if applicable):</p> <p>UD Basic Up/Down MEM Memory Preset PDL Paddle</p> <p>_____ .</p>	<p>9th Option: Lock (if applicable):</p> <p>STD Standard OMT Omit Lock Core (Deduct \$20 per lock)</p> <p>_____ .</p>
---	---	--	---	---	---

Example: WKEPFNJ2830-HS.X.LM14EW.LSW1SW.MPPJE.OMT

5 Shippable by small-package carrier.

For specification information see pages 200-201.

GSA SIN 33721

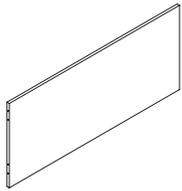

Description	Model	L1 Laminate List Price	UPCHARGES*	
			L2 Laminate Chassis	
Height Adjustable Table Layered Modesty				
Fixed Laminate Modesty Panel 24"H x 48"W for HAT	WKAUMPJ2848LL	\$ 602	\$ 23	
Fixed Laminate Modesty Panel 24"H x 54"W for HAT	WKAUMPJ2854LL	\$ 620	\$ 24	
Fixed Laminate Modesty Panel 24"H x 60"W for HAT	WKAUMPJ2860LL	\$ 638	\$ 25	
Fixed Laminate Modesty Panel 24"H x 66"W for HAT	WKAUMPJ2866LL	\$ 699	\$ 27	
Fixed Laminate Modesty Panel 24"H x 72"W for HAT	WKAUMPJ2872LL	\$ 718	\$ 28	

*For use between WKEPFNJ2830-HS with WKBKHATFM bracket

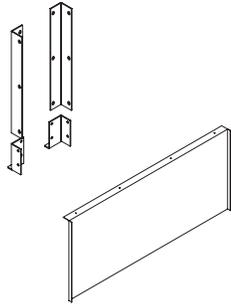

Description	Model	List Price	UPCHARGES*	
			P2	P3
Bracket for Fixed Laminate HAT Modesty				
Approach 24"H Fixed Modesty Bracket	WKBKHATFM	\$ 100	\$ 23	\$ 55
Metal HAT Modesty				
Metal Modesty Panel 28"H x 48"W for HAT	WKAUMP2848MM	\$ 416	N/A	
Metal Modesty Panel 28"H x 54"W for HAT	WKAUMP2854MM	\$ 433	N/A	
Metal Modesty Panel 28"H x 60"W for HAT	WKAUMP2860MM	\$ 453	N/A	
Metal Modesty Panel 28"H x 66"W for HAT	WKAUMP2866MM	\$ 469	N/A	
Metal Modesty Panel 28"H x 72"W for HAT	WKAUMP2872MM	\$ 487	N/A	

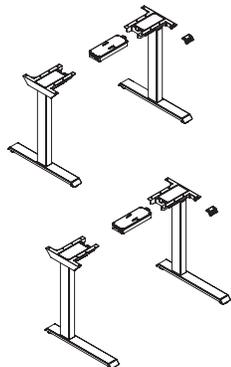

Description	Model			List Price
2-Stage A6 Table Base				
2 Stage, 2 Leg Rectangle T Foot	9.4	10.6	41.7	A6REC2S2LTF \$ 2151

*For 24"D-30"D Rectangular Worksurfaces 48"W-72"W and Approach 36"D worksurface with shrouds

2 Stage, 2 Leg Rectangle C Foot	9.4	10.6	41.7	A6REC2S2LCF \$ 2151
---------------------------------	-----	------	------	---------------------

*For 24"D-30"D Rectangular Worksurfaces 48"W-72"W and Approach 36"D worksurface with shrouds

A6 base standard travel only compatible with credenza for integrated HAT, see page 207.

APPROACH

How to specify — Select the Model Number from above.	1st Option: FSC Certified Wood (if applicable): F FSC Certified X No FSC	2nd Option: Laminate and Predefined Edge: See inside front cover for finishes.	3rd Option: Height Adjustable Base (if applicable): PR6 Silver PD8 White P71 Black	4th Option: HAT Base Feet (if applicable): X Standard Glides S Slide Glides (\$153 extra)	5th Option: Height Adjustable Base Keypad (if applicable): UD Basic Up/Down MEM Memory Preset PDL Paddle	6th Option: Bracket Paint (if applicable): P1 P2 P3 See page 173 for finishes.
_____ .	_____ .	_____ .	_____ .	X .	_____ .	_____ .

Examples: WKAUMPJ2866LL.X.LM14EW WKAUMP2866MM

WKAUJB2SA6.PR6.MEM

Shippable by small-package carrier.

- Finishes 250
- Involvement[®] Overview.....251-252
- Working with Involvement[®]253-272
- Pedestals, Credenzas, and Bookcases.....273-280
- Soft Seating.....281-286
- Storage Towers... ..287-291
- Stacking Storage..... 292
- Overheads, Shelves, Stanchions, Hutches, and Tackboards293-298
- Worksurfaces — 18"D / Primary / EZ View..... 299
- Worksurface Supports300-301
- Screens302-304



PAINTED METAL FINISHES

GRADE P1

Black	P27
Brownstone	P7D
Bungalow	P7C
Cinder	P7Q
Designer White	PJW
Flint	P02
Fossil	P28
Loft	P7B
Muslin	P4J
Parchment	P93
Pebble	P8R
Pewter	P8D
Salt	P8C
Titanium	P8T

GRADE P2

Champagne Metallic	PR5
Gunmetal Metallic	PR3
Platinum Metallic	PR2
Silver**	PR6
Solar Black	P8X

**PR6 no upcharge on Involve; available as a Grade P2 color on stanchions. PR6 & P8X are not available on Concensys, Essentials bookcase, and vertical files.

GRADE P3

Atom	P8S
Blossom**	P8K
Bullseye	PJF
Ember	P8P
Ion	P8N
Iris	P8J
Krypton	P8F
Ochre	P093
Regatta	P8M
Sienna	P092
Succulent**	P8A

Metallic paints, due to varying reflectance, may appear to have less visual color consistency than other paint finishes, even when L/A/B values are exactly the same. (L/A/B — measurable aspects of color — values are maintained within a specified range, to ensure consistent appearance of paint colors.)

***These colors are intended to be an inspirational option for the trending market. Product application is limited and color availability is approximately two years to coincide with evolving workplace trends.*

PAINTED WOOD FINISHES

Brownstone	M13
Bungalow	M12
Designer White	M17
Flint	M16
Loft	M11
Muslin	M15

ELECTRICAL AND DATA COMPONENTS

Black	E4
Brownstone	EY
Designer White	DW
Flint	E9
Loft	EV
Muslin	EU
Silver	ES

Recommended Coordinate Colors:
 Bungalow use Muslin EU
 Champagne Metallic use Muslin EU
 Cinder use Brownstone EY
 Fossil use Flint E9
 Gunmetal Metallic use Brownstone EY
 Parchment use Muslin EU
 Pebble use Loft EV
 Pewter use Flint E9
 Platinum Metallic use Silver ES
 Salt use Silver ES
 Titanium use Silver ES

LAMINATES

GRADE L1

SOLID COLORS		
Black	P
Brownstone	LM13
Bungalow	LM12
Designer White	LDW1
Flint	LM16
Fossil Shale	LEH1
Loft	LM11
Muslin	LM15
Titanium	LTI1

ABSTRACT		
Ash	LT3B
Handspun Pearl	LAHP
Handspun Dove	LAHD
Handspun Slate	LAHS
Handspun Chestnut	LAHC
Silver Mesh	LT8D

WOODGRAIN		
Belair	LWBA
Bourbon Cherry	H
Field Elm	LWFE
Florence Walnut	LFW1
Kingswood Walnut	LK11
Natural Maple	LWD
NeoWalnut	LNU1
Pinnacle	PINC
Shaker Cherry	LW7C

GRADE L2

Beigewood	LWBE
Fawn Cypress	LFC1
Lowell Ash	LLA1
Mangalore Mango	LMM1
Natural Recon	LNR1
Phantom Charcoal	LPC1
Phantom Ecru	LPE1
Portico Teak	LPT1
Skyline Walnut	LSW1
Veranda Teak	LVT1

GRADE L3

Natural Walnut	LWNW
----------------	-------	------

LAMINATE AND PAINTED WOOD STORAGE PULLS

Silver	PR6
--------	-------	-----

LAMINATE EDGE COLORS

Belair	BA
Beigewood	DE
Black	E4
Bourbon Cherry	H
Brownstone	EY
Bungalow	EX
Designer White	DW
Fawn Cypress	FC
Field Elm	FE
Flint	E9
Florence Walnut	FW
Fossil	EH
Kingswood Walnut	KI
Loft	EV
Lowell Ash	DL
Mangalore Mango	MM
Muslin	EU
Natural Maple	DD
Natural Recon	NR
Natural Walnut	DN
NeoWalnut	NU
Parchment	EN
Phantom Charcoal	PC
Phantom Ecru	PE
Pinnacle	PI
Platinum Metallic†	EP
Plyband ♦	PL
Portico Teak	DP
Shaker Cherry	DF
Skyline Walnut	SW
Titanium	TI
Veranda Teak	VT

† Not available on Aware table tops.

♦ Edge is limited to flat edge surfaces: rectangle, square, trapezoid, polygon, or round. No curvilinear or combination curve and straight.

METAL GROMMETS

FOR LAMINATE WORKSURFACES

Oval/Square:		
Matte Silver	EL

FOR VENEER WORKSURFACES

Oval:		
Black	E4
Bronze	EZ
Matte Silver	EL
Square:		
Matte Silver	EL

PLASTIC GROMMETS

FOR WORKSURFACES

Black	E4
Brownstone	EY
Bungalow	EX
Designer White	DW
Flint	E9
Fossil	EH
Loft	EV
Muslin	EU
Parchment	EN
Titanium	TI

PLASTIC GROMMETS WITH WOODGRAIN EDGE

If woodgrain edge is specified, the plastic grommet color is predetermined, based on finish selection.

Beigewood, Fawn Cypress, Natural Maple, and Natural Recon. Muslin EU
 Kingswood Walnut and NeoWalnut..... Brownstone EY
 Phantom Charcoal and Skyline Walnut Flint E9
 Phantom Ecru Loft EV
 Portico Teak Fossil EH
 All other woodgrain options Black E4

LOCKS

Black	E4
Chrome ordered by base model	
Matte Silver	EL

NOTE: Refer to individual product pages for upcharges.

Leg or Plinth Base models available. Leg base units are shown below.

Pedestals — 24"H and 28"H



Mobile
Box/File



Freestanding
Box/File



Freestanding
Open



Support
Box/Box/File



Support
File/File



Support
Open

Credenzas — 17½"H, left- and right-handed models available for handed units.



Single Lateral



Single Lateral
w/Open Cubby



Corner Table

Credenzas — 24"H, left- and right-handed models available for handed units.



Box/Lateral



Box/Box
Lateral

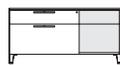

Box/Lateral
w/Open Cubby



Sliding Door
Open



Open

Credenzas — 28"H, left- and right-handed models available for handed units.



2-High
Lateral



Box/Box
Lateral



Box/Box
Project/Lateral



Sliding Door
Open w/Cubbies



Open

Credenzas and Bookcase — 42"H



3-High
Lateral

Bookcases — 65"H and 72½"H



Bookcase
w/Lateral



Bookcase



Bookcase
w/Lateral



Bookcase

Towers — 42"H (12"W only), 50"H and 57½"H (50"H shown); left- and right-handed models available.

12"W



Full-Width Door

18"W



Hinged Door
Box/Box/File

18"W



Side Access
File/File

24"W



Hinged Door
Box/Box/File

24"W



Side Access
File/File

Towers — 65"H and 72½"H (65"H shown); left- and right-handed models available.

12"W



Full-Width Door
(65"H)

18"W



Hinged Door
Box/Box/File

18"W



Hinged Door
File/File

18"W



Full-Width
Door

24"W



Hinged Door
Box/Box/File

24"W



Hinged Door
File/File

24"W



Full-Width Door

Leg or Plinth Base models available. Leg base units are shown below.

Stacking Storage — Hinged Door, left- and right-handed models available

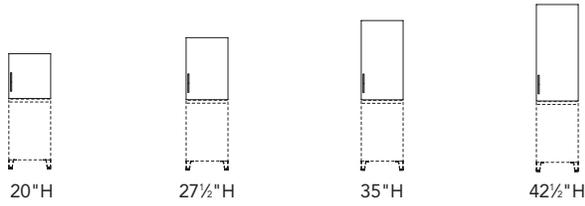

Stacking Storage — Open

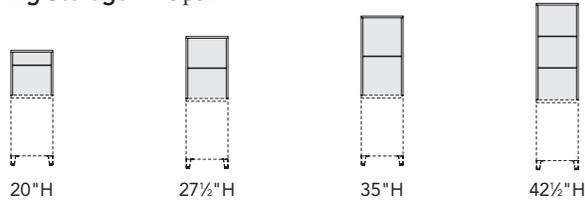

Overheads and Shelves



Hinged Door 15"H Hinged Door 22½"H Sliding Door Open Bin Dual Access Open Book Shelf Laminate Shelf

Soft Seating and Tables



Seat Base w/Drawers Seat Base w/Open Cubby Banquette Cushion Seat Base Cushion Table Top Bolster Corner Table Open Table

Worksurfaces — Shapes below added for Involve to the hundreds available in our existing Worksurface selection.

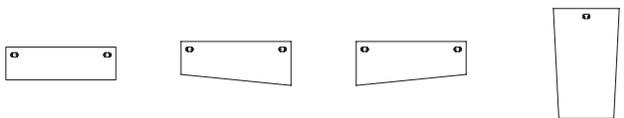

Primary 18"D Linear Taper 18"D / 24"D Linear Taper 24"D / 18"D EZ View Transition

Supports and Accessories



Open Metal End Supports Closed Laminate End Supports Post Leg Worksurface Stanchion Overhead Stanchion

Modesty Panels and Screens

Accessories



Modesty Panels Back Panels Privacy Panels Divider Panels Ped/Credenza Cushion Pullout Shelf Extra Metal Shelf Power Module

Where, how, and even what defines work is changing constantly. It's obvious that businesses are trying to understand what it means to successfully change with the culture and trends.

With Involve, we set out to discover how furniture can be used today as an impetus to an organizations change and yet perform well into the future as the organization continues to evolve.

Involve... one solution for all your needs.

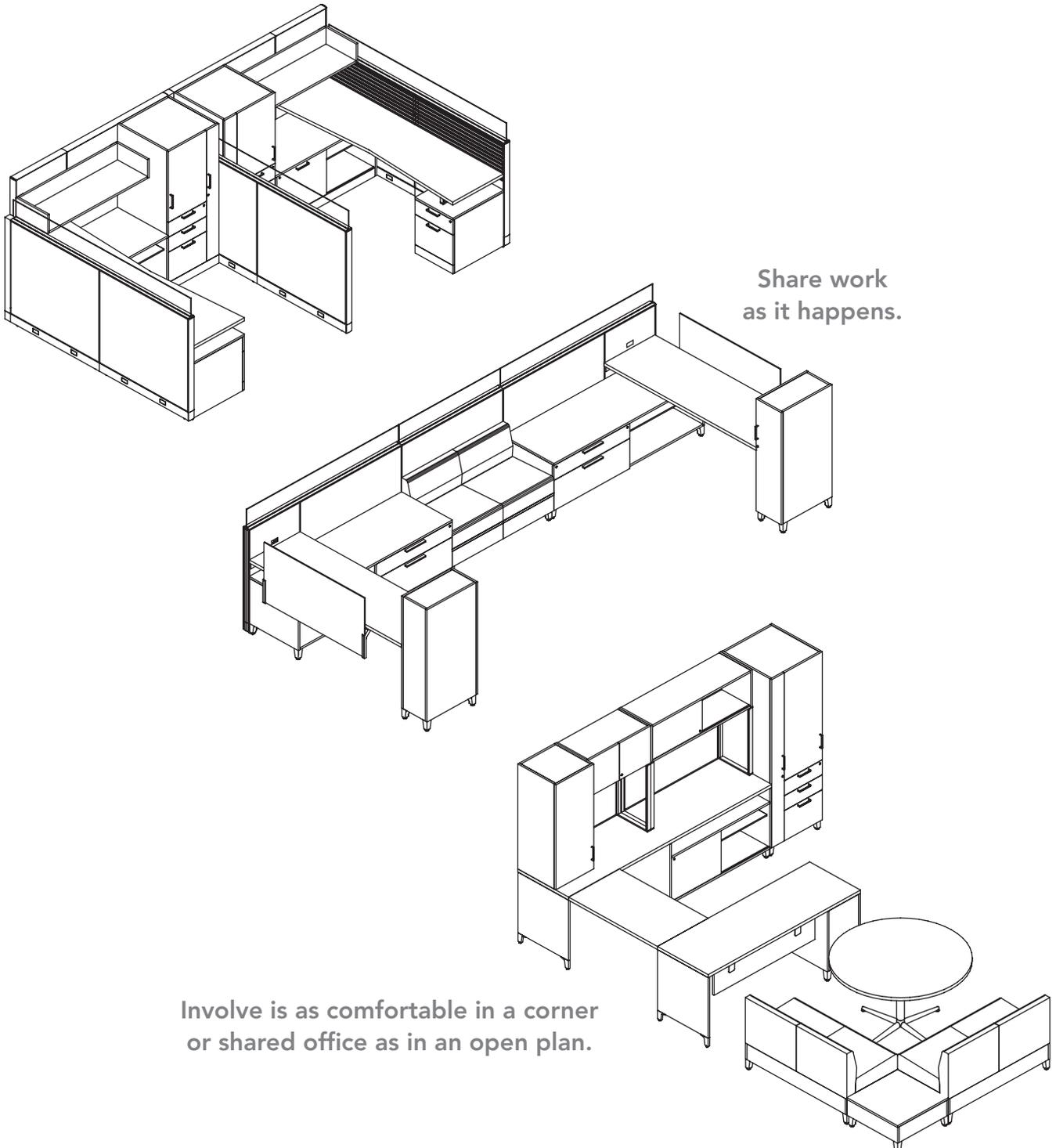

Share work
as it happens.

Involve is as comfortable in a corner
or shared office as in an open plan.

INVOLVE

A Fresh Approach

Furniture needs to work today with a fresh approach and innovative features. But support of tomorrow's needs is vitally important.

- Expand functionality of systems furniture, energize existing installs, and support changing work styles with Involve. Take existing investment and add functionality and relevance by changing out a few key pieces.
- The soft seating can be used within panel walls or pulled into freestanding or huddle room applications. The same casegoods work in private office or open plan configurations.
- Modularity of components allows for flexing of product application into the future. Involve lets you design for collaboration now while building in opportunity for future head count growth.

Changing Work Styles

From editing to brainstorming, number crunching to researching, today's work doesn't just happen in a task chair pulled up to a desk surface.

- Tired of the stodgy cubicle, users should be inspired by a fresh approach with innovative features that feel like furniture and less like a system.
- A task chair works for one job function and lounge seating works better for another. Involve supports the preferred posture for these activities while maintaining the desired home base for individuals.
- Untethered from the primary workstation, sharing of information can happen spontaneously around a screen or face to face. Involve components can be used across the floorplan offering the user multiple places to go as they work.

Get inspired by Involve.

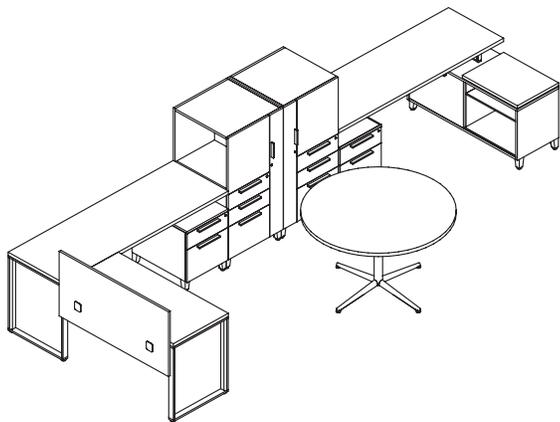

Involve's modular design accommodates all the different ways work gets done.

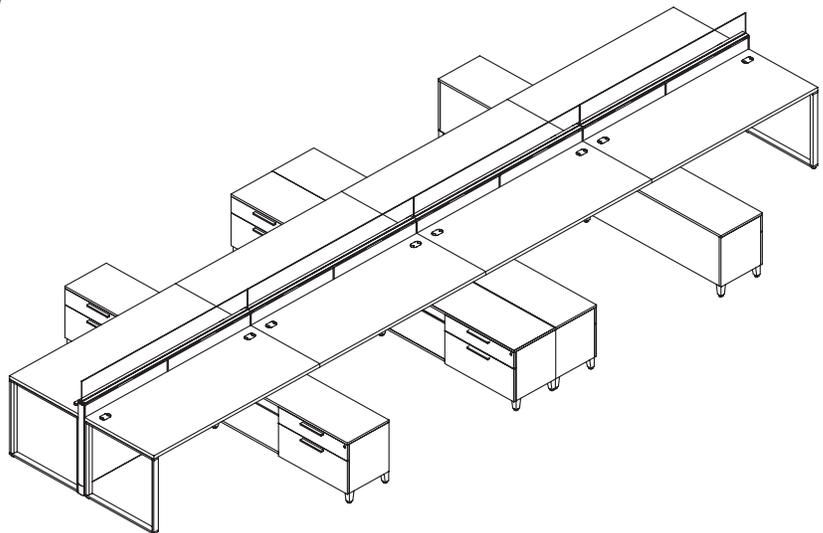

Involve moves out of dedicated user spaces to create comfortable, functional meeting areas.

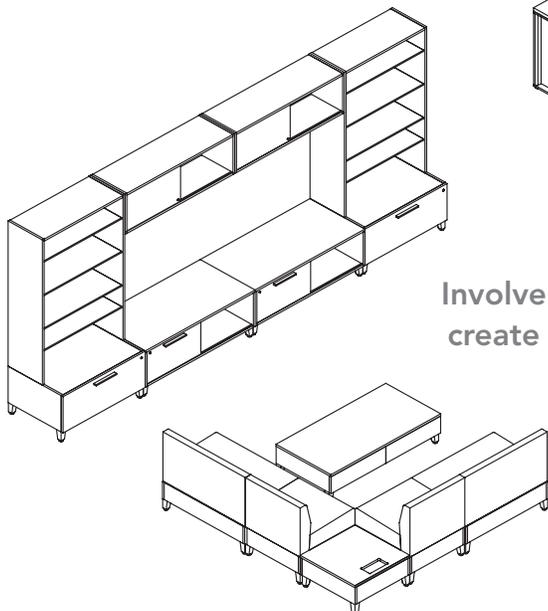

INVOLVE

Style		17½"H Credenza	24"H Credenza	28"H Credenza	42"H Credenza
Widths	Open	—	18", 24", 30", 36"	18", 24", 30", 36"	—
	Box/Lateral	—	30"	—	—
	Box/Box/Lateral	—	36"	24", 30"	—
	Box/Box/Project/Lateral	—	—	36"	—
	Lateral (1, 2, or 3 drawers)	30", 36"	—	30", 36"	36"
	Lateral/Open Cubby	48", 60", 72"	48", 60", 72"	—	—
	Combination	—	—	—	—
	Sliding Door w/shelf	—	36", 48"	36", 48"	—
	Closed (Table)	24"	—	—	—
	High Door/Low Open	—	—	—	—
Depths (some units 18"D or 24"D only)		18", 24"	18", 24"	18", 24"	18"
Pulls — Arch, Square Straight		Yes	Yes	Yes	Yes
Lock Options:					
	Lock	Standard	Standard	Standard	Standard
	Omit Core	Optional	Optional	Optional	Optional
	Master Keyed Lock	Standard	Standard	Standard	Standard
	Removable Lock Core	Yes — with special key	Yes — with special key	Yes — with special key	Yes — with special key
	Dual-Sided Locking	—	Yes	Yes	—
Suspension		Ball Bearing	Ball Bearing	Ball Bearing	Ball Bearing
Drawer Front Construction		¼" thick Laminate	¼" thick Laminate	¼" thick Laminate	¼" thick Laminate
Hinged Door Construction		¼" thick Laminate	¼" thick Laminate	¼" thick Laminate	¼" thick Laminate
Hex-head Glide		Yes	Yes	Yes	Yes
Counterweights		Required on freestanding applications	Required on freestanding applications	Required on most freestanding applications	Not required
Drawer Interiors:					
	Box Drawer	—	2¼"H	2¼"H	—
	Project Drawer	2⅝"H	—	2⅝"H	—
	Lateral Drawer	9"H	9"H	9"H	9"H
Front-to-Back Filing		Standard	Standard	Standard	Standard
Filing Options		Letter, Legal	Letter, Legal	Letter, Legal	Letter, Legal

Style		Pedestal	Towers	Bookcases	Stacking
Heights		24", 28"	50", 57½", 65", 72½"	65", 72½"	20", 27½", 35", 42½"
Widths	Open	18"	—	30", 36"	—
	Box/File	15½", 18"	—	—	—
	Box/Box/File	15½", 18"	18", 24"	—	—
	File/File	28"	18", 24"	—	—
	Shelves	—	—	30", 36"	18", 24"
	Shelves and Lateral (1 drawer)	—	—	30", 36"	—
Depths (some units 18"D or 24"D only)		18", 24"	18", 24"	15", 24"	18"
Pulls — Arch, Square, Straight		Yes	Yes	Yes	Yes
Lock Options:					
	Lock	Standard	Standard	Standard	No
	Omit Core	Optional	Optional	Optional	No
	Master Keyed Lock	Standard	Standard	Standard	No
	Removable Lock Core	Yes — with special key	Yes — with special key	Yes — with special key	No
Suspension		Ball Bearing	Ball Bearing	Ball Bearing	—
Drawer Front Construction		¼" thick Laminate	¼" thick Laminate	¼" thick Laminate	¼" thick Laminate
Hinged Door Construction		¼" thick Laminate	¼" thick Laminate	¼" thick Laminate	¼" thick Laminate
Hex-head Glide		Yes	Yes	Yes	—
Counterweights		Required on freestanding applications	Not required	Not required	Not required
Drawer Interiors:					
	Box Drawer	—	2¼"H	2¼"H	—
	File Drawer	9"H	9"H	9"H	—
Front-to-Back Filing		Standard	Standard	Standard	—
Filing Options		Letter	Letter	Letter, Legal	—

Interior Dimensions for Credenzas, Pedestals, Towers, Bookcases, Stacking Storage, and Seat Bases

[GSA Reference Page](#)

Description	Height	Depth — 18"D, 24"D	Width
CREDENZAS Open	24"H — 17 ³ / ₈ "	24"H — 17 ³ / ₈ ", 23 ³ / ₈ "	18" exterior = 16 ³ / ₈ " interior
	28"H — 22 ³ / ₈ "	28"H — 17 ³ / ₈ ", 23 ³ / ₈ "	24" exterior = 22 ³ / ₈ " interior 30" exterior = 28 ³ / ₈ " interior 36" exterior = 34 ³ / ₈ " interior 48" exterior = 46 ³ / ₈ " interior
Single Lateral	Lateral — 9"	30"W Lateral — 14", 17 ¹ / ₂ " 36"W Lateral — 12", 17 ¹ / ₂ "	30" exterior = 26 ³ / ₈ " interior 36" exterior = 32 ³ / ₈ " interior
Single Lateral w/Open Side	Lateral — 9"	24"W Lateral — 12", 17 ¹ / ₂ "	48" exterior = 43 ³ / ₈ " interior
	Open Side — 12"	30"W Lateral — 14", 17 ¹ / ₂ "	60" exterior = 55 ³ / ₈ " interior
		36"W Lateral — 12", 17 ¹ / ₂ " Open Side — 16 ³ / ₈ ", 22 ³ / ₈ "	72" exterior = 67 ³ / ₈ " interior
Sliding Door	24"H — 17 ³ / ₈ "	16", 22"	36" exterior = (2) 16 ³ / ₄ " interior 48" exterior = (2) 22 ³ / ₄ " interior
Box/Box/Lateral	Box — 2 ¹ / ₄ "	Box — 15"	36" exterior = 32 ³ / ₈ " interior
	Project — 2 ³ / ₈ "	Project — 15"	
	Lateral — 9"	Lateral — 12", 17 ¹ / ₂ "	
Box/Lateral w/Open Side	Box — 2 ³ / ₈ "	Box — 15"	48" exterior = 43 ³ / ₈ " interior
	Lateral — 9"	24"W Lateral — 12", 17 ¹ / ₂ "	60" exterior = 55 ³ / ₈ " interior
	Open Side — 17 ³ / ₈ "	30"W Lateral — 14", 17 ¹ / ₂ "	72" exterior = 67 ³ / ₈ " interior
		36"W Lateral — 12", 17 ¹ / ₂ " Open Side — 16 ³ / ₈ ", 22 ³ / ₈ "	
File/File	(2) File — 9"	30"W Lateral — 14", 17 ¹ / ₂ "	30" exterior = 26 ³ / ₈ " interior
		36"W Lateral — 12", 17 ¹ / ₂ "	36" exterior = 32 ³ / ₈ " interior
Box/Box/File Support and Box/Box/Project/Lateral Support	Box — 2 ¹ / ₄ "	Box — 15"	24" exterior = 20 ³ / ₈ " interior
	Project — 2 ³ / ₈ "	Project — 15"	30" exterior = 26 ³ / ₈ " interior
	File — 9"	24"W Lateral — 12", 17 ¹ / ₂ "	36" exterior = 32 ³ / ₈ " interior
		30"W Lateral — 14", 17 ¹ / ₂ " 36"W Lateral — 12", 17 ¹ / ₂ "	
Combination	Cabinet — 12"	Cabinet — 16 ³ / ₈ ", 22 ³ / ₈ "	48" exterior = 45 ³ / ₈ " interior
	Project — 2 ³ / ₈ "	Project — 15"	
	Open Side — 4 ³ / ₈ "	Open Side — 16 ³ / ₈ ", 22 ³ / ₈ "	
Open Bookcase	29 ¹ / ₂ "	17 ¹ / ₈ "	48" exterior = (2) 22 ³ / ₄ " interior
Open w/Sliding Door and Shelves	29 ¹ / ₂ "	16"	48" exterior = (2) 22 ³ / ₄ " interior
Lateral (42 high)	(3) File — 9"	15"	36" exterior = 32 ³ / ₈ " interior
PEDESTALS Mobile and Support	Box — 2 ¹ / ₄ "	Mobile — 15"	Mobile — 12 ¹ / ₈ "
	File — 9 ¹ / ₈ "	Support — 15", 19"	Support — 12 ¹ / ₈ " and 14 ³ / ₈ "
TOWERS Hinged Door and Side Access	Box — 2 ¹ / ₄ " File — 9 ¹ / ₈ "	15", 19"	14 ³ / ₈ "
BOOKCASES Open Bookcase	65"H — 58 ¹ / ₂ "	14 ¹ / ₈ "	30" exterior = 28 ³ / ₈ " interior
	72"H — 66"		36" exterior = 34 ³ / ₈ " interior
	Bookcase with Lateral	65" BC — 45 ³ / ₄ "	Bookcase — 14 ¹ / ₈ "
72" BC — 53 ³ / ₄ "		Lateral — 17 ¹ / ₂ "	36" exterior = 34 ³ / ₈ " interior
Lateral — 9"			
STACKING Hinged Door or Open	20"H-18 ¹ / ₄ "H 35"H-33 ¹ / ₄ "H	16 ³ / ₈ "	18" exterior = 16 ³ / ₈ " interior
	(Actual exterior ht. 1/4" less than nominal) 27 ¹ / ₂ "H-25 ³ / ₄ "H 42 ¹ / ₂ "H-40 ¹ / ₄ "H		24" exterior = 22 ³ / ₈ " interior
SEAT BASES Open	4 ¹ / ₄ "	17 ¹ / ₈ "	24" exterior = 22 ³ / ₈ " interior
			36" exterior = 34 ³ / ₈ " interior
			48" exterior = 46 ³ / ₈ " interior
Drawer	2 ³ / ₈ "	15"	24" exterior = 20 ³ / ₈ " interior
			36" exterior = 32 ³ / ₈ " interior
			48" exterior = (2) 20 ³ / ₈ " interior

Involve® Laminate Wood Storage

Features and Dimensions

Load Capacity for Laminate Wood Credenzas, Pedestals, Bookcases, Stacking Storage, Towers, and Overheads [GSA Reference Page](#)

Product Description	Style	Depth	15½"W	18"W	24"W	30"W	36"W	48"W	60"W	72"W	
11"H CREDENZAS	Open Table	18"D					57lbs.	77 lbs.			
		24"D					76 lbs.	103 lbs.			
17½"H CREDENZAS	Lateral	18"D			48 lbs.	62 lbs.	76 lbs.				
		24"D			56 lbs.	73 lbs.	89 lbs.				
	Lateral/Open Cubby	18"D							125 lbs.	159 lbs.	193 lbs.
		24"D							161 lbs.	205 lbs.	248 lbs.
24"H CREDENZAS	Box	18"D			14 lbs.	19 lbs.	23 lbs.				
		24"D			18 lbs.	23 lbs.	29 lbs.				
	Lateral	18"D			48 lbs.	62 lbs.	76 lbs.				
		24"D			56 lbs.	73 lbs.	89 lbs.				
	Box/Lateral/Open	18"D							170 lbs.	217 lbs.	263 lbs.
		24"D							222 lbs.	282 lbs.	342 lbs.
	Open	18"D		81 lbs.	111 lbs.	141 lbs.	170 lbs.				
		24"D		109 lbs.	150 lbs.	190 lbs.	230 lbs.				
	Sliding Door w/shelf	18"D						157 lbs.	213 lbs.		
		24"D						216 lbs.	293 lbs.		
28"H CREDENZAS	Box	18"D			14 lbs.	19 lbs.					
		24"D			18 lbs.	23 lbs.					
	Project Drawer	18"D						23 lbs.			
		24"D						29 lbs.			
	Lateral	18"D				62 lbs.	76 lbs.				
		24"D				73 lbs.	89 lbs.				
	Open Cubby w/shelf	18"D		104 lbs.	142 lbs.	180 lbs.	218 lbs.				
		24"D		140 lbs.	192 lbs.	243 lbs.	294 lbs.				
Sliding Door w/shelf	18"D						210 lbs.	285 lbs.			
	24"D						287 lbs.	389 lbs.			
42"H CREDENZAS	Lateral	18"D				76 lbs.					
24"H PEDESTALS	Box Mobile	18"D	9 lbs.								
	File Mobile	18"D	29 lbs.								
	Box Freestanding	18"D		10 lbs.							
		24"D		13 lbs.							
	File Freestanding	18"D		35 lbs.							
		24"D		44 lbs.							
28"H PEDESTALS	Box Support	18"D	9 lbs.	10 lbs.							
		24"D	11 lbs.	13 lbs.							
	File Support	18"D	29 lbs.	35 lbs.							
		24"D	37 lbs.	44 lbs.							
BOOKCASES	65"H with/Lateral (15"D upper)	24"D				367 lbs.	445 lbs.				
	72½"H with/Lateral (15"D upper)	24"D				413 lbs.	501 lbs.				
	65"H Open (all shelves)	15"D				377 lbs.	456 lbs.				
	72½"H Open (all shelves)	15"D				426 lbs.	516 lbs.				
STACKING STORAGE	with/Doors (All units are non-locking.)	18"D									
TOWERS	Box Drawer	18"D		10 lbs.	14 lbs.						
		24"D		13 lbs.	18 lbs.						
	File Drawer	18"D		35 lbs.	48 lbs.						
		24"D		44 lbs.	56 lbs.						
	50"H Wardrobe Section	18"D			63 lbs.						
		24"D			86 lbs.						
	57½"H Wardrobe Section	18"D			74 lbs.						
		24"D			101 lbs.						
	65"H Wardrobe Section	24"D			116 lbs.						
	72½"H Wardrobe Section	24"D			131 lbs.						
	65"H Full Width Wardrobe	24"D		360 lbs.	492 lbs.						
	72½" Full Width Wardrobe	24"D		407 lbs.	556 lbs.						

Load Capacity by Unit (continued)

GSA Reference Page

Product Description	Style	Depth	15½"W	18"W	24"W	30"W	36"W	48"W	60"W	72"W
SEAT BASES	Drawers	24"D			13 lbs.		22 lbs.	27 lbs.		
	Open	24"D			31 lbs.		48 lbs.	64 lbs.		
OVERHEADS	7½"H Open Bin			30 lbs.	38 lbs.	46 lbs.	55 lbs.	63 lbs.		
	7½"H Book Shelf			36 lbs.	46 lbs.	56 lbs.	65 lbs.	75 lbs.		
	15"H Slider Bin			61 lbs.	78 lbs.	95 lbs.	112 lbs.	129 lbs.	163 lbs.	
	15"H Binder Box w/shelf			70 lbs.	88 lbs.	107 lbs.	123 lbs.	142 lbs.	180 lbs.	
	15"H Hinged Door			64 lbs.	81 lbs.	104 lbs.	113 lbs.	130 lbs.	165 lbs.	
	15"H Dual Access w/Slider Door									
	15"H Dual Access Open					129 lbs.		175 lbs.	221 lbs.	
	22½"H Hinged Door			99 lbs.	126 lbs.	153 lbs.	176 lbs.	203 lbs.	257 lbs.	

Quantity of Locks for Laminate Wood Credenzas, Pedestals, Bookcases, Stacking Storage, Towers, and Overheads

Note: Open units and shelves are non-locking and are therefore not included in the list below.

	Style	15½"W	18"W	24"W	30"W	36"W	42"W	48"W	60"W	72"W
17½"H CREDENZAS	Lateral (1 drawer)				1 lock	1 lock				
	Lateral/Open Cubby							1 lock	1 lock	1 lock
24"H CREDENZAS	Box/Lateral				1 lock					
	Box/Box/Lateral					2 locks				
	Box/Lateral/Open							1 lock	1 lock	1 lock
	Sliding Door w/shelf					1 lock		1 lock		
28"H CREDENZAS	Box/Box/Lateral			1 lock						
	Box/Box/Project/Lateral					2 locks				
	Lateral (2 drawer)				1 lock	1 lock				
	Sliding Door w/shelf					1 lock		1 lock		
42"H CREDENZAS	Lateral (3 drawer)							1 lock		
24"H PEDESTALS	Box/File	1 lock	1 lock							
28"H PEDESTALS	Box/Box/File	1 lock	1 lock							
	File/File	1 lock	1 lock							
BOOKCASES	with/Lateral				1 lock	1 lock				
STACKING STORAGE	with/Doors (All units are non-locking.)									
TOWERS	Wardrobe/Hinged Door/Box/Box/File			2 locks						
	Wardrobe/Hinged Door/File/File			2 locks						
	Wardrobe/Side Access/File/File			2 locks						
	Wardrobe/Side Access/Box/Box/File			2 locks						
	Wardrobe			1 lock						
	Hinged Door/Box/Box/File		1 lock							
	Hinged Door/File/File		1 lock							
	Side Access/File/File		1 lock							
OVERHEADS	Hinged Doors			1 lock	1 lock	1 lock	1 lock	2 locks	2 locks	
	Sliding Door			1 lock	1 lock	1 lock	1 lock	1 lock	1 lock	
	Dual Access w/Sliding Doors								2 locks	2 locks

Top View of Drawers

15"W Pedestal
and Tower Drawers

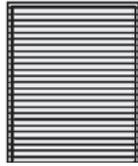

Letter Front-to-Back
18"D Mobile – 14½" of filing
24"D Support – 19" of filing

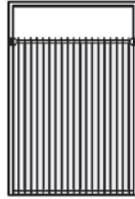

Legal Side-to-Side
24"D Support – 12" of filing

18"W Pedestal
and Tower Drawers

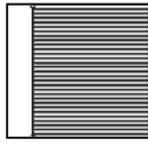

Letter Front-to-Back
18"D – 14½" of filing
24"D or 30"D – 19" of filing

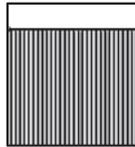

Side-to-Side
18"D – 14½" of Letter filing
24"D or 30"D – 14½" of Letter or Legal filing

24"W Credenza
Lateral Drawers

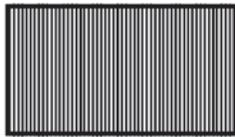

Letter Side-to-Side
18"D – 20½" of filing



Letter Front-to-Back
18"D – 15" of filing
24"D – 17½" of filing

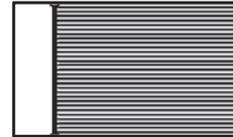

Legal Front-to-Back
18"D – 15" of filing
24"D – 17½" of filing

30"W Credenza
Lateral Drawers



Letter Front-to-Back
18"D – 30" of filing
24"D – 35" of filing



Legal Front-to-Back
18"D – 15" of filing
24"D – 17½" of filing

36"W Credenza
Lateral Drawers



Letter Front-to-Back
18"D – 30" of filing
24"D – 35" of filing

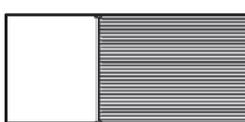

Legal Front-to-Back
18"D – 15" of filing
24"D – 17½" of filing

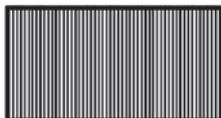

Letter Side-to-Side
18"D and 24"D – 32½" of filing

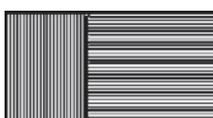

Letter Side-to-Side and Legal Front-to-Back
18"D – 17" of Letter S-T-S filing and 15" of Legal F-T-B filing
24"D – 17½" of Letter or Legal F-T-B filing

Credenzas and pedestals ship fully assembled except for tops on 28"H and 42"H units are ordered separately to allow one surface to span multiple credenzas and pedestals. Tops are available in laminate with flat edge detail.

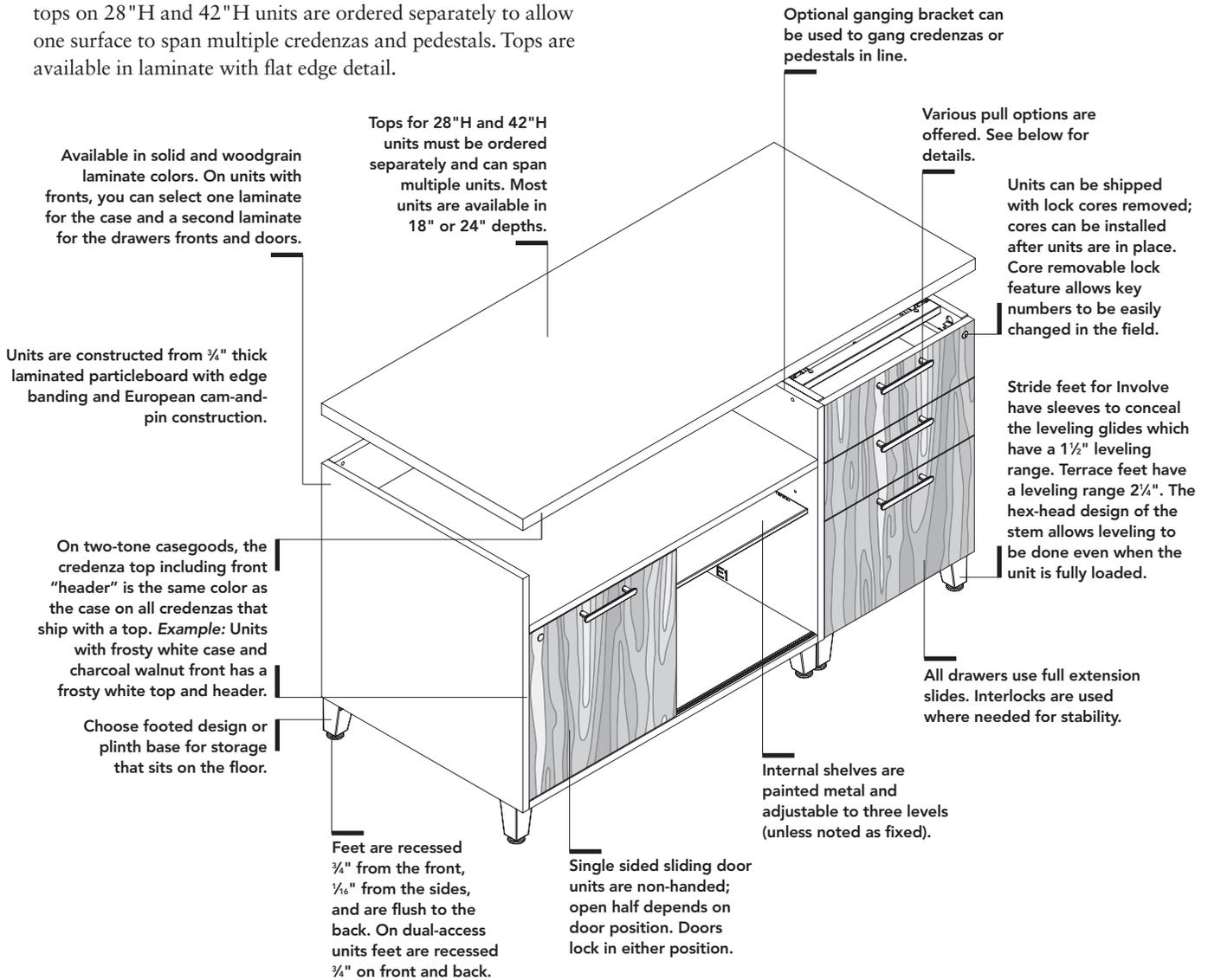

INVOLVE

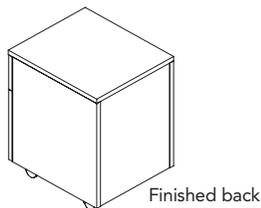

Open and partially open units come assembled with a finished laminate back.

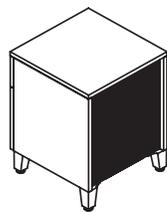

Units with drawers or doors come with an unfinished back that is recessed. A laminate back is available for units up to 28"H (ordered separately) for use when the back of the unit will be exposed.

Available pull styles:

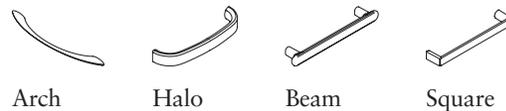

Storage that sits on the floor is available with plinth base or feet. Footed design provides increased air flow. **Two feet options** are available to integrate with Terrace or Stride Systems. Units ship assembled except for feet and pulls.

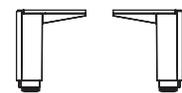
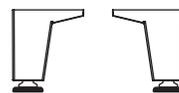

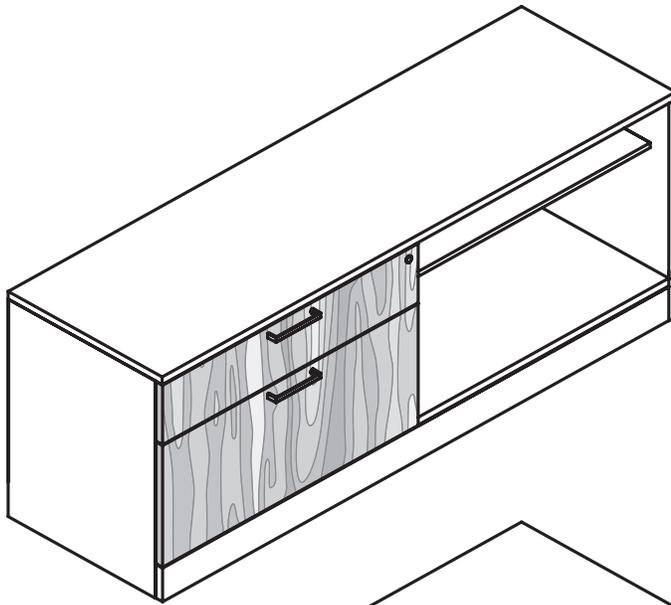

Two Tone Combo Credenzas

- Chassis, top, and plinth base will match. See illustration at left.
- Door/drawer fronts will match.

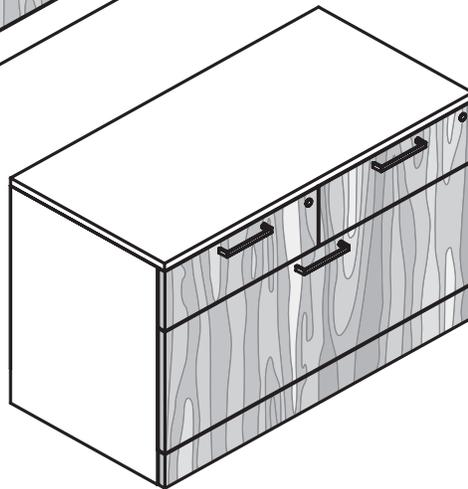

Two Tone Credenza (non-combo unit)

- Chassis and top will match. See illustration at left.
- Drawer fronts and plinth base will match.
- For best aesthetics avoid placing aside of a two-tone combo unit.

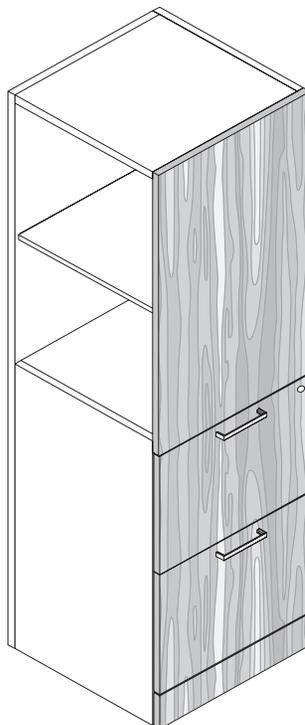

Two Tone Tower and Wardrobe Plinth

- Units have matched front and kickplate as shown here.

Note: Plinth base follows front laminate on non-combo units, and chassis & top on combo units. For best aesthetics avoid placing a two-tone combo along side of a two-tone non-combo unit.

A seat cushion can be placed on the credenza or pedestal top for additional seating. **Soft seating units** are also available for use within the private office, open plan, reception areas, and beyond. Seat bases are ordered separately from seat base cushions and table tops. Seat bases can be used as tables when ordered with a side table top.

Seat Bases are ordered separately in widths of 24", 36", and 48". Seat Bases are 11"H x 24"D and are available with plinth base, Terrace® feet, or Stride® feet. Seat cushion(s) and/or table top(s) are ordered separately to complete the unit.

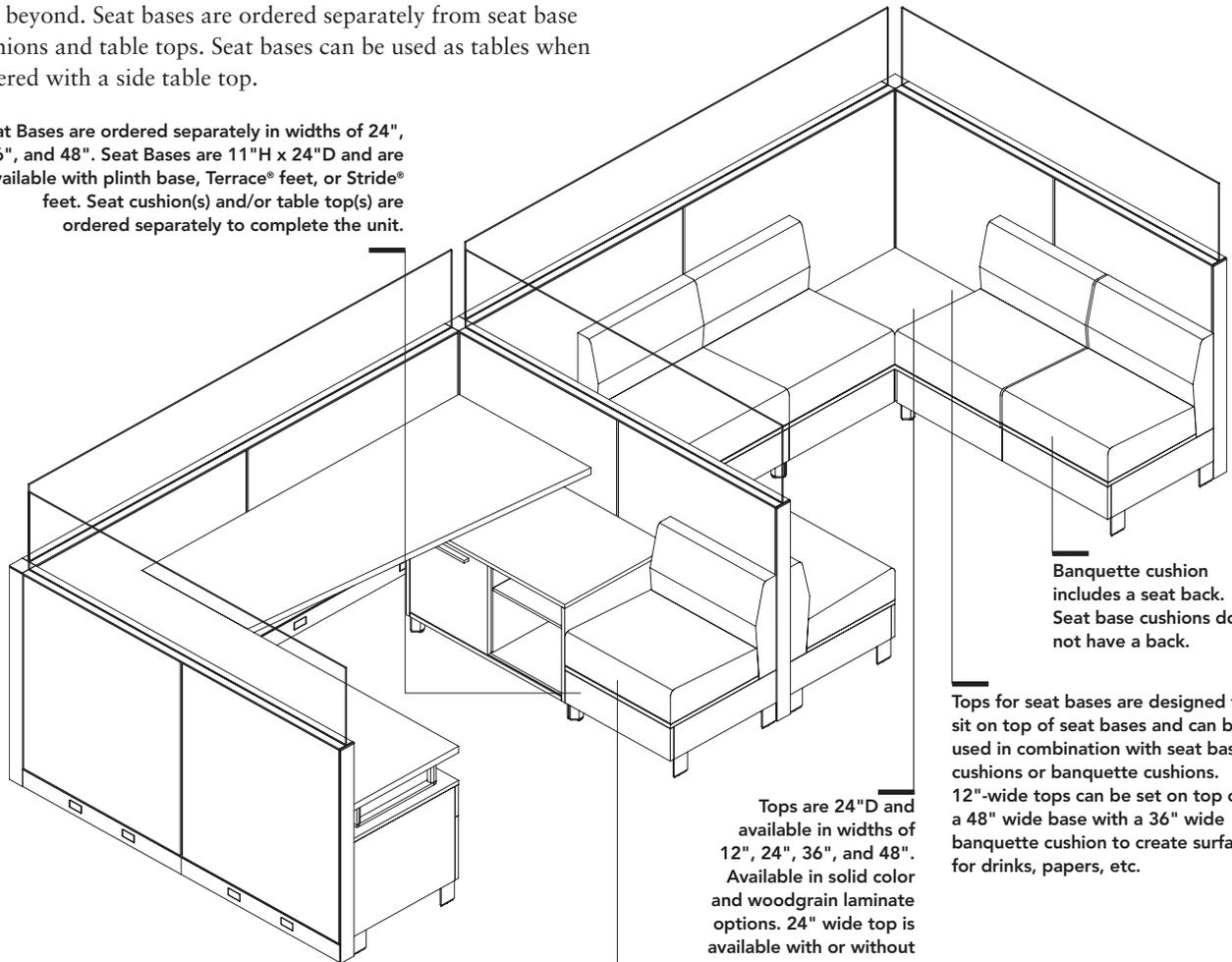

Seat cushions are designed to attach to the top of the seat bases. Offering includes: 24"W or 36"W banquette cushions or 24"W seat base cushions.

Tops are 24"D and available in widths of 12", 24", 36", and 48". Available in solid color and woodgrain laminate options. 24" wide top is available with or without power cutout. A power module is ordered separately.

Tops for seat bases are designed to sit on top of seat bases and can be used in combination with seat base cushions or banquette cushions. 12"-wide tops can be set on top of a 48" wide base with a 36" wide banquette cushion to create surface for drinks, papers, etc.

Seat base offering includes: with drawer or open. 48"W seat base with drawer has two drawers; design allows access to outbound drawers in corner applications. See illustration below showing four 48"W seat bases with 24"W cushions and tops in a U-shape configuration.

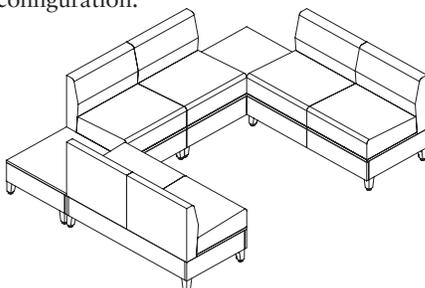

Seat bases are available in solid or woodgrain laminate options. Seat base with drawer can have a different laminate color on the drawer front than the case.

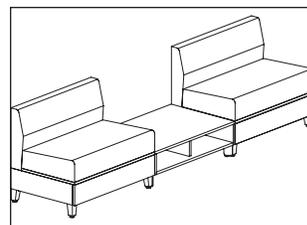

Corner table is used in a soft seating application. Corner table is 17½" high, 24" wide, and 24" deep. Illustration below is shown using plinth base units.

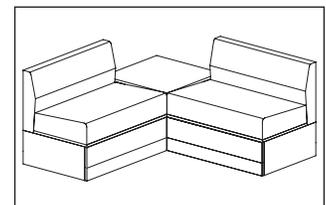

Open table is 11" high and is open at the front and back. Available in widths of 36" or 48" and depths of 18" and 24". Tables can be used to support electronics with back open for cord passage or can be used as a coffee table. 48" wide unit has a septum in the middle of the unit.

Aesthetic Alignment

Tower heights align with Stride® and Terrace® panel segmentation.

Construction and Options

See page 260 for Involve storage construction details; and base, pull, and finish options.

Shelves

Internal shelves are painted metal and adjustable to three levels.

Filing

File drawers can accommodate front-to-back letter filing.

Wardrobe Door

All 24"W towers have full-height wardrobe doors with a coat hook.

Core Removable Locks

Towers can be shipped with lock cores removed; cores can then be installed after towers are placed. Core removable lock feature allows key numbers to be easily changed in the field. It also facilitates installation.

Quantity of Lock Cores

Wardrobes with shelves, 18"W towers, and 12"W towers have one lock to secure door. All other towers have two locks — one secures the wardrobe door and the other secures all drawers.

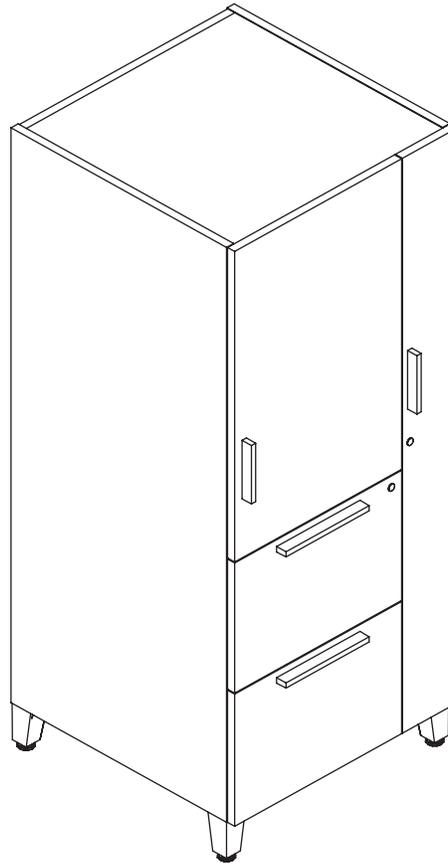

Configurations

Towers are available in five heights: 42½", 50", 57½", 65" and 72½"H. Drawer configurations include box/box/file and file/file with portion above drawers being a hinged door; 50"H and 57½"H units offer a side access option in place of front facing hinged door. All 24"W units with drawers have a full-height 6"W wardrobe; 18"W units do not. Full wardrobes with 2 adjustable shelves and a coat hook are available in 65"H and 72½"H. 12"W units include 2 coat hooks and must be panel mounted or attached to a credenza or worksurface. Left- and right-handed units available for all configurations. Units ship assembled except for feet and pulls.

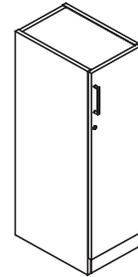

Worksurface Support

Tower can accommodate addition of an "L" tower bracket or tower rail.

An "L" tower bracket can be ordered separately and fitted to any tower to support worksurfaces at 29½"H.

A tower rail can be ordered separately and fitted to any tower to support worksurfaces at a height range of 27½"H to 30½"H.

See page 291 for visuals of a "L" tower bracket and a tower rail.

Number of Adjustable Shelves in Tower

Unit Height	Sides Access	Front Access	12" Wide
42½"H	N/A	N/A	1
50"H	1	0*	2
57½"H	1	1	2
65"H	N/A	2	2
72½"H	N/A	2	N/A

*Shelf can be ordered separately on page 283.

Stacking storage ships fully assembled. Units are designed to be placed on top of a worksurface or credenza and are attached with double-sided tape. Units line up on-module with Stride® and Terrace® elevations when mounted atop everything except a 24" high credenza. Units are available with hinged doors and open configurations.

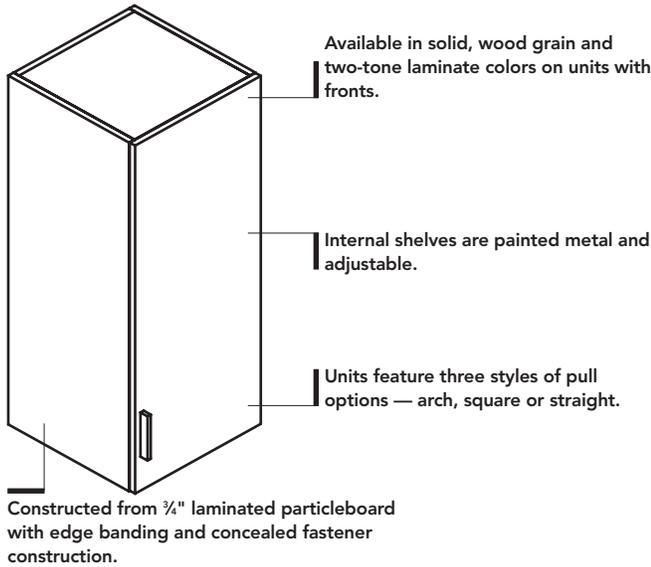

Overhead storage components maximize the use of space in the workstation and provide convenient access to binders, reference materials, software packages, and miscellaneous supplies. Overhead cabinets are available with sliding doors, hinged doors, open, and dual access with sliding door or open. Laminate selection includes solid color, woodgrain, or two-tone (case/doors).

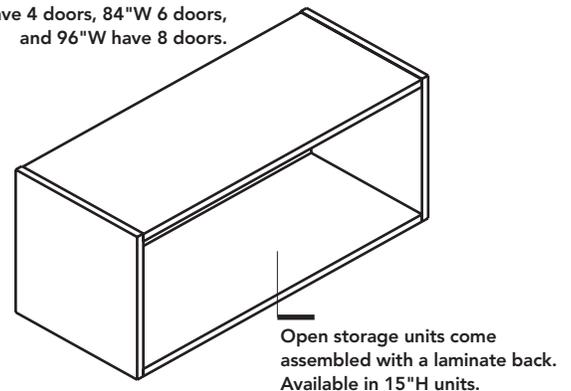
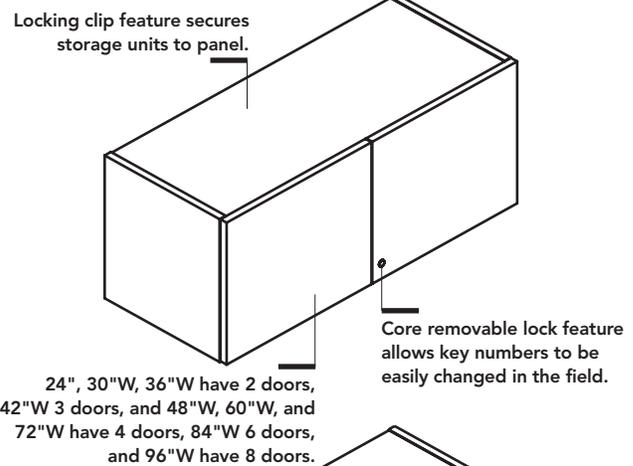
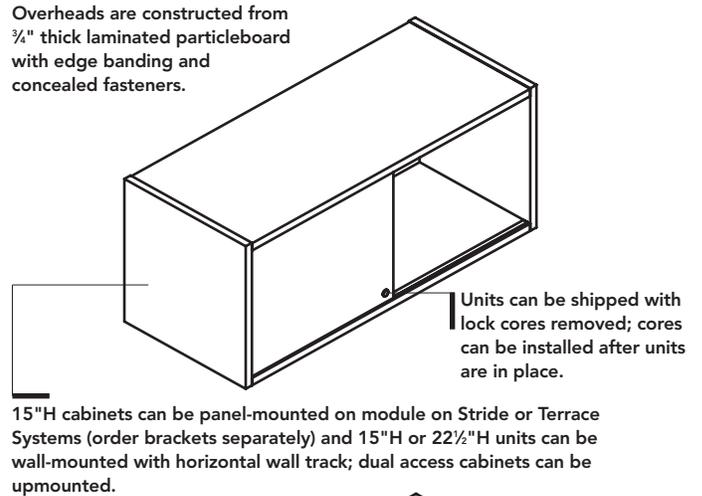

Product Dimensions

Stacking Storage

Width 18", 24"
 Inside Width 16 3/8", 22 3/8"
 Depth 18"
 Inside Depth 16 3/8"
 Actual Height 19 1/4", 27 1/4",
 34 3/4", 42 1/4"
 Inside Height 18 1/4", 27 1/2",
 33 3/4", 40 3/4"

Open Box

Width 24", 30", 36", 42", 48",
 60"
 Inside Width 1 3/4" less than
 width
 Depth 15"
 Inside Depth 13 3/8"
 Height 15"
 Inside Height 13 3/8"

Overhead Storage Cabinet w/Doors

Width 24", 30", 36", 42", 48",
 60", 72", 84", 96"
 Inside Width 1 3/4" less than
 width
 Depth 15"
 Inside Depth 12 7/8"
 Height 15", 22 1/2" (to 60"W)
 Inside Height 13 3/8", 20 7/8"

Overhead Storage — Dual Access

Open Width 36", 48", 60"
 Inside Width 17 1/8", 23 3/8",
 29 3/8", 35 3/8" per side
 Depth 15"
 Inside Depth — Slider 15 1/4"
 Open 16 1/4"
 Height 15"
 Inside Height 13 3/8"

LED undercabinet light can be mounted beneath laminate overhead cabinets for a low profile lighting option. (Recessed tasklights not recommended as bottom of laminate wood storage is not recessed.)

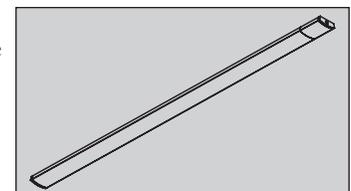

Wood Storage — Floor Based

- Plinth base or footed design with choice of feet that coordinate with either Stride® or Terrace®. (Unless unit is mobile.)
- Units ship assembled except for feet and pulls.
- Three pull options: arch, square, or straight.
- ¾" thick laminated particleboard with edge banding and European cam-and-pin construction.
- Available laminates: solid, woodgrain, or two-tone (case one laminate / front (door or drawer) a different laminate).
- 72"W units require Solid color laminate case, front can be woodgrain or solid.
- Doors and drawers lock except for stacking storage units and hinged cupboard doors on towers.
- Single sided sliding door units are non-handed; open half depends on door position. Door locks in either position.
- Some models require counterweights, wood backs, or ganging — see page 266.
- File drawers 30"W and wider accommodate legal size documents.
- Center stability foot is included on units 60"W or larger and is always black.

Mobile Pedestal (Plinth base or footed page 273)

- Box/file drawers; 24"H x 15½"W x 18"D.
- Has a top and finished back. Ships with counterweight.

Freestanding Pedestals (Plinth base or footed page 273)

- Box/file drawers; 24"H x 18"W x 18"D or 24"D.
- Have a top and unfinished back.
- Requires counterweight (order separately) if freestanding — see page 266.
- Units ship assembled except for feet and pulls.

Support Pedestals (Plinth base or footed page 273)

- Support pedestals include box/box/file, file/file, or open with one adjustable metal shelf.
- Support pedestals are 15½"W or 18"W; 18"D, 24"D and 30"D; and 28"H. They are meant to support worksurfaces; optional tops are available. With a top they are 29½"H.
- 30"D pedestals are designed to support 30"D worksurfaces; drawer depths are the same as 24"D pedestals.
- Open w/shelf models have finished laminate backs; backs on other models are open with spanner bar with optional laminate back ordered separately if back is exposed.

17½"H Credenzas (Plinth base or footed page 274)

- 18"D or 24"D; includes tops. Some models require counterweights or ganging — see page 266.
- Single lateral has one drawer, 30"W or 36"W. Requires counterweights. Optional laminate back ordered separately.
- Single lateral w/open side cubby is handed — drawer, left, or right; 48"W, 60"W, or 72"W.
- Center stability foot is included on units 60"W or larger and is always black.
- Table (closed base) units are 24"W x 24"D.
- Units ship assembled except for feet and pulls.

24"H Credenzas (Plinth base or footed pages 275-276)

- 18"D or 24"D with tops.
- Box/lateral is 30"W and box/box/lateral is 36"W. Optional laminate back ordered separately.
- Box/lateral w/open side are handed — drawer, left, or right; 48"W, 60"W, or 72"W.
- Center stability foot is included on units 60"W or larger and is always black.
- Sliding door w/adjustable metal shelf; 36"W or 48"W.
- Open binder units have an adjustable metal shelf; 18"W, 24"W, 30"W, or 36"W.
- Units ship assembled except for feet and pulls.

28"H Support Credenzas (Plinth Base or footed pages 277-278)

- 18"D or 24"D without tops.
- Units are designed to support worksurfaces; tops must be ordered separately. With top, credenzas are 29½"H.
- Box/box/lateral are 24"W or 30"W. box/box/project drawer/ lateral is 36"W. Optional laminate back ordered separately.
- Lateral/laterals are 30"W or 36"W. May require counterweights — see page 266. Optional laminate back ordered separately.
- Sliding door units w/adjustable metal shelf and an open top shelf; non-handed, 36"W or 48"W.
- Open cubby models have an adjustable metal shelf; 24"W, 30"W, or 36"W.
- Units ship assembled except for feet and pulls.

42"H Credenzas (Plinth base or footed page 279)

- Units are 18"D and designed to support worksurfaces; tops must be ordered separately. With worksurface, credenzas are 43½"H.
- 3-drawer lateral has a laminate back with seams and is 36"W.
- Aesthetic should be considered in applications where back is visible.
- Units ship assembled except for feet and pulls.

Cam Cover Kits (page 282)

- 17½"H, 24"H, and 28"H credenzas ship without cam covers. Cam cover kits can be ordered separately. 20 cam covers in each kit.

15"W Box Drawer Pedestals and Accessory (page 274)

- Box drawers do not include pencil tray.
- Order pencil tray separately - A2280-000

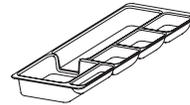

Bookcases and Bookcases with Lateral File (Plinth base or footed page 280)

- Open bookcases are 15"D. 65"H have 2 adjustable and 1 fixed shelves. 72½"H have 2 adjustable and 2 fixed shelves.
- Bookcases w/lateral are 24"D with 15"D upper bookcase. 65"H have 2 fixed shelves. 72½"H have 1 fixed and 2 adjustable shelves.
- Pin-and-cam fasteners visible from the front are covered with cam covers.
- Backs of all units have exposed pin-and-cam fasteners. Optional cam covers are available to order. Aesthetic should be considered in applications where back is visible.
- Units ship assembled except for feet and pulls.

Tops and Cushions for Pedestals and Credenzas (page 281)

- Laminate tops are 1¼" thick and 18"D or 24"D, for use on storage without tops in freestanding applications. Certain freestanding applications require counterweights or ganging — see below.
- Cushions are for use on 17½"H and 24"H storage with tops to create additional seating.

Counterweight Kits (page 282)

- Counterweight is attached to the bottom of a credenza to inhibit tipping.
- Kits must be ordered separately (see page 282) based on type and depth of unit and field-installed.
- Units designated to be ganged must be ganged to at minimum a 36"W unit with non extendable elements (i.e. KL243618N).
- Counterweight kits required for freestanding pedestals and credenzas:

HEIGHT / WIDTH	DEPTH	REQUIRED KITS
24"H Pedestals		
18"W	18"D	2 Kits & Wood Back
	24"D	2 Kits*
	30"D	0 Kits
28"H Pedestals		
15"W or 18"W	18"D	2 Kits & Wood Back
	24"D	2 Kits
	30"D	0 Kits
17"H Single Lateral Credenzas		
30"W or 36"W	18"D	2 Kits & Ganged*
	24"D	0 Kits & Ganged
17"H Single Lateral w/Open Side Credenzas		
48"W, 60"W, or 72"W	18"D	1 Kit
	24"D	0 Kits
24"H Lateral w/Box Drawer(s) Credenzas		
30"W or 36"W	18"D	4 Kits & Ganged*
	24"D	4 Kits & Ganged*
24"H Lateral w/Open Side Credenzas		
48"W, 60"W, or 72"W	18"D	3 Kits
	24"D	0 Kits
28"H Lateral w/Box Drawers Credenzas		
24"W	18"D	2 Kits & Ganged*
	24"D	2 Kits & Ganged*
30"W or 36"W	18"D	4 Kits, Wood Back, & Ganged
	24"D	1 Kit & Ganged*
28"H Lateral/Lateral Credenzas		
30"W or 36"W	18"D	3 Kits & Wood Back
	24"D	3 Kits*

Units designated with an "" may have 1 counterweight kit removed if a finished wood back is installed.

- Counterweight kit(s) and/or wood backs are not required if ganged back-to-back.
- One counterweight kit can be removed for each additional 36" width of ganged storage to units with non extendable elements.
Example: (1) 28"H x 36"W x 24"D Lateral/Lateral Credenza
 + (2) 28"H x 36"W x 24"D Open Credenzas
 (3) kits - (2) kits for 72" ganged = (1) **total kit required**

Ganging Brackets (page 282)

- Ganging brackets attach to underside of Credenzas.
- Can be used in place of Counterweight Kits based on counterweight requirements above.
- Unique ganging bracket models for footed and plinth base models.

Metal Shelves (page 283)

- Pullout shelves have a 50 lb. weight capacity and are field-installed using supplied template.
- Pullout shelves are 2"H x 18"W, 24"W, 30"W, or 36"W; and 12"D, 18"D or 24"D in P1, P2, and P3 paint colors.
- Pullout shelves can be used in open cubby space with box/lateral credenzas with septum (exception of sliding door credenzas with septum).
- Additional metal shelves with pins in dimensions for open units are available in P1, P2, and P3 paint colors.

Soft Seating — Bases/Tops/Cushions and Tables

(Plinth base or footed pages 285-286)

- Bases, either plinth base or leg base units, are ordered separately from seat cushions and table tops. 11"H x 24"D seat base comes with drawer(s) or open shelves; unfinished back and no top. 24"W, 36"W or 48"W.
- Order seat base top(s) 12"W, 24"W, 36"W, or 48"W; or 24"W seat base cushion(s); or banquette cushion(s) (24"W or 36"W) separately to fill entire width of seat base.
- 24"W seat base top is available with power module cutout. Power modules ordered separately with USB, iPod, or Ports.
- Seat base drawer fronts have finger pocket on underside.
- Low open table with top is 11"H and can be used in a soft seating application; 36"W or 48"W and 18"D or 24"D.
- Corner table w/top is closed on all sides; 17½"H x 24" x 24".
- When creating a 90° setup using three seat bases, use of ganging bracket replaces front visible foot on corner seat base.

Personal Towers (Plinth base or footed pages 287-291)

- Available in heights of 42½", 50", 57½", 65", and 72½".
- Available in right-hand and left-hand configurations. Box/box/file and file/file — front hinged door or side access models with or without 6" wide full-height wardrobe.
- 12"W towers must be attached to a panel, worksurface, or credenza.
- 18"W towers must be attached to a worksurface with Z6LB or a credenza with an inset back using bracket KLGK.
- Pilot holes in case to use "L" tower bracket or tower rail.
- Shelves in hinged door models are adjustable.
- Shelves in side access models are adjustable.
- Full width wardrobe 18"W or 24"W with 2 adjustable metal shelves on 65"H or 72½"H. 24"D have hanging rod; 18"D have double-hook.
- Pin-and-cam fasteners visible from the front and behind a door are covered with cam covers.

"L" Tower Bracket (page 291)

- Used to support a worksurface at 29½"H.
- Attaches using pre-drilled holes inside the tower.
- For use with laminate and painted wood storage only.
- The depth of the worksurface and tower should be equal.

Tower Rail (page 291)

- The tower rail mounts to the user side of towers and is used to attach worksurfaces at a height range of 27½"H to 30½"H.
- Attaches using pre-drilled holes inside the tower.
- Requires rail bracket kit for worksurface — order separately.

Stacking Storage (page 292)

- Units are 18" deep; 20", 27½", 35", and 42½"H. Open units 18"W or 24"W and hinged door units 18"W. 24"W hinged door with 6"W side display available 20"H or 27½"H.
- Units are non-locking and designed to be attached with double-sided tape on top of a 28"H properly supported storage unit worksurface and align with Stride®, Terrace® or Optimize™ elevations.
- Stacking Storage units can not be stacked on each other.
- 42½"H units have two adjustable-height metal shelves; 27½"H and 35"H units have one adjustable shelf.
- Pin-and-cam fasteners visible from the front and behind a door are covered with cam covers.

Overhead Storage (pages 293-294)

- Units include: hinged door, sliding door, dual-access, and open.
- 15"H units are designed to mount on module to a panel (Terrace or Stride — order panel mount brackets separately) or mount atop stanchions — ordered separately. 15"H and 22½"H units mount to a hard wall using horizontal wall-mount bracket — ordered separately. 22½"H have fixed metal shelf and can only be wall mounted. *See page 262 for panel mounting rules.*
- No double stacking of laminate overheads.
- 24"-36"W hinged door cabinets have 2 doors with one lock on the front of the cabinet; 42"W 3 doors with two locks; 48"W, 60"W, and 72"W have 4 doors with a center security septum and two locks; 84"W 6 doors, two septums, and three locks; 96"W 8 doors, three septums, and four locks.
- Sliding door overheads have one door with one lock that can only be locked when the door is in the left-hand position.
- Back side of single sided units are not meant to be exposed.
- Dual-access units are 18"D and designed to be used between two stations with Terrace panel system. Open units are 36"W, 48"W or 60"W.
- Overhead cabinets feature self-engaging safety latch to secure the cabinet to panel.
- Specify low profile LED tasklights. *See page 295.*
- Pin-and-cam fasteners visible from the front, bottom, and behind a door are covered with cam covers.
- Overheads 72"W or greater cannot be panel mounted. For stanchion mounting and wall mounting only.
- When stanchion mounting 72"W or greater overheads, a taskpanel kit is required on one or both sides.
- A mid stanchion is required with overheads 72"W and wider.
- A taskpanel kit is required when attaching 72"W and wider overheads to a single adjacent tower using the tower-to-overhead bracket kit.
- Taskpanel kits are not required when attaching 72"W and wider overheads to two towers using the tower-to-overhead bracket kits.
- When wall mounting overheads 72"W and wider use two brackets: 2-36"W for 72"W, 2-42"W for 84"W, and 2-48"W for 96"W.
- When ordering a two-tone option for overheads 72"W or greater, the case must always be a solid laminate color.
- Woodgrain laminate option limited to doors for overheads 72"W or greater. Case must be a solid laminate color.

Laminate Shelf, Book Shelf, and Open Box (page 294)

- Units are designed to mount on module to a panel (Optimize®, Terrace® or Stride® — brackets provided).
- Must conform to specific panel system rules for Overhead mounting
- Cannot be wall-mounted.
- Ship with panel mount brackets installed.
- Capacity not to exceed 50 lbs. on laminate shelf.

Overhead Stanchions (page 295)

- Aluminum, mid, and non-handed; 5", 11", 12", 18", 19¼", 26", and 27"H.
- 15"D used with single sided overheads, 18"D with dual access.
- Stanchions for 24"H credenzas with tops aligns unit with panel or storage: 11" stanchions align with 35"H; 18"H aligns with 42½"H; 26" aligns with 50"H.
- Stanchions for 28"H credenzas on 29½"H surface aligns unit with panel or storage: 5" stanchions align with 50"H; 12"H aligns with 57½"H; 19¼" aligns with 65"H; 27"H aligns with 72½"H.
- Overheads 72"W and wider require a mid overhead stanchion.
- Unfinished back may be exposed in freestanding application.
- Overhead stanchions are not recommended to be used on freestanding desks.

Tower-to-Overhead Bracket (page 295)

- Used when stanchion mounting 72"W, 84"W, or 96"W overheads to an adjacent tower.

Horizontal Wall-Mount Brackets (page 295)

- Use to attach an overhead directly to wall.
- Attachment hardware not included.

LED Undercabinet Light (page 295)

- Low profile energy-efficient LED tasklight for use with Involve overhead storage cabinets. Attachment hardware included.
- 95 footcandles at 18"; 3500K color temperature.
- 15W power supply is attached to plug: allow 1⅞"D space at outlet. Includes 3 cord retainer clips.

Hutches (page 297)

- Units include: hinged door, sliding door, and open.
- Designed for use on top of 28"H credenzas with a worksurface of same or greater width — 35"H align with 65"H and 42½"H with 72½"H elevation.
- Laminate hutches are not recommended to be used on freestanding open gable desks.
- Laminate hutches ship fully assembled and attach to a worksurface with double sided tape.
- When ordering a two-tone hutch with a woodgrain case 66"W and wider, the woodgrain direction on the lower back runs horizontal (tackboard recommended). The upper back woodgrain runs in a vertical direction.
- 48"-72"W hinged door cabinets have 4 doors with two locks on the front of the cabinet and a center security septum, 84"W has 6 doors with three locks and two security septums.
- 48"-66"W sliding door overheads have one door with one lock. 72" and 84"W have 2 doors with two locks and two security septums. Doors can only be locked when the door is in the left-hand position.
- 35"H have 19¼" of clearance and 42½"H have 27¼".
- Specify low profile LED task lights.
- Pin-and-cam fasteners visible from the front, bottom, and behind a door are covered with cam covers.

Tackboards for Hutches (page 298)

- Use tackboards to finish the back of a hutch.
- Tackboards are recommended on woodgrain laminate hutches since woodgrain runs horizontal as opposed to vertical.
- Specify paint color for metal frame and panel fabric.
- 66"W, 72"W, and 84"W ship as two tackboards and a center splicer for routing cables.

Primary Center Grommet Worksurfaces for use with Hutches (page 299)

- For use with Involve laminate hutches (72"W and 84"W) when a grommet or scallop is needed in the center of the worksurface which the hutch is sitting on.
- Rectangular only, in 72"W and 84"W — laminate with flat or rabbet edge and veneer with square or rabbet edge.
- Always includes center grommet position; left, right, or left and right additional grommet positions are optional.
- Oval plastic grommets are standard; metal grommet(s) are optional.

Laminate worksurfaces are 1/4" thick with particle board core and with top surfaces finished in high-pressure laminate. Bottom surfaces are covered with a backer sheet.

Wire management grommets are standard in most worksurfaces (unless specified without grommets).

Support Guidelines

- Unsupported panel runs greater than 72" need floor support for improved stability.
- Worksurface bracket kit should be used to tie panels to worksurface for added stability.
- A panel run without a return needs a floor support.

Worksurface offering includes linear taper and sweep shaped worksurfaces to support the integration of Involve soft seating and 18"D storage into the workplace.

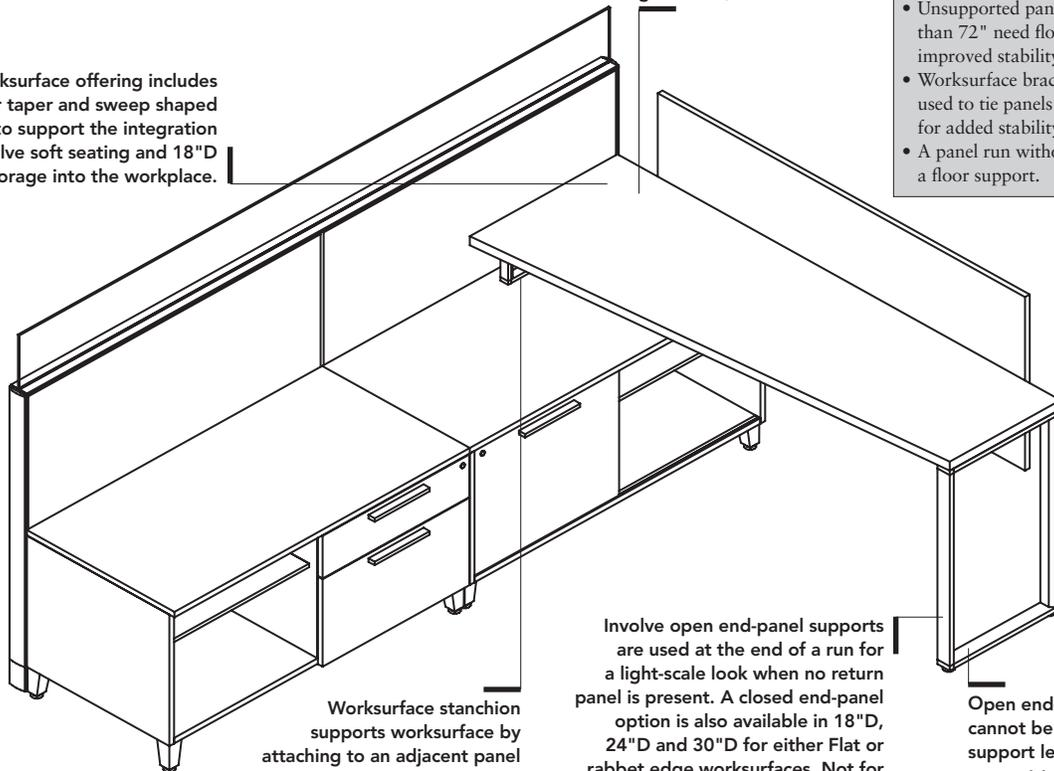

Worksurface stanchion supports worksurface by attaching to an adjacent panel and 24"H Involve storage below.

Involve open end-panel supports are used at the end of a run for a light-scale look when no return panel is present. A closed end-panel option is also available in 18"D, 24"D and 30"D for either Flat or rabbet edge worksurfaces. Not for use with T-mold worksurfaces.

Open end-panel supports cannot be used as in-line support leg, or used to connect two worksurfaces.

Primary worksurfaces are available in 18", 24", and 30" depths. Nominal worksurface width is equal to nominal panel width. Unsupported worksurface spans of 60"W-84"W require an external worksurface support channel. It is recommended for spans 48"W-59"W. See pages 270 and 301. Support hardware is ordered separately.

Corner worksurfaces with woodgrain laminate and veneer have grain direction diagonal to adjacent worksurfaces. One rear center support bracket is included. All other support hardware is ordered separately.

Secondary worksurfaces are available in 12", 18", and 24" depths. Support hardware is ordered separately.

Credenza and pedestal tops are specified separately for 28"H and 42"H units to allow the spanning of multiple peds or credenzas.

Threaded-metal inserts are standard for ease of installation and a positive fit. Worksurfaces can be panel hung or used in freestanding applications.

Worksurface stanchions are used to support worksurface when mounted atop a 24" high Involve credenza. Worksurface stanchions are 5/4"H and made of aluminum. They are available in depths of 12" and 18" and used to support surfaces 18", 24", and 30" deep.

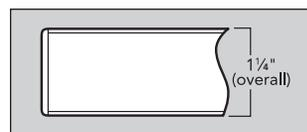

Flat Edge trim is available on laminate tops in eleven standard colors (customer specified) to match solid laminates and to complement patterned or in fourteen woodgrain edges color matched to the woodgrain laminates. Veneer worksurfaces have veneer edge.

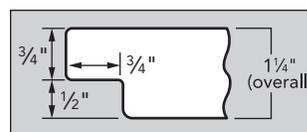

Rabbet Edge trim is available on select laminate and veneer tops. These worksurfaces and credenza tops have rabbet edge detail on all sides.

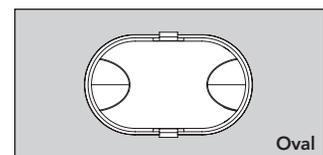

Oval

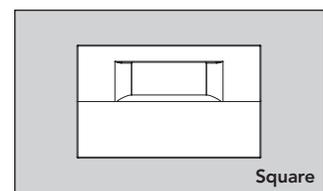

Square

Wire management grommets are standard in most worksurfaces and are specified in plastic or metal. **Metal grommets** are available in oval or square (shown above).

Primary and EZ View Worksurfaces (page 299)

- Wire management grommets standard, one for widths up to 42", two on widths 48"W and greater. Add "N" suffix for no grommets.
- Worksurfaces 66" and over require a cantilever bracket for center support in panel mounted applications. Specify 18" cantilever on 24"D, and 24" cantilever on 30"D worksurfaces.
- Desking worksurfaces should be specified for spans 60" and over when worksurfaces are not panel-attached with additional support along the width. For desking applications and widths greater than 72", additional to-the-floor support is recommended.
- Laminate flat edge worksurfaces can be specified with scallop wire management detail with no upcharge by adding suffix "S" to the model number.

Primary Desking Worksurfaces (page 299)

- Ships with an external worksurface support channel which extends 1½" below the worksurface and is inset 6" from each end. Support channel is field installed to allow for larger worksurface spans and ships separately.
- Wire management grommets standard, one for widths up to 42", two on widths 48"W and greater. Add "N" suffix for no grommets.
- Laminate flat edge worksurfaces can be specified with scallop wire management detail with no upcharge by adding suffix "S" to the model number.

EZ View Transition Worksurfaces (page 299)

- Surface is non-handed, with one wire management grommet centered on the 36"D end. Add "N" suffix for no grommets.

External Worksurface Support Channel (page 301)

- Extends 1½" below the worksurface. Installs 7" from user's edge.
- Is required on a systems worksurface for additional support for spans greater than 60"; or if a full depth horizontal storage unit is installed under the worksurface.
- Required when mounting a Stride® modesty panel.
- When using Involve supports, specify a standard worksurface and an external support channel of a smaller size. The size of the external support channel will depend on the distance between supports.

Freestanding O-Leg Supports - Metal (page 301)

- Available 29½"H and 18"D, 24"D, 30"D, and 36"D. Non-handed.
- Will work on both flat- and rabbet-edge worksurfaces.
- Can be used to build a free-standing table.
- Adjustable glides have a leveling range of 2".

Panel-Mounted Brackets for O-Leg (page 301)

- Available in left- or right-handed.
- Brackets are optional and are used to tie to a Stride, Terrace, or Optimize panel.

Freestanding Closed End Panel Supports — Laminate (page 300)

- Available 29½"H and 18"D, 24"D and 30"D. Non-handed.
- Can be used to build a freestanding desk or console table if specified with a full height modesty panel. See chart on page 302.
- Can not be used with rabbet edge worksurfaces.
- Includes laminate end-panel, attaching hardware and adjustable glides.
- Adjustable glides have a leveling range of 2¾".

Panel-Mounted Closed End Panel Supports — Laminate (page 300)

- Available 29½"H and 18"D, 24"D and 30"D. Non-handed.
- Can not be used with rabbet edge worksurfaces.
- May not be used to build a freestanding table.
- Includes laminate end-panel, panel mount bracket (non-handed), attaching hardware and adjustable glides.
- Adjustable glides have a leveling range of 2¾".
- Includes hardware to convert freestanding end-panel to panel mount. 24"H or 30"H and left- or right-handed.

Storage-to-Panel Brackets (page 300)

- Used to attach the back or side of storage to a panel frame to provide stability when used with Stride, Terrace, or Optimize frames.
- Handedness is determined by side of storage that attaches to panel when facing panel run.

Post Leg (page 301)

- Used to support worksurfaces at 29½"H.
- Adjustable glides have a leveling range of 2¾".

Worksurface Stanchion (page 301)

- Worksurface stanchions are 5¼"H for Involve credenza and made of aluminum.
- Used to support worksurface when mounted atop a 24"H Involve credenza. (4"H designed for 22"H Stride credenza.)
- Stanchions are field located on 24"H storage, either centered or offset 3" from edge to create additional piling space between storage and worksurface.
- Available in depths of 12" and 18". 12" is designed to work with 18"D worksurfaces and 18" with 24"D worksurfaces. Use two stanchions when mounting a 30"D or deeper worksurface. Stanchion orientation should run parallel to the length of the worksurface it is supporting.

"L" Tower Bracket (page 301)

- Used to support a worksurface at 29½"H.
- Attaches using pre-drilled holes inside the tower.
- For use with laminate and painted wood storage only.
- The depth of the worksurface and tower should be equal.

Tower Rail (page 301)

- The tower rail mounts to the user side of towers and is used to attach worksurfaces at a height range of 27½"H to 30½"H.
- Attaches using pre-drilled holes inside the Tower.
- Requires rail bracket kit for worksurface — order separately.

Light-scale screens provide space division. There are four options available: surface mounted modesties, privacy panels, divider panels, and taskpanels.

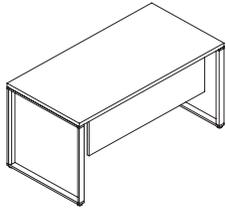

Surface mounted modesties are mounted to the underside of the desking worksurface or worksurface with external support channel. They are 11"H and available in laminate or frosted glass. Single or shared (laminate only) mounting models are available. Laminate models include a wire tray on one side of single units and on both sides of shared models. There is an optional wire tray available for glass units.

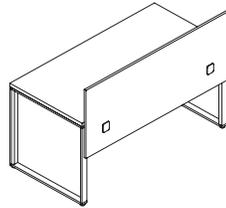

Privacy panels extend above and below the desking worksurface acting as both a screen and a modesty panel. They are 25"H and available in laminate or glass (frosted or writable). Single or shared (laminate only) mounting models are available. Laminate models include a wire tray on one side of single units and on both sides of shared models. There is an optional wire tray available for glass units.

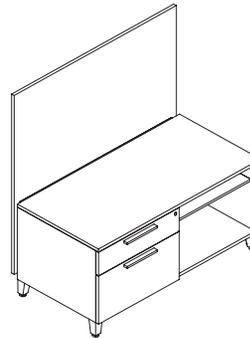

Divider panels attach to laminate back of credenza to provide space division between workstations. They are available in laminate in a 50" height.

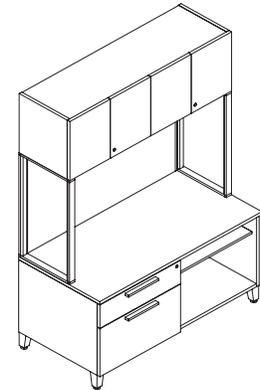

Taskpanels mount between stanchions under overhead storage cabinets. They are available as tackable, marker board, or laminate in 12", 18", 19", 26", or 27" heights.

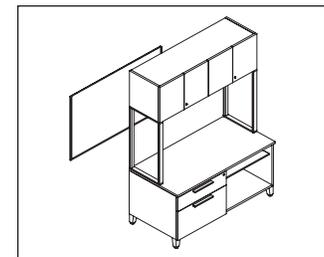
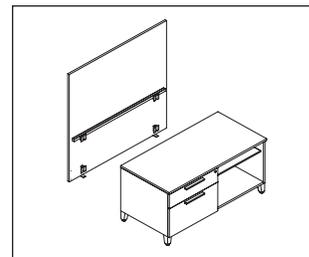

Specification Rules for Modesties and Privacy Panels

When mounting a modesty panel or a privacy panel use a desking worksurface or worksurface with an external support channel added. When mounting a modesty flush to the edge of a worksurface supported by O-Legs the modesty is to be 7" in from the front edge, the modesty must be 14" narrower than worksurface width.

When using a power/data module between a privacy panel and a worksurface, the privacy panel must be mounted 1" away from edge of the worksurface. Privacy panel can be mounted flush to the edge of the worksurface if power/data module is not used.

When using a power/data module with a surface

mounted modesty panel, the modesty panel must be inset a minimum of 2" in from the edge of the worksurface.

Privacy panel width can be same width as worksurface. *Example:* 60"W privacy panel can be used on a 30"D x 60"W worksurface. Width of panel is undersized by 1/4" providing a 1/8" gap when centered. Placement or use of a modesty must be 12" narrower than worksurface width when using Involve open and closed gable ends.

When using modesty with a Stride post leg, the width of the modesty can be the same as the worksurface, but must be mounted 8" or more in from the front edge of the worksurface.

Freestanding Table

Applications:

Privacy panels require a minimum worksurface depth of 30" for freestanding applications. Surface mounted modesties can be used with any depth freestanding application.

Panel Applications:

When using a privacy panel in a back-to-back application the adjacent panel run requires an extended straight connector to compensate for depth of shared privacy panel.

Full-Height Modesty Panels (page 302)

- Full height modesty panels are designed to create a desk. A desk can be created with a modesty panel, worksurface, and storage or gable ends on each side — see chart on page 302.
- Available in solid and woodgrain laminate color options. Modesties 61" wide or larger are limited to solid laminate colors only.
- It is recommended to recess the modesty in from the edge of the worksurface. When using with a 24"D surface, recess modesty 6". When using a 30"D surface, recess modesty 6" or 12".
- If attaching desk to a panel on one side, use a storage-to-panel bracket kit.

Divider Panels (page 303)

- Divider panels can be attached to the back of 24"H credenzas to provide space division between workstations.
- Offered in laminate in widths to attach to 30"W, 36"W, 48"W, and 60"W credenzas; and height to align with 50"H modules.
- Mounting brackets provide a 1" cord drop space between edge of worksurface and the ¼" thick divider panel.
- A cableway is provided on the inside of the divider panel to facilitate the passage of wires.
- Mounting brackets and cableway are available in black only.
- The mounting of the divider panel is designed to center the ¼" thick panel within the lateral space created by adding an extended straight connector in a panel spine.
- When specifying a divider panel to be attached to a credenza with an unfinished back, a laminate credenza back must also be specified for attachment of the divider panel brackets.
- Divider panel cannot span two credenzas side-to-side.
- Divider panels are designed to be used in single-sided application.
- Divider panel lines up with bottom of credenza case.
- Counterweight kits are still required in credenzas as rules state on page 266.

Taskpanels (page 304)

- Taskpanels are available in tackable material and attach between stanchions supporting and overhead storage cabinet.
- Taskpanels are available in 30"W, 36"W, 42"W, 48"W, 60"W, 72"W, 84"W, and 96"W. 72"W and wider consist of two panels. Nominal width of taskpanel should match width of overhead storage cabinet.
- Taskpanels are available 18"H or 26"H for use with 24"H credenzas; and 12"H, 19"H, or 27"H for use with 28"H credenzas. Nominal height of taskpanel should match stanchion height.
- Laminate and tackable taskpanels are encapsulated in a painted metal pan on sides and bottom.
- Back of unit has exposed fasteners. Aesthetic should be considered in applications where back is visible.

Involve® Laminate Wood Storage

24"H Credenzas

For specification information see pages 260-268.

GSA SIN PENDING

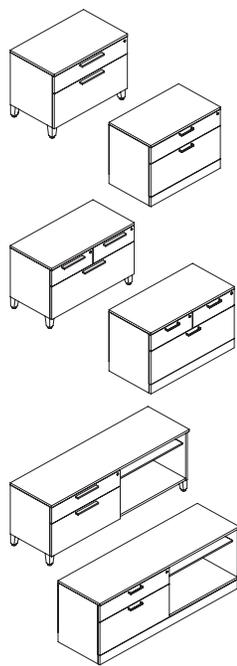

Description	Solid Color "KL" (Feet +\$100) or "KLP" (Plinth); Or prefix for Woodgrain or Two-Tone "K2T" (Feet +\$100) or "K2TP" (Plinth) Model	Lock Qty	L1 Laminate List Price	UPCHARGES*			
				L2 Laminate Case	L2 Laminate Front	L3 Laminate Case	L3 Laminate Front
24"H Credenza — Box/Lateral (unfinished back)#							
30"W x 18"D (shown)	K □ 243018BF	1	\$ 3020	\$ 71	\$ 36	\$ 142	\$ 61
30"W x 24"D	K □ 243024BF	1	\$ 3140	\$ 74	\$ 36	\$ 148	\$ 64
24"H Credenza — Box/Box/Lateral (unfinished back)#							
36"W x 18"D (shown)	K □ 243618E	2	\$ 3113	\$ 74	\$ 36	\$ 148	\$ 77
36"W x 24"D	K □ 243624E	2	\$ 3236	\$ 77	\$ 37	\$ 156	\$ 79
24"H Credenza — Box/Lateral and Open Side with Metal Shelf (finished back)#							
48"W x 18"D Lat/RH Open	K □ 244818RAF	1	\$ 4837	\$ 116	\$ 52	\$ 232	\$ 98
48"W x 18"D LH Open/Lat	K □ 244818LAF	1	\$ 4837	\$ 116	\$ 52	\$ 232	\$ 98
60"W x 18"D Lat/RH Open (shown)	K □ 246018RAF	1	\$ 5059	\$ 120	\$ 54	\$ 243	\$ 105
60"W x 18"D LH Open/Lat	K □ 246018LAF	1	\$ 5059	\$ 120	\$ 54	\$ 243	\$ 105
72"W x 18"D Lat/RH Open**	K □ 247218RAF	1	\$ 5498	N/A	N/A	N/A	N/A
72"W x 18"D LH Open/Lat**	K □ 247218LAF	1	\$ 5498	N/A	N/A	N/A	N/A
48"W x 24"D Lat/RH Open	K □ 244824RAF	1	\$ 5034	\$ 119	\$ 53	\$ 242	\$ 105
48"W x 24"D LH Open/Lat	K □ 244824LAF	1	\$ 5034	\$ 119	\$ 53	\$ 242	\$ 105
60"W x 24"D Lat/RH Open	K □ 246024RAF	1	\$ 5260	\$ 124	\$ 55	\$ 253	\$ 109
60"W x 24"D LH Open/Lat	K □ 246024LAF	1	\$ 5260	\$ 124	\$ 55	\$ 253	\$ 109
72"W x 24"D Lat/RH Open**	K □ 247224RAF	1	\$ 5717	N/A	N/A	N/A	N/A
72"W x 24"D LH Open/Lat**	K □ 247224LAF	1	\$ 5717	N/A	N/A	N/A	N/A



Laminate Back (optional for 24"H credenza with unfinished back)	L2 Laminate	L3 Laminate		
30"W – Footed Base	KLCB2430	\$ 271	\$ 13	\$ 20
30"W – Plinth Base	KLPCB2430	\$ 506	\$ 20	\$ 36
36"W – Footed Base (shown)	KLCB2436	\$ 387	\$ 16	\$ 28
36"W – Plinth Base (shown)	KLPCB2436	\$ 523	\$ 20	\$ 38

*Upcharges are added to laminate list price depending on woodgrain laminate selection.

#Unit may require counterweight kits, see page 266.

**72"W credenza case must always be solid color laminate.

How to specify — Select the Model Number from above.	1st Option: Foot Type (if applicable):	2nd Option: Foot Paint Color (if applicable):	3rd Option: Pull Type (if applicable):	4th Option: Pull Color (if applicable):
KL Feet / Solid Color KLP Plinth/ Solid Color K2T Feet / Woodgrain or Two-Tone K2TP Plinth / Woodgrain or Two-Tone	TF Terrace Foot ZF Stride Foot (Add \$29)	P1 P2 See page 250 for finishes. Stride is limited to PR6 Silver.	MP Beam OP Halo SP Square AP Arch See matrix on page 21.	MP Beam / OP Halo PJW Designer White PR6 Silver PJE Pyrite P8X Solar Black P2 upcharge +\$18/pull SP Square PJW Designer White EL Matte Silver P02 Flint P7B Loft PJE Pyrite P8X Solar Black AP Arch PRO Anodized Silver P2 upcharge +\$18/pull
K .		P .		.

Continued below ▼

5th Option: Metal Shelf Color (if applicable): P1 P2 P3 See page 250 for finishes. Add \$34 for P2 (except PR6) or \$60 for P3 Paints.	6th Option: FSC Certified Wood: FSC Select for FSC Certified Wood X No FSC	7th Option: Laminate Color: See page 250 for finishes. (If two-tone list case color here.)	8th Option: Matching Edge: See page 250 for finishes.	9th Option: 2nd Laminate Color (Front) (if applicable): See page 250 for finishes.	10th Option: Matching Edge (if applicable): See page 250 for finishes.	11th Option: Lock (if applicable): STD Standard OMT Omit Lock Core (Deduct \$20)	12th Option: Lock Color (if applicable): EL Silver
.	.		.		.		E L

Examples: K2T243018BF.TFPJW.APPR6.PR6.X.LWCWEDCW.LWCWEDCW.STDEL

KL244824RAF.ZFPR6.SPPR6.P7B.FSC.LM11EV.OMT

Involve® Laminate Wood Storage

28"H Credenzas

For specification information see pages 260-268.

GSA SIN PENDING

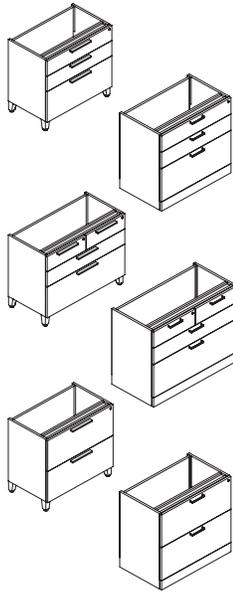

Description	Solid Color "KL" (Feet +\$100) or "KLP" (Plinth); Or prefix for Woodgrain or Two-Tone "K2T" (Feet +\$100) or "K2TP" (Plinth) Model	Lock Qty	L1 Laminate List Price	UPCHARGES*			
				L2 Laminate Case	L2 Laminate Front	L3 Laminate Case	L3 Laminate Front
28"H Support Credenza — Box/Box/Lateral (open back with spanner bar; without top)#							
24"W x 18"D	K □ 282418BBF	1	\$ 2967	\$ 70	\$ 34	\$ 140	\$ 60
30"W x 18"D (shown)	K □ 283018BBF	1	\$ 3188	\$ 74	\$ 36	\$ 153	\$ 64
24"W x 24"D	K □ 282424BBF	1	\$ 3087	\$ 72	\$ 36	\$ 144	\$ 62
30"W x 24"D	K □ 283024BBF	1	\$ 3316	\$ 78	\$ 37	\$ 159	\$ 66
28"H Support Credenza — Box/Box/Project Drawer/Lateral (open back with spanner bar; without top)#							
36"W x 18"D	K □ 283618E	2	\$ 3740	\$ 86	\$ 41	\$ 180	\$ 77
36"W x 24"D	K □ 283624E	2	\$ 3890	\$ 92	\$ 42	\$ 184	\$ 79
28"H Support Credenza — Lateral/Lateral (open back with spanner bar; without top)#							
30"W x 18"D (shown)	K □ 283018FF	1	\$ 2862	\$ 68	\$ 31	\$ 135	\$ 59
36"W x 18"D	K □ 283618FF	1	\$ 3168	\$ 74	\$ 36	\$ 153	\$ 64
30"W x 24"D	K □ 283024FF	1	\$ 2972	\$ 70	\$ 34	\$ 141	\$ 61
36"W x 24"D	K □ 283624FF	1	\$ 3291	\$ 78	\$ 37	\$ 159	\$ 66



Laminate Back (optional for 28"H credenza with open back with spanner bar)		L2 Laminate	L3 Laminate
24"W – Footed Base	KLCB2824	\$ 271	\$ 13 / \$ 20
24"W – Plinth Base	KLPCB2824	\$ 523	\$ 20 / \$ 38
30"W – Footed Base	KLCB2830	\$ 289	\$ 13 / \$ 20
30"W – Plinth Base	KLPCB2830	\$ 547	\$ 21 / \$ 40
36"W – Footed Base	KLCB2836	\$ 395	\$ 16 / \$ 28
36"W – Plinth Base	KLPCB2836	\$ 602	\$ 21 / \$ 41

*Upcharges are added to laminate list price depending on woodgrain laminate selection.
#Unit may require counterweight kits, see page 266.

How to specify — Select the Model Number from above. KL Feet / Solid Color KLP Plinth/ Solid Color K2T Feet / Woodgrain or Two-Tone K2TP Plinth / Woodgrain or Two-Tone	1st Option: Foot Type (if applicable): TF Terrace Foot ZF Stride Foot (Add \$29)	2nd Option: Foot Paint Color (if applicable): P1 P2 See page 250 for finishes. Stride is limited to PR6 Silver.	3rd Option: Pull Type (if applicable): MP Beam OP Halo SP Square AP Arch See matrix on page 21.	4th Option: Pull Color (if applicable): MP Beam / OP Halo PJW Designer White PR6 Silver PJE Pyrite P8X Solar Black P2 upcharge +\$18/pull	SP Square EL Matte Silver P02 Flint P7B Loft PJE Pyrite P8X Solar Black AP Arch PRO Anodized Silver P2 upcharge +\$18/pull
	K .	P

Continued below ▼

5th Option: Metal Shelf Color (if applicable): P1 P2 P3 See page 250 for finishes. Add \$34 for P2 (except PR6) or \$60 for P3 Paints.	6th Option: FSC Certified Wood: FSC Select for FSC Certified Wood X No FSC	7th Option: Laminate Color: See page 250 for finishes. (If two-tone list case color here.)	8th Option: Matching Edge: See page 250 for finishes.	9th Option: 2nd Laminate Color (Front) (if applicable): See page 250 for finishes.	10th Option: Matching Edge (if applicable): See page 250 for finishes.	11th Option: Lock (if applicable): STD Standard OMT Omit Lock Core (Deduct \$20)	12th Option: Lock Color (if applicable): EL Silver
.	E L

Examples: K2T243618E.TFPJW.APPR6.X.LWCWEDCW.LWCWEDCW.STDEL

INVOLVE

Involve® Laminate Wood Storage

28"H Credenzas

For specification information see pages 260-268.

GSA SIN PENDING

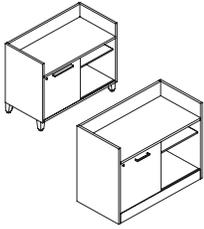

Description	Solid Color "KL" (Feet +\$100) or "KLP" (Plinth); Or prefix for Woodgrain or Two-Tone "K2T" (Feet +\$100) or "K2TP" (Plinth) Model	Lock Qty	L1 Laminate List Price	UPCHARGES*				
				L2 Laminate Case		L3 Laminate Front		
28"H Support Credenza — Sliding Door with Metal Shelf (laminata back, without top; non-handed)								
36"W x 18"D (shown)	K □ 283618N	1	\$ 3740	\$ 86	\$ 41	\$ 169	\$ 77	
36"W x 24"D	K □ 283624N	1	\$ 3890	\$ 93	\$ 43	\$ 186	\$ 79	
48"W x 18"D	K □ 284818N	1	\$ 4178	\$ 94	\$ 44	\$ 198	\$ 83	
48"W x 24"D	K □ 284824N	1	\$ 4347	\$ 105	\$ 46	\$ 209	\$ 86	

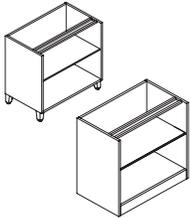

Description	Solid Color "KL" (Feet +\$100) or "KLP" (Plinth); Or prefix for Woodgrain or Two-Tone "K2T" (Feet +\$100) or "K2TP" (Plinth) Model	Lock Qty	L1 Laminate List Price	UPCHARGES*	
				L2 Laminate Case	L3 Laminate Front
28"H Support Credenza — Open Cubby with Metal Shelf (laminata back, without top)					
24"W x 18"D	K □ 282418A		\$ 2312	\$ 55	\$ 110
30"W x 18"D (shown)	K □ 283018A		\$ 2420	\$ 60	\$ 119
36"W x 18"D	K □ 283618A		\$ 2527	\$ 60	\$ 119
24"W x 24"D	K □ 282424A		\$ 2403	\$ 58	\$ 115
30"W x 24"D	K □ 283024A		\$ 2515	\$ 58	\$ 115
36"W x 24"D	K □ 283624A		\$ 2631	\$ 61	\$ 123

*Upcharges are added to laminate list price depending on woodgrain laminate selection.

Note: Additional pullout shelves can only be added to box/lateral credenzas with center septum.

**How to specify —
Select the
Model Number
from above.**

- KL Feet / Solid Color
- KLP Plinth/ Solid Color
- K2T Feet / Woodgrain or Two-Tone
- K2TP Plinth / Woodgrain or Two-Tone

- 1st Option:
Foot Type
(if applicable):**
- TF Terrace Foot
 - ZF Stride Foot (Add \$29)

- 2nd Option:
Foot Paint Color
(if applicable):**
- P1 P2
- See page 250 for finishes. Stride is limited to PR6 Silver.

- 3rd Option:
Pull Type
(if applicable):**
- MP Beam
 - OP Halo
 - SP Square
 - AP Arch
- See matrix on page 21.

- 4th Option:
Pull Color
(if applicable):**
- MP Beam / OP Halo
 - PJW Designer White
 - PR6 Silver
 - PJE Pyrite
 - P8X Solar Black
 - P2 upcharge +\$18/pull
 - SP Square
 - PJW Designer White
 - EL Matte Silver
 - P02 Flint
 - P7B Loft
 - PJE Pyrite
 - P8X Solar Black
 - AP Arch
 - PRO Anodized Silver
 - P2 upcharge +\$18/pull

Continued below ▼

- 5th Option:
Metal Shelf Color
(if applicable):**
- P1 P2 P3
- Add \$34 for P2 (except PR6) or \$60 for P3 Paints on shelf.

- 6th Option:
FSC Certified
Wood:**
- FSC Select for FSC Certified Wood
 - X No FSC

- 7th Option:
Laminate Color:**
- See page 250 for finishes.
- (If two-tone list case color here.)

- 8th Option:
Matching Edge:**
- See page 250 for finishes.

- 9th Option:
2nd Laminate
Color (Front)
(if applicable):**
- See page 250 for finishes.

- 10th Option:
Matching Edge
(if applicable):**
- See page 250 for finishes.

- 11th Option:
Lock:**
- STD Standard
 - OMT Omit Lock Core (deduct \$20 per lock)

- 12th Option:
Lock Color
(if applicable):**
- EL Silver

Examples: K2T283618N.TFPJW.APPR6.PR6.X.LWCWEDCW.LWCWEDCW.STDEL

KL283618A.ZFFPR6.SPPR6.P7B.FSC.LM11EV.OMT

Involve® Laminate Wood Storage

42"H Storage

For specification information see pages 260-268.

GSA SIN PENDING



Description	Solid Color "KL" (Feet +\$100) or "KLP" (Plinth); Or prefix for Woodgrain or Two-Tone "K2T" (Feet +\$100) or "K2TP" (Plinth) Model	Lock Qty	L1 Laminate List Price	UPCHARGES*			
				L2 Laminate Case Front		L3 Laminate Case Front	
42"H Credenza — 3 Drawer Lateral (without top; back has exposed fasteners)							
36"W x 18"D	K 423618FFF	1	\$ 4947	\$ 118	\$ 53	\$ 236	\$ 103

How to specify — Select the Model Number from above. KL Feet / Solid Color KLP Plinth/ Solid Color K2T Feet / Woodgrain or Two-Tone K2TP Plinth / Woodgrain or Two-Tone	1st Option: Foot Type (if applicable): TF Terrace Foot ZF Stride Foot (Add \$29)	2nd Option: Foot Paint Color (if applicable): P1 P2 See page 250 for finishes. Stride is limited to PR6 Silver.	3rd Option: Pull Type (if applicable): MP Beam OP Halo SP Square AP Arch See matrix on page 21.	4th Option: Pull Color (if applicable): MP Beam / OP Halo PJW Designer White PR6 Silver PJE Pyrite P8X Solar Black P2 upcharge +\$18/pull	SP Square PJW Designer White EL Matte Silver P02 Flint P7B Loft PJE Pyrite P8X Solar Black AP Arch PRO Anodized Silver P2 upcharge +\$18/pull
	K .		P .		

5th Option: FSC Certified Wood: FSC Select for FSC Certified Wood X No FSC	6th Option: Laminate Color: See page 250 for finishes. (If two-tone list case color here.)	7th Option: Matching Edge: See page 250 for finishes.	8th Option: 2nd Laminate Color (Front) (if applicable): See page 250 for finishes.	9th Option: Matching Edge (if applicable): See page 250 for finishes.	10th Option: Lock (if applicable): STD Standard OMT Omit Lock Core (Deduct \$20)	11th Option: Lock Color (if applicable): EL Silver
						E L

Examples: K2T423618FFF.TFPJW.APPR6.X.LWCWEDCW.LWCWEDCW.STDEL

INVOLVE

Involve® Laminate Wood Storage

65"H, 72½"H Bookcases

For specification information see pages 260-268.

GSA SIN PENDING

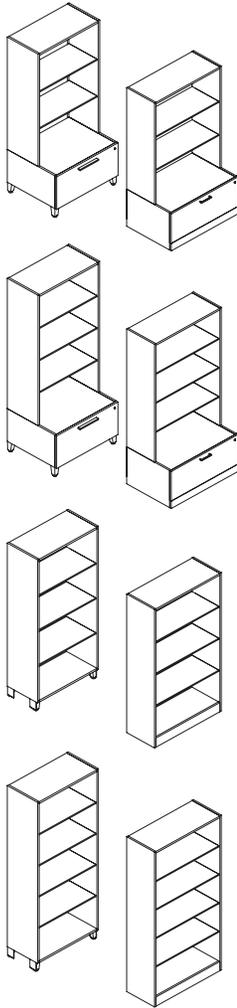

Description	Solid Color "KL" (Feet +\$100) or "KLP" (Plinth); Or prefix for Woodgrain or Two-Tone "K2T" (Feet +\$100) or "K2TP" (Plinth) Model	Lock Qty	L1 Laminate List Price	UPCHARGES*				
				L2 Laminate Case	L2 Laminate Front	L3 Laminate Case	L3 Laminate Front	
65"H Bookcase with Lateral File and Metal Shelves								
30"W x 24"D 2 Fixed Shelves	K □ BC653024F	1	\$ 5059	\$ 120	\$ 54	\$ 243	\$ 105	
36"W x 24"D 2 Fixed Shelves	K □ BC653624F	1	\$ 5277	\$ 124	\$ 55	\$ 254	\$ 109	
72½"H Bookcase with Lateral File and Metal Shelves								
30"W x 24"D 1 Fixed, 2 Adj. Shelves	K □ BC723024F	1	\$ 5344	\$ 125	\$ 55	\$ 256	\$ 110	
36"W x 24"D 1 Fixed, 2 Adj. Shelves	K □ BC723624F	1	\$ 5568	\$ 133	\$ 58	\$ 268	\$ 115	
65"H Bookcase with Metal Shelves				L2 Laminate		L3 Laminate		
30"W x 15"D 1 Fixed, 2 Adj. Shelves	K □ BC653015A		\$ 3960	\$ 93		\$ 190		
36"W x 15"D 1 Fixed, 2 Adj. Shelves	K □ BC653615A		\$ 4124	\$ 96		\$ 195		
72½"H Bookcase with Metal Shelves								
30"W x 15"D 2 Fixed, 2 Adj. Shelves	K □ BC723015A		\$ 4178	\$ 98		\$ 198		
36"W x 15"D 2 Fixed, 2 Adj. Shelves	K □ BC723615A		\$ 4397	\$ 105		\$ 211		

*Upcharges are added to laminate list price depending on woodgrain laminate selection.

INVOLVE

How to specify — Select the Model Number from above.	1st Option: Foot Type (if applicable): TF Terrace Foot ZF Stride Foot (Add \$29)	2nd Option: Foot Paint (if applicable): P1 P2 See page 250 for finishes. Stride is limited to PR6 Silver.	3rd Option: Pull Type (if applicable): MP Beam OP Halo SP Square AP Arch See matrix on page 21.	4th Option: Pull Color (if applicable): MP Beam / OP Halo PJW Designer White PR6 Silver PJE Pyrite P8X Solar Black P2 upcharge +\$18/pull	5th Option: SP Square PJW Designer White EL Matte Silver P02 Flint P7B Loft PJE Pyrite P8X Solar Black AP Arch PRO Anodized Silver P2 upcharge +\$18/pull
K .		P .		.	

Continued below ▼

5th Option: Metal Shelf Color: P1 P2 P3 See page 250 for finishes. Add \$60 for P2 (except PR6) or \$119 for P3 Paints.	6th Option: FSC Certified Wood: FSC Select for FSC Certified Wood X No FSC	7th Option: Laminate Color: See page 250 for finishes. (If two-tone list case color here.)	8th Option: Matching Edge: See page 250 for finishes.	9th Option: 2nd Laminate Color (Front) (if applicable): See page 250 for finishes.	10th Option: Matching Edge (if applicable): See page 250 for finishes.	11th Option: Lock Option (if applicable): STD Standard OMT Omit Lock Core (deduct \$20 per lock)	12th Option: Lock Color (if applicable): EL Silver
.	.		.		.		E L

Examples: K2T653024F.TFPJW.APPR6.P7D.X.LWCWEDCW.LWCWEDCW.STDEL

KLBC653015A.ZFPR6.SPPR6.P7B.FSC.LM11EV

Involve® Laminate Wood Storage

Accessories

For specification information see pages 260-268.

GSA SIN PENDING

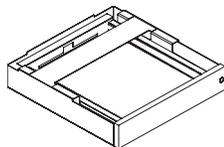
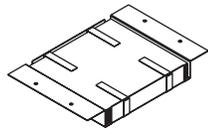

Description	Model	P1 Paint List Price	P2 Paint List Price
Storage-to-Panel Bracket Kits for 24"H and 28"H Credenzas only — back or side mount, painted metal			
24"H Left (requires laminate back for back mounting) (shown)	K624PBKL	\$ 183	\$ 203
24"H Right (requires laminate back for back mounting)	K624PBKR	\$ 183	\$ 203
28"H Left (requires laminate back for back mounting)	K630PBKL	\$ 201	\$ 221
28"H Right (requires laminate back for back mounting)	K630PBKR	\$ 201	\$ 221

Storage-to-Panel Bracket Kits for 24"H and 28"H Credenzas only — back mount only, painted metal			
24"H Left (does not require laminate back) (shown)	K624PBKML	\$ 183	\$ 203
24"H Right (does not require laminate back)	K624PBKMR	\$ 183	\$ 203
28"H Left (does not require laminate back)	K630PBKML	\$ 201	\$ 221
28"H Right (does not require laminate back)	K630PBKMR	\$ 201	\$ 221

Counterweight Kit			
For 18"D units	KLCW218	\$ 295	N/A
For 24"D units	KLCW224	\$ 440	N/A

Ganging Brackets			
For Involve Footed Storage and Seat Bases	KL GK	\$ 80	N/A
For Involve Plinth Base Storage and Seat Bases	KLPGK	\$ 80	N/A

CAM Covers — matches laminate specified			
CAM Covers (20 per pack)	KLCC	\$ 29	N/A

Description	Model	List Price		
		P1	P2	P3
Laptop Drawer - Locking, laminate front, metal case				
17 1/2"W x 18"D x 3 3/4"H (Interior 13"W x 16"D x 1 1/4"H)	U7WDA	\$ 1750	\$ 1773	\$ 1792

INVOLVE

How to specify — Select the Model Number from above.	1st Option: Laminate (Laptop drawer front if applicable): See page 250 for finishes.	2nd Option: Edge (Laptop drawer edge if applicable): See page 250 for finishes.	3rd Option: Paint (If laptop drawer, list exterior case color here): See page 250 for finishes.	4th Option: Paint (Interior of laptop drawer if applicable): See page 250 for finishes.	5th Option: Lock (if applicable): STD Standard OMT Omit (Deduct \$20)	6th Option: Lock or Tech Module Color (if applicable): EL Silver
_____	_____	_____	_____	_____	_____	_____

Examples: K624PBKL.P7B KLCC.LM16 U7WDA.LM11EV.P27.PR6.STDEL

Shippable by small-package carrier.

For specification information see pages 260-268.

GSA SIN PENDING

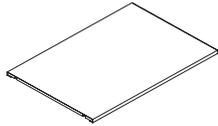

Description	Model	P1 Paint List Price	P2 Paint List Price	P3 Paint List Price
Metal Shelves — ½"H				
18"W x 18"D – for Units with Doors – use with KLC201818RH or LH	SH1818	\$ 208	\$ 242	\$ 268
18"W x 24"D – for Units with Doors – use with KLT501824LBBF, KLT502424RFF, KLT651824L, KLT721824R	SH1824	\$ 239	\$ 273	\$ 299
24"W x 24"D – for Units with Doors – use with KLT652424L or R	SH2424	\$ 240	\$ 274	\$ 300
30"W x 15"D – use with KLBC653015A or KLBC723015A (Bookcases)	SH3015A	\$ 265	\$ 299	\$ 325
36"W x 15"D – use with KLBC653615A or KLBC723615A (Bookcases)	SH3615A	\$ 277	\$ 311	\$ 337
18"W x 18"D – use with K □ 241818A, K □ 281818A, K □ C271818A, K □ C351818A, K □ C421818A, K □ 243618DA, K □ 283618DA (24"H & 28"H Credenzas and Stacking Storage)	SH1818A	\$ 255	\$ 289	\$ 315
24"W x 18"D – use with K □ 242418A, K □ 282418A, K □ C272418A, K □ C352418A, K □ C422418A (24"H & 28"H Credenzas and Stacking Storage)	SH2418A	\$ 265	\$ 299	\$ 325
30"W x 18"D – use with K □ 243018A, K □ 283018A (24"H & 28"H Credenzas)	SH3018A	\$ 277	\$ 311	\$ 337
36"W x 18"D – use with K □ 243618A, K □ 283618A, (24"H & 28"H Credenzas)	SH3618A	\$ 290	\$ 324	\$ 350
48"W x 18"D – use with K □ 284818DA, K □ 424818A (28"H & 42"H Credenza)	SH4818A	\$ 312	\$ 346	\$ 372
60"W x 18"D – use with K □ 286018DA (28"H Credenza)	SH6018A	\$ 335	\$ 369	\$ 395
18"W x 24"D – use with K □ 241824A, K □ 281824A (28"H Credenza)	SH1824A	\$ 256	\$ 290	\$ 316
24"W x 24"D – use with K □ 242424A, K □ 282424A (28"H Credenza)	SH2424A	\$ 290	\$ 324	\$ 350
30"W x 24"D – use with K □ 243024A, K □ 283024A (28"H Credenza)	SH3024A	\$ 302	\$ 336	\$ 362
36"W x 24"D – use with K □ 243624A, K □ 283624A (28"H Credenza)	SH3624A	\$ 312	\$ 346	\$ 372

Involve Tower Shelving

	Side Access	Shelf Model	Example of Model
Type	18"D	SH1818A	KLST502418LFF
	24"D	SH2418A	KLST572424RBBF
	Hinged Door (w/drawers)		
	All	SH1824	KLT502424LBBF
	Full Width Hinged Door		
	12"W x 18"D	SH1218	KLT421218L
	12"W x 24"D	SH1224	KLT421224R
	18"W x 24"D	SH1824	KLT651824R
	24"W x 24"D	SH2424	KLT722424L

How to specify —
Select the Model Number from above.

1st Option:
Paint Color:
P1
P2
P3
 See page 250 for finishes.
 No upcharge for PR6.

Example: SH1818.P7B



Notes

INVOLVE

Involve® Laminate Wood Storage

11"H Seating Bases and Tables

For specification information see pages 260-268.

GSA SIN PENDING

Description	Solid Color "KL" (Feet +\$100) or "KLP" (Plinth); Or prefix for Woodgrain or Two-Tone "K2T" (Feet +\$100) or "K2TP" (Plinth) Model	Lock Qty	L1 Laminate List Price	UPCHARGES*			
				L2 Laminate Case	Front	L3 Laminate Case	Front
11"H Seat Base with Drawer (finished back; without top)							
24"W x 24"D	K □ B112424F		\$ 2522	\$ 52	\$ 27	\$ 107	\$ 46
36"W x 24"D (shown)	K □ B113624F		\$ 2942	\$ 61	\$ 30	\$ 124	\$ 54
48"W x 24"D 2 Drawers	K □ B114824F		\$ 3364	\$ 73	\$ 34	\$ 146	\$ 61
11"H Seat Base Open (finished back; without top)							
24"W x 24"D	K □ B112424A		\$ 2367	\$ 58		\$ 117	
36"W x 24"D (shown)	K □ B113624A		\$ 2764	\$ 66		\$ 134	
48"W x 24"D	K □ B114824A		\$ 3152	\$ 78		\$ 156	
Tops for 11"H Seat Base — 24"D							
12"W	KLTT111224		\$ 293	\$ 15		\$ 25	
24"W	KLTT112424		\$ 313	\$ 16		\$ 27	
36"W (shown)	KLTT113624		\$ 377	\$ 17		\$ 30	
48"W	KLTT114824		\$ 395	\$ 18		\$ 31	
24"W with Power Cutout	KLTT112424P		\$ 354	\$ 17		\$ 29	
11"H Low Open Table (with top)							
36"W x 18"D	K □ 113618A		\$ 2750	\$ 64		\$ 131	
48"W x 18"D	K □ 114818A		\$ 2967	\$ 70		\$ 140	
36"W x 24"D (shown)	K □ 113624A		\$ 2862	\$ 66		\$ 135	
48"W x 24"D	K □ 114824A		\$ 3087	\$ 72		\$ 144	
17½"H Corner Table (closed; with top)							
24"W x 24"D	K □ 172424CT		\$ 2398	\$ 55		\$ 109	

*Upcharges are added to laminate list price depending on woodgrain laminate selection.

Description	Model	P1 Paint List Price	P2 Paint List Price
Soft Seating Panel Stabilizer Bracket — Painted Metal			
5"H Left Side/Back (shown)	K605LSSPK	\$ 154	\$ 174
5"H Right Side/Back	K605RSSPK	\$ 154	\$ 174

How to specify — Select the Model Number from above. KL Feet / Solid Color KLP Plinth/ Solid Color K2T Feet / Woodgrain or Two-Tone K2TP Plinth / Woodgrain or Two-Tone K	1st Option: Foot Type (if applicable): TF Terrace Foot ZF Stride Foot (Add \$29) 	2nd Option: Foot or Bracket Paint Color (if applicable): P1 P2 See page 250 for finishes. Stride foot color is limited to PR6 Silver. P	3rd Option: FSC Certified Wood (if applicable): FSC Select for FSC Certified Wood X No FSC 	4th Option: Laminate Color (if applicable): See page 250 for finishes. (If two-tone list case color here.)
---	---	--	---	---

Continued below ▼

5th Option: Matching Edge (if applicable): See page 250 for finishes. 	6th Option: 2nd Laminate Color (Front) (if applicable): See page 250 for finishes. 	7th Option: Matching Edge (if applicable): See page 250 for finishes.
---	--	---

Examples: K2TB112424F.TFPJW.X.LWCWEDCW.LWCWEDCW K605LSSPK.P7B

Involve® Laminate Wood Storage

72½"H Towers

For specification information see pages 260-268.

GSA SIN PENDING

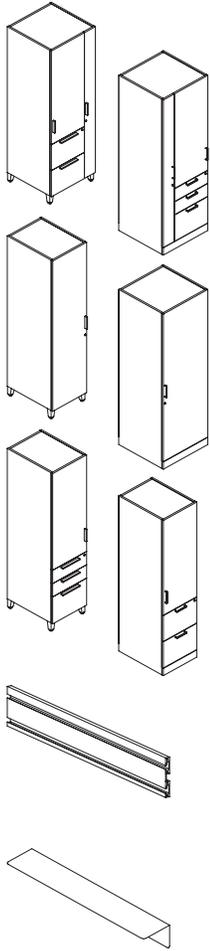

Description	Solid Color "KL" (Feet +\$100) or "KLP" (Plinth); Or prefix for Woodgrain or Two-Tone "K2T" (Feet +\$100) or "K2TP" (Plinth) Model	Lock Qty	L1 Laminate List Price	UPCHARGES*				
				L2 Laminate Case Front		L3 Laminate Case Front		
72½"H Personal Towers — 24"W x 24"D								
Wardrobe Right / Hgd Door/File/File	K □ T722424RFF	2	\$ 5835	\$ 137	\$ 137	\$ 281	\$ 281	
Wardrobe Left / Hgd Door/File/File	K □ T722424LFF	2	\$ 5835	\$ 137	\$ 137	\$ 281	\$ 281	
Wardrobe Right / Hgd Dr/Box/Box/File	K □ T722424RBBF	2	\$ 6443	\$ 156	\$ 65	\$ 311	\$ 311	
Wardrobe Left / Hgd Dr/Box/Box/File	K □ T722424LBBF	2	\$ 6443	\$ 156	\$ 65	\$ 311	\$ 311	
72½"H Personal Towers — 24"W x 24"D								
Right Hinged Door, 2 Adj. Shelves	K □ T722424R	1	\$ 3688	\$ 85	\$ 41	\$ 178	\$ 77	
Left Hinged Door, 2 Adj. Shelves	K □ T722424L	1	\$ 3688	\$ 85	\$ 41	\$ 178	\$ 77	
72½"H Personal Towers — 18"W x 24"D								
Right Hinged Door, 2 Adj. Shelves	K □ T721824R	1	\$ 3455	\$ 82	\$ 38	\$ 166	\$ 70	
Left Hinged Door, 2 Adj. Shelves	K □ T721824L	1	\$ 3455	\$ 82	\$ 38	\$ 166	\$ 70	
72½"H Personal Hinged Door Towers — 18"W x 24"D								
RH Hinged Door/File/File (shown)	K □ T721824RFF	1	\$ 5434	\$ 129	\$ 55	\$ 262	\$ 111	
LH Hinged Door/File/File	K □ T721824LFF	1	\$ 5434	\$ 129	\$ 55	\$ 262	\$ 111	
RH Hinged Door/Box/Box/File	K □ T721824RBBF	1	\$ 5621	\$ 132	\$ 57	\$ 271	\$ 116	
LH Hinged Door/Box/Box/File	K □ T721824LBBF	1	\$ 5621	\$ 132	\$ 57	\$ 271	\$ 116	

*Upcharges are added to laminate list price depending on woodgrain laminate selection.

Tower Rail (supports worksurface on side of tower — requires rail bracket kit)			
18"W Tower Rail for 18"D Tower	K6TR18	1	\$ 199

P2 paint upcharge \$12 (except PR6)

"L" Tower Bracket — for Wood Towers			
"L" Tower Bracket for 18"D or 24"D Tower			
	Z6LB		\$ 82

P2 paint upcharge \$20 (except PR6)

Shippable by small-package carrier.

How to specify — Select the Model Number from above. KL Feet / Solid Color KLP Plinth/ Solid Color K2T Feet / Woodgrain or Two-Tone K2TP Plinth / Woodgrain or Two-Tone	1st Option: Foot Type (if applicable): TF Terrace Foot ZF Stride Foot (Add \$29)	2nd Option: Foot, Rail, or Bracket Paint Color (if applicable): P1 P2 See page 250 for finishes. Stride foot is limited to PR6 Silver. Add \$12 for P2 Paint on rail or bracket (except PR6).	3rd Option: Pull Type (if applicable): MP Beam OP Halo SP Square AP Arch See matrix on page 21.	4th Option: Pull Color (if applicable): MP Beam / OP Halo PJW Designer White PR6 Silver PJE Pyrite P8X Solar Black P2 upcharge +\$18/pull	SP Square PJW Designer White EL Matte Silver P02 Flint P7B Loft PJE Pyrite P8X Solar Black AP Arch PRO Anodized Silver P2 upcharge +\$18/pull
	K		P		

Continued below ▼

5th Option: Metal Shelf Color (if applicable): P1 P2 P3 See page 250 for finishes. Add \$34 for P2 (except PR6) or \$60 for P3 Paints.	6th Option: FSC Certified Wood (if applicable): FSC Select for FSC Certified Wood X No FSC	7th Option: Laminate Color (if applicable): See page 250 for finishes. (If two-tone list case color here.)	8th Option: Matching Edge (if applicable): See page 250 for finishes.	9th Option: 2nd Laminate Color (Front) (if applicable): See page 250 for finishes.	10th Option: Matching Edge (if applicable): See page 250 for finishes.	11th Option: Lock Option (if applicable): STD Standard OMT Omit Lock Core (deduct \$20 per lock)	12th Option: Lock Color (if applicable): EL Silver
							E L

Examples: K2TT721824RFF.TFPJW.APPR6.P7D.X.LWCWEDCW.LWCWEDCW.STDEL

Involve® Laminate Wood Storage

Stanchions

For specification information see pages 260-268.

GSA SIN PENDING

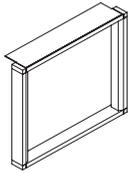

Description	Model	P1 Paint List Price	P2 Paint List Price	P3 Paint List Price
Overhead Stanchions — painted metal for use with 24"H credenzas				
11"H x 15"D Non-handed	K6OLG1115L S	\$ 468	\$ 502	\$ 535
11"H x 18"D Non-handed	K6OLG1118L S	\$ 482	\$ 516	\$ 552
11"H x 7½"D Mid	K6OLG1107 S	\$ 472	\$ 506	\$ 540
18"H x 15"D Non-handed	K6OLG1815L S	\$ 486	\$ 522	\$ 557
18"H x 7½"D Mid	K6OLG1807 S	\$ 486	\$ 522	\$ 557

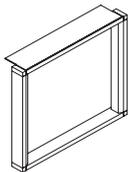

Overhead Stanchions — painted metal for use with 28"H credenzas				
5"H x 15"D Non-handed	K6OLG515L S	\$ 455	\$ 488	\$ 521
5"H x 18"D Non-handed	K6OLG518L S	\$ 570	\$ 612	\$ 652
12"H x 15"D Non-handed	K6OLG1215L S	\$ 579	\$ 622	\$ 662
12"H x 18"D Non-handed	K6OLG1218L S	\$ 596	\$ 640	\$ 682
12"H x 7½"D Mid	K6OLG1207 S	\$ 472	\$ 506	\$ 540
19¼"H x 15"D Non-handed	K6OLG1915L S	\$ 602	\$ 646	\$ 688
19¼"H x 7½"D Mid	K6OLG1907 S	\$ 486	\$ 522	\$ 557

Note: No upcharge for PR6 Silver paint on Involve.

Description	Model	P1 Paint List Price	P2 Paint List Price	P3 Paint List Price
Tower-to-Overhead Bracket — for use with wood overhead cabinets				
Attachment Bracket	K6TBK S	\$ 147	\$ 167	\$ 183

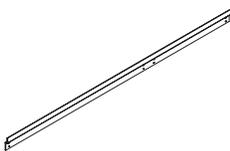

Description	Model	List Price
Horizontal Wall-Mount Brackets — for use with wood overhead cabinets		
24"W	YWC24Z S	\$ 122
30"W	YWC30Z S	\$ 141
36"W	YWC36Z S	\$ 153
42"W	YWC42Z S	\$ 173
48"W	YWC48Z S	\$ 189
60"W	YWC60Z S	\$ 232



Undercabinet LED Lights (white end caps)		
17" Undercabinet LED Tasklight	ALED17U S	\$ 1045
31" Undercabinet LED Tasklight	ALED31U S	\$ 1568

Additional LED components available, see Frame and Tile Panel Systems price list.

How to specify —
Select the
Model Number
from above.

1st Option:

Paint
(if applicable):

P1 P2 P3

See page 250 for
finishes.

Note: No upcharge
for PR6 Silver paint
on Involve.

Examples: K6O518L.P7B YWC24Z ALED17U

S Shippable by small-package carrier.

Involve® Laminate Wood Storage

Overhead Backs

For specification information see pages 260-268. Woodgrain laminate not available on 72"W-96"W.

GSA SIN PENDING



Description	Model	L1 Laminate List Price	UPCHARGES*	
			L2 Laminate	L3 Laminate
Finished Backs for Overheads — 15"H for use in single-sided applications				
30"W	KLBP1530 <input type="checkbox"/>	\$ 1332	\$ 45	\$ 89
36"W	KLBP1536 <input type="checkbox"/>	\$ 1339	\$ 46	\$ 90
42"W	KLBP1542 <input type="checkbox"/>	\$ 1375	\$ 46	\$ 92
48"W	KLBP1548 <input type="checkbox"/>	\$ 1383	\$ 47	\$ 93
60"W	KLBP1560 <input type="checkbox"/>	\$ 1466	\$ 48	\$ 96
72"W	KLBP1572	\$ 1670	N/A	N/A
84"W	KLBP1584	\$ 1934	N/A	N/A
96"W	KLBP1596	\$ 2163	N/A	N/A

INVOLVE

<p>How to specify — Select the Model Number from above.</p>	<p><i>1st Option:</i> Laminate Color for Overhead Finished Back (if applicable): See page 250 for finishes.</p>	<p><i>2nd Option:</i> Matching Laminate Edge for Overhead Finished Back (if applicable): See page 250 for finishes.</p>
--	--	--

Example: KLBP1530.LM15EU

Shippable by small-package carrier.

Involve® Laminate Wood Storage

Tackboards

For specification information see pages 260-268. Woodgrain laminate not available on 72"W-96"W.

GSA SIN PENDING

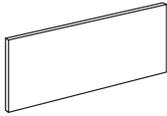

Description	Model	List Price				
		Grade A	Grade B	Grade C	Grade D	Grade E
Tackboards for 35"H Hutches						
48"W	K6TB3548T (shown)	\$ 772	\$ 844	\$ 915	\$ 1032	\$ 1151
60"W	K6TB3560T	\$ 871	\$ 961	\$ 1050	\$ 1197	\$ 1344
66"W	K6TB3566T	\$ 897	\$ 995	\$ 1092	\$ 1254	\$ 1417
72"W	K6TB3572T	\$ 1000	\$ 1108	\$ 1214	\$ 1391	\$ 1567
84"W	K6TB3584T	\$ 1151	\$ 1275	\$ 1399	\$ 1606	\$ 1812
Tackboards for 42½"H Hutches						
48"W	K6TB4248T (shown)	\$ 851	\$ 937	\$ 1024	\$ 1167	\$ 1310
60"W	K6TB4260T	\$ 958	\$ 1067	\$ 1175	\$ 1353	\$ 1532
66"W	K6TB4266T	\$ 988	\$ 1107	\$ 1225	\$ 1422	\$ 1620
72"W	K6TB4272T	\$ 1100	\$ 1230	\$ 1359	\$ 1573	\$ 1789
84"W	K6TB4284T	\$ 1206	\$ 1358	\$ 1508	\$ 1759	\$ 2009

*Upcharges are added to solid laminate list price depending on woodgrain laminate selection.

INVOLVE

<p>How to specify — Select the Model Number from above.</p>	<p>1st Option: Paint Color for Tackboard Frame (if applicable):</p> <p>P1 P2 P3</p> <p>See page 250 for finishes. P2 paint upcharge \$33 (except PR6). P3 paint upcharge \$64.</p>	<p>2nd Option: Panel Fabric for Hutch Tackboard (if applicable):</p> <p>See page 250 for finishes.</p>
--	---	--

Example: K6TB3548T.P02.APN917

S Shippable by small-package carrier.

For specification information see pages 269-270. For additional worksurface sizes reference the Stride® or Terrace® worksurface sections. For non-standard worksurface sizes see 9120 Program in any Systems price book.

Veneer/Laminate
GSA SIN PENDING

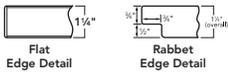

Description	Laminate w/Flat Edge Model	Laminate w/Flat Edge		
		L1 List Price	L2 List Price	L3 List Price
Primary Worksurfaces — specify grommet location				
72"W x 18"D	T51872CS	\$ 781	\$ 814	\$ 839
84"W x 18"D	T51884CS	\$ 1067	\$ 1109	\$ 1146
72"W x 24"D	T52472CS	\$ 847	\$ 881	\$ 911
84"W x 24"D	T52484CS	\$ 1164	\$ 1209	\$ 1250
72"W x 30"D	T53072CS	\$ 960	\$ 998	\$ 1032
84"W x 30"D	T53084CS	\$ 1288	\$ 1336	\$ 1383



30" D / 36" D EZ View Transition Worksurfaces (non-handed)				
30"D x 60"W x 36"D	K5306036EZ	\$ 1480	\$ 1534	\$ 1591
30"D x 72"W x 36"D	K5307236EZ	\$ 1733	\$ 1795	\$ 1861
30"D x 78"W x 36"D	K5307836EZ	\$ 2078	\$ 2155	\$ 2234

Notes: 1) Add Suffix "N" to a model number for no grommets, no upcharge. *Examples:* K5306036EZN, K5307836EZN



Top View

<p>How to specify — Select the Model Number from above.</p>	<p>1st Option: Laminate: See page 250 for finishes. (Upcharges are listed above.)</p>	<p>2nd Option: Laminate Edge Color (if applicable): See page 250 for finishes.</p>	<p>3rd Option: Grommet Location (if applicable): GC Center GCL Center and Left GCR Center and Right GCRL Center, Right, and Left</p>	<p>4th Option: Grommet Type: P Oval Plastic (Will match edge trim on laminate) M Oval Metal (Add \$12 per grommet) S Square Metal (Add \$12 per grommet)</p>	<p>5th Option: Grommet Color (Metal only): EL Matte Silver Additional Oval Veneer Colors: EZ Bronze E4 Black</p>
--	---	--	--	--	--

Examples: T51872CS.LM15EU.GCP K5306036EZ.LM13.EY.P

For specification information see pages 269-270.

GSA SIN 33721

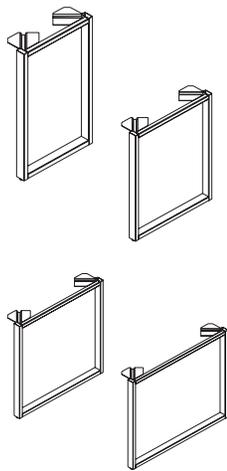

Description	Model	P1 Paint List Price	P2 Paint List Price	P3 Paint List Price
29½"H Open End Panel Supports — Painted Metal				
18"D Freestanding for Flat/Square Edge	K62918OLG	\$ 826	\$ 891	\$ 955
24"D Freestanding for Flat/Square Edge (shown)	K62924OLG	\$ 894	\$ 965	\$ 1034
30"D Freestanding for Flat/Square Edge	K62930OLG	\$ 959	\$ 1034	\$ 1108
<hr/>				
18"D Panel-Mount for Flat/Square Edge	K62918OLG	\$ 826	\$ 891	N/A
24"D Panel-Mount for Flat/Square Edge (shown)	K62924OLG	\$ 894	\$ 965	N/A
30"D Panel-Mount for Flat/Square Edge	K62930OLG	\$ 959	\$ 1034	N/A
36"D Panel-Mount for Flat/Square Edge	K62936OLG	\$ 1026	\$ 1107	\$ 1186

NOTE: No upcharge for PR6 Silver paint on Involve.

Use of a panel-mounting bracket from page 301 can change the O-Leg from freestanding to panel-mounted.

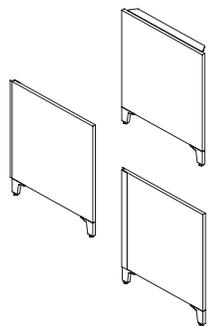

Description	Model	L1 Laminate List Price	L2 Laminate List Price	L3 Laminate List Price
29½"H Closed End Panel Supports — Laminate with Metal Brackets				
18"D Freestanding for Flat/Square Edge	K62918FEN	\$ 1000	\$ 1040	\$ 1075
24"D Freestanding for Flat/Square Edge (shown)	K62924FEN	\$ 1039	\$ 1080	\$ 1117
30"D Freestanding for Flat/Square Edge	K62930FEN	\$ 1086	\$ 1128	\$ 1166
18"D Panel-Mount for Flat/Square Edge — Left	K62918LPEN	\$ 1083	\$ 1125	\$ 1163
18"D Panel-Mount for Flat/Square Edge — Right	K62918RPEN	\$ 1083	\$ 1125	\$ 1163
24"D Panel-Mount for Flat/Square Edge (shown) — Left	K62924LPEN	\$ 1121	\$ 1164	\$ 1203
24"D Panel-Mount for Flat/Square Edge (shown) — Right	K62924RPEN	\$ 1121	\$ 1164	\$ 1203
30"D Panel-Mount for Flat/Square Edge — Left	K62930LPEN	\$ 1154	\$ 1198	\$ 1240
30"D Panel-Mount for Flat/Square Edge — Right	K62930RPEN	\$ 1154	\$ 1198	\$ 1240



Description	Model	P1 Paint List Price	P2 Paint List Price
Storage-to-Panel Bracket Kits for 24"H and 28"H Credenzas only — Painted Metal			
24"H Left (requires laminate back) (shown)	K624PBKL	\$ 183	\$ 203
24"H Right (requires laminate back)	K624PBKR	\$ 183	\$ 203
28"H Left (requires laminate back)	K630PBKL	\$ 201	\$ 221
28"H Right (requires laminate back)	K630PBKR	\$ 201	\$ 221
<hr/>			
24"H Left (does not require laminate back)	K624PBKML	\$ 183	\$ 203
24"H Right (does not require laminate back)	K624PBKMR	\$ 183	\$ 203
28"H Left (does not require laminate back)	K630PBKML	\$ 201	\$ 221
28"H Right (does not require laminate back)	K630PBKMR	\$ 201	\$ 221

INVOLVE

<p>How to specify — Select the Model Number from above.</p>	<p>1st Option: FSC Certified Wood (if applicable): FSC Select for FSC Certified Wood X No FSC</p>	<p>2nd Option: Laminate (if applicable): See page 250 for finishes.</p>	<p>3rd Option: Edge Color (if applicable): See page 250 for finishes.</p>	<p>4th Option: Paint: P1 P2 P3 See page 250 for finishes. For P2 Paints (except PR6) on Closed End Panel Supports add \$33.</p>
--	--	--	--	---

Examples: K62918OLG.P7B K624PBKR.P7B K62918LPEN.X.LM11EV.P7B

For specification information see pages 269-270.

GSA SIN PENDING

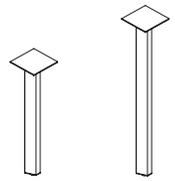

Description	Model	P1 Paint List Price	P2 Paint List Price	P3 Paint List Price
Post Leg — Painted Metal				
29½"H	K629SCF	\$ 431	\$ 461	N/A
40½"H	K640SCF	\$ 518	\$ 548	N/A

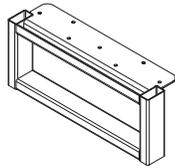

Worksurface Stanchion — Painted Metal (See below for replacement models.)				
12"D x 5¼"H for Involve 24"H Credenza	K6OLG0512	\$ 552	\$ 593	\$ 632
18"D x 5¼"H for Involve 24"H Credenza	K6OLG0518	\$ 567	\$ 609	\$ 649
12"D x 4"H for Stride 22"H Credenza	APOLG0512	\$ 416	\$ 445	\$ 468
18"D x 4"H for Stride 22"H Credenza	APOLG0518	\$ 453	\$ 482	\$ 505

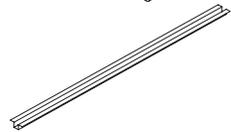

External Worksurface Support Channel (Black Only)				
30"W for use on 42"W Worksurface	Z5SC42	\$ 86	N/A	N/A
36"W for use on 48"W Worksurface	Z5SC48	\$ 89	N/A	N/A
42"W for use on 54"W Worksurface	Z5SC54	\$ 102	N/A	N/A
48"W for use on 60"W Worksurface	Z5SC60	\$ 110	N/A	N/A
54"W for use on 66"W Worksurface	Z5SC66	\$ 128	N/A	N/A
60"W for use on 72"W Worksurface	Z5SC72	\$ 137	N/A	N/A
66"W for use on 78"W Worksurface	Z5SC78	\$ 150	N/A	N/A

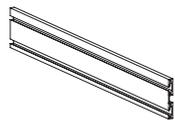

Tower Rail (supports worksurface on side of tower — requires rail bracket kit)				
18"W Tower Rail for 18"D Tower	K6TR18	\$ 199	\$ 211	N/A

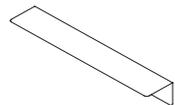

"L" Tower Bracket — for Wood Towers				
"L" Tower Bracket for 18"D or 24"D Tower	Z6LB	\$ 82	\$ 102	N/A

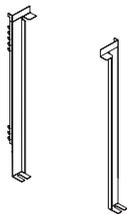

Panel-Mount Brackets for O-Leg-to-Panel Attachment Bracket				
Left-Handed O-Leg to Panel Bracket	KOLGBRKLFT	\$ 199	\$ 214	\$ 228
Right-Handed O-Leg to Panel Bracket	KOLGBRKRGT	\$ 199	\$ 214	\$ 228

How to specify —
Select the Model Number from above.

1st Option:

Paint
(if applicable):

P1 P2 P3

See page 250 for finishes.

No upcharge for PR6 Silver paint on Involve.

Examples: K629SCF.P7B Z5SC60

S Shippable by small-package carrier.

For specification information see page 272.

GSA SIN PENDING

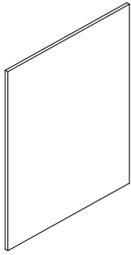

Description	Model	L1 Laminate List Price	L2 Laminate List Price	L3 Laminate List Price
50"H Laminate Divider Panel — ¼" Thick				
29"W	K6DP5029L	\$ 1088	\$ 1130	\$ 1169
35"W	K6DP5035L	\$ 1184	\$ 1229	\$ 1273
47"W	K6DP5047L	\$ 1289	\$ 1336	\$ 1384
59"W	K6DP5059L	\$ 1383	\$ 1435	\$ 1488

<p>How to specify — Select the Divider Panel Model Number from above.</p>	<p>1st Option: FSC Certified Wood: FSC Select for FSC Certified Wood X No FSC</p>	<p>2nd Option: Laminate Color: See page 250 for finishes.</p>	<p>3rd Option: Matching Edge: See page 250 for finishes.</p>
--	---	---	--

Example: K6DP5029L.X.LM11EV

Finishes 306
Statement of Line 307
Working with Storage 308-309
Pedestals and Credenzas..... 310
Storage Towers..... 311
Credenzas..... 312-313



PAINT FINISHES

GRADE P1

Black.....	P27
Brownstone.....	P7D
Bungalow.....	P7C
Cinder.....	P7Q
Cove.....	P096
Designer White.....	PJW
Dune.....	P094
Flint.....	P02
Fossil.....	P28
Harbor.....	P097
Loft.....	P7B
Muslin.....	P4J
Parchment.....	P93
Pebble.....	P8R
Pewter.....	P8D
Sage.....	P095
Salt.....	P8C
Titanium.....	P8T

GRADE P2

Champagne Metallic.....	PR5
Gunmetal Metallic.....	PR3
Night Bronze.....	P8B
Platinum Metallic.....	PR2
Pyrite.....	PJE
Silver.....	PR6
Solar Black.....	P8X

GRADE P3

Atom.....	P8S
Blossom***.....	P8K
Bullseye.....	PJF
Ember.....	P8P
Ion.....	P8N
Iris.....	P8J
Krypton.....	P8F
Ochre.....	P093
Regatta.....	P8M
Sienna.....	P092
Succulent***.....	P8A

***These colors are intended to be an inspirational option for the trending market. Product application is limited and color availability is approximately two years to coincide with evolving workplace trends.

Metallic paints, due to varying reflectance, may appear to have less visual color consistency than other paint finishes, even when L/A/B values are exactly the same. (L/A/B — measurable aspects of color — values are maintained within a specified range, to ensure consistent appearance of paint colors.)

ELECTRICAL AND DATA COMPONENTS

Black.....	E4
Brownstone.....	EY
Designer White.....	DW
Flint.....	E9
Loft.....	EV
Muslin.....	EU
Silver.....	ES

Recommended Coordinate Colors:
 Bungalow use Muslin EU
 Carob use Black E4
 Champagne Metallic use Muslin EU
 Cinder use Brownstone EY
 Fossil use Flint E9
 Gunmetal Metallic use Brownstone EY
 Parchment use Muslin EU
 Pebble use Loft EV
 Pewter use Flint E9
 Platinum Metallic use Silver ES
 Salt use Silver ES
 Titanium use Silver ES

LAMINATES

GRADE L1

SOLID COLORS	
Black.....	P
Brownstone.....	LM13
Bungalow.....	LM12
Designer White.....	LDW1
Flint.....	LM16
Fossil Shale.....	LEH1
Loft.....	LM11
Muslin.....	LM15
Titanium.....	LTI1
ABSTRACT	
Ash.....	LT3B
Handspun Pearl.....	LAHP
Handspun Dove.....	LAHD
Handspun Slate.....	LAHS
Handspun Chestnut.....	LAHC
Silver Mesh.....	LT8D

WOODGRAIN

Belair.....	LWBA
Bourbon Cherry.....	H
Field Elm.....	LWFE
Florence Walnut.....	LFW1
Kingswood Walnut.....	LK11
Natural Maple.....	LWD
NeoWalnut.....	LNU1
Pinnacle.....	PINC
Shaker Cherry.....	LW7C

GRADE L2

Beigewood.....	LWBE
Fawn Cypress.....	LFC1
Lowell Ash.....	LLA1
Mangalore Mango.....	LMM1
Natural Recon.....	LNR1
Phantom Charcoal.....	LPC1
Phantom Ecu.....	LPE1
Portico Teak.....	LPT1
Skyline Walnut.....	LSW1
Veranda Teak.....	LVT1

GRADE L3

Natural Walnut.....	LWNW
---------------------	------

All laminate surfaces are also offered with the FSC wood option. Add FSC in front of each laminate option. Refer to specification tools.

LAMINATE EDGE COLORS

Beigewood.....	DE
Belair.....	BA
Black.....	E4
Bourbon Cherry.....	H
Brownstone.....	EY
Bungalow.....	EX
Designer White.....	DW
Fawn Cypress.....	FC
Field Elm.....	FE
Flint.....	E9
Florence Walnut.....	FW
Fossil.....	EH
Kingswood Walnut.....	KI
Loft.....	EV
Lowell Ash.....	DL
Mangalore Mango.....	MM
Muslin.....	EU
Natural Maple.....	DD
Natural Recon.....	NR
Natural Walnut.....	DN
NeoWalnut.....	NU
Parchment.....	EN
Phantom Charcoal.....	PC
Phantom Ecu.....	PE
Pinnacle.....	PI
Platinum Metallic.....	EP
Plyband ♦.....	PL
Portico Teak.....	DP
Shaker Cherry.....	DF
Skyline Walnut.....	SW
Veranda Teak.....	VT

♦ Edge is limited to flat edge surfaces: rectangle, square, trapezoid, polygon, or round. No curvilinear or combination curve and straight.

NOTE: Refer to individual product pages for upcharges.

FSC Certified Wood at Allsteel
 See page 336 for more information.

STORAGE

Floor Based — Laminate with Metal

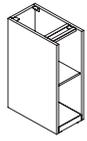

Open Support
Pedestal

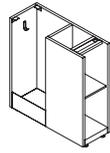

Open w/Bin
Pedestal

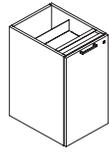

Pull Out Drawer
Support Pedestal

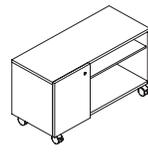

Mobile Credenza

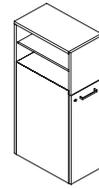

42½"H Tower

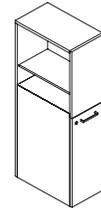

50"H Tower

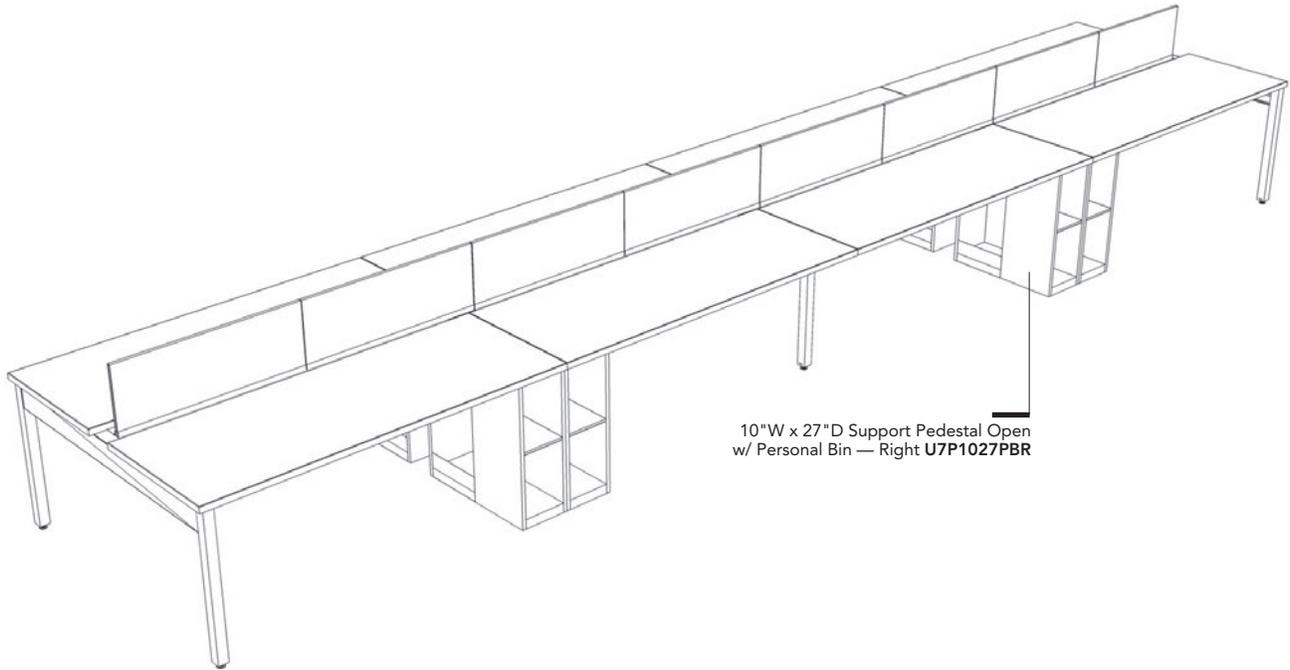

10"W x 27"D Support Pedestal Open w/ Personal Bin — Right U7P1027PBR

All Storage

- All storage is made from ¾" thick with particleboard core with top and bottom surfaces finished in laminate. Horizontal storage sides and back are painted steel.
- Edge band is made of 1mm thick ABS plastic — flat edge trim only.
- Cam and pin construction. Storage is plinth base only unless unit is mobile.
- Available in solid and woodgrain laminates, models with doors or drawers are available with a two-tone option.
- Pull options: arch, square, linear, straight. All standard in PR6 Silver.
- Locks have a silver finish.

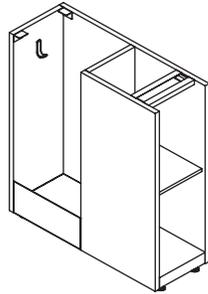

U7P1027PBR

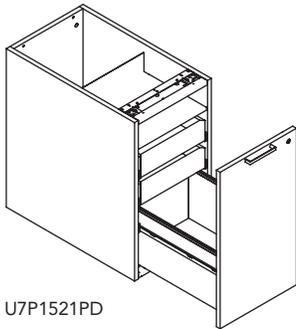

U7P1521PD

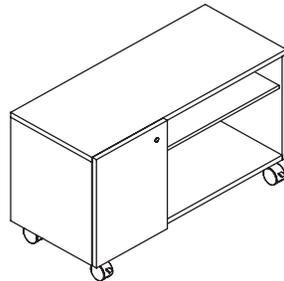

U7MC203615HL

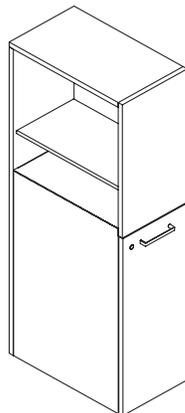

U7T501221ADR

Open Support Pedestals (page 310)

- Constructed of laminate, shelves are painted steel.
- Open Support Pedestals may be used to add additional stability — see Further Stability Requirements in the Desking & Benching Price List on page 78.
- Support pedestals may be used to create freestanding desks, storage depth must match worksurface depth.
- 27" D models have a coat/bag hook located in back of unit.

Pull-Out Drawer Support Pedestal (page 310)

- Case is constructed of laminate and painted steel.
- Box and file drawers are miter fold, 1/2" thick particle board, polypropylene wrapped.
- Configuration is box/box/file and one shelf at top of unit.
- Shelf is not adjustable but can be removed.
- All drawers hidden behind single laminate front.
- Straight, linear, arch and square pulls available as options.
- 1/8" leveling.
- Cannot be used as a freestanding, standalone unit.
- Outside overall dimensions: 15 1/2" W and 21" or 27" D
- Box drawers extend 16" for both model depths.
- File drawers extend 16" on 21" D models and 20" on 27" D models.
- Front to back filing, standard letter size
- One lock, located in upper right hand corner of drawer front.
- Two-tone laminate option for drawer fronts
- Can be used to make a freestanding desk.

Mobile Credenza (page 310)

- Constructed of laminate, shelf is painted steel.
- Mobile credenza has a hinged door with lock, no pull.
- Front casters are locking, back casters are non-locking.

Side Access Towers (page 311)

- Top and sides are laminate, shelves are painted steel.
- Side Access Towers may be used to add additional stability — see Further Stability Requirements in the Desking & Benching Price List on page 78.
- 12" wide towers must be attached to a worksurface.
- Z6LB tower "L" bracket required when supporting a worksurface with a tower — storage depth must match worksurface depth.
- Tower drawers do not extend fully — 27" D towers have a 25" D drawer with 20" travel slides; 21" D towers have a 19" D drawer with 16" travel slides.
- 27" D models have a coat/bag hook located in back of drawer.

"L" Tower Bracket (page 311)

- Z6LB tower "L" bracket required when supporting a worksurface with a tower.
- Storage depth must match worksurface depth.

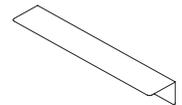

Storage

Further™ — Side Access Towers

For specification information see pages 308-309.

Laminate

GSA SIN 33721

Description	Model	List Price		
		L1	L2	L3
42½"H Side Access Towers — 12"W				
27"D w/Left Hand Side Access	U7T421227ADL <input type="checkbox"/>	\$ 4219	\$ 4365	\$ 4512
27"D w/Right Hand Side Access	U7T421227ADR <input type="checkbox"/>	\$ 4219	\$ 4365	\$ 4512

Description	Model	List Price		
		L1	L2	L3
50"H Side Access Towers — 12"W				
21"D w/Left Hand Side Access (shown)	U7T501221ADL <input type="checkbox"/>	\$ 4289	\$ 4437	\$ 4587
27"D w/Left Hand Side Access	U7T501227ADL <input type="checkbox"/>	\$ 4473	\$ 4628	\$ 4785
21"D w/Right Hand Side Access (shown)	U7T501221ADR <input type="checkbox"/>	\$ 4289	\$ 4437	\$ 4587
27"D w/Right Hand Side Access	U7T501227ADR <input type="checkbox"/>	\$ 4473	\$ 4628	\$ 4785

Description	Model	P1 Paint	P2 Paint
		List Price	List Price
"L" Tower Bracket — for Towers			
"L" Tower Bracket for 21"D or 27"D	Z6LB	\$ 82	\$ 102

How to specify — Select the Model Number from above.	1st Option: Pull Type (if applicable): MP Beam OP Halo SP Square AP Arch LP Linear See matrix on page 21.	2nd Option: Pull Color (if applicable): MP Beam / OP Halo PJW Designer White EL Matte Silver PR6 Silver PJE Pyrite P8X Solar Black P2 upcharge +\$18/pull	3rd Option: Metal Shelves Paint Color (if applicable): P1 P2 P3 Upcharge: P2 \$36 P3 \$83	4th Option: FSC Certified Wood (if applicable): FSC Select for FSC Certified Wood X No FSC
	_____ .	_____ .	_____ .	_____ .

Continued below ▼

5th Option: Laminate (if applicable): _____	6th Option: Matching Edge (if applicable): _____ .	7th Option: Door Laminate (if applicable): _____	8th Option: Matching Edge (if applicable): _____ .	9th Option: Lock Option (if applicable): STD Standard OMT Omit Lock Core (deduct \$20) _____	10th Option: Lock Color (if applicable): EL Silver E L
--	---	---	---	---	--

Examples: U7T501221ADL.LPPRO.LM11EV.LM11EV.STDEL Z6LB.PR6

Shippable by small-package carrier.

- 2- and 3-Bay credenzas ship fully assembled.
- Available in solid and woodgrain laminate colors. You can select one laminate for the case and a second laminate for the front doors and back panels. Credenza top including front edge is the same color as the case.
- Painted mesh in Designer White, Flint, or Silver at top and bottom of the front and back sides of unit provides passive ventilation.
- Edge guards on mesh and wire manager protects cords and fingers.
- Grommet models feature square Silver metal grommet.
- Six leveling glides on 72"W, four glides on 48"W. Leveling range is 1".
- Credenzas are constructed from ¾" thick high-pressure laminated particleboard with 1 mm edge banding and European cam-and-pin construction.
- Units are shipped with either lock cores removed or as non-locking. Core removable lock option allows key numbers to be easily changed in the field. Cores available on page 65. Note: Middle cabinet on 3-Bay units do not lock.
- Shelves are painted metal. Base shelves are secured, except center shelf in 72"W credenza.
- Interior bay dimensions are 22"W x 28½"H x 22⅜"D. Secured bottom shelves are 19"D to account for ventilation and wire management. Rated for 50 lbs.
- Removable back(s) snap on for easy component installation.
- Bottom wire management channel runs entire width of credenza.
- Optional top hung drawers (8½"H) use full extension slides; limit of one drawer per bay. Drawers cannot be used in same bay with AV rack, waste pullout, and will limit size of refrigerator.
- Slide out A/V storage rack features EIA spacing with twelve usable rack spaces.
- Units ship with one adjustable shelf per bay. Shelves are adjustable in 6" increments.
- Additional metal shelves are field-installed using supplied template, maximum of three per bay.

Description	Model	Ship Weight	Cubes	Solid Laminate List Price	UPCHARGES*			
					L2 Laminate Case Front/Back		L3 Laminate Case Front/Back	
Buffet Credenza — 34"H x 24"D								
72"W with Grommet / Removable Back Left and Right	AW4BC7224	336	56	\$ 9635	\$ 228	\$ 97	\$ 458	\$ 195
72"W no Grommet / Removable Back Left and Right	AW4BC7224NG	336	56	\$ 9624	\$ 228	\$ 97	\$ 458	\$ 195
48"W with Grommet /								
Removable Back Left (shown)	AW4BC4824L	235	38	\$ 7020	\$ 166	\$ 71	\$ 333	\$ 142
48"W no Grommet / Removable Back Left (shown)	AW4BC4824LNG	235	38	\$ 7008	\$ 166	\$ 71	\$ 333	\$ 142
48"W with Grommet /								
Removable Back Right	AW4BC4824R	235	38	\$ 7020	\$ 166	\$ 71	\$ 333	\$ 142
48"W no Grommet / Removable Back Right	AW4BC4824RNG	235	38	\$ 7008	\$ 166	\$ 71	\$ 333	\$ 142

Description	Model	Ship Weight	Cubes	List Price
Credenza Storage Drawer (Laminate front LM16 Flint only)				
Interior: 14½"W x 14¾"D x 2¾"H Particleboard body in a metal case	AW4DRAWER	30	4.1	\$ 915
Slide Out Audio/Visual Storage Rack (Black only, not specified) Weight capacity 125 lbs.				
19¾"W x 18¾"D x 22¾"H Metal frame with 10-32 threaded holes	AW4AVRACK	29	4.8	\$ 3314
Trash/Recycling Slide Out (Platinum only, not specified) Weight capacity 100 lbs.				
14¾"W x 22½"D x 18¾"H Comes with 2 – 35 qt bins	AW4TRASH	36	2.8	\$ 689
Metal Interior Shelf (Painted in Flint, Designer White, or Silver only)				
23"W x 21"D x 2"H Weight capacity 50 lbs.	AW4SHELF	5	1.6	\$ 246

How to specify — Select the Model Number from above.	1st Option: FSC Certified Wood (if applicable): FSC Certified X No FSC	2nd Option: Case Laminate (if applicable):	3rd Option: Matching Edge Color (if applicable):	4th Option: 2nd Laminate Color (Front) (if applicable):	5th Option: Matching Edge Color (if applicable):	6th Option: Paint Color (if applicable): PJW Designer White P02 Flint PR6 Silver (No upcharge for PR6)	7th Option: Lock (if applicable): OMT Omit Cores NL No Locks or Holes
AW4							

Examples: AW4BC7224.X.LM14EW.LWDDD.PR6.NL AW4DRAWER.LM16E9

Extensions — Introduction

Extensions accessory line by Allsteel is designed to help you create your own space.

- **Create a unique space**

Each person is unique, no one person works exactly like another, and different tasks require different tools. Extensions work tools allow each person the ability to create a unique environment that is all their own. Lots of paper to manage? Need active files within arm's reach? Want to maximize your worksurface space? Need light somewhere other than below a cabinet? Whatever the task, we have the tools to accommodate your workstyle.

- **Create a comfortable space**

With a full line of organization, ergonomic, and illumination tools, Extensions allow you to create a comfortable, ergonomic work area. Organization tools keep important items visible and within your reach. Ergonomic tools help you stay comfortable while working. Illumination tools allow you to put your light where it suits you.

- **Create an organized space**

Tired of all the piles of paper building up on your worksurface? Organization tools house your materials and keep them in an orderly fashion. With a combination of hanging or freestanding organizational accessories, Extensions let you manage everything from binders to paper clips.

- **Organization tools**

Work tools are a durable metal construction. Extensions allow you to manage your workspace smartly with tools like the phone caddy to elevate the phone off the worksurface, landscaped mail box trays to minimize worksurface intrusion, folder holders and tool box pencil holders that hang off the slat rail and each other.

Increase your efficiency with organization!

- **Ergonomic tools**

Ergonomics is more than just comfort, it's flexibility and safety. The adjustable keyboard options allow users to maintain and vary comfortable wrist and arm positions throughout the day, whether typing or mousing. Monitor Arms offer versatile adjustability while providing optimum comfort for the eyes, neck, and shoulders.

- **Illumination tools**

Sleek and flexible, our lighting components offer you several choices. Recessed task lights conserve space and feature electronic ballast for longer bulb life and cooler operating temperature. LED tasklights' slim design blends in with its surrounding while utilizing energy-efficient LED technology. The Link light offers award-winning style to a highly versatile and energy efficient light.

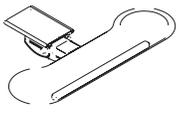
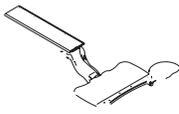
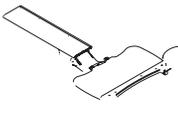
Articulating Keyboard Supports			
Features	Model AKTSHORT	Model AKTLONG	Model AKTMID
			
Keyboard Support	Platform style 28"W x 8"D	Platform Style 19"Wx11"D	Platform Style 19"Wx11"D
Keyboard Support Material	Phenolic	Phenolic	Phenolic
Suspension	<ul style="list-style-type: none"> Nylon glides on lubricated slide track Intuitive lift and lock one touch height adjustment 	Lubricated slide track system: spring assisted	Lubricated slide track system: spring assisted
Platform Rotation	360 degrees	360 degrees	360 degrees
Platform Tilt	+10/-20 degrees	+10/-20 degrees	+10/-20 degrees
Platform Tilt Adjustment	Soft touch lever for precise tilt adjustment	Convenient tilt wheel assists desired tilt angle	Convenient tilt wheel assists desired tilt angle
Platform Height Adjustment Range	6 1/2" (1 1/2" above / 5 1/4" below)	12 1/2" (7" above to 5 1/2" below)	8" (3" above / 5" below)
Platform Height Adjustment	Lift platform to raise, lift slightly and tilt back to lower	Lift platform to raise, lift slightly and tilt back to lower	Lift platform to raise, lift slightly and tilt back to lower
Palm Rest	Detachable leatherette-covered gel palm rest	Fabric covered gel palm rest	Fabric covered gel palm rest
Mouse Pad	In-line to accommodate mouse on same level as keyboard.	Circular, swivel, tilt, LH/RH mounting, mouse catcher, gel rest	Circular, swivel, tilt, LH/RH mounting, mouse catcher, gel rest
Microsoft Natural Compatible	No	Yes — by removing palm rest	Yes — by removing palm rest
Track Depth	8"	23"	21"
Required Mounting Clearance	20"W x 8"D x 1/4" Recess	19"W x 23"D + 1/4" Recess	19"W x 23"D + 1/4" Recess
Adjustable Wrist Rest	No	Fixed mounting and height	Fixed mounting and height
Ideal For	<ul style="list-style-type: none"> Straight worksurfaces ADA/HFES compliance Extensive adjustability with mouse in line, mouse over or mouse forward of keyboard Height-Adjustable Table 	<ul style="list-style-type: none"> Corner worksurface applications Sit to stand applications 	<ul style="list-style-type: none"> Shallow worksurfaces Corner worksurface (17" or 21") Radius worksurface (42" or 48")
Additional Information		<ul style="list-style-type: none"> Track can be cut in the field to shorten track depth — may affect ability to fully recess platform 	<ul style="list-style-type: none"> Track can be cut in the field to shorten track depth — may affect ability to fully recess platform

AKTSHORT Keyboard Support (page 316)

- Lift and lock intuitive height adjustment.
- Compatible with Altitude Height Adjustable Tables
- Positive and negative tilt for best ergonomic positioning.
- +10°/-20° tilt adjustment and 360° rotation provides support of neutral position of shoulders, arms and wrists while accommodating multiple working postures.
- Surpasses ANSI/BIFMA standards.
- Black powder coat finish.
- Patented secondary slide and unique arm design provide minimal footprint.



Keyboard Spacer Kit (page 316)

- Keyboard Spacer Kit required for mounting under Altitude worksurfaces.
- Kit provides ten spacers and hardware for mounting keyboard supports beneath an external worksurface support channel.
- Spacers are 2 1/8" H providing more room beneath surface for mounting.

CPU Hammock (page 316)

- Features 360-degree swivel with an 11" track.
- Load capacity is 75 lbs.
- CPU must be minimum of 3/4"W with maximum dimension of 64" in perimeter.
- Handy adjustment tool stores within unit.
- Safety feature prevents accidental release of straps and straps can be adjusted while CPU is installed.
- Can be used on Height Adjustable Tables as long as it is attached with spacer model AKMH. Take into account required leg room for users.



AKTMID and AKTLONG Keyboard Support (page 316)

- Lift and lock intuitive height adjustment.
- Positive and negative tilt for the best ergonomic positioning.
- +10°/-20° tilt adjustment and 360° rotation provides support of neutral position of shoulders, arms, and wrists while accommodating multiple working postures.
- Non-handed mouse tray can be moved from right hand to left hand side.
- Surpasses ANSI/BIFMA standards.
- Black powder-coat finish.

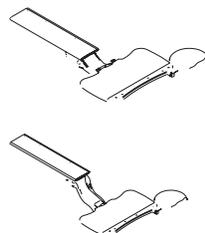

For specification information see page 315.

GSA SIN 33721

EXTENSIONS

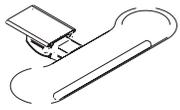

Description	Model	List Price
Compact Keyboard Support with 8" Track 30"W x 13"D	AKTSHORT 	\$ 603

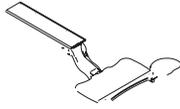

STS Keyboard Support with 23" Track 24"W x 12"D	AKTLONG 	\$ 739
---	---	--------



Articulating Keyboard Support with 21" Track 24"W x 12"D	AKTMID 	\$ 635
--	--	--------



Keyboard Spacer Kit 10 – 2½"H Spacers and Hardware	AKMH 	\$ 65
--	--	-------



CPU Hammock™ (Silver only) 360° swivel CPU holder with adjustable straps	ACPU1 	\$ 431
--	---	--------



Description	Model	P1 Paint List Price	P2 Paint List Price	P3 Paint List Price
Metal Corner Sleeve — for use with Optimize™, Concensys®, and Terrace® • Fits 1¼" thick square edge detail. (T-Mold worksurfaces) 22½"W leading edge x 18"D.	AWCS	\$ 152	\$ 158	\$ 163

Edge Details



Model AWCS

How to specify —
Select the Model Number from above.



Examples: AKMH ACPU1

 Shippable by small-package carrier.

Allsteel's tool rail works in conjunction with a variety of accessories. Modular accessories free up worksurface space and provide orderly storage that is well within reach. Units can be arranged and rearranged to respond to changing workflow. The work tools that attach to the tool rail are:

- Mail Box
- Folder Holder
- Phone Caddy
- Binder Bin
- Tool Box
- Clip Caddy™
- Sidebar™ Personal Shelf
- Paper Wave™
- Gripper Clip

Additional accessories that work with the **tool rail work tools** aesthetically are:

- Bookends
- Freestanding Mail Box

Coat hooks, marker boards and center drawers round out the organization offering.

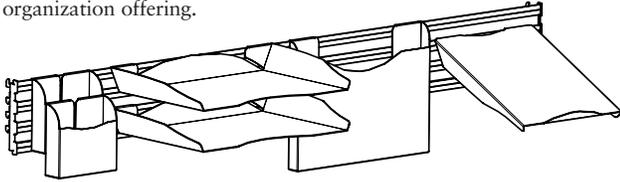

Tool rail, shown above, is height-adjustable in 1" increments using slots in panels or metal hutch. Tool rail shown with two tool boxes, two mail boxes, folder holder, and phone caddy. Folder holders and binder bins extend below a tool rail. Paper Wave and contents extend above a tool rail.

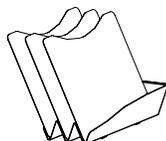
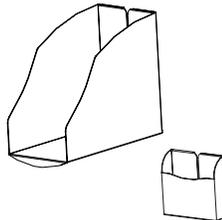
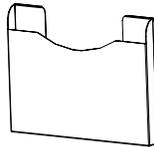

Tool Rails and Work Tools (page 320)

- Sturdy aluminum extrusion with steel support construction.
- Powder coated for durable finish.
- Use to hang Extensions tools. Cannot be used to support monitor arms.
- Suggested weight capacity not to exceed 80 lbs.
- Consideration needs to be given to height of tools and location of worksurfaces.
- For use with Terrace®, Concensys®, and Optimize™ systems.
- 5" high rail (widths coordinate with panels).
- Attachment via vertical reveals.
- Can be hung from wall track. Good solution for above copiers.
- Systems tool rail is off-modular — can be used on a panel of equal width or one size smaller.
- May span two panels of appropriate size, i.e., 60" W Tool Rail on two 30" W panels.

Tool Rail for Hutches (page 320)

- Will work on Universal, Terrace, Optimize, and Concensys system hutches produced after July 2, 2000 and Align™ metal hutches.
- Sturdy aluminum extrusion with steel support construction.
- Powder coated for durable finish.
- Use to hang Extensions tools. Cannot be used to support monitor arms.
- Suggested weight capacity not to exceed 80 lbs.
- Consideration needs to be given to height of tools and location of worksurfaces.

Mail Box (page 321)

- Holds standard letter-size paper and inter-office envelopes.
- Minimal horizontal intrusion.

Folder Holder (page 321)

- Holds manila envelopes.
- Is capable of hanging on other folder holders to maximize space.
- Stores vertically for easy access to files.

Phone Caddy (page 321)

- Holds telephone at optimum ergonomic angle.
- Wire management cut-outs.
- Accommodates standard phone sizes.

Binder Bin (page 321)

- Holds folders, binders, and manuals.

Tool Box (page 321)

- Holds pencils and other writing utensils, large post-it notes, and other desk top accessories.

Clip Caddy™ (page 321)

- Holds paper clips and other small objects.

Sidebar™ Personal Shelf (page 321)

- Holds office supplies and personal effects.

Paper Wave™ (page 321)

- Provides 3 fully divided slots for organizing files.
- Keeps papers from "bowing" at bottom.



Freestanding Mail Box (page 321)

- Incorporates similar aesthetic to mounted Mail Box.
- Mounting brackets allow for free access from front and back.
- Sold in pairs of two; will stack up to eight high.
- Individual mail box dimension = 1¼"H.
- Stacking brackets are black.



Coat Hook APMC6 (page 321)

- Hangs directly into slotted Terrace®, Optimize™, or Concensys® panel frame.
- Use for coat or bag.
- Package of six.
- Available in black only.

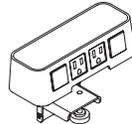

Power/Data Modules — Clamp On Worksurface (page 327)

- On-surface mounting option, fits on any worksurface with a 4" overhang.
- 6' Power cord. UL Listed.
- Includes adapters to allow use of commercially available data terminals or blanks to fill unused openings. Many of the AMP, AT&T, Krone, Leviton and most commercial data terminals can be used.

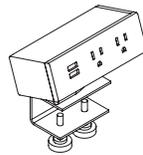

Power/Data Modules — Clamp On Worksurface (page 327)

- Worksurface clamp can be used on any surface with a 2½" overhang.
- Must be installed at time of initial worksurface installation if installing between a worksurface and panel.
- 6' Power cord. UL Listed.
- The USB hub allows simultaneous powering of 2 USB-A devices. The USB hub is a charger only, no ability to connect to a PC. The charging capacity is limited and may not charge all devices.
- Qi compatible wireless charging available on select models.

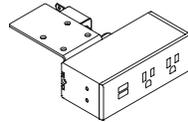
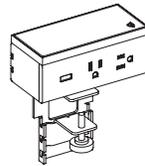

Power/Data Modules — Under Worksurface (page 327)

- Under surface mounting can be used on any surface with a 5" clearance.
- 6' Power cord. UL Listed.
- Hardware not included.



Worksurface Power/Data Module (page 327)

- Provides easy access to technology at primary worksurface.
- Mounts to edge of a worksurface and requires ⅜" gap. Consider whether ⅜" gap will work with layout.
- Must be mounted at time of initial worksurface installation if mounting between a worksurface and a panel. Maintaining ⅜" gap may not be possible with worksurfaces that are panel wrapped.

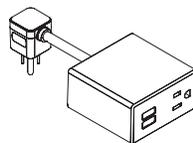

Miki Power Modules (page 327)

- Table top and undermount units.
- Hardware not included on undermount.
- 6' Power cord, UL Listed.
- 1 AC power and 1 dual USB configuration.



Vesta Mobile Power (page 327)

- 3 AC power simplex, 1 dual USB-A, 1 USB-C configuration.
- 10' Retractable power cord, UL Listed.
- Unit weighs 13 lbs.

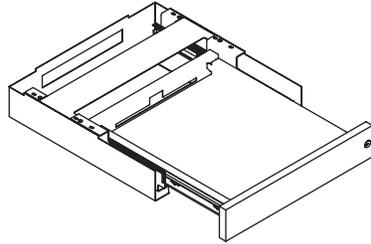
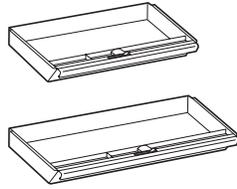

Flat Brackets

Front View



Top View

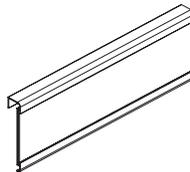
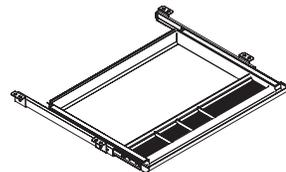
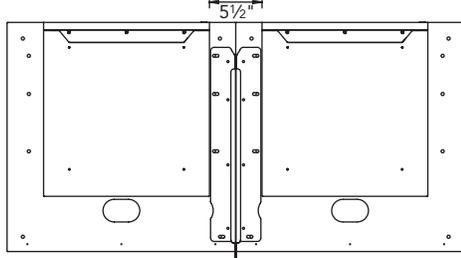

Metal Center Drawers (page 322)

- All metal center drawers feature pencil trays with three compartments for storage.
- Center drawers will not fit in center of 24" D worksurfaces which are wider than 60" due to location of center support bracket.
- For locking specifications, see pages 332-334.
- Ball-bearing slide suspension.

Laptop Drawer — U7WDA (page 322)

- Drawer body made of sheet metal.
- Drawer front made of 3/4" particleboard with laminate on both sides and fused laser edge banding.
- Core removable lock is located on right side drawer front
- 17 5/8" W x 18" D x 3 3/8" H Outside (interior 13" W x 16" D x 1 7/8" H)
- Minimum surface depth is 21" for surfaces not using an external stiffener; and 27" for surfaces using an external stiffener.
- Drawer extends 16"
- Maximum load: 45 lbs (functional BIFMA load)
- Drawer assembly and cover have cut out in back to allow for cables to exit drawer.
- Distance from floor to bottom of unit w/glides fully retracted is 24 3/4".
- Does not interfere with Further leg mounting plates so drawer can be placed directly next to either a system or table leg.
- When being placed next tower storage using the tower ell bracket (Z6LB) to support surface the drawer must be inset 3" to clear the ell bracket.
- Can be placed directly next to any support storage from any Allsteel product line (excluding towers).
- Flat brackets — drawer must be offset 3" from seam between surfaces to clear the bracket. See illustration at left.
- Can be used with rabbit edge worksurface models but there will be a larger reveal between surface and drawer.
- Can be used with knife edge worksurface models but reveal and depth need to be considered.

Polymer Center Drawer - ACD1 (page 322)

- 20 1/2" W x 17" D x 2" H
- Available in black only
- Made from ABS.
- Minimum clearance for mounting: 23" W x 16 1/4" D x 2" H.
- Retracts on 16" ball-bearing slides.
- Can be used on worksurfaces with Height Adjustable Bases as long as it is attached with spacer model AKMH.
- Can store up to 25 lbs.

Name Plate (page 321)

- Comes in a 10-pack.
- Metal backer installs under a Terrace or Optimize top cap, can be used with frameless glass.
- Cover is a transparent polycarbonate insert.
- Full plate is 8 1/2" W x 2 5/8" H.

For specification information see pages 317-318.

GSA SIN 33721

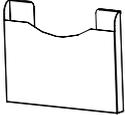
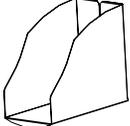
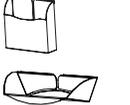
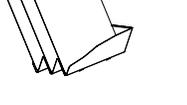
Description	Model	P1 Paint List Price	P2 Paint List Price	P3 Paint List Price
 Mail Box 9"D x 15"W	EAPT S	\$ 132	\$ 152	\$ 168
 Folder Holder 9"H x 12"W	EAFS S	\$ 135	\$ 155	\$ 171
 Phone Caddy 9"W x 11"D	EATS S	\$ 165	\$ 185	\$ 201
 Binder Bin 8½"H x 5¼"W x 10"D	EABS S	\$ 132	\$ 152	\$ 168
 Tool Box 5"H x 5¼"W x 1½"D	EADH S	\$ 106	\$ 126	\$ 142
 Clip Caddy™ 2"H x 7"W x 3½"D	EAAC S	\$ 94	\$ 114	\$ 130
 Sidebar™ Personal Shelf 2"H x 21"W x 7"D	EAPS S	\$ 135	\$ 155	\$ 171
 Paper Wave™ Tray size: 2½"H x 6"W x 10"D Dividers: 9½"H x 9"W	EASS S	\$ 189	\$ 209	\$ 225
 Freestanding Mail Box (specify paint color) Pair — 4½"H x 13¼"W x 9"D	EAFT S	\$ 271	\$ 291	\$ 307
 Coat Hooks (black only) Package of six	APMC6 S	\$ 132	N/A	N/A
 Panel Name Plate Package of 10	EACS	\$ 360	\$ 380	\$ 396
Note: Not for use on tool tile or rail, name plate installs under top cap on Terrace and Optimize.				

EXTENSIONS

<p>How to specify — Select the Model Number from above.</p>	<p><i>1st Option:</i> Paint: P1 P2 P3 See pages 18-21 for finishes.</p>								
<table border="1" style="width: 100%; height: 20px;"> <tr> <td style="width: 25%;"></td> <td style="width: 25%;"></td> <td style="width: 25%;"></td> <td style="width: 25%;"></td> </tr> </table>					<table border="1" style="width: 100%; height: 20px;"> <tr> <td style="width: 25%; text-align: center;">P</td> <td style="width: 25%;"></td> <td style="width: 25%;"></td> <td style="width: 25%;"></td> </tr> </table>	P			
P									

Examples: EAPT.P4J APMC6.P

S Shippable by small-package carrier.

For specification information see page 319.

GSA SIN 33721

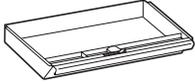
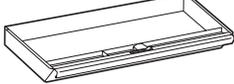
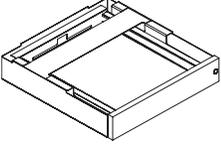
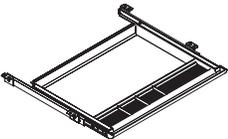
	Description	Model	List Price		
			P1	P2	P3
 Angled front	Metal Center Drawer w/Lock 19"W x 14¼"D x 3"H • 12" drawer extension (3/4). • Inside drawer dimension: 19"W x 13"D x 2⅝"H. • Minimum clearance for mounting: 21¼"W x 19¼"D.	CSDC19 S	\$ 305	\$ 327	\$ 346
	 Angled front	24½"W x 14¼"D x 3"H • 12" drawer extension (3/4). • Inside drawer dimension: 24½"W x 13½"D x 2⅝"H. • Minimum clearance for mounting: 27⅝"W x 19¼"D.	CSDC25 S	\$ 314	\$ 336
 Angled front	Laptop Drawer — Locking, laminate front, metal case 17⅝"W x 18"D x 3⅜"H • 16" drawer extension • Inside drawer dimensions: 13"W x 16"D x 1⅞"H • Minimum clearance for mounting: 17⅝"W x 21"D x 3⅜"H (see illustration)	U7WDA S	\$ 1750	\$ 1773	\$ 1792
	 Angled front	Polymer Center Drawer 20½"W x 17"D x 2"H • 11½" extension • Minimum clearance for mounting: 23"W x 16¼"D x 2"H	ACD1	\$ 244	N/A

EXTENSIONS

<p>How to specify — Select the Model Number from above.</p>	<p><i>1st Option:</i> Laminate Edge (Laptop drawer front if applicable): See pages 18-21 for finishes.</p>	<p><i>2nd Option:</i> Edge (Laptop drawer edge if applicable): See pages 18-21 for finishes.</p>	<p><i>3rd Option:</i> Paint (If laptop drawer, list exterior case color here): See pages 18-21 for finishes. Power Data Module PR6 Silver.</p>	<p><i>4th Option:</i> Paint (Interior of laptop drawer if applicable): See pages 18-21 for finishes.</p>	<p><i>5th Option:</i> Lock (if applicable): STD Standard OMT Omit (Deduct \$20)</p>	<p><i>6th Option:</i> Lock or Tech Module Color (if applicable): EL Silver (Lock)</p>
--	---	---	---	---	--	---

Example: U7WDA.LM11EV.P27.PR6.STDEL

S Shippable by small-package carrier.

Allsteel Extensions offers Illumination in three styles — Undercabinet LED Light, Wand Light, and Splitty Light.

Recessed Undercabinet LED Light

Recessed task lights conserve space and provide an efficient solution for illuminating the workplace. All models are equipped with LED strips.

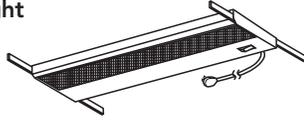

Recessed task light models mount under storage cabinets or shelves to provide optimal space utilization. Models are available in two styles and three sizes to correspond with the width of the cabinet or shelf. Task lights with a fused plug are available to meet Chicago electrical code.

Undercabinet LED Light

The Undercabinet LED Light is a low-profile, linear solution for overhead cabinets and shelves and is an ideal solution for painted wood storage. It utilizes energy-efficient LED technology which provides a long life. The Undercabinet LED Light provides the opportunity to mount the fixture where light is needed most.

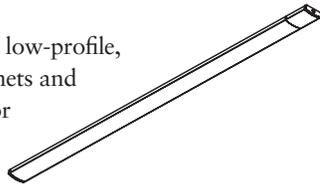

The Undercabinet LED Light features a metal trough reflector with diffuser lens. The light has a sleek 1/2" thick profile and provides two options for mounting, either magnetically or with hardware. Undercabinet LED Lights can be daisy-chained.

Optional undercabinet occupancy sensor is available which will automatically turn off the fixture after 30 minutes of no detection and back on immediately as the user re-enters the detection range using Passive Infrared (PIR) sensor technology. Unit features 360° lens with 90° outward detection angle, providing a 36" coverage diameter at 18". Occupancy sensor comes with connector and is required to be connected in the sequence shown below. Connect occupancy sensor to a light, or first light in daisy chain to control all linked lights.

CONNECTION SEQUENCE*

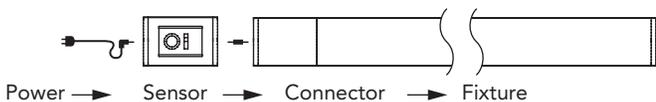

*Cannot deviate from this sequence

Recessed Task Lights (page 325)

- Black Metal Construction with 9' long black cord attached to right rear corner of the fixture.
- LED strip comes installed within light.
 - 50,000 hour life span
 - 120V-277V
 - CCT 4000K
 - CRI 80+
- Includes 4 cord retainer clips.
- Shorter width models can be used on wider overheads, shelves and hutches.
- On/Off switch provides individual control of tasklight within the workstation.
- Daisy chain models require a master control model — 10 fixtures maximum.
- RECOMMENDATION: Provide a separate circuit for task lights to ensure proper, long-term operation.

Undercabinet LED Lights (page 325)

- Low profile energy-efficient LED task light for use with overhead storage cabinets and shelves.
- 20W power supply for 10W 17" unit (.166 amps).
- 20W power supply for 20W 31" unit (.166 amps).
- 60W power supply for daisy-chain starter units (.5 amps). Must order one starter unit for each daisy-chain application.

LED Light Combinations Must Not Exceed 60W in Combination	Power Usage
6X 17"	60W
3X 31"	60W
1X 31" + 4X 17"	60W
2X 31" + 2X 17"	60W

- The combinations that could max out 60W are featured above. *Daisy chained units have a power limit of 60W from one power entry. 17W units use 10W and 31W units use 20W.*
- Specify up to 5 additional 17" interconnect units (ALED17UJMP30) to daisy-chain together with 17" daisy-chain starter fixture (ALED17U60).
Example: Daisy-chain 4-17" undercabinet LED lights:
Specify: 1 ALED17U60
Specify: 3 ALED17UJMP30 with 10" jumper cord
- Specify up to 2 additional 31" interconnect units (ALED31UJMP30) with 10" jumper cords to daisy-chain together with 31" tasklight (ALED31U60); or 17" daisy-chain starter fixture (ALED17U60).
- 3500K color temperature.
- 131 footcandles at 18" on ALED31U; 76 footcandles at 18" on ALED17U.
- Magnetic or screw-mount option — attachment hardware included.
- On 20 watt models, power drive is attached to plug: allow 1 1/8" D space at outlet.
- On 60 watt models, power drive brick is in center of cord.
- Includes 3 cord retainer clips.
- Meets California Title 24 Energy Efficiency Standards.
- "Instant On" switch with infinite dimming cycle from 100% to 15% with the last state memory, allowing the user to set their desired level of lighting.
- Fixture automatically turns off after 10 hours of use to reduce unwanted energy use.
- Optional occupancy sensor automatically turns off all interlinked fixtures after 30 minutes of no detection and back on immediately when detection is found.

Overhead Length	Suggested LED Sizes
24	17
30	17
36	17
42	31
48	17 + 17
60	31 + 17
72	31 + 31

Note: LED lights may need to be positioned along length properly to allow jumping to additional overheads. Suggested sizes above are recommendations for single overheads to provide as much light along length of overhead as possible.

The suggested sizes factor in 4 inches of room for the power inlet and occupancy sensor (optional).

Wand™ Task Light

Wand freestanding task light offers a clean, simple design along with powerful LED technology to illuminate the workspace. The swivel base and arm tilt allow users to position the light just where they need it. The 7.7 watt LED light offers efficiency and long life, providing up to 25 years of daily use. The slim, sleek design makes it easy to integrate into any workspace. Wand task light is 97% recyclable. Occupancy sensor and/or charging models available.

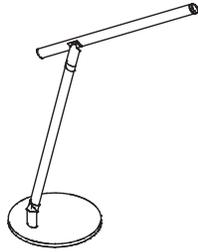

Splitty Task Light

Splitty's organic and modern design compliments the workstation while also bringing rich features to the user. In addition to illuminating the space, Splitty can also be a teleconferencing tool through Splitty's 360-degree light head adjustment and soft touch, continuous dimming. Integrated charging allows for small personal device charging crucial to the modern worker's workplace toolkit while minimizing clutter within the station. Optional clamp or tool tile mounts available as accessories.

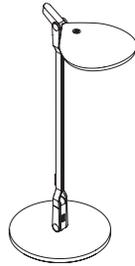

Wand LED Freestanding Task Light (page 326)

- Available in Silver or White. 9'4" cord is Silver.
- Full range dimming from 100% – 10% with last state memory.
- Uses 5W at highest setting and as low as 1 watt at its lowest setting, providing 75 to 12.7 footcandles of light, respectively (16" above worksurface).
- 7½" round swivel base and 16½"H tilt arm allow versatile positioning of the 13" lampshade.
- Designed for 50,000 hours of life.
- Color Temperature: 3500K. Color Rendering Index (CRI): 80.
- Materials: aluminum arm and lampshade, steel base.
- Weight: 4.4 lbs. 97% recyclable, 76% post-consumer.
- Certifications: UL and CUL. TAA compliant.
- Occupancy sensor available with automatic shut-off after 15 minutes if no motion is detected.
- USB model features USB-A (1), USB-C (1) charging within base of unit.
- USB model also features occupancy sensor. 7.5W (A) & 18W (C) power consumption.

Splitty Task Light (page 326)

- Available in Silver, White, or Black (accessories available in silver only).
- Cord is 12' long.
- Cord is silver when black or silver finish specified, white when white light is specified.
- Soft touch on/off, dimming.
- Continuous dimming (100% – 3%) with last state memory.
- 5.8W of energy consumption. 7W at highest setting, 0.6W at lowest.
- 5" 360-degree swivel light head, 6.54" round swivel base and 17"H arm. Arm has full 180 degree rotation and 360 degree swivel.
- Designed for 60,000 hours of life.
- Color Temperature: 3500K, Color Rendering Index: 90.
- Materials: aluminum, plastic.
- USB-A has 5W of power consumption.
- USB-A (1) charging at bottom of light arm stem. Charging feature compatible for any mounting method.
- Clamp mount compatible with surfaces ¼" – 2¼" thick.
- Tool tile mount has 1½" adjustment range, minimum slot height of ⅜".

For specification information see pages 323-324.

Open Market / GSA SIN 33721 (as noted)

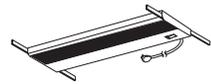

Open Market

Description	Watt Usage	Model	List Price
Recessed Task Lights (Black only) — Use recessed under overhead cabinets, storage shelves, or hutches, comes with cord retainer clips			
Task Light for 24"W	10	A870824 S	\$ 442
Task Light for 30"W and 36"W	14	A870830 S	\$ 446
Task Light for 42"W and 48"W	21	A870842 S	\$ 483
Task Light for 60"W, 66"W, and 72"W	28	A870860 S	\$ 522

Recessed Task Lights (Black only) — With fused plug (satisfies Chicago electrical code)

Task Light for 24"W	10	A870824CH S	\$ 570
Task Light for 30"W and 36"W	14	A870830CH S	\$ 581
Task Light for 42"W and 48"W	21	A870842CH S	\$ 618
Task Light for 60"W, 66"W, and 72"W	28	A870860CH S	\$ 654

Note: See below for GSA Approved Task Lights.

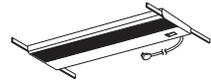

GSA SIN 33721

GSA Recessed Task Lights — Use recessed under overhead cabinets, storage shelves, or hutches

Base Models — Stand Alone

Task Light for 24"W	15	GS870924 S	\$ 565
Task Light for 30"W and 36"W	17	GS870930 S	\$ 583
Task Light for 42"W and 48"W	25	GS870948 S	\$ 627
Task Light for 60"W, 66"W, and 72"W	32	GS870960 S	\$ 671



GSA SIN 33721

Cord Retainer Clips (Black only)

Bag of 50 clips		AAPACM2 S	\$ 56
-----------------	--	---	-------



GSA SIN 33721

LED Undercabinet Light (white end caps)

17" Task Light w/20 watt power supply for 24"W or wider overhead	ALED17U	S	\$ 1045
17" Task Light w/60 watt power supply for daisy chain	ALED17U60**	S	\$ 1144
17" 10 watt Interconnect Task Light w/10" Jumper Cord	ALED17UJMP30	S	\$ 807
31" Task Light w/20 watt power supply 36"W or wider overhead	ALED31U	S	\$ 1568
31" Task Light w/60 watt power supply for daisy chain	ALED31U60**	S	\$ 1653
31" 20 watt Interconnect Task Light w/10" Jumper Cord	ALED31UJMP30	S	\$ 942
Undercabinet Occupancy Sensor 2 1/4"W + 1"W Connector	ALEDOCC*		\$ 636

*Undercabinet Occupancy Sensor works with LED Undercabinet lights shipped after 11/1/2013.

**When purchased separately without a configurable TAA compliant end product, not on GSA contract.

<p>How to specify — Select the Model Number from above.</p>	<p><i>1st Option:</i> Cord Retainer Clip Color: Black only.</p>
--	--

_____ . P | 2 | 7

Examples: A870824 A870824CH GS870924 AAPACM2.P27

S Shippable by small-package carrier.

For specification information see pages 323-324.

Open Market / GSA SIN 33721



GSA SIN 33721

Description	Model	List Price
Wand™ LED Task Light (Silver or White)		
Freestanding LED Task Light	WANDFS	\$ 509
Freestanding LED Task Light (Occupancy Sensor)	WANDFSOC S	\$ 724

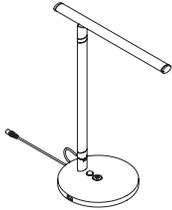

Freestanding LED Task light (Occupancy Sensor & Charging)	WANDFSUSB	\$ 754
---	-----------	--------



Splitty Task Light (Silver, White, or Black)		
Freestanding LED Task Light (Charging)	PRFTSKFS	\$ 690

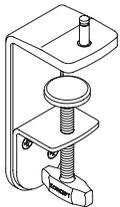

Clamp Mount (Silver only)	PRFTSKCL	\$ 80
---------------------------	----------	-------

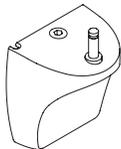

Tool Tile Mount (Silver only)	PRFTSKTR	\$ 80
-------------------------------	----------	-------

How to specify —
Select the Model Number from above.

1st Option:

Color
(for Splitty):

SVR Silver
WHT White
BLK Black

(for Wand LED):

SVR Silver
WHT White

Example: WANDFS.WHT

S Shippable by small-package carrier.

For specification information see page 318.

GSA Reference Page

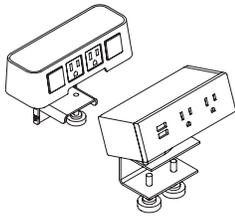

Description	Model	List Price
Power/Data Modules — Worksurface Clamp		
Dome — 2 Power, 2 Open Data with faceplate adapters (FOG Fog only)	ACOMDOME2	\$ 515
2 Power, 1 USB-A, 1 USB-C (SNW Snow or STRM Storm)	APWRMOD2WC	\$ 710
3 Power (SNW Snow or STRM Storm)	APWRMOD3WC	\$ 546
2 Power, 1 Dual USB, Qi Power Module	APWRMOD2Q	\$ 783

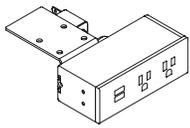
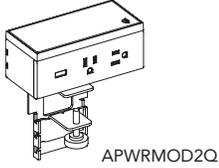

Power/Data Modules — Under Worksurface Mount		
2 Power, 1 USB-A, 1 USB-C (SNW Snow or STRM Storm)	APWRMOD2UWM	\$ 710
3 Power (SNW Snow or STRM Storm)	APWRMOD3UWM	\$ 546
4 Power Quad Tap (10' cord)	UNQTMP	\$ 456

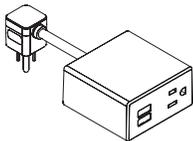
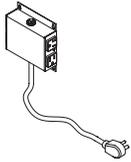

Miki		
1 Power, 1 USB Table Top	APWRMOD1TT	\$ 314
1 Power, 1 USB Under Worksurface Mount	APWRMOD1UWM	\$ 314

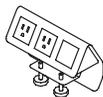

Worksurface Power/Data Module (PR6 Silver only)		
2 Simplex receptacles, 1 data position	A870302	\$ 395



Vesta		
3 Power Vesta – Corded	AVSTA3PWR	\$ 2000

<p>How to specify — Select the Model Number from above.</p> <p>_____ .</p>	<p><i>1st Option:</i></p> <p>Color Option 1:</p> <p>FOG Fog SNW Snow STRM Storm BLK Black</p> <p>_____ .</p>	<p><i>2nd Option:</i></p> <p>Color Option 2 (if applicable):</p> <p>FOG Fog SNW Snow STRM Storm BLK Black</p> <p>_____ .</p>
	<p><i>Example: ACOMDOME2.FOG</i></p>	

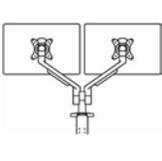
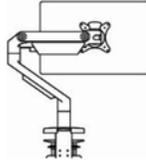
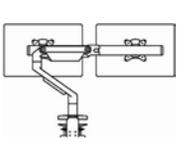
PIVOT MONITOR ARMS	Standard Dynamic Single	Standard Dynamic Dual	Heavy Duty Dynamic Single	Heavy Duty Dynamic Dual with Crossbar
Allsteel Model:	AMASTS	AMASD	AMASHD	AMADHD
				
Features:				
Price	\$488	\$983	\$838	\$1160
Colors	Black and Silver	Black and Silver	Black and Silver	Black and Silver
Monitor Rotation	180°	180°	180°	180°
Monitor Extension	18.75"	18.26"	20.75"	23"
Monitor Tilt Adjustment	+25°/-25°	+25°/-25°	+25°/-25°	+25°/-25°
Arm Height Adjustment	8.4" to 19"	9.6" to 20.1"	8.5" to 20"	8.5" to 20"
Weight Capacity	6.2 to 17 lbs.	6.2 to 17 lbs. per Arm	8 to 35 lbs.	17.5 lbs. per VESA Plate
Mounting Option	Grommet and Clamp Mounts	Grommet and Clamp Mounts	Grommet and Clamp Mounts	Grommet and Clamp Mounts
360° Lockout Feature	Yes	Yes	Yes	Yes
VESA Compatibility	75mm and 100mm	75mm and 100mm	75mm and 100mm	75mm and 100mm
Pole Height	N/A	N/A	N/A	N/A
Maximum Width per Monitor*	N/A	25"	N/A	25"
Worksurface Clamp Requirements	¾" to 2" Thick	¾" to 2" Thick	¾" to 2" Thick	¾" to 2" Thick
Worksurface Grommet Clamp Requirements	¾" to 2" Thick/Hole Diameter ⅜" to 2"	¾" to 2" Thick/Hole Diameter ⅜" to 2"	¾" to 2" Thick/Hole Diameter ⅜" to 2"	¾" to 2" Thick/Hole Diameter ⅜" to 2"
Environmental Info	94% Recycled Content	94% Recycled Content	94% Recycled Content	94% Recycled Content

*Use of APACSM Slider Model will allow for wider monitor capabilities

ACCESSORIES

Pivot Standard Weight Monitor Arms

- Adaptable and adjustable to user preference the Pivot monitor arm offers a slim and refined design coupled with easy fingertip adjustment.
- Multiple points of adjustment including 360 degree swivel with optional 180 degree lockout, 18.75" extension, and 10" of height adjustment.
- Monitor tilts +25/-25 degrees.
- Standard weight arms utilize a tension spring that allows for effortless adjustment of monitors to proper ergonomic positions.
- Tension adjustment at multiple points allows for proper adjustment for monitors weight between 6-17 lbs.
- Model includes grommet and worksurface mounting options.
- Desk clamp mounts require ¾" –2" thick surfaces; grommet mount requires hole diameter of ⅜" to 2" wide and accommodates up to 2" thick surfaces.
- Integrated cable management included with each model. Black models ship with all black cable management pieces, Silver models ship with grey wire management but optional white pieces ship in the box and can be installed on site.
- Dual monitor arm supports up to 25" wide monitors. Wider monitors may require use of optional slider mount model.
- Pivot arms are VESA 75mm and 100mm compatible.
- Quick release feature simplifies monitor installation and changes.

Pivot Slider Mount

- Provides 11.8" of horizontal movement.
- Allows for wider monitors to be used on dual monitor arms and sit flush side by side.
- Not compatible with Pivot Heavy Duty Series.

Pivot Heavy Duty Series

- Adaptable and adjustable to user preference the Pivot monitor arm offers a slim and refined design coupled with easy fingertip adjustment.
- Multiple points of adjustment including 360 degree swivel with optional 180 degree lockout, 20.75" extension, and 12" of height adjustment.
- Monitor tilts +25/-25 degrees.
- Tension adjustment at multiple points allows for proper adjustment for monitors weight between 8-35 lbs.
- Model includes grommet and worksurface mounting options.
- Desk clamp mounts require ¾" –2" thick surfaces; grommet mount requires hole diameter of ⅜" to 2" wide and accommodates up to 2" thick surfaces.
- Integrated cable management included with each model. Black models ship with all black cable management pieces, Silver models ship with grey wire management but optional white pieces ship in the box and can be installed on site.
- Dual monitor arm supports up to 2 monitors weight 4-17.5 lbs each.
- Pivot arms are VESA 75mm and 100mm compatible.
- Quick release feature simplifies monitor installation and changes.

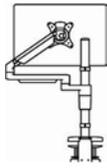
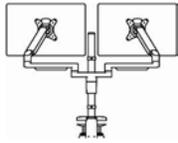
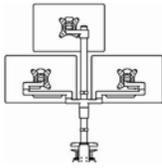
PIVOT MONITOR ARMS	Dynamic Single Post	Dynamic Dual Post	Triple Fixed Post
Allsteel Model:	APASD	APADD	APATF
			
Features:			
Price	\$660	\$923	\$1166
Colors	Silver	Silver	Silver
Monitor Rotation	180°	180°	180°
Monitor Extension	21"	21"	23"
Monitor Tilt Adjustment	+25°/-25°	+25°/-25°	+25°/-25°
Arm Height Adjustment	10.6"	10.6"	N/A
Weight Capacity	6.2 to 17 lbs.	6.2 to 17 lbs. per Arm	17 lbs. per arm
Mounting Option	Grommet and Clamp Mounts	Grommet and Clamp Mounts	Grommet and Clamp Mounts
360° Lockout Feature	Yes	Yes	Yes
VESA Compatibility	75mm and 100mm	75mm and 100mm	75mm and 100mm
Pole Height	17.7"	17.7"	27.5"
Maximum Width per Monitor*	25"	25"	25"
Worksurface Clamp Requirements	7/8" to 2" Thick	7/8" to 2" Thick	7/8" to 2" Thick
Worksurface Grommet Clamp Requirements	7/8" to 2" Thick/Hole Diameter 3/16" to 2"	7/8" to 2" Thick/Hole Diameter 3/16" to 2"	7/8" to 2" Thick/Hole Diameter 3/16" to 2"
Environmental Info	94% Recycled Content	94% Recycled Content	94% Recycled Content

*Use of APACSM Slider Model will allow for wider monitor capabilities

Pivot Post Series

- Adaptable and adjustable to user preference the Pivot monitor arm offers a slim and refined design coupled with easy fingertip adjustment.
- Multiple points of adjustment including 360 degree swivel with 21" extension and 10.6" of height adjustment.
- Monitor tilts +25/-25 degrees.
- Tension adjustment at multiple points allows for proper adjustment for monitors weight between 6.5-17 lbs per arm.
- Model includes grommet and worksurface mounting options.
- Desk clamp mounts require 7/8" – 2" thick surfaces; grommet mount requires hole diameter of 3/16" to 2" wide and accommodates up to 2" thick surfaces.
- Integrated cable management included with each model. Silver color option with grey wire management only.
- Dual monitor arm supports up to 25" wide monitors. Wider monitors may require use of optional slider mount model.
- Single and dual models have a post height of 17.7"; Triple monitor model has a post height of 27.5".
- Pivot arms are VESA 75mm and 100mm compatible.
- Quick release feature simplifies monitor installation and changes.

Pivot Counterweight Kit

- Counterweight Kit to be used with monitors weighing less than 6 lbs.
- Gray color only.
- Counterweight weighs 1 lb. 6 oz.

Pivot Conversion Kits

- Kit allows user to transform single monitor arm (Standard, Heavy Duty, or Post) into Dual Arm configuration
- Available in black and silver, Post arm only available in silver
- Required wire management included
- Once assembled, will aesthetically emulate dual configuration of chosen arm

Accessories — Pivot Monitor Arms

Pivot

For specification information see pages 328-329.

GSA SIN PENDING, GSA SIN 33721

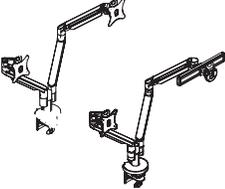
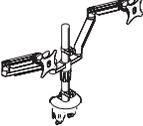
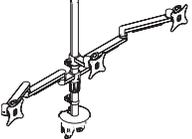
Description	Model	List Price
Pivot Monitor Arms		
 Dynamic Single Monitor - Standard Weight	AMASTS <input type="checkbox"/>	\$ 488
Dynamic Single Monitor - Standard Weight for GSA *Silver Only GSA SIN 33721.	AMASTS-G	\$ 576
 Dynamic Single Monitor - Heavy Weight	AMASHD <input type="checkbox"/>	\$ 838
 Dynamic Dual Monitor with Crossbar	AMADHD <input type="checkbox"/>	\$ 1160
Dynamic Dual Monitor - Standard Weight	AMASD <input type="checkbox"/>	\$ 983
 Dynamic Dual Monitor - Standard Weight for GSA *Silver Only **Slider Mount included. GSA SIN 33721.	AMASD-G	\$ 1048
 Single Dynamic Post Arm *Silver Only	APASD <input type="checkbox"/>	\$ 660
 Double Dynamic Post Arm *Silver Only	APADD <input type="checkbox"/>	\$ 923
 Triple Fixed Post Mount *Silver Only	APATF <input type="checkbox"/>	\$ 1166

ACCESSORIES

How to specify —
Select the
Model Number
from above.

1st Option:

Select the Color:

SVR Silver
BLK Black

A | | | | | .

| | | |

Example: AMADHD.BLK

Shippable by small-package carrier.

Accessories — Pivot Monitor Arms

Pivot

For specification information see pages 328-329.

Open Market



Description	Model	List Price
Pivot Monitor Arms		
Monitor Arm Sliding Mount	APACSM <input type="checkbox"/>	\$ 233

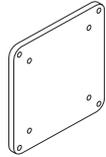

Monitor Arm Counterweight	APACW <input type="checkbox"/>	\$ 55
---------------------------	--------------------------------	-------

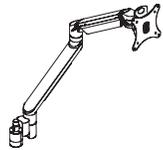

Pivot Monitor Arm Standard Single Conversion Kit	AMASTSCK	\$ 546
--	----------	--------

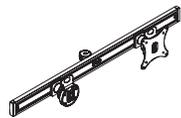

Pivot Monitor Arm Heavy Duty Single Conversion Kit	AMASHDCK	\$ 477
--	----------	--------

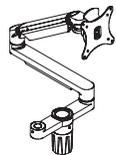

Pivot Single Post Arm Conversion Kit	APASDCK	\$ 695
*Silver Only		

ACCESSORIES

<p>How to specify — Select the Model Number from above.</p>	<p>1st Option: Select the Color: SVR Silver BLK Black</p>
<p>A .</p>	<p> </p>

Example:

Laterals, Pedestals and Storage, Painted Wood Storage

Standard Options

- Random Keying — The factory will assign key(s) arbitrarily using key numbers from chart below.
- Omit Lock Core — The factory will omit lock cores. Removable lock core kits with specific key number must be ordered to facilitate keying alike in the field.

Vertical Files

Standard Options

- Random Keying — The factory will assign key(s) arbitrarily (see below chart for key numbers).

Key Alike Process

- Order standard product which will be shipped with factory installed locks and random numbered cores.
- Order the appropriate quantity of like numbered cores required for each workstation or keyed area.
- Simply replace the factory installed core with the replacement cores after product has been installed.

Replacing Lock Cores

- Lock must be in the unlocked position.
- Insert core removal key and pull core straight out. (Reach units require rotating key 90° clockwise past unlocked position.)
- Insert new core with core removable key, hold core into lock and withdraw core removal key.
- Retain original core for future use.

	Random Keying	Omit Lock Core	Key Numbers	Lock Core Kit	Master Key
Align™ Laterals	X	X	101E-225E	ALKF23C*	AMKF22
Align New Low Credenzas, Towers, Pedestals (“YP” prefix models)	X	X	101E-225E	ALKF26EL	AMKF22
Align Old Pedestals (for New Pedestals after 11/2015 see above)	X	X	101E-225E	ALKF23C*	AMKF22
Align Old Towers (for New Towers after 2/2016 see above)	X	X	101E-225E	ALKF23C*	AMKF22
Align Metal Front Lockers	X	X	101E-225E	ALKF26EL	AMKF22
Align Laminate Front Lockers	X	X	101E-225E	ALKF23C*	AMKF22
Approach™ Desking and Storage	X	X	101E-225E	ALKF26EL	AMKF22
Center Drawer (CSDC19/25)	X	X	101E-225E	ALKF23C*	AMKF22
Essentials™ Laterals	X	X	101E-225E	ALKF23C	AMKF22
Essentials Overfile Cabinets	X	X	101E-225E	ALKF23C*	AMKF22
Essentials Pedestals	X	X	101E-225E	ALKF23C*	AMKF22
Essentials Personal Tower and Files	X	X	101E-225E	ALKF23C*	AMKF22
Further™ Laminate Storage	X	X	101E-225E	ALKF23C*	AMKF22
Hutches	X	X	101E-225E	ALKF23C*	AMKF22
Involve® Laminate Storage	X	X	101E-225E	ALKF23C*	AMKF22
Overheads (Flipper Door, including RTA)	X	X	101E-225E	ALKF23C*	AMKF22
Overheads (Receding Door)	X	X	101E-225E	ALKF23C*	AMKF22
Vertical Files A990/A940	X		101E-225E	ALKF23C*	AMKF22

*ALKF23C is chrome. Optional black core for wood casegoods is ALKF23CE4. Optional matte silver core is ALKF26EL.

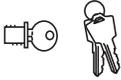
	Description	Model	List Price
	Removable Lock Core Kits**	Key Numbers 101E-225E	
	Brushed Chrome used on metal and painted wood casegoods product produced after 2/3/97; A980, A990, and A940 Series vertical files; Persona™ pedestals produced after 8/22/09; Reach® Storage units produced after 10/5/09; and receding door overheads produced after 8/1/10. Includes one core, two keys, one core removal tool, adapter and instructions	ALKF23C*** 	\$ 30
	Black used on veneer casegoods product. Includes one core, two keys, one core removal tool, adapter and instructions. Core matches manufactured lock on metal casegoods but Black core can be used with veneer and laminate product.	ALKF23CE4*** 	\$ 30
	Matte Silver used on Approach and Align metal credenzas, new pedestals, and new towers. Includes one core, two keys, one core removal tool, adapter, and instructions.	ALKF26EL 	\$ 30
 Open Market	Master Key (One key) Available to authorized dealers only on faxed orders. Will open ALKF23C, LKF23C, ALKF23CE4, LKF23CE4, LKF24, LKF25EL, and LKF25E4 locks numbered 101E-225E.	AMKF22 	\$ 31

HOW TO ORDER:
Note: Numbers 101E-225E are available. Orders without numbers specified will be keyed at random.
SAMPLE ORDER:

Quantity	Model	Color
6	ALKF23C	X121E
1	AMKF22	X

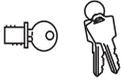
	Brushed Chrome Removable Lock Core Kit** **	Key Numbers 101N-225N	
	Includes one core, two keys, one core removal tool, adapter, and instructions	ALKF23CN*** 	\$ 30
 Open Market	Master Key* (One key) Available to authorized dealers only on electronic orders. Will open ALKF23CN and LKF23CN locks numbered 101N-225N.	AMF22 	\$ 31

N series lock cores (ALKF23CN) are a replacement part for legacy Allsteel products. N series lock cores were used in all Persona pedestals produced between January 1996 and August 2009 as well as Receding Door Overheads produced between January 1996 and August 2010. N series lock cores are NOT used in current product and should not be ordered for product produced after these dates. E series lock cores are used in current product, see above.

*On existing Premium and Asset lateral, use N-Series locks.

** Removable Lock Core Kits are intended for use with Allsteel systems furniture and are approved under GSA SIN PENDING. When purchased separately and used without Allsteel systems furniture, those Removable Lock Core Kits marked by (**) are considered Open Market.

*** When purchased separately without a configurable TAA compliant end product, not on GSA contract.

 Shippable by small-package carrier.

EASY LOCK PROGRAM

The Allsteel Easy Lock Program simplifies the lock-core ordering process when multiple cores are being specified. The Easy Lock cores can be used with Allsteel storage that currently uses the **ALKF23C** cores (all storage except receding door overheads).

To ensure ease of ordering in different situations the Easy Lock cores can be specified in three different ways — random, specified or sequential.

Random Keying

The random keying option is provided for instances where there are multiple orders or phases to a project and the offices need to be keyed alike but the key numbering is not required. With the random keying option key numbers are not specified, however, the core kits will be in sequential order from a random starting point.

Example: There are 15 offices which each have 5 black locks that need to be keyed alike, but the actual key numbers are not important.

This order would look like: **LKFE5BLK.X.15**

This specifies that 15 5-core kits are needed in black with random key numbers.

Specified Keying

The Specified Keying option is provided for the instances where there is a specific key number desired for all of the cores ordered.

Example: There are 10 offices which each have 2 silver locks that need to be keyed-alike with key number 202.

This order would look like: **LKFE2SLV.X202.10**

This specifies that 10 2-core kits are needed in silver with key number 202.

Sequential Keying

Allsteel Sequential Keying option is provided for the instances when there are multiple orders or phases to a project and it is imperative that key numbers are not duplicated.

Example: A multiple phase project has 60 total offices — 40 offices in Phase I, and 20 offices in Phase II. The project manager has expressed a need to have keyed-alike offices but doesn't want any of the offices to use the same key numbers.

The first 40 offices have 4 silver locks each that need to be keyed-alike.

This order would look like: **LKFE4SLV.SEQ/101.40**

This specifies that 40 4-core kits are needed in silver and the starting number is 101.

The second set of 20 offices only have 3 silver locks each that need to be keyed-alike; and it is important which key number starts off the sequence to ensure that no key number is duplicated. It is known that the first key range was key numbers 101-140.

The second order would look like: **LKFE3SLV.SEQ/141.20**

This specifies that 20 3-core kits are needed in silver and key sequence has to start at key number 141.

HOW TO ORDER:

Numbers 101-225 are available. Orders without key numbers specified will be keyed at random.

SAMPLE ORDER FOR EXAMPLES GIVEN:

Model	Key Type	Quantity
LKFE5BLK.	X.	15
LKFE2SLV.	X202.	10
LKFE4SLV.	SEQ/101.	40
LKFE3SLV.	SEQ/141.	20

Note: Quantity required is last number in model.option string.

Description	Model / Color	List Price
Easy Lock Lock-Core		
Lock Core Kit — 1 core, 2 keys	LKFE1 _____	\$ 30
Lock Core Kit — 2 cores, 2 keys	LKFE2 _____	\$ 61
Lock Core Kit — 3 cores, 2 keys	LKFE3 _____	\$ 91
Lock Core Kit — 4 cores, 2 keys	LKFE4 _____	\$ 121
Lock Core Kit — 5 cores, 2 keys	LKFE5 _____	\$ 151
Add color suffix to model: SLV Silver, BLK Black, MTS Matte Silver		
Note: One core removal key minimum per order. One additional core removal key per 25 lock-cores will be shipped.		
Note: When purchased separately without a configurable TAA compliant end product, not on GSA contract.		
Master Key		
(One key) Available to authorized dealers only on faxed orders.		
	AMKF22	\$ 31

How to specify using Easy Lock Program:

Step 1 — Count the number of lock cores and color required in each workstation that need to be keyed alike.

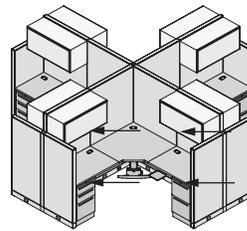

2 overheads with 1 lock-core each = 2
 2 pedestals with 1 lock-core each = 2
Total silver lock-cores per station = 4

Step 2 — Count the total number of workstations needing 4 lock-cores.

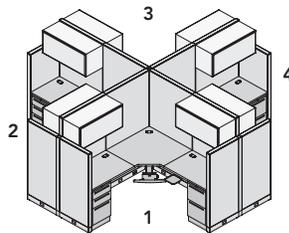

4 total workstations

Step 3 — Specify model number based on total number of lock-cores in a station and quantity of kits based on number of workstations.

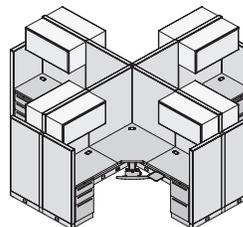

LKFE4SLV.X.4

Lock-Cores per station
 Color of Core
 Number of workstations

Exterior Width	Model	P1 Paint List Price	P2 Paint List Price	P3 Paint List Price
Touch-Up Paint — Brush				
Bottle of Touch-Up Paint with Brush — 0.5 oz.	APTK S	\$ 102	\$ 114	\$ 122
Touch-Up Paint — Spray				
Spray Can of Touch-Up Paint — 12 oz.	ARSLCC S	\$ 102	\$ 114	\$ 122

<p>How to specify — Select the Model Number from above.</p> <p>A .</p>	<p>1st Option: Paint Color: P1 P2 P3</p> <p>See pages 18-21 for options.</p> <p> </p>
---	--

Examples: APTK.P02 ARSLCC.P02

S Shippable by small-package carrier.

Model Number	Grade 13	Grade 14	Grade 15	Grade 16	Grade 17	Grade 18	Grade 19	Grade 20	Grade 21	Grade 22
Align™ and Essentials™ Pedestal Seat Cushion Tops — see page 66										
ASPT-24SC 23½"D	\$ 534	\$ 559	\$ 582	\$ 607	\$ 632	\$ 657	\$ 680	\$ 705	\$ 730	\$ 754
ASPT-30SC 29½"D	\$ 548	\$ 573	\$ 596	\$ 621	\$ 646	\$ 671	\$ 694	\$ 719	\$ 744	\$ 768
YPPA1815SC 17"D	\$ 488	\$ 513	\$ 536	\$ 561	\$ 586	\$ 611	\$ 634	\$ 659	\$ 684	\$ 708
YPPA2415SC 23"D	\$ 539	\$ 564	\$ 587	\$ 612	\$ 637	\$ 662	\$ 685	\$ 710	\$ 735	\$ 759
YPPA3015SC 29"D	\$ 554	\$ 579	\$ 602	\$ 627	\$ 652	\$ 677	\$ 700	\$ 725	\$ 750	\$ 774

Model Number	Description	Grade G	Grade H	Grade J
30"H Tackboards — see page 242				
WKTKFT4H30-FA	30"W	\$ 759	\$ 819	\$ 879
WKTKFT4H36-FA	36"W	\$ 820	\$ 892	\$ 963
WKTKFT4H42-FA	42"W	\$ 911	\$ 995	\$ 1078
WKTKFT4H48-FA	48"W	\$ 1006	\$ 1103	\$ 1198
WKTKFT4H54-FA	54"W	\$ 1081	\$ 1188	\$ 1295
WKTKFT4H60-FA	60"W	\$ 1172	\$ 1292	\$ 1412
WKTKFT4H66-FA	66"W (2 Piece)	\$ 1234	\$ 1365	\$ 1497
WKTKFT4H72-FA	72"W (2 Piece)	\$ 1362	\$ 1506	\$ 1650
WKTKFT4H78-FA	78"W (2 Piece)	\$ 1441	\$ 1595	\$ 1752
WKTKFT4H84-FA	84"W (2 Piece)	\$ 1530	\$ 1698	\$ 1866
WKTKFT4H90-FA	90"W (3 Piece)	\$ 1606	\$ 1785	\$ 1964
WKTKFT4H96-FA	96"W (2 Piece)	\$ 1686	\$ 1878	\$ 2069

34"H Tackboards — see page 242				
WKTKFT4H30-LA	30"W	\$ 811	\$ 879	\$ 948
WKTKFT4H36-LA	36"W	\$ 876	\$ 959	\$ 1039
WKTKFT4H42-LA	42"W	\$ 973	\$ 1069	\$ 1162
WKTKFT4H48-LA	48"W	\$ 1075	\$ 1182	\$ 1291
WKTKFT4H54-LA	54"W	\$ 1154	\$ 1276	\$ 1398
WKTKFT4H60-LA	60"W	\$ 1256	\$ 1391	\$ 1526
WKTKFT4H66-LA	66"W (2 Piece)	\$ 1327	\$ 1475	\$ 1625
WKTKFT4H72-LA	72"W (2 Piece)	\$ 1458	\$ 1621	\$ 1784
WKTKFT4H78-LA	78"W (2 Piece)	\$ 1550	\$ 1727	\$ 1903
WKTKFT4H84-LA	84"W (2 Piece)	\$ 1639	\$ 1828	\$ 2018
WKTKFT4H90-LA	90"W (3 Piece)	\$ 1733	\$ 1937	\$ 2142
WKTKFT4H96-LA	96"W (2 Piece)	\$ 1817	\$ 2034	\$ 2251

Model Number	Description	Grade G	Grade H	Grade J
45"H Tackboards — see page 243				
WKTKFT5H30-FA	30"W	\$ 919	\$ 1010	\$ 1100
WKTKFT5H36-FA	36"W	\$ 998	\$ 1105	\$ 1212
WKTKFT5H42-FA	42"W	\$ 1111	\$ 1235	\$ 1361
WKTKFT5H48-FA	48"W	\$ 1233	\$ 1377	\$ 1521
WKTKFT5H54-FA	54"W	\$ 1330	\$ 1492	\$ 1654
WKTKFT5H60-FA	60"W	\$ 1449	\$ 1628	\$ 1807
WKTKFT5H66-FA	66"W (2 Piece)	\$ 1537	\$ 1734	\$ 1932
WKTKFT5H72-FA	72"W (2 Piece)	\$ 1688	\$ 1904	\$ 2120
WKTKFT5H78-FA	78"W (2 Piece)	\$ 1795	\$ 2028	\$ 2261
WKTKFT5H84-FA	84"W (2 Piece)	\$ 1908	\$ 2159	\$ 2411
WKTKFT5H90-FA	90"W (3 Piece)	\$ 2007	\$ 2276	\$ 2545
WKTKFT5H96-FA	96"W (2 Piece)	\$ 2112	\$ 2401	\$ 2689

49"H Tackboards — see page 243				
WKTKFT5H30-LA	30"W	\$ 968	\$ 1065	\$ 1162
WKTKFT5H36-LA	36"W	\$ 1054	\$ 1170	\$ 1289
WKTKFT5H42-LA	42"W	\$ 1180	\$ 1316	\$ 1453
WKTKFT5H48-LA	48"W	\$ 1307	\$ 1463	\$ 1619
WKTKFT5H54-LA	54"W	\$ 1407	\$ 1584	\$ 1760
WKTKFT5H60-LA	60"W	\$ 1539	\$ 1733	\$ 1929
WKTKFT5H66-LA	66"W (2 Piece)	\$ 1629	\$ 1845	\$ 2061
WKTKFT5H72-LA	72"W (2 Piece)	\$ 1792	\$ 2027	\$ 2262
WKTKFT5H78-LA	78"W (2 Piece)	\$ 1908	\$ 2163	\$ 2417
WKTKFT5H84-LA	84"W (2 Piece)	\$ 2020	\$ 2294	\$ 2567
WKTKFT5H90-LA	90"W (3 Piece)	\$ 2133	\$ 2425	\$ 2718
WKTKFT5H96-LA	96"W (2 Piece)	\$ 2242	\$ 2554	\$ 2867

FSC Certified Wood at Allsteel

Allsteel has received FSC Chain of Custody certification and can offer FSC certified products. Forest Stewardship Council (FSC) certification is intended to promote the sustainable harvesting of forests worldwide by setting requirements for the forest and everyone who handles the wood from forest to product. Certification provides a Chain of Customer number that we will pass on to customers who are pursuing LEED certification or who want to ensure that materials used to manufacture our wood products come from a well-managed forest. For more information, please contact Customer Support at 888-255-7833.

Appendix

Fabric Grade Pricing

Model Number	Grade 9	Grade 10	Grade 11	Grade 12	Grade 13	Grade 14	Grade 15	Grade 16	Grade 17	Grade 18	Grade 19	Grade 20	Grade 21	Grade 22
Radii Storage Seat Cushions – 19"D — see page 138														
AESC18	\$ 398	\$ 416	\$ 437	\$ 456	\$ 480	\$ 505	\$ 528	\$ 553	\$ 578	\$ 603	\$ 626	\$ 651	\$ 676	\$ 700
Radii Storage Seat Cushions – 23"D — see page 138														
AESC24	\$ 443	\$ 461	\$ 482	\$ 501	\$ 525	\$ 550	\$ 573	\$ 598	\$ 623	\$ 648	\$ 671	\$ 696	\$ 721	\$ 745
Involve® Ped/Credenza Cushions – 18"D — see page 281														
K5CT1815SC	\$ 641	\$ 680	\$ 719	\$ 759	\$ 807	\$ 856	\$ 904	\$ 954	\$ 1002	\$ 1052	\$ 1100	\$ 1150	\$ 1198	\$ 1247
K5CT1818SC	\$ 664	\$ 703	\$ 742	\$ 782	\$ 830	\$ 879	\$ 927	\$ 977	\$ 1025	\$ 1075	\$ 1123	\$ 1173	\$ 1221	\$ 1270
K5CT1824SC	\$ 692	\$ 731	\$ 770	\$ 810	\$ 858	\$ 907	\$ 955	\$ 1005	\$ 1053	\$ 1103	\$ 1151	\$ 1201	\$ 1249	\$ 1298
K5CT1830SC	\$ 724	\$ 763	\$ 802	\$ 842	\$ 890	\$ 939	\$ 987	\$ 1037	\$ 1085	\$ 1135	\$ 1183	\$ 1233	\$ 1281	\$ 1330
K5CT1836SC	\$ 780	\$ 819	\$ 858	\$ 898	\$ 946	\$ 995	\$ 1043	\$ 1093	\$ 1141	\$ 1191	\$ 1239	\$ 1289	\$ 1337	\$ 1386
K5CT1848SC	\$ 795	\$ 834	\$ 873	\$ 913	\$ 961	\$ 1010	\$ 1058	\$ 1108	\$ 1156	\$ 1206	\$ 1254	\$ 1304	\$ 1352	\$ 1401
Involve Ped/Credenza Cushions – 24"D — see page 281														
K5CT2415SC	\$ 752	\$ 803	\$ 853	\$ 904	\$ 966	\$ 1028	\$ 1091	\$ 1154	\$ 1217	\$ 1279	\$ 1342	\$ 1405	\$ 1468	\$ 1531
K5CT2418SC	\$ 758	\$ 809	\$ 859	\$ 910	\$ 972	\$ 1034	\$ 1097	\$ 1160	\$ 1223	\$ 1285	\$ 1348	\$ 1411	\$ 1474	\$ 1537
K5CT2424SC	\$ 791	\$ 842	\$ 892	\$ 943	\$ 1005	\$ 1067	\$ 1130	\$ 1193	\$ 1256	\$ 1318	\$ 1381	\$ 1444	\$ 1507	\$ 1570
K5CT2430SC	\$ 823	\$ 874	\$ 924	\$ 975	\$ 1037	\$ 1099	\$ 1162	\$ 1225	\$ 1288	\$ 1350	\$ 1413	\$ 1476	\$ 1539	\$ 1602
K5CT2436SC	\$ 861	\$ 912	\$ 962	\$ 1013	\$ 1075	\$ 1137	\$ 1200	\$ 1263	\$ 1326	\$ 1388	\$ 1451	\$ 1514	\$ 1577	\$ 1640
K5CT2448SC	\$ 920	\$ 971	\$ 1021	\$ 1072	\$ 1134	\$ 1196	\$ 1259	\$ 1322	\$ 1385	\$ 1447	\$ 1510	\$ 1573	\$ 1636	\$ 1699
Involve Banquette Cushions – 24"D — see page 286														
K5C2424	\$ 1913	\$ 1974	\$ 2034	\$ 2095	\$ 2170	\$ 2247	\$ 2322	\$ 2398	\$ 2474	\$ 2550	\$ 2625	\$ 2701	\$ 2776	\$ 2853
K5C3624	\$ 2331	\$ 2392	\$ 2452	\$ 2513	\$ 2588	\$ 2665	\$ 2740	\$ 2816	\$ 2892	\$ 2968	\$ 3043	\$ 3119	\$ 3194	\$ 3271
Involve Seat Base Cushions – 24"D — see page 286														
K5SC2424	\$ 954	\$ 983	\$ 1014	\$ 1043	\$ 1081	\$ 1118	\$ 1155	\$ 1193	\$ 1230	\$ 1267	\$ 1305	\$ 1342	\$ 1379	\$ 1416

Cross Reference Index

by Model Number

Model	Page	Model	Page	Model	Page	Model	Page	Model	Page
2282-300	113	APADD	330	AW4WCTIBC36W	313	ELF830SS	114	ISLAUT2PYB4836S2	99
2282-400	113	APASD	330	AW4WCTIBC57W	313	ELF836NA	114	ISLAUT2PYB4836S4	99
A6REC252LFC	247	APASDCK	331	AW4WCTIP36W	313	ELF836NB	114	ISLAUT2PYB6018S2	98
A6REC252LTF	247	APATF	330	AW4WCTIP57W	313	ELF836NI	114	ISLAUT2PYB6018S5	98
A87P2UIR	286	APFB80	113	AWCS	316	ELF836NS	114	ISLAUT2PYB6036S2	99
A944	122	APGBP18SNPT	137	CSDC19	322	ELF836SA	114	ISLAUT2PYB6036S5	99
A945	122	APGBP18SNPTE	139	CSDC25	322	ELF836SB	114	ISLAUT2PYB7218S2	98
A994	122	APGBP186NPT	137	EACS	321	ELF836SI	114	ISLAUT2PYB7218S3	98
A995	122	APGBP186NPTE	139	EABS	321	ELF836SS	114	ISLAUT2PYB7218S6	98
A995C	122	APGBP189TFNE	137	EACS	321	ELF842NA	114	ISLAUT2PYB7236S2	99
A2280-000	51, 113, 206, 274	APGBP189TFNE	139	EADH	321	ELF842NB	114	ISLAUT2PYB7236S3	99
A870302	327	APGBP246NPT	137	EAFS	321	ELF842NI	114	ISLAUT2PYB7236S6	99
A870824	325	APGBP246NPTE	139	EAFI	321	ELF842NS	114	ISLAUT2PYB8418S2	98
A870824CH	325	APGBP249TFN	137	EAHSR36	320	ELF842SA	114	ISLAUT2PYB8418S7	98
A870830	325	APGBP249TFNE	139	EAHSR42	320	ELF842SB	114	ISLAUT2PYB8436S2	99
A870830CH	325	APGBS24SNPT	137	EAHSR48	320	ELF842SI	114	ISLAUT2PYB8436S7	99
A870842	325	APGBS24SNPTE	139	EAHSR60	320	ELF842SS	114	ISLAUT2PYB9018S3	98
A870842CH	325	APGBS249TFN	137	EAHSR66	320	ESC230A	116	ISLAUT2PYB9036S3	99
A870860	325	APGBS249TFNE	139	EAHSR72	320	ESC230B	116	ISLAUTNPNB2418S1	96
A870860CH	325	APGCP189TPN	137	EAPS	321	ESC230L	116	ISLAUTNPNB2436S1	96
AAPACM2	325	APGCP189TPNE	139	EAPT	321	ESC230S	116	ISLAUTNPNB3018S1	96
ACD1	322	APGCP249TPN	137	EASR24	320	ESC236A	116	ISLAUTNPNB3036S1	96
ACMCM2IO	145	APGCP249TPNE	139	EASR30	320	ESC236B	116	ISLAUTNPNB3618S1	96
ACMCM2IT	145	APGCS249TPN	137	EASR36	320	ESC236I	116	ISLAUTNPNB3618S3	96
ACMCOM2E	327	APGCS249TPNE	139	EASR42	320	ESC236S	116	ISLAUTNPNB3636S1	96
ACPU1	316	APMAP186NFN	137	EASR48	320	ESC330A	116	ISLAUTNPNB3636S3	96
AECH	142	APMAP186NFNE	139	EASR60	320	ESC330B	116	ISLAUTNPNB4218S1	96
AEHF	142	APMAP246NFN	137	EASS	321	ESC330L	116	ISLAUTNPNB4236S1	96
AELT	142	APMAP246NFNE	139	EATS	321	ESC330S	116	ISLAUTNPNB4818S1	96
AESC18	138	APMBP18SNPT	137	EB30	117	ESC336A	116	ISLAUTNPNB4818S2	96
AESC24	138	APMBP18SNPTE	140	EB42	117	ESC336B	116	ISLAUTNPNB4818S4	96
AESS	142	APMBP186NPT	138	EB60	117	ESC336I	116	ISLAUTNPNB4836S1	96
AEST	142, 228	APMBP186NPTE	140	EB72	117	ESC336S	116	ISLAUTNPNB4836S2	96
AEV920	245	APMBP189TFN	137	EB82	117	ESC436A	116	ISLAUTNPNB4836S4	96
AF397-203A	112	APMBP189TFNE	140	EB230	117	ESC436B	116	ISLAUTNPNB6018S1	96
AF397-203B	112	APMBP246NPT	138	EB236	117	ESC436I	116	ISLAUTNPNB6018S2	96
AF397-203L	112	APMBP246NPTE	140	EB330	117	ESC436S	116	ISLAUTNPNB6018S5	96
AF397-203S	112	APMBP249TFN	137	EB336	117	ESC530A	116	ISLAUTNPNB6036S1	96
AF397-233A	112	APMBP249TFNE	140	EB436	117	ESC530B	116	ISLAUTNPNB6036S2	96
AF397-233B	112	APMBS24SNPT	137	EB530	117	ESC530L	116	ISLAUTNPNB6036S5	96
AF397-233L	112	APMBS24SNPTE	140	EB536	117	ESC530S	116	ISLAUTNPNB7218S1	96
AF397-233S	112	APMBS249TFN	137	ECF530HA	115	ESC536A	116	ISLAUTNPNB7218S2	96
AF398-202A	112	APMBS249TFNE	140	ECF530HB	115	ESC536B	116	ISLAUTNPNB7218S3	96
AF398-202B	112	APMC6	321	ECF530HI	115	ESC536I	116	ISLAUTNPNB7218S6	96
AF398-202L	112	APMCP189TPN	138	ECF530HS	115	ESC536S	116	ISLAUTNPNB7236S1	96
AF398-202S	112	APMCP189TPNE	140	ECF530NA	115	ETK2P28H	113	ISLAUTNPNB7236S2	96
AF398-232A	112	APMCP249TPN	138	ECF530NB	115	FBRZPWM	63	ISLAUTNPNB7236S3	96
AF398-232B	112	APMCP249TPNE	140	ECF530NI	115	G8870924	325	ISLAUTNPNB7236S6	96
AF398-232L	112	APMCS249TPN	138	ECF530NS	115	G8870930	325	ISLAUTNPNB8418S1	96
AF398-232S	112	APMCS249TFNE	140	ECF536HA	115	G8870948	325	ISLAUTNPNB8418S2	96
AJTRGH24	245	APOLG0512	64, 301	ECF536HB	115	G8870960	325	ISLAUTNPNB8418S7	96
AJTRGH36	245	APOLG0518	64, 301	ECF536HI	115	ISLAAB2P4842S2	100	ISLAUTNPNB8436S1	96
AKMH	316	APOLG0612	64	ECF536HS	115	ISLAAB2P4842S4	100	ISLAUTNPNB8436S2	96
AKTLONG	316	APOLG0618	64	ECF536NA	115	ISLAAB2P6042S5	100	ISLAUTNPNB8436S7	96
AKTMID	316	APTK	335	ECF536NB	115	ISLAAB2P7242S3	100	ISLAUTNPNB9018S1	96
AKTSHORT	316	APWRMOD1TT	327	ECF536NI	115	ISLAAB2P7242S6	100	ISLAUTNPNB9018S3	96
ALED17U	295, 325	APWRMOD1UWM	327	ECF536NS	115	ISLAAB2P8442S7	100	ISLAUTNPNB9036S1	96
ALED17U60	325	APWRMOD2Q	327	ELF330NA	114	ISLAABEN1842	100	ISLAUTNPNB9036S3	96
ALED17UJMP30	325	APWRMOD2UWM	327	ELF330NB	114	ISLAAESP3642	101	K2T113618A	285
ALED31U	295, 325	APWRMOD2WC	327	ELF342NS	114	ISLAAEYB1842L	100	K2T113624A	285
ALED31U60	325	APWRMOD3UWM	327	ELF430NA	114	ISLAAEYB1842R	100	K2T114818A	285
ALED31UJMP30	325	APWRMOD3WC	327	ELF430NB	114	ISLAAEYB3642	100	K2T114824A	285
ALED3OC	325	ARSLCC	335	ELF430NI	114	ISLAEO3642	101	K2T172424CT	274, 285
ALKF23C	333	ASISLABEL5	65, 114	ELF430NS	114	ISLAEB2P6040S2	100	K2T174818LAF	274
ALKF23CE4	333	ASPT-245C	66, 113	ELF430NA	114	ISLAEB2P7240S2	100	K2T174818RAF	274
ALKF23CN	333	ASPT-305C	66, 113	ELF342NA	114	ISLAEB2P8440S2	100	K2T174824LAF	274
ALKF26EL	65, 333	ASPTP-24LL	51	ELF342NB	114	ISLAEB2P9040S3	100	K2T174824RAF	274
AM387-203A	112	ASPTP-30LL	51	ELF342NI	114	ISLAENB1842	100	K2T176018LAF	274
AM387-203B	112	AUCH15N	142	ELF342NS	114	ISLAEESP3642	101	K2T176018RAF	274
AM387-203L	112	AUCH15NE	144	ELF430NA	114	ISLAAEYB1842L	100	K2T241518MBF	273
AM387-203S	112	AUCH15U	142	ELF430NB	114	ISLAAEYB1842R	100	K2T241818A	276
AM387-233A	112	AUCH15UE	144	ELF430NI	114	ISLAAEYB3642	100	K2T241818BF	273
AM387-233B	112	AUCH15N	142	ELF430NS	114	ISLAEO3642	101	K2T241824A	276
AM387-233L	112	AUCH15NE	144	ELF436NA	114	ISLAUT1PYB4836S2	99	K2T241824BF	273
AM387-233S	112	AUCH15U	142	ELF436NB	114	ISLAUT1PYB4836S4	99	K2T242418A	276
AM388-202A	112	AUCH15UE	144	ELF436NI	114	ISLAUT1PYB6036S2	99	K2T242424A	276
AM388-202B	112	AUCL15N	142	ELF436NS	114	ISLAUT1PYB6036S5	99	K2T243018A	276
AM388-202L	112	AUCL15U	142	ELF442NA	114	ISLAUT1PYB7236S2	99	K2T243018BF	275
AM388-202S	112	AUFD15N	142	ELF442NB	114	ISLAUT1PYB7236S3	99	K2T243024A	276
AM388-232A	112	AUFD15NE	144	ELF442NI	114	ISLAUT1PYB7236S6	99	K2T243024BF	275
AM388-232B	112	AUFH15N	142	ELF442NS	114	ISLAUT1PYB8436S2	99	K2T243618A	276
AM388-232L	112	AUFH15NE	144	ELF530NA	114	ISLAUT1PYB8436S7	99	K2T243618E	275
AM388-232S	112	AUFH15N	142	ELF530NB	114	ISLAUT1PYB9036S3	99	K2T243618N	276
AMADHD	330	AUFHL15NE	144	ELF530NI	114	ISLAUT2PNB2418S1	97	K2T243624A	276
AMASD	330	AUFO15N	142	ELF530NS	114	ISLAUT2PNB3018S1	97	K2T243624E	275
AMASD-G	330	AVSTA3PWR	327	ELF536NA	114	ISLAUT2PNB3618S1	97	K2T243624N	276
AMASHD	330	AW4AVRACK	312	ELF536NB	114	ISLAUT2PNB3618S3	97	K2T244818LAF	275
AMASHDCK	331	AW4BC4824L	312	ELF536NI	114	ISLAUT2PNB4218S1	97	K2T244818N	276
AMASTS	330	AW4BC4824LNG	312	ELF536NS	114	ISLAUT2PNB4818S2	97	K2T244818RAF	275
AMASTSCK	331	AW4BC4824RNG	312	ELF542NA	114	ISLAUT2PNB4818S4	97	K2T244824LAF	275
AMASTS-G	330	AW4BC4824RNG	312	ELF542NB	114	ISLAUT2PNB6018S2	97	K2T244824N	276
AMF22	333	AW4BC7224	312	ELF542NI	114	ISLAUT2PNB6018S5	97	K2T244824RAF	275
AMKF22	333, 334	AW4C7224NG	312	ELF542NS	114	ISLAUT2PNB7218S2	97	K2T246018LAF	275
AP22PBKRLH	64, 81	AW4DRAWER	312	ELF830NA	114	ISLAUT2PNB7218S3	97	K2T246018RAF	275
AP22PBKRRH	64, 81	AW4SHELF	312	ELF830NB	114	ISLAUT2PNB7218S6	97	K2T246024LAF	275
AP1050CST	113	AW4TRASH	312	ELF830NI	114	ISLAUT2PNB8418S2	97	K2T246024RAF	275
AP20040AG	113	AW4WC36LABEL	313	ELF830NS	114	ISLAUT2PNB8418S7	97	K2T247218LAF	275
AP519495	113	AW4WC57LABEL	313	ELF830SA	114	ISLAUT2PNB9018S3	97	K2T247218RAF	275
APACSM	331	AW4WC3620	313	ELF830SB	114	ISLAUT2PYB4818S2	98	K2T247224LAF	275
APACW	331	AW4WC5720	313	ELF830SI	114	ISLAUT2PYB4818S4	98	K2T247224RAF	275

Cross Reference Index

by Model Number

Model	Page	Model	Page	Model	Page	Model	Page	Model	Page
K2T281518BBF	273	K2TH4284H	297	K2TP283024BBF	277	K2TPT651824RFF	290	K2TT721824RFF	291
K2T281518FF	273	K2TH4284N	297	K2TP283024FF	277	K2TPT652424L	290	K2TT722424L	291
K2T281524BBF	273	K2TOC072415SH	294	K2TP283618A	278	K2TPT652424LBBF	290	K2TT722424LBBF	291
K2T281524FF	273	K2TOC073015SH	294	K2TP283618E	277	K2TPT652424LFF	290	K2TT722424LFF	291
K2T281530BBF	273	K2TOC073615SH	294	K2TP283618FF	277	K2TPT652424R	290	K2TT722424R	291
K2T281530FF	273	K2TOC074215SH	294	K2TP283618N	278	K2TPT652424RBBF	290	K2TT722424RBBF	291
K2T281818A	273	K2TOC152415SH	293	K2TP283624A	278	K2TPT652424RFF	290	K2TT722424RFF	291
K2T281818BBF	273	K2TOC152415A	293	K2TP283624E	277	K2TPT721824L	291	K5CT15365C	310
K2T281818FF	273	K2TOC152415H	293	K2TP283624FF	277	K2TPT721824LBBF	291	K5CT18155C	281
K2T281824A	273	K2TOC152415N	293	K2TP283624N	278	K2TPT721824LFF	291	K5CT1818L	281
K2T281824BBF	273	K2TOC153015A	293	K2TP284818N	278	K2TPT721824RFF	291	K5CT18185C	281
K2T281824FF	273	K2TOC153015H	293	K2TP284824N	278	K2TPT721824R	291	K5CT1824L	281
K2T281830BBF	273	K2TOC153015N	293	K2TP243618FF	279	K2TPT721824RBBF	291	K5CT18245C	66, 281
K2T281830FF	273	K2TOC153615A	293	K2TPB112424A	285	K2TPT722424L	291	K5CT1830L	281
K2T282418A	278	K2TOC153615H	293	K2TPB112424F	285	K2TPT722424LBBF	291	K5CT18305C	66, 281
K2T282418BBF	277	K2TOC153615N	293	K2TPB113624A	285	K2TPT722424LFF	291	K5CT1836L	281
K2T282424A	278	K2TOC154215H	293	K2TPB113624F	285	K2TPT722424R	291	K5CT18365C	66, 281
K2T282424BBF	277	K2TOC154215SH	293	K2TPB114824A	285	K2TPT722424RBBF	291	K5CT18425C	66
K2T283018A	278	K2TOC154215N	293	K2TPB114824F	285	K2TPT722424RFF	291	K5CT1848L	281
K2T283018BBF	277	K2TOC154815A	293	K2TPBC653015A	280	K2TST501818LBBF	288	K5CT18485C	66, 281
K2T283018FF	277	K2TOC154815H	293	K2TPBC653024F	280	K2TST501818LFF	288	K5CT24155C	281
K2T283024A	278	K2TOC154815N	293	K2TPBC653615A	280	K2TST501818RBBF	288	K5CT2418L	281
K2T283024BBF	277	K2TOC156015A	293	K2TPBC653624F	280	K2TST501818RFF	288	K5CT24185C	281
K2T283024FF	277	K2TOC156015H	293	K2TPBC723015A	280	K2TST501824LBBF	288	K5CT2424L	281
K2T283618A	278	K2TOC156015N	293	K2TPBC723024F	280	K2TST501824LFF	288	K5CT24245C	66, 281
K2T283618E	277	K2TOC157215H	293	K2TPBC723615A	280	K2TST501824RBBF	288	K5CT2430L	281
K2T283618FF	277	K2TOC157215N	293	K2TPBC723624F	280	K2TST501824RFF	288	K5CT24305C	66, 281
K2T283618N	278	K2TOC158415H	293	K2TPF173018	274	K2TST502418LBBF	288	K5CT2436L	281
K2T283624A	278	K2TOC158415N	293	K2TPF173024	274	K2TST502418LFF	288	K5CT24365C	66, 281
K2T283624E	277	K2TOC159615H	293	K2TPF173618	274	K2TST502418RBBF	288	K5CT2448L	281
K2T283624FF	277	K2TOC159615N	293	K2TPF173624	274	K2TST502418RFF	288	K5CT24485C	66, 281
K2T283624N	278	K2TOC232415H	294	K2TPST501818LBBF	288	K2TST502424LBBF	288	K6DM2829L	302
K2T284818N	278	K2TOC233015H	294	K2TPST501818LFF	288	K2TST502424LFF	288	K6DM2830L	302
K2T284824N	278	K2TOC233615H	294	K2TPST501818RBBF	288	K2TST502424RBBF	288	K6DM2834L	302
K2T2423618FF	279	K2TOC234215H	294	K2TPST501818RFF	288	K2TST502424RFF	288	K6DM2835L	302
K2TB112424A	285	K2TOC234815H	294	K2TPST501824LBBF	288	K2TST571818LBBF	289	K6DM2836L	302
K2TB112424F	285	K2TOC236015H	294	K2TPST501824LFF	288	K2TST571818LFF	289	K6DM2840L	302
K2TB113624A	285	K2TP113618A	285	K2TPST501824RBBF	288	K2TST571818RBBF	289	K6DM2841L	302
K2TB113624F	285	K2TP113624A	285	K2TPST501824RFF	288	K2TST571818RFF	289	K6DM2842L	302
K2TB114824A	285	K2TP114818A	285	K2TPST502418LBBF	288	K2TST571824LBBF	289	K6DM2843L	302
K2TB114824F	285	K2TP114824A	285	K2TPST502418LFF	288	K2TST571824LFF	289	K6DM2846L	302
K2TBC653015A	280	K2TP172424CT	274, 285	K2TPST502418RBBF	288	K2TST571824RBBF	289	K6DM2847L	302
K2TBC653024F	280	K2TP174818LAF	274	K2TPST502418RFF	288	K2TST571824RFF	289	K6DM2849L	302
K2TBC653615A	280	K2TP174818RAF	274	K2TPST502424LBBF	288	K2TST572418LBBF	289	K6DM2853L	302
K2TBC653624F	280	K2TP174824LAF	274	K2TPST502424LFF	288	K2TST572418LFF	289	K6DM2855L	302
K2TBC723015A	280	K2TP174824RAF	274	K2TPST502424RBBF	288	K2TST572418RBBF	289	K6DM2858L	302
K2TBC723024F	280	K2TP176018LAF	274	K2TPST502424RFF	288	K2TST572418RFF	289	K6DM2859L	302
K2TBC723615A	280	K2TP176018RAF	274	K2TPST571818LBBF	289	K2TST572424LBBF	289	K6DM2861L	302
K2TBC723624F	280	K2TP241818A	276	K2TPST571818LFF	289	K2TST572424LFF	289	K6DM2864L	302
K2TC153618S	294	K2TP241818BBF	276	K2TPST571818RBBF	289	K2TST572424RBBF	289	K6DM2870L	302
K2TC154818S	294	K2TP241824A	273	K2TPST571818RFF	289	K2TST572424RFF	289	K6DM2876L	302
K2TC156018S	294	K2TP241824BF	273	K2TPST571824LBBF	289	K2T421218L	287	K6DMP2830L	302
K2TC201818A	292	K2TP242418A	276	K2TPST571824LFF	289	K2T421218R	287	K6DMP2834L	302
K2TC201818LH	292	K2TP242424A	276	K2TPST571824RBBF	289	K2T421224L	287	K6DMP2836L	302
K2TC201818RH	292	K2TP243018A	276	K2TPST571824RFF	289	K2T421224R	287	K6DMP2840L	302
K2TC202418A	292	K2TP243018BBF	275	K2TPST572418LBBF	289	K2T501218L	287	K6DMP2842L	302
K2TC271818A	292	K2TP243024A	276	K2TPST572418LFF	289	K2T501218R	287	K6DMP2846L	302
K2TC271818LH	292	K2TP243024BF	275	K2TPST572418RBBF	289	K2T501224L	287	K6DP5029L	303
K2TC271818RH	292	K2TP243618A	276	K2TPST572418RFF	289	K2T501224R	287	K6DP5035L	303
K2TC272418A	292	K2TP243618E	275	K2TPST572424LBBF	289	K2T501824LBBF	288	K6DP5047L	303
K2TC351818A	292	K2TP243618N	276	K2TPST572424LFF	289	K2T501824LFF	288	K6DP5059L	303
K2TC351818LH	292	K2TP243624A	276	K2TPST572424RBBF	289	K2T501824RBBF	288	K6OLG0512	301
K2TC351818RH	292	K2TP243624E	275	K2TPST572424RFF	289	K2T501824RFF	288	K6OLG515L	295
K2TC352418A	292	K2TP243624N	276	K2TPT421218L	287	K2T502424LBBF	288	K6OLG0518	301
K2TC421818A	292	K2TP244818LAF	275	K2TPT421218R	287	K2T502424LFF	288	K6OLG518L	295
K2TC421818LH	292	K2TP244818RAF	275	K2TPT421224L	287	K2T502424RBBF	288	K6OLG1107	295
K2TC421818RH	292	K2TP244818A	275	K2TPT421224R	287	K2T502424RFF	288	K6OLG1115L	295
K2TC422418A	292	K2TP244824LAF	275	K2TPT501218L	287	K2T571218L	287	K6OLG1118L	295
K2TF173018	274	K2TP244824RAF	275	K2TPT501218R	287	K2T571218R	287	K6OLG1207	295
K2TF173024	274	K2TP246018LAF	275	K2TPT501224L	287	K2T571224L	287	K6OLG1215L	295
K2TF173618	274	K2TP246018RAF	275	K2TPT501224R	287	K2T571224R	287	K6OLG1218L	295
K2TF173624	274	K2TP246018A	275	K2TPT501824LBBF	288	K2T571824LBBF	289	K6OLG1807	295
K2TH3548A	297	K2TP246024LAF	275	K2TPT501824LFF	288	K2T571824LFF	289	K6OLG1815L	295
K2TH3548H	297	K2TP246024RAF	275	K2TPT501824RBBF	288	K2T571824RBBF	289	K6OLG1907	295
K2TH3548N	297	K2TP247218LAF	275	K2TPT501824RFF	288	K2T571824RFF	289	K6OLG1915L	295
K2TH3560A	297	K2TP247218RAF	275	K2TPT502424LBBF	288	K2T572424LBBF	289	K6TB1230T	304
K2TH3560H	297	K2TP247224LAF	275	K2TPT502424LFF	288	K2T572424LFF	289	K6TB1236T	304
K2TH3560N	297	K2TP247224RAF	275	K2TPT502424RBBF	288	K2T572424RBBF	289	K6TB1242T	304
K2TH3566A	297	K2TP281518BBF	273	K2TPT502424RFF	288	K2T572424RFF	289	K6TB1248T	304
K2TH3566H	297	K2TP281518FF	273	K2TPT571218L	287	K2T651218L	287	K6TB1260T	304
K2TH3566N	297	K2TP281524BBF	273	K2TPT571218R	287	K2T651218R	287	K6TB1830T	304
K2TH3572A	297	K2TP281524FF	273	K2TPT571224L	287	K2T651224L	287	K6TB1836T	304
K2TH3572H	297	K2TP281530BBF	273	K2TPT571224R	287	K2T651224R	287	K6TB1842T	304
K2TH3572N	297	K2TP281530FF	273	K2TPT571824LBBF	289	K2T651824L	290	K6TB1848T	304
K2TH3584A	297	K2TP281818A	273	K2TPT571824LFF	289	K2T651824LFF	290	K6TB1860T	304
K2TH3584H	297	K2TP281818BBF	273	K2TPT571824RBBF	289	K2T651824RFF	290	K6TB1930T	304
K2TH3584N	297	K2TP281818FF	273	K2TPT571824RFF	289	K2T651824R	290	K6TB1936T	304
K2TH4248A	297	K2TP281824A	273	K2TPT572424LBBF	289	K2T651824RBBF	290	K6TB1942T	304
K2TH4248H	297	K2TP281824BBF	273	K2TPT572424LFF	289	K2T651824RFF	290	K6TB1948T	304
K2TH4248N	297	K2TP281824FF	273	K2TPT572424RBBF	289	K2T652424L	290	K6TB1960T	304
K2TH4260A	297	K2TP281830BBF	273	K2TPT572424RFF	289	K2T652424LBBF	290	K6TB2630T	304
K2TH4260H	297	K2TP281830FF	273	K2TPT651218L	287	K2T652424LFF	290	K6TB2636T	304
K2TH4260N	297	K2TP282418A	278	K2TPT651218R	287	K2T652424R	290	K6TB2642T	304
K2TH4266A	297	K2TP282418BBF	277	K2TPT651224L	287	K2T652424RBBF	290	K6TB2648T	304
K2TH4266H	297								

Cross Reference Index

by Model Number

Model	Page	Model	Page	Model	Page	Model	Page	Model	Page
K6TB3548T	298	KL283018A	278	KLH4272A	297	KLP282418BBF	277	KLPT571224R	287
K6TB3560T	298	KL283018BBF	277	KLH4272H	297	KLP282424A	278	KLPT571824LBBF	289
K6TB3566T	298	KL283018FF	277	KLH4272N	297	KLP282424BBF	277	KLPT571824LFF	289
K6TB3572T	298	KL283024A	278	KLH4284A	297	KLP283018A	278	KLPT571824RBBF	289
K6TB3584T	298	KL283024BBF	277	KLH4284H	297	KLP283018BBF	277	KLPT571824RFF	289
K6TB4248T	298	KL283024FF	277	KLH4284N	297	KLP283018FF	277	KLPT572424LBBF	289
K6TB4260T	298	KL283618A	278	KL283618A	278	KLP283024A	278	KLPT572424LFF	289
K6TB4266T	298	KL283618E	277	KLOC073615SH	294	KLP283024BBF	277	KLPT572424RBBF	289
K6TB4272T	298	KL283618FF	277	KLOC073615SH	294	KLP283024FF	277	KLPT572424RFF	289
K6TB4284T	298	KL283618N	278	KLOC074215SH	294	KLP283618A	278	KLPT651218L	287
K6TBK	295	KL283624A	278	KLOC074815SH	294	KLP283618E	277	KLPT651218R	287
K6TR18	291, 301	KL283624E	277	KLOC152415A	293	KLP283618FF	277	KLPT651224L	287
K605LSSPK	285	KL283624FF	277	KLOC152415H	293	KLP283618N	278	KLPT651224R	287
K605RSSPK	285	KL283624N	278	KLOC152415N	293	KLP283624A	278	KLPT651824L	290
K624PBKL	282, 300	KL284818N	278	KLOC153015A	293	KLP283624E	277	KLPT651824LBBF	290
K624PBKML	282, 300	KL284824N	278	KLOC153015H	293	KLP283624FF	277	KLPT651824LFF	290
K624PBKMR	282, 300	KL423618FFF	279	KLOC153015N	293	KLP283624N	278	KLPT651824R	290
K624PBKR	282, 300	KL283618A	278	KLOC153615A	293	KLP284818N	278	KLPT651824RBBF	290
K629SCF	301	KL283618E	277	KLOC153615H	293	KLP284824N	278	KLPT651824RFF	290
K630PBKL	282, 300	KL283618N	278	KLOC153615N	293	KLP423618FFF	279	KLPT652424L	290
K630PBKML	282, 300	KL283618FF	277	KLOC154215A	293	KLPB112424A	285	KLPT652424LBBF	290
K630PBKMR	282, 300	KL283618N	278	KLOC154215H	293	KLPB112424F	285	KLPT652424LFF	290
K630PBKR	282, 300	KL283618E	277	KLOC154215N	293	KLPB113624A	285	KLPT652424R	290
K640SCF	301	KL283618FF	277	KLOC154815A	293	KLPB113624F	285	KLPT652424RBBF	290
K62918FEN	300	KL283624A	278	KLOC154815H	293	KLPB114824A	285	KLPT652424RFF	290
K62918LPEN	300	KL283624E	277	KLOC154815N	293	KLPB114824F	285	KLPT721824L	291
K62918OLG	300	KL283624N	278	KLOC156015A	293	KLPBC653015A	280	KLPT721824LBBF	291
K62918RPEN	300	KL423618FFF	279	KLOC156015H	293	KLPBC653024F	280	KLPT721824LFF	291
K62924FEN	300	KL283618A	278	KLOC156015N	293	KLPBC653615A	280	KLPT721824R	291
K62924LPEN	300	KL283618E	277	KLOC157215A	293	KLPBC653624F	280	KLPT721824RBBF	291
K62924OLG	300	KL283618FF	277	KLOC157215H	293	KLPBC723015A	280	KLPT721824RFF	291
K62924RPEN	300	KL283618N	278	KLOC157215N	293	KLPBC723024F	280	KLPT722424L	291
K62930FEN	300	KL283618E	277	KLOC158415A	293	KLPBC723615A	280	KLPT722424LBBF	291
K62930LPEN	300	KL283618FF	277	KLOC158415H	293	KLPBC723624F	280	KLPT722424LFF	291
K62930OLG	300	KL283618N	278	KLOC158415N	293	KLPBCB1730	274	KLPT722424R	291
K62930RPEN	300	KL283618A	278	KLOC159615A	293	KLPBCB1736	274	KLPT722424RBBF	291
K62936OLG	300	KL283618E	277	KLOC159615H	293	KLPBCB2418	273	KLPT722424RFF	291
K5306036EZ	299	KL283618FF	277	KLOC159615N	293	KLPBCB2430	275	KLSP45MK	294
K5307236EZ	299	KL283618N	278	KLOC232415H	294	KLPBCB2436	275	KLSPMK	294
K5307836EZ	299	KL283618E	277	KLOC233015H	294	KLPBCB2815	273	KLST501818LBBF	288
KL113618A	285	KL283618FF	277	KLOC233615H	294	KLPBCB2818	273	KLST501818LFF	288
KL113624A	285	KL283618N	278	KLOC234215H	294	KLPBCB2824	277	KLST501818RBBF	288
KL114818A	285	KL283618E	277	KLOC234815H	294	KLPBCB2830	277	KLST501818RFF	288
KL114824A	285	KL283618FF	277	KLOC236015H	294	KLPBCB2836	277	KLST501824LBBF	288
KL172424CT	274, 285	KL283618N	278	KLP113618A	285	KLPF173018	274	KLST501824LFF	288
KL174818LAF	274	KL283618A	278	KLP113624A	285	KLPF173024	274	KLST501824RBBF	288
KL174818RAF	274	KL283618E	277	KLP114818A	285	KLPF173618	274	KLST501824RFF	288
KL174824LAF	274	KL283618FF	277	KLP114824A	285	KLPF173624	274	KLST502418LBBF	288
KL174824RAF	274	KL283618N	278	KLP172424CT	274, 285	KLPBK	282	KLST502418LFF	288
KL176018LAF	274	KL283618E	277	KLP174818LAF	274	KLPST501818LBBF	288	KLST502418RBBF	288
KL176018RAF	274	KL283618FF	277	KLP174818RAF	274	KLPST501818LFF	288	KLST502418RFF	288
KL241518MBF	273	KL283618N	278	KLP174824LAF	274	KLPST501818RBBF	288	KLST502424LBBF	288
KL241818A	276	KL283618A	278	KLP174824RAF	274	KLPST501818RFF	288	KLST502424LFF	288
KL241818BF	273	KL283618E	277	KLP176018LAF	274	KLPST501824LBBF	288	KLST502424RBBF	288
KL241824A	276	KL283618FF	277	KLP176018RAF	274	KLPST501824LFF	288	KLST502424RFF	288
KL241824BF	273	KL283618N	278	KLP241818A	276	KLPST501824RBBF	288	KLST571818LBBF	289
KL242418A	276	KL283618A	278	KLP241818BF	273	KLPST501824RFF	288	KLST571818LFF	289
KL242424A	276	KL283618E	277	KLP241824A	276	KLPST502418LBBF	288	KLST571818RBBF	289
KL243018A	276	KL283618FF	277	KLP241824BF	273	KLPST502418LFF	288	KLST571818RFF	289
KL243018BF	275	KL283618N	278	KLP242418A	276	KLPST502418RBBF	288	KLST571824LBBF	289
KL243024A	276	KL283618A	278	KLP242424A	276	KLPST502418RFF	288	KLST571824LFF	289
KL243024BF	275	KL283618E	277	KLP243018A	276	KLPST502424LBBF	288	KLST571824RBBF	289
KL243618A	276	KL283618FF	277	KLP243018BF	275	KLPST502424LFF	288	KLST571824RFF	289
KL243618E	275	KL283618N	278	KLP243024A	276	KLPST502424RBBF	288	KLST572418LBBF	289
KL243618N	276	KL283618A	278	KLP243024BF	276	KLPST502424RFF	288	KLST572418LFF	289
KL243624A	276	KL283618E	277	KLP243618A	276	KLPST571818LBBF	289	KLST572418RBBF	289
KL243624E	275	KL283618FF	277	KLP243618E	275	KLPST571818LFF	289	KLST572418RFF	289
KL243624N	276	KL283618N	278	KLP243618N	276	KLPST571818RBBF	289	KLST572424LBBF	289
KL244818LAF	275	KL283618A	278	KLP243624A	276	KLPST571818RFF	289	KLST572424LFF	289
KL244818N	276	KL283618E	277	KLP243624E	275	KLPST571824LBBF	289	KLST572424RBBF	289
KL244818RAF	275	KL283618FF	277	KLP243624N	276	KLPST571824LFF	289	KLST572424RFF	289
KL244824LAF	275	KL283618N	278	KLP244818LAF	275	KLPST571824RBBF	289	KLPT421218L	287
KL244824N	276	KL283618A	278	KLP244818N	276	KLPST571824RFF	289	KLPT421218R	287
KL244824RAF	275	KL283618E	277	KLP244818RAF	275	KLPST572418LBBF	289	KLPT421224L	287
KL246018LAF	275	KL283618FF	277	KLP244824LAF	275	KLPST572418LFF	289	KLPT421224R	287
KL246018RAF	275	KL283618N	278	KLP244824RAF	275	KLPST572418RBBF	289	KLPT501218L	287
KL246024LAF	275	KL283618A	278	KLKG	282	KLPST572418RFF	289	KLPT501218R	287
KL246024RAF	275	KL283618E	277	KLP244824A	276	KLPST572424LBBF	289	KLPT501224L	287
KL247218LAF	275	KL283618FF	277	KLP246018RAF	275	KLPST572424LFF	289	KLPT501224R	287
KL247218RAF	275	KL283618N	278	KLP246024LAF	275	KLPST572424RBBF	289	KLPT501824LBBF	288
KL247224LAF	275	KL283618A	278	KLP246024RAF	275	KLPST572424RFF	289	KLPT501824LFF	288
KL247224RAF	275	KL283618E	277	KLP247218LAF	275	KLPST572424RBBF	289	KLPT501824RBBF	288
KL281518BBF	273	KL283618FF	277	KLP247218RAF	275	KLPST572424LFF	289	KLPT501824RFF	288
KL281518FF	273	KL283618N	278	KLP247224LAF	275	KLPST572424LBBF	289	KLPT502424LBBF	288
KL281524BBF	273	KL283618A	278	KLP247224RAF	275	KLPST572424LFF	289	KLPT502424LFF	288
KL281524FF	273	KL283618E	277	KLP281518BBF	273	KLPST572424RBBF	289	KLPT502424RBBF	288
KL281530BBF	273	KL283618FF	277	KLP281518FF	273	KLPST572424RFF	289	KLPT502424RFF	288
KL281530FF	273	KL283618N	278	KLP281524BBF	273	KLPST501224L	287	KLPT502424RFF	288
KL281818A	273	KL283618A	278	KLP281524FF	273	KLPST501224R	287	KLPT571218L	287
KL281818BBF	273	KL283618E	277	KLP281530BBF	273	KLPST501824LBBF	288	KLPT571218R	287
KL281818FF	273	KL283618FF	277	KLP281530FF	273	KLPST501824LFF	288	KLPT571224L	287
KL281824A	273	KL283618N	278	KLH4248A	297	KLPST501824RBBF	288	KLPT571224R	287
KL281824BBF	273	KL283618A	278	KLH4248H	297	KLPST501824RFF	288	KLPT571824LBBF	289
KL281824FF	273	KL283618E	277	KLH4248N	297	KLPST502424LBBF	288	KLPT571824LFF	289
KL281830BBF	273	KL283618FF	277	KLH4260A	297	KLPST502424LFF	288	KLPT571824RBBF	289
KL281830FF	273	KL283618N	278	KLH4260H	297	KLPST502424RBBF	288	KLPT571824RFF	289
KL282418A	278	KL283618A	278	KLH4260N	297	KLPST502424RFF	288	KLPT572424LBBF	289
KL282418BBF	277	KL283618E	277	KLH4266A	297	KLPST571218L	287	KLPT572424LFF	289
KL282424A	278	KL283618FF	277	KLH4266H	297	KLPST571218R	287	KLPT572424RBBF	289
KL282424BBF	277	KL283618N	278	KLH4266N	297	KLPT571224L	287	KLPT572424RFF	289
								KLPT571224R	287
								KLPT571824LBBF	289
								KLPT571824LFF	289
								KLPT571824RBBF	289
								KLPT571824RFF	289
								KLPT572424LBBF	289
								KLPT572424LFF	289
								KLPT572424RBBF	289
								KLPT572424RFF	289
								KLPT651218L	287
								KLPT651218R	287
								KLPT651224L	287
								KLPT651224R	287
								KLPT651824L	290

Cross Reference Index

by Model Number

Model	Page	Model	Page	Model	Page	Model	Page	Model	Page
KLT651218R	287	PM187-183B	111	WKAUMPJ2872LL	247	WKCSFY283018-HD	213	WKCUFN287224-LFOS	214
KLT651224L	287	PM187-183L	111	WKAURS6630	245	WKCSFY283018-LF	213	WKCUFN287224-OSLF	215
KLT651224R	287	PM187-183S	111	WKAURS7230	245	WKCSFY283018-MF	213	WKCUFY246018-BFBF	211
KLT651824L	290	PM187-233A	111	WKAURS7236	245	WKCSFY283018-OS	213	WKCUFY246018-BFHD	212
KLT651824LBBF	290	PM187-233B	111	WKBFKN2H3015	220	WKCSFY283024-BBF	213	WKCUFY246018-BFOS	211
KLT651824LFF	290	PM187-233L	111	WKBFKN3H3015	220	WKCSFY283024-HD	213	WKCUFY246018-HDBF	212
KLT651824R	290	PM187-233S	111	WKBFKN4H3015	220	WKCSFY283024-LF	213	WKCUFY246018-HDHD	212
KLT651824RBBF	290	PM187-303A	111	WKBFKN5H3015	220	WKCSFY283024-MF	213	WKCUFY246018-OSBF	212
KLT651824RFF	290	PM187-303B	111	WKBP0108	218	WKCSFY283024-OS	213	WKCUFY247218-BFBF	211
KLT652424L	290	PM187-303S	111	WKBP2030	218	WKCSFY283618-BBF	213	WKCUFY247218-BFHD	212
KLT652424LBBF	290	PM188-182A	111	WKBP2036	218	WKCSFY283618-HD	213	WKCUFY247218-BFOS	211
KLT652424LFF	290	PM188-182B	111	WKBP2060	218	WKCSFY283618-LF	213	WKCUFY247218-HDBF	212
KLT652424R	290	PM188-182C	111	WKBP2072	218	WKCSFY283618-OS	213	WKCUFY247218-HDHD	212
KLT652424RBBF	290	PM188-182L	111	WKBP2418	218	WKCSFY283624-BBF	213	WKCUFY247218-OSBF	212
KLT652424RFF	290	PM188-182S	111	WKBP2430	218	WKCSFY283624-HD	213	WKCUFY286018-HDHD	215
KLT721824L	291	PM188-232A	111	WKBP2436	218	WKCSFY283624-LF	213	WKCUFY286018-HDLF	215
KLT721824LBBF	291	PM188-232B	111	WKBP2460	218	WKCSFY283624-OS	213	WKCUFY286018-LFHD	215
KLT721824LFF	291	PM188-232L	111	WKBP2472	218	WKCSFY283624-OS	213	WKCUFY286018-LFHD	215
KLT721824R	291	PM188-302A	111	WKBP2818	218	WKCSFY283624-OS	213	WKCUFY286018-LFHD	215
KLT721824RBBF	291	PM188-302B	111	WKBP2830	218	WKCSFY283618-BBF	213	WKCUFY286018-LFOS	214
KLT721824RFF	291	PM188-302L	111	WKBP2836	218	WKCSFY283618-HD	213	WKCUFY286018-LFOS	214
KLT722424L	291	PM188-302S	111	WKBP2860	218	WKCSFY283618-LF	213	WKCUFY286018-LFOS	214
KLT722424LBBF	291	POHRTA365	130	WKBP2872	218	WKCSFY283618-OS	213	WKCUFY286024-LFHD	215
KLT722424LFF	291	POHRTA48S	130	WKBP2872	218	WKCSFY283618-OS	213	WKCUFY286024-LFHD	215
KLT722424R	291	POHRTA1536FD	130	WKBP2872	218	WKCSFY283618-OS	213	WKCUFY286024-LFHD	215
KLT722424RBBF	291	POHRTA1542FD	130	WKBP2872	218	WKCSFY283618-OS	213	WKCUFY286024-LFHD	215
KLT722424RFF	291	POHRTA1548FD	130	WKBP2872	218	WKCSFY283618-OS	213	WKCUFY286024-LFHD	215
KLTT11224L	285	PRFTSKCL	326	WKCDfN243018-BFHD	209	WKCSFY283618-LF	213	WKCUFY286024-LFHD	215
KLTT112424	285	PRFTSKCL	326	WKCDfN243018-BFHD	209	WKCSFY283618-LF	213	WKCUFY286024-LFHD	215
KLTT112424P	285	PRFTSKCL	326	WKCDfN243018-BFHD	209	WKCSFY283618-LF	213	WKCUFY286024-LFHD	215
KLTT113624	285	PRFTSKTR	326	WKCDfN243018-BFHD	209	WKCSFY283618-LF	213	WKCUFY286024-LFHD	215
KLTT114824	285	PT17-20TTP	113	WKCDfN243018-BFHD	209	WKCSFY283618-LF	213	WKCUFY286024-LFHD	215
KOLGBRKLFT	301	PT17-23TTP	113	WKCDfN243018-BFHD	209	WKCSFY283618-LF	213	WKCUFY286024-LFHD	215
KOLGBRKRGT	301	PT17-29TTP	113	WKCDfN243018-BFHD	209	WKCSFY283618-LF	213	WKCUFY286024-LFHD	215
KS2410	294	SH1218	287	WKCDfN243018-BFHD	209	WKCSFY283618-LF	213	WKCUFY286024-LFHD	215
KS3010	294	SH1224	287	WKCDfN243018-BFHD	209	WKCSFY283618-LF	213	WKCUFY286024-LFHD	215
KS3610	294	SH1818	283	WKCDfN243018-BFHD	209	WKCSFY283618-LF	213	WKCUFY286024-LFHD	215
KS4210	294	SH1818A	283	WKCDfN243018-BFHD	209	WKCSFY283618-LF	213	WKCUFY286024-LFHD	215
KS4810	294	SH1824	283	WKCDfN243018-BFHD	209	WKCSFY283618-LF	213	WKCUFY286024-LFHD	215
KSC2424	286	SH1824A	283	WKCDfN243018-BFHD	209	WKCSFY283618-LF	213	WKCUFY286024-LFHD	215
KSC3624	286	SH2418A	283	WKCDfN243018-BFHD	209	WKCSFY283618-LF	213	WKCUFY286024-LFHD	215
KSSC2424	286	SH2424	283	WKCDfN243018-BFHD	209	WKCSFY283618-LF	213	WKCUFY286024-LFHD	215
L919491	114	SH2424A	283	WKCDfN243018-BFHD	209	WKCSFY283618-LF	213	WKCUFY286024-LFHD	215
LKFE	334	SH3015A	283	WKCDfN243018-BFHD	209	WKCSFY283618-LF	213	WKCUFY286024-LFHD	215
LKFE1M1TS	65	SH3018A	283	WKCDfN243018-BFHD	209	WKCSFY283618-LF	213	WKCUFY286024-LFHD	215
LKFE2M1TS	65	SH3024A	283	WKCDfN243018-BFHD	209	WKCSFY283618-LF	213	WKCUFY286024-LFHD	215
LKFE3M1TS	65	SH3615A	283	WKCDfN243018-BFHD	209	WKCSFY283618-LF	213	WKCUFY286024-LFHD	215
LKFE4M1TS	65	SH3618A	283	WKCDfN243018-BFHD	209	WKCSFY283618-LF	213	WKCUFY286024-LFHD	215
LKFE5M1TS	65	SH3624A	283	WKCDfN243018-BFHD	209	WKCSFY283618-LF	213	WKCUFY286024-LFHD	215
OHI524FD	129	SH4818A	283	WKCDfN243018-BFHD	209	WKCSFY283618-LF	213	WKCUFY286024-LFHD	215
OHI524SD	129	SH6018A	283	WKCDfN243018-BFHD	209	WKCSFY283618-LF	213	WKCUFY286024-LFHD	215
OHI530FD	129	T7DV	129, 131	WKCDfN243018-BFHD	209	WKCSFY283618-LF	213	WKCUFY286024-LFHD	215
OHI530RD	129	T612FB	102	WKCDfN243018-BFHD	209	WKCSFY283618-LF	213	WKCUFY286024-LFHD	215
OHI530SD	130	T51872CS	299	WKCDfN243018-BFHD	209	WKCSFY283618-LF	213	WKCUFY286024-LFHD	215
OHI536FD	129	T51884CS	299	WKCDfN243018-BFHD	209	WKCSFY283618-LF	213	WKCUFY286024-LFHD	215
OHI536RD	129	T52472CS	299	WKCDfN243018-BFHD	209	WKCSFY283618-LF	213	WKCUFY286024-LFHD	215
OHI536SD	129	T52484CS	299	WKCDfN243018-BFHD	209	WKCSFY283618-LF	213	WKCUFY286024-LFHD	215
OHI542FD	129	T53072CS	299	WKCDfN243018-BFHD	209	WKCSFY283618-LF	213	WKCUFY286024-LFHD	215
OHI542RD	129	T53084CS	299	WKCDfN243018-BFHD	209	WKCSFY283618-LF	213	WKCUFY286024-LFHD	215
OHI542SD	130	TWTH	129	WKCDfN243018-BFHD	209	WKCSFY283618-LF	213	WKCUFY286024-LFHD	215
OHI548FD	129	U7MC203615HL	310	WKCDfN243018-BFHD	209	WKCSFY283618-LF	213	WKCUFY286024-LFHD	215
OHI548RD	130	U7MC203615HR	310	WKCDfN243018-BFHD	209	WKCSFY283618-LF	213	WKCUFY286024-LFHD	215
OHI548SD	129	U7P1027PB	310	WKCDfN243018-BFHD	209	WKCSFY283618-LF	213	WKCUFY286024-LFHD	215
OHI560FD	129	U7P1027PB	310	WKCDfN243018-BFHD	209	WKCSFY283618-LF	213	WKCUFY286024-LFHD	215
OHI560RD	130	U7P15121ADL	311	WKCDfN243018-BFHD	209	WKCSFY283618-LF	213	WKCUFY286024-LFHD	215
OHI560SD	129	U7T421227ADR	311	WKCDfN243018-BFHD	209	WKCSFY283618-LF	213	WKCUFY286024-LFHD	215
PD80	113	U7T421227ADR	311	WKCDfN243018-BFHD	209	WKCSFY283618-LF	213	WKCUFY286024-LFHD	215
PF197-183A	111	U7T501221ADL	311	WKCDfN243018-BFHD	209	WKCSFY283618-LF	213	WKCUFY286024-LFHD	215
PF197-183B	111	U7T501221ADR	311	WKCDfN243018-BFHD	209	WKCSFY283618-LF	213	WKCUFY286024-LFHD	215
PF197-183L	111	U7T501227ADL	311	WKCDfN243018-BFHD	209	WKCSFY283618-LF	213	WKCUFY286024-LFHD	215
PF197-183S	111	U7T501227ADR	311	WKCDfN243018-BFHD	209	WKCSFY283618-LF	213	WKCUFY286024-LFHD	215
PF197-233A	111	U7WDA	282, 322	WKCDfN243018-BFHD	209	WKCSFY283618-LF	213	WKCUFY286024-LFHD	215
PF197-233B	111	UH6536FD	131	WKCDfN243018-BFHD	209	WKCSFY283618-LF	213	WKCUFY286024-LFHD	215
PF197-233L	111	UH6542FD	131	WKCDfN243018-BFHD	209	WKCSFY283618-LF	213	WKCUFY286024-LFHD	215
PF197-233S	111	UH6548FD	131	WKCDfN243018-BFHD	209	WKCSFY283618-LF	213	WKCUFY286024-LFHD	215
PF197-303A	111	UH6560FD	131	WKCDfN243018-BFHD	209	WKCSFY283618-LF	213	WKCUFY286024-LFHD	215
PF197-303B	111	UH6566FD	131	WKCDfN243018-BFHD	209	WKCSFY283618-LF	213	WKCUFY286024-LFHD	215
PF197-303L	111	UH6572FD	131	WKCDfN243018-BFHD	209	WKCSFY283618-LF	213	WKCUFY286024-LFHD	215
PF197-303S	111	UHTB36	131	WKCDfN243018-BFHD	209	WKCSFY283618-LF	213	WKCUFY286024-LFHD	215
PF198-182A	111	UHTB42	131	WKCDfN243018-BFHD	209	WKCSFY283618-LF	213	WKCUFY286024-LFHD	215
PF198-182B	111	UHTB48	131	WKCDfN243018-BFHD	209	WKCSFY283618-LF	213	WKCUFY286024-LFHD	215
PF198-182L	111	UHTB60	131	WKCDfN243018-BFHD	209	WKCSFY283618-LF	213	WKCUFY286024-LFHD	215
PF198-182S	111	UHTB66	131	WKCDfN243018-BFHD	209	WKCSFY283618-LF	213	WKCUFY286024-LFHD	215
PF198-232A	111	UHTB72	131	WKCDfN243018-BFHD	209	WKCSFY283618-LF	213	WKCUFY286024-LFHD	215
PF198-232B	111	UNQTMP	327	WKCDfN243018-BFHD	209	WKCSFY283618-LF	213	WKCUFY286024-LFHD	215
PF198-232L	111	WANDFS	326	WKCDfN243018-BFHD	209	WKCSFY283618-LF	213	WKCUFY286024-LFHD	215
PF198-232S	111	WANDFSOC	326	WKCDfN243018-BFHD	209	WKCSFY283618-LF	213	WKCUFY286024-LFHD	215
PF198-302A	111	WANDFSUSB	326	WKCDfN243018-BFHD	209	WKCSFY283618-LF	213	WKCUFY286024-LFHD	215
PF198-302B	111	WKAUBG4224	221	WKCDfN243018-BFHD	209	WKCSFY283618-LF	213	WKCUFY286024-LFHD	215
PF198-302L	111	WKAUBG4824	221	WKCDfN243018-BFHD	209	WKCSFY283618-LF	213	WKCUFY286024-LFHD	215
PF198-302S	111	WKAUCB29	225	WKCDfN243018-BFHD	209	WKCSFY283618-LF	213	WKCUFY286024-LFHD	215
PH149-232A	111	WKAUMP2848MM	247	WKCDfN243018-BFHD	209	WKCSFY283618-LF	213	WKCUFY286024-LFHD	215
PH149-232B	111	WKAUMP2854MM	247	WKCDfN243018-BFHD	209	WKCSFY283618-LF	213	WKCUFY286024-LFHD	215
PH149-232L	111	WKAUMP							

Cross Reference Index

by Model Number

Model	Page	Model	Page	Model	Page	Model	Page	Model	Page
WKUCUTY247218-HDHD	212	WKFC1620	216	WKNST572418LBBF	232	WKNT572424RBBF	231	WKPMFN241620-BF	205
WKUCUTY247218-OSBF	212	WKFC3018	216	WKNST572418LFF	232	WKNT572424RFF	231	WKPSFN28924-BBF	205
WKUCUTY284218-LFOS	214	WKFC3024	217	WKNST572418RBBF	232	WKNT651218L	234	WKPSFN28924-FF	205, 221
WKUCUTY284218-OSLF	214	WKFC3618	216	WKNST572418RFF	232	WKNT651218R	234	WKPSFN28930-BBF	205
WKUCUTY284224-LFOS	214	WKFC3624	217	WKNST572424LBBF	232	WKNT651224L	234	WKPSFN28930-FF	205, 221
WKUCUTY284224-OSLF	214	WKFPFN281214LH	221	WKNST572424LFF	232	WKNT651224R	234	WKPSFN281818-BBF	205
WKUCUTY284818-LFOS	214	WKFPFN281214RH	221	WKNST572424RBBF	232	WKNT651818L	235	WKPSFN281818-FF	205
WKUCUTY284818-OSLF	214	WKFPFN281218LH	221	WKNST572424RFF	232	WKNT651818LBBF	229	WKPSFN281818LH-HD	205
WKUCUTY284824-LFOS	214	WKFPFN281218RH	221	WKNST651818LFF	230	WKNT651818LFF	229	WKPSFN281818RH-HD	205
WKUCUTY284824-OSLF	214	WKFPFN281224LH	221	WKNST651818RFF	230	WKNT651818R	235	WKPSFN281824-BBF	205
WKUCUTY286018-HDHD	215	WKFPFN281224RH	221	WKNST651818RBBF	230	WKNT651818RBBF	229	WKPSFN281824-FF	205
WKUCUTY286018-HDLF	215	WKFS30	239	WKNST651818RFF	230	WKNT651818RFF	229	WKPSFN281824LH-HD	205
WKUCUTY286018-LFHD	215	WKFS36	239	WKNST651824LBBF	230	WKNT651824L	235	WKPSFN281824RH-HD	205
WKUCUTY286018-LFLF	214	WKFS42	239	WKNST651824LFF	230	WKNT651824LBBF	229	WKPSFNJ2830LH-HS	205, 246
WKUCUTY286018-LFOS	214	WKFS48	239	WKNST651824RBBF	230	WKNT651824LFF	229	WKPSFNJ2830RH-HS	205, 246
WKUCUTY286018-OSLF	215	WKFS54	239	WKNST652418RFF	230	WKNT651824R	235	WKPT421224LH	228
WKUCUTY286024-HDHD	215	WKFS60	239	WKNST652418LBBF	232	WKNT651824RBBF	229	WKPT421224RH	228
WKUCUTY286024-HDLF	215	WKFS66	239	WKNST652418LFF	232	WKNT651824RFF	229	WKPT421230LH	228
WKUCUTY286024-LFHD	215	WKFS72	239	WKNST652418RBBF	232	WKNT652418L	236	WKPT421230RH	228
WKUCUTY286024-LFLF	214	WKFS78	239	WKNST652418RFF	232	WKNT652418LBBF	231	WKPT501224LH	228
WKUCUTY286024-LFOS	214	WKHATN246018	207	WKNST652418LFF	232	WKNT652418R	231	WKPT501224RH	228
WKUCUTY286024-OSLF	215	WKHATN246024	207	WKNST652424LFF	232	WKNT652418RBBF	231	WKPT501230LH	228
WKUCUTY287218-HDHD	215	WKHATN247218	207	WKNST652424RBBF	232	WKNT652418RFF	231	WKPT501230RH	228
WKUCUTY287218-HDLF	215	WKHATN247224	207	WKNST652424RFF	232	WKNT652424L	236	WKPWDP25M	248
WKUCUTY287218-LFHD	215	WKHP2818	221	WKNST721818LBBF	230	WKNT652424LBBF	231	WKPWDP35M	248
WKUCUTY287218-LFLF	214	WKHP2824	221	WKNST721818LFF	230	WKNT652424LFF	231	WKSEC	244
WKUCUTY287218-LFOS	214	WKHP2830	221	WKNST721818RBBF	230	WKNT652424RBBF	231	WKSHL296030	203
WKUCUTY287218-OSLF	215	WKHP2836	221	WKNST721818RFF	230	WKNT652424RFF	231	WKSHL296630	203
WKUCUTY287224-HDHD	215	WKHP2842	221	WKNST721824LBBF	230	WKNT721218L	234	WKSHL297230	203
WKUCUTY287224-HDLF	215	WKHP2848	221	WKNST721824LFF	230	WKNT721218R	234	WKSPPLYMT	225
WKUCUTY287224-LFHD	215	WKHFFN2H3018	219	WKNST721824RBBF	230	WKNT721224L	234	WKSPPLYWD	225
WKUCUTY287224-LFLF	214	WKHFFN2H3024	219	WKNST721824RFF	230	WKNT721224R	234	WKST312	226
WKUCUTY287224-LFOS	214	WKLFFN2H3618	219	WKNST722418LBBF	232	WKNT721818L	235	WKST318	226
WKUCUTY287224-OSLF	215	WKLFFN2H3624	219	WKNST722418LFF	232	WKNT721818LBBF	229	WKST412	226
WKDAFNJ294824	202	WKLFFN3H3018	219	WKNST722418RBBF	232	WKNT721818LFF	229	WKST418	226
WKDAFNJ295424	202	WKLFFN3H3024	219	WKNST722418RFF	232	WKNT721818R	235	WKSWMC	245
WKDAFNJ296024	202	WKLFFN3H3618	219	WKNST722424LBBF	232	WKNT721818RBBF	229	WKTBTL2824	225
WKDAFNJ296624	202	WKLFFN3H3624	219	WKNST722424LFF	232	WKNT721818RFF	229	WKTBTL2830	225
WKDAFNJ296630	202	WKLFFN4H3018	219	WKNST722424RBBF	232	WKNT721824L	235	WKTDL0296630	203
WKDAFNJ296630LH-FF	202	WKLFFN4H3024	219	WKNST722424RFF	232	WKNT721824LBBF	229	WKTDL0297230	203
WKDAFNJ296630RH-FF	202	WKLFFN4H3618	219	WKNT421218L	234	WKNT721824LFF	229	WKTFT4H30-FA	242
WKDAFNJ297224	202	WKLFFN4H3624	219	WKNT421218R	234	WKNT721824R	235	WKTFT4H30-LA	242
WKDAFNJ297230	202	WKMP1430	227	WKNT421224L	234	WKNT721824RBBF	229	WKTFT4H36-FA	242
WKDAFNJ297230LH-FF	202	WKMP1436	227	WKNT421224R	234	WKNT721824RFF	229	WKTFT4H36-LA	242
WKDAFNJ297230RH-FF	202	WKMP1436LH	227	WKNT421818L	235	WKNT722418L	236	WKTFT4H42-FA	242
WKDAFNJ297236	202	WKMP1436RH	227	WKNT421818R	235	WKNT722418LBBF	231	WKTFT4H42-LA	242
WKDAFNJ297236LH-FF	202	WKMP1442	227	WKNT421824L	236	WKNT722418LFF	237	WKTFT4H44-HA	241
WKDAFNJ297236RH-FF	202	WKMP1442LH	227	WKNT422418L	236	WKNT722418RBBF	231	WKTFT4H44-LA	241
WKDRFN294830LH-BBF	204	WKMP1442RH	227	WKNT422418R	236	WKNT722418RFF	231	WKTFT4H48-FA	242
WKDRFN294830RH-BBF	204	WKMP1448	227	WKNT422424L	236	WKNT722424L	236	WKTFT4H48-LA	242
WKDRFN295430LH-BBF	204	WKMP1448LH	227	WKNT501218L	234	WKNT722424LBBF	231	WKTFT4H54-FA	242
WKDRFN295430RH-BBF	204	WKMP1448RH	227	WKNT501218R	234	WKNT722424LFF	231	WKTFT4H54-LA	242
WKDRFN296030LH-BBF	204	WKMP1454	227	WKNT501224L	234	WKNT722424RBBF	231	WKTFT4H60-FA	242
WKDRFN296030RH-BBF	204	WKMP1454LH	227	WKNT501224R	234	WKNT722424RFF	231	WKTFT4H60-LA	242
WKDRFN296630LH-BBF	204	WKMP1454RH	227	WKNT501818L	235	WKNT723018L	237	WKTFT4H62-FA	241
WKDRFN296630RH-BBF	204	WKMP1454RH	227	WKNT501818LBBF	229	WKNT723018LFF	237	WKTFT4H62-LA	241
WKDRFN297230LH-BBF	204	WKMP1460LH	227	WKNT501818R	235	WKNT723018RFF	237	WKTFT4H66-FA	242
WKDRFN297230RH-BBF	204	WKMP1460RH	227	WKNT501818RBBF	229	WKNT723024L	237	WKTFT4H66-LA	242
WKDRPB294830LH	203	WKMP1466	227	WKNT501818RFF	229	WKNT723024LFF	237	WKTFT4H72-FA	242
WKDRPB294830RH	203	WKMP1466LH	227	WKNT501818RBBF	229	WKNT723024RFF	237	WKTFT4H72-LA	242
WKDRPB295430LH	203	WKMP1466RH	227	WKNT501824L	235	WKOH3548-HDG	241	WKTFT4H78-FA	242
WKDRPB295430RH	203	WKMP1472	227	WKNT501824LBBF	229	WKOH3548-HDL	241	WKTFT4H78-LA	242
WKDRPB296030LH	203	WKMP1472LH	227	WKNT501824LFF	229	WKOH3560-HDG	241	WKTFT4H84-FA	242
WKDRPB296030RH	203	WKMP1472RH	227	WKNT501824R	235	WKOH3560-HDL	241	WKTFT4H84-LA	242
WKDRPB296630LH	203	WKMP2848	227	WKNT501824RBBF	229	WKOH3566-HDG	241	WKTFT4H90-FA	242
WKDRPB296630RH	203	WKMP2854	227	WKNT501824RFF	229	WKOH3566-HDL	241	WKTFT4H90-LA	242
WKDRPB297230LH	203	WKMP2860	227	WKNT502418L	236	WKOH3572-HDG	241	WKTFT4H96-FA	242
WKDRPB297230RH	203	WKMP2866	227	WKNT502418LBBF	231	WKOH3572-HDL	241	WKTFT4H96-LA	242
WKDRPB297830LH	203	WKMP2872	227	WKNT502418LFF	231	WKOH153015-HDG	238	WKTFT5H30-FA	243
WKDRPB297830RH	203	WKMTMP	244	WKNT502418R	231	WKOH153015-HDL	238	WKTFT5H30-LA	243
WKDRTL294830	203	WKMTMP	244	WKNT502418RBBF	231	WKOH153015-NDL	238	WKTFT5H36-FA	243
WKDRTL295430	203	WKMTMU	244	WKNT502424L	236	WKOH153615-HDG	238	WKTFT5H36-LA	243
WKDRTL296030	203	WKNST281524-BBF	206	WKNT502424LBBF	231	WKOH153615-HDL	238	WKTFT5H42-FA	243
WKDRTL297230	203	WKNST281524-FF	206	WKNT502424LFF	231	WKOH153615-NDL	238	WKTFT5H42-LA	243
WKDRTL297830	203	WKNST281530-BBF	206	WKNT502424RBBF	231	WKOH154215-HDG	238	WKTFT5H48-FA	243
WKDRTL298430	203	WKNST281530-FF	206	WKNT502424RFF	231	WKOH154215-HDL	238	WKTFT5H48-LA	243
WKDTCB294830	203	WKNST501818LBBF	230	WKNT571218L	234	WKOH154815-HDG	238	WKTFT5H54-FA	243
WKDTCB295430	203	WKNST501818LFF	230	WKNT571218R	234	WKOH154815-HDL	238	WKTFT5H54-LA	243
WKDTCB296030	203	WKNST501818RBBF	230	WKNT571224L	234	WKOH154815-SDL	238	WKTFT5H60-FA	243
WKDTCB296630	203	WKNST501818RFF	230	WKNT571224R	234	WKOH156015-HDG	238	WKTFT5H60-LA	243
WKDTCB297230	203	WKNST501824LBBF	230	WKNT571818L	235	WKOH156015-HDL	238	WKTFT5H66-FA	243
WKDUFN296030LH-BBF	204	WKNST501824LFF	230	WKNT571818LBBF	229	WKOH156015-SDL	238	WKTFT5H66-LA	243
WKDUFN296030RH-BBF	204	WKNST501824RBBF	230	WKNT571818LFF	229	WKOH156615-HDG	238	WKTFT5H72-FA	243
WKDUFN296630LH-BBF	204	WKNST501824RFF	230	WKNT571818R	235	WKOH156615-HDL	238	WKTFT5H72-LA	243
WKDUFN296630RH-BBF	204	WKNST502418LBBF	232	WKNT571818RBBF	229	WKOH156615-SDL	238	WKTFT5H78-FA	243
WKDUFN297230LH-BBF	204	WKNST502418LFF	232	WKNT571818RFF	229	WKOH157215-HDG	238	WKTFT5H78-LA	243
WKDUFN297230RH-BBF	204	WKNST502418RBBF	232	WKNT50H157215-HDL	238	WKOH157215-HDL	238	WKTFT5H84-FA	243
WKDUFN297236-BBFF	204	WKNST502418RFF	232	WKNT571824LBBF	229	WKOH157215-SDL	238	WKTFT5H84-LA	243
WKDUFN297236LH-BBF	204	WKNST502424LBBF	232	WKNT571824LFF	229	WKOH157815-HDG	238	WKTFT5H90-FA	243
WKDUFN297236RH-BBF	204	WKNST502424LFF	232	WKNT571824R	235	WKOH157815-HDL	238	WKTFT5H90-LA	243
WKFC	244	WKNST502424RBBF	232	WKNT571824RBBF	229	WKOH157815-SDL	238	WKTFT5H96-FA	243
WKEP2814LH	227	WKNST502424RFF	232	WKNT571824RFF	229	WKOHBW30AK	238	WKTFT5H96-LA	243
WKEP2814RH	227	WKNST571818LBBF	230	WKNT572418L	236	WKOHBW60AK	238	WKTGT4H30-FA	242
WKEP2824LH	227	WKNST571818LFF	230	WKNST572418LBBF	231	WKPLFN241218LH-HD	206	WKTGT4H30-LA	242
WKEP2824RH	227	WKNST571818RBBF	230	WKNST572418LFF	231	WKPLFN241218-OC	206	WKTGT4H36-FA	242
WKEP2830LH	227	WKNST571818RFF	230	WKNST572418RBBF	231	WKPLFN241218RH-HD	206	WKTGT4H36-LA	242
WKEP2830RH	227	WKNST571824LBBF	230	WKNST572418RFF	231	WKPLTN241218-OC	206	WKTGT4H42-FA	242
WKEP2836LH	227	WKNST571824LFF	230	WKNST572424L	236	WKPLTN241218LH-HD	206	WKTGT4H42-LA	242
WKEP2836RH	227	WKNST571824RBBF	230	WKNST572424LBBF	231	WKPLTN241218-OC	206	WKTGT4H48-FA	242
WKEPFNJ2830-HS	246	WKNST571824RFF	230	WKNT572424LFF	231	WKPLTN241218RH-HD	206	WKTGT4H48-LA	242

INDEX

Cross Reference Index

by Model Number

Model	Page	Model	Page	Model	Page	Model	Page	Model	Page
WTKTGT4H54-FA.....	242	WKWSCWFD3624.....	217	WKYST651824RFF.....	230	WKYT651824R.....	235	YPCF224218O.....	54
WTKTGT4H54-LA.....	242	WKWSCWFD4218.....	217	WKYST652418LBBF.....	232	WKYT651824RBBF.....	229	YPCF224218OFL.....	58
WTKTGT4H60-FA.....	242	WKWSCWFD4224.....	217	WKYST652418RFF.....	232	WKYT651824RFF.....	229	YPCF224218OFM.....	56
WTKTGT4H60-LA.....	242	WKWSCWFD4818.....	217	WKYST652418RBBF.....	232	WKYT652418.....	236	YPCF224218RBFOL.....	55
WTKTGT4H66-FA.....	242	WKWSCWFD4824.....	217	WKYST652418RFF.....	232	WKYT652418LBBF.....	231	YPCF224218RBFOM.....	54
WTKTGT4H66-LA.....	242	WKWSCWFD5418.....	217	WKYST652424LBBF.....	232	WKYT652418LFF.....	231	YPCF224218ROHAT.....	62
WTKTGT4H72-FA.....	242	WKWSCWFD5424.....	217	WKYST652424RFF.....	232	WKYT652418RBBF.....	231	YPCF224224BFL.....	55
WTKTGT4H72-LA.....	242	WKWSCWFD6018.....	217	WKYST652424RBBF.....	232	WKYT652418RFF.....	231	YPCF224224BFL.....	54
WTKTGT4H84-FA.....	242	WKWSCWFD6024.....	217	WKYST721818LBBF.....	230	WKYT652424.....	236	YPCF224224LBFOL.....	55
WTKTGT4H84-LA.....	242	WKWSCWFD6618.....	217	WKYST721818RFF.....	230	WKYT652424LBBF.....	231	YPCF224224LBFOM.....	54
WTKTGT4H84-FA.....	242	WKWSCWFD6624.....	217	WKYST721818LFF.....	230	WKYT652424LFF.....	231	YPCF224224O.....	54
WTKTGT4H84-LA.....	242	WKWSCWFD7218.....	217	WKYST721818RBBF.....	230	WKYT652424RBBF.....	231	YPCF224224RBFOL.....	55
WTKTGT4H90-FA.....	242	WKWSCWFD7224.....	217	WKYST721818RFF.....	230	WKYT652424RFF.....	231	YPCF224224RBFOM.....	54
WTKTGT4H90-LA.....	242	WKWSCWFD7818.....	217	WKYST721824LBBF.....	230	WKYT721218L.....	234	YPCF224818LBFOL.....	55
WTKTGT4H96-FA.....	242	WKWSCWFD7824.....	217	WKYST721824LFF.....	230	WKYT721218R.....	234	YPCF224818LBFOLHAT.....	58
WTKTGT4H96-LA.....	242	WKWSCWFD8418.....	217	WKYST721824RBBF.....	230	WKYT721224L.....	234	YPCF224818LBFOM.....	54
WTKTGT5H30-FA.....	243	WKWSCWFD8424.....	217	WKYST721824RFF.....	230	WKYT721224R.....	234	YPCF224818LBFOMHAT.....	56
WTKTGT5H30-LA.....	243	WKWSCWFD9018.....	217	WKYST722418LBBF.....	232	WKYT721818L.....	235	YPCF224818RBFOL.....	55
WTKTGT5H36-FA.....	243	WKWSCWFD9024.....	217	WKYST722418LFF.....	232	WKYT721818LBBF.....	229	YPCF224818RBFOLHAT.....	58
WTKTGT5H36-LA.....	243	WKWSCWFD9618.....	217	WKYST722418RBBF.....	232	WKYT721818LFF.....	229	YPCF224818RBFOM.....	54
WTKTGT5H42-FA.....	243	WKWSCWFD9624.....	217	WKYST722418RFF.....	232	WKYT721818R.....	235	YPCF224818RBFOMHAT.....	56
WTKTGT5H42-LA.....	243	WKWSDS6024.....	223	WKYST722424LBBF.....	232	WKYT721818RBBF.....	229	YPCF224824LBFOL.....	55
WTKTGT5H48-FA.....	243	WKWSDS6030.....	223	WKYST722424LFF.....	232	WKYT721818RFF.....	229	YPCF224824LBFOM.....	54
WTKTGT5H48-LA.....	243	WKWSDS6624.....	223	WKYST722424RBBF.....	232	WKYT721824L.....	235	YPCF224824RBFOL.....	55
WTKTGT5H54-FA.....	243	WKWSDS6630.....	223	WKYST722424RFF.....	232	WKYT721824LBBF.....	229	YPCF224824RBFOM.....	54
WTKTGT5H54-LA.....	243	WKWSDS7224.....	223	WKYST722424RFF.....	232	WKYT721824LFF.....	229	YPCF226018LBFOL.....	55
WTKTGT5H60-FA.....	243	WKWSDS7230.....	223	WKYT421218L.....	234	WKYT721824R.....	235	YPCF226018LBFOLHAT.....	58
WTKTGT5H60-LA.....	243	WKWSDS7230.....	223	WKYT421224L.....	234	WKYT721824RBBF.....	229	YPCF226018LBFOM.....	54
WTKTGT5H66-FA.....	243	WKWSPT1818.....	216	WKYT421224R.....	234	WKYT721824RFF.....	229	YPCF226018LBFOMHAT.....	56
WTKTGT5H66-LA.....	243	WKWSPT1824.....	216	WKYT421818L.....	235	WKYT722418.....	236	YPCF226018RBFOL.....	55
WTKTGT5H72-FA.....	243	WKWSRS3024.....	224	WKYT421818R.....	235	WKYT722418LBBF.....	231	YPCF226018RBFOLHAT.....	58
WTKTGT5H72-LA.....	243	WKWSRS3030.....	224	WKYT421824L.....	235	WKYT722418LFF.....	231	YPCF226018RBFOM.....	54
WTKTGT5H78-FA.....	243	WKWSRS3624.....	224	WKYT421824R.....	235	WKYT722418RBBF.....	231	YPCF226018RBFOMHAT.....	56
WTKTGT5H78-LA.....	243	WKWSRS3630.....	224	WKYT422418.....	236	WKYT722418RFF.....	231	YPCF226024LBFOL.....	55
WTKTGT5H84-FA.....	243	WKWSRS4224.....	224	WKYT422424.....	236	WKYT722424.....	236	YPCF226024LBFOM.....	54
WTKTGT5H84-LA.....	243	WKWSRS4230.....	224	WKYT501218L.....	234	WKYT722424LBBF.....	231	YPCF226024RBFOL.....	55
WTKTGT5H90-FA.....	243	WKWSRS4824.....	224	WKYT501218R.....	234	WKYT722424LFF.....	231	YPCF226024RBFOM.....	54
WTKTGT5H90-LA.....	243	WKWSRS4830.....	224	WKYT501224L.....	234	WKYT722424RBBF.....	231	YPCF227218LBFOL.....	55
WTKTGT5H96-FA.....	243	WKWSRS5424.....	224	WKYT501224R.....	234	WKYT722424RFF.....	231	YPCF227218LBFOLHAT.....	58
WTKTGT5H96-LA.....	243	WKWSRS5430.....	224	WKYT501818L.....	235	WKYT723018.....	237	YPCF227218LBFOM.....	54
WTKTRD36.....	222	WKWSRS6024.....	224	WKYT501818LFF.....	229	WKYT723018LFF.....	237	YPCF227218LBFOMHAT.....	55
WTKTRD42.....	222	WKWSRS6030.....	224	WKYT501818R.....	235	WKYT723024.....	237	YPCF227218RBFOL.....	58
WTKTRD48.....	222	WKWSRS6624.....	224	WKYT501818RFF.....	229	WKYT723024LFF.....	237	YPCF227218RBFOM.....	54
WKTWFN4H1815LH-HDL.....	239	WKWSRS6630.....	224	WKYT501818RBBF.....	229	WKYT723024RFF.....	237	YPCF227218RBFOMHAT.....	56
WKTWFN4H1815RH-HDL.....	239	WKWSRS7224.....	224	WKYT501818RFF.....	229	YPCABD02.....	65	YPCF227224LBFOL.....	55
WKTWFN4H3015-HDL.....	239	WKWSRS7230.....	224	WKYT501824L.....	235	YPCABD10.....	65	YPCF227224LBFOM.....	54
WKTWFN4H3015-SH.....	240	WKWSRS7236.....	224	WKYT501824LBBF.....	229	YPCACW25.....	65	YPCF227224RBFOL.....	55
WKTWFN4H3615-HDL.....	239	WKWSRS7824.....	224	WKYT501824LFF.....	229	YPCACW35.....	65	YPCF227224RBFOM.....	54
WKTWFN4H3615-SH.....	240	WKWSRS7830.....	224	WKYT501824R.....	235	YPCACW50.....	65	YPCF282418O.....	67
WKTWFN5H1815LH-HDL.....	239	WKWSRS8424.....	224	WKYT501824RBBF.....	229	YPCACW65.....	65	YPCF283018O.....	67
WKTWFN5H1815RH-HDL.....	239	WKWSRS8430.....	224	WKYT501824RFF.....	229	YPCAFD02.....	65, 114	YPCF283618O.....	67
WKTWFN5H1815-SH.....	240	WKWSRS8436.....	224	WKYT502418.....	236	YPCAFD10.....	65, 114	YPCLF501218L.....	88
WKTWFN5H3015-HDL.....	239	WKWSRS9024.....	224	WKYT502418LBBF.....	231	YPCAH12.....	65	YPCLF501218LM.....	87
WKTWFN5H3015-SH.....	240	WKWSRS9030.....	224	WKYT502418LFF.....	231	YPCAH15.....	65	YPCLF501218RL.....	88
WKTWFN5H3615-HDL.....	239	WKWSRS9624.....	224	WKYT502418RBBF.....	231	YPCF222418BFL.....	55	YPCLF501218RM.....	87
WKTWFN5H3615-SH.....	240	WKWSRS9630.....	224	WKYT502418RFF.....	231	YPCF222418BFL.....	55	YPCLF502418L.....	90
WKUP296030LH-BBF.....	204	WKWT30.....	244	WKYT502424.....	236	YPCF222418BFL.....	55	YPCLF502418LM.....	89
WKUP296030LH-FF.....	204	WKYSP281524-BBF.....	206	WKYT502424LBBF.....	231	YPCF222418BFL.....	55	YPCLF502418RM.....	89
WKUP296030RH-BBF.....	204	WKYSP281524-FF.....	206	WKYT502424LFF.....	231	YPCF222418BOM.....	56	YPCLF502418RM.....	90
WKUP296030RH-FF.....	204	WKYSP281530-BBF.....	206	WKYT502424RBBF.....	231	YPCF222418OFL.....	58	YPCLF651218L.....	88
WKUP296030RH-BBF.....	204	WKYSP281530-FF.....	206	WKYT502424RFF.....	231	YPCF222418OFL.....	58	YPCLF651218LM.....	87
WKUP296030LH-FF.....	204	WKYST501818LBBF.....	230	WKYT571218L.....	234	YPCF222418OFL.....	56	YPCLF651218RM.....	87
WKUP296030RH-BBF.....	204	WKYST501818LFF.....	230	WKYT571218R.....	234	YPCF222424BFL.....	55	YPCLF651218RM.....	87
WKUP296030RH-FF.....	204	WKYST501818RBBF.....	230	WKYT571224L.....	234	YPCF222424BFL.....	55	YPCLF652418L.....	90
WKUP297230LH-BBF.....	204	WKYST501818RFF.....	230	WKYT571224R.....	234	YPCF222424BFL.....	55	YPCLF652418LM.....	89
WKUP297230LH-FF.....	204	WKYST501824LBBF.....	230	WKYT571818L.....	235	YPCF223018BFL.....	55	YPCLF652418RM.....	89
WKUP297230RH-BBF.....	204	WKYST501824LFF.....	230	WKYT571818LBBF.....	229	YPCF223018BFL.....	55	YPCLF652418RM.....	89
WKUP297230RH-FF.....	204	WKYST501824RBBF.....	230	WKYT571818LFF.....	229	YPCF223018BOM.....	56	YPCLP501218L.....	88
WKWC1814-SH.....	233	WKYST501824RFF.....	230	WKYT571818R.....	235	YPCF223018OFL.....	58	YPCLP501218LM.....	87
WKWC2414-SH.....	233	WKYST502418LBBF.....	232	WKYT571818RBBF.....	229	YPCF223018OFL.....	58	YPCLP502418L.....	90
WKWC3014-SH.....	233	WKYST502418LFF.....	232	WKYT571818RFF.....	229	YPCF223018OFL.....	58	YPCLP502418LM.....	90
WKWSCW3018.....	216	WKYST502418RBBF.....	232	WKYT571824L.....	235	YPCF223018OFL.....	58	YPCLP651218L.....	88
WKWSCW3024.....	216	WKYST502418RFF.....	232	WKYT571824LBBF.....	229	YPCF223018OFL.....	58	YPCLP651218LM.....	87
WKWSCW3618.....	216	WKYST502424LBBF.....	232	WKYT571824LFF.....	229	YPCF223018OFL.....	58	YPCLP652418L.....	90
WKWSCW3624.....	216	WKYST502424LFF.....	232	WKYT571824R.....	235	YPCF223018OFL.....	58	YPCLP652418LM.....	90
WKWSCW4218.....	216	WKYST502424RBBF.....	232	WKYT571824RBBF.....	229	YPCF223018OFL.....	58	YPCLP652418RM.....	89
WKWSCW4224.....	216	WKYST502424RFF.....	232	WKYT571824RFF.....	229	YPCF223018OFL.....	58	YPCLP652418RM.....	89
WKWSCW4818.....	216	WKYST502424RFF.....	232	WKYT572418.....	236	YPCF223618BFL.....	55	YPCLP652418RM.....	90
WKWSCW4824.....	216	WKYST571818LBBF.....	230	WKYT572418LBBF.....	231	YPCF223618BFL.....	55	YPCLP652418RM.....	89
WKWSCW5418.....	216	WKYST571818LFF.....	230	WKYT572418LFF.....	231	YPCF223618BFL.....	55	YPCLP652418RM.....	89
WKWSCW5424.....	216	WKYST571818RBBF.....	230	WKYT572418R.....	235	YPCF223618BFL.....	55	YPCLP652418RM.....	89
WKWSCW6018.....	216	WKYST571818RFF.....	230	WKYT572418RBBF.....	229	YPCF223618BFL.....	55	YPCLP652418RM.....	89
WKWSCW6024.....	216	WKYST571824LBBF.....	230	WKYT572418RFF.....	229	YPCF223618BFL.....	55	YPCLP652418RM.....	89
WKWSCW6618.....	216	WKYST571824LFF.....	230	WKYT572424.....	236	YPCF223618BFL.....	55	YPCLP652418RM.....	89
WKWSCW6624.....	216	WKYST571824RBBF.....	230	WKYT572424LBBF.....	231	YPCF223618BFL.....	55	YPCLP652418RM.....	89
WKWSCW7218.....	216	WKYST571824RFF.....	230	WKYT572424LFF.....	231	YPCF223618BFL.....	55	YPCLP652418RM.....	89
WKWSCW7224.....	216	WKYST572418LBBF.....	232	WKYT572424RBBF.....	231	YPCF223618BFL.....	55	YPCLP652418RM.....	89
WKWSCW7818.....	216	WKYST572418LFF.....	232	WKYT572424RFF.....	231	YPCF223618BFL.....	55	YPCLP652418RM.....	89
WKWSCW7824.....	216	WKYST572418RBBF.....	232	WKYT572424RFF.....	231	YPCF223618BFL.....	55	YPCLP652418RM.....	89
WKWSCW8418.....	216	WKYST572418RFF.....	232	WKYT651218L.....	234	YPCF223618BFL.....	55	YPCLP652418RM.....	89
WKWSCW8424.....	216	WKYST572424LBBF.....	232	WKYT651218LFF.....	234	YPCF223618BFL.....	55	YPCLP652418RM.....	89
WKWSCW9018.....	216	WKYST572424LFF.....	232	WKYT651224R.....	234	YPCF223618BFL.....	55	YPCLP652418RM.....	89
WKWSCW9024.....	216	WKYST572424RBBF.....	232	WKYT651818L.....	235	YPCF223618BFL.....	55	YPCLP652418RM.....	89
WKWSCW9618.....	216	WKYST572424RFF.....	232	WKYT651818LBBF.....	229	YPCF223618BFL.....	55	YPCLP652418RM.....	89
WKWSCW9624.....	216	WKYST651818LBBF.....	230	WKYT651818LFF.....	229	YPCF223618BFL.....	55	YPCLP652418RM.....	89
WKWSCWFD1818.....	217	WKYST651818RBBF.....	230	WKYT651818R.....	235	YPCF223618BFL.....	55	YPCLP652418RM.....	89
WKWSCWFD1824.....	217	WKYST651818RFF.....	230	WKYT651818RBBF.....	229	YPCF223618BFL.....	55	YPCLP652418RM.....	89
WKWSCWFD3018.....	217	WKYST651824LBBF.....	230	WKYT651824L.....	236	YPCF223618BFL.....	55	YPCLP652418RM.....	89
WKWSCWFD3024.....	217	WKYST651824LFF.....	230	WKYT651824LBBF.....	229	YPCF223618BFL.....	55	YPCLP652418RM.....	89
WKWSCWFD3618.....	217	WKYST65							

Model	Page
YPWP651224LM.....	80
YPWP651224RL.....	82
YPWP651224RM.....	80
YPWTAWSBKT18.....	81
YPWTAWSBKT24.....	81
YWC24Z.....	295
YWC30Z.....	295
YWC36Z.....	295
YWC42Z.....	295
YWC48Z.....	295
YWC60Z.....	295
Z2NM.....	129
Z2UP24.....	129
Z2UP30.....	129
Z2UP36.....	129
Z2UP42.....	129
Z2UP48.....	129
Z2UP60.....	129
Z4UP24.....	129
Z4UP30.....	129
Z4UP36.....	129
Z4UP42.....	129
Z4UP48.....	129
Z4UP60.....	129
Z5SC42.....	102, 226, 301
Z5SC48.....	102, 226, 301
Z5SC54.....	102, 226, 301
Z5SC60.....	102, 226, 301
Z5SC66.....	102, 226, 301
Z5SC72.....	102, 226, 301
Z5SC78.....	102, 226, 301
Z5SC84.....	102, 226
Z6LB.....	291, 301, 311
Z6PL40HP.....	101
Z617UWTRGH.....	245
Z636UWTRGH.....	245
Z61710UWTRGH.....	245
Z63610UWTRGH.....	245
ZHFPMK.....	294
ZS24.....	129
ZS30.....	129
ZS36.....	129
ZS42.....	129
ZS48.....	129
ZS60.....	129

INDEX



Allsteel®

Allsteel Inc.
Muscatine, Iowa 52761

allsteeloffice.com

Form #A8745.A3 (03/24)