

GSA
CADRE
SWIVEL
SEATING



GSA Contract Number
47Q SMA22D08P9

2 0 2 4



Mailing Address: HBF PO Box 8 Hickory NC 28603-0008	Shipping Address: HBF 900 - 12th Street Drive NW Hickory NC 28601-4763	Contact: Phone: 1.855.HBF.2020 828.328.2064 Fax: 828.485.2690 Info: hbfservice@hbf.com www.hbf.com	Order Processing: Phone: 1.855.HBF.2020 828.328.2064 Fax: 828.485.2690 hbforders@hbf.com
--	---	--	---

GENERAL INFORMATION	PAGE
ANSI/BIFMA e3-2014e Furniture Sustainability.....	5
Casters	9
COM Ordering Requirements.....	3
Combinations of Upholstery Applications	4
Dimension Guide	5
GSA	6
HBF Textiles Graded Product	8
High Performance Products	6
Indoor Advantage™ Gold Certified	5
Product Material Options	7
Seating Ordering Procedure	2
Special Code Compliance – CAL 117.....	4
Spring Down Cushions.....	6
Statement of Line.....	11
Veneer Options.....	6
Yardage Requirements.....	2
 SWIVEL SEATING	
Cadre	10



Coverings

All upholstered items may be ordered using HBF Textiles, HBF Leathers, or coverings provided by the customer. Prices listed as COM refer to Customer's Own Material, which includes textiles and leather. Prices listed as GRADE refer to HBF Textiles and/or HBF Leather.

Yardage requirements shown in the price list are based on non-directional 54" wide material. The following conversion chart should be used to determine yardage requirements when COM textile is 54" wide or less and/or has a repeat of 2" or more. Add together the vertical and horizontal repeat to determine which column should be used as a reference.

Table with 9 columns: Fabric Width, Plain Fabric, 2"-10" Repeat, 11"-20" Repeat, 21"-25" Repeat, 26"-30" Repeat, 31"-35" Repeat, 36"-40" Repeat, 41"-45" Repeat. Rows show percentage increments for various fabric widths.

To determine the possibility of reduced yardage requirements for orders of thirty (30) or more units, please contact The HBF Client Experience Team. HBF reserves the right to request additional yardage of COM at customer expense based on repeat and/or pattern size, and number of rolls.

All COM's must be approved for application before the purchase order is submitted to HBF. Please contact The HBF Client Experience Team at hbfservice@hbf.com to verify that your COM fabric has been approved. If it has not, please request COM approval testing via www.hbf.com under COM Request. Failure to submit a COM for testing may result in additional expenses or rejection of COM. For any repeat and/or pattern size not listed, please contact The HBF Client Experience Team for a yardage requirement quotation.

HBF cannot be held responsible for performance, color accuracy, or weaving of COM materials. All responsibility for COM shipments is between the purchaser and the textile/leather source. HBF reserves the right to reject any COM. HBF assumes no responsibility for suitability or wearability of COM. Difficult COM may be subject to additional charge if additional labor costs are incurred. HBF assumes no responsibility for the flame retardance of any COM. Customers are solely responsible for making sure that COM complies with all applicable codes and regulations. Orders specifying COM will not be scheduled for production until all approved COM(s) are received by HBF. To ensure proper COM expediting, please tag fabric/leather roll(s) with the following information: 1. Purchasing dealer name and purchase order number 2. HBF acknowledgment number, if available 3. Other pertinent information which will enable proper COM identification.

When sending COM leather for use on one of our upholstered pieces, please send eighteen (18) square feet of leather for each yard of 54" plain fabric required for that item.



Coverings (Continued)

COM ORDERING REQUIREMENTS:

Prior to acceptance of order specifying COM, a memo sample must be submitted to HBF for determination of suitability. All COM's must be rolled separately, on individual tubes. Multiple materials rolled on the same tube will not be accepted.

For ease of expediting your COM order, we require the following information:

- | | |
|---|------------------------------|
| 1. Material description | Shipping Address: HBF |
| 2. Material source | 900 12th Street Drive NW |
| 3. Order line, product name or number | Hickory, NC 28601-4763 |
| 4. Material color | |
| 5. A swatch of the covering | |
| 6. Special application instructions, if any | |

If COM is of a type requiring choices of seam placement, face side, position of design or repeat; these instructions must be clearly stated on the original order.

HBF cannot be held responsible for performance, color accuracy, or weaving of COM materials. All responsibility for COM shipments is between the purchaser and the textile/leather source.

HBF reserves the right to reject any COM. HBF assumes no responsibility for suitability or wearability of COM. Difficult COM may be subject to additional charge if additional labor costs are incurred.

HBF assumes no responsibility for the flame retardance of any COM. Customers are solely responsible for making sure that COM complies with all applicable codes and regulations.

Orders specifying COM will not be scheduled for production until all approved COM is received by HBF.

To ensure proper COM expediting, please tag textile/leather with the following information:

1. Purchasing dealer name and purchase order number
2. HBF acknowledgement number, if available
3. Other pertinent information which will enable proper COM identification



Combination of Upholstery Applications

All seating ordered with combination upholstery application (fabric, leather) that **is not** offered as standard is subject to a **\$103 List Upholstery upcharge** and will be entered and processed as a special model, in addition to the following pricing conditions:

1. Combinations using HBF Textiles and COM will be priced at the COM price. The cost of the portion of the HBF Textiles used, will be entered as a miscellaneous charge on the furniture order.
2. Combinations using HBF Textiles and HBF Leathers, or COM and HBF Leathers, will be priced at the appropriate Leather I-V price.
3. Combinations using two HBF Textiles will be invoiced at higher grade price.
4. When specifying combination of upholstery applications, a sketch indicating placement of textiles and direction of applications must accompany the purchase order.

Special Code Compliance

California #117-2013

Unless otherwise specified, foam used in all HBF seating products complies with these guidelines.

Boston Fire Code

New York Port Authority

Please contact the HBF Client Experience Team if compliance is required for these special codes.

**ANSI/BIFMA e3-2014e
LEVEL® Furniture
Sustainability Standard
Certification**

A majority of HBF’s products have met the necessary qualifications to achieve LEVEL® certification. LEVEL® is the multi-attribute sustainability certification based on the ANSI/BIFMA e3 Furniture Sustainability Standard. The standard and certification were created to deliver the most open and transparent means of evaluating and communicating the environmental and social impacts of furniture products in the built environment. Taking into account a company’s social actions, energy usage, material selection and human and ecosystem health impacts, LEVEL® addresses how a product is sustainable from multiple perspectives. The organization, facilities, and products are audited on an annual basis to ensure ongoing compliance and improvement.

With LEVEL®, customers can make informed choices about sustainable commercial office furniture. The LEVEL® mark identifies that a product has been vetted by an independent third party certifier and its numeric marking of 1, 2, or 3 indicates the threshold of certification the product has achieved. A majority of HBF’s seating, occasional tables, and conference lines are LEVEL® certified. Please download the certificates from our product pages for the complete details. For more information about the ANSI/BIFMA LEVEL® standard, visit www.levelcertified.org.

**ANSI/BIFMA Performance
Standards**

Our seating products meet or exceed ANSI/BIFMA weight performance standards of 275 lbs. (124.7 kg.) unless otherwise noted.

**Indoor Advantage™
Gold certified**

All HBF seating products are Indoor Advantage™ Gold Certified.

SCS Global Services, a reputable third-party certification and assessment body of environmental, sustainability and safety claims since 1984, has developed internationally recognized standards and certification programs to assist businesses with improving their environmental efforts, social accountability and product performance.

The advantages of holding Indoor Air Quality certification are substantial: in addition to improving indoor working environments and meeting qualifications for the LEED-CI EQ 4.5 credit for office furniture as well as the BIFMA Standard for Low-Emitting Office Furniture Systems & Seating M-7.1, there is the added assurance of knowing that the company’s entire breadth of products is held to such rigorous standards.

For more information regarding Indoor Advantage™, please visit: <http://www.scsglobalservices.com>.

Please contact the HBF Client Experience Team for pricing and lead time information.

Dimension Guide

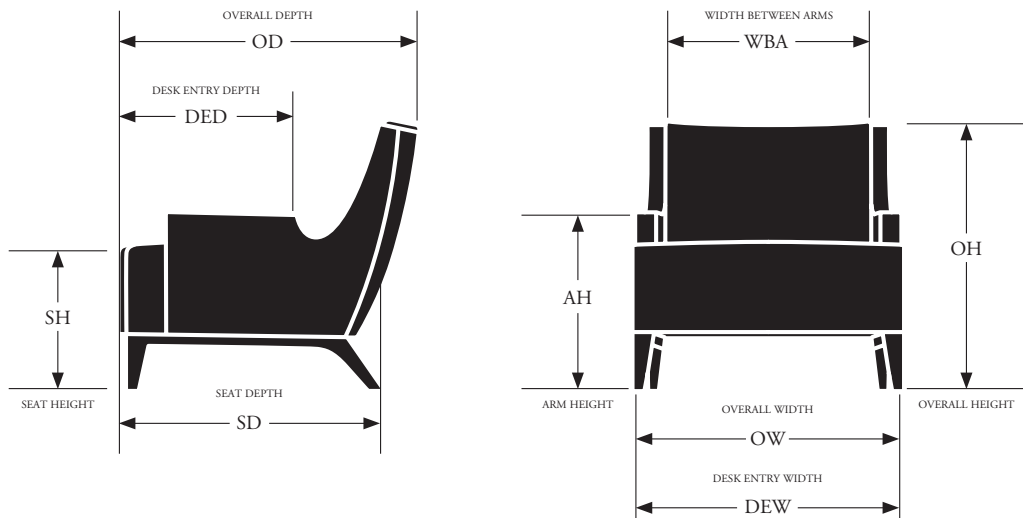



GSA/Federal Contract Information:

GSA Contract Number 47QSMA22D08P9

Model numbers identified with the following verbiage “When purchased separately without a configurable TAA compliant end product, not on GSA contract” is to mean that these configurable parts or components:

- Have no functionality or capability without being integrated into an end product; and
- Are considered **Open Market** if purchased without a configurable TAA compliant end product.

HBF High Performance Products

HBF and HBF Textiles have long been leaders in contract furnishings and known for industry-leading product design coupled with the highest quality construction, comfort and aesthetic beauty.

Now these same principals are the cornerstones of HBF Healthcare high performance products. We have consulted with healthcare designers and clients to provide products and options for interiors that will provide quality sustainable design solutions for the future. These effective solutions will address the unique interactions required by any high-use facility. Visit www.hbf.com for additional high performance product information.

Seating Product High Performance Options:

- Guest and Lounge Seating
- Arm Caps
- Moisture Barrier
- Wipe Out - Clean Out
- Tandem Seating
- Wall Saver Legs
- Replaceable Components
- Upholstery Products from HBF Textiles

Spring Down Cushions

Optional spring down cushions are available on most loose cushion HBF lounge seating. List upcharges are:

	\$108
Loveseat	\$194
Sofa	\$297

Veneer and Finishes

Wood owes its inherent beauty to variations in color, grain, and texture; therefore, these variations are not considered defects. Due to the natural color and grain variances of wood substance the final finish color, texture and grain may vary from one furniture piece to another even though they are finished at the same time. Exposure to light and the aging process will cause changes in surface color of natural wood products. Light finishes on wood products do not mask the natural characteristics of wood. HBF does not guarantee the exact matching of grain, pattern and color.

An upcharge of **5% Net** COM per seating unit, with a minimum upcharge of **\$500 Net** per order, will apply for any custom wood finish.

Refer to the following page for product material options.



POWDER COAT:



P8X
Solar Black

METAL:



PAL
Polished Aluminum

Screen images are intended as a guide only and should not be regarded as absolutely correct.
For exact color/texture, please visit www.hbf.com to request an actual sample.



Grade A	Grade B	Grade C	Grade D	Grade E	Grade F
Blink Denim Wash* Walkabout Zippy	Look-see Remember Rush*	Caddy Corner* Checkmate Cuddle Up Picnic Plaid Upbeat	Chenille Striae Crumpled Paper Dot Grid Habu Poppy Skim Coat	Fourfold* Uptown	All Terrain Bunny Cloverleaf Comfort Zone Happy Camper Here & There Knitwork Laugh Lines Moody Moss Notable Grain Sherpa Well-Loved

Grade G	Grade H	Grade J	Grade K	Grade L	Grade M
Beetle Curtain Wall Dashing Equation* Folded Lines High Rise Honest* Inherent Matriarch Pebbled Scribble XS Stardust Upscale	Air Mail* Captain Bubble Crafted Felt Chubby Baby Intersection Lawn Chair Madam Dottie Soft Angles 2.0 Upstart Uptick	Abito Argyle Boucle Belgian Meadow Brushed Canvas Digital Bloom 2.0 Enriched Boucle Glint Lava Rock Quill Scribble XL Sir Stripe-a-lot Tattoo Toile Tessellations Tête-à-Tête Tickled Herring Twist	Afghan Cherished Knit Complex Crosstweed Double Stitch Gather Grateful Grid Heartfelt Merci Boucle Moving Blanket Moving Forward Night Earth Pepper Blend Polygone Quilted Comfort Sideways Sister Solid	Agate Stripe Goosebumps Hipster Landscape Blur Ms. Quilty 2.0 Smart* Sweater Velvet Mix Woven Memory	Crafted Cloud Eccentric Flirt Poodle

Leather I	Leather II	Leather III	Leather IV	Leather V	Leather VI
Clutch	Vivace II	Aviator	Free Way	Wild West	Modern Patina Upper Crust

*Some or all colors to be discontinued in 2024

Casters

Double wheel medium casters (A) are standard on Cadre Series swivel products.

Optional soft wheel casters (B) are available on Cadre Series swivel products.
This must be specified on product orders.

*(A)
Double Wheel
Wheel Diameter 2"*



*(B)
Soft Wheel
Wheel Diameter 2"*





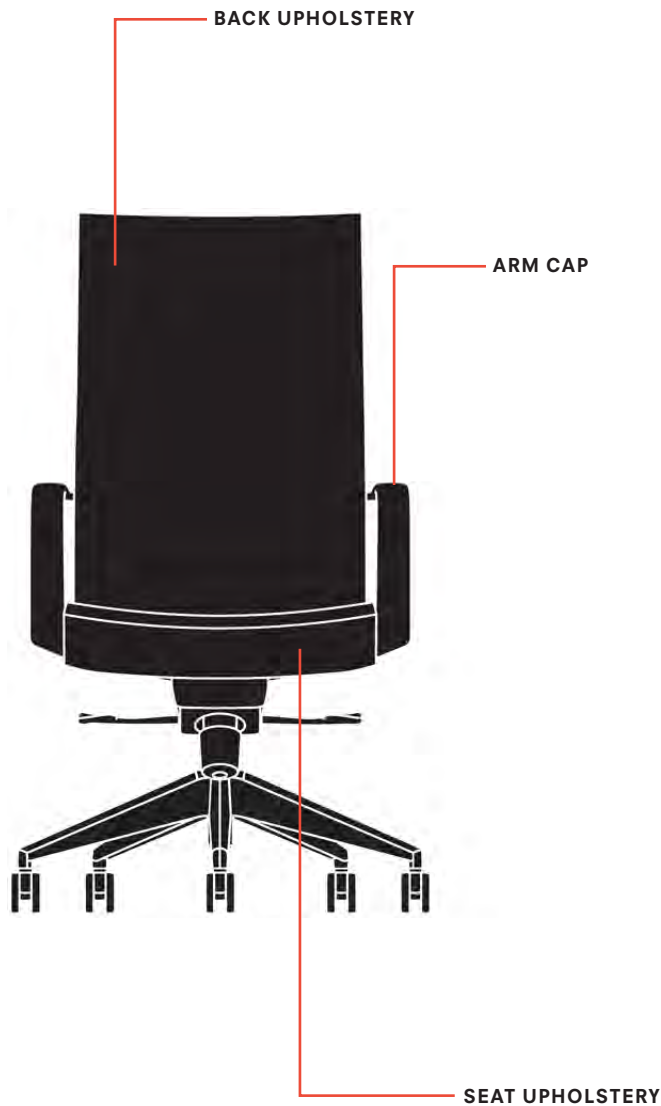

Cadre Series Specifications

Collection Details	Mid Back vs High Back Plain or Channel Stitched seat and inside back
Adjustments	Knee tilt adjustment and pneumatic seat height and are standard on Cadre chairs with arm that wraps around the back of the chair. Synchronized seat and back movement are standard on all other chairs. Synchro Tilt vs Knee Tilt
Bases	Finish for five-prong bases is standard in either black metal or polished aluminum, as listed in the specification notes for each model.
Casters	Double wheel casters are standard on all chairs. Optional soft wheel casters available.
Arms	Non-wraparound vs wraparound arm frame Finish for arms is standard in either black metal or polished aluminum, as listed in the specification notes for each model. Urethane vs upholstered arm cap









CADRE MID BACK

<p>MID BACK SWIVEL CHAIR</p> <p>Synchro Tilt, Upholstered Arm Cap, Polished Arm HST222-511 Pg 20</p>  <p>OH 35½-39½ SD 19 OW 24 AH 26½-30½ OD 26 WBA 19 SH* 18½-22½</p> <p>POLISHED WITH URETHANE ARM CAP HST222-611 Pg 36</p> <p>SOLAR BLACK WITH UPHOLSTERED ARM CAP HST222-011 Pg 12</p> <p>SOLAR BLACK WITH URETHANE ARM CAP HST222-111 Pg 28</p>	<p>MID BACK SWIVEL CHAIR</p> <p>Knee Tilt, Upholstered Arm Cap, Polished Wrap Around Arm HST222-531 Pg 22</p>  <p>OH 35½-39½ SD 19 OW 24 AH 26½-30½ OD 26 WBA 19 SH* 18½-22½</p> <p>POLISHED WITH URETHANE ARM CAP HST222-631 Pg 38</p> <p>SOLAR BLACK WITH UPHOLSTERED ARM CAP HST222-031 Pg 14</p> <p>SOLAR BLACK WITH URETHANE ARM CAP HST222-131 Pg 30</p>	<p>MID BACK CHANNEL STITCHED SWIVEL CHAIR</p> <p>Synchro Tilt, Upholstered Arm Cap, Polished Arm HST222-551 Pg 24</p>  <p>OH 35½-39½ SD 19 OW 24 AH 26½-30½ OD 26 WBA 19 SH* 18½-22½</p> <p>POLISHED WITH URETHANE ARM CAP HST222-651 Pg 40</p> <p>SOLAR BLACK WITH UPHOLSTERED ARM CAP HST222-051 Pg 16</p> <p>SOLAR BLACK WITH URETHANE ARM CAP HST222-151 Pg 32</p>	<p>MID BACK CHANNEL STITCHED SWIVEL CHAIR</p> <p>Knee Tilt, Upholstered Arm Cap, Polished Wrap Around Arm HST222-571 Pg 26</p>  <p>OH 35½-39½ SD 19 OW 24 AH 26½-30½ OD 26 WBA 19 SH* 18½-22½</p> <p>POLISHED WITH URETHANE ARM CAP HST222-671 Pg 42</p> <p>SOLAR BLACK WITH UPHOLSTERED ARM CAP HST222-071 Pg 18</p> <p>SOLAR BLACK WITH URETHANE ARM CAP HST222-171 Pg 34</p>
--	---	---	--

CADRE HIGH BACK

<p>HIGH BACK SWIVEL CHAIR</p> <p>Synchro Tilt, Upholstered Arm Cap, Polished Arm HST222-521 Pg 21</p>  <p>OH 41½-44½ SD 19 OW 24 AH 26½-30½ OD 26 WBA 19 SH* 18½-22½</p> <p>POLISHED WITH URETHANE ARM CAP HST222-621 Pg 37</p> <p>SOLAR BLACK WITH UPHOLSTERED ARM CAP HST222-021 Pg 13</p> <p>SOLAR BLACK WITH URETHANE ARM CAP HST222-121 Pg 29</p>	<p>HIGH BACK SWIVEL CHAIR</p> <p>Knee Tilt, Upholstered Arm Cap, Polished Wrap Around Arm HST222-541 Pg 23</p>  <p>OH 41½-44½ SD 19 OW 24 AH 26½-30½ OD 26 WBA 19 SH* 18½-22½</p> <p>POLISHED WITH URETHANE ARM CAP HST222-641 Pg 39</p> <p>SOLAR BLACK WITH UPHOLSTERED ARM CAP HST222-041 Pg 15</p> <p>SOLAR BLACK WITH URETHANE ARM CAP HST222-141 Pg 31</p>	<p>HIGH BACK CHANNEL STITCHED SWIVEL CHAIR</p> <p>Synchro Tilt, Upholstered Arm Cap, Polished Arm HST222-561 Pg 25</p>  <p>OH 41½-44½ SD 19 OW 24 AH 26½-30½ OD 26 WBA 19 SH* 18½-22½</p> <p>POLISHED WITH URETHANE ARM CAP HST222-661 Pg 41</p> <p>SOLAR BLACK WITH UPHOLSTERED ARM CAP HST222-061 Pg 17</p> <p>SOLAR BLACK WITH URETHANE ARM CAP HST222-161 Pg 33</p>	<p>HIGH BACK CHANNEL STITCHED SWIVEL CHAIR</p> <p>Synchro Tilt, Upholstered Arm Cap, Polished Wrap Around Arm HST222-581 Pg 27</p>  <p>OH 41½-44½ SD 19 OW 24 AH 26½-30½ OD 26 WBA 19 SH* 18½-22½</p> <p>POLISHED WITH URETHANE ARM CAP HST222-681 Pg 43</p> <p>SOLAR BLACK WITH UPHOLSTERED ARM CAP HST222-081 Pg 19</p> <p>SOLAR BLACK WITH URETHANE ARM CAP HST222-181 Pg 35</p>
---	--	--	--

DIMENSIONS

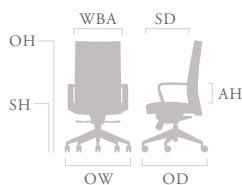

- OH Overall Height
- OW Overall Width
- OD Overall Depth
- SH* Seat Height
- SH* Seat Depth
- AH Arm Height
- WBA Width Between Arms

All dimensions in inches.

*Reflects the nominal seat height to the top of cushion welt.

*Arm and base metal finishing will always match.





Dimensions

Cadre HST222-011



OH	35½-39½	AH	26½-30½
OW	24	WBA	19
OD	26	DED	
SH	18½-22½	DEW	
SD	19	R	

Shipping Weight	66
Cube	20.4

Mid Back | Upholstered Back and Seat | Black Arm with Upholstered Arm Cap | Five-Prong Black Metal Base |

Synchronized Adjustments | Double Wheel Casters

ANSI/BIFMA LEVEL® Furniture Sustainability Standard certified
Indoor Advantage™ certified

Pricing for Single Fabric Placement:

Upholstery:

COM/COL	2615
Grade A	2560
Grade B	2590
Grade C	2615
Grade D	2645
Grade E	2670
Grade F	2705
Grade G	2745
Grade H	2785
Grade J	2810
Grade K	2865
Grade L	2950
Grade M	3060
Leather I	3250
Leather II	3450
Leather III	3650
Leather IV	3850
Leather V	4050
Leather VI	4250

Upholstery Requires:

Fabric:	2½	Yards
Leather:	45	Sq. Ft.

Pricing for Multiple Fabric Placement:

(To Calculate, Begin with Base Price and add Upcharges)

Back Upholstery:

COM/COL	30
Grade A	10
Grade B	20
Grade C	30
Grade D	45
Grade E	55
Grade F	65
Grade G	85
Grade H	100
Grade J	110
Grade K	130
Grade L	165
Grade M	210
Leather I	285
Leather II	365
Leather III	445
Leather IV	525
Leather V	605
Leather VI	685

Upholstery Requires (Per Application):

Fabric:	1	Yard
Leather:	18	Sq. Ft.

Arm Upholstery:

COM/COL	20
Grade A	5
Grade B	15
Grade C	20
Grade D	25
Grade E	30
Grade F	35
Grade G	45
Grade H	50
Grade J	55
Grade K	70
Grade L	85
Grade M	105
Leather I	145
Leather II	185
Leather III	225
Leather IV	265
Leather V	305
Leather VI	345

Upholstery Requires (Per Application):

Fabric:	½	Yard
Leather:	9	Sq. Ft.

Seat Upholstery:

COM/COL	30
Grade A	10
Grade B	20
Grade C	30
Grade D	45
Grade E	55
Grade F	65
Grade G	85
Grade H	100
Grade J	110
Grade K	130
Grade L	165
Grade M	210
Leather I	285
Leather II	365
Leather III	445
Leather IV	525
Leather V	605
Leather VI	685

Upholstery Requires (Per Application):

Fabric:	1	Yard
Leather:	18	Sq. Ft.

Base Price: 2535

Total Required

Upholstery: Fabric: 2½ Yards
Leather: 45 Sq. Ft.

PLEASE SPECIFY THE FOLLOWING TO ORDER:

MODEL NUMBER	TEXTILES Indicate fabric choice for: Back upholstery <i>See options for fabrics at www.hbftextiles.com</i>	TEXTILES Indicate fabric choice for: Arm upholstery <i>See options for fabrics at www.hbftextiles.com</i>	TEXTILES Indicate fabric choice for: Seat upholstery <i>See options for fabrics at www.hbftextiles.com</i>	FLAMMABILITY Indicate flammability: U = Cal 117	CASTER DWCM = Double Wheel - Medium Casters DWCS = Double Wheel - Soft Casters +\$106
--------------	---	--	---	--	---

HST222-011.BackFabric.ArmFabric.SeatFabric.Flammability.Caster Example: HST222-011.950-88.950-88.950-88.U.DWCM



Dimensions

Cadre HST222-021



OH	41½-44½	AH	26½-30½
OW	24	WBA	19
OD	26	DED	
SH	18½-22½	DEW	
SD	19	R	
Shipping Weight		66	
Cube		22.5	

High Back | Upholstered Back and Seat | Black Arm with Upholstered Arm Cap | Five-Prong Black Metal Base |

Synchronized Adjustments | Double Wheel Casters

ANSI/BIFMA LEVEL® Furniture Sustainability Standard certified
Indoor Advantage™ certified

Pricing for Single Fabric Placement:

Upholstery:

COM/COL	2955
Grade A	2890
Grade B	2925
Grade C	2955
Grade D	2985
Grade E	3015
Grade F	3050
Grade G	3095
Grade H	3135
Grade J	3165
Grade K	3230
Grade L	3320
Grade M	3440
Leather I	3650
Leather II	3870
Leather III	4090
Leather IV	4310
Leather V	4530
Leather VI	4750

Upholstery Requires:

Fabric: 2¾ Yards
Leather: 49½ Sq. Ft.

Pricing for Multiple Fabric Placement:

(To Calculate, Begin with Base Price and add Upcharges)

Back Upholstery:

COM/COL	45
Grade A	15
Grade B	30
Grade C	45
Grade D	55
Grade E	70
Grade F	90
Grade G	105
Grade H	125
Grade J	140
Grade K	170
Grade L	210
Grade M	265
Leather I	360
Leather II	460
Leather III	560
Leather IV	660
Leather V	760
Leather VI	860

Upholstery Requires (Per Application):

Fabric: 1¼ Yards
Leather: 22½ Sq. Ft.

Arm Upholstery:

COM/COL	20
Grade A	5
Grade B	15
Grade C	20
Grade D	25
Grade E	30
Grade F	35
Grade G	45
Grade H	50
Grade J	55
Grade K	70
Grade L	85
Grade M	105
Leather I	145
Leather II	185
Leather III	225
Leather IV	265
Leather V	305
Leather VI	345

Upholstery Requires (Per Application):

Fabric: ½ Yard
Leather: 9 Sq. Ft.

Seat Upholstery:

COM/COL	30
Grade A	10
Grade B	20
Grade C	30
Grade D	45
Grade E	55
Grade F	65
Grade G	85
Grade H	100
Grade J	110
Grade K	130
Grade L	165
Grade M	210
Leather I	285
Leather II	365
Leather III	445
Leather IV	525
Leather V	605
Leather VI	685

Upholstery Requires (Per Application):

Fabric: 1 Yard
Leather: 18 Sq. Ft.

Base Price: 2860

Total Required

Upholstery: Fabric: 2¾ Yards
Leather: 49½ Sq. Ft.

PLEASE SPECIFY THE FOLLOWING TO ORDER:

MODEL NUMBER	TEXTILES Indicate fabric choice for: Back upholstery <i>See options for fabrics at www.hbftextiles.com</i>	TEXTILES Indicate fabric choice for: Arm upholstery <i>See options for fabrics at www.hbftextiles.com</i>	TEXTILES Indicate fabric choice for: Seat upholstery <i>See options for fabrics at www.hbftextiles.com</i>	FLAMMABILITY Indicate flammability: U = Cal 117	CASTER DWCM = Double Wheel - Medium Casters DWCS = Double Wheel - Soft Casters +\$106
--------------	---	--	---	--	---

HST222-021.BackFabric.ArmFabric.SeatFabric.Flammability.Caster Example: HST222-021.950-88.950-88.950-88.U.DWCM



Dimensions

Cadre HST222-031



OH	35½-39½	AH	26½-30½
OW	24	WBA	19
OD	26	DED	
SH	18½-22½	DEW	
SD	19	R	

Shipping Weight 66
Cube 20.4

Mid Back | Upholstered Back and Seat | Full Black Wrap Around Arm with Upholstered Arm Cap |

Five-Prong Black Metal Base | Knee Tilt | Double Wheel Casters

ANSI/BIFMA LEVEL® Furniture Sustainability Standard certified
Indoor Advantage™ certified

Pricing for Single Fabric Placement:

Upholstery:

COM/COL	2655
Grade A	2600
Grade B	2630
Grade C	2655
Grade D	2685
Grade E	2710
Grade F	2745
Grade G	2785
Grade H	2825
Grade J	2850
Grade K	2905
Grade L	2990
Grade M	3100
Leather I	3290
Leather II	3490
Leather III	3690
Leather IV	3890
Leather V	4090
Leather VI	4290

Upholstery Requires:

Fabric: 2½ Yards
Leather: 45 Sq. Ft.

Pricing for Multiple Fabric Placement:

(To Calculate, Begin with Base Price and add Upcharges)

Back Upholstery:

COM/COL	30
Grade A	10
Grade B	20
Grade C	30
Grade D	45
Grade E	55
Grade F	65
Grade G	85
Grade H	100
Grade J	110
Grade K	130
Grade L	165
Grade M	210
Leather I	285
Leather II	365
Leather III	445
Leather IV	525
Leather V	605
Leather VI	685

Upholstery Requires (Per Application):

Fabric: 1 Yard
Leather: 18 Sq. Ft.

Arm Upholstery:

COM/COL	20
Grade A	5
Grade B	15
Grade C	20
Grade D	25
Grade E	30
Grade F	35
Grade G	45
Grade H	50
Grade J	55
Grade K	70
Grade L	85
Grade M	105
Leather I	145
Leather II	185
Leather III	225
Leather IV	265
Leather V	305
Leather VI	345

Upholstery Requires (Per Application):

Fabric: ½ Yard
Leather: 9 Sq. Ft.

Seat Upholstery:

COM/COL	30
Grade A	10
Grade B	20
Grade C	30
Grade D	45
Grade E	55
Grade F	65
Grade G	85
Grade H	100
Grade J	110
Grade K	130
Grade L	165
Grade M	210
Leather I	285
Leather II	365
Leather III	445
Leather IV	525
Leather V	605
Leather VI	685

Upholstery Requires (Per Application):

Fabric: 1 Yard
Leather: 18 Sq. Ft.

Base Price: 2575

Total Required

Upholstery: Fabric: 2½ Yards
Leather: 45 Sq. Ft.

PLEASE SPECIFY THE FOLLOWING TO ORDER:

<p>MODEL NUMBER</p>	<p>TEXTILES</p> <p>Indicate fabric choice for:</p> <p>Back upholstery</p> <p><i>See options for fabrics at www.hbftextiles.com</i></p>	<p>TEXTILES</p> <p>Indicate fabric choice for:</p> <p>Arm upholstery</p> <p><i>See options for fabrics at www.hbftextiles.com</i></p>	<p>TEXTILES</p> <p>Indicate fabric choice for:</p> <p>Seat upholstery</p> <p><i>See options for fabrics at www.hbftextiles.com</i></p>	<p>FLAMMABILITY</p> <p>Indicate flammability:</p> <p>U = Cal 117</p>	<p>CASTER</p> <p>DWCM = Double Wheel - Medium Casters</p> <p>DWCS = Double Wheel - Soft Casters +\$106</p>
----------------------------	--	---	--	--	---

HST222-031.BackFabric.ArmFabric.SeatFabric.Flammability.Caster Example: HST222-031.950-88.950-88.950-88.U.DWCM



Dimensions

Cadre HST222-041



OH	41½-44½	AH	26½-30½
OW	24	WBA	19
OD	26	DED	
SH	18½-22½	DEW	
SD	19	R	

Shipping Weight 66
Cube 22.5

High Back | Upholstered Back and Seat | Full Black Wrap Around Arm with Upholstered Arm Cap |

ANSI/BIFMA LEVEL® Furniture Sustainability Standard certified
Indoor Advantage™ certified

Five-Prong Black Metal Base | Knee Tilt | Double Wheel Casters

Pricing for Single Fabric Placement:

Upholstery:

COM/COL	3005
Grade A	2940
Grade B	2975
Grade C	3005
Grade D	3035
Grade E	3065
Grade F	3100
Grade G	3145
Grade H	3185
Grade J	3215
Grade K	3280
Grade L	3370
Grade M	3490
Leather I	3700
Leather II	3920
Leather III	4140
Leather IV	4360
Leather V	4580
Leather VI	4800

Upholstery Requires:

Fabric: 2¾ Yards
Leather: 49½ Sq. Ft.

Pricing for Multiple Fabric Placement:

(To Calculate, Begin with Base Price and add Upcharges)

Back Upholstery:

COM/COL	45
Grade A	15
Grade B	30
Grade C	45
Grade D	55
Grade E	70
Grade F	90
Grade G	105
Grade H	125
Grade J	140
Grade K	170
Grade L	210
Grade M	265
Leather I	360
Leather II	460
Leather III	560
Leather IV	660
Leather V	760
Leather VI	860

Upholstery Requires (Per Application):

Fabric: 1¼ Yards
Leather: 22½ Sq. Ft.

Arm Upholstery:

COM/COL	20
Grade A	5
Grade B	15
Grade C	20
Grade D	25
Grade E	30
Grade F	35
Grade G	45
Grade H	50
Grade J	55
Grade K	70
Grade L	85
Grade M	105
Leather I	145
Leather II	185
Leather III	225
Leather IV	265
Leather V	305
Leather VI	345

Upholstery Requires (Per Application):

Fabric: ½ Yard
Leather: 9 Sq. Ft.

Seat Upholstery:

COM/COL	30
Grade A	10
Grade B	20
Grade C	30
Grade D	45
Grade E	55
Grade F	65
Grade G	85
Grade H	100
Grade J	110
Grade K	130
Grade L	165
Grade M	210
Leather I	285
Leather II	365
Leather III	445
Leather IV	525
Leather V	605
Leather VI	685

Upholstery Requires (Per Application):

Fabric: 1 Yard
Leather: 18 Sq. Ft.

Base Price: 2910

Total Required

Upholstery: Fabric: 2¾ Yards
Leather: 49½ Sq. Ft.

PLEASE SPECIFY THE FOLLOWING TO ORDER:

<p>MODEL NUMBER</p>	<p>TEXTILES</p> <p>Indicate fabric choice for:</p> <p>Back upholstery</p> <p><i>See options for fabrics at www.hbftextiles.com</i></p>	<p>TEXTILES</p> <p>Indicate fabric choice for:</p> <p>Arm upholstery</p> <p><i>See options for fabrics at www.hbftextiles.com</i></p>	<p>TEXTILES</p> <p>Indicate fabric choice for:</p> <p>Seat upholstery</p> <p><i>See options for fabrics at www.hbftextiles.com</i></p>	<p>FLAMMABILITY</p> <p>Indicate flammability:</p> <p>U = Cal 117</p>	<p>CASTER</p> <p>DWCM = Double Wheel - Medium Casters</p> <p>DWCS = Double Wheel - Soft Casters +\$106</p>
---------------------	--	---	--	---	--

HST222-041.BackFabric.ArmFabric.SeatFabric.Flammability.Caster Example: HST222-041.950-88.950-88.950-88.U.DWCM



Dimensions

Cadre HST222-051

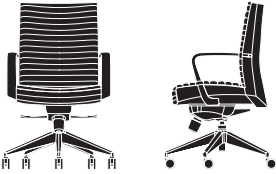

OH	35½-39½	AH	26½-30½
OW	24	WBA	19
OD	26	DED	
SH	18½-22½	DEW	
SD	19	R	

Shipping Weight 66
Cube 20.4

Mid Back | Channel Stitched Upholstered Back and Seat | Black Arm with Upholstered Arm Cap | Five-Prong Black Metal Base |

Synchronized Adjustments | Double Wheel Casters

ANSI/BIFMA LEVEL® Furniture Sustainability Standard certified
Indoor Advantage™ certified

Pricing for Single Fabric Placement:

Upholstery:

COM/COL	3125
Grade A	3030
Grade B	3075
Grade C	3125
Grade D	3170
Grade E	3220
Grade F	3275
Grade G	3340
Grade H	3405
Grade J	3455
Grade K	3550
Grade L	3690
Grade M	3880
Leather I	4200
Leather II	4540
Leather III	4880
Leather IV	5220
Leather V	5560
Leather VI	5900

Upholstery Requires:

Fabric: 4¼ Yards
Leather: 76½ Sq. Ft.

Pricing for Multiple Fabric Placement:

(To Calculate, Begin with Base Price and add Upcharges)

Back Upholstery:

COM/COL	75
Grade A	25
Grade B	50
Grade C	75
Grade D	100
Grade E	125
Grade F	155
Grade G	190
Grade H	225
Grade J	250
Grade K	300
Grade L	375
Grade M	475
Leather I	645
Leather II	825
Leather III	1005
Leather IV	1185
Leather V	1365
Leather VI	1545

Upholstery Requires (Per Application):

Fabric: 2¼ Yards
Leather: 40½ Sq. Ft.

Arm Upholstery:

COM/COL	20
Grade A	5
Grade B	15
Grade C	20
Grade D	25
Grade E	30
Grade F	35
Grade G	45
Grade H	50
Grade J	55
Grade K	70
Grade L	85
Grade M	105
Leather I	145
Leather II	185
Leather III	225
Leather IV	265
Leather V	305
Leather VI	345

Upholstery Requires (Per Application):

Fabric: ½ Yard
Leather: 9 Sq. Ft.

Seat Upholstery:

COM/COL	50
Grade A	15
Grade B	35
Grade C	50
Grade D	65
Grade E	85
Grade F	105
Grade G	125
Grade H	150
Grade J	165
Grade K	200
Grade L	250
Grade M	315
Leather I	430
Leather II	550
Leather III	670
Leather IV	790
Leather V	910
Leather VI	1030

Upholstery Requires (Per Application):

Fabric: 1½ Yards
Leather: 27 Sq. Ft.

Base Price: 2980

Total Required

Upholstery: Fabric: 4¼ Yards
Leather: 76½ Sq. Ft.

PLEASE SPECIFY THE FOLLOWING TO ORDER:

<p>MODEL NUMBER</p>	<p>TEXTILES</p> <p>Indicate fabric choice for:</p> <p>Back upholstery</p> <p><i>See options for fabrics at www.hbftextiles.com</i></p>	<p>TEXTILES</p> <p>Indicate fabric choice for:</p> <p>Arm upholstery</p> <p><i>See options for fabrics at www.hbftextiles.com</i></p>	<p>TEXTILES</p> <p>Indicate fabric choice for:</p> <p>Seat upholstery</p> <p><i>See options for fabrics at www.hbftextiles.com</i></p>	<p>FLAMMABILITY</p> <p>Indicate flammability:</p> <p>U = Cal 117</p>	<p>CASTER</p> <p>DWCM = Double Wheel - Medium Casters</p> <p>DWCS = Double Wheel - Soft Casters +\$106</p>
---------------------	--	---	--	---	--

HST222-051.BackFabric.ArmFabric.SeatFabric.Flammability.Caster Example: HST222-051.950-88.950-88.950-88.U.DWCM



Dimensions

Cadre HST222-061



OH	41½-44½	AH	26½-30½
OW	24	WBA	19
OD	26	DED	
SH	18½-22½	DEW	
SD	19	R	

Shipping Weight 66
Cube 22.5

High Back | Channel Stitched Upholstered Back and Seat | Black Arm with Upholstered Arm Cap | Five-Prong Black Metal Base |

Synchronized Adjustments | Double Wheel Casters

ANSI/BIFMA LEVEL® Furniture Sustainability Standard certified
Indoor Advantage™ certified

Pricing for Single Fabric Placement:

Upholstery:

COM/COL	3415
Grade A	3330
Grade B	3375
Grade C	3415
Grade D	3455
Grade E	3500
Grade F	3550
Grade G	3605
Grade H	3665
Grade J	3705
Grade K	3790
Grade L	3915
Grade M	4080
Leather I	4365
Leather II	4665
Leather III	4965
Leather IV	5265
Leather V	5565
Leather VI	5865

Upholstery Requires:

Fabric: 3¾ Yards
Leather: 67½ Sq. Ft.

Pricing for Multiple Fabric Placement:

(To Calculate, Begin with Base Price and add Upcharges)

Back Upholstery:

COM/COL	55
Grade A	20
Grade B	35
Grade C	55
Grade D	75
Grade E	95
Grade F	120
Grade G	145
Grade H	175
Grade J	195
Grade K	230
Grade L	290
Grade M	370
Leather I	500
Leather II	640
Leather III	780
Leather IV	920
Leather V	1060
Leather VI	1200

Upholstery Requires (Per Application):

Fabric: 1¾ Yards
Leather: 31½ Sq. Ft.

Arm Upholstery:

COM/COL	20
Grade A	5
Grade B	15
Grade C	20
Grade D	25
Grade E	30
Grade F	35
Grade G	45
Grade H	50
Grade J	55
Grade K	70
Grade L	85
Grade M	105
Leather I	145
Leather II	185
Leather III	225
Leather IV	265
Leather V	305
Leather VI	345

Upholstery Requires (Per Application):

Fabric: ½ Yard
Leather: 9 Sq. Ft.

Seat Upholstery:

COM/COL	50
Grade A	15
Grade B	35
Grade C	50
Grade D	65
Grade E	85
Grade F	105
Grade G	125
Grade H	150
Grade J	165
Grade K	200
Grade L	250
Grade M	315
Leather I	430
Leather II	550
Leather III	670
Leather IV	790
Leather V	910
Leather VI	1030

Upholstery Requires (Per Application):

Fabric: 1½ Yards
Leather: 27 Sq. Ft.

Base Price: 3290

Total Required

Upholstery: Fabric: 3¾ Yards
Leather: 67½ Sq. Ft.

PLEASE SPECIFY THE FOLLOWING TO ORDER:

<p>MODEL NUMBER</p>	<p>TEXTILES</p> <p>Indicate fabric choice for:</p> <p>Back upholstery</p> <p><i>See options for fabrics at www.hbftextiles.com</i></p>	<p>TEXTILES</p> <p>Indicate fabric choice for:</p> <p>Arm upholstery</p> <p><i>See options for fabrics at www.hbftextiles.com</i></p>	<p>TEXTILES</p> <p>Indicate fabric choice for:</p> <p>Seat upholstery</p> <p><i>See options for fabrics at www.hbftextiles.com</i></p>	<p>FLAMMABILITY</p> <p>Indicate flammability:</p> <p>U = Cal 117</p>	<p>CASTER</p> <p>DWCM = Double Wheel - Medium Casters</p> <p>DWCS = Double Wheel - Soft Casters +\$106</p>
----------------------------	--	---	--	--	---

HST222-061.BackFabric.ArmFabric.SeatFabric.Flammability.Caster

Example: HST222-061.950-88.950-88.950-88.U.DWCM



Dimensions

Cadre HST222-071



OH	35½-39½	AH	26½-30½
OW	24	WBA	19
OD	26	DED	
SH	18½-22½	DEW	
SD	19	R	

Shipping Weight 66
Cube 20.4

Mid Back | Channel Stitched Upholstered Back and Seat | Full Black Wrap Around Arm with Upholstered Arm Cap | Five-Prong Black Metal Base | Knee Tilt | Double Wheel Casters

ANSI/BIFMA LEVEL® Furniture Sustainability Standard certified
Indoor Advantage™ certified

Pricing for Single Fabric Placement:

Upholstery:

COM/COL	3175
Grade A	3080
Grade B	3125
Grade C	3175
Grade D	3220
Grade E	3270
Grade F	3325
Grade G	3390
Grade H	3455
Grade J	3505
Grade K	3600
Grade L	3740
Grade M	3930
Leather I	4250
Leather II	4590
Leather III	4930
Leather IV	5270
Leather V	5610
Leather VI	5950

Upholstery Requires:

Fabric: 4¼ Yards
Leather: 76½ Sq. Ft.

Pricing for Multiple Fabric Placement:

(To Calculate, Begin with Base Price and add Upcharges)

Back Upholstery:

COM/COL	75
Grade A	25
Grade B	50
Grade C	75
Grade D	100
Grade E	125
Grade F	155
Grade G	190
Grade H	225
Grade J	250
Grade K	300
Grade L	375
Grade M	475
Leather I	645
Leather II	825
Leather III	1005
Leather IV	1185
Leather V	1365
Leather VI	1545

Upholstery Requires (Per Application):

Fabric: 2¼ Yards
Leather: 40½ Sq. Ft.

Arm Upholstery:

COM/COL	20
Grade A	5
Grade B	15
Grade C	20
Grade D	25
Grade E	30
Grade F	35
Grade G	45
Grade H	50
Grade J	55
Grade K	70
Grade L	85
Grade M	105
Leather I	145
Leather II	185
Leather III	225
Leather IV	265
Leather V	305
Leather VI	345

Upholstery Requires (Per Application):

Fabric: ½ Yard
Leather: 9 Sq. Ft.

Seat Upholstery:

COM/COL	50
Grade A	15
Grade B	35
Grade C	50
Grade D	65
Grade E	85
Grade F	105
Grade G	125
Grade H	150
Grade J	165
Grade K	200
Grade L	250
Grade M	315
Leather I	430
Leather II	550
Leather III	670
Leather IV	790
Leather V	910
Leather VI	1030

Upholstery Requires (Per Application):

Fabric: 1½ Yards
Leather: 27 Sq. Ft.

Base Price: 3030

Total Required

Upholstery: Fabric: 4¼ Yards
Leather: 76½ Sq. Ft.

PLEASE SPECIFY THE FOLLOWING TO ORDER:

MODEL NUMBER	TEXTILES Indicate fabric choice for: Back upholstery <i>See options for fabrics at www.hbftextiles.com</i>	TEXTILES Indicate fabric choice for: Arm upholstery <i>See options for fabrics at www.hbftextiles.com</i>	TEXTILES Indicate fabric choice for: Seat upholstery <i>See options for fabrics at www.hbftextiles.com</i>	FLAMMABILITY Indicate flammability: U = Cal 117	CASTER DWCM = Double Wheel - Medium Casters DWCS = Double Wheel - Soft Casters +\$106
--------------	---	--	---	--	---

HST222-071.BackFabric.ArmFabric.SeatFabric.Flammability.Caster Example: HST222-071.950-88.950-88.950-88.U.DWCM



Dimensions

Cadre HST222-081



OH	41½-44½	AH	26½-30½
OW	24	WBA	19
OD	26	DED	
SH	18½-22½	DEW	
SD	19	R	
Shipping Weight		66	
Cube		22.5	

High Back | Channel Stitched Upholstered Back and Seat | Full Black Wrap Around Arm with Upholstered Arm Cap | Five-Prong Black Metal Base | Knee Tilt | Double Wheel Casters

ANSI/BIFMA LEVEL® Furniture Sustainability Standard certified
Indoor Advantage™ certified

Pricing for Single Fabric Placement:

Upholstery:

COM/COL	3470
Grade A	3385
Grade B	3430
Grade C	3470
Grade D	3510
Grade E	3555
Grade F	3605
Grade G	3660
Grade H	3720
Grade J	3760
Grade K	3845
Grade L	3970
Grade M	4135
Leather I	4420
Leather II	4720
Leather III	5020
Leather IV	5320
Leather V	5620
Leather VI	5920

Upholstery Requires:

Fabric: 3¾ Yards
Leather: 67½ Sq. Ft.

Pricing for Multiple Fabric Placement:
(To Calculate, Begin with Base Price and add Upcharges)

Back Upholstery:

COM/COL	55
Grade A	20
Grade B	35
Grade C	55
Grade D	75
Grade E	95
Grade F	120
Grade G	145
Grade H	175
Grade J	195
Grade K	230
Grade L	290
Grade M	370
Leather I	500
Leather II	640
Leather III	780
Leather IV	920
Leather V	1060
Leather VI	1200

Upholstery Requires (Per Application):

Fabric: 1¾ Yards
Leather: 31½ Sq. Ft.

Arm Upholstery:

COM/COL	20
Grade A	5
Grade B	15
Grade C	20
Grade D	25
Grade E	30
Grade F	35
Grade G	45
Grade H	50
Grade J	55
Grade K	70
Grade L	85
Grade M	105
Leather I	145
Leather II	185
Leather III	225
Leather IV	265
Leather V	305
Leather VI	345

Upholstery Requires (Per Application):

Fabric: ½ Yard
Leather: 9 Sq. Ft.

Seat Upholstery:

COM/COL	50
Grade A	15
Grade B	35
Grade C	50
Grade D	65
Grade E	85
Grade F	105
Grade G	125
Grade H	150
Grade J	165
Grade K	200
Grade L	250
Grade M	315
Leather I	430
Leather II	550
Leather III	670
Leather IV	790
Leather V	910
Leather VI	1030

Upholstery Requires (Per Application):

Fabric: 1½ Yards
Leather: 27 Sq. Ft.

Base Price: 3345

Total Required Upholstery: Fabric: 3¾ Yards
Leather: 67½ Sq. Ft.

PLEASE SPECIFY THE FOLLOWING TO ORDER:

MODEL NUMBER	TEXTILES Indicate fabric choice for: Back upholstery <i>See options for fabrics at www.hbftextiles.com</i>	TEXTILES Indicate fabric choice for: Arm upholstery <i>See options for fabrics at www.hbftextiles.com</i>	TEXTILES Indicate fabric choice for: Seat upholstery <i>See options for fabrics at www.hbftextiles.com</i>	FLAMMABILITY Indicate flammability: U = Cal 117	CASTER DWCM = Double Wheel - Medium Casters DWCS = Double Wheel - Soft Casters +\$106
--------------	---	--	---	--	---

HST222-081.BackFabric.ArmFabric.SeatFabric.Flammability.Caster Example: HST222-081.950-88.950-88.950-88.U.DWCM



Dimensions

Cadre HST222-511



OH	35½-39½	AH	26½-30½
OW	24	WBA	19
OD	26	DED	
SH	18½-22½	DEW	
SD	19	R	

Shipping Weight	66
Cube	20.4

Mid Back | Upholstered Back and Seat | Polished Aluminum Arm with Upholstered Arm Cap |

ANSI/BIFMA LEVEL® Furniture Sustainability Standard certified
Indoor Advantage™ certified

Synchronized Adjustments | Five-Prong Polished Aluminum Base | Double Wheel Casters

Pricing for Single Fabric Placement:

Upholstery:

COM/COL	2615
Grade A	2560
Grade B	2590
Grade C	2615
Grade D	2645
Grade E	2670
Grade F	2705
Grade G	2745
Grade H	2785
Grade J	2810
Grade K	2865
Grade L	2950
Grade M	3060
Leather I	3250
Leather II	3450
Leather III	3650
Leather IV	3850
Leather V	4050
Leather VI	4250

Upholstery Requires:

Fabric:	2½	Yards
Leather:	45	Sq. Ft.

Pricing for Multiple Fabric Placement:

(To Calculate, Begin with Base Price and add Upcharges)

Back Upholstery:

COM/COL	30
Grade A	10
Grade B	20
Grade C	30
Grade D	45
Grade E	55
Grade F	65
Grade G	85
Grade H	100
Grade J	110
Grade K	130
Grade L	165
Grade M	210
Leather I	285
Leather II	365
Leather III	445
Leather IV	525
Leather V	605
Leather VI	685

Upholstery Requires (Per Application):

Fabric:	1	Yard
Leather:	18	Sq. Ft.

Arm Upholstery:

COM/COL	20
Grade A	5
Grade B	15
Grade C	20
Grade D	25
Grade E	30
Grade F	35
Grade G	45
Grade H	50
Grade J	55
Grade K	70
Grade L	85
Grade M	105
Leather I	145
Leather II	185
Leather III	225
Leather IV	265
Leather V	305
Leather VI	345

Upholstery Requires (Per Application):

Fabric:	½	Yard
Leather:	9	Sq. Ft.

Seat Upholstery:

COM/COL	30
Grade A	10
Grade B	20
Grade C	30
Grade D	45
Grade E	55
Grade F	65
Grade G	85
Grade H	100
Grade J	110
Grade K	130
Grade L	165
Grade M	210
Leather I	285
Leather II	365
Leather III	445
Leather IV	525
Leather V	605
Leather VI	685

Upholstery Requires (Per Application):

Fabric:	1	Yard
Leather:	18	Sq. Ft.

Base Price: 2535

Total Required

Upholstery: Fabric: 2½ Yards
Leather: 45 Sq. Ft.

PLEASE SPECIFY THE FOLLOWING TO ORDER:

MODEL NUMBER	TEXTILES Indicate fabric choice for: Back upholstery <i>See options for fabrics at www.hbftextiles.com</i>	TEXTILES Indicate fabric choice for: Arm upholstery <i>See options for fabrics at www.hbftextiles.com</i>	TEXTILES Indicate fabric choice for: Seat upholstery <i>See options for fabrics at www.hbftextiles.com</i>	FLAMMABILITY Indicate flammability: U = Cal 117	CASTER DWCM = Double Wheel - Medium Casters DWCS = Double Wheel - Soft Casters +\$106
--------------	---	--	---	--	---

HST222-511.BackFabric.ArmFabric.SeatFabric.Flammability.Caster Example: HST222-511.950-88.950-88.950-88.U.DWCM



Dimensions

Cadre HST222-521



OH	41½-44½	AH	26½-30½
OW	24	WBA	19
OD	26	DED	
SH	18½-22½	DEW	
SD	19	R	
Shipping Weight		66	
Cube		22.5	

High Back | Upholstered Back and Seat | Polished Aluminum Arm with Upholstered Arm Cap |

Synchronized Adjustments | Five-Prong Polished Aluminum Base | Double Wheel Casters

ANSI/BIFMA LEVEL® Furniture Sustainability Standard certified
Indoor Advantage™ certified

Pricing for Single Fabric Placement:

Upholstery:

COM/COL	2955
Grade A	2890
Grade B	2925
Grade C	2955
Grade D	2985
Grade E	3015
Grade F	3050
Grade G	3095
Grade H	3135
Grade J	3165
Grade K	3230
Grade L	3320
Grade M	3440
Leather I	3650
Leather II	3870
Leather III	4090
Leather IV	4310
Leather V	4530
Leather VI	4750

Upholstery Requires:

Fabric: 2¾ Yards
Leather: 49½ Sq. Ft.

Pricing for Multiple Fabric Placement:

(To Calculate, Begin with Base Price and add Upcharges)

Back Upholstery:

COM/COL	45
Grade A	15
Grade B	30
Grade C	45
Grade D	55
Grade E	70
Grade F	90
Grade G	105
Grade H	125
Grade J	140
Grade K	170
Grade L	210
Grade M	265
Leather I	360
Leather II	460
Leather III	560
Leather IV	660
Leather V	760
Leather VI	860

Upholstery Requires (Per Application):

Fabric: 1¼ Yards
Leather: 22½ Sq. Ft.

Arm Upholstery:

COM/COL	20
Grade A	5
Grade B	15
Grade C	20
Grade D	25
Grade E	30
Grade F	35
Grade G	45
Grade H	50
Grade J	55
Grade K	70
Grade L	85
Grade M	105
Leather I	145
Leather II	185
Leather III	225
Leather IV	265
Leather V	305
Leather VI	345

Upholstery Requires (Per Application):

Fabric: ½ Yard
Leather: 9 Sq. Ft.

Seat Upholstery:

COM/COL	30
Grade A	10
Grade B	20
Grade C	30
Grade D	45
Grade E	55
Grade F	65
Grade G	85
Grade H	100
Grade J	110
Grade K	130
Grade L	165
Grade M	210
Leather I	285
Leather II	365
Leather III	445
Leather IV	525
Leather V	605
Leather VI	685

Upholstery Requires (Per Application):

Fabric: 1 Yard
Leather: 18 Sq. Ft.

Base Price: 2860

Total Required

Upholstery: Fabric: 2¾ Yards
Leather: 49½ Sq. Ft.

PLEASE SPECIFY THE FOLLOWING TO ORDER:

<p>MODEL NUMBER</p>	<p>TEXTILES</p> <p>Indicate fabric choice for:</p> <p>Back upholstery</p> <p><i>See options for fabrics at www.hbftextiles.com</i></p>	<p>TEXTILES</p> <p>Indicate fabric choice for:</p> <p>Arm upholstery</p> <p><i>See options for fabrics at www.hbftextiles.com</i></p>	<p>TEXTILES</p> <p>Indicate fabric choice for:</p> <p>Seat upholstery</p> <p><i>See options for fabrics at www.hbftextiles.com</i></p>	<p>FLAMMABILITY</p> <p>Indicate flammability:</p> <p>U = Cal 117</p>	<p>CASTER</p> <p>DWCM = Double Wheel - Medium Casters</p> <p>DWCS = Double Wheel - Soft Casters +\$106</p>
---------------------	--	---	--	---	--

HST222-521.BackFabric.ArmFabric.SeatFabric.Flammability.Caster Example: HST222-521.950-88.950-88.950-88.U.DWCM



Dimensions

Cadre HST222-531



OH	35½-39½	AH	26½-30½
OW	24	WBA	19
OD	26	DED	
SH	18½-22½	DEW	
SD	19	R	

Shipping Weight 66
Cube 20.4

Mid Back | Upholstered Back and Seat | Full Polished Aluminum Wrap Around Arm with Upholstered Arm Cap |

ANSI/BIFMA LEVEL® Furniture Sustainability Standard certified
Indoor Advantage™ certified

Knee Tilt | Five-Prong Polished Aluminum Base | Double Wheel Casters

Pricing for Single Fabric Placement:

Upholstery:

COM/COL	2655
Grade A	2600
Grade B	2630
Grade C	2655
Grade D	2685
Grade E	2710
Grade F	2745
Grade G	2785
Grade H	2825
Grade J	2850
Grade K	2905
Grade L	2990
Grade M	3100
Leather I	3290
Leather II	3490
Leather III	3690
Leather IV	3890
Leather V	4090
Leather VI	4290

Upholstery Requires:

Fabric: 2½ Yards
Leather: 45 Sq. Ft.

Pricing for Multiple Fabric Placement:

(To Calculate, Begin with Base Price and add Upcharges)

Back Upholstery:

COM/COL	30
Grade A	10
Grade B	20
Grade C	30
Grade D	45
Grade E	55
Grade F	65
Grade G	85
Grade H	100
Grade J	110
Grade K	130
Grade L	165
Grade M	210
Leather I	285
Leather II	365
Leather III	445
Leather IV	525
Leather V	605
Leather VI	685

Upholstery Requires (Per Application):

Fabric: 1 Yard
Leather: 18 Sq. Ft.

Arm Upholstery:

COM/COL	20
Grade A	5
Grade B	15
Grade C	20
Grade D	25
Grade E	30
Grade F	35
Grade G	45
Grade H	50
Grade J	55
Grade K	70
Grade L	85
Grade M	105
Leather I	145
Leather II	185
Leather III	225
Leather IV	265
Leather V	305
Leather VI	345

Upholstery Requires (Per Application):

Fabric: ½ Yard
Leather: 9 Sq. Ft.

Seat Upholstery:

COM/COL	30
Grade A	10
Grade B	20
Grade C	30
Grade D	45
Grade E	55
Grade F	65
Grade G	85
Grade H	100
Grade J	110
Grade K	130
Grade L	165
Grade M	210
Leather I	285
Leather II	365
Leather III	445
Leather IV	525
Leather V	605
Leather VI	685

Upholstery Requires (Per Application):

Fabric: 1 Yard
Leather: 18 Sq. Ft.

Base Price: 2575

Total Required

Upholstery: Fabric: 2½ Yards
Leather: 45 Sq. Ft.

PLEASE SPECIFY THE FOLLOWING TO ORDER:

<p>MODEL NUMBER</p>	<p>TEXTILES</p> <p>Indicate fabric choice for:</p> <p>Back upholstery</p> <p><i>See options for fabrics at www.hbftextiles.com</i></p>	<p>TEXTILES</p> <p>Indicate fabric choice for:</p> <p>Arm upholstery</p> <p><i>See options for fabrics at www.hbftextiles.com</i></p>	<p>TEXTILES</p> <p>Indicate fabric choice for:</p> <p>Seat upholstery</p> <p><i>See options for fabrics at www.hbftextiles.com</i></p>	<p>FLAMMABILITY</p> <p>Indicate flammability:</p> <p><input type="checkbox"/> U = Cal 117</p>	<p>CASTER</p> <p><input type="checkbox"/> DWCM = Double Wheel - Medium Casters</p> <p><input type="checkbox"/> DWCS = Double Wheel - Soft Casters +\$106</p>
---------------------	--	---	--	---	--

HST222-531.BackFabric.ArmFabric.SeatFabric.Flammability.Caster Example: HST222-531.950-88.950-88.950-88.U.DWCM



Dimensions

Cadre HST222-541



OH	41½-44½	AH	26½-30½
OW	24	WBA	19
OD	26	DED	
SH	18½-22½	DEW	
SD	19	R	

Shipping Weight 66
Cube 22.5

High Back | Upholstered Back and Seat | Full Polished Aluminum Wrap Around Arm with Upholstered Arm Cap |

ANSI/BIFMA LEVEL® Furniture Sustainability Standard certified
Indoor Advantage™ certified

Knee Tilt | Five-Prong Polished Aluminum Base | Double Wheel Casters

Pricing for Single Fabric Placement:

Upholstery:

COM/COL	3005
Grade A	2940
Grade B	2975
Grade C	3005
Grade D	3035
Grade E	3065
Grade F	3100
Grade G	3145
Grade H	3185
Grade J	3215
Grade K	3280
Grade L	3370
Grade M	3490
Leather I	3700
Leather II	3920
Leather III	4140
Leather IV	4360
Leather V	4580
Leather VI	4800

Upholstery Requires:

Fabric: 2¾ Yards
Leather: 49½ Sq. Ft.

Pricing for Multiple Fabric Placement:

(To Calculate, Begin with Base Price and add Upcharges)

Back Upholstery:

COM/COL	45
Grade A	15
Grade B	30
Grade C	45
Grade D	55
Grade E	70
Grade F	90
Grade G	105
Grade H	125
Grade J	140
Grade K	170
Grade L	210
Grade M	265
Leather I	360
Leather II	460
Leather III	560
Leather IV	660
Leather V	760
Leather VI	860

Upholstery Requires (Per Application):

Fabric: 1¼ Yards
Leather: 22½ Sq. Ft.

Arm Upholstery:

COM/COL	20
Grade A	5
Grade B	15
Grade C	20
Grade D	25
Grade E	30
Grade F	35
Grade G	45
Grade H	50
Grade J	55
Grade K	70
Grade L	85
Grade M	105
Leather I	145
Leather II	185
Leather III	225
Leather IV	265
Leather V	305
Leather VI	345

Upholstery Requires (Per Application):

Fabric: ½ Yard
Leather: 9 Sq. Ft.

Seat Upholstery:

COM/COL	30
Grade A	10
Grade B	20
Grade C	30
Grade D	45
Grade E	55
Grade F	65
Grade G	85
Grade H	100
Grade J	110
Grade K	130
Grade L	165
Grade M	210
Leather I	285
Leather II	365
Leather III	445
Leather IV	525
Leather V	605
Leather VI	685

Upholstery Requires (Per Application):

Fabric: 1 Yard
Leather: 18 Sq. Ft.

Base Price: 2910

Total Required

Upholstery: Fabric: 2¾ Yards
Leather: 49½ Sq. Ft.

PLEASE SPECIFY THE FOLLOWING TO ORDER:

<p>MODEL NUMBER</p>	<p>TEXTILES</p> <p>Indicate fabric choice for:</p> <p>Back upholstery</p> <p><i>See options for fabrics at www.bbftextiles.com</i></p>	<p>TEXTILES</p> <p>Indicate fabric choice for:</p> <p>Arm upholstery</p> <p><i>See options for fabrics at www.bbftextiles.com</i></p>	<p>TEXTILES</p> <p>Indicate fabric choice for:</p> <p>Seat upholstery</p> <p><i>See options for fabrics at www.bbftextiles.com</i></p>	<p>FLAMMABILITY</p> <p>Indicate flammability:</p> <p>U = Cal 117</p>	<p>CASTER</p> <p>DWCM = Double Wheel - Medium Casters</p> <p>DWCS = Double Wheel - Soft Casters +\$106</p>
---------------------	--	---	--	---	--

HST222-541.BackFabric.ArmFabric.SeatFabric.Flammability.Caster Example: HST222-541.950-88.950-88.950-88.U.DWCM



Dimensions

Cadre HST222-551



OH	35½-39½	AH	26½-30½
OW	24	WBA	19
OD	26	DED	
SH	18½-22½	DEW	
SD	19	R	

Shipping Weight 66
Cube 20.4

Mid Back | Channel Stitched Upholstered Back and Seat | Polished Aluminum Arm with Upholstered Arm Cap |

ANSI/BIFMA LEVEL® Furniture Sustainability Standard certified
Indoor Advantage™ certified

Synchronized Adjustments | Five-Prong Polished Aluminum Base | Double Wheel Casters

Pricing for Single Fabric Placement:

Upholstery:

COM/COL	3125
Grade A	3030
Grade B	3075
Grade C	3125
Grade D	3170
Grade E	3220
Grade F	3275
Grade G	3340
Grade H	3405
Grade J	3455
Grade K	3550
Grade L	3690
Grade M	3880
Leather I	4200
Leather II	4540
Leather III	4880
Leather IV	5220
Leather V	5560
Leather VI	5900

Upholstery Requires:

Fabric: 4¼ Yards
Leather: 76½ Sq. Ft.

Pricing for Multiple Fabric Placement:

(To Calculate, Begin with Base Price and add Upcharges)

Back Upholstery:

COM/COL	75
Grade A	25
Grade B	50
Grade C	75
Grade D	100
Grade E	125
Grade F	155
Grade G	190
Grade H	225
Grade J	250
Grade K	300
Grade L	375
Grade M	475
Leather I	645
Leather II	825
Leather III	1005
Leather IV	1185
Leather V	1365
Leather VI	1545

Upholstery Requires (Per Application):

Fabric: 2¼ Yards
Leather: 40½ Sq. Ft.

Arm Upholstery:

COM/COL	20
Grade A	5
Grade B	15
Grade C	20
Grade D	25
Grade E	30
Grade F	35
Grade G	45
Grade H	50
Grade J	55
Grade K	70
Grade L	85
Grade M	105
Leather I	145
Leather II	185
Leather III	225
Leather IV	265
Leather V	305
Leather VI	345

Upholstery Requires (Per Application):

Fabric: ½ Yard
Leather: 9 Sq. Ft.

Seat Upholstery:

COM/COL	50
Grade A	15
Grade B	35
Grade C	50
Grade D	65
Grade E	85
Grade F	105
Grade G	125
Grade H	150
Grade J	165
Grade K	200
Grade L	250
Grade M	315
Leather I	430
Leather II	550
Leather III	670
Leather IV	790
Leather V	910
Leather VI	1030

Upholstery Requires (Per Application):

Fabric: 1½ Yards
Leather: 27 Sq. Ft.

Base Price: 2980

Total Required

Upholstery: Fabric: 4¼ Yards
Leather: 76½ Sq. Ft.

PLEASE SPECIFY THE FOLLOWING TO ORDER:

<p>MODEL NUMBER</p>	<p>TEXTILES</p> <p>Indicate fabric choice for:</p> <p>Back upholstery</p> <p><i>See options for fabrics at www.hbftextiles.com</i></p>	<p>TEXTILES</p> <p>Indicate fabric choice for:</p> <p>Arm upholstery</p> <p><i>See options for fabrics at www.hbftextiles.com</i></p>	<p>TEXTILES</p> <p>Indicate fabric choice for:</p> <p>Seat upholstery</p> <p><i>See options for fabrics at www.hbftextiles.com</i></p>	<p>FLAMMABILITY</p> <p>Indicate flammability:</p> <p>U = Cal 117</p>	<p>CASTER</p> <p>DWCM = Double Wheel - Medium Casters</p> <p>DWCS = Double Wheel - Soft Casters +\$106</p>
---------------------	--	---	--	---	--

HST222-551.BackFabric.ArmFabric.SeatFabric.Flammability.Caster Example: HST222-551.950-88.950-88.950-88.U.DWCM



Dimensions

Cadre HST222-561



OH	41½-44½	AH	26½-30½
OW	24	WBA	19
OD	26	DED	
SH	18½-22½	DEW	
SD	19	R	
Shipping Weight		66	
Cube		22.5	

High Back | Channel Stitched Upholstered Back and Seat | Polished Aluminum Arm with Upholstered Arm Cap |

ANSI/BIFMA LEVEL® Furniture Sustainability Standard certified
Indoor Advantage™ certified

Synchronized Adjustments | Five-Prong Polished Aluminum Base | Double Wheel Casters

Pricing for Single Fabric Placement:

Upholstery:

COM/COL	3415
Grade A	3330
Grade B	3375
Grade C	3415
Grade D	3455
Grade E	3500
Grade F	3550
Grade G	3605
Grade H	3665
Grade J	3705
Grade K	3790
Grade L	3915
Grade M	4080
Leather I	4365
Leather II	4665
Leather III	4965
Leather IV	5265
Leather V	5565
Leather VI	5865

Upholstery Requires:

Fabric: 3¾ Yards
Leather: 67½ Sq. Ft.

Pricing for Multiple Fabric Placement:

(To Calculate, Begin with Base Price and add Upcharges)

Back Upholstery:

COM/COL	55
Grade A	20
Grade B	35
Grade C	55
Grade D	75
Grade E	95
Grade F	120
Grade G	145
Grade H	175
Grade J	195
Grade K	230
Grade L	290
Grade M	370
Leather I	500
Leather II	640
Leather III	780
Leather IV	920
Leather V	1060
Leather VI	1200

Upholstery Requires (Per Application):

Fabric: 1¾ Yards
Leather: 31½ Sq. Ft.

Arm Upholstery:

COM/COL	20
Grade A	5
Grade B	15
Grade C	20
Grade D	25
Grade E	30
Grade F	35
Grade G	45
Grade H	50
Grade J	55
Grade K	70
Grade L	85
Grade M	105
Leather I	145
Leather II	185
Leather III	225
Leather IV	265
Leather V	305
Leather VI	345

Upholstery Requires (Per Application):

Fabric: ½ Yard
Leather: 9 Sq. Ft.

Seat Upholstery:

COM/COL	50
Grade A	15
Grade B	35
Grade C	50
Grade D	65
Grade E	85
Grade F	105
Grade G	125
Grade H	150
Grade J	165
Grade K	200
Grade L	250
Grade M	315
Leather I	430
Leather II	550
Leather III	670
Leather IV	790
Leather V	910
Leather VI	1030

Upholstery Requires (Per Application):

Fabric: 1½ Yards
Leather: 27 Sq. Ft.

Base Price: 3290

Total Required

Upholstery: Fabric: 3¾ Yards
Leather: 67½ Sq. Ft.

PLEASE SPECIFY THE FOLLOWING TO ORDER:

<p>MODEL NUMBER</p>	<p>TEXTILES</p> <p>Indicate fabric choice for:</p> <p>Back upholstery</p> <p><i>See options for fabrics at www.hbftextiles.com</i></p>	<p>TEXTILES</p> <p>Indicate fabric choice for:</p> <p>Arm upholstery</p> <p><i>See options for fabrics at www.hbftextiles.com</i></p>	<p>TEXTILES</p> <p>Indicate fabric choice for:</p> <p>Seat upholstery</p> <p><i>See options for fabrics at www.hbftextiles.com</i></p>	<p>FLAMMABILITY</p> <p>Indicate flammability:</p> <p>U = Cal 117</p>	<p>CASTER</p> <p>DWCM = Double Wheel - Medium Casters</p> <p>DWCS = Double Wheel - Soft Casters +\$106</p>
----------------------------	--	---	--	--	---

HST222-561.BackFabric.ArmFabric.SeatFabric.Flammability.Caster Example: HST222-561.950-88.950-88.950-88.U.DWCM



Dimensions

Cadre HST222-571



OH	35½-39½	AH	26½-30½
OW	24	WBA	19
OD	26	DED	
SH	18½-22½	DEW	
SD	19	R	

Shipping Weight 66
Cube 20.4

Mid Back | Channel Stitched Upholstered Back and Seat | Full Polished Aluminum Wrap Around Arm with Upholstered Arm Cap |

Knee Tilt | Five-Prong Polished Aluminum Base | Double Wheel Casters

ANSI/BIFMA LEVEL® Furniture Sustainability Standard certified
Indoor Advantage™ certified

Pricing for Single Fabric Placement:

Upholstery:

COM/COL	3175
Grade A	3080
Grade B	3125
Grade C	3175
Grade D	3220
Grade E	3270
Grade F	3325
Grade G	3390
Grade H	3455
Grade J	3505
Grade K	3600
Grade L	3740
Grade M	3930
Leather I	4250
Leather II	4590
Leather III	4930
Leather IV	5270
Leather V	5610
Leather VI	5950

Upholstery Requires:

Fabric: 4¼ Yards
Leather: 76½ Sq. Ft.

Pricing for Multiple Fabric Placement:

(To Calculate, Begin with Base Price and add Upcharges)

Back Upholstery:

COM/COL	75
Grade A	25
Grade B	50
Grade C	75
Grade D	100
Grade E	125
Grade F	155
Grade G	190
Grade H	225
Grade J	250
Grade K	300
Grade L	375
Grade M	475
Leather I	645
Leather II	825
Leather III	1005
Leather IV	1185
Leather V	1365
Leather VI	1545

Upholstery Requires (Per Application):

Fabric: 2¼ Yards
Leather: 40½ Sq. Ft.

Arm Upholstery:

COM/COL	20
Grade A	5
Grade B	15
Grade C	20
Grade D	25
Grade E	30
Grade F	35
Grade G	45
Grade H	50
Grade J	55
Grade K	70
Grade L	85
Grade M	105
Leather I	145
Leather II	185
Leather III	225
Leather IV	265
Leather V	305
Leather VI	345

Upholstery Requires (Per Application):

Fabric: ½ Yard
Leather: 9 Sq. Ft.

Seat Upholstery:

COM/COL	50
Grade A	15
Grade B	35
Grade C	50
Grade D	65
Grade E	85
Grade F	105
Grade G	125
Grade H	150
Grade J	165
Grade K	200
Grade L	250
Grade M	315
Leather I	430
Leather II	550
Leather III	670
Leather IV	790
Leather V	910
Leather VI	1030

Upholstery Requires (Per Application):

Fabric: 1½ Yards
Leather: 27 Sq. Ft.

Base Price: 3030

Total Required

Upholstery: Fabric: 4¼ Yards
Leather: 76½ Sq. Ft.

PLEASE SPECIFY THE FOLLOWING TO ORDER:

<p>MODEL NUMBER</p>	<p>TEXTILES</p> <p>Indicate fabric choice for:</p> <p>Back upholstery</p> <p><i>See options for fabrics at www.hbftextiles.com</i></p>	<p>TEXTILES</p> <p>Indicate fabric choice for:</p> <p>Arm upholstery</p> <p><i>See options for fabrics at www.hbftextiles.com</i></p>	<p>TEXTILES</p> <p>Indicate fabric choice for:</p> <p>Seat upholstery</p> <p><i>See options for fabrics at www.hbftextiles.com</i></p>	<p>FLAMMABILITY</p> <p>Indicate flammability:</p> <p>U = Cal 117</p>	<p>CASTER</p> <p>DWCM = Double Wheel - Medium Casters</p> <p>DWCS = Double Wheel - Soft Casters +\$106</p>
----------------------------	--	---	--	--	---

HST222-571.BackFabric.ArmFabric.SeatFabric.Flammability.Caster

Example: HST222-571.950-88.950-88.950-88.U.DWCM



Dimensions

Cadre HST222-581



OH	41½-44½	AH	26½-30½
OW	24	WBA	19
OD	26	DED	
SH	18½-22½	DEW	
SD	19	R	

Shipping Weight 66
Cube 22.5

High Back | Channel Stitched Upholstered Back and Seat | Full Polished Aluminum Wrap Around Arm with Upholstered Arm Cap |
Knee Tilt | Five-Prong Polished Aluminum Base | Double Wheel Casters

ANSI/BIFMA LEVEL® Furniture Sustainability Standard certified
Indoor Advantage™ certified

Pricing for Single Fabric Placement:

Upholstery:

COM/COL	3470
Grade A	3385
Grade B	3430
Grade C	3470
Grade D	3510
Grade E	3555
Grade F	3605
Grade G	3660
Grade H	3720
Grade J	3760
Grade K	3845
Grade L	3970
Grade M	4135
Leather I	4420
Leather II	4720
Leather III	5020
Leather IV	5320
Leather V	5620
Leather VI	5920

Upholstery Requires:

Fabric: 3¾ Yards
Leather: 67½ Sq. Ft.

Pricing for Multiple Fabric Placement:

(To Calculate, Begin with Base Price and add Upcharges)

Back Upholstery:

COM/COL	55
Grade A	20
Grade B	35
Grade C	55
Grade D	75
Grade E	95
Grade F	120
Grade G	145
Grade H	175
Grade J	195
Grade K	230
Grade L	290
Grade M	370
Leather I	500
Leather II	640
Leather III	780
Leather IV	920
Leather V	1060
Leather VI	1200

Upholstery Requires (Per Application):

Fabric: 1¾ Yards
Leather: 31½ Sq. Ft.

Arm Upholstery:

COM/COL	20
Grade A	5
Grade B	15
Grade C	20
Grade D	25
Grade E	30
Grade F	35
Grade G	45
Grade H	50
Grade J	55
Grade K	70
Grade L	85
Grade M	105
Leather I	145
Leather II	185
Leather III	225
Leather IV	265
Leather V	305
Leather VI	345

Upholstery Requires (Per Application):

Fabric: ½ Yard
Leather: 9 Sq. Ft.

Seat Upholstery:

COM/COL	50
Grade A	15
Grade B	35
Grade C	50
Grade D	65
Grade E	85
Grade F	105
Grade G	125
Grade H	150
Grade J	165
Grade K	200
Grade L	250
Grade M	315
Leather I	430
Leather II	550
Leather III	670
Leather IV	790
Leather V	910
Leather VI	1030

Upholstery Requires (Per Application):

Fabric: 1½ Yards
Leather: 27 Sq. Ft.

Base Price: 3345

Total Required

Upholstery: Fabric: 3¾ Yards
Leather: 67½ Sq. Ft.

PLEASE SPECIFY THE FOLLOWING TO ORDER:

<p>MODEL NUMBER</p>	<p>TEXTILES</p> <p>Indicate fabric choice for:</p> <p>Back upholstery</p> <p><i>See options for fabrics at www.hbftextiles.com</i></p>	<p>TEXTILES</p> <p>Indicate fabric choice for:</p> <p>Arm upholstery</p> <p><i>See options for fabrics at www.hbftextiles.com</i></p>	<p>TEXTILES</p> <p>Indicate fabric choice for:</p> <p>Seat upholstery</p> <p><i>See options for fabrics at www.hbftextiles.com</i></p>	<p>FLAMMABILITY</p> <p>Indicate flammability:</p> <p>U = Cal 117</p>	<p>CASTER</p> <p>DWCM = Double Wheel - Medium Casters</p> <p>DWCS = Double Wheel - Soft Casters +\$106</p>
---------------------	--	---	--	---	--

HST222-581.BackFabric.ArmFabric.SeatFabric.Flammability.Caster Example: HST222-581.950-88.950-88.950-88.U.DWCM



Dimensions

Cadre HST222-111



OH	35½-39½	AH	26½-30½
OW	24	WBA	19
OD	26	DED	
SH	18½-22½	DEW	
SD	19	R	

Shipping Weight	66
Cube	20.4

Mid Back | Upholstered Back and Seat | Black Arm with Urethane Arm Cap | Five-Prong Black Metal Base |

Synchronized Adjustments | Double Wheel Casters

ANSI/BIFMA LEVEL® Furniture Sustainability Standard certified
Indoor Advantage™ certified

Pricing for Single Fabric Placement:

Upholstery:

COM/COL	2485
Grade A	2445
Grade B	2465
Grade C	2485
Grade D	2515
Grade E	2535
Grade F	2555
Grade G	2595
Grade H	2625
Grade J	2645
Grade K	2685
Grade L	2755
Grade M	2845
Leather I	2995
Leather II	3155
Leather III	3315
Leather IV	3475
Leather V	3635
Leather VI	3795

Upholstery Requires:

Fabric:	2	Yards
Leather:	36	Sq. Ft.

Pricing for Multiple Fabric Placement:

(To Calculate, Begin with Base Price and add Upcharges)

Back Upholstery:

COM/COL	30
Grade A	10
Grade B	20
Grade C	30
Grade D	45
Grade E	55
Grade F	65
Grade G	85
Grade H	100
Grade J	110
Grade K	130
Grade L	165
Grade M	210
Leather I	285
Leather II	365
Leather III	445
Leather IV	525
Leather V	605
Leather VI	685

Upholstery Requires (Per Application):

Fabric:	1	Yard
Leather:	18	Sq. Ft.

Seat Upholstery:

COM/COL	30
Grade A	10
Grade B	20
Grade C	30
Grade D	45
Grade E	55
Grade F	65
Grade G	85
Grade H	100
Grade J	110
Grade K	130
Grade L	165
Grade M	210
Leather I	285
Leather II	365
Leather III	445
Leather IV	525
Leather V	605
Leather VI	685

Upholstery Requires (Per Application):

Fabric:	1	Yard
Leather:	18	Sq. Ft.

Base Price: 2425

Total Required

Upholstery: Fabric: 2 Yards
Leather: 36 Sq. Ft.

PLEASE SPECIFY THE FOLLOWING TO ORDER:

<p>MODEL NUMBER</p>	<p>TEXTILES</p> <p>Indicate fabric choice for:</p> <p>Back upholstery</p> <p><i>See options for fabrics at www.bbftextiles.com</i></p>	<p>TEXTILES</p> <p>Indicate fabric choice for:</p> <p>Seat upholstery</p> <p><i>See options for fabrics at www.bbftextiles.com</i></p>	<p>FLAMMABILITY</p> <p>Indicate flammability:</p> <p>U = Cal 117</p>	<p>CASTER</p> <p>DWCM = Double Wheel - Medium Casters</p> <p>DWCS = Double Wheel - Soft Casters +\$106</p>
----------------------------	--	--	--	---

HST222-111.BackFabric.SeatFabric.Flammability.Caster Example: HST222-111.950-88.950-88.U.DWCM



Dimensions

Cadre HST222-121



OH	41½-44½	AH	26½-30½
OW	24	WBA	19
OD	26	DED	
SH	18½-22½	DEW	
SD	19	R	

Shipping Weight	66
Cube	22.5

High Back | Upholstered Back and Seat | Black Arm with Urethane Arm Cap | Five-Prong Black Metal Base |

Synchronized Adjustments | Double Wheel Casters

ANSI/BIFMA LEVEL® Furniture Sustainability Standard certified
Indoor Advantage™ certified

Pricing for Single Fabric Placement:

Upholstery:

COM/COL	2830
Grade A	2780
Grade B	2805
Grade C	2830
Grade D	2855
Grade E	2880
Grade F	2910
Grade G	2945
Grade H	2980
Grade J	3005
Grade K	3055
Grade L	3130
Grade M	3230
Leather I	3400
Leather II	3580
Leather III	3760
Leather IV	3940
Leather V	4120
Leather VI	4300

Upholstery Requires:

Fabric: 2¼ Yards
Leather: 40½ Sq. Ft.

Pricing for Multiple Fabric Placement:

(To Calculate, Begin with Base Price and add Upcharges)

Back Upholstery:

COM/COL	45
Grade A	15
Grade B	30
Grade C	45
Grade D	55
Grade E	70
Grade F	90
Grade G	105
Grade H	125
Grade J	140
Grade K	170
Grade L	210
Grade M	265
Leather I	360
Leather II	460
Leather III	560
Leather IV	660
Leather V	760
Leather VI	860

Upholstery Requires (Per Application):

Fabric: 1¼ Yards
Leather: 22½ Sq. Ft.

Seat Upholstery:

COM/COL	30
Grade A	10
Grade B	20
Grade C	30
Grade D	45
Grade E	55
Grade F	65
Grade G	85
Grade H	100
Grade J	110
Grade K	130
Grade L	165
Grade M	210
Leather I	285
Leather II	365
Leather III	445
Leather IV	525
Leather V	605
Leather VI	685

Upholstery Requires (Per Application):

Fabric: 1 Yard
Leather: 18 Sq. Ft.

Base Price: 2755

Total Required

Upholstery: Fabric: 2¼ Yards
Leather: 40½ Sq. Ft.

PLEASE SPECIFY THE FOLLOWING TO ORDER:

<p>MODEL NUMBER</p>	<p>TEXTILES</p> <p>Indicate fabric choice for:</p> <p>Back upholstery</p> <p><i>See options for fabrics at www.bbftextiles.com</i></p>	<p>TEXTILES</p> <p>Indicate fabric choice for:</p> <p>Seat upholstery</p> <p><i>See options for fabrics at www.bbftextiles.com</i></p>	<p>FLAMMABILITY</p> <p>Indicate flammability:</p> <p>U = Cal 117</p>	<p>CASTER</p> <p>DWCM = Double Wheel - Medium Casters</p> <p>DWCS = Double Wheel - Soft Casters +\$106</p>
----------------------------	--	--	--	---

HST222-121.BackFabric.SeatFabric.Flammability.Caster Example: HST222-121.950-88.950-88.U.DWCM



Dimensions

Cadre HST222-131



OH	35½-39½	AH	26½-30½
OW	24	WBA	19
OD	26	DED	
SH	18½-22½	DEW	
SD	19	R	

Shipping Weight	66
Cube	20.4

Mid Back | Upholstered Back and Seat | Full Black Wrap Around Arm with Urethane Arm Cap |

Five-Prong Black Metal Base | Knee Tilt Adjustments | Double Wheel Casters

ANSI/BIFMA LEVEL® Furniture Sustainability Standard certified
Indoor Advantage™ certified

Pricing for Single Fabric Placement:

Upholstery:

COM/COL	2500
Grade A	2460
Grade B	2480
Grade C	2500
Grade D	2530
Grade E	2550
Grade F	2570
Grade G	2610
Grade H	2640
Grade J	2660
Grade K	2700
Grade L	2770
Grade M	2860
Leather I	3010
Leather II	3170
Leather III	3330
Leather IV	3490
Leather V	3650
Leather VI	3810

Upholstery Requires:

Fabric: 2 Yards
Leather: 36 Sq. Ft.

Pricing for Multiple Fabric Placement:

(To Calculate, Begin with Base Price and add Upcharges)

Back Upholstery:

COM/COL	30
Grade A	10
Grade B	20
Grade C	30
Grade D	45
Grade E	55
Grade F	65
Grade G	85
Grade H	100
Grade J	110
Grade K	130
Grade L	165
Grade M	210
Leather I	285
Leather II	365
Leather III	445
Leather IV	525
Leather V	605
Leather VI	685

Upholstery Requires (Per Application):

Fabric: 1 Yard
Leather: 18 Sq. Ft.

Seat Upholstery:

COM/COL	30
Grade A	10
Grade B	20
Grade C	30
Grade D	45
Grade E	55
Grade F	65
Grade G	85
Grade H	100
Grade J	110
Grade K	130
Grade L	165
Grade M	210
Leather I	285
Leather II	365
Leather III	445
Leather IV	525
Leather V	605
Leather VI	685

Upholstery Requires (Per Application):

Fabric: 1 Yard
Leather: 18 Sq. Ft.

Base Price: 2440

Total Required

Upholstery: Fabric: 2 Yards
Leather: 36 Sq. Ft.

PLEASE SPECIFY THE FOLLOWING TO ORDER:

<p>MODEL NUMBER</p>	<p>TEXTILES</p> <p>Indicate fabric choice for:</p> <p>Back upholstery</p> <p><i>See options for fabrics at www.bbf textiles.com</i></p>	<p>TEXTILES</p> <p>Indicate fabric choice for:</p> <p>Seat upholstery</p> <p><i>See options for fabrics at www.bbf textiles.com</i></p>	<p>FLAMMABILITY</p> <p>Indicate flammability:</p> <p>U = Cal 117</p>	<p>CASTER</p> <p>DWCM = Double Wheel - Medium Casters</p> <p>DWCS = Double Wheel - Soft Casters +\$106</p>
----------------------------	--	--	--	---

HST222-131.BackFabric.SeatFabric.Flammability.Caster Example: HST222-131.950-88.950-88.U.DWCM



Dimensions

Cadre HST222-141



OH	41½-44½	AH	26½-30½
OW	24	WBA	19
OD	26	DED	
SH	18½-22½	DEW	
SD	19	R	

Shipping Weight 66
Cube 22.5

High Back | Upholstered Back and Seat | Full Black Wrap Around Arm with Urethane Arm Cap |

Five-Prong Black Metal Base | Knee Tilt Adjustments | Double Wheel Casters

ANSI/BIFMA LEVEL® Furniture Sustainability Standard certified
Indoor Advantage™ certified

Pricing for Single Fabric Placement:

Upholstery:

COM/COL	2850
Grade A	2800
Grade B	2825
Grade C	2850
Grade D	2875
Grade E	2900
Grade F	2930
Grade G	2965
Grade H	3000
Grade J	3025
Grade K	3075
Grade L	3150
Grade M	3250
Leather I	3420
Leather II	3600
Leather III	3780
Leather IV	3960
Leather V	4140
Leather VI	4320

Upholstery Requires:

Fabric: 2¼ Yards
Leather: 40½ Sq. Ft.

Pricing for Multiple Fabric Placement:

(To Calculate, Begin with Base Price and add Upcharges)

Back Upholstery:

COM/COL	45
Grade A	15
Grade B	30
Grade C	45
Grade D	55
Grade E	70
Grade F	90
Grade G	105
Grade H	125
Grade J	140
Grade K	170
Grade L	210
Grade M	265
Leather I	360
Leather II	460
Leather III	560
Leather IV	660
Leather V	760
Leather VI	860

Upholstery Requires (Per Application):

Fabric: 1¼ Yards
Leather: 22½ Sq. Ft.

Seat Upholstery:

COM/COL	30
Grade A	10
Grade B	20
Grade C	30
Grade D	45
Grade E	55
Grade F	65
Grade G	85
Grade H	100
Grade J	110
Grade K	130
Grade L	165
Grade M	210
Leather I	285
Leather II	365
Leather III	445
Leather IV	525
Leather V	605
Leather VI	685

Upholstery Requires (Per Application):

Fabric: 1 Yard
Leather: 18 Sq. Ft.

Base Price: 2775

Total Required

Upholstery: Fabric: 2¼ Yards
Leather: 40½ Sq. Ft.

PLEASE SPECIFY THE FOLLOWING TO ORDER:

<p>MODEL NUMBER</p>	<p>TEXTILES</p> <p>Indicate fabric choice for:</p> <p>Back upholstery</p> <p><i>See options for fabrics at www.bbftextiles.com</i></p>	<p>TEXTILES</p> <p>Indicate fabric choice for:</p> <p>Seat upholstery</p> <p><i>See options for fabrics at www.bbftextiles.com</i></p>	<p>FLAMMABILITY</p> <p>Indicate flammability:</p> <p>U = Cal 117</p>	<p>CASTER</p> <p>DWCM = Double Wheel - Medium Casters</p> <p>DWCS = Double Wheel - Soft Casters +\$106</p>
----------------------------	--	--	--	---

HST222-141.BackFabric.SeatFabric.Flammability.Caster Example: HST222-141.950-88.950-88.U.DWCM



Dimensions

Cadre HST222-151



OH	35½-39½	AH	26½-30½
OW	24	WBA	19
OD	26	DED	
SH	18½-22½	DEW	
SD	19	R	

Shipping Weight 66
Cube 20.4

Mid Back | Channel Stitched Upholstered Back and Seat | Black Arm with Urethane Arm Cap | Five-Prong Black Metal Base |

Synchronized Adjustments | Double Wheel Casters

ANSI/BIFMA LEVEL® Furniture Sustainability Standard certified
Indoor Advantage™ certified

Pricing for Single Fabric Placement:

Upholstery:

COM/COL	2995
Grade A	2910
Grade B	2955
Grade C	2995
Grade D	3035
Grade E	3080
Grade F	3130
Grade G	3185
Grade H	3245
Grade J	3285
Grade K	3370
Grade L	3495
Grade M	3660
Leather I	3945
Leather II	4245
Leather III	4545
Leather IV	4845
Leather V	5145
Leather VI	5445

Upholstery Requires:

Fabric: 3¾ Yards
Leather: 67½ Sq. Ft.

Pricing for Multiple Fabric Placement:

(To Calculate, Begin with Base Price and add Upcharges)

Back Upholstery:

COM/COL	75
Grade A	25
Grade B	50
Grade C	75
Grade D	100
Grade E	125
Grade F	155
Grade G	190
Grade H	225
Grade J	250
Grade K	300
Grade L	375
Grade M	475
Leather I	645
Leather II	825
Leather III	1005
Leather IV	1185
Leather V	1365
Leather VI	1545

Upholstery Requires (Per Application):

Fabric: 2¼ Yards
Leather: 40½ Sq. Ft.

Seat Upholstery:

COM/COL	50
Grade A	15
Grade B	35
Grade C	50
Grade D	65
Grade E	85
Grade F	105
Grade G	125
Grade H	150
Grade J	165
Grade K	200
Grade L	250
Grade M	315
Leather I	430
Leather II	550
Leather III	670
Leather IV	790
Leather V	910
Leather VI	1030

Upholstery Requires (Per Application):

Fabric: 1½ Yards
Leather: 27 Sq. Ft.

Base Price: 2870

Total Required

Upholstery: Fabric: 3¾ Yards
Leather: 67½ Sq. Ft.

PLEASE SPECIFY THE FOLLOWING TO ORDER:

<p>MODEL NUMBER</p>	<p>TEXTILES</p> <p>Indicate fabric choice for:</p> <p>Back upholstery</p> <p><i>See options for fabrics at www.bbftextiles.com</i></p>	<p>TEXTILES</p> <p>Indicate fabric choice for:</p> <p>Seat upholstery</p> <p><i>See options for fabrics at www.bbftextiles.com</i></p>	<p>FLAMMABILITY</p> <p>Indicate flammability:</p> <p>U = Cal 117</p>	<p>CASTER</p> <p>DWCM = Double Wheel - Medium Casters</p> <p>DWCS = Double Wheel - Soft Casters +\$106</p>
----------------------------	--	--	--	---

HST222-151.BackFabric.SeatFabric.Flammability.Caster Example: HST222-151.950-88.950-88.U.DWCM



Dimensions

Cadre HST222-161



OH	41½-44½	AH	26½-30½
OW	24	WBA	19
OD	26	DED	
SH	18½-22½	DEW	
SD	19	R	

Shipping Weight 66
Cube 22.5

High Back | Channel Stitched Upholstered Back and Seat | Black Arm with Urethane Arm Cap | Five-Prong Black Metal Base |

Synchronized Adjustments | Double Wheel Casters

ANSI/BIFMA LEVEL® Furniture Sustainability Standard certified
Indoor Advantage™ certified

Pricing for Single Fabric Placement:

Upholstery:

COM/COL	3285
Grade A	3215
Grade B	3250
Grade C	3285
Grade D	3325
Grade E	3360
Grade F	3400
Grade G	3455
Grade H	3505
Grade J	3540
Grade K	3610
Grade L	3720
Grade M	3865
Leather I	4110
Leather II	4370
Leather III	4630
Leather IV	4890
Leather V	5150
Leather VI	5410

Upholstery Requires:

Fabric: 3¼ Yards
Leather: 58½ Sq. Ft.

Pricing for Multiple Fabric Placement:

(To Calculate, Begin with Base Price and add Upcharges)

Back Upholstery:

COM/COL	55
Grade A	20
Grade B	35
Grade C	55
Grade D	75
Grade E	95
Grade F	120
Grade G	145
Grade H	175
Grade J	195
Grade K	230
Grade L	290
Grade M	370
Leather I	500
Leather II	640
Leather III	780
Leather IV	920
Leather V	1060
Leather VI	1200

Upholstery Requires (Per Application):

Fabric: 1¾ Yards
Leather: 31½ Sq. Ft.

Seat Upholstery:

COM/COL	50
Grade A	15
Grade B	35
Grade C	50
Grade D	65
Grade E	85
Grade F	105
Grade G	125
Grade H	150
Grade J	165
Grade K	200
Grade L	250
Grade M	315
Leather I	430
Leather II	550
Leather III	670
Leather IV	790
Leather V	910
Leather VI	1030

Upholstery Requires (Per Application):

Fabric: 1½ Yards
Leather: 27 Sq. Ft.

Base Price: 3180

Total Required

Upholstery: Fabric: 3¼ Yards
Leather: 58½ Sq. Ft.

PLEASE SPECIFY THE FOLLOWING TO ORDER:

<p>MODEL NUMBER</p>	<p>TEXTILES</p> <p>Indicate fabric choice for:</p> <p>Back upholstery</p> <p><i>See options for fabrics at www.bbftextiles.com</i></p>	<p>TEXTILES</p> <p>Indicate fabric choice for:</p> <p>Seat upholstery</p> <p><i>See options for fabrics at www.bbftextiles.com</i></p>	<p>FLAMMABILITY</p> <p>Indicate flammability:</p> <p>U = Cal 117</p>	<p>CASTER</p> <p>DWCM = Double Wheel - Medium Casters</p> <p>DWCS = Double Wheel - Soft Casters +\$106</p>
----------------------------	--	--	--	---

HST222-161.BackFabric.SeatFabric.Flammability.Caster Example: HST222-161.950-88.950-88.U.DWCM



Dimensions

Cadre HST222-171



OH	35½-39½	AH	26½-30½
OW	24	WBA	19
OD	26	DED	
SH	18½-22½	DEW	
SD	19	R	

Shipping Weight 66
Cube 20.4

Mid Back | Channel Stitched Upholstered Back and Seat | Full Black Wrap Around Arm with Urethane Arm Cap |

Five-Prong Black Metal Base | Knee Tilt | Double Wheel Casters

ANSI/BIFMA LEVEL® Furniture Sustainability Standard certified
Indoor Advantage™ certified

Pricing for Single Fabric Placement:

Upholstery:

COM/COL	3015
Grade A	2930
Grade B	2975
Grade C	3015
Grade D	3055
Grade E	3100
Grade F	3150
Grade G	3205
Grade H	3265
Grade J	3305
Grade K	3390
Grade L	3515
Grade M	3680
Leather I	3965
Leather II	4265
Leather III	4565
Leather IV	4865
Leather V	5165
Leather VI	5465

Upholstery Requires:

Fabric: 3¾ Yards
Leather: 67½ Sq. Ft.

Pricing for Multiple Fabric Placement:

(To Calculate, Begin with Base Price and add Upcharges)

Back Upholstery:

COM/COL	75
Grade A	25
Grade B	50
Grade C	75
Grade D	100
Grade E	125
Grade F	155
Grade G	190
Grade H	225
Grade J	250
Grade K	300
Grade L	375
Grade M	475
Leather I	645
Leather II	825
Leather III	1005
Leather IV	1185
Leather V	1365
Leather VI	1545

Upholstery Requires (Per Application):

Fabric: 2¼ Yards
Leather: 40½ Sq. Ft.

Seat Upholstery:

COM/COL	50
Grade A	15
Grade B	35
Grade C	50
Grade D	65
Grade E	85
Grade F	105
Grade G	125
Grade H	150
Grade J	165
Grade K	200
Grade L	250
Grade M	315
Leather I	430
Leather II	550
Leather III	670
Leather IV	790
Leather V	910
Leather VI	1030

Upholstery Requires (Per Application):

Fabric: 1½ Yards
Leather: 27 Sq. Ft.

Base Price: 2890

Total Required

Upholstery: Fabric: 3¾ Yards
Leather: 67½ Sq. Ft.

PLEASE SPECIFY THE FOLLOWING TO ORDER:

<p>MODEL NUMBER</p>	<p>TEXTILES</p> <p>Indicate fabric choice for:</p> <p>Back upholstery</p> <p><i>See options for fabrics at www.bbftextiles.com</i></p>	<p>TEXTILES</p> <p>Indicate fabric choice for:</p> <p>Seat upholstery</p> <p><i>See options for fabrics at www.bbftextiles.com</i></p>	<p>FLAMMABILITY</p> <p>Indicate flammability:</p> <p>U = Cal 117</p>	<p>CASTER</p> <p>DWCM = Double Wheel - Medium Casters</p> <p>DWCS = Double Wheel - Soft Casters +\$106</p>
----------------------------	--	--	--	---

HST222-171.BackFabric.SeatFabric.Flammability.Caster Example: HST222-171.950-88.950-88.U.DWCM



Dimensions

Cadre HST222-181



OH	41½-44½	AH	26½-30½
OW	24	WBA	19
OD	26	DED	
SH	18½-22½	DEW	
SD	19	R	

Shipping Weight 66
Cube 22.5

High Back | Channel Stitched Upholstered Back and Seat | Full Black Wrap Around Arm with Urethane Arm Cap |

Five-Prong Black Metal Base | Knee Tilt | Double Wheel Casters

ANSI/BIFMA LEVEL® Furniture Sustainability Standard certified
Indoor Advantage™ certified

Pricing for Single Fabric Placement:

Upholstery:

COM/COL	3310
Grade A	3240
Grade B	3275
Grade C	3310
Grade D	3350
Grade E	3385
Grade F	3425
Grade G	3480
Grade H	3530
Grade J	3565
Grade K	3635
Grade L	3745
Grade M	3890
Leather I	4135
Leather II	4395
Leather III	4655
Leather IV	4915
Leather V	5175
Leather VI	5435

Upholstery Requires:

Fabric: 3¼ Yards
Leather: 58½ Sq. Ft.

Pricing for Multiple Fabric Placement:

(To Calculate, Begin with Base Price and add Upcharges)

Back Upholstery:

COM/COL	55
Grade A	20
Grade B	35
Grade C	55
Grade D	75
Grade E	95
Grade F	120
Grade G	145
Grade H	175
Grade J	195
Grade K	230
Grade L	290
Grade M	370
Leather I	500
Leather II	640
Leather III	780
Leather IV	920
Leather V	1060
Leather VI	1200

Upholstery Requires (Per Application):

Fabric: 1¾ Yards
Leather: 31½ Sq. Ft.

Seat Upholstery:

COM/COL	50
Grade A	15
Grade B	35
Grade C	50
Grade D	65
Grade E	85
Grade F	105
Grade G	125
Grade H	150
Grade J	165
Grade K	200
Grade L	250
Grade M	315
Leather I	430
Leather II	550
Leather III	670
Leather IV	790
Leather V	910
Leather VI	1030

Upholstery Requires (Per Application):

Fabric: 1½ Yards
Leather: 27 Sq. Ft.

Base Price: 3205

Total Required

Upholstery: Fabric: 3¼ Yards
Leather: 58½ Sq. Ft.

PLEASE SPECIFY THE FOLLOWING TO ORDER:

<p>MODEL NUMBER</p>	<p>TEXTILES</p> <p>Indicate fabric choice for:</p> <p>Back upholstery</p> <p><i>See options for fabrics at www.bbftextiles.com</i></p>	<p>TEXTILES</p> <p>Indicate fabric choice for:</p> <p>Seat upholstery</p> <p><i>See options for fabrics at www.bbftextiles.com</i></p>	<p>FLAMMABILITY</p> <p>Indicate flammability:</p> <p>U = Cal 117</p>	<p>CASTER</p> <p>DWCM = Double Wheel - Medium Casters</p> <p>DWCS = Double Wheel - Soft Casters +\$106</p>
----------------------------	--	--	--	---

HST222-181.BackFabric.SeatFabric.Flammability.Caster Example: HST222-181.950-88.950-88.U.DWCM



Dimensions

Cadre HST222-611



OH	35½-39½	AH	26½-30½
OW	24	WBA	19
OD	26	DED	
SH	18½-22½	DEW	
SD	19	R	

Shipping Weight	66
Cube	20.4

Mid Back | Upholstered Back and Seat | Polished Aluminum Arm with Urethane Arm Cap | Five-Prong Polished Aluminum Base |

Synchronized Adjustments | Double Wheel Casters

ANSI/BIFMA LEVEL® Furniture Sustainability Standard certified
Indoor Advantage™ certified

Pricing for Single Fabric Placement:

Upholstery:

COM/COL	2485
Grade A	2445
Grade B	2465
Grade C	2485
Grade D	2515
Grade E	2535
Grade F	2555
Grade G	2595
Grade H	2625
Grade J	2645
Grade K	2685
Grade L	2755
Grade M	2845
Leather I	2995
Leather II	3155
Leather III	3315
Leather IV	3475
Leather V	3635
Leather VI	3795

Upholstery Requires:

Fabric: 2	Yards
Leather: 36	Sq. Ft.

Pricing for Multiple Fabric Placement:

(To Calculate, Begin with Base Price and add Upcharges)

Back Upholstery:

COM/COL	30
Grade A	10
Grade B	20
Grade C	30
Grade D	45
Grade E	55
Grade F	65
Grade G	85
Grade H	100
Grade J	110
Grade K	130
Grade L	165
Grade M	210
Leather I	285
Leather II	365
Leather III	445
Leather IV	525
Leather V	605
Leather VI	685

Upholstery Requires (Per Application):

Fabric: 1	Yard
Leather: 18	Sq. Ft.

Seat Upholstery:

COM/COL	30
Grade A	10
Grade B	20
Grade C	30
Grade D	45
Grade E	55
Grade F	65
Grade G	85
Grade H	100
Grade J	110
Grade K	130
Grade L	165
Grade M	210
Leather I	285
Leather II	365
Leather III	445
Leather IV	525
Leather V	605
Leather VI	685

Upholstery Requires (Per Application):

Fabric: 1	Yard
Leather: 18	Sq. Ft.

Base Price: 2420

Total Required

Upholstery: Fabric: 2 Yards
Leather: 36 Sq. Ft.

PLEASE SPECIFY THE FOLLOWING TO ORDER:

<p>MODEL NUMBER</p>	<p>TEXTILES</p> <p>Indicate fabric choice for:</p> <p>Back upholstery</p> <p><i>See options for fabrics at www.bbftextiles.com</i></p>	<p>TEXTILES</p> <p>Indicate fabric choice for:</p> <p>Seat upholstery</p> <p><i>See options for fabrics at www.bbftextiles.com</i></p>	<p>FLAMMABILITY</p> <p>Indicate flammability:</p> <p>U = Cal 117</p>	<p>CASTER</p> <p>DWCM = Double Wheel - Medium Casters</p> <p>DWCS = Double Wheel - Soft Casters +\$106</p>
----------------------------	--	--	--	---

HST222-611.BackFabric.SeatFabric.Flammability.Caster Example: HST222-611.950-88.950-88.U.DWCM



Dimensions

Cadre HST222-621



OH	41½-44½	AH	26½-30½
OW	24	WBA	19
OD	26	DED	
SH	18½-22½	DEW	
SD	19	R	

Shipping Weight	66
Cube	22.5

High Back | Upholstered Back and Seat | Polished Aluminum Arm with Urethane Arm Cap | Five-Prong Polished Aluminum Base |

Synchronized Adjustments | Double Wheel Casters

ANSI/BIFMA LEVEL® Furniture Sustainability Standard certified
Indoor Advantage™ certified

Pricing for Single Fabric Placement:

Upholstery:

COM/COL	2830
Grade A	2780
Grade B	2805
Grade C	2830
Grade D	2855
Grade E	2880
Grade F	2910
Grade G	2945
Grade H	2980
Grade J	3005
Grade K	3055
Grade L	3130
Grade M	3230
Leather I	3400
Leather II	3580
Leather III	3760
Leather IV	3940
Leather V	4120
Leather VI	4300

Upholstery Requires:

Fabric: 2¼ Yards
Leather: 40½ Sq. Ft.

Pricing for Multiple Fabric Placement:

(To Calculate, Begin with Base Price and add Upcharges)

Back Upholstery:

COM/COL	45
Grade A	15
Grade B	30
Grade C	45
Grade D	55
Grade E	70
Grade F	90
Grade G	105
Grade H	125
Grade J	140
Grade K	170
Grade L	210
Grade M	265
Leather I	360
Leather II	460
Leather III	560
Leather IV	660
Leather V	760
Leather VI	860

Upholstery Requires (Per Application):

Fabric: 1¼ Yards
Leather: 22½ Sq. Ft.

Seat Upholstery:

COM/COL	30
Grade A	10
Grade B	20
Grade C	30
Grade D	45
Grade E	55
Grade F	65
Grade G	85
Grade H	100
Grade J	110
Grade K	130
Grade L	165
Grade M	210
Leather I	285
Leather II	365
Leather III	445
Leather IV	525
Leather V	605
Leather VI	685

Upholstery Requires (Per Application):

Fabric: 1 Yard
Leather: 18 Sq. Ft.

Base Price: 2755

Total Required

Upholstery: Fabric: 2¼ Yards
Leather: 40½ Sq. Ft.

PLEASE SPECIFY THE FOLLOWING TO ORDER:

<p>MODEL NUMBER</p>	<p>TEXTILES</p> <p>Indicate fabric choice for:</p> <p>Back upholstery</p> <p><i>See options for fabrics at www.bbftextiles.com</i></p>	<p>TEXTILES</p> <p>Indicate fabric choice for:</p> <p>Seat upholstery</p> <p><i>See options for fabrics at www.bbftextiles.com</i></p>	<p>FLAMMABILITY</p> <p>Indicate flammability:</p> <p>U = Cal 117</p>	<p>CASTER</p> <p>DWCM = Double Wheel - Medium Casters</p> <p>DWCS = Double Wheel - Soft Casters +\$106</p>
----------------------------	--	--	--	---

HST222-621.BackFabric.SeatFabric.Flammability.Caster Example: HST222-621.950-88.950-88.U.DWCM



Dimensions

Cadre HST222-631



OH	35½-39½	AH	26½-30½
OW	24	WBA	19
OD	26	DED	
SH	18½-22½	DEW	
SD	19	R	

Shipping Weight 66
Cube 20.4

Mid Back | Upholstered Back and Seat | Full Polished Aluminum Wrap Around Arm with Urethane Arm Cap |

ANSI/BIFMA LEVEL® Furniture Sustainability Standard certified
Indoor Advantage™ certified

Knee Tilt | Five-Prong Polished Aluminum Base | Double Wheel Casters

Pricing for Single Fabric Placement:

Upholstery:

COM/COL	2500
Grade A	2460
Grade B	2480
Grade C	2500
Grade D	2530
Grade E	2550
Grade F	2570
Grade G	2610
Grade H	2640
Grade J	2660
Grade K	2700
Grade L	2770
Grade M	2860
Leather I	3010
Leather II	3170
Leather III	3330
Leather IV	3490
Leather V	3650
Leather VI	3810

Upholstery Requires:

Fabric: 2 Yards
Leather: 36 Sq. Ft.

Pricing for Multiple Fabric Placement:

(To Calculate, Begin with Base Price and add Upcharges)

Back Upholstery:

COM/COL	30
Grade A	10
Grade B	20
Grade C	30
Grade D	45
Grade E	55
Grade F	65
Grade G	85
Grade H	100
Grade J	110
Grade K	130
Grade L	165
Grade M	210
Leather I	285
Leather II	365
Leather III	445
Leather IV	525
Leather V	605
Leather VI	685

Upholstery Requires (Per Application):

Fabric: 1 Yard
Leather: 18 Sq. Ft.

Seat Upholstery:

COM/COL	30
Grade A	10
Grade B	20
Grade C	30
Grade D	45
Grade E	55
Grade F	65
Grade G	85
Grade H	100
Grade J	110
Grade K	130
Grade L	165
Grade M	210
Leather I	285
Leather II	365
Leather III	445
Leather IV	525
Leather V	605
Leather VI	685

Upholstery Requires (Per Application):

Fabric: 1 Yard
Leather: 18 Sq. Ft.

Base Price: 2435

Total Required

Upholstery: Fabric: 2 Yards
Leather: 36 Sq. Ft.

PLEASE SPECIFY THE FOLLOWING TO ORDER:

<p>MODEL NUMBER</p>	<p>TEXTILES</p> <p>Indicate fabric choice for:</p> <p>Back upholstery</p> <p><i>See options for fabrics at www.bbftextiles.com</i></p>	<p>TEXTILES</p> <p>Indicate fabric choice for:</p> <p>Seat upholstery</p> <p><i>See options for fabrics at www.bbftextiles.com</i></p>	<p>FLAMMABILITY</p> <p>Indicate flammability:</p> <p>U = Cal 117</p>	<p>CASTER</p> <p>DWCM = Double Wheel - Medium Casters</p> <p>DWCS = Double Wheel - Soft Casters +\$106</p>
----------------------------	--	--	--	---

HST222-631.BackFabric.SeatFabric.Flammability.Caster Example: HST222-631.950-88.950-88.U.DWCM



Dimensions

Cadre HST222-641



OH	41½-44½	AH	26½-30½
OW	24	WBA	19
OD	26	DED	
SH	18½-22½	DEW	
SD	19	R	

Shipping Weight	66
Cube	22.5

High Back | Upholstered Back and Seat | Full Polished Aluminum Wrap Around Arm with Urethane Arm Cap |

ANSI/BIFMA LEVEL® Furniture Sustainability Standard certified
Indoor Advantage™ certified

Knee Tilt | Five-Prong Polished Aluminum Base | Double Wheel Casters

Pricing for Single Fabric Placement:

Upholstery:

COM/COL	2850
Grade A	2800
Grade B	2825
Grade C	2850
Grade D	2875
Grade E	2900
Grade F	2930
Grade G	2965
Grade H	3000
Grade J	3025
Grade K	3075
Grade L	3150
Grade M	3250
Leather I	3420
Leather II	3600
Leather III	3780
Leather IV	3960
Leather V	4140
Leather VI	4320

Upholstery Requires:

Fabric: 2¼ Yards
Leather: 40½ Sq. Ft.

Pricing for Multiple Fabric Placement:
(To Calculate, Begin with Base Price and add Upcharges)

Back Upholstery:

COM/COL	45
Grade A	15
Grade B	30
Grade C	45
Grade D	55
Grade E	70
Grade F	90
Grade G	105
Grade H	125
Grade J	140
Grade K	170
Grade L	210
Grade M	265
Leather I	360
Leather II	460
Leather III	560
Leather IV	660
Leather V	760
Leather VI	860

Upholstery Requires (Per Application):

Fabric: 1¼ Yards
Leather: 22½ Sq. Ft.

Seat Upholstery:

COM/COL	30
Grade A	10
Grade B	20
Grade C	30
Grade D	45
Grade E	55
Grade F	65
Grade G	85
Grade H	100
Grade J	110
Grade K	130
Grade L	165
Grade M	210
Leather I	285
Leather II	365
Leather III	445
Leather IV	525
Leather V	605
Leather VI	685

Upholstery Requires (Per Application):

Fabric: 1 Yard
Leather: 18 Sq. Ft.

Base Price: 2775

Total Required Upholstery: Fabric: 2¼ Yards
Leather: 40½ Sq. Ft.

PLEASE SPECIFY THE FOLLOWING TO ORDER:

<p>MODEL NUMBER</p>	<p>TEXTILES</p> <p>Indicate fabric choice for:</p> <p>Back upholstery</p> <p><i>See options for fabrics at www.bbftextiles.com</i></p>	<p>TEXTILES</p> <p>Indicate fabric choice for:</p> <p>Seat upholstery</p> <p><i>See options for fabrics at www.bbftextiles.com</i></p>	<p>FLAMMABILITY</p> <p>Indicate flammability:</p> <p>U = Cal 117</p>	<p>CASTER</p> <p>DWCM = Double Wheel - Medium Casters</p> <p>DWCS = Double Wheel - Soft Casters +\$106</p>
----------------------------	--	--	--	---

HST222-641.BackFabric.SeatFabric.Flammability.Caster Example: HST222-641.950-88.950-88.U.DWCM



Dimensions

Cadre HST222-651



OH	35½-39½	AH	26½-30½
OW	24	WBA	19
OD	26	DED	
SH	18½-22½	DEW	
SD	19	R	
Shipping Weight		66	
Cube		20.4	

Mid Back | Channel Stitched Upholstered Back and Seat | Polished Aluminum Arm with Urethane Arm Cap |

ANSI/BIFMA LEVEL® Furniture Sustainability Standard certified
Indoor Advantage™ certified

Synchronized Adjustments | Five-Prong Polished Aluminum Base | Double Wheel Casters

Pricing for Single Fabric Placement:

Upholstery:

COM/COL	2995
Grade A	2910
Grade B	2955
Grade C	2995
Grade D	3035
Grade E	3080
Grade F	3130
Grade G	3185
Grade H	3245
Grade J	3285
Grade K	3370
Grade L	3495
Grade M	3660
Leather I	3945
Leather II	4245
Leather III	4545
Leather IV	4845
Leather V	5145
Leather VI	5445

Upholstery Requires:

Fabric: 3¾ Yards
Leather: 67½ Sq. Ft.

Pricing for Multiple Fabric Placement:

(To Calculate, Begin with Base Price and add Upcharges)

Back Upholstery:

COM/COL	75
Grade A	25
Grade B	50
Grade C	75
Grade D	100
Grade E	125
Grade F	155
Grade G	190
Grade H	225
Grade J	250
Grade K	300
Grade L	375
Grade M	475
Leather I	645
Leather II	825
Leather III	1005
Leather IV	1185
Leather V	1365
Leather VI	1545

Upholstery Requires (Per Application):

Fabric: 2¼ Yards
Leather: 40½ Sq. Ft.

Seat Upholstery:

COM/COL	50
Grade A	15
Grade B	35
Grade C	50
Grade D	65
Grade E	85
Grade F	105
Grade G	125
Grade H	150
Grade J	165
Grade K	200
Grade L	250
Grade M	315
Leather I	430
Leather II	550
Leather III	670
Leather IV	790
Leather V	910
Leather VI	1030

Upholstery Requires (Per Application):

Fabric: 1½ Yards
Leather: 27 Sq. Ft.

Base Price: 2870

Total Required

Upholstery: Fabric: 3¾ Yards
Leather: 67½ Sq. Ft.

PLEASE SPECIFY THE FOLLOWING TO ORDER:

<p>MODEL NUMBER</p>	<p>TEXTILES</p> <p>Indicate fabric choice for:</p> <p>Back upholstery</p> <p><i>See options for fabrics at www.bbftextiles.com</i></p>	<p>TEXTILES</p> <p>Indicate fabric choice for:</p> <p>Seat upholstery</p> <p><i>See options for fabrics at www.bbftextiles.com</i></p>	<p>FLAMMABILITY</p> <p>Indicate flammability:</p> <p>U = Cal 117</p>	<p>CASTER</p> <p>DWCM = Double Wheel - Medium Casters</p> <p>DWCS = Double Wheel - Soft Casters +\$106</p>
----------------------------	--	--	--	---

HST222-651.BackFabric.SeatFabric.Flammability.Caster Example: HST222-651.950-88.950-88.U.DWCM



Dimensions

Cadre HST222-661



OH	41½-44½	AH	26½-30½
OW	24	WBA	19
OD	26	DED	
SH	18½-22½	DEW	
SD	19	R	

Shipping Weight 66
Cube 22.5

High Back | Channel Stitched Upholstered Back and Seat | Polished Aluminum Arm with Urethane Arm Cap |

ANSI/BIFMA LEVEL® Furniture Sustainability Standard certified
Indoor Advantage™ certified

Synchronized Adjustments | Five-Prong Polished Aluminum Base | Double Wheel Casters

Pricing for Single Fabric Placement:

Upholstery:

COM/COL	3285
Grade A	3215
Grade B	3250
Grade C	3285
Grade D	3325
Grade E	3360
Grade F	3400
Grade G	3455
Grade H	3505
Grade J	3540
Grade K	3610
Grade L	3720
Grade M	3865
Leather I	4110
Leather II	4370
Leather III	4630
Leather IV	4890
Leather V	5150
Leather VI	5410

Upholstery Requires:

Fabric: 3¼ Yards
Leather: 58½ Sq. Ft.

Pricing for Multiple Fabric Placement:

(To Calculate, Begin with Base Price and add Upcharges)

Back Upholstery:

COM/COL	55
Grade A	20
Grade B	35
Grade C	55
Grade D	75
Grade E	95
Grade F	120
Grade G	145
Grade H	175
Grade J	195
Grade K	230
Grade L	290
Grade M	370
Leather I	500
Leather II	640
Leather III	780
Leather IV	920
Leather V	1060
Leather VI	1200

Upholstery Requires (Per Application):

Fabric: 1¾ Yards
Leather: 31½ Sq. Ft.

Seat Upholstery:

COM/COL	50
Grade A	15
Grade B	35
Grade C	50
Grade D	65
Grade E	85
Grade F	105
Grade G	125
Grade H	150
Grade J	165
Grade K	200
Grade L	250
Grade M	315
Leather I	430
Leather II	550
Leather III	670
Leather IV	790
Leather V	910
Leather VI	1030

Upholstery Requires (Per Application):

Fabric: 1½ Yards
Leather: 27 Sq. Ft.

Base Price: 3180

Total Required

Upholstery: Fabric: 3¼ Yards
Leather: 58½ Sq. Ft.

PLEASE SPECIFY THE FOLLOWING TO ORDER:

<p>MODEL NUMBER</p>	<p>TEXTILES</p> <p>Indicate fabric choice for:</p> <p>Back upholstery</p> <p><i>See options for fabrics at www.bbftextiles.com</i></p>	<p>TEXTILES</p> <p>Indicate fabric choice for:</p> <p>Seat upholstery</p> <p><i>See options for fabrics at www.bbftextiles.com</i></p>	<p>FLAMMABILITY</p> <p>Indicate flammability:</p> <p>U = Cal 117</p>	<p>CASTER</p> <p>DWCM = Double Wheel - Medium Casters</p> <p>DWCS = Double Wheel - Soft Casters +\$106</p>
----------------------------	--	--	--	---

HST222-661.BackFabric.SeatFabric.Flammability.Caster Example: HST222-661.950-88.950-88.U.DWCM



Dimensions

Cadre HST222-671



OH	35½-39½	AH	26½-30½
OW	24	WBA	19
OD	26	DED	
SH	18½-22½	DEW	
SD	19	R	

Shipping Weight 66
Cube 20.4

Mid Back | Channel Stitched Upholstered Back and Seat | Full Polished Aluminum Wrap Around Arm with Urethane Arm Cap |

Knee Tilt | Five-Prong Polished Aluminum Base | Double Wheel Casters

ANSI/BIFMA LEVEL® Furniture Sustainability Standard certified
Indoor Advantage™ certified

Pricing for Single Fabric Placement:

Upholstery:

COM/COL	3015
Grade A	2930
Grade B	2975
Grade C	3015
Grade D	3055
Grade E	3100
Grade F	3150
Grade G	3205
Grade H	3265
Grade J	3305
Grade K	3390
Grade L	3515
Grade M	3680
Leather I	3965
Leather II	4265
Leather III	4565
Leather IV	4865
Leather V	5165
Leather VI	5465

Upholstery Requires:

Fabric: 3¾ Yards
Leather: 67½ Sq. Ft.

Pricing for Multiple Fabric Placement:

(To Calculate, Begin with Base Price and add Upcharges)

Back Upholstery:

COM/COL	75
Grade A	25
Grade B	50
Grade C	75
Grade D	100
Grade E	125
Grade F	155
Grade G	190
Grade H	225
Grade J	250
Grade K	300
Grade L	375
Grade M	475
Leather I	645
Leather II	825
Leather III	1005
Leather IV	1185
Leather V	1365
Leather VI	1545

Upholstery Requires (Per Application):

Fabric: 2¼ Yards
Leather: 40½ Sq. Ft.

Seat Upholstery:

COM/COL	50
Grade A	15
Grade B	35
Grade C	50
Grade D	65
Grade E	85
Grade F	105
Grade G	125
Grade H	150
Grade J	165
Grade K	200
Grade L	250
Grade M	315
Leather I	430
Leather II	550
Leather III	670
Leather IV	790
Leather V	910
Leather VI	1030

Upholstery Requires (Per Application):

Fabric: 1½ Yards
Leather: 27 Sq. Ft.

Base Price: 2890

Total Required

Upholstery: Fabric: 3¾ Yards
Leather: 67½ Sq. Ft.

PLEASE SPECIFY THE FOLLOWING TO ORDER:

<p>MODEL NUMBER</p>	<p>TEXTILES</p> <p>Indicate fabric choice for:</p> <p>Back upholstery</p> <p><i>See options for fabrics at www.bbftextiles.com</i></p>	<p>TEXTILES</p> <p>Indicate fabric choice for:</p> <p>Seat upholstery</p> <p><i>See options for fabrics at www.bbftextiles.com</i></p>	<p>FLAMMABILITY</p> <p>Indicate flammability:</p> <p>U = Cal 117</p>	<p>CASTER</p> <p>DWCM = Double Wheel - Medium Casters</p> <p>DWCS = Double Wheel - Soft Casters +\$106</p>
----------------------------	--	--	--	---

HST222-671.BackFabric.SeatFabric.Flammability.Caster Example: HST222-671.950-88.950-88.U.DWCM



Dimensions

Cadre HST222-681



OH	41½-44½	AH	26½-30½
OW	24	WBA	19
OD	26	DED	
SH	18½-22½	DEW	
SD	19	R	

Shipping Weight 66
Cube 22.5

High Back | Channel Stitched Upholstered Back and Seat | Full Polished Aluminum Wrap Around Arm with Urethane Cap |

Knee Tilt | Five-Prong Polished Aluminum Base | Double Wheel Casters

ANSI/BIFMA LEVEL® Furniture Sustainability Standard certified
Indoor Advantage™ certified

Pricing for Single Fabric Placement:

Upholstery:

COM/COL	3310
Grade A	3240
Grade B	3275
Grade C	3310
Grade D	3350
Grade E	3385
Grade F	3425
Grade G	3480
Grade H	3530
Grade J	3565
Grade K	3635
Grade L	3745
Grade M	3890
Leather I	4135
Leather II	4395
Leather III	4655
Leather IV	4915
Leather V	5175
Leather VI	5435

Upholstery Requires:

Fabric: 3¼ Yards
Leather: 58½ Sq. Ft.

Pricing for Multiple Fabric Placement:

(To Calculate, Begin with Base Price and add Upcharges)

Back Upholstery:

COM/COL	55
Grade A	20
Grade B	35
Grade C	55
Grade D	75
Grade E	95
Grade F	120
Grade G	145
Grade H	175
Grade J	195
Grade K	230
Grade L	290
Grade M	370
Leather I	500
Leather II	640
Leather III	780
Leather IV	920
Leather V	1060
Leather VI	1200

Upholstery Requires (Per Application):

Fabric: 1¾ Yards
Leather: 31½ Sq. Ft.

Seat Upholstery:

COM/COL	50
Grade A	15
Grade B	35
Grade C	50
Grade D	65
Grade E	85
Grade F	105
Grade G	125
Grade H	150
Grade J	165
Grade K	200
Grade L	250
Grade M	315
Leather I	430
Leather II	550
Leather III	670
Leather IV	790
Leather V	910
Leather VI	1030

Upholstery Requires (Per Application):

Fabric: 1½ Yards
Leather: 27 Sq. Ft.

Base Price: 3205

Total Required

Upholstery: Fabric: 3¼ Yards
Leather: 58½ Sq. Ft.

PLEASE SPECIFY THE FOLLOWING TO ORDER:

<p>MODEL NUMBER</p>	<p>TEXTILES</p> <p>Indicate fabric choice for:</p> <p>Back upholstery</p> <p><i>See options for fabrics at www.bbftextiles.com</i></p>	<p>TEXTILES</p> <p>Indicate fabric choice for:</p> <p>Seat upholstery</p> <p><i>See options for fabrics at www.bbftextiles.com</i></p>	<p>FLAMMABILITY</p> <p>Indicate flammability:</p> <p>U = Cal 117</p>	<p>CASTER</p> <p>DWCM = Double Wheel - Medium Casters</p> <p>DWCS = Double Wheel - Soft Casters +\$106</p>
----------------------------	--	--	--	---

HST222-681.BackFabric.SeatFabric.Flammability.Caster Example: HST222-681.950-88.950-88.U.DWCM