

Firma Table Collection

PRICE LIST

STATE OF SOUTH CAROLINA



Mailing Address:

HBF
PO Box 8
Hickory, NC 28603-0008

Shipping Address:

HBF
900 12th Street Drive NW
Hickory, NC 28601-4763

Contact:

Phone: 1.855.HBF.2020
828.328.2064
Fax: 828.485.2690
Info: hbfservice@hbf.com
www.hbf.com

Order Processing:

Phone: 1.855.HBF.2020
828.328.2064
Fax: 828.485.2690
hbforders@hbf.com

Table of Contents

General Information

Terms and Conditions of Sales..... 3
Sustainability..... 7
Engineering and Performance Testing..... 8
Wood Finishes..... 9

Limited Warranty

HBF..... 10
Juniper..... 12

Occasional and Communal Table Sustainability..... 13

Wood Veneer Disclosure..... 14

Materials..... 15

Material Cleaning Guide..... 18

Collection Overview..... 19

Tabletop Material Specifications..... 20

Tabletop Specifications..... 21

Base Specifications..... 22

Base Specifications: Communal..... 23

Power and Cable Management

Integrated Power Rail Power Module
Specifications 24

Juniper Shared Task Lamp + Power System
Specifications.....26

Integrated Power Rail Power Module and Juniper
Shared Task Lamp + Power System Specifications.. 28

Integrated Power Rail Power Module
Specifications.....30

Internal Power Cable Kit Specifications..... 31

Juniper Shared Task Lamp + Power System
Specifications: Dimensions..... 32

Pricing

Occasional Tables..... 36

Multipurpose Tables..... 37

Conference Table..... 38

ADA Height Table 34” 39

Counter Height Table 36” 40

Bar Height Table 42” 41

COM Bases..... 42

Integrated Power Rail Power Modules..... 43

Internal Power Cable Kits..... 44

Juniper Shared Task Lamp + Power System..... 45

Bag Hooks..... 46

Shipping Details

Occasional Tables..... 47

Multipurpose Tables..... 48

Conference Table..... 49

ADA Height Table 34” 51

Counter Height Table 36” 53

Bar Height Table 42” 55



These Terms and Conditions apply to all quotations, orders, and contracts for Hickory Business Furniture, LLC (“HBF”) furniture products (“Products”)

Entire Agreement

Our sale to you is limited to and expressly made conditional on your assent to the published Terms and Conditions of Sale, all of which form a part of our acknowledgment and which supersede and reject all prior writings, representations, negotiations with respect hereto, and any conflicting terms and conditions of yours, whether or not the acknowledgment is signed by you. Your acceptance of the HBF products described on the face of the acknowledgment or payment therefore operates as acceptance by you of our Terms and Conditions of Sale.

Order Entry

To expedite order entry and to ensure proper service:

Email Orders: hbforders@hbf.com

Fax Orders: 828.485.2690

Mail Orders: HBF, PO Box 8, Hickory, NC 28603-0008

All orders faxed or emailed and then mailed to HBF must be marked “Confirmation.” HBF will not be responsible for duplicate orders if purchase orders are left unmarked.

Your order will be considered to be an offer by you to purchase the products described on that order until it is accepted and acknowledged in writing by us. Unless we receive a communication from you concerning our acknowledgment, we will schedule production of your order by the end of the business day following the day we provide you our acknowledgment.

Submitting Purchase Orders

Please provide complete customer contact information including, but not limited to, email address, bill to/ship to information, contact name and telephone number, project specifier and product information.

Pricing

Prices for the products described in our acknowledgment shall be from our current and applicable published price list, as in effect at the time we acknowledge your order, less the discounts listed on our acknowledgment. However, if any order requests a delivery date more than one hundred twenty (120) days from the date of the order, then the applicable price list will be the current price list on the date of shipment.

Payment Terms

Payment terms are net thirty (30) days from the date of our invoice. If credit has not been established, full payment must accompany your order. We accept MasterCard, VISA and American Express. We reserve the right at any time to require you to provide us with reasonable assurances for due payment for the products, and we may suspend any further performance of your order until you provide reasonable assurances of payment satisfactory to us.

Deposits

HBF reserves the right, at our sole discretion, to require you to submit a deposit with your order. The required amount of your deposit, if any, will be listed on our acknowledgment. All deposits become non-refundable once we begin production of the applicable order.

Changes + Cancellations

Prices published are List prices. HBF reserves the right to adjust prices, specifications, and materials without prior notification. HBF will not enter orders with incomplete information.



These Terms and Conditions apply to all quotations, orders, and contracts for Hickory Business Furniture, LLC (“HBF”) furniture products (“Products”)

**Return of Merchandise
Claims + Allowances**

Products may be returned only with our prior written consent and shipping instructions. You must pre-pay all Claims & Allowances related transportation costs. Authorized returns are subject to a minimum 35% restocking charge. Returned products must be received in the original carton and in new condition. Damaged or used products may be subject to an additional or full charge. No credit or allowance will be given for any repairs to damaged or defective Products unless we give you written permission to make the repairs. We reserve the right to have any product returned (freight charges prepaid) to our factory for inspection. If your claim is justified, we will refund your freight costs and repair or replace the damaged product at our expense and subject to the HBF Limited Warranty.

**Damaged, Over, Short
Merchandise**

HBF is not liable for damages that occur during transit, concealed damages, or damages from storage or Merchandise installation. HBF is FOB; the carrier assumes all responsibility upon acceptance of the product. It is the customer/receiver’s responsibility to inspect all products upon receipt. Any visible damage to a carton requires that a written exception be noted on the delivery receipt. An immediate inspection should be requested of the carrier if any products are damaged. Please hold on to cartons and packing materials if carrier inspection is needed.

NOTE: If concealed damage is discovered, it must be reported to the carrier and HBF immediately. Failure to notify carrier and HBF immediately shall constitute an acceptance of the products as received. Upon arrival of the product, examine the delivery receipt to ensure address is correct, piece count is correct and correct products are received.

Examine all cartons for the following:

- Crushed corners, ends, or sides
- Holes
- Rips
- Dents
- Water stains or damage
- Missing cartons

Before HBF files a claim with the carrier on your behalf, you will need to provide the following:

- A copy of the signed delivery receipt with exceptions notated
- A copy of the carrier’s inspection report
- Any photographs of the cartons and products.

In the event of overage or shortage, regardless of carrier, you shall not accept the shipment until such overage or shortage is noted on both the bill of lading and the freight bill. In the case of an overage or shortage on our truck, you shall notify our factory immediately.

Packaging

HBF uses 60%-70% post-consumer content recycled corrugated and 100% recyclable stretch wrapping and/or plastic bags. Pricing includes cartoning of all products.

Shipments

HBF will determine routing. Refer to our Guaranteed Freight Program, as in effect at the time of our acknowledgment, for details on our optional guaranteed freight program.

A \$25.00 charge will be added to your invoice for prepaid freight requests when not using our Guaranteed Freight Program. Requests for specific carriers are subject to our approval. We will not drop-ship to an end-user customer without that customer’s prior approval. We reserve the right to split-ship orders.



These Terms and Conditions apply to all quotations, orders, and contracts for Hickory Business Furniture, LLC (“HBF”) furniture products (“Products”)

Insurance

HBF carries the following insurance:

- Worker’s Compensation Insurance (or its equivalent) in accordance with the requirements of applicable law.
- Employer’s Liability Insurance – \$1,000,000 policy limit.
- Motor Vehicle Liability Insurance – \$1,000,000 combined single limit.
- Commercial General Liability Insurance (including products, completed operations, and contractual liability) – \$1,000,000 per occurrence of bodily injury and property damage; \$1,000,000 per occurrence of personal and advertising injury; \$2,000,000 annual general aggregate; and \$4,000,000 products and completed operations annual aggregate.

You may change or cancel an acknowledged order only with our prior written consent. Order changes and cancellations are subject to price and schedule adjustments and/or cancellation charges, as appropriate.

Storage by HBF

HBF has made no provision for storage of products ordered by you. If you are unable to accept delivery of products as scheduled for any reason, you are solely responsible for providing new shipping instructions to HBF and for all costs associated with any delay.

Storage by Owner

Due to the inherent nature of wood products, HBF does not warrant any product stored or set in place in an environment where temperature and humidity are not controlled. Temperatures must be maintained within a range of 50-60 degrees F (or 10-27 degrees C); the relative humidity must be maintained between 30%

Warranty

We warrant HBF products in accordance with the HBF Limited Warranty as outlined on pages 14 & 15, as in effect at the time of acknowledgment, the terms of which are incorporated by reference into these Terms and Conditions of Sale.

Force Majeure

We will not be liable for any failure to deliver product when delivery is prevented by any cause beyond our reasonable control. Causes beyond our reasonable control will include, without limitation, acts of God, war, terrorism, insurrection, epidemic, labor disputes, inability to obtain raw materials, supplies, labor or transportation, or any act of governmental authorities.

Limitation of Liability

In no event will HBF be liable to you for special, incidental, indirect, consequential, or any other similar damages, including, but not limited to, the loss of profits or revenues, loss of use of product or cost of substitute product, based on or arising from any breach of warranty, breach of contract, negligence or any other legal theory.

General

These Terms and Conditions of Sale: (a) shall be binding on the parties and their respective successors and permitted assigns; (b) may not be amended or modified unless such amendment or modification is made in writing and signed by both parties; and (c) may not be assigned by either party without the prior written consent of the other party. No provision of these Terms and Conditions of Sale may be waived unless such waiver is made in writing and signed by the party to be bound thereby.



These Terms and Conditions apply to all quotations, orders, and contracts for Hickory Business Furniture, LLC (“HBF”) furniture products (“Products”)

Governing Law, Venue & Waiver of Jury Trial

The laws of the State of North Carolina shall govern the interpretation, validity and enforceability of these Terms and Conditions of Sale, excluding North Carolina law with respect to conflicts of law. The rights and obligations of the parties shall not be governed by the 1980 United Nations Convention on Contracts for the International Sale of Goods. The parties agree that court proceedings, actions or suits which may be brought by either party against the other party under, related to or by virtue of these terms and conditions of sale or the provision of products shall be brought exclusively in a court of competent jurisdiction in the State of North Carolina and each party hereby covenants and agrees to submit to the exclusive jurisdiction of such court in the event such party is named as a party in any such proceedings, actions or suits. The parties hereby agree that any court proceedings, actions or suits which may be brought under, related to or by virtue of these Terms and Conditions of Sale or the provision of products between the parties shall be determined by a court sitting without a jury. The parties hereby waive any right to a jury trial.

No Other Contract Provisions

There are no representations, agreements, obligations, or conditions (express or implied, statutory or otherwise) relating to the subject matter hereof, other than as herein contained, and these terms and conditions of sale shall be incorporated and become a part of any agreement between the parties with reference to the purchase of our Products.



Environmental

HBF and HBF Textiles are committed to protecting the environment for future generations. We understand the potential impact of our products and have integrated life cycle principals into our design and manufacturing systems driving continuous improvement in products, workspace environments and our community. We strive to meet the most stringent environmental standards, including BIFMA LEVEL®, BIFMA's sustainability certification program for furniture, and SCS Global Services' (SCS') Indoor Advantage™ Gold certification for indoor air quality. We provide environmental data sheets to help our clients calculate the environmental benefits of using HBF products in Leadership in Energy and Environmental Design (LEED)® projects.

Recycled Materials

HBF Price Lists include the post-consumer (PC) and post-industrial (PI) recycled content percentages for all seating products where applicable to serve as a road map for those who wish to quickly identify environmentally sound products. HBF uses Green-Blend® panel materials wherever possible. Green-Blend® panel material cores are produced with no added urea-formaldehyde and contribute towards LEED® Rapidly Renewable Materials and Recycled Content credits. Green-Blend is SCS® certified 100% pre-consumer recycled wood fiber panel material that has no urea-formaldehyde added during the manufacturing process. It combines low emission standards, certified recycled content and sustainable raw materials with the reliability of a proven industry track record of wood based panel material.

ANSI/BIFMA e3-2014e Furniture Sustainability Standard and LEVEL® Certification

A majority of HBF's products have met the necessary qualifications to achieve LEVEL® certification. LEVEL® is the multi-attribute sustainability certification based on the ANSI/BIFMA e3 Furniture Sustainability Standard. The standard and certification were created to deliver the most open and transparent means of evaluating and communicating the environmental and social impacts of furniture products in the built environment. Taking into account a company's social actions, energy usage, material selection and human and ecosystem health impacts, LEVEL® addresses how a product is sustainable from multiple perspectives. The organization, facilities, and products are audited on an annual basis to ensure ongoing compliance and improvement. With LEVEL®, customers can make informed choices about sustainable commercial office furniture. The LEVEL® mark identifies that a product has been vetted by an independent third party certifier and its numeric marking of 1, 2, or 3 indicates the threshold of certification the product has achieved. A majority of HBF's seating, occasional tables, and conference lines are LEVEL® certified. Please download the certificates from our product pages for the complete details. For more information about the ANSI/BIFMA LEVEL® standard, visit www.levelcertified.org.

ANSI/BIFMA LEVEL® Performance Standards

Our seating products meet or exceed ANSI/BIFMA weight performance standards of 275 lbs. (124.7 kg.) unless otherwise noted.

Indoor Advantage Certified™

Many HBF products are Indoor Advantage™ Gold certified

SCS Global Services (SCS), a reputable third-party certification and assessment body of environmental, sustainability and safety claims since 1984, has developed internationally recognized standards and certification programs to assist businesses with improving their environmental efforts, social accountability and product performance.

The advantages of holding Indoor Air Quality certification are substantial: in addition to improving indoor working environments and meeting qualifications for the LEED-CI EQ 4.5 credit for office furniture as well as the BIFMA Standard for Low-Emitting Office Furniture Systems & Seating M-7.1, there is the added assurance of knowing that the company's entire breadth of products is held to such rigorous standards.

For more information regarding Indoor Advantage™, please visit: <http://www.scsglobalservices.com>.



Engineering

HBF products have been engineered to provide the structural integrity necessary to assure customer satisfaction. Seating has been engineered to provide proper body support to the user. Specifications of construction techniques for HBF products are available upon request.

Performance

HBF voluntarily tests a majority of its products to the rigid testing requirements as set forth in accordance with BIFMA and ANSI standards. Information on testing procedures is available upon request.



Wood Species

All external wood parts used in the manufacture of HBF wood products are of the highest grade solids and veneers. Veneer options per product series are indicated with each product. These, like all natural materials, are subject to variation in grain and coloration.

Finishes

HBf finishes have been developed to be compatible with finishes in today's market. Finish specifications must be shown on each order.

STANDARD WOOD FINISHES

HBf offers a variety of standard wood finishes on multiple solid and veneer options. Please refer to the veneer and finish matrix in the price list for each product series to determine finishes and veneers available for that product line.

1. Finished pieces may vary in tone and character. No guarantee can be made of an exact match.
2. Wood finish touch-up kits are available for HBf standard finishes, see HBf Care and Maintenance Kits.

CUSTOM WOOD FINISHES

Custom wood finish samples must accompany the purchase order.

Orders specifying custom wood finishes will be scheduled into regular production upon receipt of an approved custom wood finish panel.

An upcharge of 5% Net per seating unit, with a minimum upcharge of \$500 Net per order, will apply for any custom wood finish.

An upcharge of 5% Net per occasional table unit, with a minimum upcharge of \$500 Net per order, will apply for any custom wood finish.

An upcharge of 10% Net per unit for conference products, with a minimum upcharge of \$500 Net per order will apply for any custom wood finish.



Hickory Business Furniture, dba HBF, warrants to the original purchaser that its products are free from defects in materials and workmanship for a period of twelve (12) years from date of shipment, except as noted below. This warranty applies to single shift (standard 8-hour day, 5 days per week) use, and covers products delivered in the Americas: Canada, the Caribbean, Latin America, Mexico and the United States.

Exceptions

5 Years

Stacking chairs, metal chair frames, seating components including controls and adjustment mechanisms, monitor supports and tablet arm assemblies, wood, wood veneer, linoleum, low (LPL) and high (HPL) pressure laminate surfaces, solid surfaces, urethane, wood and wood edge treatments, and tailoring.

3 Years

Electrical components and power supplies, ballasts, height adjustment mechanisms and pneumatic cylinders, casters, glides, exposed wood frames and legs, marker and tack board surfaces, granite, marble and glass surfaces, and replacement parts.

2 Years

Graded-In HBF Textiles cover materials including, but not limited to, textiles, leathers and faux leathers. Licensed products are warranted to the original purchaser to be free from defects in materials and workmanship for a period of two (2) years from date of shipment, except as noted under the exclusions below.

Exclusions

Warranty does not apply to product failure or loss resulting from:

- Acts of nature, civil disobedience or social unrest.
- Normal wear and tear.
- COM (Customer’s own materials) including, but not limited to solid surfaces, linoleum, laminates, textiles and upholstery materials, leathers, wood and wood veneers. These materials are subject to the original manufacturer’s warranties only.
- Failure to apply, install, clean or maintain products according to published HBF or manufacturer instructions and guidelines.
- Use of harsh, abrasive or acidic cleaning agents; and chemicals or agents that may alter or degrade the appearance, materiality and structural integrity of the product.
- Physical or chemical abuse, misuse, neglect or accident.
- Unauthorized alteration or modification of the product.
- Unauthorized repair of the product.
- Products exposed to extreme environmental conditions, direct sunlight or improper storage.
- Products exposed to outdoor use, unless manufactured specifically for outdoor conditions.
- Products used for rental purposes.’
- Substitution of any unauthorized components that are integral to the performance of the product.

Warranty does not cover:

- Replacement parts are covered for three (3) years or the balance of the original warranty, whichever is longer. Replacement parts for licensed products are covered for one (1) year of the balance of the original warranty, whichever is longer.
- Damage caused by carriers or concealed damage. Damage caused in-transit will be handled under separate terms.
- Damage caused by dealers and their subcontractors or agents.
- Custom and special product(s) are covered for three (3) years, and all other exclusions apply.
- Variations in surface and solid materials including color, grain, marbling, texture and veining.
- Variations in leather such as scars, wrinkles, and other marks.
- Variations in wood such as color, staining, grain, scars and other marks.
- Variations in textiles and other upholstery materials due to inconsistencies between dye lots.
- Color fastness due to aging or exposure to artificial or natural sunlight.
- Consumables, such as batteries, light bulbs and lamps.
- Products purchased “as is,” used or secondhand.
- Products sold by unauthorized dealers or installers.



**Warranty Provides
Exclusive Remedies**

Under this warranty, if a product fails during normal use during the warranty period as a result of a defect in materials or workmanship, HBF will, at its sole discretion, either repair or replace the product free of charge, which includes delivery and labor costs. If HBF determines the repair or replacement of the product(s) is not commercially practical, HBF may choose to refund the purchase price of the affected product. This warranty applies to products purchased on or after June 1, 2017. For products purchased prior to June 1, 2017, please refer to the warranty terms and conditions in effect at that time.

THIS LIMITED WARRANTY IS THE SOLE REMEDY FOR PRODUCT DEFECT AND NO OTHER EXPRESS OR IMPLIED WARRANTY IS PROVIDED, INCLUDING BUT NOT LIMITED TO ANY IMPLIED WARRANTIES OF MERCHANTABILITY OR FITNESS FOR A PARTICULAR PURPOSE. HICKORY BUSINESS FURNITURE SHALL NOT BE LIABLE FOR ANY CONSEQUENTIAL, INDIRECT, SPECIAL, PUNITIVE OR INCIDENTAL DAMAGES.

This warranty is non-transferable and valid to the original purchaser only. Warranty is enforceable only if products were acquired and installed by Hickory Business Furniture or one of its Authorized Resellers.

**Juniper Warranty,
Waivers &
Certifications
Limited Warranty**

Juniper warrants its products to be free from defects in materials and workmanship for a period of three (3) years from the date of delivery. Electrical components including LEDs and other electrical elements excluding external transformers & power supply units will be warranted for five (5) years from the date of delivery. During this warranty period, Juniper will repair, or replace, at its option, free of charge, products with manufacturing defects.

We do not warrant:

- Changes in surface finishes due to aging, exposure, or use of chemicals
- Evidence of product tampering or altering
- Misuse, mistreatment, or neglect
- Variations in metal finishes occurring naturally over time
- Material changes resulting from normal wear and tear

Juniper, if applicable, hereby expressly reserves the right to limit or exclude consequential damages under the terms of this warranty. No back charges, charge for labor or materials are accepted without Juniper's prior written approval.



**ANSI/BIFMA e3-2014
Furniture Sustainability
Standard and LEVEL
Certification**

A majority of HBF's products have met the necessary qualifications to achieve LEVEL® certification. LEVEL® is the Furniture Sustainability the multi-attribute sustainability certification based on the ANSI/BIFMA e3 Furniture Sustainability Standard.

The standard and certification were created to deliver the most open and transparent means of evaluating and communicating the environmental and social impacts of furniture products in the built environment. Taking into account a company's social actions, energy usage, material selection and human and ecosystem health impacts, LEVEL® addresses how a product is sustainable from multiple perspectives. The organization, facilities, and products are audited on an annual basis to ensure ongoing compliance and improvement.

With LEVEL®, customers can make informed choices about sustainable commercial office furniture. The LEVEL® mark identifies that a product has been vetted by an independent third party certifier and its numeric marking of 1, 2, or 3 indicates the threshold of certification the product has achieved. A majority of HBF's seating, occasional tables, and conference lines are LEVEL® certified. Please download the certificates from our product pages for the complete details. For more information about the ANSI/BIFMA LEVEL® standard, visit www.levelcertified.org.

SCS Indoor Advantage™

HBF table products are Indoor Advantage™ Gold Certified. SCS Global Services (SCS), a reputable third-party certification and assessment body of environmental, sustainability and safety claims since 1984, has developed internationally recognized standards and certification programs to assist businesses with improving their environmental efforts, social accountability and product performance.

**HBF High Performance
Products**

HBF and HBF Textiles have long been leaders in contract furnishings and known for industry-leading product design coupled with the highest quality construction, comfort and aesthetic beauty. Now these same principles are the cornerstones of HBF Healthcare high performance products. We have consulted with healthcare designers and clients to provide products and options for interiors that will provide quality sustainable design solutions for the future. These effective solutions will address the unique interactions required by any high-use facility. Visit www.hbf.com for additional high performance product information.

Occasional Table Product High Performance Options:

- Coffee, End and Console Tables
- Acrylic Solid Surface Tops
- Laminate Tops
- Durable Wood Finishes
- Metal Legs
- Surfaces for High Use Areas

Veneer and Finishes

Wood owes its inherent beauty to variations in color, grain, and texture; therefore, these variations are not considered defects. Due to the natural color and grain variances of wood the final finish color, texture and grain may vary from one furniture piece to another even though they are finished at the same time. Exposure to light and the aging process will cause changes in surface color of natural wood products. Light finishes on wood products do not mask the natural characteristics of wood. HBF does not guarantee the exact matching of grain, pattern and color.

An upcharge of 10% Net per unit for communal tables, with a minimum upcharge of \$500 Net per order, will apply for any custom wood finish. Refer to the following page for product material options.

Screen images are intended as a guide only and should not be regarded as absolutely correct. For exact color/texture, please visit www.hbf.com to request an actual sample.

Wood Veneer Options - Tabletop, Subtop and Base

Oak Veneer



Walnut Veneer



Cut Type

Oak
Rift Cut

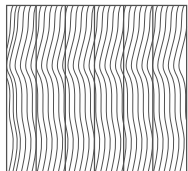

Walnut
Flatcut

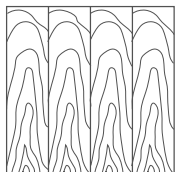

Wood Veneer Grain Direction

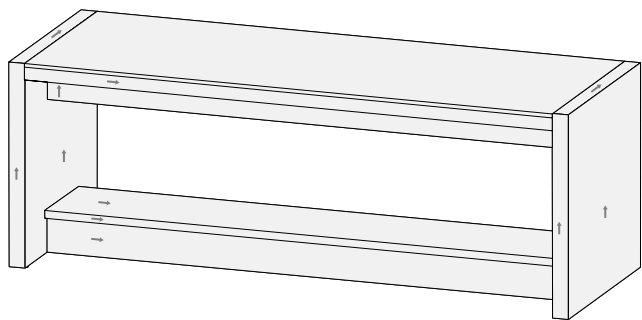

L-Brackets

The color of the L-brackets under the Firma tables is chosen based on the color of the tables base. Black for darker colors and white for lighter ones.



Screen images are intended as a guide only and should not be regarded as absolutely correct. For exact color/texture, please visit www.hbf.com to request an actual sample.

Solid Laminate - Tabletop

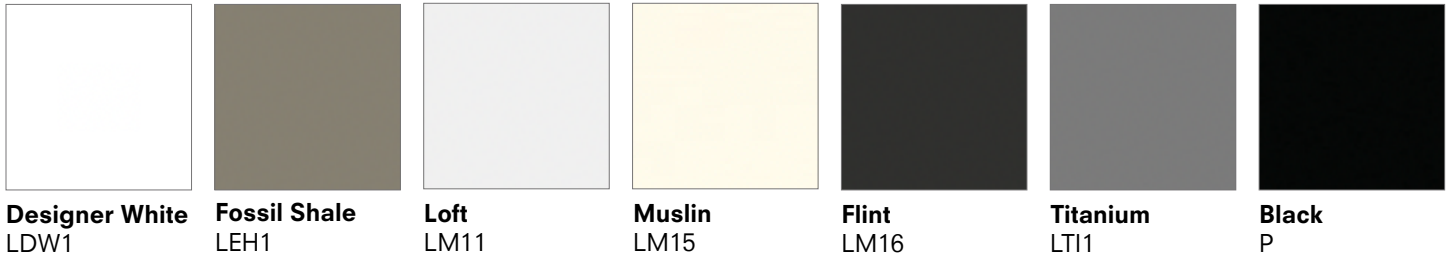

Velvet Black Top with Black (P) Edge Band
LBV1

Glass - Tabletop (Not available with Juniper Shared Task Lamp + Power System)

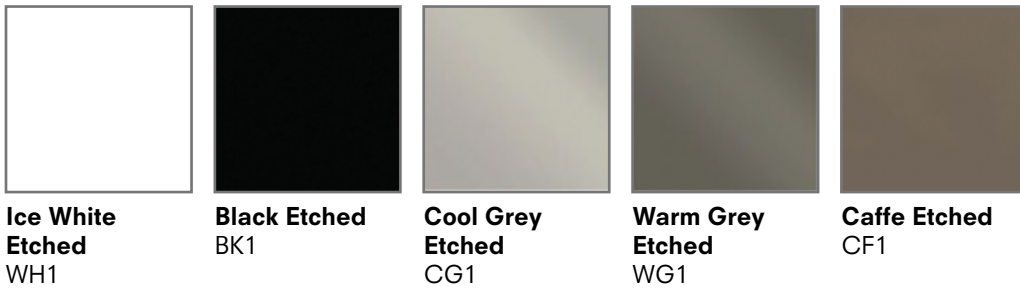

Solid Surface - Tabletop

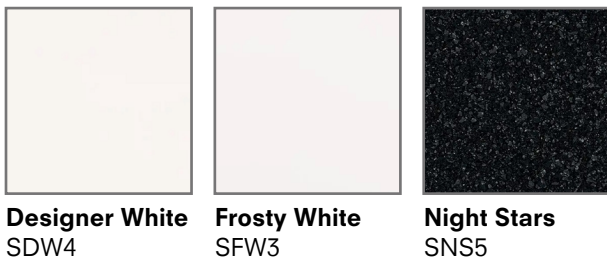

Engineered Quartz - Tabletop

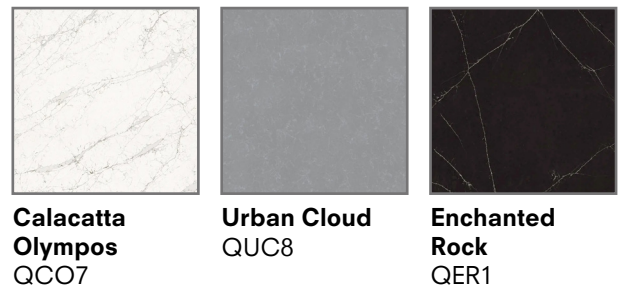

Customer Own Materials (COM) - Tabletop

Firma tables can accept 2cm engineered quartz, solid surface, and stone COM only.

Screen images are intended as a guide only and should not be regarded as absolutely correct. For exact color/texture, please visit www.hbf.com to request an actual sample.

Metal - Plinth

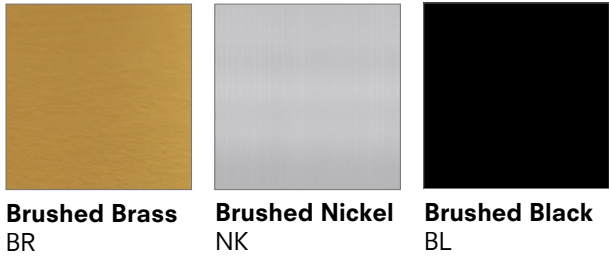

Metal Plinth

Metal - Juniper Shared Task Lamp + Power System



Juniper Power System USB-A Receptacle and Dimmer Knob

Metal - Powder Coated Power Module

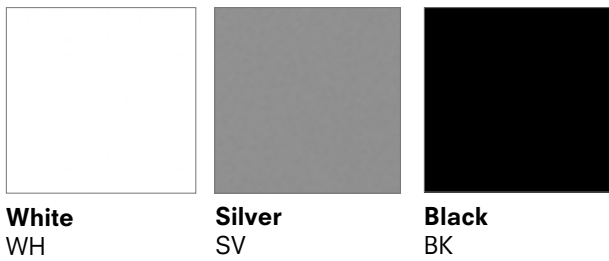

Metal - Bag Hook

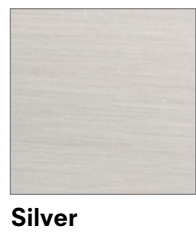

Bag Hook



Juniper Shared Task Lamp + Power System

Laminate

Wipe down with a cloth using warm soapy water or a mild household detergent. Accumulated dirt or grime may be scrubbed with a fine brush such as a firm toothbrush. Light stains may be cleaned with a cloth soaked in acetone or methylated spirits and then wiped dry with a clean cloth. Heavy stains can be cleaned with diluted household bleach. Dilute by adding one part of bleach to three parts of water. Leave on surface for 5-10 minutes and then remove the bleach with plenty of cold water and a clean cloth. Laminates have a durable and water resistant surface that, with careful use and regular cleaning, will last for many years. Excess heat can cause blisters or burns to the surface. Do not use abrasive cleaners on the surface. Warm soapy water is all that is required to keep the surface clean. Stains can be removed with methylated spirits or diluted bleach. Avoid moving abrasive or sharp objects across the surface of the laminate as this can leave marks or dull scratches.

Wood Veneer

HBF employs a multi-step finishing process culminating in the application of a highly durable chemical resistant top coat. The finishing material provides for unusual durability and resistance to everyday chemical compounds such as alcohol, mustard, vinegar and nail polish remover. Due to the protection offered by this finish, the care for HBF furniture simply requires gentle dusting of the surface with a soft, moist, lint-free cloth. This should be followed with a drying cloth. Since dust can act as a potential abrasive, improper rubbing can result in fine hairline scratches. The application of any commonly available furniture polish should be avoided.

Glass

Mix one part white vinegar and four parts distilled water in spray bottle. Spray onto a cleaning cloth or microfiber cloth. Rub the glass surface in a circular motion to remove all spots. Next wipe the glass surface with vertical swipes followed by horizontal swipes to clean glass with a cotton lint free cloth.

Solid Surface

Clean surfaces with mild soap and water. Avoid window cleaners and bleach. To remove small fine scratches, pour mild abrasive liquid cleanser onto a damp cloth or sponge. Rub over area using small circular motions until the area has been cleaned. Rinse the top thoroughly with clean water and wipe surface completely dry using a cotton or soft lint free cloth. Repeat if necessary.

Engineered Quartz

For routine cleaning, simply wipe down your surface with a damp cloth or paper towel and, if necessary, a small amount of non-bleach, non-abrasive cleanser. Even though engineered quartz surfaces resist permanent staining when exposed to liquids (such as wine, vinegar, tea, lemon juice and soda) or fruits and vegetables, you will want to wipe up food and liquid spills as soon as possible. For stubborn or dried spills, use a nonabrasive cleaning scrub pad coupled with a glass & surface cleaner or a comparable cleaning product. Engineered quartz surfaces are heat- and scratch-resistant, but not heat- and scratch-proof. We recommend the use of trivets and hot pads. Because it is nonporous, engineered quartz does not require sealants or waxes. Engineered quartz keeps its lustrous gloss and ultra-smooth surface without polishing or applying sealant. Avoid using cleaners that contain bleach. Always follow the cleaner manufacturer's use instructions and exercise proper care when handling and storing any cleaning products. Avoid High-pH cleaners. Casual exposure to alkaline solutions, such as diluted bleach, will not damage engineered quartz surfaces. Highly alkaline (high pH) cleaners, such as oven cleaners and concentrated bleach, are not recommended. Avoid exposing engineered quartz to strong chemicals and solvents, especially paint removers or furniture strippers containing trichlorethane or methylene chloride. Keep nail polish remover, bleach, detergent, permanent markers or inks, and oil soaps away from engineered quartz. Keep permanent markers and inks away from engineered surfaces. Should these materials come into contact with the surface, clean first as outlined above in the Routine Cleaning section. If the stain persists, moisten a cloth with Goo Gone®, or a comparable product, and rub it into the stain. Rinse thoroughly with warm water to remove any cleaner residue. Materials that harden as they dry (such as gum, food, grease, nail polish or paint) are especially tenacious. Remove these by gently scraping away the excess with a plastic putty knife.

Metal

No chemical should be used any part of the metal fixtures. A microfiber cloth for dusting is suggested.

Collection Models

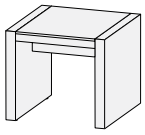

Side Table, Pg. 36

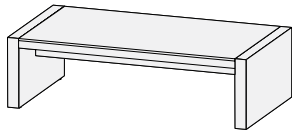

Coffee Table, Pg. 36

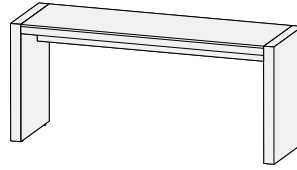

Console Table, Pg. 37

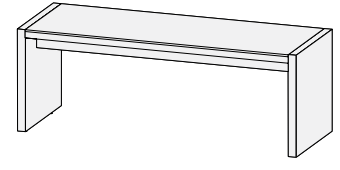

Conference Table (30"), Pg. 38

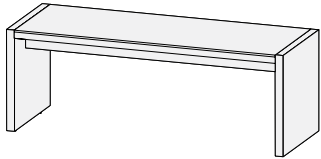

ADA Height Table (34"), Pg. 39

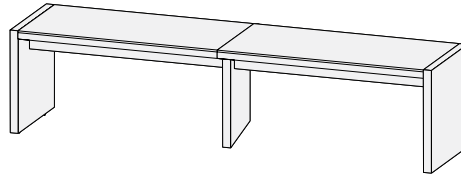

Counter Height Table, (36") Pg. 40

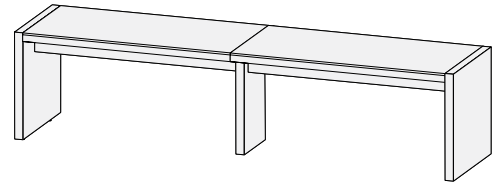

Bar Height Table, (42") Pg. 41

Tabletop	Wood Veneer Laminate Glass Solid Surface Engineered Quartz
Base + Stretcher	Wood Veneer
Metal Plinth	Brushed Brass Brushed Nickel Brushed Black
Wood Veneer Species	Oak Walnut
Power Wiring	Hard-Wire Soft-Wire
Power Systems	Integrated Power Rail Power Modules Juniper Power System*
Power Sources	USB-A Simplex Receptacle Duplex Receptacle
Lighting	Juniper Shared Task Lamp* with Color Temperature 3,000 K
Lighting Power Control	Dimmer
Wire Management	Under mounted Power Rail with Dust Cover Floor Chase Discreet Wire Cutouts and Channels in Table Base
Options	Silver Bag Hook

Shipping

Communal tables (Conference Table, ADA Height Table, Counter Height Table, and Bar Height Table) ship knocked-down. 108" and 120" length wood veneer tabletops available in one or two tabletop pieces. 144" length wood veneer tabletops must ship in two pieces. 108", 120", and 144" length tabletops for all other materials must come in two pieces.

Occasional tables (Side and Coffee Tables) and multipurpose tables (Console Table) ship fully assembled for wood veneer tops. Other tabletop materials must be installed on site.

It is the installing party/dealer's responsibility to ensure and plan for entryway and hallway dimensions accordingly.

*Juniper Shared Task Lamp + Power System not available with glass tabletops.

Wood

Thickness = 0.75"

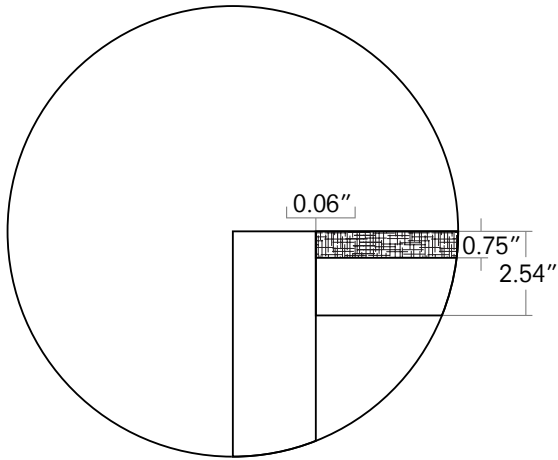

Laminate

Thickness = 0.75"

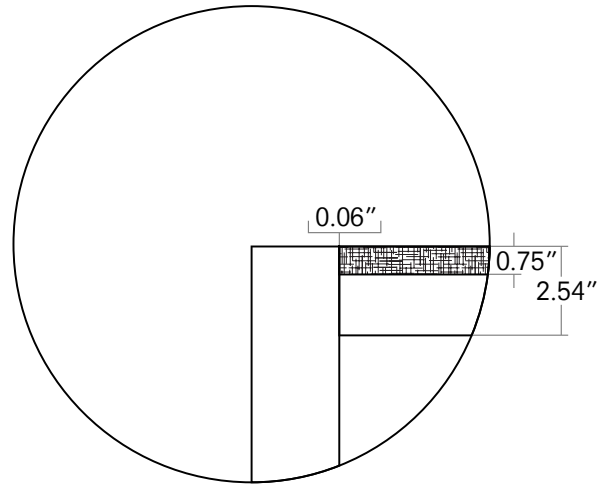

Glass*

Thickness = 0.472" (12mm)

*Not available with Juniper Shared Task Lamp and Power System

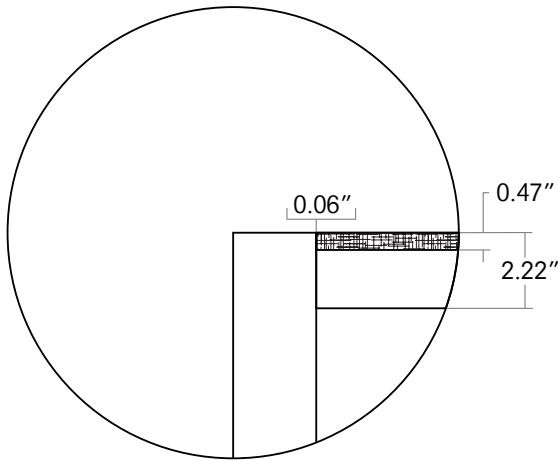

Solid Surface

Thickness = 0.5" (12.7mm)

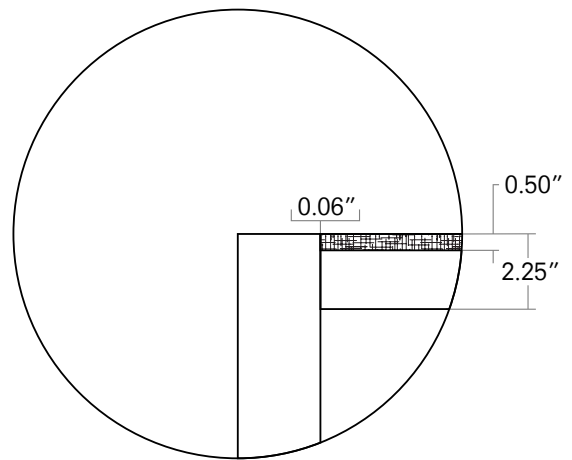

Engineered Quartz

Thickness = 0.79" (20mm)

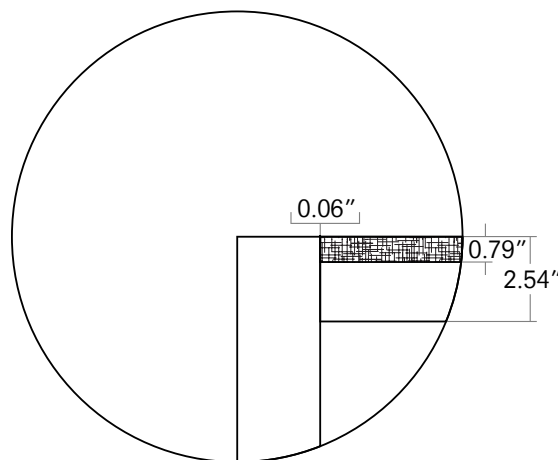

COM Engineered Quartz, Solid Surface or Stone



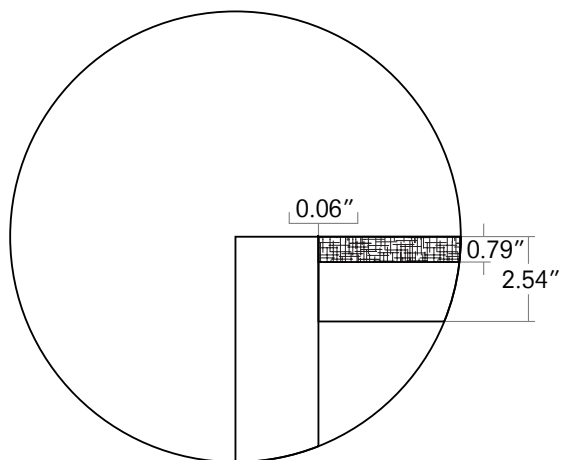

Thickness = 0.79" (20mm)







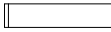









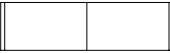
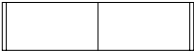

Tabletop Sizes

Occasional Tables

Multipurpose Tables

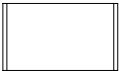
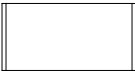
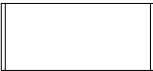

	24"	42"	56"	60"	72"
24"		-	-	18" 	
30"	-	-			
42"	-		-		

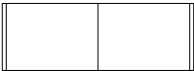
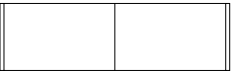
Communal Tables

	60"	72"	84"	96"	108" *	120" *	144"
30"							
36"							
42"							

*108" and 120" wood veneer tables offered in both one and two piece tops, other tabletop materials as shown.

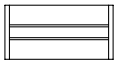
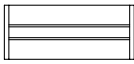
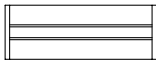
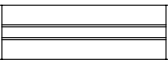
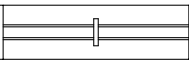
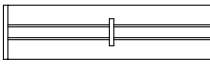
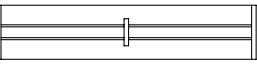
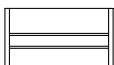
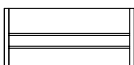
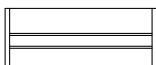
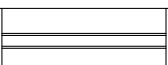
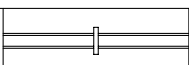
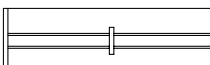
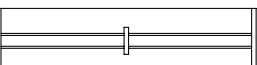
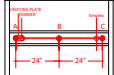
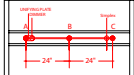
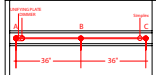
Power Rail and Juniper Shared Task Lamp + Power System* Tabletop Wire Management

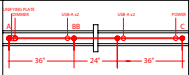
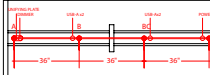
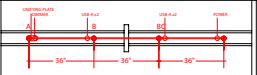
	60"	72"	84"	96"	108"	120"	144"
30"							
36"							
42"							

*Juniper Shared Task Lamp + Power System not available with glass tabletops.

Base Heights

Occasional Tables

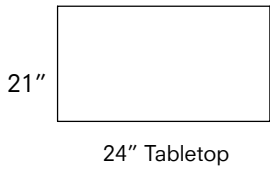
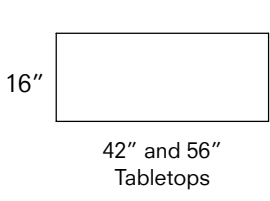

Multipurpose Tables

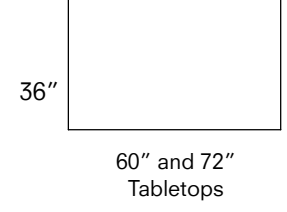
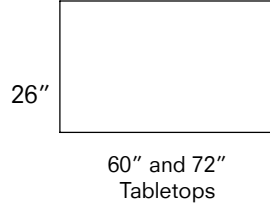

Communal Tables

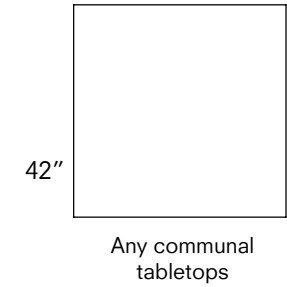
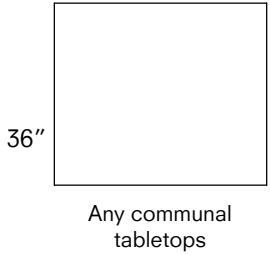
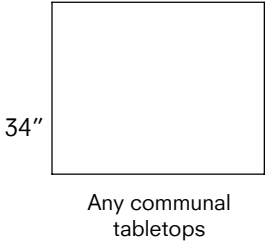
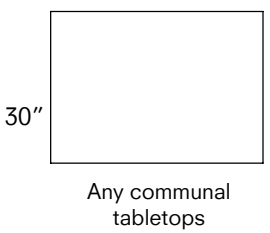

Wire Management

The following illustration shows the wire management within the base of the Firma communal tables.

Side Elevation View

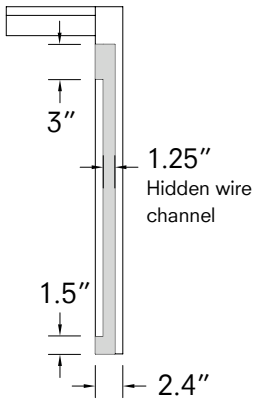

Discreet Wire Cutout on Outside Base Panel



Discreet Wire Cutout on Inside Base Panel



Discreet Wire Cutout on Outside Base Panel

End Elevation View

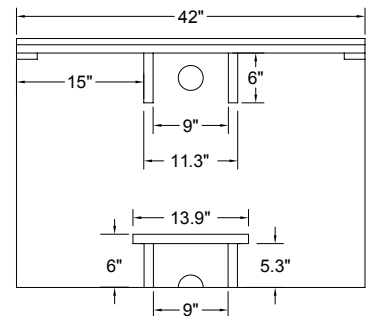
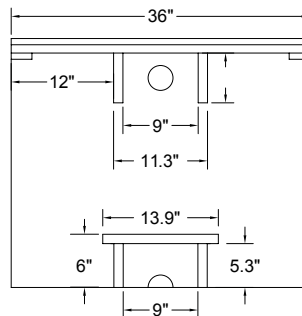
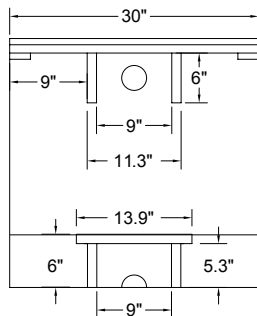
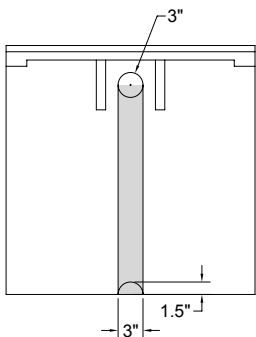

Communal Table Base Options

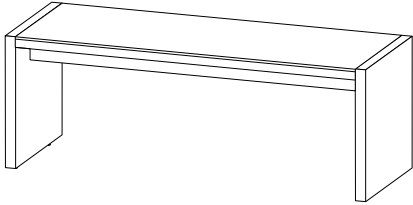
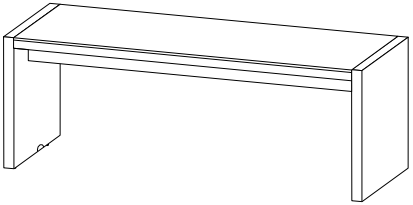
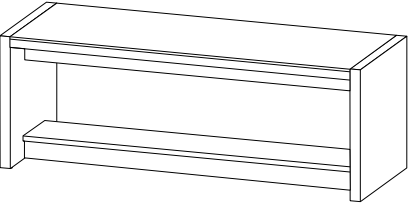
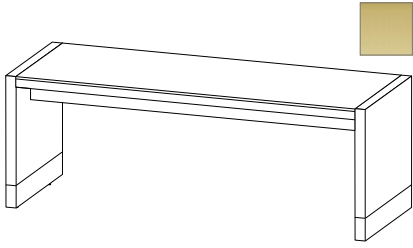
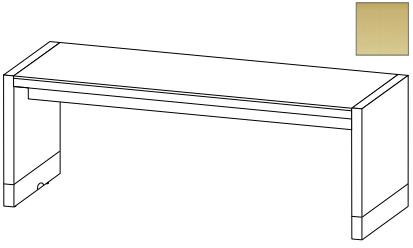
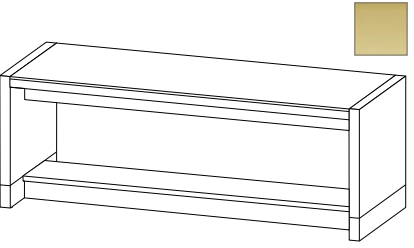
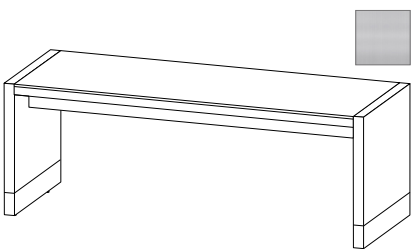
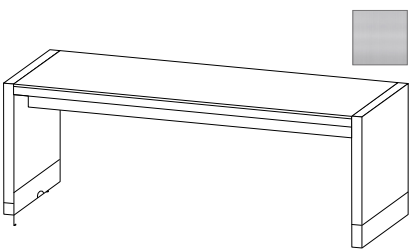
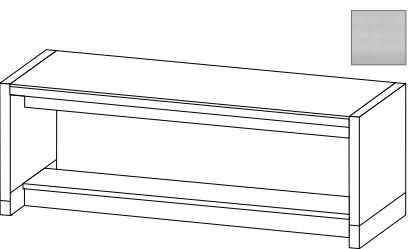
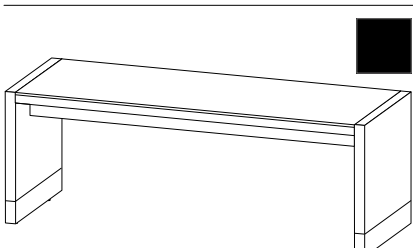
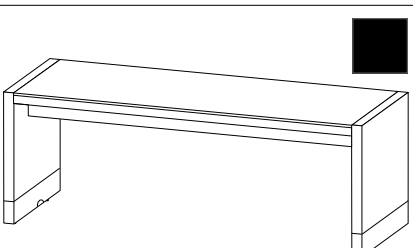
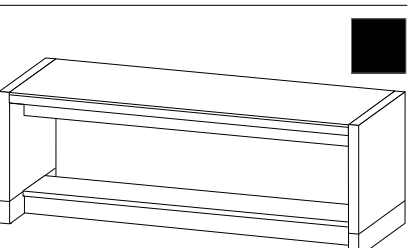
	No Base Wire Management	Base Wire Management	Base Wire Management + Floor Chase
No Plinth	 <p>Veneer Wood BWWWMN + \$0</p>	 <p>Veneer Wood + Wire Management BWWWMY + \$0</p>	 <p>Veneer Wood + Floor Chase BWWFLC + \$1,500 (Widths - 60", 72", 84", 96") + \$2,065 (Widths - 108", 120", 144")</p>
Brushed Brass Plinth*	 <p>Veneer Wood + Brushed Brass Plinth BBRWMN +2,065 For all widths.</p>	 <p>Veneer Wood + Brushed Brass Plinth + Wire Management BBRWMY +2,065 For all widths.</p>	 <p>Veneer Wood + Brushed Brass Plinth + Floor Chase BBRFLC + \$3,565 (Widths - 60", 72", 84", 96") + \$4,265 (Widths - 108", 120", 144")</p>
Brushed Nickel Plinth*	 <p>Veneer Wood + Brushed Nickel Plinth BNKWMN +2,065 For all widths.</p>	 <p>Veneer Wood + Nickel Plinth + Wire Management BNKWMY +2,065 For all widths.</p>	 <p>Veneer Wood + Brushed Nickel Plinth + Floor Chase BNKFLC + \$3,565 (Widths - 60", 72", 84", 96") + \$4,265 (Widths - 108", 120", 144")</p>
Brushed Black Plinth*	 <p>Veneer Wood + Brushed Black Plinth BBLWMN +2,065 For all widths.</p>	 <p>Veneer Wood + Brushed Black Plinth + Wire Management BBLWMY +2,065 For all widths.</p>	 <p>Veneer Wood + Brushed Black Plinth + Floor Chase BBLFLC + \$3,565 (Widths - 60", 72", 84", 96") + \$4,265 (Widths - 108", 120", 144")</p>

*For tables with three bases, the metal plinth is not applied to the center base.

Power Rail

The Firma table collection offers a variety of wire management options. A stretcher rail underneath the table can house undermount power, with easy-to-remove dust cover—no tools required. The optional floor chase conceals floorcore power sources and optional discreet cord cutouts are available in table base for wire management.

Hard-Wired Two Base Table

60", 72", 84", and 96" Wide Tables

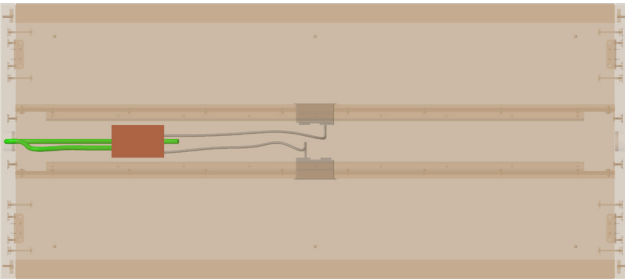
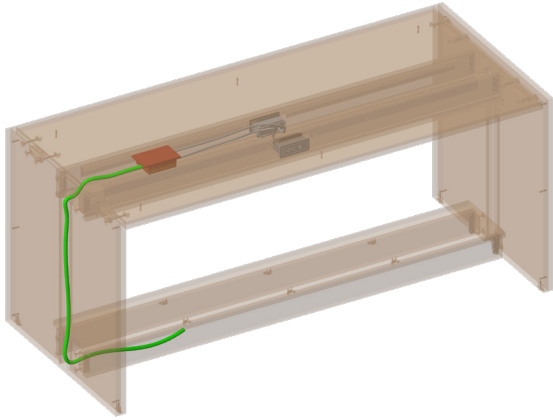

Firma model shown:

- Dimensions: 42" H x 42" W x 96" L
- Model Number: HCFRM23E42H4296-W1
- Base Type: BWWFLC
 - See page 23 for base type specifications
 - The power module cutout on the power rail is always centered between bases.
- Integrated Power Module Model Number (2): HVFRM23DUOBZL-EEU-HW
 - See page 30 for Integrated Power Module specifications
 - Please note that Integrated Power Modules must be ordered separately, see page 43.
- For hard-wired Integrated Power Rail Power Modules, you do not need to order an Internal Power Cable Kit.

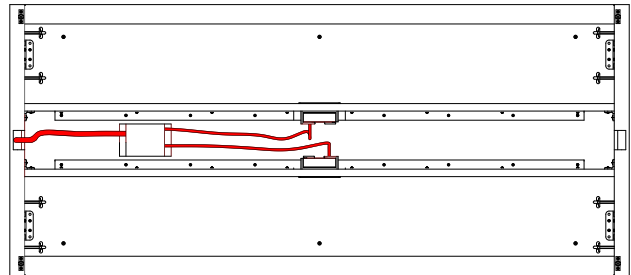

Hard-Wired Three Base Table

108", 120", and 144" Wide Tables

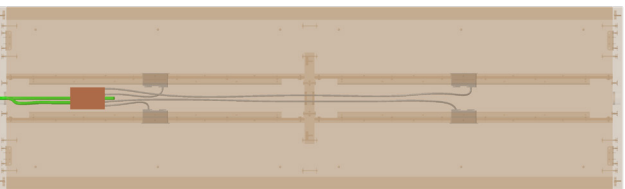
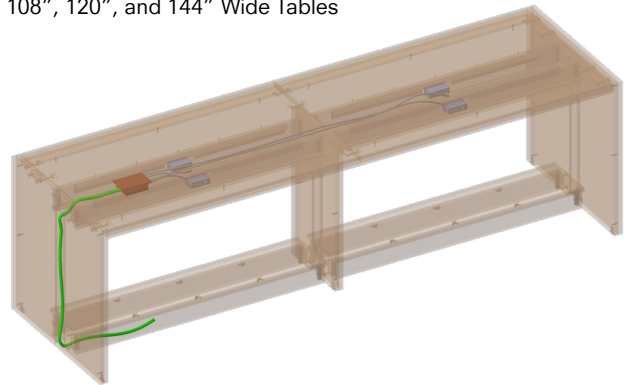

Firma model shown:

- Dimensions: 42" H x 42" W x 144" L
- Model Number: HCFRM23E42H42144-W2
- Base Type: BWWFLC
 - See page 23 for base type specifications
 - The power module cutout on the power rail is always centered between bases.
- Integrated Power Module Model Number (4): HVFRM23DUOBZL-EEU-HW
 - See page 30 for Integrated Power Module specifications
 - Please note that Integrated Power Modules must be ordered separately, see page 43.
- For hard-wired Integrated Power Rail Power Modules, you do not need to order an Internal Power Cable Kit.

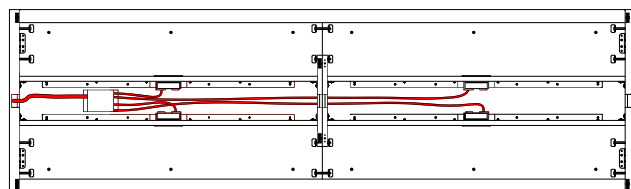

Power Rail

The Firma table collection offers a variety of wire management options. A stretcher rail underneath the table can house undermount power, with easy-to-remove dust cover—no tools required. The optional floor chase conceals floorcore power sources and optional discreet cord cutouts are available in table base for wire management.

Soft-Wired Two Base Table

60", 72", 84", and 96" Wide Tables

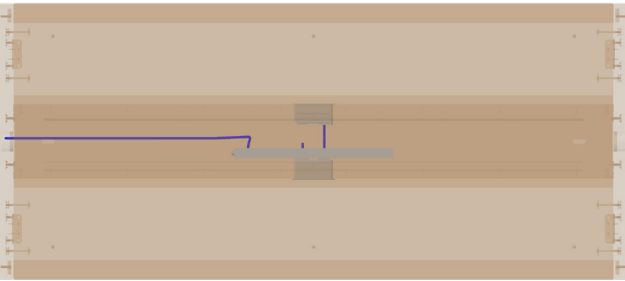
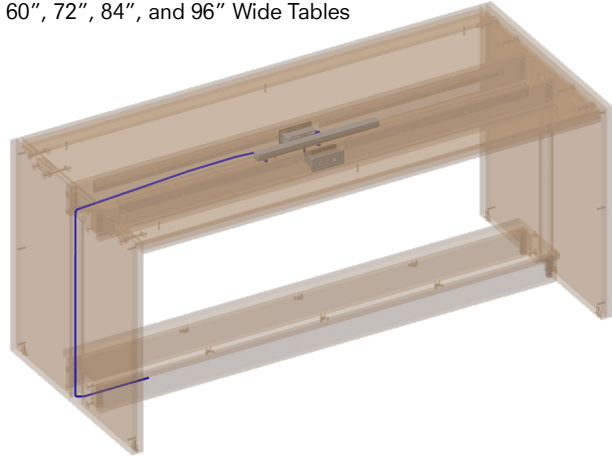

Firma model shown:

- Dimensions: 42"H x 42"W x 96"L
- Model Number: HCFRM23E42H4296-W1
- Base Type: BWWFLC
 - See page 23 for base type specifications
 - The power module cutout on the power rail is always centered between bases.
- Integrated Power Module Model Number (2): HVFRM23DUOBZL-EEU
 - See page 30 for Integrated Power Module specifications
 - Please note that Integrated Power Modules must be ordered separately, see page 43.
- Internal Power Cable Kit Model Number (1): HVFRM23-PWRSTRP
 - See page 31 for Internal Power Cable Kit specifications
 - Please note that Internal Power Cable Kits must be ordered separately, see page 44.

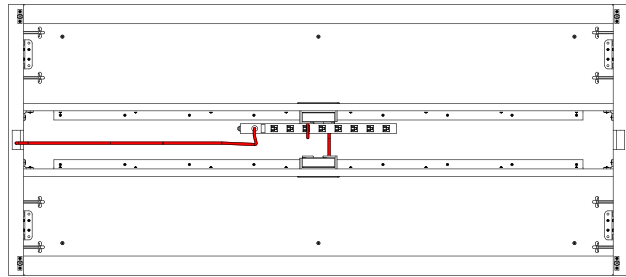

Soft-Wired Three Base Table

108", 120", and 144" Wide Tables

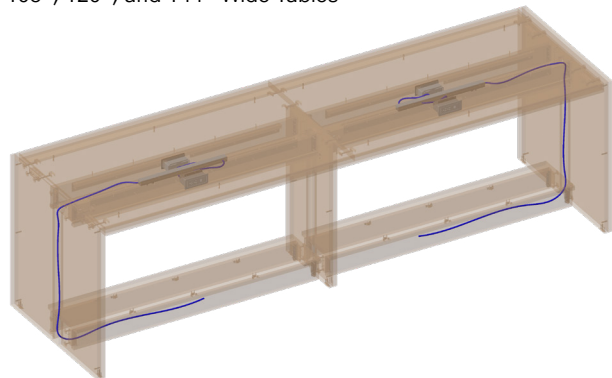

Firma model shown:

- Dimensions: 42"H x 42"W x 144"L
- Model Number: HCFRM23E42H42144-W2
- Base Type: BWWFLC
 - See page 23 for base type specifications
 - The power module cutout on the power rail is always centered between bases.
- Integrated Power Module Model Number (4): HVFRM23DUOBZL-EEU
 - See page 30 for Integrated Power Module specifications
 - Please note that Integrated Power Modules must be ordered separately, see page 43.
- Internal Power Cable Kit Model Number (2): HVFRM23-PWRSTRP
 - See page 31 for Internal Power Cable Kit specifications
 - Please note that Internal Power Cable Kits must be ordered separately, see page 44.

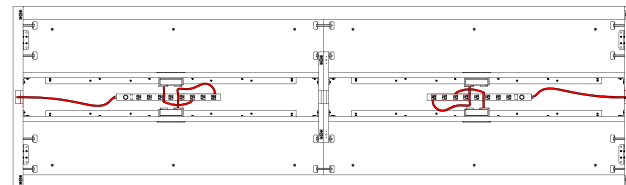

Juniper Shared Task Lamp + Power System*

The Firma table collection offers a variety of wire management options. A stretcher rail underneath the table can house undermount power, with easy-to-remove dust cover—no tools required. The optional floor chase to conceal floorcore power sources and discreet cord cutouts available in table base for wire management.

Hard-Wired Two Base Table

60", 72", 84", and 96" Wide Tables

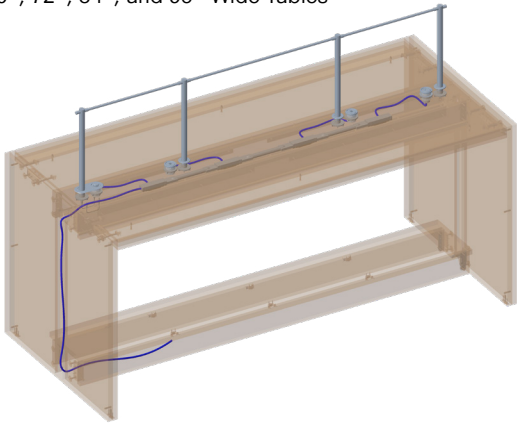

Firma model shown:

- Dimensions: 42"H x 42"W x 96"L
- Model Number: HCFRM23E42H4296-W1
- Base Type: BWWFLC
 - See page 23 for base type specifications
- Juniper Power System Model Number (1): HAFRM23-LGHT96W
 - See pages 32-35 for Juniper Power System specifications
 - Please note that Juniper Power System Kits must be ordered separately, see page 45.
 - Color temperature is 3,000 K
- Internal Power Cable Kit Model Number (1): HVFRM23-HDWIRE2BSE
 - See page 31 for Internal Power Cable Kit specifications
 - Please note that Internal Power Cable Kits must be ordered separately, see page 44.

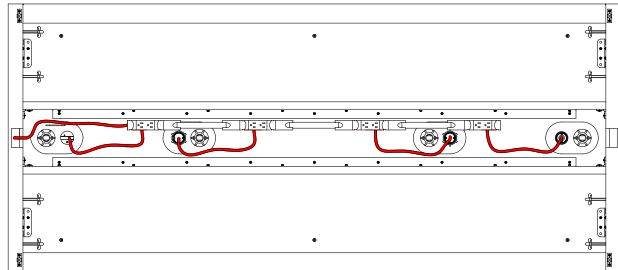
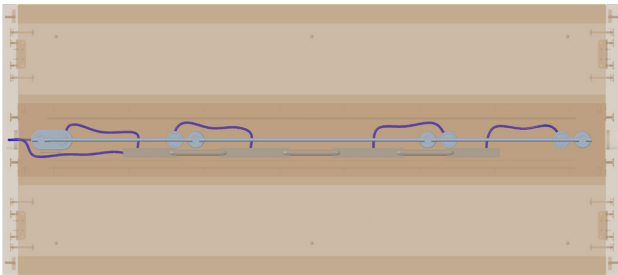

Hard-Wired Three Base Table

108", 120", and 144" Wide Tables

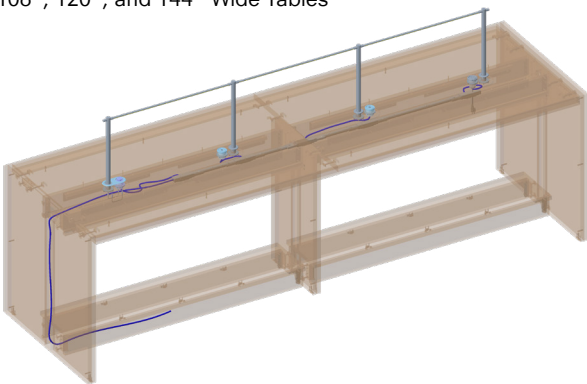

Firma model shown:

- Dimensions: 42"H x 42"W x 144"L
- Model Number: HCFRM23E42H42144-W2
- Base Type: BWWFLC
 - See page 23 for base type specifications
- Juniper Power System Model Number (1): HAFRM23-LGHT144W
 - See pages 32-35 for Juniper Power System specifications
 - Please note that Juniper Power System Kits must be ordered separately, see page 45.
 - Color temperature is 3,000 K
- Internal Power Cable Kit Model Number (2): HVFRM23-HDWIRE3BSE
 - See page 31 for Internal Power Cable Kit specifications
 - Please note that Internal Power Cable Kits must be ordered separately, see page 44.

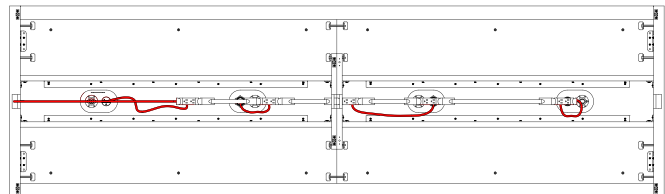
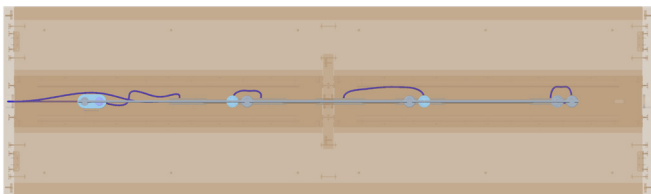

*Juniper Power System is not available with glass tabletops.

Juniper Shared Task Lamp + Power System*

The Firma table collection offers a variety of wire management options. A stretcher rail underneath the table can house undermount power, with easy-to-remove dust cover—no tools required. The optional floor chase to conceal floorcore power sources and discreet cord cutouts available in table base for wire management.

Soft-Wired Two Base Table

60", 72", 84", and 96" Wide Tables

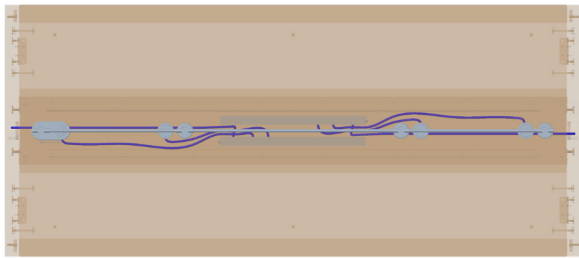
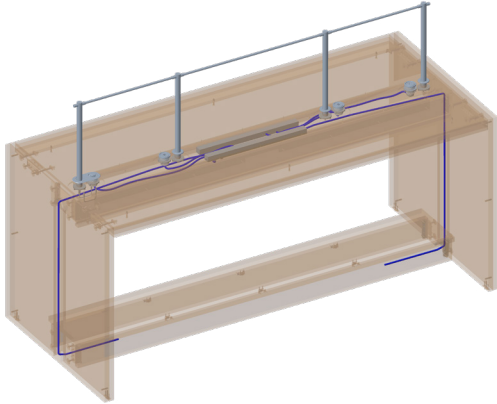

Firma model shown:

- Dimensions: 42"H x 42"W x 96"L
- Model Number: HCFRM23E42H4296-W1
- Base Type: BWWFLC
 - See page 23 for base type specifications
- Juniper Power System Model Number (1): HAFRM23-LGHT96W
 - See pages 32-35 for Juniper Power System specifications
 - Please note that Juniper Power System Kits must be ordered separately, see page 45.
 - Color temperature is 3,000 K
- Internal Power Cable Kit Model Number (2): HVFRM23-PWRSTRP
 - See page 31 for Internal Power Cable Kit specifications
 - Please note that Internal Power Cable Kits must be ordered separately, see page 44.

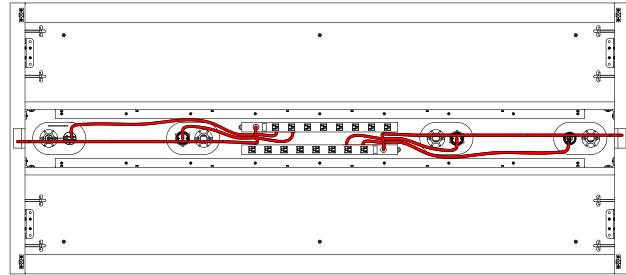

Soft-Wired Three Base Table

108", 120", and 144" Wide Tables

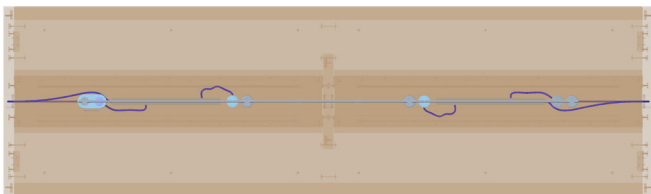
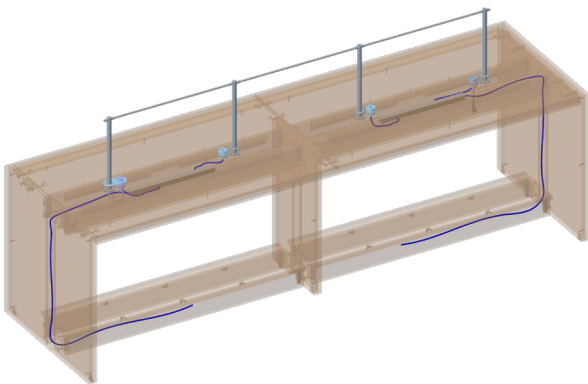

Firma model shown:

- Dimensions: 42"H x 42"W x 144"L
- Model Number: HCFRM23E42H42144-W2
- Base Type: BWWFLC
 - See page 23 for base type specifications
- Juniper Power System Model Number (1): HAFRM23-LGHT144W
 - See pages 32-35 for Juniper Power System specifications
 - Please note that Juniper Power System Kits must be ordered separately, see page 45.
 - Color temperature is 3,000 K
- Internal Power Cable Kit Model Number (2): HVFRM23-PWRSTRP
 - See page 31 for Internal Power Cable Kit specifications
 - Please note that Internal Power Cable Kits must be ordered separately, see page 44.

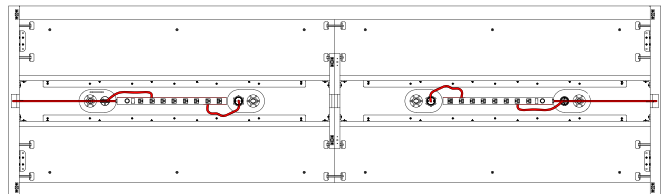

*Juniper Power System is not available with glass tabletops.

Power Rail and Juniper Shared Task Lamp + Power System*

The Firma table collection offers a variety of wire management options. A stretcher rail underneath the table can house undermount power, with easy-to-remove dust cover—no tools required. The optional floor chase to conceal floorcore power sources and discreet cord cutouts available in table base for wire management.

Hard-Wired Two Base Table

60", 72", 84", and 96" Wide Tables

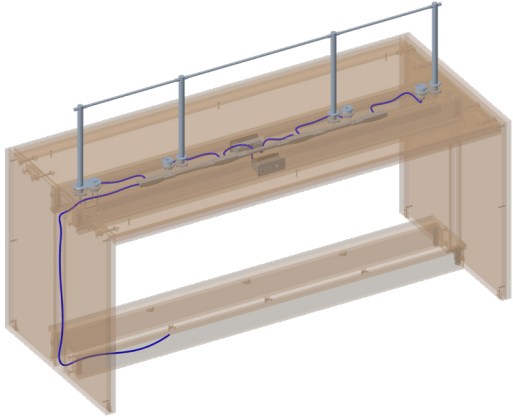

Firma model shown:

- Dimensions: 42"H x 42"W x 96"L
- Model Number: HCFRM23E42H4296-W1
- Base Type: BWWFLC
 - See page 23 for base type specifications
- Integrated Power Module Model Number (2): HVFRM23DUOBZL-EEU-HW
 - See page 30 for Integrated Power Module specifications
 - Please note that Integrated Power Modules must be ordered separately, see page 43.
- Juniper Power System Model Number (1): HAFRM23-LGHT96W
 - See pages 32-35 for Juniper Power System specifications
 - Please note that Juniper Power System Kits must be ordered separately, see page 45.
 - Color temperature is 3,000 K
- Internal Power Cable Kit Model Number (1): HVFRM23-HDWIRE2BSE
 - See page 31 for Internal Power Cable Kit specifications
 - Please note that Internal Power Cable Kits must be ordered separately, see page 44.
- For hard-wired Integrated Power Rail Power Modules, you do not need to order an Internal Power Cable Kit.

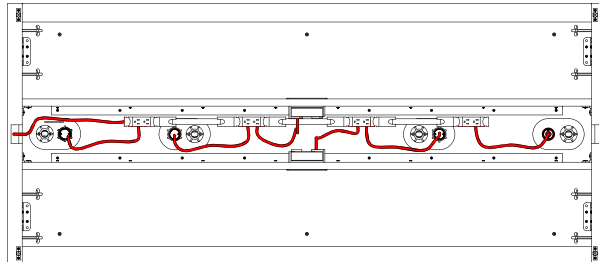
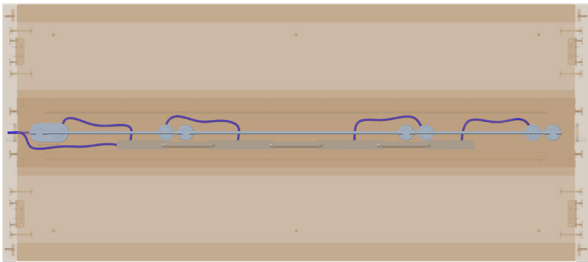

Hard-Wired Three Base Table

108", 120", and 144" Wide Tables

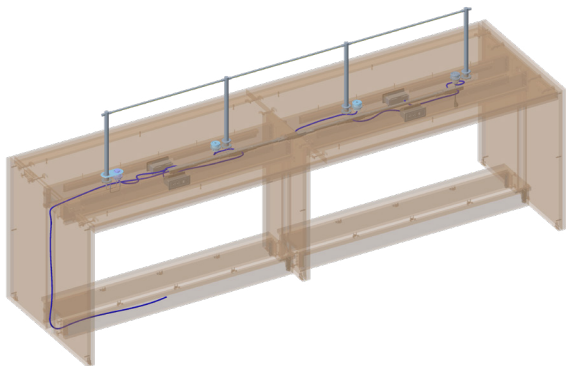

Firma model shown:

- Dimensions: 42"H x 42"W x 144"L
- Model Number: HCFRM23E42H42144-W2
- Base Type: BWWFLC
 - See page 23 for base type specifications
- Integrated Power Module Model Number (4): HVFRM23DUOBZL-EEU-HW
 - See page 30 for Integrated Power Module specifications
 - Please note that Integrated Power Modules must be ordered separately, see page 43.
- Juniper Power System Model Number (1): HAFRM23-LGHT144W
 - See pages 32-35 for Juniper Power System specifications
 - Please note that Juniper Power System Kits must be ordered separately, see page 45.
 - Color temperature is 3,000 K
- Internal Power Cable Kit Model Number (2): HVFRM23-HDWIRE3BSE
 - See page 31 for Internal Power Cable Kit specifications
 - Please note that Internal Power Cable Kits must be ordered separately, see page 44.
- For hard-wired Integrated Power Rail Power Modules, you do not need to order an Internal Power Cable Kit.

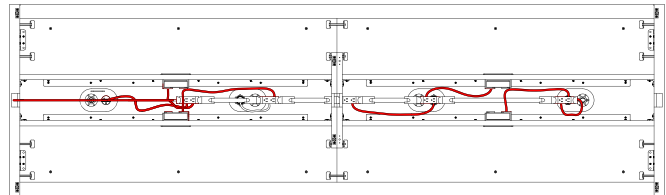
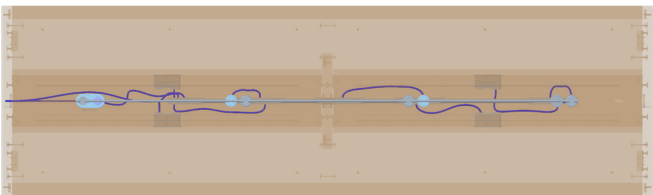

*Juniper Power System is not available with glass tabletops.

Power Rail and Juniper Shared Task Lamp + Power System*

The Firma table collection offers a variety of wire management options. A stretcher rail underneath the table can house undermount power, with easy-to-remove dust cover—no tools required. The optional floor chase to conceal floorcore power sources and discreet cord cutouts available in table base for wire management.

Soft-Wired Two Base Table
60", 72", 84", and 96" Wide Tables

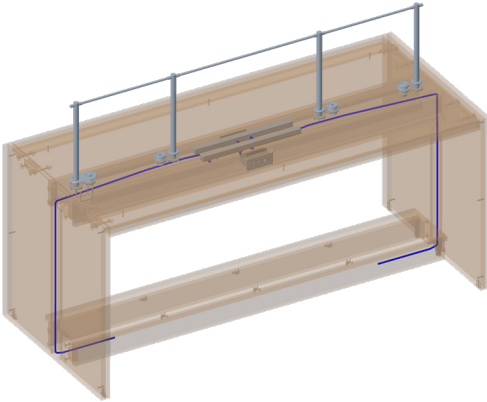

Firma model shown:

- Dimensions: 42"H x 42"W x 96"L
- Model Number: HCFRM23E42H4296-W1
- Base Type: BWWFLC
 - See page 23 for base type specifications
- Integrated Power Module Model Number (2): HVFRM23DUOBZL-EEU
 - See page 30 for Integrated Power Module specifications
 - Please note that Integrated Power Modules must be ordered separately, see page 43.
- Juniper Power System Model Number (1): HAFRM23-LGHT96W
 - See pages 32-35 for Juniper Power System specifications
 - Please note that Juniper Power System Kits must be ordered separately, see page 45.
 - Color temperature is 3,000 K
- Internal Power Cable Kit Model Number (2): HVFRM23-PWRSTRP
 - See page 31 for Internal Power Cable Kit specifications
 - Please note that Internal Power Cable Kits must be ordered separately, see page 44.

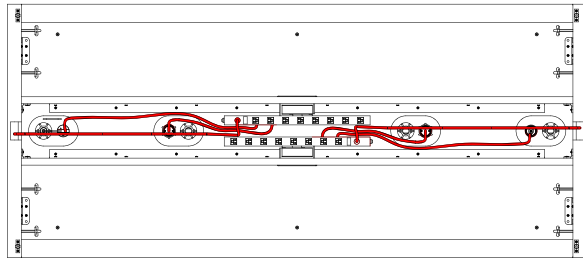
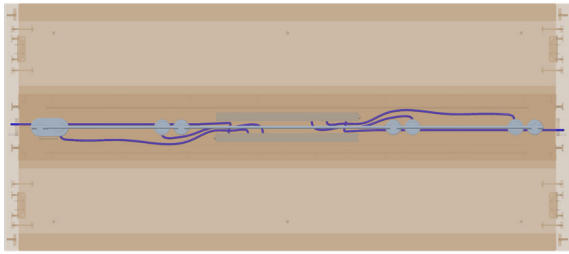

Soft-Wired Three Base Table
108", 120", and 144" Wide Tables

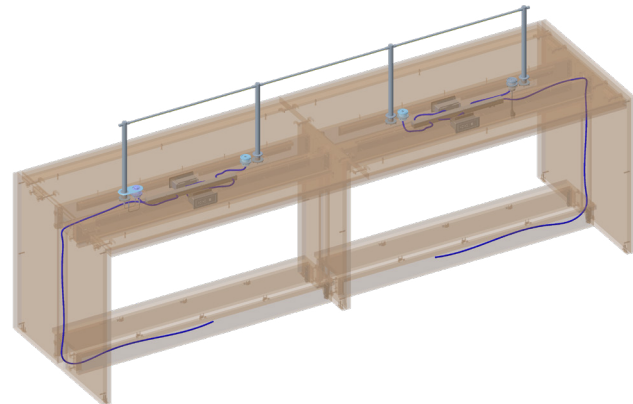

Firma model shown:

- Dimensions: 42"H x 42"W x 144"L
- Model Number: HCFRM23E42H42144-W2
- Base Type: BWWFLC
 - See page 23 for base type specifications
- Integrated Power Module Model Number (4): HVFRM23DUOBZL-EEU-HW
 - See page 30 for Integrated Power Module specifications
 - Please note that Integrated Power Modules must be ordered separately, see page 43.
- Juniper Power System Model Number (1): HAFRM23-LGHT144W
 - See pages 32-35 for Juniper Power System specifications
 - Please note that Juniper Power System Kits must be ordered separately, see page 45.
 - Color temperature is 3,000 K
- Internal Power Cable Kit Model Number (2): HVFRM23-PWRSTRP
 - See page 31 for Internal Power Cable Kit specifications
 - Please note that Internal Power Cable Kits must be ordered separately, see page 44.

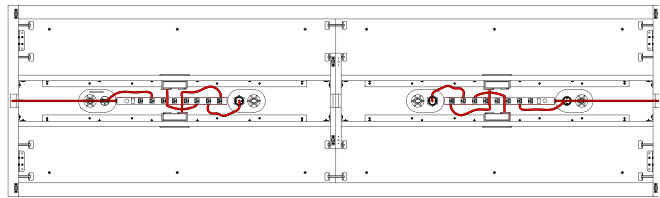
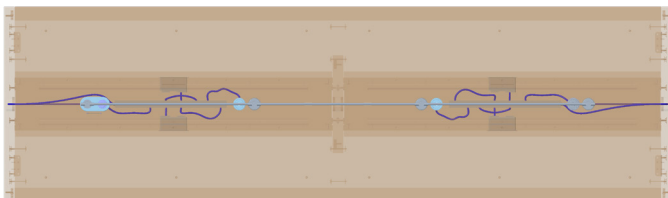

*Juniper Power System is not available with glass tabletops.

Integrated Power Rail Power Modules

Hard-Wired

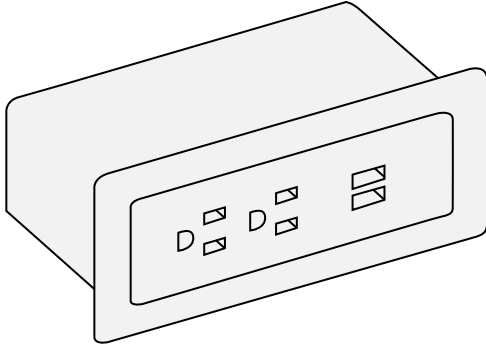

Model Number: HVFRM23DUOBZL-EEU-HW

Dimensions:

- 2 3/4" D x 4 1/8" W x 1 3/4" H

Power Outlet Types:

- Two USB-A
- Two Simplex Receptacles

Notes:

Integrated Power Modules need to be ordered separately. See page 43.

Finishes



White
WH



Silver
SV



Black
BK

Soft-Wired

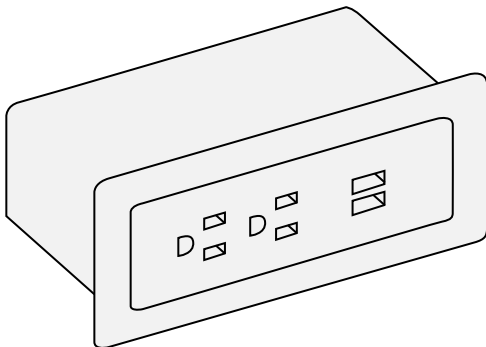

Model Number: HVFRM23DUOBZL-EEU

Dimensions:

- 2 3/4" D x 4 1/8" W x 1 3/4" H

Power Outlet Types:

- Two USB-A
- Two Simplex Receptacles

Notes:

Integrated Power Modules need to be ordered separately. See page 43.

Finishes



White
WH

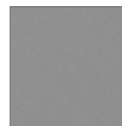

Silver
SV

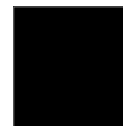

Black
BK

Internal Power Cable Kits

Hard-Wired



For use with two base tables.

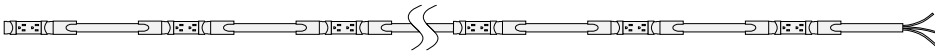

For use with three base tables.

Model Numbers:

- HVFRM23-HDWIRE2BSE (Two Base Table)
- HVFRM23-HDWIRE3BSE (Three Base Table)

Description:

- Not needed for integrated power rail power modules.
- Accessible through the dustcover on the undermounted power rail.

Notes:

Internal Power Cable Kits need to be ordered separately. See page 44.

Soft-Wired

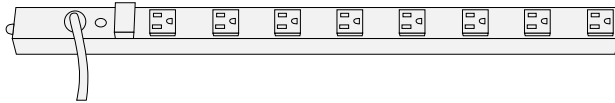

Model Number:

- HVFRM23-PWRSTRP

Description:

- Eight standard duplex receptacles
- Accessible through the dustcover on the undermounted power rail.

Notes:

Internal Power Cable Kits need to be ordered separately. See page 44.



60" Juniper Shared Task Lamp + Power System Kit

Model Number: HAfrm23-LGHT60W

Finishes:

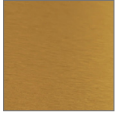

Satin Brass
SBR



Satin Nickel
SNI



Black Oxide
BLOX

Color Temperature:

- 3,000 K

Power Outlet(s):

- One simplex receptacle

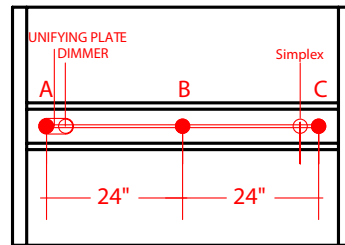
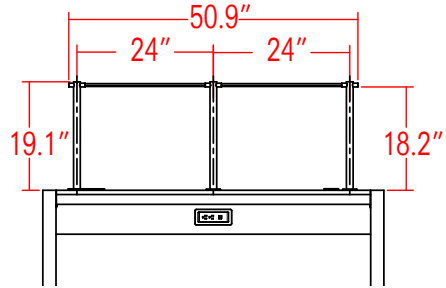

72" Juniper Shared Task Lamp + Power System Kit

Model Number: HAfrm23-LGHT72W

Finishes:



Satin Brass
SBR



Satin Nickel
SNI



Black Oxide
BLOX

Color Temperature:

- 3,000 K

Power Outlet(s):

- One simplex receptacle

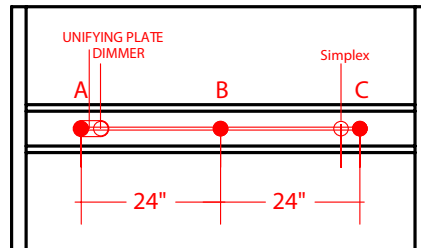
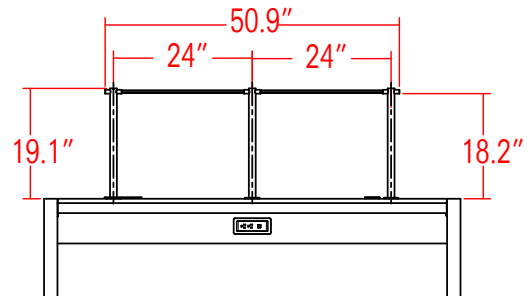

84" Juniper Shared Task Lamp + Power System Kit

Model Number: HAFRM23-LGHT84W

Finishes:



Color Temperature:

- 3,000 K

Power Outlet(s):

- One simplex receptacle

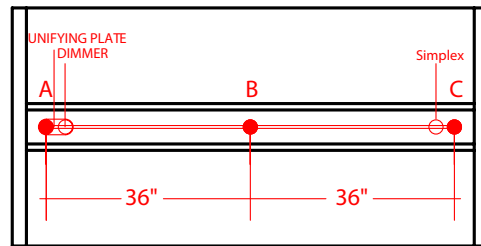
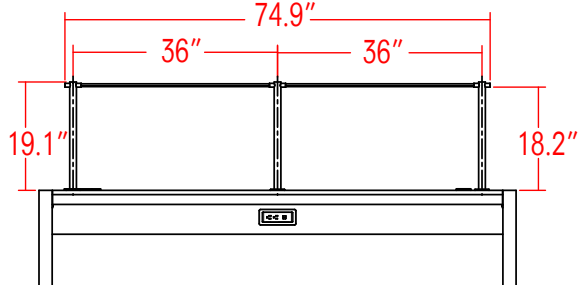

96" Juniper Shared Task Lamp + Power System Kit

Model Number: HAFRM23-LGHT96W

Finishes:

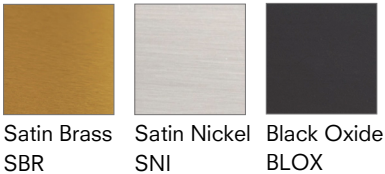

Color Temperature:

- 3,000 K

Power Outlet(s):

- One simplex receptacle
- Four USB-A receptacles

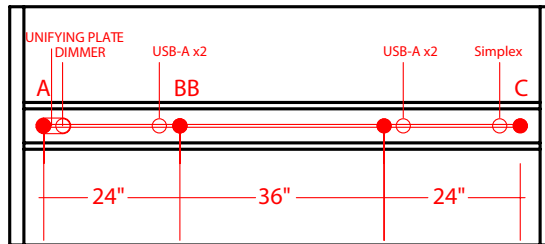
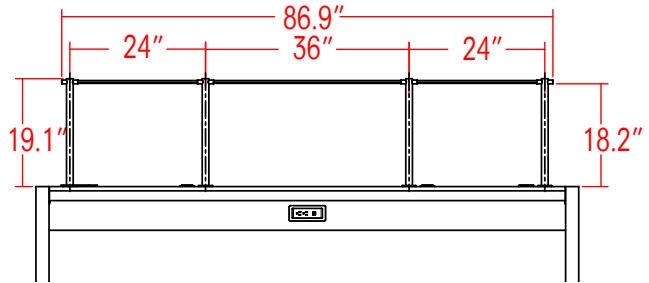

108" Juniper Shared Task Lamp + Power System Kit

Model Number: HAFRM23-LGHT108W

Finishes:

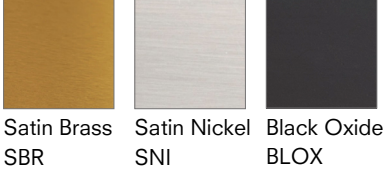

Color Temperature:

- 3,000 K

Power Outlet(s):

- One simplex receptacle
- Four USB-A receptacles

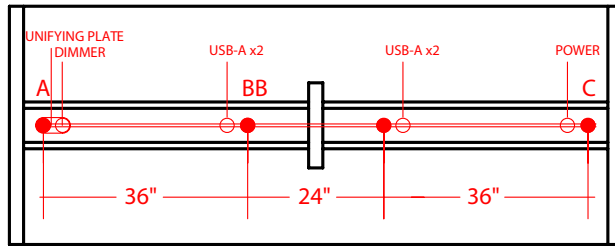
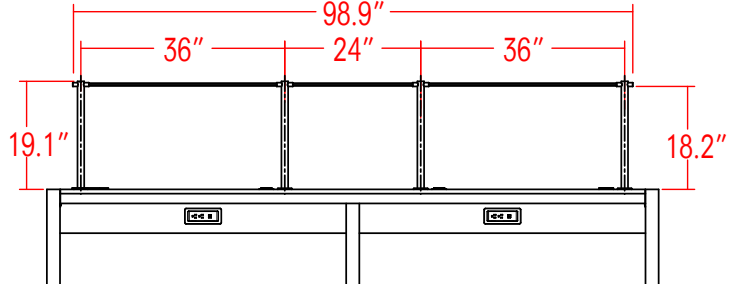

120" Juniper Shared Task Lamp + Power System Kit

Model Number: HAFRM23-LGHT120W

Finishes:

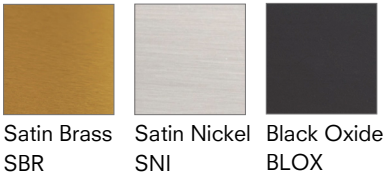

Color Temperature:

- 3,000 K

Power Outlet(s):

- One simplex receptacle
- Four USB-A receptacles

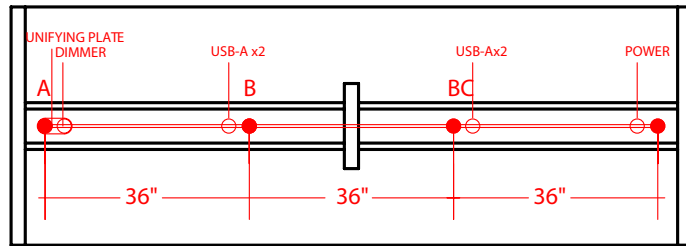
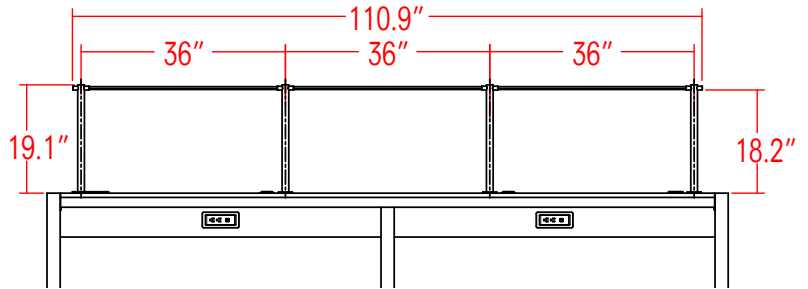

144" Juniper Shared Task Lamp + Power System Kit

Model Number: HAfrm23-LGHT144W

Finishes:



Satin Brass
SBR



Satin Nickel
SNI



Black Oxide
BLOX

Color Temperature:

- 3,000 K

Power Outlet(s):

- One simplex receptacle
- Four USB-A receptacles

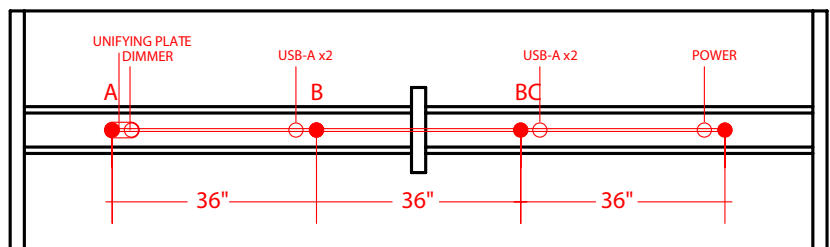
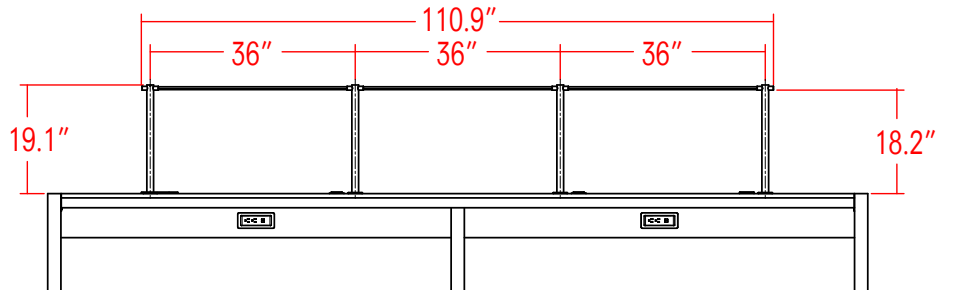

Side Table

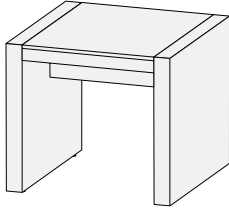

Tabletop Material		L - Laminate W - Wood Veneer G - Glass			S - Solid Surface Q - Engineered Quartz			
Choose material and number of pieces:								
Model Number	H	D	W	L	W	G	S	Q
HTFRM23S21H2424-	21	24	24	3,835	4,035	6,055	5,730	7,920

Coffee Tables

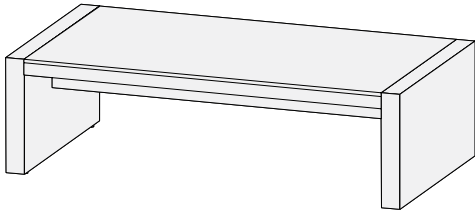

Model Number	H	D	W	L	W	G	S	Q
HTFRM23E16H3056-	16	30	56	5,230	5,505	8,260	8,335	11,295
HTFRM23S16H4242-	16	42	42	5,230	5,505	8,260	8,555	12,540

Model Number	Tabletop	FSC	Base Finish	Tabletop Material
See Above (17 Characters)	See above (1 Characters)	No - X Yes - F	See Page 15 Base finish determines veneer tabletop selection. Other materials chosen in "Tabletop Material" section.	See Page 16 (1-4 Characters) Disregard this section if tabletop is wood veneer or COM.
_ _ _ _ _ _ _ _ _ _ _ _ _ _ _ _ _	_	_	_ _ _ _ _ _ _ _ _ _ _ _ _ _ _ _ _	_ _ _

Specification Code Example: HCFRM23E30H30108-L.F.RF301-OP20.LM16

Console Tables

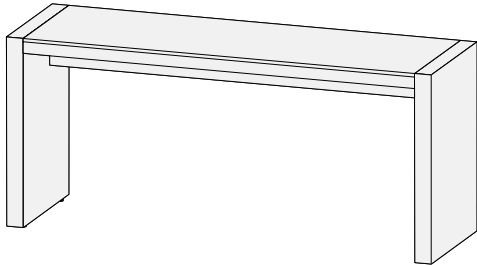

Tabletop Material		L - Laminate W - Wood Veneer G - Glass			S - Solid Surface Q - Engineered Quartz			
Choose material and number of pieces:								
Model Number	H	D	W	L	W	G	S	Q
HTFRM23E26H1860-	26	18	60	5,100	5,370	8,055	8,275	11,090
HTFRM23E26H1872-	26	18	72	5,180	5,450	8,175	8,375	11,210
HTFRM23E36H1860-	36	18	60	5,260	5,535	8,305	8,575	11,685
HTFRM23E36H1872-	36	18	72	5,335	5,615	8,425	8,675	11,805

Model Number	Tabletop	FSC	Base Finish	Tabletop Material
See Above (17 Characters)	See above (1 Characters)	No - X Yes - F	See Page 15 Base finish determines veneer tabletop selection. Other materials chosen in "Tabletop Material" section.	See Page 16 (1-4 Characters) Disregard this section if tabletop is wood veneer or COM.
_ _ _ _ _ _ _ _ _ _ _ _ _ _ _ _ _ _	_	_	_ _ _ _ _ _ _ _ _ _ _ _ _ _ _ _ _ _	_ _ _

Specification Code Example: HCFRM23E30H30108-L.F.RF301-OP20.LM16

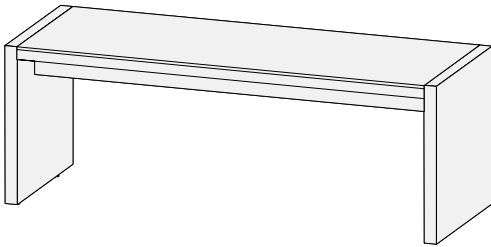

Tabletop Material
Choose material and number of pieces:

L - Laminate
W - Wood Veneer
G - Glass

S - Solid Surface
Q - Engineered Quartz

1 - One Piece
2 - Two Piece

Model Number	H	D	W	L1	W1	G1	S1	Q1	L2	W2	G2	S2	Q2
HCFRM23E30H3060-	30	30	60	9,700	10,210	15,315	12,765	19,910	-	-	-	-	-
HCFRM23E30H3072-	30	30	72	9,935	10,460	15,690	13,075	20,395	-	-	-	-	-
HCFRM23E30H3084-	30	30	84	10,645	11,205	16,810	14,005	21,850	-	-	-	-	-
HCFRM23E30H3096-	30	30	96	11,260	11,855	17,785	14,820	23,115	-	-	-	-	-
HCFRM23E30H30108-	30	30	108	-	12,665	-	-	-	12,330	13,300	21,850	18,205	28,400
HCFRM23E30H30120-	30	30	120	-	12,985	-	-	-	12,645	13,635	22,400	18,665	29,120
HCFRM23E30H30144-	30	30	144	-	-	-	-	-	13,280	14,315	23,525	19,600	30,580

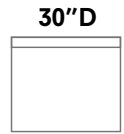

Model Number	H	D	W	L1	W1	G1	S1	Q1	L2	W2	G2	S2	Q2
HCFRM23E30H3660-	30	36	60	9,945	10,470	15,705	13,090	20,415	-	-	-	-	-
HCFRM23E30H3672-	30	36	72	10,185	10,720	16,080	13,400	20,905	-	-	-	-	-
HCFRM23E30H3684-	30	36	84	10,890	11,465	17,200	14,330	22,355	-	-	-	-	-
HCFRM23E30H3696-	30	36	96	11,590	12,200	18,300	15,250	23,790	-	-	-	-	-
HCFRM23E30H36108-	30	36	108	-	13,005	-	-	-	12,665	13,655	22,435	18,695	29,165
HCFRM23E30H36120-	30	36	120	-	13,325	-	-	-	12,975	13,990	22,990	19,155	29,885
HCFRM23E30H36144-	30	36	144	-	-	-	-	-	13,620	14,690	24,135	20,115	31,370

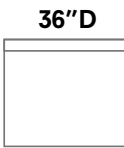

Model Number	H	D	W	L1	W1	G1	S1	Q1	L2	W2	G2	S2	Q2
HCFRM23E30H4260-	30	42	60	10,195	10,730	16,095	13,415	20,925	-	-	-	-	-
HCFRM23E30H4272-	30	42	72	10,430	10,980	16,470	13,725	21,410	-	-	-	-	-
HCFRM23E30H4284-	30	42	84	11,140	11,725	17,590	14,655	22,865	-	-	-	-	-
HCFRM23E30H4296-	30	42	96	12,080	12,715	19,075	15,895	24,795	-	-	-	-	-
HCFRM23E30H42108-	30	42	108	-	13,530	-	-	-	13,175	14,205	23,340	19,450	30,345
HCFRM23E30H42120-	30	42	120	-	13,850	-	-	-	13,490	14,545	23,890	19,910	31,060
HCFRM23E30H42144-	30	42	144	-	-	-	-	-	14,165	15,270	25,095	20,905	32,620

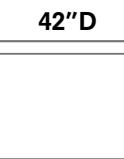

Model Number	Tabletop	FSC	Base Finish	Base Type	Power Rail Module	Tabletop Material	Cutout
See Above (16-17 Characters)	See above (2 Characters)	No - X Yes - F	See Page 15 Base finish determines wood veneer tabletop selection. Other materials chosen in "Tabletop Material" section.	See Page 23	No - PRN Yes - PRY If PRY selected, see page 30 to select power module.	See Page 16 (1-4 Characters) Disregard this section if tabletop is wood veneer or COM.	No - GN Yes - LT1 (2-3 Characters) If LT1 selected, see page 32-35 to select lighting. Not available on glass tabletops.

Specification Code Example: HCFRM23E30H30108-L2.F.RF301-OP20.BWWWMN.PRN.LM16.LT1

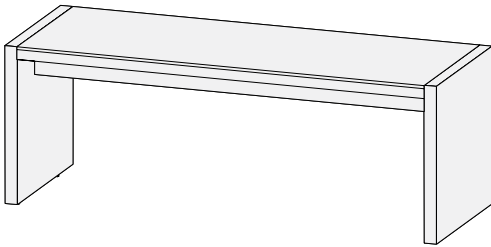

Tabletop Material
Choose material and number of pieces:

L - Laminate
W - Wood Veneer
G - Glass

S - Solid Surface
Q - Engineered Quartz

1 - One Piece
2 - Two Piece

Model Number	H	D	W	L1	W1	G1	S1	Q1	L2	W2	G2	S2	Q2
HCFRM23E34H3060-	34	30	60	10,110	10,640	15,960	13,300	20,750	-	-	-	-	-
HCFRM23E34H3072-	34	30	72	10,345	10,890	16,335	13,615	21,235	-	-	-	-	-
HCFRM23E34H3084-	34	30	84	11,060	11,640	17,460	14,550	22,700	-	-	-	-	-
HCFRM23E34H3096-	34	30	96	11,750	12,370	18,555	15,465	24,120	-	-	-	-	-
HCFRM23E34H30108-	34	30	108	-	13,215	-	-	-	12,870	13,875	22,800	19,000	29,635
HCFRM23E34H30120-	34	30	120	-	13,500	-	-	-	13,145	14,135	23,290	19,405	30,275
HCFRM23E34H30144-	34	30	144	-	-	-	-	-	13,800	14,885	24,455	20,380	31,785

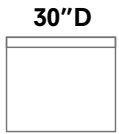

Model Number	H	D	W	L1	W1	G1	S1	Q1	L2	W2	G2	S2	Q2
HCFRM23E34H3660-	34	36	60	10,110	10,640	15,960	13,300	20,750	-	-	-	-	-
HCFRM23E34H3672-	34	36	72	10,345	10,890	16,335	13,615	21,235	-	-	-	-	-
HCFRM23E34H3684-	34	36	84	11,060	11,640	17,460	14,550	22,700	-	-	-	-	-
HCFRM23E34H3696-	34	36	96	11,750	12,370	18,555	15,465	24,120	-	-	-	-	-
HCFRM23E34H36108-	34	36	108	-	13,180	-	-	-	12,835	13,840	22,735	18,945	29,555
HCFRM23E34H36120-	34	36	120	-	13,500	-	-	-	13,145	14,175	23,290	19,405	30,275
HCFRM23E34H36144-	34	36	144	-	-	-	-	-	13,800	14,885	24,455	20,380	31,785

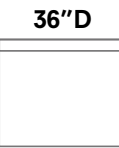

Model Number	H	D	W	L1	W1	G1	S1	Q1	L2	W2	G2	S2	Q2
HCFRM23E34H4260-	34	42	60	10,355	10,900	16,350	13,625	21,255	-	-	-	-	-
HCFRM23E34H4272-	34	42	72	10,595	11,150	16,725	13,940	21,745	-	-	-	-	-
HCFRM23E34H4284-	34	42	84	11,300	11,895	17,845	14,870	23,195	-	-	-	-	-
HCFRM23E34H4296-	34	42	96	12,240	12,885	19,330	16,105	25,125	-	-	-	-	-
HCFRM23E34H42108-	34	42	108	-	13,700	-	-	-	13,340	14,385	23,630	19,695	30,720
HCFRM23E34H42120-	34	42	120	-	14,020	-	-	-	13,655	14,720	24,185	20,155	31,440
HCFRM23E34H42144-	34	42	144	-	-	-	-	-	14,335	15,455	25,390	21,160	33,010

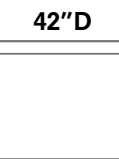

Model Number	Tabletop	FSC	Base Finish	Base Type	Power Rail Module	Tabletop Material	Cutout
See Above (16-17 Characters)	See above (2 Characters)	No - X Yes - F	See Page 15 Base finish determines wood veneer tabletop selection. Other materials chosen in "Tabletop Material" section.	See Page 23	No - PRN Yes - PRY If PRY selected, see page 30 to select power module.	See Page 16 (1-4 Characters) Disregard this section if tabletop is wood veneer or COM.	No - GN Yes - LT1 (2-3 Characters) If LT1 selected, see page 32-35 to select lighting. Not available on glass tabletops.

Specification Code Example: HCFRM23E30H30108-L2.F.RF301-OP20.BWWWMN.PRN.LM16.LT1

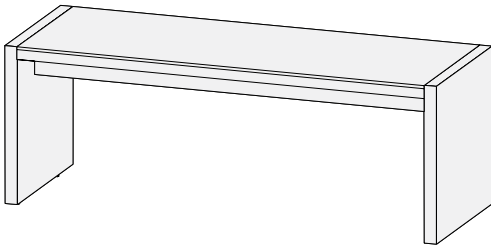

Tabletop Material
Choose material and number of pieces:

L - Laminate
W - Wood Veneer
G - Glass

S - Solid Surface
Q - Engineered Quartz

1 - One Piece
2 - Two Piece

Model Number	H	D	W	L1	W1	G1	S1	Q1	L2	W2	G2	S2	Q2
HCFRM23E36H3060-	36	30	60	10,110	10,640	15,960	13,300	20,750	-	-	-	-	-
HCFRM23E36H3072-	36	30	72	10,345	10,890	16,335	13,615	21,235	-	-	-	-	-
HCFRM23E36H3084-	36	30	84	11,060	11,640	17,460	14,550	22,700	-	-	-	-	-
HCFRM23E36H3096-	36	30	96	11,750	12,370	18,555	15,465	24,120	-	-	-	-	-
HCFRM23E36H30108-	36	30	108	-	13,215	-	-	-	12,870	13,875	22,800	19,000	29,635
HCFRM23E36H30120-	36	30	120	-	13,500	-	-	-	13,145	14,135	23,290	19,405	30,275
HCFRM23E36H30144-	36	30	144	-	-	-	-	-	13,800	14,885	24,455	20,380	31,785

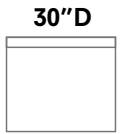

Model Number	H	D	W	L1	W1	G1	S1	Q1	L2	W2	G2	S2	Q2
HCFRM23E36H3660-	36	36	60	10,110	10,640	15,960	13,300	20,750	-	-	-	-	-
HCFRM23E36H3672-	36	36	72	10,345	10,890	16,335	13,615	21,235	-	-	-	-	-
HCFRM23E36H3684-	36	36	84	11,060	11,640	17,460	14,550	22,700	-	-	-	-	-
HCFRM23E36H3696-	36	36	96	11,750	12,370	18,555	15,465	24,120	-	-	-	-	-
HCFRM23E36H36108-	36	36	108	-	13,180	-	-	-	12,835	13,840	22,735	18,945	29,555
HCFRM23E36H36120-	36	36	120	-	13,500	-	-	-	13,145	14,175	23,290	19,405	30,275
HCFRM23E36H36144-	36	36	144	-	-	-	-	-	13,800	14,885	24,455	20,380	31,785



Model Number	H	D	W	L1	W1	G1	S1	Q1	L2	W2	G2	S2	Q2
HCFRM23E36H4260-	36	42	60	10,355	10,900	16,350	13,625	21,255	-	-	-	-	-
HCFRM23E36H4272-	36	42	72	10,595	11,150	16,725	13,940	21,745	-	-	-	-	-
HCFRM23E36H4284-	36	42	84	11,300	11,895	17,845	14,870	23,195	-	-	-	-	-
HCFRM23E36H4296-	36	42	96	12,240	12,885	19,330	16,105	25,125	-	-	-	-	-
HCFRM23E36H42108-	36	42	108	-	13,700	-	-	-	13,340	14,385	23,630	19,695	30,720
HCFRM23E36H42120-	36	42	120	-	14,020	-	-	-	13,655	14,720	24,185	20,155	31,440
HCFRM23E36H42144-	36	42	144	-	-	-	-	-	14,335	15,455	25,390	21,160	33,010

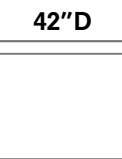

Model Number	Tabletop	FSC	Base Finish	Base Type	Power Rail Module	Tabletop Material	Cutout
See Above (16-17 Characters)	See above (2 Characters)	No - X Yes - F	See Page 15 Base finish determines wood veneer tabletop selection. Other materials chosen in "Tabletop Material" section.	See Page 23	No - PRN Yes - PRY If PRY selected, see page 30 to select power module.	See Page 16 (1-4 Characters) Disregard this section if tabletop is wood veneer or COM.	No - GN Yes - LT1 (2-3 Characters) If LT1 selected, see page 32-35 to select lighting. Not available on glass tabletops.

Specification Code Example: HCFRM23E30H30108-L2.F.RF301-OP20.BWWWMN.PRN.LM16.LT1

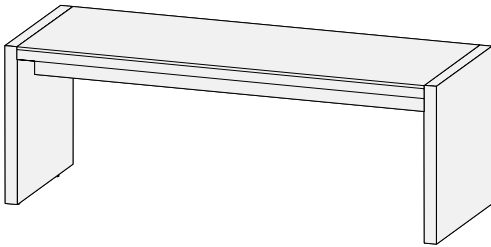

Tabletop Material
Choose material and number of pieces:

L - Laminate
W - Wood Veneer
G - Glass

S - Solid Surface
Q - Engineered Quartz

1 - One Piece
2 - Two Piece

Model Number	H	D	W	L1	W1	G1	S1	Q1	L2	W2	G2	S2	Q2
HCFRM23E42H3060-	42	30	60	10,025	10,555	15,835	13,195	20,580	-	-	-	-	-
HCFRM23E42H3072-	42	30	72	10,265	10,805	16,210	13,505	21,070	-	-	-	-	-
HCFRM23E42H3084-	42	30	84	10,975	11,550	17,325	14,440	22,525	-	-	-	-	-
HCFRM23E42H3096-	42	30	96	11,590	12,200	18,300	15,250	23,790	-	-	-	-	-
HCFRM23E42H30108-	42	30	108	-	13,005	-	-	-	12,665	13,655	22,435	18,695	29,165
HCFRM23E42H30120-	42	30	120	-	13,325	-	-	-	12,975	13,990	22,990	19,155	29,885
HCFRM23E42H30144-	42	30	144	-	-	-	-	-	13,620	14,690	24,135	20,115	31,370

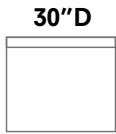

Model Number	H	D	W	L1	W1	G1	S1	Q1	L2	W2	G2	S2	Q2
HCFRM23E42H3660-	42	36	60	10,275	10,815	16,225	13,520	21,090	-	-	-	-	-
HCFRM23E42H3672-	42	36	72	10,510	11,065	16,600	13,830	21,575	-	-	-	-	-
HCFRM23E42H3684-	42	36	84	11,220	11,810	17,715	14,765	23,030	-	-	-	-	-
HCFRM23E42H3696-	42	36	96	11,920	12,545	18,820	15,680	24,465	-	-	-	-	-
HCFRM23E42H36108-	42	36	108	-	13,355	-	-	-	13,000	14,025	23,040	19,200	29,945
HCFRM23E42H36120-	42	36	120	-	13,675	-	-	-	13,315	14,360	23,590	19,660	30,665
HCFRM23E42H36144-	42	36	144	-	-	-	-	-	13,980	15,080	24,770	20,645	32,200

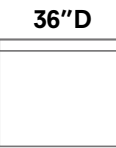

Model Number	H	D	W	L1	W1	G1	S1	Q1	L2	W2	G2	S2	Q2
HCFRM23E42H4260-	42	42	60	10,520	11,075	16,615	13,845	21,595	-	-	-	-	-
HCFRM23E42H4272-	42	42	72	10,755	11,320	16,980	14,150	22,075	-	-	-	-	-
HCFRM23E42H4284-	42	42	84	11,465	12,070	18,105	15,090	23,535	-	-	-	-	-
HCFRM23E42H4296-	42	42	96	12,405	13,060	19,590	16,325	25,465	-	-	-	-	-
HCFRM23E42H42108-	42	42	108	-	13,870	-	-	-	13,505	14,565	23,925	19,940	31,100
HCFRM23E42H42120-	42	42	120	-	14,190	-	-	-	13,815	14,900	24,480	20,400	31,820
HCFRM23E42H42144-	42	42	144	-	-	-	-	-	14,510	15,645	25,700	21,420	33,415

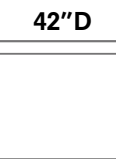

Model Number	Tabletop	FSC	Base Finish	Base Type	Power Rail Module	Tabletop Material	Cutout
See Above (16-17 Characters)	See above (2 Characters)	No - X Yes - F	See Page 15 Base finish determines wood veneer tabletop selection. Other materials chosen in "Tabletop Material" section.	See Page 23	No - PRN Yes - PRY If PRY selected, see page 30 to select power module.	See Page 16 (1-4 Characters) Disregard this section if tabletop is wood veneer or COM.	No - GN Yes - LT1 (2-3 Characters) If LT1 selected, see page 32-35 to select lighting. Not available on glass tabletops.

Specification Code Example: HCFRM23E30H30108-L2.F.RF301-OP20.BWWWMN.PRN.LM16.LT1



30"H														
Model Number	H	D	W	COM	Model Number	H	D	W	COM	Model Number	H	D	W	COM
HCFRM23-30H3060-Q	30	30	60	16,795	HCFRM23-30H3660-Q	30	36	60	17,250	HCFRM23-30H4260-Q	30	42	60	17,685
HCFRM23-30H3072-Q	30	30	72	17,210	HCFRM23-30H3672-Q	30	36	72	17,670	HCFRM23-30H4272-Q	30	42	72	18,100
HCFRM23-30H3084-Q	30	30	84	18,445	HCFRM23-30H3684-Q	30	36	84	18,900	HCFRM23-30H4284-Q	30	42	84	19,335
HCFRM23-30H3096-Q	30	30	96	19,495	HCFRM23-30H3696-Q	30	36	96	20,120	HCFRM23-30H4296-Q	30	42	96	20,975
HCFRM23-30H30108-Q	30	30	108	23,955	HCFRM23-30H36108-Q	30	36	108	24,675	HCFRM23-30H42108-Q	30	42	108	25,680
HCFRM23-30H30120-Q	30	30	120	24,580	HCFRM23-30H36120-Q	30	36	120	25,285	HCFRM23-30H42120-Q	30	42	120	26,285
HCFRM23-30H30144-Q	30	30	144	25,810	HCFRM23-30H36144-Q	30	36	144	26,540	HCFRM23-30H42144-Q	30	42	144	27,610

34"H														
Model Number	H	D	W	COM	Model Number	H	D	W	COM	Model Number	H	D	W	COM
HCFRM23-34H3060-Q	34	30	60	17,635	HCFRM23-34H3660-Q	34	36	60	17,585	HCFRM23-34H4260-Q	34	42	60	18,015
HCFRM23-34H3072-Q	34	30	72	18,050	HCFRM23-34H3672-Q	34	36	72	18,000	HCFRM23-34H4272-Q	34	42	72	18,435
HCFRM23-34H3084-Q	34	30	84	19,295	HCFRM23-34H3684-Q	34	36	84	19,245	HCFRM23-34H4284-Q	34	42	84	19,665
HCFRM23-34H3096-Q	34	30	96	20,500	HCFRM23-34H3696-Q	34	36	96	20,450	HCFRM23-34H4296-Q	34	42	96	21,305
HCFRM23-34H30108-Q	34	30	108	25,190	HCFRM23-34H36108-Q	34	36	108	25,065	HCFRM23-34H42108-Q	34	42	108	26,055
HCFRM23-34H30120-Q	34	30	120	25,735	HCFRM23-34H36120-Q	34	36	120	25,675	HCFRM23-34H42120-Q	34	42	120	26,665
HCFRM23-34H30144-Q	34	30	144	27,015	HCFRM23-34H36144-Q	34	36	144	26,955	HCFRM23-34H42144-Q	34	42	144	28,000

36"H														
Model Number	H	D	W	COM	Model Number	H	D	W	COM	Model Number	H	D	W	COM
HCFRM23-36H3060-Q	36	30	60	17,635	HCFRM23-36H3660-Q	36	36	60	17,585	HCFRM23-36H4260-Q	36	42	60	18,015
HCFRM23-36H3072-Q	36	30	72	18,050	HCFRM23-36H3672-Q	36	36	72	18,000	HCFRM23-36H4272-Q	36	42	72	18,435
HCFRM23-36H3084-Q	36	30	84	19,295	HCFRM23-36H3684-Q	36	36	84	19,245	HCFRM23-36H4284-Q	36	42	84	19,665
HCFRM23-36H3096-Q	36	30	96	20,500	HCFRM23-36H3696-Q	36	36	96	20,450	HCFRM23-36H4296-Q	36	42	96	21,305
HCFRM23-36H30108-Q	36	30	108	25,190	HCFRM23-36H36108-Q	36	36	108	25,065	HCFRM23-36H42108-Q	36	42	108	26,055
HCFRM23-36H30120-Q	36	30	120	25,735	HCFRM23-36H36120-Q	36	36	120	25,675	HCFRM23-36H42120-Q	36	42	120	26,665
HCFRM23-36H30144-Q	36	30	144	27,015	HCFRM23-36H36144-Q	36	36	144	26,955	HCFRM23-36H42144-Q	36	42	144	28,000

42"H														
Model Number	H	D	W	COM	Model Number	H	D	W	COM	Model Number	H	D	W	COM
HCFRM23-42H3060-Q	42	30	60	17,465	HCFRM23-42H3660-Q	42	36	60	17,925	HCFRM23-42H4260-Q	42	42	60	18,355
HCFRM23-42H3072-Q	42	30	72	17,885	HCFRM23-42H3672-Q	42	36	72	18,340	HCFRM23-42H4272-Q	42	42	72	18,765
HCFRM23-42H3084-Q	42	30	84	19,120	HCFRM23-42H3684-Q	42	36	84	19,575	HCFRM23-42H4284-Q	42	42	84	20,005
HCFRM23-42H3096-Q	42	30	96	20,170	HCFRM23-42H3696-Q	42	36	96	20,795	HCFRM23-42H4296-Q	42	42	96	21,645
HCFRM23-42H30108-Q	42	30	108	24,720	HCFRM23-42H36108-Q	42	36	108	25,455	HCFRM23-42H42108-Q	42	42	108	26,435
HCFRM23-42H30120-Q	42	30	120	25,345	HCFRM23-42H36120-Q	42	36	120	26,065	HCFRM23-42H42120-Q	42	42	120	27,045
HCFRM23-42H30144-Q	42	30	144	26,600	HCFRM23-42H36144-Q	42	36	144	27,370	HCFRM23-42H42144-Q	42	42	144	28,405

Model Number See Above (17-18 Characters)	FSC No - X Yes - F	Base Finish See Page 15 Base finish determines wood veneer tabletop selection. Other materials chosen in "Tabletop Material" section.	Base Type See Page 23	Power Rail Module No - PRN Yes - PRY If PRY selected, see page 30 to select power module.	Tabletop Material Disregard this section if tabletop is COM.	Cutout No - GN Yes - LT1 (2-3 Characters) If LT1 selected, see page 32-35 to select lighting. Not available on glass tabletops.
_____	_____	_____	_____	_____	_____	_____

Specification Code Example: HCFRM23E30H30108-Q.F.RF301-OP20.BWWMN.PRN.LT1



Internal Power Cable Kits

Model Number	Description	Price
HVFRM23-HDWIRE2BSE	Hard-wired kit for two base tables.	524
HVFRM23-HDWIRE3BSE	Hard-wired kit for three base tables.	637
HVFRM23-PWRSTRP	Soft-wired power strip.	316

HVFRM23-HDWIRE2BSE

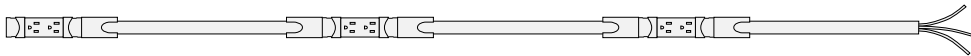

HVFRM23-HDWIRE3BSE

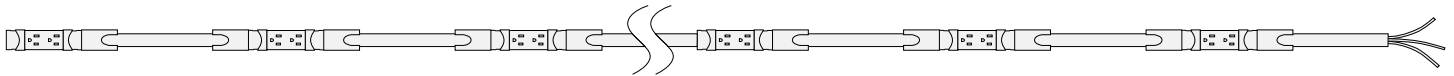

HVFRM23-PWRSTRP

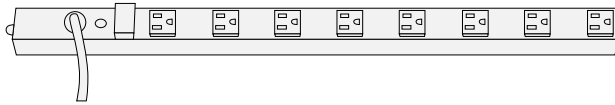

Model Number

See Above
(15-18 Characters)



Specification Code Example: HVFRM23-HDWIRE3BSE



Juniper Shared Task Lamp + Power System	Model Number	Description	Table Length	Price
	HAFRM23-LGHT60W	Juniper Shared Task Lamp, lighting dimmer, one simplex receptacle.	60"	3,287
	HAFRM23-LGHT72W	Juniper Shared Task Lamp, lighting dimmer, one simplex receptacle.	72"	3,287
	HAFRM23-LGHT84W	Juniper Shared Task Lamp, lighting dimmer, one simplex receptacle.	84"	3,713
	HAFRM23-LGHT96W	Juniper Shared Task Lamp, lighting dimmer, one simplex receptacle, and four USB-A receptacles.	96"	4,852
	HAFRM23-LGHT108W	Juniper Shared Task Lamp, lighting dimmer, one simplex receptacle, and four USB-A receptacles.	108"	5,056
	HAFRM23-LGHT120W	Juniper Shared Task Lamp, lighting dimmer, one simplex receptacle, and four USB-A receptacles.	120"	5,130
	HAFRM23-LGHT144W	Juniper Shared Task Lamp, lighting dimmer, one simplex receptacle, and four USB-A receptacles.	144"	5,130

Finishes



Satin Brass
SBR

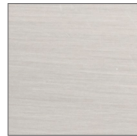

Satin Nickel
SNI



Black Oxide
BLOX



Model Number

See Above
(15-16 Characters)

Lighting Finish

See Above
(3-4 Characters)



Specification Code Example: HAFRM23-LGHT144W.BLOX

Bag Hook

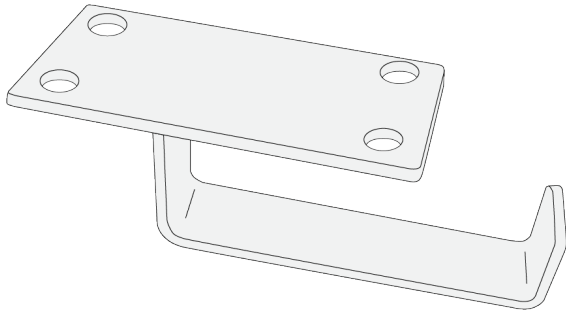

Model Number	Description	Price
HAFRM23-HOOK2	Two Silver Hooks (3"x3/4"x1-3/16")	206
HAFRM23-HOOK4HW	Four Silver Hooks (3"x3/4"x1-3/16")	360

Finishes



Silver



Model Number

See Above
(13-15 Characters)



Specification Code Example: HAFRM23-HOOK4



Notes

Occasional tables (Side and Coffee Tables) ship fully assembled for wood veneer tops. Other tabletop materials must be installed on site.

It is the installing party/dealer’s responsibility to ensure and plan for entryway and hallway dimensions accordingly.

Side Tables

Model Number	Weight	Cubes	Height	Depth	Width
HTFRM23S21H2424-G	115.394	75.031	21.00	24.00	24.00
HTFRM23S21H2424-L	104.736	75.031	21.00	24.00	24.00
HTFRM23S21H2424-Q	130.112	75.031	21.00	24.00	24.00
HTFRM23S21H2424-S	109.543	75.031	21.00	24.00	24.00
HTFRM23S21H2424-W	104.743	61.137	21.00	24.00	24.00

Coffee Tables

Model Number	Weight	Cubes	Height	Depth	Width
HTFRM23E16H3056-G	199.804	62.969	16.00	30.00	56.00
HTFRM23E16H3056-L	163.516	62.969	16.00	30.00	56.00
HTFRM23E16H3056-Q	248.043	62.969	16.00	30.00	56.00
HTFRM23E16H3056-S	179.490	62.969	16.00	30.00	56.00
HTFRM23E16H3056-W	163.520	51.308	16.00	30.00	56.00
HTFRM23S16H4242-G	222.390	75.031	16.00	42.00	42.00
HTFRM23S16H4242-L	185.458	75.031	16.00	42.00	42.00
HTFRM23S16H4242-Q	271.459	75.031	16.00	42.00	42.00
HTFRM23S16H4242-S	201.709	75.031	16.00	42.00	42.00
HTFRM23S16H4242-W	185.460	61.137	16.00	42.00	42.00



Notes

Multipurpose tables (Console) ship fully assembled for wood veneer tops. Other tabletop materials must be installed on site.

It is the installing party/dealer’s responsibility to ensure and plan for entryway and hallway dimensions accordingly.

Console Tables

Model Number	Weight	Cubes	Height	Depth	Width
HTFRM23E26H1860-G	154.828	62.969	26.00	18.00	60.00
HTFRM23E26H1860-L	131.587	62.969	26.00	18.00	60.00
HTFRM23E26H1860-Q	186.253	62.969	26.00	18.00	60.00
HTFRM23E26H1860-S	141.930	23.322	26.00	18.00	60.00
HTFRM23E26H1860-W	131.597	51.308	26.00	18.00	60.00
HTFRM23E26H1872-G	173.834	74.594	26.00	18.00	72.00
HTFRM23E26H1872-L	145.398	74.594	26.00	18.00	72.00
HTFRM23E26H1872-Q	211.948	74.594	26.00	18.00	72.00
HTFRM23E26H1872-S	157.984	74.594	26.00	18.00	72.00
HTFRM23E26H1872-W	145.408	60.780	26.00	18.00	72.00
HTFRM23E36H1860-G	178.214	62.969	36.00	18.00	60.00
HTFRM23E36H1860-L	154.972	62.969	36.00	18.00	60.00
HTFRM23E36H1860-Q	209.639	62.969	36.00	18.00	60.00
HTFRM23E36H1860-S	165.315	62.969	36.00	18.00	60.00
HTFRM23E36H1860-W	154.982	51.308	36.00	18.00	60.00
HTFRM23E36H1872-G	197.220	74.594	36.00	18.00	72.00
HTFRM23E36H1872-L	168.783	74.594	36.00	18.00	72.00
HTFRM23E36H1872-Q	235.333	74.594	36.00	18.00	72.00
HTFRM23E36H1872-S	181.369	74.594	36.00	18.00	72.00
HTFRM23E36H1872-W	168.794	60.780	36.00	18.00	72.00



Notes

Communal tables (Conference Table, ADA Height Table, Counter Height Table, and Bar Height Table) ship knocked-down. 108” and 120” length wood veneer tabletops available in one or two tabletop pieces. 144” length wood veneer tabletops must ship in two pieces. 108”, 120”, and 144” length tabletops for all other materials must come in two pieces.

It is the installing party/dealer’s responsibility to ensure and plan for entryway and hallway dimensions accordingly.

30” Conference Tables

Model Number	Weight	Cubes	Height	Depth	Width	Model Number	Weight	Cubes	Height	Depth	Width
HCFRM23E30H30108-G2	536.924	101.073	30.00	30.00	108.00	HCFRM23E30H3096-S1	435.886	175.265	30.00	30.00	96.00
HCFRM23E30H30108-L2	466.938	50.142	30.00	30.00	108.00	HCFRM23E30H3096-W1	406.457	58.017	30.00	30.00	96.00
HCFRM23E30H30108-Q2	637.296	101.073	30.00	30.00	108.00	HCFRM23E30H36108-G2	603.569	116.358	30.00	36.00	108.00
HCFRM23E30H30108-S2	499.380	101.073	30.00	30.00	108.00	HCFRM23E30H36108-L2	519.445	59.847	30.00	36.00	108.00
HCFRM23E30H30108-W1	465.553	38.481	30.00	30.00	108.00	HCFRM23E30H36108-Q2	723.877	116.358	30.00	36.00	108.00
HCFRM23E30H30108-W2	465.831	38.481	30.00	30.00	108.00	HCFRM23E30H36108-S2	558.312	116.358	30.00	36.00	108.00
HCFRM23E30H30120-G2	583.430	101.073	30.00	30.00	120.00	HCFRM23E30H36108-W1	523.333	45.929	30.00	36.00	108.00
HCFRM23E30H30120-L2	505.224	50.142	30.00	30.00	120.00	HCFRM23E30H36108-W2	523.610	45.929	30.00	36.00	108.00
HCFRM23E30H30120-Q2	695.385	101.073	30.00	30.00	120.00	HCFRM23E30H36120-G2	655.094	116.358	30.00	36.00	120.00
HCFRM23E30H30120-S2	541.402	101.073	30.00	30.00	120.00	HCFRM23E30H36120-L2	561.107	59.847	30.00	36.00	120.00
HCFRM23E30H30120-W1	503.709	38.481	30.00	30.00	120.00	HCFRM23E30H36120-Q2	789.302	116.358	30.00	36.00	120.00
HCFRM23E30H30120-W2	503.987	38.481	30.00	30.00	120.00	HCFRM23E30H36120-S2	604.457	116.358	30.00	36.00	120.00
HCFRM23E30H30144-G2	676.442	156.106	30.00	30.00	144.00	HCFRM23E30H36120-W1	564.838	45.929	30.00	36.00	120.00
HCFRM23E30H30144-L2	581.796	59.399	30.00	30.00	144.00	HCFRM23E30H36120-W2	565.116	45.929	30.00	36.00	120.00
HCFRM23E30H30144-Q2	811.567	156.106	30.00	30.00	144.00	HCFRM23E30H36144-G2	758.144	178.856	30.00	36.00	144.00
HCFRM23E30H30144-S2	625.446	156.106	30.00	30.00	144.00	HCFRM23E30H36144-L2	644.432	70.895	30.00	36.00	144.00
HCFRM23E30H30144-W2	580.299	45.585	30.00	30.00	144.00	HCFRM23E30H36144-Q2	920.157	178.856	30.00	36.00	144.00
HCFRM23E30H3060-G1	329.924	101.073	30.00	30.00	60.00	HCFRM23E30H36144-S2	696.747	178.856	30.00	36.00	144.00
HCFRM23E30H3060-L1	292.556	50.142	30.00	30.00	60.00	HCFRM23E30H36144-W2	648.126	54.408	30.00	36.00	144.00
HCFRM23E30H3060-Q1	383.708	101.073	30.00	30.00	60.00	HCFRM23E30H3660-G1	376.492	116.358	30.00	36.00	60.00
HCFRM23E30H3060-S1	309.799	101.073	30.00	30.00	60.00	HCFRM23E30H3660-L1	331.559	59.847	30.00	36.00	60.00
HCFRM23E30H3060-W1	291.969	38.481	30.00	30.00	60.00	HCFRM23E30H3660-Q1	440.941	116.358	30.00	36.00	60.00
HCFRM23E30H3072-G1	376.430	156.106	30.00	30.00	72.00	HCFRM23E30H3660-S1	352.240	116.358	30.00	36.00	60.00
HCFRM23E30H3072-L1	330.842	59.399	30.00	30.00	72.00	HCFRM23E30H3660-W1	330.850	45.929	30.00	36.00	60.00
HCFRM23E30H3072-Q1	441.799	156.106	30.00	30.00	72.00	HCFRM23E30H3672-G1	428.017	178.856	30.00	36.00	72.00
HCFRM23E30H3072-S1	351.821	156.106	30.00	30.00	72.00	HCFRM23E30H3672-L1	373.221	70.895	30.00	36.00	72.00
HCFRM23E30H3072-W1	330.125	45.585	30.00	30.00	72.00	HCFRM23E30H3672-Q1	506.369	178.856	30.00	36.00	72.00
HCFRM23E30H3084-G1	422.956	157.350	30.00	30.00	84.00	HCFRM23E30H3672-S1	398.385	178.856	30.00	36.00	72.00
HCFRM23E30H3084-L1	369.148	103.643	30.00	30.00	84.00	HCFRM23E30H3672-W1	372.356	54.408	30.00	36.00	72.00
HCFRM23E30H3084-Q1	499.910	157.350	30.00	30.00	84.00	HCFRM23E30H3684-G1	479.562	167.899	30.00	36.00	84.00
HCFRM23E30H3084-S1	393.863	157.350	30.00	30.00	84.00	HCFRM23E30H3684-L1	414.903	103.643	30.00	36.00	84.00
HCFRM23E30H3084-W1	368.301	79.540	30.00	30.00	84.00	HCFRM23E30H3684-Q1	571.817	167.899	30.00	36.00	84.00
HCFRM23E30H3096-G1	469.462	175.265	30.00	30.00	96.00	HCFRM23E30H3684-S1	444.550	167.899	30.00	36.00	84.00
HCFRM23E30H3096-L1	407.434	75.598	30.00	30.00	96.00	HCFRM23E30H3684-W1	413.881	79.540	30.00	36.00	84.00
HCFRM23E30H3096-Q1	558.000	175.265	30.00	30.00	96.00	HCFRM23E30H3696-G1	531.087	201.230	30.00	36.00	96.00



Notes

Communal tables (Conference Table, ADA Height Table, Counter Height Table, and Bar Height Table) ship knocked-down. 108” and 120” length wood veneer tabletops available in one or two tabletop pieces. 144” length wood veneer tabletops must ship in two pieces. 108”, 120”, and 144” length tabletops for all other materials must come in two pieces.

It is the installing party/dealer’s responsibility to ensure and plan for entryway and hallway dimensions accordingly.

30” Conference Tables

Model Number	Weight	Cubes	Height	Depth	Width	Model Number	Weight	Cubes	Height	Depth	Width
HCFRM23E30H3696-L1	456.565	90.230	30.00	36.00	96.00	HCFRM23E30H4284-W1	459.402	79.540	30.00	42.00	84.00
HCFRM23E30H3696-Q1	637.244	201.230	30.00	36.00	96.00	HCFRM23E30H4296-G1	592.654	230.532	30.00	42.00	96.00
HCFRM23E30H3696-S1	490.695	201.230	30.00	36.00	96.00	HCFRM23E30H4296-L1	505.638	109.491	30.00	42.00	96.00
HCFRM23E30H3696-W1	455.387	69.247	30.00	36.00	96.00	HCFRM23E30H4296-Q1	716.429	230.532	30.00	42.00	96.00
HCFRM23E30H42108-G2	670.155	143.662	30.00	42.00	108.00	HCFRM23E30H4296-S1	545.446	230.532	30.00	42.00	96.00
HCFRM23E30H42108-L2	571.894	86.224	30.00	42.00	108.00	HCFRM23E30H4296-W1	504.257	84.028	30.00	42.00	96.00
HCFRM23E30H42108-Q2	810.400	143.662	30.00	42.00	108.00						
HCFRM23E30H42108-S2	617.185	143.662	30.00	42.00	108.00						
HCFRM23E30H42108-W1	581.062	66.172	30.00	42.00	108.00						
HCFRM23E30H42108-W2	581.339	66.172	30.00	42.00	108.00						
HCFRM23E30H42120-G2	726.700	143.662	30.00	42.00	120.00						
HCFRM23E30H42120-L2	616.932	86.224	30.00	42.00	120.00						
HCFRM23E30H42120-Q2	883.161	143.662	30.00	42.00	120.00						
HCFRM23E30H42120-S2	667.453	143.662	30.00	42.00	120.00						
HCFRM23E30H42120-W1	625.916	66.172	30.00	42.00	120.00						
HCFRM23E30H42120-W2	626.194	66.172	30.00	42.00	120.00						
HCFRM23E30H42144-G2	839.788	204.369	30.00	42.00	144.00						
HCFRM23E30H42144-L2	707.009	86.224	30.00	42.00	144.00						
HCFRM23E30H42144-Q2	1,028.689	204.369	30.00	42.00	144.00						
HCFRM23E30H42144-S2	767.989	204.369	30.00	42.00	144.00						
HCFRM23E30H42144-W2	715.904	66.172	30.00	42.00	144.00						
HCFRM23E30H4260-G1	423.001	143.662	30.00	42.00	60.00						
HCFRM23E30H4260-L1	370.503	86.224	30.00	42.00	60.00						
HCFRM23E30H4260-Q1	498.116	143.662	30.00	42.00	60.00						
HCFRM23E30H4260-S1	394.622	143.662	30.00	42.00	60.00						
HCFRM23E30H4260-W1	369.673	66.172	30.00	42.00	60.00						
HCFRM23E30H4272-G1	479.545	204.369	30.00	42.00	72.00						
HCFRM23E30H4272-L1	415.541	86.224	30.00	42.00	72.00						
HCFRM23E30H4272-Q1	570.881	204.369	30.00	42.00	72.00						
HCFRM23E30H4272-S1	444.890	204.369	30.00	42.00	72.00						
HCFRM23E30H4272-W1	414.527	66.172	30.00	42.00	72.00						
HCFRM23E30H4284-G1	536.110	178.447	30.00	42.00	84.00						
HCFRM23E30H4284-L1	460.599	103.643	30.00	42.00	84.00						
HCFRM23E30H4284-Q1	643.665	178.447	30.00	42.00	84.00						
HCFRM23E30H4284-S1	495.178	178.447	30.00	42.00	84.00						



Notes

Communal tables (Conference Table, ADA Height Table, Counter Height Table, and Bar Height Table) ship knocked-down. 108" and 120" length wood veneer tabletops available in one or two tabletop pieces. 144" length wood veneer tabletops must ship in two pieces. 108", 120", and 144" length tabletops for all other materials must come in two pieces.

It is the installing party/dealer's responsibility to ensure and plan for entryway and hallway dimensions accordingly.

34" ADA Height Tables

Model Number	Weight	Cubes	Height	Depth	Width	Model Number	Weight	Cubes	Height	Depth	Width
HCFRM23E34H30108-G2	555.152	101.073	34.00	30.00	108.00	HCFRM23E34H3096-S1	450.636	175.265	34.00	30.00	96.00
HCFRM23E34H30108-L2	485.166	50.142	34.00	30.00	108.00	HCFRM23E34H3096-W1	421.208	58.017	34.00	30.00	96.00
HCFRM23E34H30108-Q2	655.524	101.073	34.00	30.00	108.00	HCFRM23E34H36108-G2	624.915	116.358	34.00	36.00	108.00
HCFRM23E34H30108-S2	517.608	101.073	34.00	30.00	108.00	HCFRM23E34H36108-L2	540.791	59.847	34.00	36.00	108.00
HCFRM23E34H30108-W1	483.781	38.481	34.00	30.00	108.00	HCFRM23E34H36108-Q2	745.223	116.358	34.00	36.00	108.00
HCFRM23E34H30108-W2	484.059	38.481	34.00	30.00	108.00	HCFRM23E34H36108-S2	579.658	116.358	34.00	36.00	108.00
HCFRM23E34H30120-G2	601.658	101.073	34.00	30.00	120.00	HCFRM23E34H36108-W1	545.458	45.929	34.00	36.00	108.00
HCFRM23E34H30120-L2	523.452	50.142	34.00	30.00	120.00	HCFRM23E34H36108-W2	545.736	45.929	34.00	36.00	108.00
HCFRM23E34H30120-Q2	713.613	101.073	34.00	30.00	120.00	HCFRM23E34H36120-G2	676.440	116.358	34.00	36.00	120.00
HCFRM23E34H30120-S2	559.630	101.073	34.00	30.00	120.00	HCFRM23E34H36120-L2	582.454	59.847	34.00	36.00	120.00
HCFRM23E34H30120-W1	521.937	38.481	34.00	30.00	120.00	HCFRM23E34H36120-Q2	810.648	116.358	34.00	36.00	120.00
HCFRM23E34H30120-W2	522.215	38.481	34.00	30.00	120.00	HCFRM23E34H36120-S2	625.803	116.358	34.00	36.00	120.00
HCFRM23E34H30144-G2	694.670	156.106	34.00	30.00	144.00	HCFRM23E34H36120-W1	586.964	45.929	34.00	36.00	120.00
HCFRM23E34H30144-L2	600.024	59.399	34.00	30.00	144.00	HCFRM23E34H36120-W2	587.241	45.929	34.00	36.00	120.00
HCFRM23E34H30144-Q2	829.795	156.106	34.00	30.00	144.00	HCFRM23E34H36144-G2	779.490	178.856	34.00	36.00	144.00
HCFRM23E34H30144-S2	643.674	156.106	34.00	30.00	144.00	HCFRM23E34H36144-L2	665.778	70.895	34.00	36.00	144.00
HCFRM23E34H30144-W2	598.527	45.585	34.00	30.00	144.00	HCFRM23E34H36144-Q2	941.504	178.856	34.00	36.00	144.00
HCFRM23E34H3060-G1	344.675	101.073	34.00	30.00	60.00	HCFRM23E34H36144-S2	718.093	178.856	34.00	36.00	144.00
HCFRM23E34H3060-L1	307.307	50.142	34.00	30.00	60.00	HCFRM23E34H36144-W2	670.252	54.408	34.00	36.00	144.00
HCFRM23E34H3060-Q1	398.458	101.073	34.00	30.00	60.00	HCFRM23E34H3660-G1	394.361	116.358	34.00	36.00	60.00
HCFRM23E34H3060-S1	324.549	101.073	34.00	30.00	60.00	HCFRM23E34H3660-L1	349.427	59.847	34.00	36.00	60.00
HCFRM23E34H3060-W1	306.720	38.481	34.00	30.00	60.00	HCFRM23E34H3660-Q1	458.810	116.358	34.00	36.00	60.00
HCFRM23E34H3072-G1	391.180	156.106	34.00	30.00	72.00	HCFRM23E34H3660-S1	370.108	116.358	34.00	36.00	60.00
HCFRM23E34H3072-L1	345.593	59.399	34.00	30.00	72.00	HCFRM23E34H3660-W1	348.719	45.929	34.00	36.00	60.00
HCFRM23E34H3072-Q1	456.549	156.106	34.00	30.00	72.00	HCFRM23E34H3672-G1	445.886	178.856	34.00	36.00	72.00
HCFRM23E34H3072-S1	366.571	156.106	34.00	30.00	72.00	HCFRM23E34H3672-L1	391.089	70.895	34.00	36.00	72.00
HCFRM23E34H3072-W1	344.876	45.585	34.00	30.00	72.00	HCFRM23E34H3672-Q1	524.238	178.856	34.00	36.00	72.00
HCFRM23E34H3084-G1	437.706	157.350	34.00	30.00	84.00	HCFRM23E34H3672-S1	416.253	178.856	34.00	36.00	72.00
HCFRM23E34H3084-L1	383.899	103.643	34.00	30.00	84.00	HCFRM23E34H3672-W1	390.224	54.408	34.00	36.00	72.00
HCFRM23E34H3084-Q1	514.660	157.350	34.00	30.00	84.00	HCFRM23E34H3684-G1	497.431	167.899	34.00	36.00	84.00
HCFRM23E34H3084-S1	408.614	157.350	34.00	30.00	84.00	HCFRM23E34H3684-L1	432.772	103.643	34.00	36.00	84.00
HCFRM23E34H3084-W1	383.052	79.540	34.00	30.00	84.00	HCFRM23E34H3684-Q1	589.685	167.899	34.00	36.00	84.00
HCFRM23E34H3096-G1	484.212	175.265	34.00	30.00	96.00	HCFRM23E34H3684-S1	462.418	167.899	34.00	36.00	84.00
HCFRM23E34H3096-L1	422.185	75.598	34.00	30.00	96.00	HCFRM23E34H3684-W1	431.750	79.540	34.00	36.00	84.00
HCFRM23E34H3096-Q1	572.751	175.265	34.00	30.00	96.00	HCFRM23E34H3696-G1	548.956	201.230	34.00	36.00	96.00



Notes

Communal tables (Conference Table, ADA Height Table, Counter Height Table, and Bar Height Table) ship knocked-down. 108" and 120" length wood veneer tabletops available in one or two tabletop pieces. 144" length wood veneer tabletops must ship in two pieces. 108", 120", and 144" length tabletops for all other materials must come in two pieces.

It is the installing party/dealer's responsibility to ensure and plan for entryway and hallway dimensions accordingly.

34" ADA Height Tables

Model Number	Weight	Cubes	Height	Depth	Width	Model Number	Weight	Cubes	Height	Depth	Width
HCFRM23E34H3696-L1	474.434	90.230	34.00	36.00	96.00	HCFRM23E34H4284-W1	480.389	79.540	34.00	42.00	84.00
HCFRM23E34H3696-Q1	655.113	201.230	34.00	36.00	96.00	HCFRM23E34H4296-G1	613.641	230.532	34.00	42.00	96.00
HCFRM23E34H3696-S1	508.563	201.230	34.00	36.00	96.00	HCFRM23E34H4296-L1	526.624	109.491	34.00	42.00	96.00
HCFRM23E34H3696-W1	473.255	69.247	34.00	36.00	96.00	HCFRM23E34H4296-Q1	737.416	230.532	34.00	42.00	96.00
HCFRM23E34H42108-G2	694.620	143.662	34.00	42.00	108.00	HCFRM23E34H4296-S1	566.432	230.532	34.00	42.00	96.00
HCFRM23E34H42108-L2	596.358	86.224	34.00	42.00	108.00	HCFRM23E34H4296-W1	525.244	84.028	34.00	42.00	96.00
HCFRM23E34H42108-Q2	834.864	143.662	34.00	42.00	108.00						
HCFRM23E34H42108-S2	641.649	143.662	34.00	42.00	108.00						
HCFRM23E34H42108-W1	607.085	66.172	34.00	42.00	108.00						
HCFRM23E34H42108-W2	607.363	66.172	34.00	42.00	108.00						
HCFRM23E34H42120-G2	751.164	143.662	34.00	42.00	120.00						
HCFRM23E34H42120-L2	641.396	86.224	34.00	42.00	120.00						
HCFRM23E34H42120-Q2	907.625	143.662	34.00	42.00	120.00						
HCFRM23E34H42120-S2	691.917	143.662	34.00	42.00	120.00						
HCFRM23E34H42120-W1	651.940	66.172	34.00	42.00	120.00						
HCFRM23E34H42120-W2	652.217	66.172	34.00	42.00	120.00						
HCFRM23E34H42144-G2	864.253	204.369	34.00	42.00	144.00						
HCFRM23E34H42144-L2	731.473	86.224	34.00	42.00	144.00						
HCFRM23E34H42144-Q2	1,053.153	204.369	34.00	42.00	144.00						
HCFRM23E34H42144-S2	792.453	204.369	34.00	42.00	144.00						
HCFRM23E34H42144-W2	741.927	66.172	34.00	42.00	144.00						
HCFRM23E34H4260-G1	443.988	143.662	34.00	42.00	60.00						
HCFRM23E34H4260-L1	391.489	86.224	34.00	42.00	60.00						
HCFRM23E34H4260-Q1	519.103	143.662	34.00	42.00	60.00						
HCFRM23E34H4260-S1	415.608	143.662	34.00	42.00	60.00						
HCFRM23E34H4260-W1	390.659	66.172	34.00	42.00	60.00						
HCFRM23E34H4272-G1	500.532	204.369	34.00	42.00	72.00						
HCFRM23E34H4272-L1	436.527	86.224	34.00	42.00	72.00						
HCFRM23E34H4272-Q1	591.867	204.369	34.00	42.00	72.00						
HCFRM23E34H4272-S1	465.876	204.369	34.00	42.00	72.00						
HCFRM23E34H4272-W1	435.514	66.172	34.00	42.00	72.00						
HCFRM23E34H4284-G1	557.096	178.447	34.00	42.00	84.00						
HCFRM23E34H4284-L1	481.586	103.643	34.00	42.00	84.00						
HCFRM23E34H4284-Q1	664.652	178.447	34.00	42.00	84.00						
HCFRM23E34H4284-S1	516.164	178.447	34.00	42.00	84.00						



Notes

Communal tables (Conference Table, ADA Height Table, Counter Height Table, and Bar Height Table) ship knocked-down. 108" and 120" length wood veneer tabletops available in one or two tabletop pieces. 144" length wood veneer tabletops must ship in two pieces. 108", 120", and 144" length tabletops for all other materials must come in two pieces.

It is the installing party/dealer's responsibility to ensure and plan for entryway and hallway dimensions accordingly.

36" Counter Height Tables

Model Number	Weight	Cubes	Height	Depth	Width	Model Number	Weight	Cubes	Height	Depth	Width
HCFRM23E36H30108-G2	591.851	101.073	36.00	30.00	108.00	HCFRM23E36H3096-S1	483.124	175.265	36.00	30.00	96.00
HCFRM23E36H30108-L2	523.111	50.142	36.00	30.00	108.00	HCFRM23E36H3096-W1	453.895	58.017	36.00	30.00	96.00
HCFRM23E36H30108-Q2	690.828	101.073	36.00	30.00	108.00	HCFRM23E36H36108-G2	668.084	116.358	36.00	36.00	108.00
HCFRM23E36H30108-S2	553.738	101.073	36.00	30.00	108.00	HCFRM23E36H36108-L2	585.207	59.847	36.00	36.00	108.00
HCFRM23E36H30108-W1	520.110	38.481	36.00	30.00	108.00	HCFRM23E36H36108-Q2	786.998	116.358	36.00	36.00	108.00
HCFRM23E36H30108-W2	520.388	38.481	36.00	30.00	108.00	HCFRM23E36H36108-S2	622.259	116.358	36.00	36.00	108.00
HCFRM23E36H30120-G2	638.356	101.073	36.00	30.00	120.00	HCFRM23E36H36108-W1	588.648	45.929	36.00	36.00	108.00
HCFRM23E36H30120-L2	561.397	50.142	36.00	30.00	120.00	HCFRM23E36H36108-W2	588.925	45.929	36.00	36.00	108.00
HCFRM23E36H30120-Q2	748.917	101.073	36.00	30.00	120.00	HCFRM23E36H36120-G2	719.609	116.358	36.00	36.00	120.00
HCFRM23E36H30120-S2	595.760	101.073	36.00	30.00	120.00	HCFRM23E36H36120-L2	626.869	59.847	36.00	36.00	120.00
HCFRM23E36H30120-W1	558.266	38.481	36.00	30.00	120.00	HCFRM23E36H36120-Q2	852.423	116.358	36.00	36.00	120.00
HCFRM23E36H30120-W2	558.544	38.481	36.00	30.00	120.00	HCFRM23E36H36120-S2	668.404	116.358	36.00	36.00	120.00
HCFRM23E36H30144-G2	731.368	156.106	36.00	30.00	144.00	HCFRM23E36H36120-W1	630.153	45.929	36.00	36.00	120.00
HCFRM23E36H30144-L2	637.969	59.399	36.00	30.00	144.00	HCFRM23E36H36120-W2	630.431	45.929	36.00	36.00	120.00
HCFRM23E36H30144-Q2	865.099	156.106	36.00	30.00	144.00	HCFRM23E36H36144-G2	822.660	178.856	36.00	36.00	144.00
HCFRM23E36H30144-S2	679.804	156.106	36.00	30.00	144.00	HCFRM23E36H36144-L2	710.193	70.895	36.00	36.00	144.00
HCFRM23E36H30144-W2	634.856	45.585	36.00	30.00	144.00	HCFRM23E36H36144-Q2	983.278	178.856	36.00	36.00	144.00
HCFRM23E36H3060-G1	378.339	101.073	36.00	30.00	60.00	HCFRM23E36H36144-S2	760.694	178.856	36.00	36.00	144.00
HCFRM23E36H3060-L1	340.752	50.142	36.00	30.00	60.00	HCFRM23E36H36144-W2	713.441	54.408	36.00	36.00	144.00
HCFRM23E36H3060-Q1	431.313	101.073	36.00	30.00	60.00	HCFRM23E36H3660-G1	434.495	116.358	36.00	36.00	60.00
HCFRM23E36H3060-S1	357.883	101.073	36.00	30.00	60.00	HCFRM23E36H3660-L1	389.344	59.847	36.00	36.00	60.00
HCFRM23E36H3060-W1	340.169	38.481	36.00	30.00	60.00	HCFRM23E36H3660-Q1	498.136	116.358	36.00	36.00	60.00
HCFRM23E36H3072-G1	424.845	156.106	36.00	30.00	72.00	HCFRM23E36H3660-S1	409.913	116.358	36.00	36.00	60.00
HCFRM23E36H3072-L1	379.038	59.399	36.00	30.00	72.00	HCFRM23E36H3660-W1	388.639	45.929	36.00	36.00	60.00
HCFRM23E36H3072-Q1	489.404	156.106	36.00	30.00	72.00	HCFRM23E36H3672-G1	486.020	178.856	36.00	36.00	72.00
HCFRM23E36H3072-S1	399.906	156.106	36.00	30.00	72.00	HCFRM23E36H3672-L1	431.006	70.895	36.00	36.00	72.00
HCFRM23E36H3072-W1	378.325	45.585	36.00	30.00	72.00	HCFRM23E36H3672-Q1	563.563	178.856	36.00	36.00	72.00
HCFRM23E36H3084-G1	471.370	157.350	36.00	30.00	84.00	HCFRM23E36H3672-S1	456.058	178.856	36.00	36.00	72.00
HCFRM23E36H3084-L1	417.344	103.643	36.00	30.00	84.00	HCFRM23E36H3672-W1	430.145	54.408	36.00	36.00	72.00
HCFRM23E36H3084-Q1	547.515	157.350	36.00	30.00	84.00	HCFRM23E36H3684-G1	537.566	167.899	36.00	36.00	84.00
HCFRM23E36H3084-S1	441.948	157.350	36.00	30.00	84.00	HCFRM23E36H3684-L1	472.688	103.643	36.00	36.00	84.00
HCFRM23E36H3084-W1	416.501	79.540	36.00	30.00	84.00	HCFRM23E36H3684-Q1	629.011	167.899	36.00	36.00	84.00
HCFRM23E36H3096-G1	517.268	175.265	36.00	30.00	96.00	HCFRM23E36H3684-S1	502.223	167.899	36.00	36.00	84.00
HCFRM23E36H3096-L1	454.864	75.598	36.00	30.00	96.00	HCFRM23E36H3684-W1	471.670	79.540	36.00	36.00	84.00
HCFRM23E36H3096-Q1	604.413	175.265	36.00	30.00	96.00	HCFRM23E36H3696-G1	588.483	201.230	36.00	36.00	96.00



Notes

Communal tables (Conference Table, ADA Height Table, Counter Height Table, and Bar Height Table) ship knocked-down. 108" and 120" length wood veneer tabletops available in one or two tabletop pieces. 144" length wood veneer tabletops must ship in two pieces. 108", 120", and 144" length tabletops for all other materials must come in two pieces.

It is the installing party/dealer's responsibility to ensure and plan for entryway and hallway dimensions accordingly.

36" Counter Height Tables

Model Number	Weight	Cubes	Height	Depth	Width	Model Number	Weight	Cubes	Height	Depth	Width
HCFRM23E36H3696-L1	513.584	90.230	36.00	36.00	96.00	HCFRM23E36H4284-W1	526.780	79.540	34.00	42.00	84.00
HCFRM23E36H3696-Q1	693.246	201.230	36.00	36.00	96.00	HCFRM23E36H4296-G1	659.638	230.532	34.00	42.00	96.00
HCFRM23E36H3696-S1	547.522	201.230	36.00	36.00	96.00	HCFRM23E36H4296-L1	572.246	109.491	34.00	42.00	96.00
HCFRM23E36H3696-W1	512.413	69.247	36.00	36.00	96.00	HCFRM23E36H4296-Q1	782.019	230.532	34.00	42.00	96.00
HCFRM23E36H42108-G2	744.259	143.662	36.00	42.00	108.00	HCFRM23E36H4296-S1	611.862	230.532	34.00	42.00	96.00
HCFRM23E36H42108-L2	647.244	86.224	36.00	42.00	108.00	HCFRM23E36H4296-W1	570.872	84.028	34.00	42.00	96.00
HCFRM23E36H42108-Q2	883.109	143.662	36.00	42.00	108.00						
HCFRM23E36H42108-S2	690.721	143.662	36.00	42.00	108.00						
HCFRM23E36H42108-W1	657.135	66.172	36.00	42.00	108.00						
HCFRM23E36H42108-W2	657.412	66.172	36.00	42.00	108.00						
HCFRM23E36H42120-G2	800.804	143.662	36.00	42.00	120.00						
HCFRM23E36H42120-L2	692.283	86.224	36.00	42.00	120.00						
HCFRM23E36H42120-Q2	955.870	143.662	36.00	42.00	120.00						
HCFRM23E36H42120-S2	740.989	143.662	36.00	42.00	120.00						
HCFRM23E36H42120-W1	701.990	66.172	36.00	42.00	120.00						
HCFRM23E36H42120-W2	702.267	66.172	36.00	42.00	120.00						
HCFRM23E36H42144-G2	913.892	204.369	36.00	42.00	144.00						
HCFRM23E36H42144-L2	782.359	86.224	36.00	42.00	144.00						
HCFRM23E36H42144-Q2	1,101.399	204.369	36.00	42.00	144.00						
HCFRM23E36H42144-S2	841.525	204.369	36.00	42.00	144.00						
HCFRM23E36H42144-W2	791.977	66.172	36.00	42.00	144.00						
HCFRM23E36H4260-G1	490.593	143.662	36.00	42.00	60.00						
HCFRM23E36H4260-L1	437.876	86.224	36.00	42.00	60.00						
HCFRM23E36H4260-Q1	564.899	143.662	36.00	42.00	60.00						
HCFRM23E36H4260-S1	461.884	143.662	36.00	42.00	60.00						
HCFRM23E36H4260-W1	437.050	66.172	36.00	42.00	60.00						
HCFRM23E36H4272-G1	547.138	204.369	36.00	42.00	72.00						
HCFRM23E36H4272-L1	482.915	86.224	36.00	42.00	72.00						
HCFRM23E36H4272-Q1	637.664	204.369	36.00	42.00	72.00						
HCFRM23E36H4272-S1	512.152	204.369	36.00	42.00	72.00						
HCFRM23E36H4272-W1	481.905	66.172	36.00	42.00	72.00						
HCFRM23E36H4284-G1	603.702	178.447	36.00	42.00	84.00						
HCFRM23E36H4284-L1	527.973	103.643	36.00	42.00	84.00						
HCFRM23E36H4284-Q1	710.448	178.447	36.00	42.00	84.00						
HCFRM23E36H4284-S1	562.440	178.447	36.00	42.00	84.00						



Notes

Communal tables (Conference Table, ADA Height Table, Counter Height Table, and Bar Height Table) ship knocked-down. 108” and 120” length wood veneer tabletops available in one or two tabletop pieces. 144” length wood veneer tabletops must ship in two pieces. 108”, 120”, and 144” length tabletops for all other materials must come in two pieces.

It is the installing party/dealer’s responsibility to ensure and plan for entryway and hallway dimensions accordingly.

42” Bar Height Tables

Model Number	Weight	Cubes	Height	Depth	Width	Model Number	Weight	Cubes	Height	Depth	Width
HCFRM23E42H30108-G2	619.193	101.073	42.00	30.00	108.00	HCFRM23E42H3096-S1	505.250	175.265	42.00	30.00	96.00
HCFRM23E42H30108-L2	550.453	50.142	42.00	30.00	108.00	HCFRM23E42H3096-W1	476.020	58.017	42.00	30.00	96.00
HCFRM23E42H30108-Q2	718.170	101.073	42.00	30.00	108.00	HCFRM23E42H36108-G2	700.104	116.358	42.00	36.00	108.00
HCFRM23E42H30108-S2	581.080	101.073	42.00	30.00	108.00	HCFRM23E42H36108-L2	617.226	59.847	42.00	36.00	108.00
HCFRM23E42H30108-W1	547.452	38.481	42.00	30.00	108.00	HCFRM23E42H36108-Q2	819.017	116.358	42.00	36.00	108.00
HCFRM23E42H30108-W2	547.730	38.481	42.00	30.00	108.00	HCFRM23E42H36108-S2	654.278	116.358	42.00	36.00	108.00
HCFRM23E42H30120-G2	665.698	101.073	42.00	30.00	120.00	HCFRM23E42H36108-W1	621.836	45.929	42.00	36.00	108.00
HCFRM23E42H30120-L2	588.739	50.142	42.00	30.00	120.00	HCFRM23E42H36108-W2	622.114	45.929	42.00	36.00	108.00
HCFRM23E42H30120-Q2	776.259	101.073	42.00	30.00	120.00	HCFRM23E42H36120-G2	751.629	116.358	42.00	36.00	120.00
HCFRM23E42H30120-S2	623.102	101.073	42.00	30.00	120.00	HCFRM23E42H36120-L2	658.888	59.847	42.00	36.00	120.00
HCFRM23E42H30120-W1	585.608	38.481	42.00	30.00	120.00	HCFRM23E42H36120-Q2	884.442	116.358	42.00	36.00	120.00
HCFRM23E42H30120-W2	585.886	38.481	42.00	30.00	120.00	HCFRM23E42H36120-S2	700.423	116.358	42.00	36.00	120.00
HCFRM23E42H30144-G2	758.710	156.106	42.00	30.00	144.00	HCFRM23E42H36120-W1	663.341	45.929	42.00	36.00	120.00
HCFRM23E42H30144-L2	665.311	59.399	42.00	30.00	144.00	HCFRM23E42H36120-W2	663.619	45.929	42.00	36.00	120.00
HCFRM23E42H30144-Q2	892.441	156.106	42.00	30.00	144.00	HCFRM23E42H36144-G2	854.679	178.856	42.00	36.00	144.00
HCFRM23E42H30144-S2	707.146	156.106	42.00	30.00	144.00	HCFRM23E42H36144-L2	742.213	70.895	42.00	36.00	144.00
HCFRM23E42H30144-W2	662.198	45.585	42.00	30.00	144.00	HCFRM23E42H36144-Q2	1,015.297	178.856	42.00	36.00	144.00
HCFRM23E42H3060-G1	400.464	101.073	42.00	30.00	60.00	HCFRM23E42H36144-S2	700.423	178.856	42.00	36.00	144.00
HCFRM23E42H3060-L1	362.878	50.142	42.00	30.00	60.00	HCFRM23E42H36144-W2	746.630	54.408	42.00	36.00	144.00
HCFRM23E42H3060-Q1	453.439	101.073	42.00	30.00	60.00	HCFRM23E42H3660-G1	461.298	116.358	42.00	36.00	60.00
HCFRM23E42H3060-S1	380.009	101.073	42.00	30.00	60.00	HCFRM23E42H3660-L1	416.147	59.847	42.00	36.00	60.00
HCFRM23E42H3060-W1	362.295	38.481	42.00	30.00	60.00	HCFRM23E42H3660-Q1	524.938	116.358	42.00	36.00	60.00
HCFRM23E42H3072-G1	446.970	156.106	42.00	30.00	72.00	HCFRM23E42H3660-S1	436.716	116.358	42.00	36.00	60.00
HCFRM23E42H3072-L1	401.164	59.399	42.00	30.00	72.00	HCFRM23E42H3660-W1	415.442	45.929	42.00	36.00	60.00
HCFRM23E42H3072-Q1	511.530	156.106	42.00	30.00	72.00	HCFRM23E42H3672-G1	512.823	178.856	42.00	36.00	72.00
HCFRM23E42H3072-S1	422.031	156.106	42.00	30.00	72.00	HCFRM23E42H3672-L1	457.809	70.895	42.00	36.00	72.00
HCFRM23E42H3072-W1	400.451	45.585	42.00	30.00	72.00	HCFRM23E42H3672-Q1	590.366	178.856	42.00	36.00	72.00
HCFRM23E42H3084-G1	493.496	157.350	42.00	30.00	84.00	HCFRM23E42H3672-S1	482.861	178.856	42.00	36.00	72.00
HCFRM23E42H3084-L1	439.470	103.643	42.00	30.00	84.00	HCFRM23E42H3672-W1	456.947	54.408	42.00	36.00	72.00
HCFRM23E42H3084-Q1	569.641	157.350	42.00	30.00	84.00	HCFRM23E42H3684-G1	564.368	167.899	42.00	36.00	84.00
HCFRM23E42H3084-S1	464.074	157.350	42.00	30.00	84.00	HCFRM23E42H3684-L1	499.491	103.643	42.00	36.00	84.00
HCFRM23E42H3084-W1	438.627	79.540	42.00	30.00	84.00	HCFRM23E42H3684-Q1	655.814	167.899	42.00	36.00	84.00
HCFRM23E42H3096-G1	539.394	175.265	42.00	30.00	96.00	HCFRM23E42H3684-S1	529.026	167.899	42.00	36.00	84.00
HCFRM23E42H3096-L1	476.990	75.598	42.00	30.00	96.00	HCFRM23E42H3684-W1	498.473	79.540	42.00	36.00	84.00
HCFRM23E42H3096-Q1	626.538	175.265	42.00	30.00	96.00	HCFRM23E42H3696-G1	615.285	201.230	42.00	36.00	96.00



Notes

Communal tables (Conference Table, ADA Height Table, Counter Height Table, and Bar Height Table) ship knocked-down. 108” and 120” length wood veneer tabletops available in one or two tabletop pieces. 144” length wood veneer tabletops must ship in two pieces. 108”, 120”, and 144” length tabletops for all other materials must come in two pieces.

It is the installing party/dealer’s responsibility to ensure and plan for entryway and hallway dimensions accordingly.

42” Bar Height Tables

Model Number	Weight	Cubes	Height	Depth	Width	Model Number	Weight	Cubes	Height	Depth	Width
HCFRM23E42H3696-L1	540.387	90.230	42.00	36.00	96.00	HCFRM23E42H4284-W1	558.260	79.540	42.00	42.00	84.00
HCFRM23E42H3696-Q1	720.048	201.230	42.00	36.00	96.00	HCFRM23E42H4296-G1	691.118	230.532	42.00	42.00	96.00
HCFRM23E42H3696-S1	574.325	201.230	42.00	36.00	96.00	HCFRM23E42H4296-L1	603.725	109.491	42.00	42.00	96.00
HCFRM23E42H3696-W1	539.215	69.247	42.00	36.00	96.00	HCFRM23E42H4296-Q1	813.499	230.532	42.00	42.00	96.00
HCFRM23E42H42108-G2	780.956	143.662	42.00	42.00	108.00	HCFRM23E42H4296-S1	643.341	230.532	42.00	42.00	96.00
HCFRM23E42H42108-L2	683.941	86.224	42.00	42.00	108.00	HCFRM23E42H4296-W1	602.352	84.028	42.00	42.00	96.00
HCFRM23E42H42108-Q2	919.805	143.662	42.00	42.00	108.00						
HCFRM23E42H42108-S2	727.417	143.662	42.00	42.00	108.00						
HCFRM23E42H42108-W1	696.170	66.172	42.00	42.00	108.00						
HCFRM23E42H42108-W2	696.447	66.172	42.00	42.00	108.00						
HCFRM23E42H42120-G2	837.500	143.662	42.00	42.00	120.00						
HCFRM23E42H42120-L2	728.979	86.224	42.00	42.00	120.00						
HCFRM23E42H42120-Q2	992.567	143.662	42.00	42.00	120.00						
HCFRM23E42H42120-S2	777.685	143.662	42.00	42.00	120.00						
HCFRM23E42H42120-W1	741.024	66.172	42.00	42.00	120.00						
HCFRM23E42H42120-W2	741.302	66.172	42.00	42.00	120.00						
HCFRM23E42H42144-G2	950.589	204.369	42.00	42.00	144.00						
HCFRM23E42H42144-L2	819.056	86.224	42.00	42.00	144.00						
HCFRM23E42H42144-Q2	1,138.095	204.369	42.00	42.00	144.00						
HCFRM23E42H42144-S2	878.221	204.369	42.00	42.00	144.00						
HCFRM23E42H42144-W2	831.011	66.172	42.00	42.00	144.00						
HCFRM23E42H4260-G1	522.073	143.662	42.00	42.00	60.00						
HCFRM23E42H4260-L1	469.356	86.224	42.00	42.00	60.00						
HCFRM23E42H4260-Q1	596.379	143.662	42.00	42.00	60.00						
HCFRM23E42H4260-S1	493.364	143.662	42.00	42.00	60.00						
HCFRM23E42H4260-W1	468.530	66.172	42.00	42.00	60.00						
HCFRM23E42H4272-G1	578.617	204.369	42.00	42.00	72.00						
HCFRM23E42H4272-L1	514.395	86.224	42.00	42.00	72.00						
HCFRM23E42H4272-Q1	669.144	204.369	42.00	42.00	72.00						
HCFRM23E42H4272-S1	543.632	204.369	42.00	42.00	72.00						
HCFRM23E42H4272-W1	513.385	66.172	42.00	42.00	72.00						
HCFRM23E42H4284-G1	635.182	178.447	42.00	42.00	84.00						
HCFRM23E42H4284-L1	559.453	103.643	42.00	42.00	84.00						
HCFRM23E42H4284-Q1	741.928	178.447	42.00	42.00	84.00						
HCFRM23E42H4284-S1	593.920	178.447	42.00	42.00	84.00						