

# SHARP

Be Original.

MX-4061  
MX-3061

Digital Full Colour Multifunctional System



**A Savvy Workflow Optimiser  
for Your Busy Office**



simply better **business**

# Fast Output and Smart Functions for Simply Better **Business**

Transform your office into a smart hub with this full-colour A3 MFD. Packed with user-friendly functions, this speedy document powerhouse pushes productivity to the next level. Thanks to its secure network and cloud integration, the MFD keeps your office safely connected and helps everyone on your team work smarter.



Home screen



## Simply Better **Process**

Transform the way you use information in your business by connecting this new MFD to a variety of mobile devices and cloud services. Now you don't have to be confined to the office—you and your team can work anytime, anywhere. The amazing flexibility of this Sharp MFD can help you grab new business opportunities and boost your bottom line.

**Business owners / directors**



### Link to Public Cloud and Mobile Printing Services\*

This MFD enables single sign-on for easy access to public cloud services such as Google Drive™, OneDrive® for Business, SharePoint® Online, Box, and Dropbox. It also supports Google Cloud Print™ and Sharp Print Service Plugin mobile printing services.

\* For details, see pages 5 and 6.

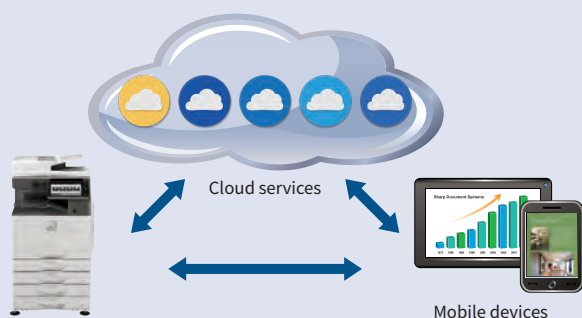

### Business Card Management

It's easy to manage a database of business cards with this MFD. Simply place multiple cards on the MFD's document glass (platen) to scan them all at once. The MFD reads contact details on each card via OCR and then exports those details to a third-party contact management system of your choice. This saves you the hassle of having to input details manually.



# Simply Better Experience

Sharp's proprietary technologies give this MFD quick warm-up and first copy times. A motion sensor lets you use the machine without feeling like you have to wait. Thanks to its intuitive operation and superb usability, the MFD simplifies even the most complex work processes and help you finish document jobs fast.

Office users



## 10.1-Inch Colour LCD Touchscreen

Operating the MFD is easy and intuitive with the 10.1-inch colour LCD touchscreen. Just tap your dedicated user icon to access a personally customised operation screen. In Easy UI mode, the touchscreen displays simple icons for frequently used functions like duplexing and paper size selection. And with the Advanced Preview function, you can check document finishes, edit pages in advance, and more.



Quick login

Preview mode (3D)

## Motion Sensor

A built-in motion sensor detects your approach to the MFD and wakes it from Sleep mode. The control panel lights up and the machine finishes warming up as you enter your desired copy or scan settings. Then, with a minimum of waiting, you simply push the Start button to get the job underway.



Detection range can be set to three different ranges

# Simply Better Admin

This MFD fits securely and seamlessly into your office system. An advanced security environment and easily viewable administration tools reduce the workload for system administrators and give full support to their management duties.

IT managers / administrators



## Secure Access Control

The MFD supports the **Active Directory**® service, which lets you use the machine's log-on credentials for network folders. With centralised management of multiple user credentials, system administrators are able to keep track of MFD usage, which makes for an efficient and highly secure operational environment. And with **single sign-on**, you can access cloud services and internal network folders from the MFD by simply logging in to it—there's no need to re-enter your IDs and passwords.

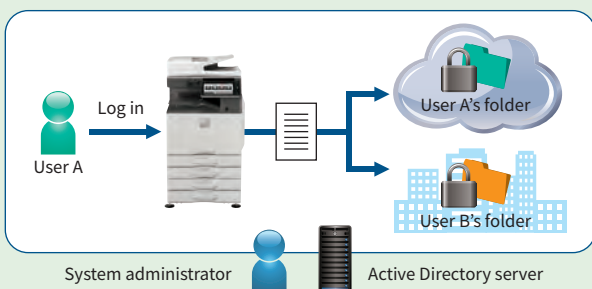

## Integrated Device Management

As a system administrator, you can get the most out of a Sharp document system by using Sharp's efficiency-boosting device management tools. From a single location, you can use Sharp Remote Device Manager\* (SRDM) to manage multiple Sharp MFDs. This includes everything from system setup, user access, and security settings to troubleshooting and maintenance.

\* Contact a Sharp customer representative for availability and other details.

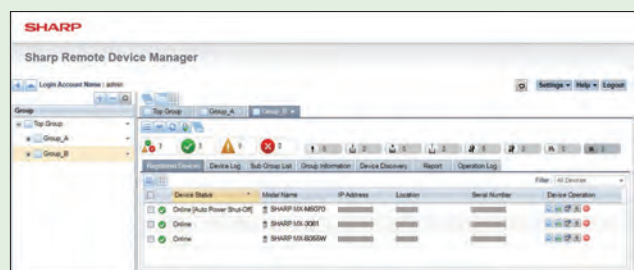



# HIGH PRODUCTIVITY

## Super-Efficient Colour and B/W Output

This MFD delivers a fast output of 40/30 ppm\* in B/W and in full colour. The first copy comes out in just 4.7 seconds in B/W and 6.7 seconds in full colour, saving you valuable time when performing multiple short-run jobs.

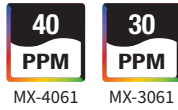

\* A4, long-edge feeding

## Versatile Paper Handling

Most of the MFD's paper trays accommodate a wide variety of paper, in sizes up to SRA3 and in weights up to 300 g/m<sup>2</sup>. The MFD can also handle extra-long paper up to 1,300 mm\*. In addition to plain paper, this MFD accommodates a number of other paper types, including coated, textured, embossed, and removable adhesive paper. Envelopes can be fed via a standard paper tray, so you can print more of them at once. Such versatile paper handling expands the range of possible printing applications.

\* Sharp recommends using the optional MX-LT10 for this function. Contact a Sharp customer representative for details.



## Print Release\*

The Print Release function lets you send documents to the main MFD, which acts as a server and stores them for printing out from any other compatible MFD on the network. This function comes in handy when the main MFD is in use or under maintenance, letting you finish your job with minimal waiting.

\* Contact a Sharp customer representative for details on the recommended maximum number of connectable MFDs.

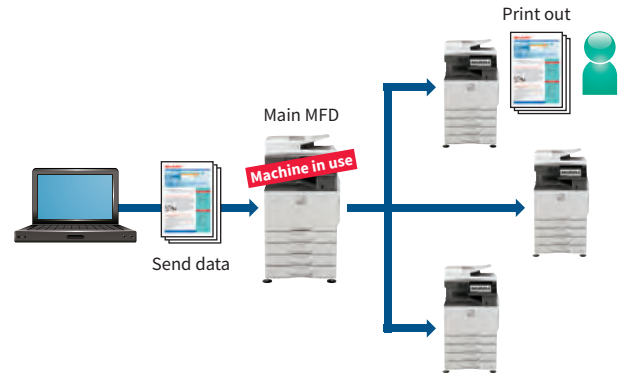

## Job Separator Tray

The Job Separator Tray option prevents copy/print/fax jobs from getting mixed together. Thanks to this interior output tray system, the MFD can provide up to four output destinations when it's equipped with an exit tray and external finisher.

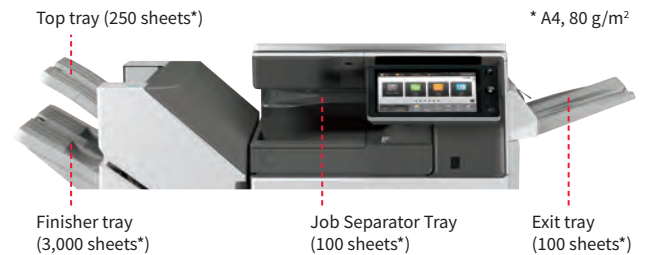

## Finisher Options

These MFDs offer plenty of finishing options to suit a variety of workplaces and applications.

	<b>MX-FN27 N Finisher</b>	<b>MX-FN29 Saddle Stitch Finisher</b>	<b>MX-FN31 Saddle Stitch Finisher</b>
Max. paper capacity* <sup>1</sup>	500 sheets	1,000 sheets	3,000 sheets
Stapleless stapling	Yes	-	Yes
Manual stapling	Yes	-	Yes
Saddle stitching	-	Yes	Yes
Punching* <sup>2</sup>	Yes	Yes	Yes

\*1: A4, 80 g/m<sup>2</sup>

\*2: Requires optional punch module

### Stapling

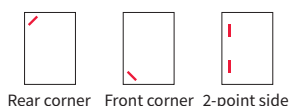

### Punching

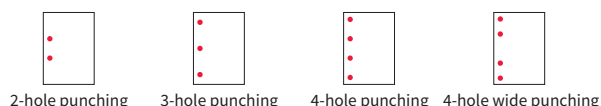

### Saddle stitching

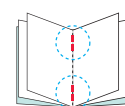

## Stapleless Stapler

To make paper recycling easy and to save on stapler costs, a staple-free stapler crimps the corners of paper to keep up to five sheets securely bound.



## Manual Stapler

You can quickly staple documents at the MFD as needed without using a conventional stapler. A real time-saver if you want to, say, restaple documents that were unstapled for copying.



## Office Direct Printing\*

Print common Microsoft® Office files without using a PC. With this MFD, you can print a Word, Excel®, or PowerPoint® file directly from a mobile device, cloud service, USB drive, or file server.

\* The actual printout may look different from what is displayed on the computer screen. This function is enabled via Qualcomm® DirectOffice™ technology.

## High-Efficiency Scanning

The MFD's standard equipped 100-sheet RSPF (reversing single pass feeder) efficiently feeds in either one- or two-sided originals. With a scanning speed of up to 80 opm\* (one-sided) for both colour and B/W documents, the MFD can complete large jobs with ease and efficiency.

\* Originals per minute; when feeding A4 sheets



## Multiple Scan Destinations

Scanned documents can be distributed in a number of ways. For example, they can be sent as e-mail attachments or they can be scanned directly to an FTP server for storage. A standard-equipped compact PDF function ensures that PDF files are sent and received smoothly. When you're scanning large-volume documents, the MFD saves the data on its hard disk and generates a URL for accessing that data. You can then e-mail recipients this URL rather than the full document, thereby reducing the load on the mail server.

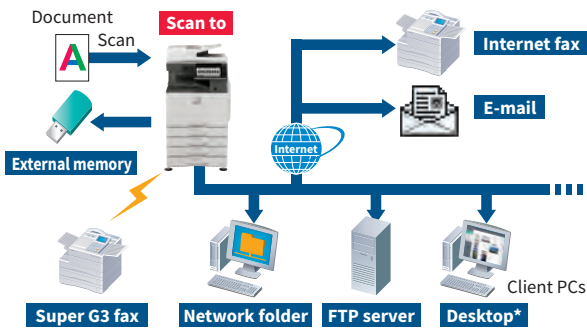

\* Requires optional Sharpdesk License Kit.

## Versatile Fax Functions (option)

- **Super G3 Fax** function
- **Internet Fax** lets you exchange faxes via e-mail
- **PC-Fax** sends PC documents directly to a fax machine via a phone line

## Automated Scanner Settings\*1

Tap on the LCD touchscreen's Auto Set button to have the MFD perform a host of actions automatically. It can determine scan resolution, skip blank pages in a multi-page document, or reorient pages mixed in upside down. The MFD can also tell whether a document being scanned is colour or B/W. If it is B/W it can automatically select the optimal setting for text—monochrome or greyscale. What's more, it can adjust skewed documents\*2, so you don't have to re-scan them. Automatic functions like these save you time and effort, while ensuring optimal scan results

\*1: Easy UI mode only

\*2: PDF format only

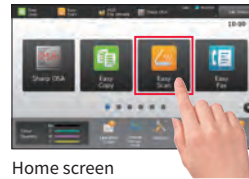

Home screen

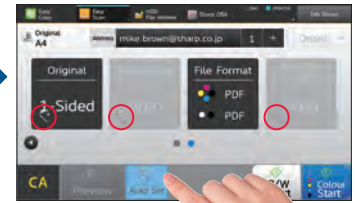

Easy scan mode

## Convert Documents via OCR

OCR capability on this MFD lets you convert a scanned document into a searchable PDF file or into an editable Office Open XML (docx, xlsx, pptx) file. This means you can do speedy text searches, even with large-volume documents, and you can easily copy and paste text data into other applications. Functions like these help you maximise work efficiency.

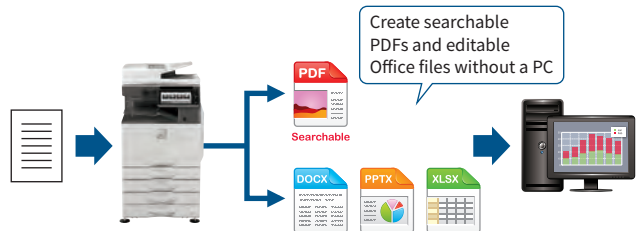

## Multicrop and Image Crop Functions

Multiple receipts, photos, and other items can be scanned all at once, with each one saved as a separate file. This helps you streamline the filing of receipts and bills. The MFD can also crop photos from documents such as magazine pages and save them as individual files.



Example: Scanning multiple photos

Scan

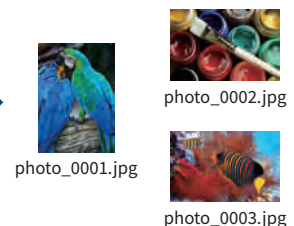

# SECURE INFORMATION SHARING

## Link to Cloud Services

This MFD doesn't just connect to your local server. It also connects with cloud services directly from its control panel. You can upload scanned data to Google Drive, OneDrive for Business, SharePoint Online, Box, or Dropbox—or print directly from any of them. Cloud services help to make setting up and managing a server in your company more efficient. Once you log in to the MFD, its single sign-on feature allows you to quickly access multiple software services without having to sign in to each one separately.

Contact a Sharp customer representative for details.

## Application Portal\*

Sharp is creating an app store for its MFDs, to make them even more useful to your business. Like a smartphone app store, Sharp's Application Portal will offer apps that you can download and install on your MFD. You'll be able to access the application server and download apps directly from the MFD.

\* Contact a Sharp customer representative for details.

## Link with Mail Servers

Scanned data can be conveniently sent via your regular Gmail™ or Microsoft Exchange/Online account. Sending e-mail is as easy as choosing a recipient from your address book on the mail server. Scanned data that you send can be stored on the mail server with other sent items.

## Sharp OSA (Open Systems Architecture)

Sharp OSA technology allows you to interact with intra-company systems and network applications right from the LCD control panel, offering a new realm of control and convenience. And since Sharp OSA utilises industry-standard network protocols, the MFD can easily integrate with third-party document management systems, enterprise resource planning software, workflow applications, and more. The latest version of Sharp OSA can reach beyond the firewall, enabling extensive system construction as well as services delivered over the Internet such as cloud services.

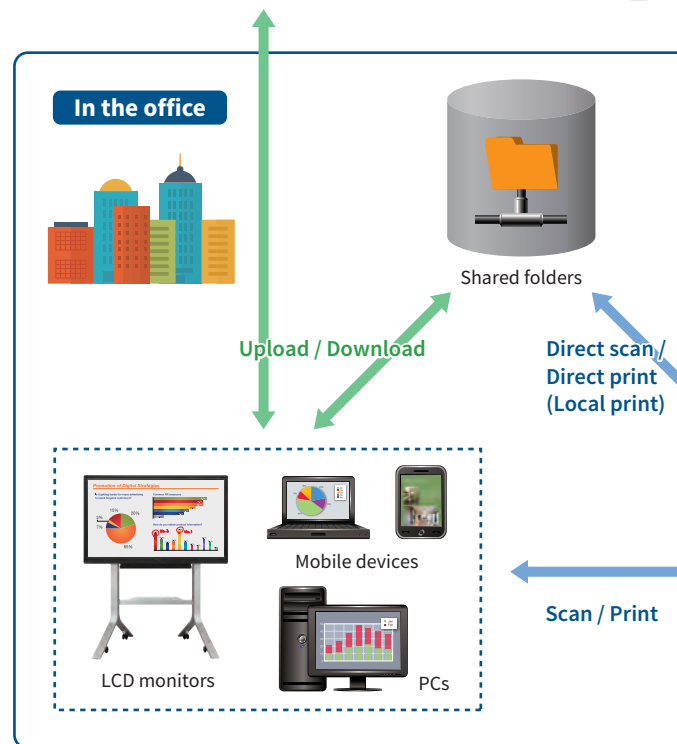
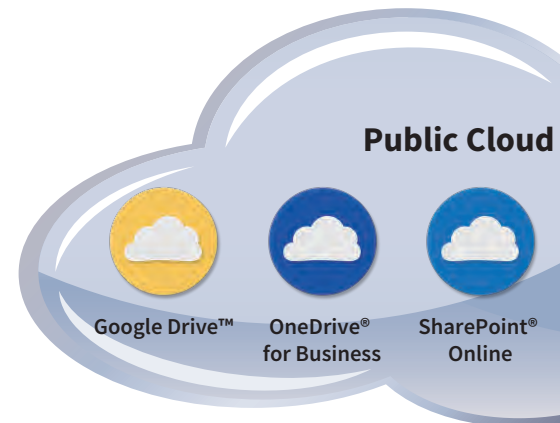

## Multi-Layered Security

### Network Security and Access Control

- **S/MIME** provides secure e-mail communications\*  
\* Only when e-mailing scanned data.
- **SSL** (secure sockets layer) and **IPsec** data encryption technologies ensure secure network communications
- **User Authentication** covering up to 1,000 users prevents unauthorised MFD use by requiring access passwords
- **Active Directory** enables integrated management of user credentials, thereby providing a highly secure and efficient environment for system administrators
- **Whitelisting** protects the MFD from fraudulent programs trying to access the file system and obtain information
- **Image Job Log\*** creates and externally stores an image file (PDF) and a log file (XML) for each job. This helps identify unauthorised use of the MFD.

\* Contact a Sharp customer representative for details on activating this function.

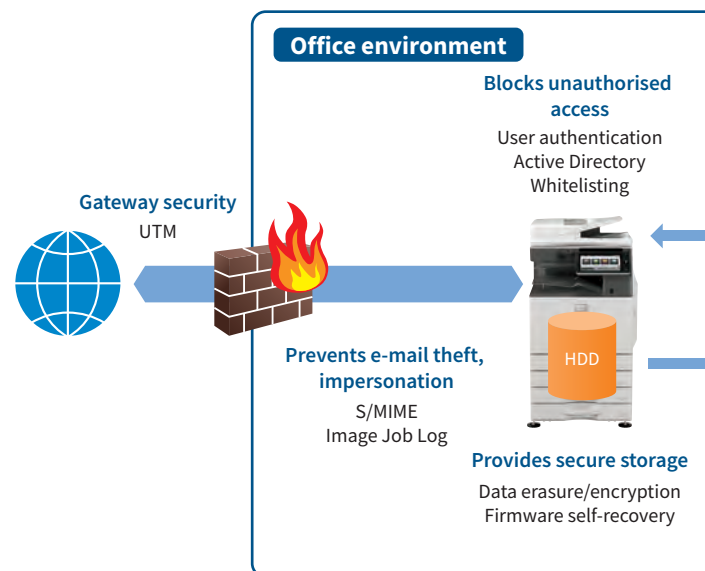

## Link with Mobile Devices

Connecting the MFD to one or more mobile devices is easy, and it expands your options for sharing data. Not only can you send scanned documents to mobile devices such as smartphones and tablets, you can also print documents or photos sent from those devices.

- The **Sharpdesk Mobile**<sup>\*1</sup> print/scan app lets you easily link your mobile device to the MFD by simply holding it over the MFD's NFC tag<sup>\*2</sup> or by scanning the MFD's QR Code<sup>®</sup>.

<sup>\*1</sup>: For details, see the Sharpdesk Mobile support website:  
[http://sharp-world.com/products/copier/docu\\_solutions/mobile/sharpdesk\\_mobile/](http://sharp-world.com/products/copier/docu_solutions/mobile/sharpdesk_mobile/)

<sup>\*2</sup>: The NFC interface is for Android™ devices.

- **AirPrint**, **Google Cloud Print**, and **Sharp Print Service Plugin** are supported.

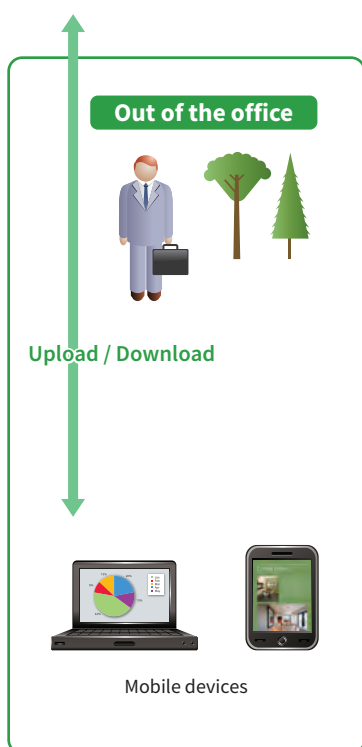
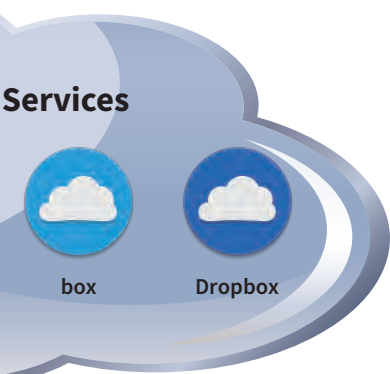

## Wireless Connections

The MFD offers ultra-handy wireless access, enabling convenient access to the MFD even from places where it's difficult to connect a LAN cable.

## Secondary Ethernet Port\*

A secondary Ethernet port allows the MFD to support two separate networks. You can set up different IP addresses and security settings for each line—one in-house, say, and one for visitors. Alternatively, the MFD could be set up to access a web-connected office network as well as a high-security offline network.

\* Requires an Ethernet adaptor that supports two lines. Contact a Sharp customer representative for details.

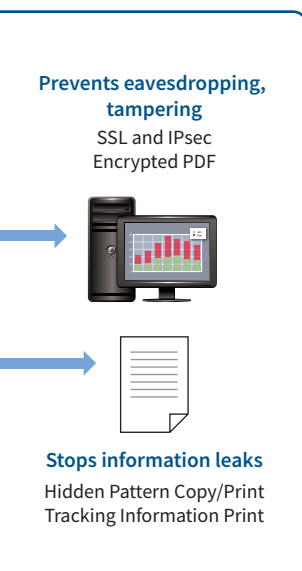
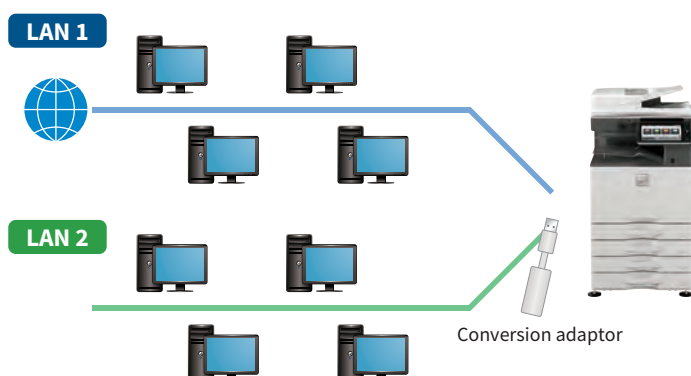

## Document Protection

- **Document Control**<sup>\*</sup> prevents unauthorised use of confidential documents by embedding copy prevention data in them  
<sup>\*</sup> Requires optional MX-FR62U. May not work with certain types of paper, documents (such as those with a large volume of photos), or MFD settings.
- **Hidden Pattern Copy/Print** embeds a watermark, such as "Confidential" or "Not for Copy," onto a document
- **Tracking Information Print** prints the MFD user's name, the date, job ID, and other specifics on printouts

## Data/System Protection

- **Job data is automatically encrypted**<sup>\*</sup> before being saved to the MFD's internal storage. Once a job is finished, its encrypted **data is erased**<sup>\*</sup> by up to 10 automatic overwrites.  
<sup>\*</sup> Contact a Sharp customer representative for details on activating these functions.
- Retained data can be **erased** when it's time to replace the MFD, preventing the leakage of confidential information
- **Firmware self-recovery** prevents data leaks and firmware damage by automatically restoring files when abnormal activity is detected

# EASE OF USE

## Direct Printing/Scanning with USB Drives

Insert a USB drive into the MFD and a print/scan command screen will automatically pop up on the LCD. Right away you can print files from the USB drive—which are displayed as thumbnails—or you can scan documents directly to the USB drive.



## Printer Driver with Easy Setup

The printer driver setup window features a simple design that includes larger buttons and drop-down menus, making it easier than ever to use printer functions.

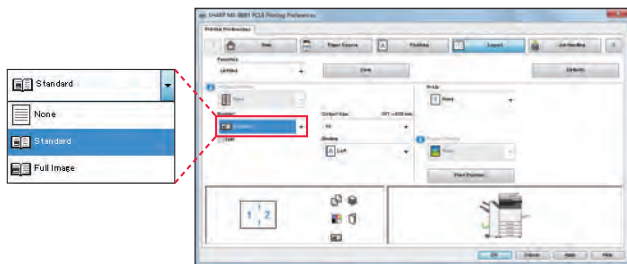

## Utility Table

An optional Utility Table gives you a handy place to lay documents or a mobile device such as a tablet when you're working at the MFD. An IC card reader\* can be built underneath the table.

\* Commercially available



## LED Lamps

Next to the control panel are LED lamps in three colors: red, green, and blue. The blue LED lamps light up in distinct patterns to indicate things like MFD startup, user authentication, and specific user operations. The red and green LED lamps light up to notify you—even from a distance—of the status of the machine.



Status lamps



Communication lamps

## Free-Tilting Control Panel

The control panel can be tilted freely at various angles for easy viewing and easy operation, even from a wheelchair. Having the control panel at the perfect viewing angle means you can reduce eye strain and avoid making input errors.



## Remote Operation\*

The Remote Operation function lets you display the MFD's main control panel on the screen of your PC or mobile device. From a remote location, you can then check MFD settings or reprint data stored on the MFD. This function also enables the administrator to guide an MFD user through necessary procedures and allows remote MFD operation from a wheelchair.

\* Requires VNC application. Simultaneous remote operation from two or more PCs or mobile devices is not possible. Remote operation also depends on the network environment and applications being used. Contact a Sharp customer representative for details.

## Seamless Document Management

### Sharpdesk\*<sup>1</sup>

With Sharpdesk integrated document management software, scanned files can be organized, edited, converted, and combined with ease. What's more, Full Text Search\*<sup>2</sup> makes it easy to retrieve your documents.

\*1: Requires optional Sharpdesk License Kit.

\*2: Full text search of PDF files requires Adobe® PDF iFilter.

### Easy Sharing of Application Files

The MFD's hard disk enables files created with applications such as Word and Excel to be saved in their original file format and shared across the office network\*.

\* Sharp recommends backing up data saved to the MFD's hard disk.

### Document Filing

Document Filing allows files that have been copied, printed, scanned, or faxed\* to be stored by job in a Quick File folder, Main folder, or Custom folder on the MFD's hard disk. From there, they can be instantly recalled for printing and sending at a later time. The Main folder and Custom folder require users to enter a password for access, thereby protecting your sensitive data.

\* For fax and Internet fax jobs, only transmitted data (not received faxes) can be saved via the Document Filing function.



## Easy, High-Quality Copying and Scanning

Through an advanced three-step process, **Auto Colour Mode** provides faithful and fully automated copying and scanning in both colour and B/W—all with a simple press of the Start button. Here's how it works: **Auto Colour Selection** automatically determines whether a page is colour or B/W. **Auto Original Type Selection** then analyses page contents to distinguish between different components (such as photos, text, and text on halftone backgrounds) and selects the appropriate mode. It uses machine learning to optimally reproduce text and images. Finally, **Background Suppression** automatically removes unnecessary background colour.

### Auto Colour Mode

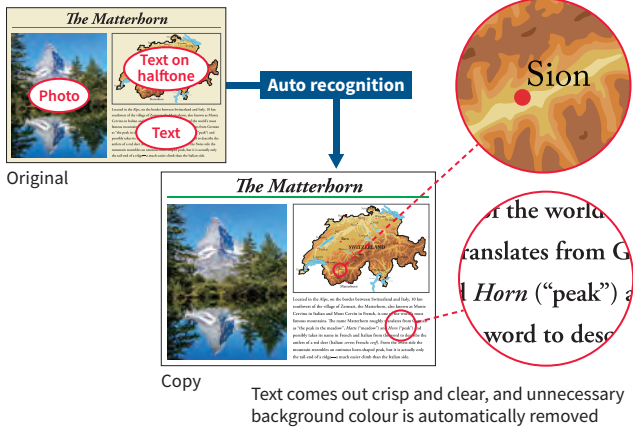

## Developer Refresh System

By discharging old developer little by little and continuously replacing it with new developer, this system prevents developer deterioration and ensures stable print quality over the long term.

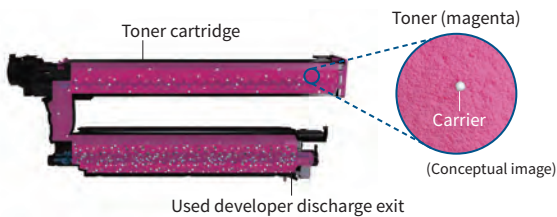

## PCL 6 and True Adobe® PostScript® 3™

For better graphics handling, this MFD comes standard with both PCL 6 and true Adobe PostScript 3. In addition, the PostScript driver allows you to use the dot screening technique so that you can emulate the high-quality printing of commercial offset printers.

## High-Resolution Output

The MFD's print engine supports 1,200 × 1,200 dpi printing and copying\*. Digital smoothing technology delivers print and copy resolution at the equivalent of 9,600 × 600 dpi, giving you ultra-clear image quality. Fine lines and small text come out looking crisper and easier to read.

\* Copying in B/W only.

## Auto Process Control

To maintain consistently high image quality during large-volume print jobs, this MFD employs a periodic colour calibration system. Image density sensors read high-density and halftone colour patches and feed the information back to the image control unit. The MFD can then make adjustments to minimise colour variance between pages.

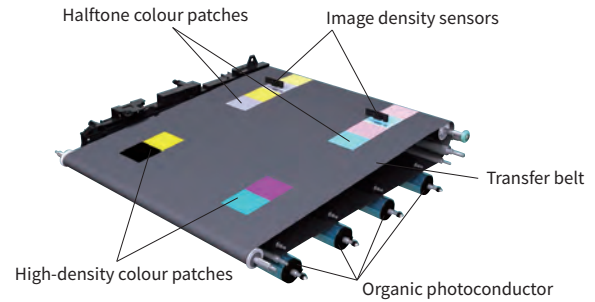

## Line Width Adjustment

This function adjusts the width of lines. Fine lines, which are otherwise difficult to render properly, turn out sharp and crisp. Intricate line drawings, complex graphs and charts, and detailed spreadsheets are reproduced with exceptional quality and precision.

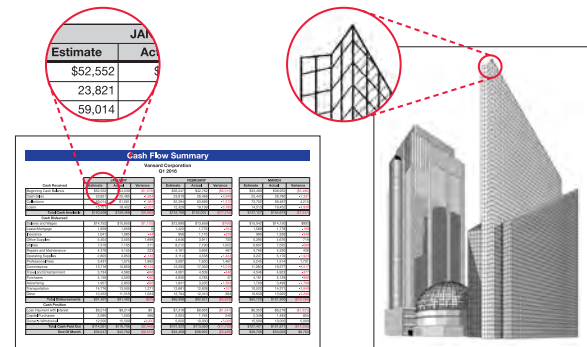

## Image Enhancement

Smooth borders are added to the edges of lines and text, including outline text. This serves to improve edge contrast, resulting in noticeably clearer, crisper lines and text.

## Copying Originals with Highlighted Lines

Highlighter markings, such as lines, check marks, and circles on a document are usually hard to reproduce. But with this MFD, they turn out clearly visible in copies.



# ENVIRONMENT-FRIENDLY

## Low Power Consumption

To reduce power consumption, Sharp has applied its advanced technologies across all areas of this MFD, including the hardware, software, electrical system, and supplies. As a result, the MFD delivers exceptional energy efficiency.

## Eco-Friendly Toner

Mycrotoner-Crystal is filled with low-melting-point material. This toner is able to fuse at low temperatures, resulting in reduced energy consumption.

## Automatic Toner Cartridge Eject Function

This function expels completely empty cartridges in preparation for replacement. The cartridge is replaced only after all the toner has been consumed, thereby ensuring efficient use of toner. Because you can tell at a glance when cartridges are empty, they are fast and easy to replace.



## Eco Scan

The Eco Scan function saves energy by keeping the fusing system shut down during jobs that don't require its use—for example, during image sending and Document Filing.

## Auto Power Shut-Off Mode

Based on prior usage patterns, the MFD automatically determines how long to wait before going into auto power shut-off mode. Shortly before this mode begins, a message appears on the LCD indicating that the MFD will soon shut down and giving you the option to continue operation.

## Power ON/OFF Schedule

This function automatically turns the MFD on or off per administrator-set schedules.

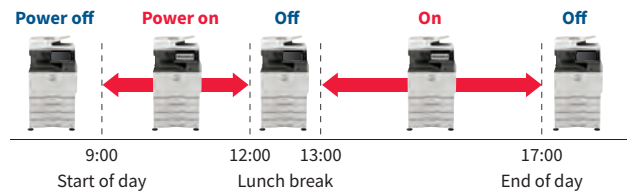

## Eco Recommendation

This function suggests environmentally friendly settings before a print\*/copy command is executed from the control panel.

\* For printing Document Filing data and direct printing (FTP/SMB/USB)

# SYSTEM CONFIGURATION

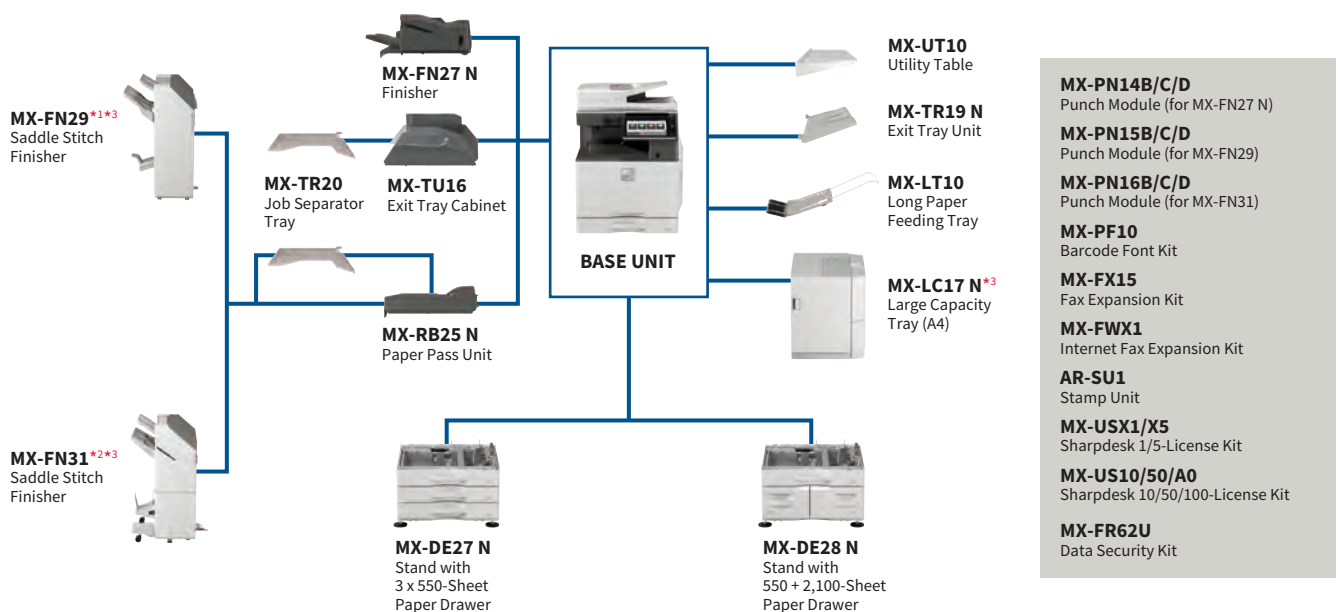

\*1: Max. paper capacity: 1,000 sheets \*2: Max. paper capacity: 3,000 sheets \*3: Requires MX-DE27 N/DE28 N.

# SPECIFICATIONS FOR OPTIONAL EQUIPMENT

## MX-TR20 Job Separator Tray

Paper size	A3W to A5
Paper capacity	100 sheets (A4)

## MX-FN27 N Finisher

Paper size	Non offset	A3W to A5
	Offset/staple	A3 to B5* <sup>1</sup>
	Stapleless staple	A3 to B5* <sup>2</sup>
Paper capacity	Non offset/offset	500 sheets (A4 or smaller), 250 sheets (B4 or larger)
	Staple	30 sets or 500 sheets (A4 or smaller), 30 sets or 250 sheets (B4 or larger)
	Stapleless staple	30 sets
Stapling capacity	Staple	50 sheets (A4, B5* <sup>3</sup> ), 30 sheets (A3, B4)
	Stapleless staple	5 sheets* <sup>4</sup>
	Manual staple	Total paper thickness 4 mm or less (40 sheets)
Staple position	Staple mode	3 locations (front, rear, or 2-point stapling)
	Stapleless staple mode	1 location (rear)
	Manual staple mode	1 location

## MX-FN29 Saddle Stitch Finisher

Paper size	Non offset	A3W to A5
	Offset	A3W to A5
	Staple	A3W to B5
Paper capacity	Finisher tray (non offset/offset)	1,000 sheets (A4), 500 sheets (other sizes)
	(staple)	100 sets or 1,000 sheets (A4), 50 sets or 500 sheets (other sizes)
	Top tray	250 sheets (A4 or smaller), 50 sheets (B4 or larger)
	Saddle stitch tray	7 sets of 11–15 sheets, 10 sets of 6–10 sheets, 20 sets of 1–5 sheets
Stapling capacity		50 sheets (A4, B5), 30 sheets (A3, B4)
Staple position		3 locations (front, rear, or 2-point stapling)

## MX-FN31 Saddle Stitch Finisher

Paper size	Non offset	A3W to A5
	Offset/staple	A3 to B5* <sup>1</sup>
	Stapleless staple	A3, A4* <sup>3</sup>
Paper capacity	Finisher tray (non offset/offset)	3,000 sheets (A4, B5), 1,500 sheets (other sizes)
	(staple)	200 sets or 3,000 sheets (A4, B5), 100 sets or 1,500 sheets (other sizes)
	(stapleless staple)	200 sets (A4), 100 sets (A3)
	Top tray	250 sheets (A4* <sup>3</sup> , B5* <sup>3</sup> , A5), 125 sheets (other sizes)
	Saddle stitch tray	10 sets of 11–20 sheets, 15 sets of 6–10 sheets, 25 sets of 1–5 sheets
Stapling capacity	Staple	65 sheets (A4* <sup>3</sup> , B5* <sup>3</sup> ), 30 sheets (other sizes)
	Stapleless staple	5 sheets* <sup>4</sup>
	Manual staple	Total paper thickness 9 mm or less (65 sheets)
Staple position	Staple mode	3 locations (front, rear, or 2-point stapling)
	Stapleless staple mode	1 location (rear)
	Manual staple mode	1 location

Note: All specifications relating to paper capacity refer to 80 g/m<sup>2</sup> paper.

\*1: Only long-edge feeding can be used with B5 paper. \*2: Only long-edge feeding can be used with A4 and B5 paper.

\*3: Long-edge feeding. \*4: Guaranteed stapleable weight is up to 64 g/m<sup>2</sup> (4 sheets up to 81.4 g/m<sup>2</sup> and 3 sheets up to 105 g/m<sup>2</sup>). \*5: Accepts North American paper sizes.

\*6: Accepts ISO-standard paper sizes. \*7: Guaranteed punchable weight is 60 to 128 g/m<sup>2</sup>. \*8: Only short-edge feeding can be used with A5 paper.

## Punch Modules

Model name	For MX-FN27 N	<b>MX-PN14B</b> * <sup>5</sup>	<b>MX-PN14C</b> * <sup>6</sup>	<b>MX-PN14D</b>
	For MX-FN29	<b>MX-PN15B</b> * <sup>5</sup>	<b>MX-PN15C</b> * <sup>6</sup>	<b>MX-PN15D</b>
	For MX-FN31	<b>MX-PN16B</b> * <sup>5</sup>	<b>MX-PN16C</b> * <sup>6</sup>	<b>MX-PN16D</b>
Number of holes		3	2 or 4	4 (wide)
Paper weight		55 to 300 g/m <sup>2</sup> * <sup>7</sup>		

## MX-TR19 N Exit Tray Unit

Paper size	A3W to A5
Paper capacity	100 sheets (A4)

## MX-DE27 N Stand with 3 x 550-Sheet Paper Drawer

Paper size	Upper/middle/lower tray	A3W to A5* <sup>8</sup>
Paper capacity	Upper/middle/lower tray	550 sheets each

## MX-DE28 N Stand with 550 + 2,100-Sheet Paper Drawer

Paper size	Upper tray	A3W to A5* <sup>8</sup>
	Lower right tray	A4, B5,
	Lower left tray	A4,
Paper capacity	Upper tray	550 sheets
	Lower right tray	900 sheets
	Lower left tray	1,200 sheets

## MX-LC17 N Large Capacity Tray

Paper size	A4, B5,
Paper capacity	3,000 sheets

## MX-LT10 Long Paper Feeding Tray

Paper size	Max. 1,300 mm long
Paper capacity	1 sheet

## SPECIFICATIONS

### General

Type	Desktop	
Engine speed	A4*1: Max. 40/30 ppm A3: Max. 20/16 ppm SRA3: Max. 18/15 ppm	
Control panel display	10.1-inch colour LCD touchscreen	
Paper size	Max. SRA3, min. A5	
Paper capacity (80 g/m <sup>2</sup> )	Standard: 650 sheets (550-sheet tray and 100-sheet multi-bypass tray) Maximum: 6,300 sheets (650 sheets & optional 550 + 2,100-sheet tray and 3,000-sheet tray)	
Paper weight	Tray: 60 g/m <sup>2</sup> to 300 g/m <sup>2</sup> Multi-bypass tray: 55 g/m <sup>2</sup> to 300 g/m <sup>2</sup>	
Warm-up time*2	20 sec.*3	
Memory	5 GB (copy/print shared)	500 GB HDD*4
Power requirements	Rated local AC voltage ±10%, 50/60 Hz	
Power consumption	Max. 1.84 kW (220 V to 240 V),	
Dimensions (W x D x H)*5	608 x 650 x 834 mm	
Weight (approx.)	79 kg	

### Copier

Original paper size	Max. A3	
First copy time*6	Colour: 6.7 sec.	B/W: 4.7 sec.
Continuous copy	Max. 9,999 copies	
Resolution	Scan (colour): 600 x 600 dpi Scan (B/W): 600 x 600 dpi, 600 x 400 dpi Print (colour): 600 x 600 dpi, 9,600 (equivalent) x 600 dpi (depending on copy mode) Print (B/W): 1,200 x 1,200 dpi, 600 x 600 dpi, 9,600 (equivalent) x 600 dpi (depending on copy mode)	
Gradation	Equivalent to 256 levels	
Zoom range	25% to 400% (25% to 200% using RSPF) in 1% increments	
Preset copy ratios	Metric: 10 ratios (5R/5E), inch: 8 ratios (4R/4E)	

### Network Scanner

Scan method	Push scan (via control panel) Pull scan (TWAIN-compliant application)
Scan speed*7	[Colour & B/W] Max. 80 originals/min.
Resolution	Push scan: 100, 150, 200, 300, 400, 600 dpi Pull scan: 75, 100, 150, 200, 300, 400, 600 dpi 50 dpi to 9,600 dpi via user setting
File formats	TIFF, PDF, PDF/A-1a, PDF/A-1b, encrypted PDF, XPS, compact PDF*8, JPEG*8, searchable PDF, OOXML (pptx, xlsx, docx), text (TXT [UTF-8]), rich text (RTF)
Scan destinations	Scan to e-mail/desktop*9/FTP server/network folder (SMB)/USB drive/HDD

- \*1: Long-edge feeding.
- \*2: In a standard measurement environment. May vary depending on operating conditions and environment.
- \*3: When starting the MFD via the power button. 33 sec. when starting via the main power switch.
- \*4: HDD capacity depends on procurement and sourcing status.
- \*5: Including adjusters and protruberances.
- \*6: Short-edge feeding of A4 sheets from 1st paper tray, using document glass, without Auto Colour Selection and Auto Colour mode, MFD in fully ready condition. May vary depending on operating conditions and environment.
- \*7: Based on Sharp's A4 standard chart, using document feeder, long-edge feeding, and one-sided scanning. Using factory default settings with Auto Colour Selection off. Scan speed will vary depending on the type of document and the scan settings.
- \*8: Colour/greyscale only.
- \*9: Requires optional Sharpdesk License Kit.
- \*10: Storage capacity will vary depending on the type of document and the scan settings.
- \*11: Some features require optional equipment.
- \*12: Based on Sharp's standard chart with approx. 700 characters (A4 long-edge feeding) at standard resolution in Super G3 mode, 33,600 bps, JBIG compression.

### Document Filing

Document filing capacity*10	Main and custom folders: 20,000 pages or 3,000 files Quick file folder: 10,000 pages or 1,000 files
Stored jobs*11	Copy, print, scan, fax
Storage folders	Quick file folder, main folder, custom folder (max. 1,000 folders)

### Network Printer

Resolution	1,200 x 1,200 dpi, 600 x 600 dpi, 9,600 (equivalent) x 600 dpi
Interface	USB 2.0 (host, high-speed), 10Base-T/100Base-TX/1000Base-T, wireless LAN (IEEE 802.11 n/g/b)
Supported OS	Windows Server® 2008, Windows Server® 2008 R2, Windows Server® 2012, Windows Server® 2012 R2, Windows Server® 2016, Windows Server® 2019, Windows® 7, Windows® 8.1, Windows® 10 Mac OS 10.7, 10.8, 10.9, 10.10, 10.11, 10.12, 10.13, 10.14 & 10.15
Network protocols	TCP/IP
Printing protocols	LPR, Raw TCP (port 9100), POP3 (e-mail printing), HTTP, FTP for downloading print files, IPP, SMB, WSD
PDL	PCL 6 emulation, Adobe® PostScript® 3™
Available fonts	80 fonts for PCL, 139 fonts for Adobe PostScript 3

### B/W Facsimile (requires optional MX-FX15)

Compression method	MH/MR/MMR/JBIG
Communication protocol	Super G3/G3
Transmission time	Less than 3 seconds*12
Modem speed	33,600 bps to 2,400 bps with automatic fallback
Transmission resolution	From Standard (203.2 x 97.8 dpi) to Ultra Fine (406.4 x 391 dpi)
Recording size	A3 to A5
Memory	1 GB (built-in)
Greyscale levels	Equivalent to 256 levels

- Design and specifications are subject to change without prior notice.
- Google Drive, Google Cloud Print, Gmail, and Android are trademarks of Google LLC. The Google Drive trademark is used with permission from Google LLC. OneDrive, SharePoint, Active Directory, Microsoft, Excel, PowerPoint, Windows Server, and Windows are either registered trademarks or trademarks of Microsoft Corporation in the US and/or other countries. Box is a trademark, service mark, or registered trademark of Box, Inc. Dropbox is a trademark or registered trademark of Dropbox, Inc. QR Code is a registered trademark of DENSO WAVE INCORPORATED in Japan and other countries. PCL is a registered trademark of Hewlett-Packard Company. Adobe and PostScript 3 are either registered trademarks or trademarks of Adobe Systems Incorporated in the US and/or other countries. Mac is a trademark of Apple Inc., registered in the US and other countries. Qualcomm DirectOffice is a product of Qualcomm Technologies, Inc. and/or its subsidiaries. Qualcomm is a trademark of Qualcomm Incorporated, registered in the US and other countries. DirectOffice is a trademark of CSR Imaging US, LP, registered in the US and other countries, used with permission. All other brand names and product names may be trademarks or registered trademarks of their respective owners.

Qualcomm® DirectOffice™

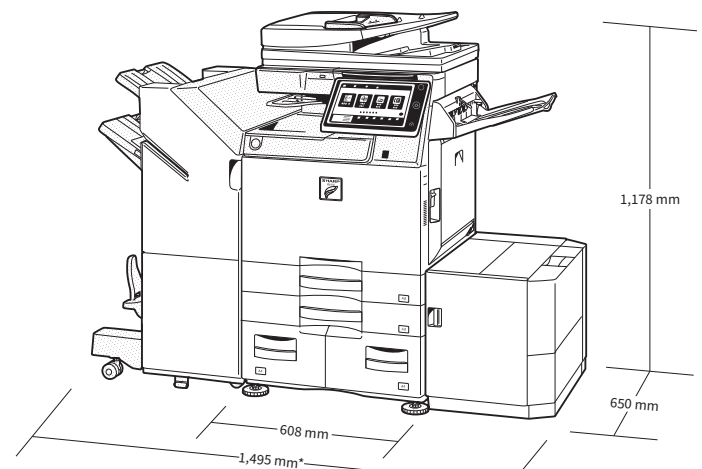

\* 1,649 mm when finisher tray and exit tray are extended.

Shown with optional equipment.

Distributed by:

# SHARP

SHARP CORPORATION OF AUSTRALIA PTY LTD

ABN 40 003 039 405  
P.O. Box 84, Macquarie Park, NSW 2113  
Tel: (02) 9830 4600  
www.sharp.net.au