

SHARP®



R-995DST R-995D(W)

**Convection Microwave Oven
OPERATION MANUAL WITH COOKING GUIDE**

Read all instructions carefully before using the oven

CONTENTS

OPERATION

| | |
|--------------------------------------|-------|
| Important Safety Instructions..... | 1 |
| Special Notes for Microwave | 2 |
| Installation Instructions..... | 3 |
| Specifications | 3 |
| Oven Diagram..... | 4 |
| Operation of Control Panel | 5 |
| Control Panel Display | 5 |
| Touch Control Panel Layout..... | 5 |
| Before Operating | 6 |
| Getting Started | 6 |
| Clock Setting | 6 |
| Stop/Clear..... | 6 |
| Clean the Oven Before First Use..... | 6 |
| Manual Operation..... | 7-9 |
| Microwave..... | 7 |
| Grill | 7 |
| Convection..... | 8 |
| Mix Cooking..... | 9 |
| Automatic Operation..... | 10-11 |
| Notes for Automatic Operation | 10 |
| Auto Menu | 10 |
| Sensor Cook..... | 11 |
| Convenience Cook | 11 |
| Weight Defrost | 11 |
| Other Convenient Features | 12-13 |
| Less or More Time Adjustment..... | 12 |
| +1min. Function | 12 |
| Multiple Sequence Cooking..... | 12 |
| Demonstration Mode | 12 |
| Info..... | 13 |
| Timer | 13 |
| Care and Cleaning | 14 |
| Service Call Check | 14 |

COOKING GUIDE

| | |
|---|------------|
| Helpful Hints | 15-16 |
| Microwave Cooking | 15 |
| Convection Cooking..... | 16 |
| Mix Cooking..... | 16 |
| Grilling | 16 |
| Cookware and Utensil Guide..... | 17 |
| Auto Menu Guide..... | 18-19 |
| Sensor Cook Guide | 20 |
| Convenience Cook Guide..... | 21 |
| Weight Defrost Guide | 22 |
| Manual Cooking Chart..... | 23-26 |
| Defrost Times for Meat | 23 |
| Fresh Vegetable..... | 24 |
| Rice & Pasta..... | 25 |
| Porridge | 25 |
| Scrambled Egg | 25 |
| Reheating/Defrosting Convenience Food | 26 |
| Recipes..... | 27-32 |
| Fish..... | 27 |
| Pork | 28 |
| Chicken..... | 29 |
| Vegetarian..... | 30 |
| Beef | 31 |
| Desserts | 32 |
| Warranty | 33 |
| Quick Reference Guide | Back cover |

IMPORTANT SAFETY INSTRUCTIONS

IMPORTANT SAFETY INSTRUCTIONS: READ CAREFULLY AND KEEP FOR FUTURE REFERENCE

1. This oven is designed to be used on a benchtop, on a shelf or built-in with a Sharp built-in kit. We do not recommend installing the oven under the benchtop or any other appliances. The appliance must not be placed in a cupboard. The appliance must not be installed behind a decorative door in order to avoid overheating. See page 3 for the installation. The oven door and the top of the oven may become hot during cooking. Place or mount the oven so that the bottom of the oven is 85 cm or more above the floor. Keep children away from the door to prevent them from burning themselves.
2. Ensure there is a minimum of free space above the oven of 40 cm. See page 3 for the other necessary spaces.
3. This appliance is intended to be used in household and similar applications such as:
 - staff kitchen areas in shops, offices and other working environments;
 - farm houses;
 - by clients in hotels, motels and other residential environments;
 - bed and breakfast type environmentsIt is not suitable for commercial, laboratory use.
4. The microwave oven is intended for heating food and beverages. Drying of food or clothing and heating of warming pads, therapeutic devices (eg. wheat bags), slippers, sponges, damp cloth and similar may lead to risk of injury, ignition or fire.
5. This appliance is not intended for use by persons (including children) with reduced physical, sensory or mental capabilities, or lack of experience and knowledge, unless they have been given supervision or instruction concerning use of the appliance by a person responsible for their safety.
6. Children should be supervised to ensure that they do not play with the appliance.
7. **WARNING:** Only allow children to use the oven without supervision when adequate instructions have been given so that the child is able to use the oven in a safe way and understands the hazards of improper use.
8. **WARNING:** When the appliance is operated in the combination mode (Mix Cooking), Convection Cooking, Grilling or Automatic Operations (except Weight Defrost), children should only use the oven under adult supervision due to the temperature generated.
9. **WARNING:** Accessible parts may become hot during use. To avoid burns young children should be kept away.
10. **WARNING:** If the door or door seals are damaged, the oven must not be operated until it has been repaired by an authorised SHARP service agent or microwave technician.
11. **WARNING:** Never adjust, repair or modify the oven yourself. It is hazardous for anyone other than an authorised SHARP service agent or microwave technician to carry out any service or repair operation which involves the removal of a cover which gives protection against exposure to microwave energy.
12. If the power supply cord of this appliance is damaged, it must be replaced by a service centre approved by SHARP in order to avoid a hazard.
13. **WARNING:** Liquids and other foods must not be heated in sealed containers since they are liable to explode.
14. Microwave heating of beverages can result in delayed eruptive boiling, therefore care must be taken when handling the container.
15. Eggs in their shell and whole hard-boiled eggs should not be heated on microwave modes since they may explode, even after microwave heating has ended. To cook or reheat eggs which have not been scrambled or mixed on microwave modes, pierce the yolks and the whites, or the eggs may explode. Shell and slice hard boiled eggs before reheating them on microwave modes.
16. Utensils should be checked to ensure that they are suitable for use in the oven. See Page 18. Use only microwave safe containers and utensils on microwave modes.
17. Metallic containers for food and beverages are not allowed during microwave modes.
18. The contents of feeding bottles and baby food jars must be stirred or shaken and the temperature checked before consumption, in order to avoid burns.
19. The door, outer cabinet, oven cavity, dishes and accessories will become very hot during operation. Care should be taken to avoid touching these areas. To prevent burns, always use thick oven gloves. Before cleaning make sure they are not hot.
20. When heating food in plastic or paper containers, keep an eye on the oven due to the possibility of ignition.
21. If smoke is observed, switch off or unplug the appliance and keep the door closed in order to stifle any flames.
22. The oven should be cleaned regularly and any food deposits removed.
23. Cleaning and user maintenance shall not be performed by children without supervision.
24. Failure to maintain the oven in a clean condition could lead to deterioration of the surface that could adversely affect the life of the appliance and possibly result in a hazardous situation.
25. Do not use harsh abrasive cleaners or sharp metal scrapers to clean the oven door glass since they can scratch the surface, which may result in shattering of the glass.
26. The appliance must not be cleaned with a steam cleaner.
27. See instructions for cleaning door seals, cavities and adjacent parts on page 14.
28. Handle with care when removing items from the oven so that the turntable does not displace.

Other warnings

1. To reduce the risk of fire in the oven cavity:
 - a. Do not overcook food.
 - b. Remove wire twist-ties from paper or plastic bags before placing bag in the oven.
 - c. Do not heat oil or fat for deep frying. The temperature of the oil cannot be controlled.

2. To reduce the risk of an explosion or delayed eruptive boiling, care should be taken when handling the container. Your oven is capable of heating food and beverages very quickly with microwave, therefore it is very important that you select the appropriate cooking time and power level for the type and quantity of food to be heated. If you are unsure of the cooking time and power level required, begin with low cooking times and power levels until the food is sufficiently heated evenly throughout.
Additionally:
 - a. Do not place sealed containers in the oven. Babies bottles fitted with a screw cap or teat are considered to be sealed containers.
 - b. Do not use excessive amount of time.
 - c. When boiling liquids in the oven, use a wide-mouthed container.
 - d. Do not heat for longer than recommended time. See REHEATING-FOOD CHART in the attached cookbook.
 - e. Stand at least for 20 seconds at the end of cooking to avoid delayed eruptive boiling of liquids.
 - f. Stir the liquid before and during cooking. Use extreme care when handling the container or inserting a spoon or other utensil into the container.
3. Never operate the oven whilst any object is caught or jammed between the door and the oven.
4. Handle with care when removing items from the oven so that the utensil, your clothes or accessories do not touch the latches.
5. Never poke an object, particularly a metal object, through a grille or between the door and the oven while the oven is operating.
6. Never tamper with or deactivate the latches.
7. Always use oven gloves to prevent burns when handling utensils that are in contact with hot food. Enough heat from the food can transfer through utensils to cause skin burns.
8. If the oven lamp fails please consult your dealer or a qualified service technician trained by SHARP.
9. Avoid steam burns by directing steam away from the face and hands. Slowly lift the furthest edge of a dish's cover including microwave plastic wrap etc., and carefully open popcorn and oven cooking bags away from the face.
10. Make sure that the power supply cord is undamaged, and that it does not run under the oven or over any hot surfaces or sharp edges.
11. Do not place anything on the outer cabinet.
12. Do not store food or any other items inside the oven.
13. Make sure the utensil does not touch the interior walls during cooking.
14. Do not operate the oven without a load (i.e. an absorbing material such as food or water) in the oven cavity except when conditioning or cleaning the heater elements as described in the operation manual.

SPECIAL NOTES FOR MICROWAVE

| | DO | DON'T |
|--|---|---|
| Popcorn | <ul style="list-style-type: none"> * Use specially bagged popcorn for the microwave oven. * Listen while popping corn for the popping to slow to 1-2 seconds. | <ul style="list-style-type: none"> * Pop popcorn in regular brown bags or glass bowls. * Exceed maximum time on popcorn package. |
| Baby food | <ul style="list-style-type: none"> * Transfer baby food to small dish and heat carefully, stirring often. Check for suitable temperature to prevent burns. * Remove the screw cap and teat before warming baby bottles. After warming shake thoroughly. Check for suitable temperature. | <ul style="list-style-type: none"> * Heat disposable bottles. * Overheat baby bottles. Only heat until warm. * Heat bottles with nipples on. * Heat baby food in original jars. |
| General | <ul style="list-style-type: none"> * Food with filling should be cut after heating, to release steam and avoid burns. * Use a deep bowl when cooking liquids or cereals to prevent boiling over. | <ul style="list-style-type: none"> * Heat or cook in closed glass jars or air tight containers. * Overcook oysters. * Dry nuts or seeds in shells. * Heat or dry wood, herbs, wet papers, clothes or flowers. |
| Canned foods | <ul style="list-style-type: none"> * Remove food from can. | <ul style="list-style-type: none"> * Heat or cook food while in cans. |
| Sausage rolls, Pies, Christmas pudding | <ul style="list-style-type: none"> * Cook for the recommended time. (These foods have high sugar and / or fat contents.) | <ul style="list-style-type: none"> * Overcook as they may catch fire. |
| Meats | <ul style="list-style-type: none"> * Use a microwave proof roasting rack to collect drained juices. | <ul style="list-style-type: none"> * Place meat directly on the turntable for cooking. |

INSTALLATION INSTRUCTIONS

1. Remove all packing materials from the oven cavity, (do not remove the waveguide cover), and the feature sticker from the outside of the door, if there is one. Check the unit for any damage, such as a misaligned door, damaged door seals around the door or dents inside the oven cavity or on the door. If there is any damage, please do not operate the oven until it has been checked by a SERVICE CENTRE APPROVED BY SHARP and repaired, if necessary.
2. Accessories provided
1) Turntable tray 2) Roller stay 3) Low rack 4) High rack 5) Square tray 6) Operation manual
3. Since the door may become hot during cooking, you should place or mount the oven so that the bottom of the oven is 85 cm or more above floor. You should also keep children away from the door to prevent them burning themselves.
4. Place the roller stay, with the engraved word "Top" facing up, securely with in the three pins on the coupling, then fit the turntable on the roller stay. (See OVEN DIAGRAM on page 4) Make sure the turntable and roller stay are centrally located and locked together. NEVER operate the oven without the roller stay and turntable.
5. This oven is designed to be used on a benchtop, on a shelf or built-in. The appliance must not be placed in a cupboard. It should not be installed in any area where heat and steam are generated, for example, next to a conventional oven unit. The oven should be installed so as not to block ventilation openings. When the oven is mounted on a kitchen benchtop, allow a space of at least 40 cm on the top, 10 cm on both sides and 5cm at the rear of the oven for adequate air circulation. When installing on a shelf, the minimum dimension of the shelf should be 750mm(W) x 768mm(H) x 587mm(D), and allow a space of at least 5cm at the rear of the oven for adequate air circulation. When building the oven into a cabinet or wall, a Sharp built-in kit model number EBR-99ST [Stainless Steel] for R-995DST and Sharp built-in kit model numbers EBR-9900(W)[White] or EBR-99ST [Stainless Steel] for R-995D(W) is available which enable the microwave oven to be integrated within a kitchen, the kit is available from your retailer. Do not build-in the appliance under the benchtop or any other appliances. Read carefully the installation instructions for the built-in kit before installation. This built-in kit has been tested according to Australian Standards. Sharp does not recommend the use of any other built-in kit. If the oven is to be positioned near a conventional oven, ensure that adequate space is allowed, and a suitable heat shield is incorporated between the two to prevent damage to the oven and the built-in kit caused by heat.
Please note the final colour of the built-in kit may vary against the appliance.
WARNING: The electrical outlet must be readily accessible so that the unit can be unplugged easily in an emergency.
6. Neither the manufacturer nor the distributors can accept any liability for damage to the machine or personal injury for failure to observe the correct electrical connecting procedure.
The A.C. voltage must be single phase • 230V-240V, 50Hz
7. This appliance must be earthed.
8. Operate the oven from a general purpose domestic outlet. If a generator is used, do not operate the oven with non-sinusoidal outputs.
9. Before using GRILL and CONVECTION HEATING ELEMENTS for the first time, operate the oven without food for 20 minutes on grill and then at convection 250°C. This will allow the oil that is used for rust protection to be burned off.

SPECIFICATIONS

| Model Name | R-995DST | R-995D(W) |
|---------------------------------|---|-------------------------|
| AC Line Voltage | Single phase 230-240V, 50Hz | |
| Input | Microwave (STEADY): 1.40kW Microwave (INITIAL): 1.83kW Convection: 2.15 kW (at 240V) / 1.98 kW (at 230V) Grill: 1.50kW (at 240V) / 1.38 kW (at 230V) | |
| Output Power | Microwave : 1000 W* (IEC test procedure) | |
| Microwave Frequency | 2450 MHz**(Class B/Group 2) | |
| Outside Dimensions (WxHxD) | 550mm x 368mm x 537mm | |
| Depth with the door open | 954mm | |
| Cooking Uniformity | Turntable (ø362mm tray) system | |
| Weight | Approx. 19 kg | |
| Sharp Built in Kit model number | EBR-99ST | EBR-9900(W) or EBR-99ST |

* When tested in accordance with AS/NZS 2895.1.2007

** This is the classification of ISM (Industrial, Scientific and Medical) equipment described in the International Standard CISPR11.

OVEN DIAGRAM

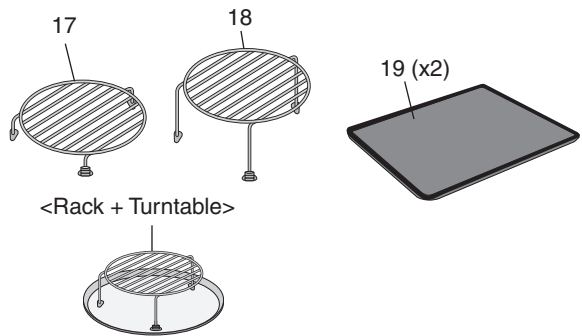
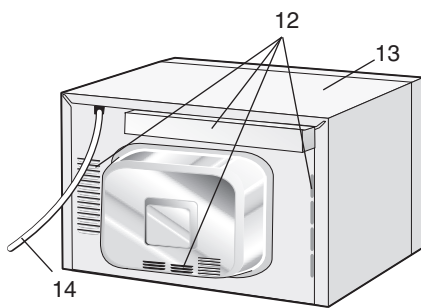
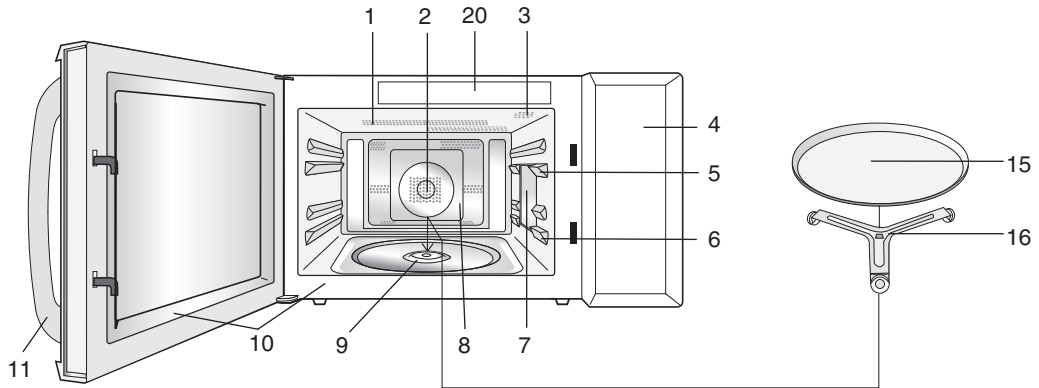

<Figure A>

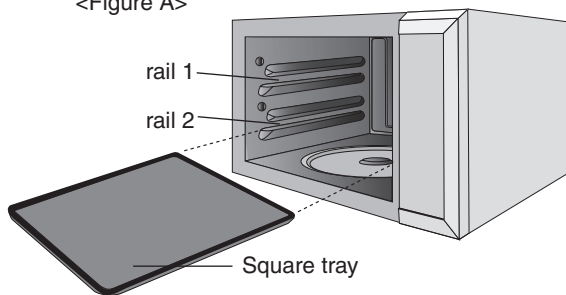

1. Grill heating element
2. Convection heating element
3. Oven lamp
4. Control panel
5. Shelf rail (rail 1)
6. Shelf rail (rail 2)
7. Waveguide cover (Do not remove)
8. Oven cavity
9. Coupling
10. Door seals and sealing surfaces
11. Door opening handle
12. Ventilation openings
13. Outer cabinet
14. Power supply cord
15. Turntable
16. Roller stay
17. Low rack (height: 4 cm)
18. High rack (height: 15.5 cm)
19. Square tray (x2)
20. Menu label

- Place the roller stay into the coupling in the centre of the oven floor, ensuring you place it TOP side up, (TOP is engraved on one side). It should be able to freely rotate around the coupling.
- Place the turntable on to the roller stay.
- Place the high/low racks onto the turntable if necessary. These racks are used for cooking in Convection, Mix or Grill mode.
- Use the square tray for convection only. See page 8. When using one square tray, place it at rail 2 as shown in the figure A.
- Do not substitute similar types of racks or square trays for these specially designed ones.

NOTES:

- Always operate the oven with the turntable and roller stay fitted correctly. This promotes thorough even cooking. A badly fitted turntable may rattle, may not rotate properly and damage the oven.
- The turntable rotates clockwise or counter clockwise. The rotary direction may change each time you start the oven. This does not affect cooking performance.
- When you order accessories, please mention two details: part name and model name to your dealer or SHARP authorised service facility.

OPERATION OF CONTROL PANEL

The operation of the oven is controlled by pressing the appropriate keys arranged on the surface of the control panel.

A 'beep' sound should be heard each time you press the control panel to make a correct entry.

When starting and stopping the cooking/timer, the response sounds of the START key and the STOP key are different from the others.

In addition an audible signal will sound for approximately 2 seconds at the end of the cooking cycle, or 4 times when an action is required during a cooking programme.

Control Panel Display

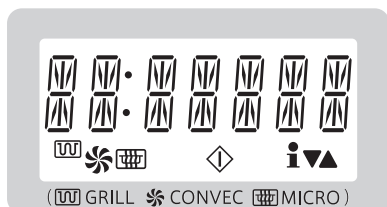

The display shows useful information including cooking time and cooking mode.

◇ : COOK indicator

i : INFO indicator

▼▲ : LESS/MORE indicators

Touch Control Panel Layout

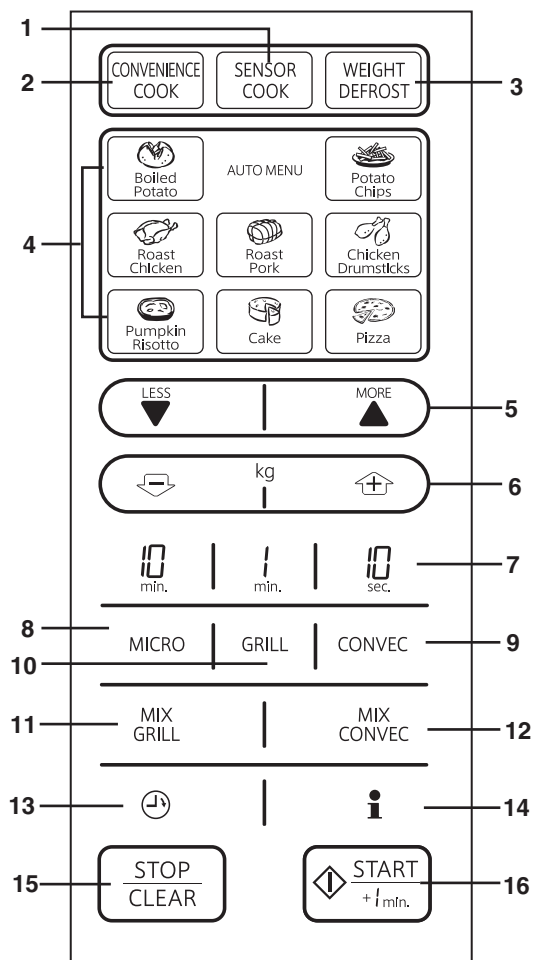

- 1 SENSOR COOK key
Press to select Sensor Cook menus.
- 2 CONVENIENCE COOK key
Press to select Convenience Cook menus.
- 3 WEIGHT DEFROST key
Press to select Weight Defrost menus.
- 4 AUTO MENU keys
Press to cook 8 popular menus.
- 5 LESS/MORE keys
Press to alter the cooking result for Auto Menu, Sensor Cook, Convenience Cook, and Weight Defrost modes.
Press to increase/decrease the time in one minute increments during cooking.
- 6 WEIGHT keys
Press to increase/decrease the weight.
- 7 TIME keys
Press to enter time.
- 8 MICROWAVE key
Press to select microwave power setting.
If not pressed, 100% is automatically selected.
- 9 CONVECTION key
Press to select Convection mode.
- 10 GRILL key
Press to select Grill mode.
- 11 MIX GRILL key
Press to select Mix Grill mode.
- 12 MIX CONVECTION key
Press to select Mix Convection mode.
- 13 TIMER/CLOCK key
Press to set Timer or Clock.
- 14 INFO key
Press to set Delay Start or Child Lock.
- 15 STOP/CLEAR key
Press to clear during programming.
Press once to stop operation of the oven during cooking; press twice to cancel cooking programme.
- 16 START/+ 1 min. key
Press once to cook for 1 minute on 100% microwave cooking or increase by 1 minute multiples each time this key is pressed during Microwave, Convection, Grill or Mix cooking. Press to start the oven after setting programmes.

BEFORE OPERATING

- Before operating your oven, make sure you read and understand this operation manual completely.
- Before the oven can be used, follow these procedures:
 1. See below for getting started.
 2. Follow directions on the right side for cleaning the oven before first use.

Getting Started

PROCEDURE

1 Plug the oven into a power point. "MICRO-, WAVE, OVEN" will appear on the display.

2 Press STOP/CLEAR.



The display will show ".0".

Clock Setting

* To enter the present time of day 11:34 (AM or PM).

PROCEDURE

1 Press TIMER/CLOCK twice.



2 Enter the hours by pressing TIME.



3 Press TIMER/CLOCK.



4 Enter the minutes by pressing TIME.

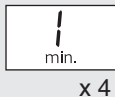

5 Press TIMER/CLOCK.



This is a 12-hour clock. If the clock is set, when cooking is complete, the display will show the correct time of day. If the clock has not been set, the display will only show ".0" when cooking is complete. If you wish to know the time of day during the cooking, delay start or timer mode, press TIMER/CLOCK. As long as your finger is pressing TIMER/CLOCK, the time of day will be displayed.

Stop/Clear

Use the STOP/CLEAR to:

1. Clear if you make a mistake during programming.
2. Stop the oven temporarily during cooking.
3. Cancel a programme during cooking, press twice.

CLEAN THE OVEN BEFORE FIRST USE

You may detect smoke or a burning smell when using the grill and convection for the first time, this is normal and not a sign that the oven is out of order. To avoid this problem, when first using the oven, heat the oven without food for 20 minutes on grill and then on convection 250°C.

PREPARATION

Ventilate the room.

PROCEDURE

1 Ensure that no food is in the oven. Enter the time by pressing TIME.

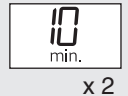

2 Select GRILL or CONVECTION.

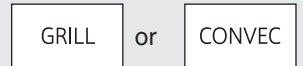

3 Press START.



WARNING:

Accessible parts (e.g. oven door, oven cavity, dishes and accessories) will become hot when in use. To prevent burns, always use thick oven gloves.

MANUAL OPERATION

Microwave

Microwave is fast and convenient for cooking, reheating and defrosting.

First enter the cooking time then select the power level.

This mode can be programmed for up to 99 minutes 50 seconds.

There are 6 different power levels.

| Display | Power level | Examples |
|---------|-------------|--|
| 100P | 100% | Raw meat, Vegetables, Rice or Pasta |
| 70P | 70% | Delicate Food such as Eggs or Seafood. |
| 50P | 50% | |
| 30P | 30% | Defrost, Softening butter |
| 10P | 10% | Keep food warm |
| 0P | 0% | |

This variable cooking control allows you to select the rate of microwave cooking.

If a power level is not selected, then 100% is automatically used.

1 layer cooking only.

* Suppose you want to cook for 5 minutes on 100%.

PROCEDURE

1 Enter the cooking time by pressing TIME (5.00)  x 5

2 Press START. 

To change the microwave power level, press MICROWAVE until the desired power level is displayed.

* Suppose you want to defrost for 5 minutes on 30%.

PROCEDURE

1 Enter the cooking time by pressing TIME (5.00)  x 5

2 Change the power level by pressing MICROWAVE until the desired microwave power level is displayed (30P)  x 4

3 Press START. 

WARNING:

1. Never use the square tray for microwave cooking as this may cause arcing.
2. After cooking and opening the door, the display may show "NOW COOLING".

NOTES:

1. When the door is opened during the cooking process, the cooking time on the digital display stops automatically. The cooking time starts to count down again when the door is closed and START is pressed.
2. If you wish to know the power level during cooking, press MICROWAVE. As long as your finger is pressing MICROWAVE, the power level which you have input will be displayed.

Grill

The grill heating element at the top of the oven cavity has one power setting only. This mode can be programmed for up to 99 minutes 50 seconds.

* Suppose you want to cook for 10 minutes on Grill.

PROCEDURE

1 Enter the cooking time by pressing TIME (10.00)  x 1

2 Press GRILL. 

3 Press START. 

WARNING:

The oven door, outer cabinet, oven cavity, accessories and dishes will become hot. Use thick oven gloves when adding or removing foods to prevent burns.

NOTES:

1. The high or low racks are recommended when grilling. It is not recommended to use the square tray for grilling.
2. You may detect smoke or a burning smell when using the grill for the first time, this is normal and not a sign that the oven is out of order. (Please see CLEAN THE OVEN BEFORE FIRST USE on page 6)
3. After cooking and opening the door, the display may show "NOW COOLING".

MANUAL OPERATION

Convection

Your oven can be used as a conventional oven using the convection facility and 10 pre-set oven temperatures (250, 230, 220, 200, 190, 180, 160, 130, 100, 40°C)

Preheating is recommended for better results (especially when using the square tray).

Convection can be programmed for up to 99 minutes 50 seconds.

TO COOK WITHOUT PREHEATING

* Suppose you want to cook at 250°C for 20 minutes.

PROCEDURE

1 Enter the cooking time by pressing TIME (20.00)  x 2

2 Select the desired cooking temperature by pressing CONVECTION until the desired temperature is displayed (250°C)  x 1

3 Press START. 

WARNING:

The oven door, outer cabinet, oven cavity, accessories and dishes will become hot. Use thick oven gloves when adding or removing foods to prevent burns.

NOTES:

1. After cooking and opening the door, the display may show "NOW COOLING".
2. You may detect smoke or a burning smell when using convection for the first time. This is normal and is not a sign that the oven is out of order. (See CLEAN THE OVEN BEFORE FIRST USE on page 6.)
3. If you wish to know the oven temperature during cooking, press CONVECTION. As long as your finger is pressing CONVECTION, the temperature which you have input will be displayed.

TO COOK WITH PREHEATING

* Suppose you want to preheat to 200°C and cook for 20 minutes at 200°C.

PROCEDURE

1 Enter the desired preheat temperature by pressing CONVECTION until the desired temperature is displayed (200°C)  x 4

2 Press START to start preheating. 

The display will show "PREHEAT".

When the preheated temperature has been reached the audible signal sounds, the display will show 200°C. Open the door and place the food inside the oven. Close the door.

3 Enter the cooking time by pressing TIME (20.00)  x 2

4 Press START. 

NOTES FOR PREHEATING:

1. When the oven is preheated the turntable should be in the oven.
2. After preheating, if you want to cook at a different temperature press CONVECTION until the desired setting appears on the display. In the example above, to change the temperature you would press CONVECTION after entering the cooking time.
3. When the oven reaches the programmed preheating temperature, it will automatically hold at the preheated temperature for 30 minutes. After 30 minutes, the selected convection programme will be cancelled.
4. If you press CONVECTION during preheating, the actual oven temperature will be displayed. If the oven temperature is below 40°C, "LO" will be displayed.

SPECIAL NOTES FOR SQUARE TRAY:

1. When using one square tray, place it at rail 2. Refer to the figure A on page 4.
2. When using the square tray, leave the turntable in the oven.
3. When using the square tray, rotate the square tray or the container on it 180° halfway to achieve better results.

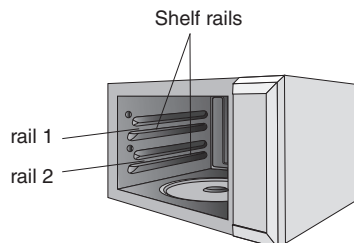

MANUAL OPERATION

Mix Cooking

Your oven has 2 mix cooking modes combining the heat of the grill or convection with microwave power. To select the mix cooking mode, choose the cooking time, then press MIX GRILL or MIX CONVECTION to select the desired setting. Mix cooking can be programmed for up to 99 minutes 50 seconds.

| Cooking mode | | Preset programme |
|----------------|------------|---|
| Mix Grill | MIX GRILL | Grill Microwave 30% or 10%* |
| Mix Convection | MIX CONVEC | Convection 40°C - 250°C** (select from 10 temperatures) Microwave 30% or 10%* |

NOTES:





* The microwave power can be chosen by pressing MICROWAVE.

** To adjust the convection temperature, press CONVECTION until the desired temperature appears on the display.

TO COOK WITH MIX GRILL

* Suppose you want to cook for 20 minutes on Mix Grill using 10% microwave power and grill.





PROCEDURE

- 1 Enter the cooking time by pressing TIME (20.00)  x 2
- 2 Press MIX GRILL. 
- 3 Change the power level by pressing MICROWAVE until the desired microwave power level is displayed (10P)  x 2
- 4 Press START. 

TO COOK WITH MIX CONVECTION

* Suppose you want to cook for 20 minutes on Mix Convection using 10% microwave power and 200°C convection.

PROCEDURE

- 1 Enter the cooking time by pressing TIME (20.00)  x 2
- 2 Press MIX CONVECTION. 
- 3 Change the power level by pressing MICROWAVE until the desired microwave power level is displayed (10P)  x 2
- 4 Select the desired cooking temperature by pressing CONVECTION until the desired temperature is displayed (200°C).  x 4
- 5 Press START. 

WARNING:

1. The oven door, outer cabinet, oven cavity, accessories and dishes will become hot. Use thick oven gloves when adding or removing foods to prevent burns.
2. Never use the square tray for mix cooking as this may cause arcing.

NOTES:

1. After cooking and opening the door, the display may show "NOW COOLING".
2. If you wish to know the power level during cooking, press MICROWAVE. As long as your finger is pressing MICROWAVE, the power level which you have input will be displayed.
3. If you wish to know the oven temperature during mix convection cooking, press CONVECTION. As long as your finger is pressing CONVECTION, the temperature which you have input will be displayed.

AUTOMATIC OPERATION

Notes for Automatic Operation

1. Wipe off any moisture from the outside of cooking containers and the interior of the oven with a dry cloth or paper towel prior to cooking on SENSOR COOK.
2. After oven is plugged in, wait 2 minutes before using SENSOR COOK.
3. When cooking small quantities of food on SENSOR COOK, the food may be cooked without displaying any remaining cooking time.
4. When using the automatic features, carefully follow the instructions provided in each GUIDE to achieve the best result. If the instructions are not followed carefully, the food may be overcooked or undercooked or "ERROR" may be displayed.
5. Food weighing more or less than the quantity or weight listed in each GUIDE, cook manually. Refer to manual cooking charts on pages 23-26.
6. To change the final cooking or defrosting result from the standard setting, press LESS(▼) or MORE(▲) prior to pressing each automatic operation key. Refer to page 12.
7. The final cooking result will vary according to the food condition (e.g. initial temperature, shape, quality). Check the food after cooking and if necessary continue cooking manually.
8. To avoid children's misuse, each AUTO MENU key can be used only within 3 minutes of a preceding operation.
9. "ERROR" will be displayed if:
 - (a) more or less than the quantity or weight of foods suggested in the SENSOR COOK GUIDE are programmed when START is pressed.
 - (b) the door is opened or STOP/CLEAR is pressed until the cooking time is displayed. To clear, press STOP/CLEAR and cook manually. Refer to manual cooking charts on pages 23-26.
10. When entering the weight of the food, round off the weight to the nearest 0.1kg(100g). For example, 1.65kg would become 1.7kg. When entering up to 0.3kg(300g), round off the weight to the nearest 0.05kg(50g).
11. After cooking, the cooling fan will continue to operate. "NOW COOLING" may be displayed when the door is opened or STOP/CLEAR is pressed while fan is operating.

Auto Menu

The AUTO MENUS have been pre-programmed with a cook mode and cook time, offering convenience at meal times. There are 8 popular AUTO MENUS which have been listed below. See AUTO MENU GUIDE on pages 18-19 for information on how to use these menus.

- | | |
|-----------------|----------------------|
| - Boiled Potato | - Chicken Drumsticks |
| - Potato Chips | - Pumpkin Risotto |
| - Roast Chicken | - Cake |
| - Roast Pork | - Pizza |

* Suppose you want to cook 0.5 kg Chicken Drumsticks.

PROCEDURE

- 1 Press Chicken Drumsticks until the desired quantity is displayed.
For 0.5kg, press 5 times.
(within 3 minutes of closing the door)
After about 2 seconds, the timer will begin to count down.



x 5

The oven will stop. COOK indicator will go off and "TURN OVER" will be displayed. Open the door. Turn over the chicken drumsticks. Close the door.

- 2 Press START.



The cooking time will begin counting to zero, when it reaches zero, the oven will "beep". "STAND" will be displayed.

WARNING:

The oven door, outer cabinet, oven cavity, accessories and dishes will become hot. Use thick oven gloves when adding or removing foods to prevent burns.

NOTE:

When using Potato Chips key, press once for Thin chips, press twice for Thick chips.

AUTOMATIC OPERATION

Sensor Cook

SENSOR COOK will automatically compute the power level and cooking time by detecting the vapour from the food. SENSOR COOK has 4 menus. See SENSOR COOK GUIDE on page 20.

No.1: Casserole No.3: Rice (White)
No.2: Fresh Vegetables No.4: Pasta (Dry)

* Suppose you want to cook 0.3 kg Fresh Vegetables.

PROCEDURE

- 1 Press SENSOR COOK until the menu number of your choice is displayed. For Fresh Vegetables, press twice.

SENSOR
COOK

x 2

- 2 Press START.



The display will show "FRESH VEG." repeatedly.

The oven will stop. COOK indicator will go off and "STIR" will be displayed. Open the door. Stir the vegetables. Close the door.

- 3 Press START.



The cooking time will begin counting to zero, when it reaches zero, the oven will "beep". "STIR STAND COVER" will be displayed.

Convenience Cook

CONVENIENCE COOK will automatically compute the cooking mode and cooking time. CONVENIENCE COOK has 3 popular menus. See CONVENIENCE COOK GUIDE on page 21.

C-1: Frozen Ready Meals
C-2: Frozen Vegetables
C-3: Frozen Lasagne

* Suppose you want to cook 0.4 kg Frozen Lasagne.

PROCEDURE

- 1 Press CONVENIENCE COOK until the menu number of your choice is displayed. For Frozen Lasagne, press 3 times.

CONVENIENCE
COOK

x 3

- 2 Press START.



The timer will begin to count down, when it reaches zero, the oven will "beep". "STAND COVER" will be displayed.

WARNING:

The oven door, outer cabinet, oven cavity, accessories and dishes will become hot. Use thick oven gloves when adding or removing foods to prevent burns.

Weight Defrost

The WEIGHT DEFROST menus have been pre-programmed with a cook mode and cook time to make defrosting easier for you at home. There are 6 menus which have been listed below. See WEIGHT DEFROST GUIDE on page 22.

D-1: Steak/Chops D-4: Chicken Drumsticks
D-2: Roast Meat D-5: Poultry
D-3: Minced Meat D-6: Bread

* Suppose you want to defrost 0.5 kg Steak.

PROCEDURE

- 1 Press WEIGHT DEFROST until the menu number of your choice is displayed. For Steak, press once.

WEIGHT
DEFROST

x 1

- 2 Enter weight by pressing WEIGHT (0.50 KG)



x 6

or



x 4

- 3 Press START.



The timer will begin to count down.

The oven will stop. COOK indicator will go off and "TURN OVER AND SHIELD" will be displayed. Open the door. Turn over the steak. Shield the thin parts and warm spots with aluminium foil. Close the door.

- 4 Press START.



The cooking time will begin counting to zero, when it reaches zero, the oven will "beep". "STAND COVER" will be displayed.

OTHER CONVENIENT FEATURES

Less or More Time Adjustment (LESS (▼) / MORE (▲) keys)

a) To use with automatic cooking

The cooking times programmed into the automatic menus are tailored to the most popular tastes. To adjust the cooking time to your individual preference - use the "more" or "less" feature to either add (more) or reduce (less) cooking time.

To adjust cooking time, press LESS (▼) or MORE (▲) at the beginning of the procedure.

* Suppose you want to cook 0.5kg Chicken Drumsticks with MORE (▲).

PROCEDURE

1 Press MORE.



2 Press Chicken Drumsticks 5 times.



NOTE:

To cancel LESS or MORE press the same key again. To change MORE to LESS simply press LESS (▼). To change LESS to MORE simply press MORE (▲).

b) To use with manual cooking

During the manual cooking process, the cooking time can be decreased or increased in 1 minute steps each time the LESS (▼) or MORE (▲) is pressed.

+1min. Function

+1min. allows you to operate the two following functions:

a) Direct start

You can directly start cooking on 100 % microwave power for 1 minute by pressing +1min.

NOTE:

To avoid the misuse by children, +1min can be used only within 3 minutes after preceding operation, i.e., closing the door, pressing STOP/CLEAR or cooking completion.

b) Extend the manual cooking time

You can extend the manual cooking time for multiples of 1 minute if +1min is pressed while the oven is in operation.

Multiple Sequence Cooking

This function allows you to cook using up to 4 manual cooking programmes including combinations of Microwave, Grill, Convection and Mix Cooking.

* Suppose you want to cook in Sequence Cooking for:
5 minutes on 70 % Microwave power (Stage 1)
3 minutes on Grill (Stage 2)

PROCEDURE

1 For 1st stage, enter the desired cooking time by pressing TIME (5.00) and press MICROWAVE until the desired power level is displayed (70P)



x 5

MICRO

x 2

2 For 2nd stage, enter the desired cooking time by pressing TIME (3.00) and press GRILL.



x 3

GRILL

3 Press START.



WARNING:

The oven door, outer cabinet, oven cavity, accessories and dishes will become hot. Use thick oven gloves when adding or removing foods to prevent burns.

Demonstration Mode

This feature is mainly for use by retail outlets, and also allows you to practice the key operation.

To demonstrate, press STOP/CLEAR and hold for 4 seconds.

When you hear the oven beeps, press STOP/CLEAR 4 times within 2 seconds. The display will show "DEMO HELLO DO YOU LIKE TO COOK WITH ME" repeatedly.

Cooking operations can now be demonstrated with no power in the oven. The display will count down to zero at ten times the speed faster than normal.

To cancel, press STOP/CLEAR and hold for 4 seconds. When you hear the oven beeps, press STOP/CLEAR 4 times within 2 seconds. The display will show "DEMO OFF", and then the time of day. Or unplug the oven from the electrical outlet and re-plug to cancel Demo Mode.

NOTE:

The displayed message will change to the time of day when pressing STOP/CLEAR.

OTHER CONVENIENT FEATURES

Info

INFO key provides 2 features.

a) Delay Start

The Delay Start feature allows you to set your oven to start automatically.

* Suppose you want to start cooking for 20 minutes on 30% microwave power at 4:30.

(Check that the correct time of day is displayed.)

PROCEDURE

1 Press INFO once.



2 Set the desired start time.



3 Set the desired cooking programme.



4 Press START.



The display will show "DELAY START 4:30 ON".
And the oven will start cooking at 4:30.

To check the current time, simply press TIMER/CLOCK, the time will be displayed.

If the door is opened after step 4, close the door and press START to continue with Delay Start.

Press STOP/CLEAR to cancel Delay Start.

The correct time of day must be set before using Delay Start, see clock setting on page 6.

b) Child Lock

Child Lock prevents unwanted oven operation such as by small children. The oven can be set so that the control panel is deactivated and locked.

* To set the Child Lock.

PROCEDURE

1 Press INFO twice.



2 Press START.



The display will show "LOCK", and the time of day.

The control panel is now locked, each time a key is pressed, the display will show "LOCK".

* To unlock the control panel.

PROCEDURE

1 Press INFO once.

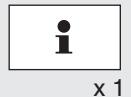

2 Press START.



The display will show "LOCK OFF", and the time of day.
The oven is ready to use.

Timer

Use the TIMER as a minute timer or to monitor the standing time for cooked/defrosted food.

* To set the timer for 5 minutes.

PROCEDURE

1 Press TIMER/CLOCK once.



2 Enter the desired time by pressing Time.

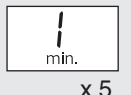

3 Press START.



CARE AND CLEANING

Disconnect the power supply cord before cleaning or leave the door open to inactivate the oven. Before cleaning ensure oven cavity is cool.

CLEAN THE OVEN AT REGULAR INTERVALS - Keep the oven clean and remove any food deposits, or it could lead to deterioration of the surface. This could adversely affect the life of the appliance and possibly result in a hazardous situation.

Exterior: The outside may be cleaned with mild soap and warm water, wipe clean with a damp cloth. Avoid the use of harsh abrasive cleaners. Keep the ventilation openings free of dust.

Door: Wipe the door and window on both sides, the door seals and adjacent parts frequently with a damp cloth to remove any spills or splatters. Do not use harsh abrasive cleaners or sharp metal scrapers to clean the oven door glass since they can scratch the surface, which may result in shattering of the glass.

Touch Control Panel: Wipe the panel with a cloth dampened slightly with water only. Do not scrub or use any sort of chemical cleaners. Avoid the use of excess water.

Interior walls: Wipe splatters and spills with a little dish washing liquid on a soft damp cloth. For heavier stains inside the oven cavity only, use a mild stainless steel cleaner applied with a soft damp cloth. Do not apply to the inside of the door. Wipe clean ensuring all cleaner is removed.

After use wipe the waveguide cover in the oven with a soft damp cloth to remove any food splashes. Built-up splashes may overheat and begin to smoke or catch fire. Do not remove the waveguide cover.

DO NOT USE CAUSTIC CLEANERS, ABRASIVE OR HARSH CLEANSERS OR SCOURING PADS ON YOUR OVEN. NEVER SPRAY OVEN CLEANERS DIRECTLY ONTO ANY PART OF YOUR OVEN.

DO NOT USE A STEAM CLEANER. Avoid using excess water. After cleaning the oven, ensure any water is removed with a soft cloth.

Note: At regular intervals, heat the oven referring to "CLEAN THE OVEN BEFORE FIRST USE" on page 6.

Because, the splashed dirt or food oil remained around oven walls may cause the smoke and odour.

Turntable/Turntable Support/Racks: Wash with mild soapy water and dry thoroughly.

Note: Keep the waveguide cover and accessories clean at all times. If you leave grease or fat in the cavity or accessories, it may overheat, cause arching, smoke or even catch fire when next using the oven.

SPECIAL NOTE for Roller Stay:

After cooking, always clean the roller stay, especially around the rollers. These must be free from food splashes and grease. Built-up splashes or grease may overheat and cause arching, which may produce smoke or catch fire.

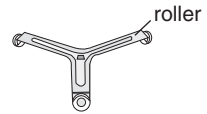

SERVICE CALL CHECK

Please check the following before calling service:

- | | | |
|--|-----------|----------|
| 1. Does the display light up? | Yes _____ | No _____ |
| 2. When the door is opened, does the oven lamp come on? | Yes _____ | No _____ |
| 3. Place one cup of water (approx. 250 mL) in a glass measuring cup in the oven and close the door securely. Oven lamp should go off if door is closed properly. Press START once. | | |
| A. Does the oven lamp come on? | Yes _____ | No _____ |
| B. Does the cooling fan work?(Put your hand over the rear ventilation openings.) | Yes _____ | No _____ |
| C. Does the turntable rotate? (The turntable can rotate clockwise or counterclockwise. This is quite normal.) | Yes _____ | No _____ |
| D. Does the COOK indicator light up? | Yes _____ | No _____ |
| E. After 1 minute, is the water hot? | Yes _____ | No _____ |
| 4. Remove water from the oven and programme the oven for 3 minutes on grill. | | |
| A. Do the GRILL and COOK indicators light up? | Yes _____ | No _____ |
| B. After 3 minutes, does the grill heating element become red | Yes _____ | No _____ |
| 5. Programme the oven for 3 minutes at convection 180°C. | | |
| A. Does the CONVEC and COOK indicators light up? | Yes _____ | No _____ |
| B. After 3 minutes, is the inside of the oven hot? | Yes _____ | No _____ |

If "NO" is the answer to any of the above questions, please check your wall socket and the fuse in your meter box. If both the wall socket and the fuse are functioning properly, CONTACT YOUR NEAREST SERVICE CENTRE APPROVED BY SHARP.

NOTE:

1. If time in the display is counting down rapidly, check Demonstration Mode. (See P. 12 for detail.)
2. On 100 % microwave power level, output power will gradually be reduced to avoid overheating. If you cook the food over 20 minutes on 70% or 50% microwave power level, the microwave power will be automatically reduced to avoid overcooking.
3. If you cook the food over 15minutes with Grill mode, the grill heating elements will begin to light on and off automatically to avoid overheating.
4. After manual or automatic cooking using the Grill, Mix or Convection modes, the cooling fan will switch on to cool the oven cavity. To clear it, press STOP/CLEAR and the display will return to the time of day, if set. During these modes, the cooling fan will carry on working after you have pressed STOP/ CLEAR. You may feel hot air blowing out of the ventilation openings.

HELPFUL HINTS

MICROWAVE COOKING

1. ARRANGEMENT

Arrange foods carefully. Place thickest areas towards the outside of the dish.

Eg. Arrange vegetables in a shallow dish in the following way:

Hard Vegetables (e.g. carrots) around the outside,

Soft Vegetables (e.g. broccoli) in the centre.



2. TURNING

Foods such as poultry and joints of meat should be turned over after half the cooking time.

3. COVERING

Cover foods in the microwave to retain moisture or if you would normally cover the food in your ordinary oven, e.g. vegetables and casseroles.

Use to cover foods:



LID



PLASTIC WRAP

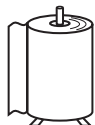

PAPER TOWEL

4. PIERCING

Pierce potatoes, eggs, oysters, tomatoes or any foods with a skin or membrane to allow steam to escape.



TOMATO



EGG

5. SHIELDING

Shield using small pieces of aluminium foil to shield thin areas of meat, fish and poultry or edges of cakes to prevent overcooking.

Watch for sparking. Sparking can damage the cavity. To prevent sparking, reduce aluminium foil or keep clear of cavity walls.



FISH



CHICKEN

6. STANDING TIME

Standing time is important. After cooking or defrosting ensure adequate standing time. This allows the food to continue cooking or heating. Refer to cooking guides for each menu or according to manufacturer's instructions.

7. STIRRING

Stir foods from the outside to the centre of the dish, once or twice during cooking if possible.

E.g. Casseroles and Sauces.



STIR

8. SIZE

Small pieces cook faster than large ones. To speed cooking, cut pieces smaller than 5 cm so microwaves can penetrate to the centre from all sides. For even cooking, make all the pieces the same size.

9. DENSITY

The depth to which microwaves penetrate food varies depending on the food's density. Porous foods like minced beef or mashed potatoes microwave faster than dense ones like steak or whole potatoes.

10. FAT AND BONE

Marbling within meat, or a thin, even layer of fat on a roast, speeds cooking. Large fatty areas or excess drippings in dish attract energy away from meat, and slows cooking. Centre bones do not affect cooking, but bone on the side of meat conducts heat to the areas next to it.

11. STARTING TEMPERATURE

Frozen or refrigerated food takes longer to heat than food at room temperature. Cooking times in this book are based on normal storage temperatures. Since rooms, refrigerators and freezers differ in temperature, check for doneness at the minimum time.

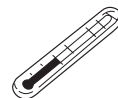

12. QUANTITY

Microwave cooking times are directly related to the amount of food in the oven. Because energy is absorbed by the food itself, one potato or a single piece of chicken cooks rapidly. When the energy is divided among several items, cooking takes more time.

13. CONDENSATION

Condensation is a normal part of microwave cooking. The humidity and moisture in food will influence the amount of condensation in the oven. Generally, covered foods will not cause as much condensation as uncovered foods. Ensure that the ventilation openings are not blocked.

14. GENERAL

Your microwave oven is capable of heating food and beverages very quickly therefore, it is very important that you select the appropriate cooking time and power level for the type and quantity of food to be heated. If you are unsure of the cooking time and power level required, begin with low cooking times and power levels until the food is sufficiently heated evenly throughout.

HELPFUL HINTS

CONVECTION COOKING

1. Use thick oven gloves when removing food or the turntable from the oven to **PREVENT BURNS**. Because accessible parts (e.g. oven door, oven cavity, dishes and accessories) will become hot when in use.
2. Can be used the same a conventional oven.
3. When cooking your own recipes; cook for a slightly shorter cooking time, at the temperature the recipe suggests. Then add additional time if necessary.
4. For best results, preheat to required temperature with the turntable in the oven. Add food after preheating.
5. Food may be cooked either directly on turntable, using the high or low racks or by using the square trays.
6. Do not cover turntable, square trays, high rack, or low rack with aluminium foil.

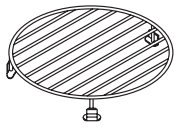

LOW RACK

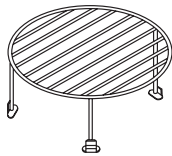

HIGH RACK

7. Metal cookware can be used. Round pizza trays are excellent cooking utensils for cooking.



CAKE TIN

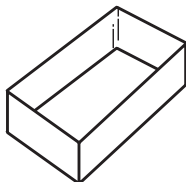

SQUARE DISH



PIZZA TRAY

8. If you are cooking and wish to check the temperature you have programmed, simply press the **CONVECTION** key. The programmed temperature will be displayed as long as **CONVECTION** key is pressed.
9. When using the square tray, see pages 4 and 8.

MIX COOKING

1. There are two automatic, pre-programmed mix settings.
 - a) **MIX GRILL** - Grill with 30% microwave power or 10% microwave power. Use for baking pastries.
 - b) **MIX CONVECTION** - Convection with 30% microwave power or 10% microwave power. Use for roasting meats, lasagne and baking.
2. Use thick oven gloves when removing food or the turntable from the oven to **PREVENT BURNS**. Because accessible parts (e.g. oven door, oven cavity, dishes and accessories) will become hot when in use.
3. The convection temperature can be changed to accommodate all your favourite recipes.
4. If you are cooking and wish to check the temperature you have programmed simply press the **CONVECTION** key. The programmed temperature will be displayed as long as **CONVECTION** key is pressed.

GRILLING

1. Use thick oven gloves when removing food or the turntable from the oven to **PREVENT BURNS**. Because accessible parts (e.g. oven door, oven cavity, dishes and accessories) will become hot when in use.
2. Place food on the high rack or low rack in the oven. **DO NOT USE THE SQUARE TRAY.**

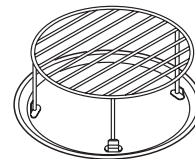

HIGH RACK & TURNTABLE

When grilling food that causes excessive fat splatter and smoke (e.g. steak, chops) the following principles should be followed:

- * Fit the high or low rack on the turntable, place the food on the rack and pour 1/2 cup of tap water on the turntable. (Otherwise the dripping fat drops onto the hot turntable causing the smoke).

COOKWARE AND UTENSIL GUIDE



OVENPROOF GLASS

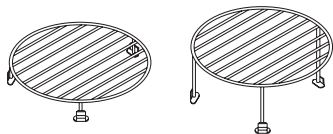

METAL RACKS (INCLUDED)

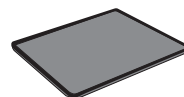

SQUARE TRAY (INCLUDED)



PIZZA TRAY



CAKE TIN

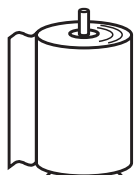

PAPER TOWEL



FOIL



RING CENTRE DISH

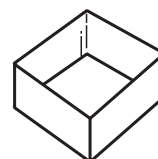

SQUARE DISH







| | MICROWAVE | CONVECTION | MIX COOKING | GRILL |
|---|------------------------|------------|---------------|-------|
| METAL RACKS (INCLUDED) | YES (LOW RACK ONLY) | YES | YES | YES |
| SQUARE TRAY (INCLUDED) | NO | YES | NO | NO |
| GLASSWARE/CERAMIC (HEAT RESISTANT) | YES | YES | YES | YES |
| METAL COOKWARE | NO | YES | NO | YES |
| OVEN BAGS | YES | YES | YES | NO |
| ALUMINIUM FOIL | For Shielding | YES | For Shielding | YES |
| NON-STICK PAPER | YES | YES | YES | NO |
| GREASE-PROOF PAPER | YES | YES | YES | NO |
| WAXED PAPER | YES | NO | NO | NO |
| PLASTIC WRAP | * 1 YES | NO | NO | NO |
| PAPER TOWEL | YES | NO | NO | NO |
| PLASTIC COOKWARE MICROWAVE SAFE | * 2 YES | NO | NO | NO |
| DEFROST RACK MICROWAVE SAFE | Defrost Only | NO | NO | NO |
| THERMOMETERS MICROWAVE SAFE | YES | NO | NO | NO |
| CONVENTIONAL | NO | YES | NO | NO |

There are many brands of microwave safe plastic cookware / defrosting racks available in the market.



*1 For cooking food with high fat contents, do not bring the wrap in contact with the food as it may melt.

*2 Some microwave safe plastic cookware are not suitable for cooking foods with high fat and sugar content.

AUTO MENU GUIDE

| Key | Menu | Weight (Increasing Unit) / Utensils | Procedure |
|--|---|--|---|
|  | Boiled Potato (initial temp 20°C) | 0.25 kg, 0.50 kg Dish & lid | <ul style="list-style-type: none"> • Peel the potatoes if necessary and cut them into similar sized pieces. (approx. 50 - 80 g each) • Put them in a dish. • Add ¼ cup of water for 0.25kg or ½ cup for 0.5kg of potatoes and add a little salt. • Cover with lid. • When the audible signals sound, stir and re-cover. • After cooking, let stand for 1-2 minutes. |
|  x 1 | Potato Chips, Thin (recommended for conventional ovens) (initial temp -18°C) | 0.25 kg Flat round microwave safe dish & high rack | <ul style="list-style-type: none"> • Place the potato chips in a single layer onto dish and then on the high rack. • When the audible signals sound, turn over. • Season with salt as desired. |
|  x 2 | Potato Chips, Thick (recommended for conventional ovens) (initial temp -18°C) | 0.3 kg Flat round microwave safe dish & high rack | |
|  | Roast Chicken (initial temp 3°C) | 0.9 - 2.0 kg (100 g increments) Low rack | <ul style="list-style-type: none"> • Pierce the skin of the chicken and place breast side down on the low rack. • When the audible signals sound, turn the chicken over. • After cooking, let stand for approx. 10 minutes covered in foil. |
|  | Roast Pork (initial temp 3°C) | 1.0 - 2.0 kg (100 g increments) Low rack | <ul style="list-style-type: none"> • Place the pork on the low rack. • When the audible signals sound, turn the pork over. • After cooking, let stand, wrapped in aluminium foil for approx. 10 minutes. |
|  | Chicken Drumsticks (initial temp 3°C) | 0.20 kg, 0.25 kg, 0.3 - 1.0 kg (100 g increments) High rack | <ul style="list-style-type: none"> • Pierce the skin of the chicken drumsticks. • Put the chicken drumsticks on the high rack with the thin ends towards the centre. • When the audible signals sound, turn the chicken drumsticks over. • After cooking, let stand for approx. 3 minutes. |

AUTO MENU GUIDE

| Key | Menu | Weight (Increasing Unit) / Utensils | Procedure |
|---|-----------------------------|--|---|
|  | Pumpkin Risotto | Recipe Ceramic dish | <ul style="list-style-type: none"> Prepare and cook pumpkin risotto referring to the recipe below. |
|  | Cake | Recipe 21cm square silicone dish High rack | <ul style="list-style-type: none"> Prepare and cook cake referring to the recipe below. |
|  | Pizza (initial temp 3°C) | 1 Base Low rack | <ul style="list-style-type: none"> Place the food directly on the low rack. |

PUMPKIN RISOTTO

Ingredients :

30 g butter, cut into small pieces
 1 brown onion, finely chopped
 2 cloves garlic, crushed
 1 cup Arborio rice, washed
 350 g pumpkin, skin & seeds removed & cut into approx. 2cm pieces
 2 cups chicken stock
 100 g broccoli, cut into small florets
 Parmesan, to taste
 Salt and Pepper, to taste

Method:

- Combine the butter, onion and garlic in a medium sized microwave safe dish and place onto the turntable and press the **Pumpkin Risotto** key.
- When the audible signals sound, add the rice, pumpkin and chicken stock and stir to combine. Place the dish onto the turntable and press the **START** key.
- When the audible signals sound, stir in the broccoli and place the dish back onto the turntable and press the **START** key.
- After cooking, remove the risotto from the oven, cover with a lid and let stand for 10 minutes. Serve with grated parmesan and salt and pepper.

CAKE

Ingredients :

230 g butter, softened
 1 cup castor sugar
 1 tbsp. vanilla essence
 3 eggs
 2 cups self-raising flour
 ¾ cup milk

Method:

- Starting off on a low speed, beat the butter and sugar in a large bowl until combined and then increase speed to high and beat until light in colour and fluffy.
- Add vanilla essence and eggs one at a time, beating well between each addition until combined.
- Add half of the flour and half of the milk and fold through the mixture until combined, before folding through the remaining flour and milk.
- Pour mixture into a greased 21cm silicone dish and place the dish on the high rack and press the **Cake** key.
- After cooking, let stand for 10 minutes in the dish before turning out onto a wire rack to cool.

SENSOR COOK GUIDE

| Key | Menu No. | Weight / Utensils | Procedure | | | | | | | | | | |
|---|---|---|---|-------|--------|--------|--------|--------|--------|--------|--------|--|--|
| <div style="border: 1px solid black; padding: 2px; display: inline-block;">SENSOR COOK</div> x1 | No. 1 Casserole (initial temp 3°C) | 1 - 2 cups (1 cup = 250 mL) Bowl & plastic wrap | <ul style="list-style-type: none"> Do not cover. Place the bowl in the centre of the turntable. When the oven stops and the audible signals sound, stir. | | | | | | | | | | |
| <div style="border: 1px solid black; padding: 2px; display: inline-block;">SENSOR COOK</div> x2 | No. 2 Fresh Vegetables (initial temp 3°C) e.g. Cauliflower, carrot, broccoli | 0.1 - 0.8 kg Bowl & lid | <ul style="list-style-type: none"> Cut into uniform pieces and add the required amount of water (1 tbsp per 100 g) Cover with a lid. When the oven stops and the audible signals sound, stir. After cooking, stir and let the food stand for approx. 2 minutes. | | | | | | | | | | |
| <div style="border: 1px solid black; padding: 2px; display: inline-block;">SENSOR COOK</div> x3 | No. 3 Rice, white Washed <table border="1" style="margin-left: 20px; margin-top: 10px;"> <thead> <tr> <th>Rice</th> <th>Hot Water</th> </tr> </thead> <tbody> <tr> <td>1 cup</td> <td>2 cups</td> </tr> <tr> <td>2 cups</td> <td>4 cups</td> </tr> <tr> <td>3 cups</td> <td>5 cups</td> </tr> <tr> <td>4 cups</td> <td>6 cups</td> </tr> </tbody> </table> | Rice | Hot Water | 1 cup | 2 cups | 2 cups | 4 cups | 3 cups | 5 cups | 4 cups | 6 cups | 1 - 4 cups (1 cup = 250 mL) Dish & lid | <ul style="list-style-type: none"> Place in a dish and add hot tap water. Cover with a lid. Place the dish in the centre of the turntable. When the oven stops and the audible signals sound, stir. After cooking, let stand, covered for approx. 10 minutes. |
| Rice | Hot Water | | | | | | | | | | | | |
| 1 cup | 2 cups | | | | | | | | | | | | |
| 2 cups | 4 cups | | | | | | | | | | | | |
| 3 cups | 5 cups | | | | | | | | | | | | |
| 4 cups | 6 cups | | | | | | | | | | | | |
| <div style="border: 1px solid black; padding: 2px; display: inline-block;">SENSOR COOK</div> x4 | No. 4 Pasta <table border="1" style="margin-left: 20px; margin-top: 10px;"> <thead> <tr> <th>Pasta</th> <th>Cold Water</th> </tr> </thead> <tbody> <tr> <td>1 cup</td> <td>2 cups</td> </tr> <tr> <td>2 cups</td> <td>4 cups</td> </tr> <tr> <td>3 cups</td> <td>5 cups</td> </tr> <tr> <td>4 cups</td> <td>6 cups</td> </tr> </tbody> </table> | Pasta | Cold Water | 1 cup | 2 cups | 2 cups | 4 cups | 3 cups | 5 cups | 4 cups | 6 cups | 1 - 4 cups (1 cup = 250 mL) Dish & lid | <ul style="list-style-type: none"> Place in a dish and add cold water. Cover with a lid. Place the dish in the centre of the turntable. When the oven stops and the audible signals sound, stir. After cooking, let stand, covered for approx. 2 minutes. |
| Pasta | Cold Water | | | | | | | | | | | | |
| 1 cup | 2 cups | | | | | | | | | | | | |
| 2 cups | 4 cups | | | | | | | | | | | | |
| 3 cups | 5 cups | | | | | | | | | | | | |
| 4 cups | 6 cups | | | | | | | | | | | | |

CONVENIENCE COOK GUIDE

| Key | Menu No. | Weight (Increasing Unit) / Utensils | Procedure |
|--|---|-------------------------------------|---|
| <div style="border: 1px solid black; padding: 2px; display: inline-block;">CONVENIENCE COOK</div> x1 | C-1 Frozen Ready Meals (initial temp -18°C) | 0.4 kg | <ul style="list-style-type: none"> • Remove cardboard packaging. Leave meal in original microwave safe plastic packaging with plastic film on. • Pierce the film with a fork 5 times. • After cooking, stir and let stand for approx. 2 minutes. |
| <div style="border: 1px solid black; padding: 2px; display: inline-block;">CONVENIENCE COOK</div> x2 | C-2 Frozen Vegetables (initial temp -18°C) e.g. Mixed vegetables & cauliflower | 0.5 kg Dish & lid | <ul style="list-style-type: none"> • Place in a dish and cover with a lid. • When the oven stops and the audible signals sound, stir and re-cover. • After cooking, let stand for approx. 2 minutes. <p>NOTE: If frozen vegetables are compacted together, try to separate them before cooking.</p> |
| <div style="border: 1px solid black; padding: 2px; display: inline-block;">CONVENIENCE COOK</div> x3 | C-3 Frozen Lasagne (initial temp -18°C) | 0.4 kg Low rack | <ul style="list-style-type: none"> • Remove cardboard packaging. Leave lasagne in original microwave safe plastic packaging. • Place on the low rack. • Do not cover. • After cooking, let stand, covered in aluminium foil for approx. 5 minutes. |

WEIGHT DEFROST GUIDE

| Key | Menu No. | Weight (Increasing Unit) / Utensils | Procedure |
|----------------------|--|---|--|
| WEIGHT DEFROST x1 | D-1 Steaks, Chops (initial temp -18°C) | 0.25 kg, 0.3 - 1.0 kg (100 g increments) Defrost rack | <ul style="list-style-type: none"> Place the meat on a defrost rack. When the oven stops and the audible signals sound, turn the food over, re-arrange and separate. Shield the thin parts and warm spots with aluminium foil. After defrosting, wrap in aluminium foil until thoroughly defrosted. |
| WEIGHT DEFROST x2 | D-2 Roast Meat (initial temp -18°C) | 1.0 - 2.0 kg (100 g increments) Defrost rack | <ul style="list-style-type: none"> Place the meat on a defrost rack. When the oven stops and the audible signals sound, turn the food over. Shield the defrosted parts with aluminium foil. If audible signals sound, turn the food over and shield again. After defrosting, cover with aluminium foil and stand until thoroughly defrosted. |
| WEIGHT DEFROST x3 | D-3 Minced Meat (initial temp -18°C) | 0.5 - 1.0 kg (100 g increments) Defrost rack | <ul style="list-style-type: none"> Place the meat on a defrost rack. When the oven stops and the audible signals sound, turn the food over. Remove the defrosted parts if possible. After defrosting, cover in aluminium foil until thoroughly defrosted. |
| WEIGHT DEFROST x4 | D-4 Chicken Drumsticks (initial temp -18°C) | 0.20 kg, 0.25 kg, 0.3 - 1.0 kg (100 g increments) Defrost rack | <ul style="list-style-type: none"> Place the food on a defrost rack. When the oven stops and the audible signals sound, turn the food over, re-arrange and separate. Shield the thin parts and warm spots with aluminium foil. After defrosting, wrap in aluminium foil until thoroughly defrosted. |
| WEIGHT DEFROST x5 | D-5 Poultry (initial temp -18°C) | 0.9 - 2.0 kg (100 g increments) Defrost rack | <ul style="list-style-type: none"> Place the food on a defrost rack. When the oven stops and the audible signals sound, turn over and shield the thin parts and warm spots with aluminium foil. After defrosting, cover with aluminium foil and stand until thoroughly defrosted. |
| WEIGHT DEFROST x6 | D-6 Bread (sliced) (initial temp -18°C) | 2, 4 slices Plate | <ul style="list-style-type: none"> Place in a single layer on a plate. When the audible signals sound turn bread over. After defrosting, cover the bread with aluminium foil and let stand for 5 minutes or until thoroughly defrosted. |

There are many brands of microwave safe plastic cookware / defrosting racks available in the market.

MANUAL COOKING CHART

DEFROST TIMES FOR MEAT

1. Remove any packaging and place the frozen item on a shallow microwave safe plastic defrost rack or plate. If necessary, shield thin areas with aluminum foil to prevent the item from cooking while defrosting.
2. Defrost by selecting the cook time first, and then set the microwave power to 30%.
3. When turning over, re-shield any warm areas so it continues to defrost without cooking and remove any defrosted areas if appropriate.
4. Stand item in foil until defrosted.

| Cut | Microwave Time |
|-----------------|-------------------------|
| BEEF (Roast) | 6 – 7 minutes / 500 g |
| Steaks | 6 – 8 minutes / 500 g |
| Minced Beef | 6 – 8 minutes / 500 g |
| PORK (Roast) | 6 – 7 minutes / 500 g |
| Chops | 6 – 8 minutes / 500 g |
| Ribs | 6 – 8 minutes / 500 g |
| Minced Pork | 6 – 8 minutes / 500 g |
| LAMB (Roast) | 10 – 12 minutes / 500 g |
| Chops | 6 – 8 minutes / 500 g |
| Mince | 7 – 9 minutes / 500 g |
| POULTRY | |
| Chicken (Whole) | 7 – 8 minutes / 500 g |
| Drumsticks | 7 – 8 minutes / 500 g |
| Breast | 6 – 8 minutes / 500 g |

MANUAL COOKING CHART

FRESH VEGETABLE

1. Cover required dishes with plastic wrap or a lid.
2. Drain any remaining water after standing before serving.

NOTE: Weights are based on a serving size for approx. 2 people.

| Vegetable | Amount | Microwave Time at 100% power | Cooking Procedure |
|------------------------------------|------------------------|------------------------------|--|
| Asparagus | 1 bunch (approx.130g) | 1 – 3 minutes | Place in a shallow microwave safe dish with 1 tablespoon of water. Cover. Stand for 2 minutes. |
| Beans (top and tailed) | 250 g | 5 – 6 minutes | Place in a shallow microwave safe dish with 1 tablespoon of water. Cover. Stand for 2 minutes. |
| Broccoli (uniform florets) | 250 g | 2 – 4 minutes | Place in a shallow microwave safe dish with 1 tablespoon of water. Cover. Stand for 2 minutes. |
| Cabbage (shredded) | 250 g | 5 – 7 minutes | Place in a shallow microwave safe dish with 1 tablespoon of water. Cover. Stand for 2 minutes. |
| Carrots (sliced) (approx. 1 large) | 200 g | 3 – 5 minutes | Place in a shallow microwave safe dish with 1 tablespoon of water. Cover. Stand for 2 minutes. |
| Cauliflower (uniform florets) | 250 g | 3 – 5 minutes | Place in a shallow microwave safe dish with 1 tablespoon of water. Cover. Stand for 2 minutes. |
| Corn on the Cob | 2 pieces (cut In half) | 6 – 8 minutes | Place in a shallow microwave safe dish with 1 tablespoon of water. Cover. Stand for 2 minutes. |
| Mushrooms (button) | 250 g | 2 – 4 minutes | Place in a shallow microwave safe dish with 1 tablespoon of water. Cover. Stand for 2 minutes. |
| Potatoes | 2 medium | 5 – 7 minutes | Place in a shallow microwave safe dish with ½ cup of water. Cover. Stand for 2 minutes. |
| Pumpkin (2cm cubes) | 350 g | 3 – 4 minutes | Place in a shallow microwave safe dish with 1 tablespoon of water. Cover. Stand for 2 minutes. |
| Spinach (shredded) | 250 g | 5 – 7 minutes | Place in a shallow microwave safe dish with 1 tablespoon of water. Cover. Stand for 2 minutes. |
| Snow Peas (top and tailed) | 200 g | 2 – 4 minutes | Place in a shallow microwave safe dish with 1 tablespoon of water. Cover. Stand for 2 minutes. |
| Squash (whole) | 200 g | 3 – 4 minutes | Place in a shallow microwave safe dish with 1 tablespoon of water. Cover. Stand for 2 minutes. |
| Sweet Potato (2cm cubes) | 350 g | 5 – 6 minutes | Place in a shallow microwave safe dish with 1 tablespoon of water. Cover. Stand for 2 minutes. |
| Zucchini (sliced) | 200g | 2 – 3 minutes | Place in a shallow microwave safe dish with 1 tablespoon of water. Cover. Stand for 2 minutes. |

MANUAL COOKING CHART

RICE & PASTA

1. Wash and strain rice before measuring amounts.
2. Place rice/pasta in a medium/large microwave safe bowl with water. Cook uncovered, stirring halfway through cooking. Allow to stand for 2 minutes before straining any remaining water and serving.

| Food | | Other Ingredients | Cook on 100% Power |
|------------|--------|-------------------|--------------------|
| Pasta | 1 Cup | 2 cups Hot Water | 14 minutes |
| | 2 Cups | 4 cups Hot Water | 17 minutes |
| | 4 Cups | 6 cups Hot Water | 23 minutes |
| White Rice | 1 Cup | 2 cups Hot Water | 18 minutes |
| | 2 Cups | 4 cups Hot Water | 20 minutes |
| | 4 Cups | 6 cups Hot Water | 24 minutes |

PORRIDGE

Place oats and milk/water in a small/medium sized microwave safe dish. Cook uncovered, stirring halfway through cooking then allow to stand, covered, for 5 minutes.

| Serves | Oats | Milk/Water | Cook on 100% Power |
|--------|--------|------------|--------------------|
| 1 | ½ cup | ¾ cup | 3 minutes |
| 2 | 1 cup | 1½ cups | 6 minutes |
| 4 | 2 cups | 3 cups | 12 minutes |

SCRAMBLED EGG

Place butter, eggs and milk in a small/medium microwave safe bowl. Beat with a fork until well combined and yolks of eggs are completely stirred in. Cook uncovered, stirring halfway through cooking.

| Serves | Eggs | Butter | Milk | Cook on 70% Power |
|--------|------|--------|--------|-------------------|
| 1 | 2 | 5 g | 1 tbsp | 2 minutes |
| 2 | 4 | 10 g | ¼ cup | 4 minutes |
| 3 | 6 | 10 g | ¼ cup | 6 minutes |

MANUAL COOKING CHART

REHEATING/DEFROSTING CONVENIENCE FOOD

| Food | Weight | Cooking Time And Power Level | Special Instructions | Standing Time |
|---|-------------------|--|---|---------------|
| Beverage 250 mL per cup | 1 cup 2 cups | 1 minutes 20 seconds on 100% 2 minutes 30 seconds on 100% | Stir after heating. | — |
| Canned Food (room temp.) (e.g. Spaghetti, Baked Beans) | 1 cup 2 cups | 2 minutes 30 seconds on 100% 4 minutes on 100% | Place food in bowl. Stir halfway through cooking. | 2 minutes |
| Canned Soup (room temp) 250 mL per cup (thin soup) | 1 cup 2 cups | 1 minutes 30 seconds on 100% 2 minutes 50 seconds on 100% | Place food in bowl. Stir halfway through cooking. | — |
| Meat Pie (refrigerated) Individual 180g each | 1 pie 4 pies | 5 minutes on Mix Grill 30% 8 minutes on Mix Grill 30% | Place onto a microwave safe plate, face side up. Place plate on the high rack. | 5 minutes |
| Dinner Plate (refrigerated) 400g per serve | 1 serve | 4 minutes on 100% | Cover plate with plastic wrap and pierce 5 times with a fork. | 5 minutes |
| Fruit Pie individual (frozen) 135 g each | 1 2 | 8 minutes on Mix Grill 10% 9 minutes on Mix Grill 10% | Remove from foil container and place on a plate. Place plate on the high rack. | 2 minutes |
| Mini Sausage Rolls | 450g (approx. 15) | 10 minutes on Mix Grill 30% | Place in a single layer on a large plate and onto the high rack. | 2 minutes |
| Mini Meat Pies | 550g (approx. 14) | 12 minutes on Mix Grill 30% | Place in a single layer on a large plate and onto the high rack. | 2 minutes |
| Hash Browns | 4 | 15 minutes on Mix Grill 30% | Place onto a large plate and onto the high rack. Turn over after 10 minutes. | — |
| Spring Rolls | 400g | 15 minutes on Mix Grill 30% | Place onto a large plate and onto the high rack. Turn over after 8 minutes. | 2 minutes |
| Mini Quiche | 20 | 9 minutes on Mix Grill 30% | Place onto a large plate and onto the high rack. | 2 minutes |

NOTE: Room Temperature +20°C
Refrigerator Temperature +3°C
Frozen Temperature -18°C

RECIPES

FISH

PIZZA DOUGH

Serves : Makes 2 pizza bases

Ingredients :

1½ cups plain flour
7 g sachet dried yeast
½ tsp salt
¾ cup lukewarm water

Method:

1. Combine all ingredients together in a bowl and mix to combine. You may find it easier to use your hands for this.
2. Roll dough out onto a lightly floured surface and knead until smooth and dough bounces back when pressed (approx. 5 minutes).
3. Place dough back into the bowl and cover the dough with a damp tea towel. Leave to proof (rest) for 1 hour.
4. Divide dough in half. Using a rolling pin, roll each half into rounds until desired thickness is achieved.

GARLIC PRAWN PIZZA

Serves : Makes 2 pizzas

Ingredients :

300 g ricotta
Zest of 1 lemon
1 tbsp. parsley, finely chopped
4 garlic cloves, crushed
¼ cup parmesan
100 g uncooked prawns, shelled and deveined
Parsley, finely chopped, extra for dusting
Parmesan, extra for dusting

Method:

1. Place the rolled pizza dough onto 2 square trays lined with baking paper.
2. Combine the ricotta, lemon zest, parsley, half the garlic and parmesan in a bowl and spread the mixture over the base of both the doughs.
3. Combine the remaining half of the garlic and the prawns and spread over the pizza bases. Sprinkle the extra parsley and parmesan over the top.
4. Place the square trays on the shelf rails (rails 1 and 2) and cook on auto menu "Pizza". When the oven stops, cook pizza for an additional 10 minutes on convection 250°C, swapping the pizza bases over half way.

Note: If only cooking 1 pizza base, use auto menu "Pizza" without the extended cook time.

TERIYAKI SALMON

Serves : Serves 4

Ingredients :

2 tbsp. soy sauce
2 tbsp. mirin
2 tbsp. Chinese cooking wine (Shao Shing)
1 tbsp. castor sugar
4 salmon fillets, skinned (approx. 230 g each)

Method:

1. To make the teriyaki sauce, combine the soy sauce, mirin, Chinese cooking wine and castor sugar in a small jug and stir until the sugar is dissolved.
2. Place salmon fillets side by side in a microwave safe dish and pour the teriyaki sauce over the salmon to coat each piece. Place dish on the low rack and cook for 15 minutes on mix convection 30% / 200°C.

RECIPES

PORK

SAN CHOY BAU

Serves : Serves 4

Ingredients :

1 tbsp. sesame oil
2 cloves garlic, crushed
5cm piece ginger, finely chopped
500 g pork mince
100 g brown mushrooms, finely chopped
½ red capsicum, finely chopped
1 x 227 g water chestnuts, drained and finely chopped
2 shallots, sliced
1 tsp. fresh coriander, finely chopped
50 g (approx. ½ cup firmly packed) bean sprouts
⅓ cup oyster sauce
3 tsp. fish sauce
Iceberg lettuce, to serve

Method:

1. Combine the sesame oil, garlic and ginger in a microwave safe dish and cook for 1 minute on 70% microwave power.
2. Add mince and mix to combine. Cook for 5 minutes on 50% microwave power. Stir half way through cooking.
3. Add mushrooms and cook for 2 minutes on 50% microwave power.
4. Drain all the liquid from the dish then add remaining ingredients excluding the lettuce and mix to combine. Cook for a further 2 minutes on 70% microwave power.
5. Cut 3-4cm off the base of the lettuce. Pull lettuce leaves off one by one and wash leaves. Place a few spoonfuls of cooked mixture into the centre of each leaf and roll up to eat.

ROAST PORK

Serves : Serves 4~6

Ingredients :

2 garlic cloves
1 tbsp. ginger, grated
1 tbsp. tomato paste
¼ tsp. chilli powder
1 tsp. fish sauce
½ tsp. Chinese five spice
¼ cup hoisin sauce
2 kg pork roast

Method:

1. Mix all ingredients together in a small bowl and rub over pork.
2. Place pork in a microwave safe dish on the low rack and cook using the auto menu "Roast Pork". If more crispy skin is desired, place the pork rind under the grill for 10 minutes or until desired results are achieved.

RECIPES

CHICKEN

SATAY CHICKEN PIZZA

Serves : Makes 2 pizzas

Note: refer to fish section on page 27 for pizza dough recipe

Ingredients :

Satay sauce:

½ onion, cut into quarters

1 garlic clove

¼ cup coconut cream

½ cup crunchy peanut butter

1 small red chilli, seeds removed, sliced

1tbsp. soy sauce

1 tsp brown sugar

Topping:

2 chicken thigh fillets, very thinly sliced into strips 1cm wide

1 shallot, finely sliced

½ red capsicum, finely sliced

Cheddar cheese, to taste

MOROCCAN ROAST CHICKEN

Serves : Serves 4~6

Ingredients :

1½ tsp ground cumin

1½ tsp ground coriander

1½ tsp sweet paprika

1 tsp turmeric

1 tsp ground cinnamon

½ onion, grated

1 tbsp. vegetable oil

2 kg chicken

Method:

1. Place all ingredients for the satay sauce into a food processor and process until well combined.
2. Place the pizza bases onto 2 square trays lined with baking paper. Spread 2 heaped tablespoons of satay sauce over each of the pizza bases.
3. Mix 2 heaped tablespoons of satay sauce with the sliced chicken or enough to coat the chicken well and spread chicken mixture evenly over the 2 pizza bases. Top with the shallot and capsicum and sprinkle over the cheese.
4. Place the square trays on the shelf rails (rails 1 and 2) and cook on auto menu "Pizza". When the oven stops, cook pizza for an additional 10 minutes on convection 250°C, swapping the pizza bases over half way.

Method:

1. Combine the spices, onion, garlic and oil in a bowl and rub over chicken.
2. Place chicken on a microwave safe dish and onto the low rack. Bake on auto menu "Roast Chicken". If a more crispy skin is desired, cook under the grill for a further 5-10 minutes on each side.

RECIPES

VEGETARIAN

SPINACH AND RICOTTA CANNELLONI

Serves : Serves 4

Ingredients :

250 g frozen spinach, thawed and drained
1 cup parmesan
300g ricotta
1 egg
Pinch nutmeg
Salt and pepper
About 4 fresh lasagne sheets
½ x 420 g can condensed pumpkin soup
2 tbsp. milk
¼ cup water
Mozzarella cheese, to taste

Method:

1. Mix the spinach, parmesan, ricotta, egg, nutmeg, salt and pepper together in a bowl.
2. Lay a lasagne sheet flat and spoon about 2 tablespoons of mixture along one of the edges. Roll the lasagne sheet over the mixture to form a tube and cut off excess pasta. Repeat with remaining mixture.
3. Combine the pumpkin soup, milk and water in a jug. Pour 2 tablespoons of mixture over the base of a microwave safe dish and spread evenly to coat the bottom of the dish.
4. Place the tubes side by side into the dish and pour over remaining pumpkin soup mix. Sprinkle the mozzarella cheese over the top.
5. Place the dish on the high rack. Using the multiple sequence cooking function, cook for 14 minutes on 70% microwave power and then 4 minutes on grill.

POTATO BAKE

Serves : Serves 6

Ingredients :

800 g potatoes, thinly sliced (approx. 2-4mm thick)
½ leek, sliced
200 g mushrooms, sliced
1½ cups cheddar cheese, grated
2 garlic cloves, crushed
300 mL thickened cream
Salt and pepper

Method:

1. Place the potatoes, leek, mushrooms and one third of the cheese in a large microwave safe dish.
2. Combine the garlic, cream, salt and pepper in a jug and pour over the potatoes. Toss to ensure potatoes are coated by the cream mixture.
3. Sprinkle remaining cheese over the top of the potatoes and place on the low rack. Using the multiple sequence cooking function, cook for 24 minutes on 100% microwave power and then 7 minutes on grill.

RECIPES

BEEF

SPAGHETTI BOLOGNAISE

Serves : Serves 4-6

Ingredients :

1 onion, finely diced
2 garlic cloves, crushed
100 g mushrooms, chopped
1 tablespoon olive oil
500 g beef mince
50 g sachet tomato paste
1 tin whole tomatoes
½ tin condensed tomato soup
3 bay leaves
1 tbsp. dried mixed herbs
1 tsp sugar
Salt and pepper
250 g dried spaghetti

Method:

1. Place onion, garlic, mushrooms and oil into a medium sized microwave safe dish and cook for 2 minutes on 100% microwave power.
2. Add the beef mince, breaking it up with a fork. Cook for 4 minutes on 70% microwave power, stirring half way through.
3. Add tomato paste, tinned tomatoes, condensed tomato soup, bay leaves, dried mixed herbs, sugar, salt and pepper. Cook for 8 minutes on 50% microwave power then cover with a lid and let the mixture sit while you cook the pasta.
4. Break the spaghetti in half and place in a large bowl with 5 cups of hot water. Cook uncovered for 10 minutes on 100% microwave power before draining and refreshing in cold water.

MASSAMAN BEEF SKEWERS

Serves : Makes 14 skewers

Ingredients :

1 onion, cut into quarters
2 garlic cloves
½ cup salted roasted peanuts
⅓ cup fresh coriander
1 kg beef mince
195 g jar massaman curry paste
3 tbsp. coconut cream
14 wooden skewers soaked in water

Method:

1. In a food processor, combine the onion, garlic, peanuts and coriander and blend until ingredients are finely chopped.
2. In a large bowl, place the blended mixture, the beef mince, massaman curry paste and coconut cream and stir well to combine.
3. Using 2 heaped tablespoons of mixture, shape mixture into a long sausage, approx. 12cm x 4cm and then insert a skewer down the centre. Repeat with remaining mixture.
4. Place 7 of the skewers onto the high rack, with the meat end sitting at alternate ends of the rack. Cook for 22 minutes, turning the skewers over after 12 minutes. Repeat process with remaining 7 skewers.

RECIPES

DESSERTS

CARROT CAKE

Serves : Serves 10

Ingredients :

1 cup vegetable oil
1 cup brown sugar
3 eggs
1½ cups self-raising flour
1 tsp bicarb soda
1 tsp ground cinnamon
1 tsp mixed spice
Pinch salt
2 large carrots, grated
¼ cup (90g) walnuts, roughly chopped

Method:

1. Whisk the oil, sugar and eggs together to combine.
2. Sift in flour, bicarb, cinnamon, mixed spice and salt and then fold through the grated carrot and walnuts.
3. Pour mixture into a microwave safe dish lined with baking paper and cook for 12 minutes on 70% microwave power.
4. Stand cake for 5 minutes before turning out onto a wire rack to cool.

APPLE CRUMBLE

Serves : Serves 6~8

Ingredients :

90 g butter
¾ cup plain flour
⅔ cup rolled oats
¼ cup brown sugar
¼ cup sliced almonds
1 tsp cinnamon
800 g can apples

Method:

1. To make the crumble, rub the butter into the flour until it resembles fine breadcrumbs then stir in the oats, brown sugar, almonds and cinnamon and combine well.
2. Pour the apples into a shallow microwave safe dish and spread them out evenly. Sprinkle over the crumble mixture.
3. Place dish on the low rack and bake for 20 minutes on convection 200°C.

CHOCOLATE BROWNIES

Serves : Serves 12

Ingredients :

150 g butter
180 g dark chocolate
3 eggs
1½ cups castor sugar
1 tsp vanilla essence
1 cup plain flour, sifted
¼ cup cocoa, sifted

Method:

1. Melt the butter and chocolate in a small microwave safe bowl by cooking on 100% power for 1 minute 45 seconds, stirring halfway through cooking (try cutting the butter into small cubes and breaking the chocolate into pieces for more efficient results).
2. In a large bowl, whisk the eggs, castor sugar and vanilla essence until combined.
3. Whisk in the melted butter and chocolate, flour and cocoa until just combined.
4. Line the base and sides of a 21cm square microwave safe dish, such as a Pyrex dish, with baking paper. Leave a little extra baking paper on the sides to allow you to easily lift the brownies out of the dish later on. Pour batter into dish and cook for 10 minutes on 70% microwave power. The centre should be quite fudgy so a skewer should not come out completely clean.

SHARP

WARRANTY

Consumer Electronic Products

Congratulations on Your Purchase!

This Sharp product is warranted against faults in material and manufacture for the period as stated in the table below.

If service is required during the warranty period, please contact your nearest Sharp Approved Service Centre. These repairs would be carried out at no charge to the owner, subject to the conditions specified herein.

This warranty does not extend to defects or injuries caused by or resulting from causes not attributable to faulty parts or the manufacture of the product, including but not limited to, defect or injury caused by or resulting from misuse, abuse, neglect, lack of maintenance, accidental damage, improper voltage, liquid spillage, vermin infestation, software, or any alterations made to the product which are not authorised by Sharp.

Please retain your sales documentation, as this should be produced to validate a warranty claim. This warranty is in addition to and in no way limits, varies or excludes any implied rights and remedies under any relevant legislation in the country of sale.

This warranty does not cover transportation to and from the Sharp Approved Service Centre. Goods presented for repair may be replaced by refurbished goods of the same type rather than being repaired. Refurbished parts may be used to repair the goods. The repair of your goods may result in the loss of user generated data, please ensure that you have saved this data elsewhere prior to repair.

Australian customers: Our goods come with guarantees that cannot be excluded under the Australian Consumer Law. You are entitled to a replacement or refund for a major failure and for compensation for any other reasonably foreseeable loss or damage. You are also entitled to have the goods repaired or replaced if the goods fail to be of acceptable quality and the failure does not amount to a major failure. The criteria of a major failure is defined in the Australian Consumer Law. Should you require any assistance with a major failure please contact Sharp Customer Care.

WARRANTY PERIODS

| | | |
|--------------------------|-----------|-----------------------------------|
| Home Theatre Projector | 12 months | (excluding lamps and air filters) |
| Audio/Home Theatre | 12 months | |
| Microwave / Steam Oven | 12 months | |
| Slow Juicer | 12 months | |
| Refrigerator | 24 months | |
| DVD/Blu-ray | 12 months | |
| Washing Machine | 24 months | |
| Portable Air Conditioner | 12 months | |
| LCD Television | 12 months | |
| Air Purifier | 12 months | |
| Coffee Machine | 12 months | |



































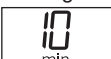



SHARP
 SHARP CORPORATION OF AUSTRALIA PTY LIMITED
 ABN 40 003 039 405
 2 Julius Ave, North Ryde, NSW 2113
 SHARP CORPORATION OF NEW ZEALAND LIMITED
 53 Hugg Johnson Drive
 Panmure, Auckland

IMPORTANT NOTICE: This warranty applies only to products sold in Australia & New Zealand

SHARP
 FOR LOCATION ENQUIRIES WITHIN
AUSTRALIA
 REGARDING YOUR LOCAL
SHARP APPROVED SERVICE CENTRE
 VISIT OUR WEBSITE AT
www.sharp.net.au
 OR CALL SHARP
 LOCAL CALL **1300 135 022**
 SHARP CORPORATION OF AUSTRALIA PTY LTD

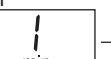
SHARP
 FOR PRODUCTS PURCHASED
NEW ZEALAND
 CONTACT YOUR SELLING DEALER/RETAILER
 OR CALL
SHARP CUSTOMER SERVICES
 TELEPHONE: **09 573 0111**
 FACSIMILE: 09 573 0113
 WEB:
www.sharp.net.nz
 SHARP CORPORATION OF NEW ZEALAND LIMITED

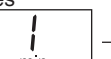
QUICK REFERENCE GUIDE

| FEATURE | QUICK OPERATION GUIDE |
|--|---|
| Auto Menu |  x 5 eg. 0.5 kg Within 3 minutes of closing the door, cooking completion or pressing STOP/CLEAR. |
| Sensor Cook | Menu Number  x 2 →  eg. Fresh Vegetables |
| Convenience Cook | Menu Number  x 3 →  eg. Frozen Lasagne |
| Weight Defrost | Menu Number  x 1 →  x 6 or  x 4 →  eg. Steak Weight eg. 0.5 kg |
| + 1 min. for Direct Start (100% microwave power cooking) | Just One Touch  Within 3 minutes of closing the door, cooking completion or pressing STOP/CLEAR. |
| Microwave | Cooking Time  x 4 → Power Level  x 4 →  eg. 40 seconds eg. 30% |
| Grill | Cooking Time  x 1 →  →  eg. 10 minutes |
| Convection (with Preheat) | Temp.  x 4 →  → Cooking Time  x 2 →  eg. 200°C eg. 20 minutes |
| Mix Cooking (Mix Grill) | Cooking Time  x 2 →  → Power Level  x 2 →  eg. 20 minutes eg. 10% |
| Mix Cooking (Mix Convection) | Cooking Time  x 2 →  → Power Level  x 2 → Temp.  x 4 →  eg. 20 minutes eg. 10% eg. 200°C |
| Timer | Time  x 1 →  x 3 →  eg. 3 minutes |
| Clock | To set for 11:34 am. Hour  x 2 →  x 1 →  x 1 →  → Minutes  x 3 →  x 4 →  |