

# SHARP

## COMMERCIAL MICROWAVE OVEN

Ⓝ

# MODEL R-2197

## OPERATION MANUAL AND COOKING GUIDE

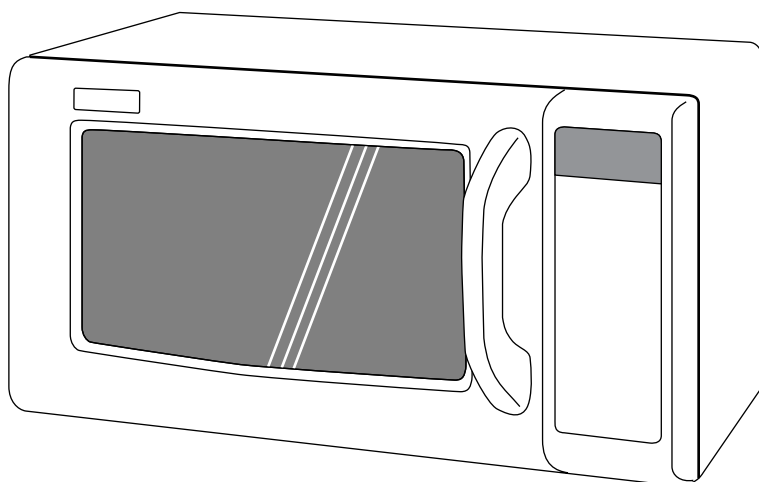

### CONTENTS

Page

Warning	1
Special Notes	2
Installation Instructions	3
Oven Diagram	4
Operation of Touch Control Panel	5
Before Operating	5
Sound Setting	5
Stop/Clear	5
Memory Operation	5
Cooking with Memory	5
Cooking Double Quantity with Memory	6
Memory Programme Entry	6
Memory Check	9
Manual Operation	10
Time Cooking	10
Multiple Sequence Cooking	11
Other Convenient Features	12
Express Defrost	12
Express Defrost Chart	12
Counter Check	13
Demonstration Mode	14
Error Mode	14
Care and Cleaning	14
Service Call Check	15
Specifications	15
Helpful Hints	16
Cookware and Utensil Guide	17
Warranty	18
Quick Reference Guide	19

# WARNING

IMPORTANT SAFETY INSTRUCTIONS : READ CAREFULLY AND KEEP FOR FUTURE REFERENCE.

To reduce the risk of fire in the oven cavity:

- a. Do not overcook food.
- b. Remove wire twist-ties from paper or plastic bags before placing bag in the oven.
- c. Do not heat oil or fat for deep frying. The temperature of the oil cannot be controlled.
- d. Look at the oven from time to time when food is heated in disposable containers made of plastic, paper or other combustible materials for signs of smoke or burning.
- e. If materials inside the oven should ignite, or smoke is observed, keep oven door closed, turn oven off, and disconnect the power cord, or shut off power at the fuse or circuit breaker panel.

To reduce the risk of an explosion or delayed eruptive boiling:

Your microwave oven is capable of heating food and beverages very quickly therefore, it is very important that you select the appropriate cooking time and power level for the type and quantity of food to be heated. If you are unsure of the cooking time and power level required, begin with low cooking times and power levels until the food is sufficiently heated evenly throughout.

Additionally:

- a. Do not place sealed containers in the oven. Babies bottles fitted with a screw cap or teat are considered to be sealed containers.
- b. Do not use excessive amount of time.
- c. When boiling liquids in the oven, use a wide-mouthed container.
- d. Stand at least for 20 seconds at the end of cooking to avoid delayed eruptive boiling of liquids.
- e. Stir the liquid before and during cooking. Use extreme care when handling the container or inserting a spoon or other utensil into the container.

This oven is for food preparation only and should only be used for heating, cooking and defrosting food and beverage.

It is not suitable for laboratory use, or heating therapeutic devices eg. Wheat bags.

The electrical outlet must be readily accessible so that the unit can be unplugged easily in an emergency.

Never operate the oven whilst any object is caught or jammed between the door and the oven.

Do not try to adjust or repair the oven yourself.

It is hazardous for anyone other than a qualified service technician trained by SHARP to carry out any service or repair operation. Especially those which involve the removal of a cover which gives protection against exposure to microwave energy are very hazardous.

Do not operate the oven if it is not working correctly or damaged until it has been repaired by a qualified service technician trained by SHARP. It is particularly important that the oven door closes properly and that there is no damage to:

(1) Door (warped), (2) Hinges and Latches (broken or loosened), (3) Door Seals, Sealing Surfaces and oven cavity (buckled or deformed), (4) Burn marks on the door seal faces.

Do not bump, or catch utensils, loose clothes and your accessories on the door safety latches when removing food from the oven.

Never poke an object, particularly a metal object, through a grille or between the door and the oven while the oven is operating.

Never tamper with or deactivate the door safety latches.

Always use oven gloves to prevent burns when handling utensils that are in contact with hot food. Enough heat from the food can transfer through utensils to cause skin burns.

Should the power supply cord become damaged, it must be replaced with a special cord supplied by a SERVICE CENTRE APPROVED BY SHARP. And it must be replaced by a qualified service technician trained by SHARP.

Avoid steam burns by directing steam away from the face and hands.

Slowly lift the furthest edge of a dish's cover and microwave plastic wrap and carefully open popcorn and oven cooking bags away from the face.

Make sure that the power supply cord is undamaged, and that it does not run under the oven or over any hot surfaces or sharp edges.

Do not place anything on the outer cabinet.

Do not store food or any other items inside the oven.

Make sure the utensil does not touch the interior walls during cooking.

Only allow children to use the oven without supervision when adequate instructions have been given so that the child is able to use the oven in a safe way and understands the hazards of improper use.

This appliance is not intended for use by young children or infirm persons without supervision.

Young children should be supervised to ensure that they do not play with the appliance.

Do not use the oven near the steamer and fryer.

Individuals with PACEMAKERS should check with their doctor or the manufacturer of the pacemaker for precautions regarding microwave ovens.

# SPECIAL NOTES

	DO	DON'T
Eggs, fruits, nuts, seeds, vegetables, sausages and oysters	<ul style="list-style-type: none"> <li>* Puncture egg yolks and whites and oysters before cooking to prevent "explosion".</li> <li>* Pierce skins of potatoes, apples, squash, hot dogs, sausages and oysters so that steam escapes.</li> </ul>	<ul style="list-style-type: none"> <li>* Cook eggs in shells. This prevents "explosion", which may damage the oven or injure yourself.</li> <li>* Reheat whole eggs.</li> <li>* Overcook oysters.</li> <li>* Dry nuts or seeds in shells.</li> </ul>
Popcorn	<ul style="list-style-type: none"> <li>* Use specially bagged popcorn for the microwave oven.</li> <li>* Listen while popping corn for the popping to slow to 1-2 seconds.</li> </ul>	<ul style="list-style-type: none"> <li>* Pop popcorn in regular brown bags or glass bowls.</li> <li>* Exceed maximum time on popcorn package.</li> </ul>
Baby food	<ul style="list-style-type: none"> <li>* Transfer baby food to small dish and heat carefully, stirring often. Check for suitable temperature to prevent burns.</li> <li>* Remove the screw cap and teat before warming baby bottles. After warming shake thoroughly. Check for suitable temperature.</li> </ul>	<ul style="list-style-type: none"> <li>* Heat disposable bottles.</li> <li>* Overheat baby bottles. Only heat until warm.</li> <li>* Heat bottles with nipples on.</li>   <li>* Heat baby food in original jars.</li> </ul>
General	<ul style="list-style-type: none"> <li>* Food with filling should be cut after heating, to release steam and avoid burns.</li> <li>* Use a deep bowl when cooking liquids or cereals to prevent boiling over.</li> </ul>	<ul style="list-style-type: none"> <li>* Heat or cook in closed glass jars or air tight containers.</li>   <li>* Deep fat fry.</li> <li>* Heat or dry wood, herbs, wet papers, clothes or flowers.</li> <li>* Operate the oven without a load (i.e. an absorbing material such as food or water) in the oven cavity.</li> </ul>
Liquids (Beverages)	<ul style="list-style-type: none"> <li>* For boiling or cooking liquids see WARNING on page 1 to prevent explosion and delayed eruptive boiling.</li> </ul>	<ul style="list-style-type: none"> <li>* Heat for longer than recommended time.</li> </ul>
Canned foods	<ul style="list-style-type: none"> <li>* Remove food from can.</li> </ul>	<ul style="list-style-type: none"> <li>* Heat or cook food while in cans.</li> </ul>
Sausage rolls, Pies, Christmas pudding	<ul style="list-style-type: none"> <li>* These foods have high sugar and/or fat contents.</li> <li>* Cook for the recommended time.</li> </ul>	<ul style="list-style-type: none"> <li>* Overcook as they may catch fire.</li> </ul>
Meats	<ul style="list-style-type: none"> <li>* Use a microwave proof roasting rack to collect drained juices.</li> </ul>	<ul style="list-style-type: none"> <li>* Place meat directly on the ceramic shelf for cooking.</li> </ul>
Utensils	<ul style="list-style-type: none"> <li>* Check the utensils are suitable for MICROWAVE cooking before you use them.</li> </ul>	<ul style="list-style-type: none"> <li>* Use metal utensils for MICROWAVE cooking. Metal reflects microwave energy and may cause an electrical discharge known as arcing.</li> </ul>
Aluminium foil	<ul style="list-style-type: none"> <li>* Use to shield food to prevent over cooking.</li> <li>* Watch for sparking. Reduce foil or keep clear of cavity walls.</li> </ul>	<ul style="list-style-type: none"> <li>* Use too much.</li> <li>* Shield food close to cavity walls. Sparking can damage the cavity.</li> </ul>
Browning dish	<ul style="list-style-type: none"> <li>* Place a suitable insulator such as a microwave and heat proof dinner plate between the ceramic shelf and the browning dish.</li> </ul>	<ul style="list-style-type: none"> <li>* Exceed the preheating time recommended by the manufacturer. Excessive preheating can damage internal parts of the oven.</li> </ul>

# INSTALLATION INSTRUCTIONS

1. Remove all packing materials from the oven cavity, and the feature sticker from the outside of the door, if there is one. Remove the protective film (blue film) from the outer case cabinet. Check the unit for any damage, such as a misaligned door, damaged door seals around the door or dents inside the oven cavity or on the door. If there is any damage, please do not operate the oven until it has been checked by a SERVICE CENTRE APPROVED BY SHARP and repaired, if necessary.
2. Accessories provided
  - 1) Operation manual and cooking guide
  - 2) Caution sheet (SPECIAL INSTRUCTIONS AND WARNINGS: part code TCAUHA276WRRZ)
3. The oven should not be installed in any area where excessive heat and steam are generated, for example, next to a conventional oven unit.

The oven should be installed so as not to block ventilation openings.  
Allow at least 40 cm on the top and 5 cm on the both sides of the oven for free air space. And the rear of the oven should touch the wall.
4. Neither the manufacturer nor the distributors can accept any liability for damage to the machine or personal injury for failure to observe the correct electrical connecting procedure.

The A.C. voltage must be single phase 230-240V, 50Hz.
5. It is recommended that a separate circuit serving only this appliance be provided.
6. This appliance must be earthed.
7. Operate the oven from a general purpose outlet.

If a generator is used, do not operate the oven with non-sinusoidal outputs.
8. The unit may be secured to a countertop or stand. There is a screw hole in the bottom of the unit. After the oven is permanently placed, drill a hole through the counter top for a 5 mm self-tapping screw. The hole should be 20 mm from the left side of the outer case cabinet and 180 mm back from the front edge of the cavity face plate.
9. Never stack two ovens.

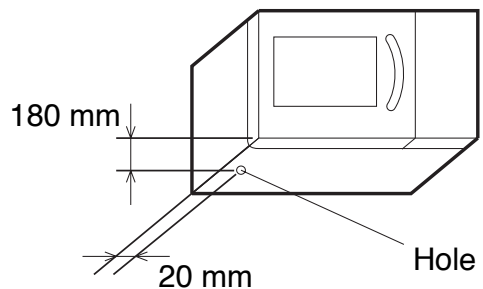

# OVEN DIAGRAM

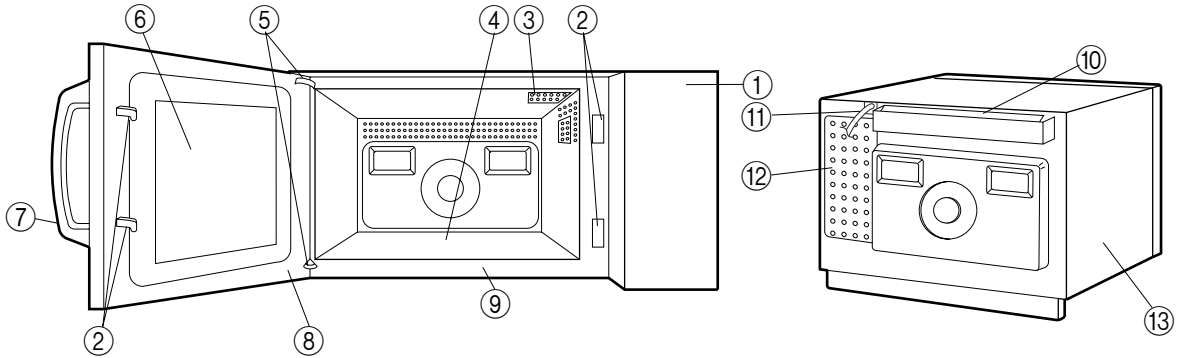

- 1. Touch control panel
- 2. Door safety latches
- 3. Oven lamp
- 4. Ceramic shelf
- 5. Door hinges
- 6. See through door
- 7. Door handle
- 8. Door seals and sealing surfaces
- 9. Cavity face plate
- 10. Air ventilation cover and openings
- 11. Power supply cord
- 12. Air intake openings
- 13. Outer case cabinet

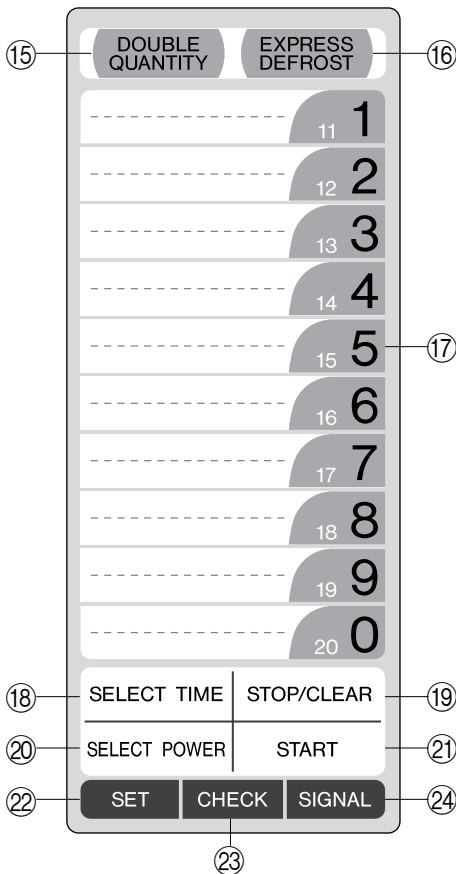
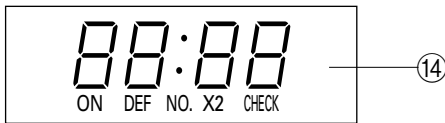

- 14. Indicator
- 15. DOUBLE QUANTITY pad
- 16. EXPRESS DEFROST pad
- 17. NUMBER pads for time and memory programming
- 18. SELECT TIME pad
- 19. STOP/CLEAR pad; press to stop operation of oven and clear remaining heating time
- 20. SELECT POWER pad for setting variable power level
- 21. START pad; press to operate oven after door is closed and time is set
- 22. SET pad for setting memory
- 23. CHECK pad for checking memory
- 24. SIGNAL pad for setting signal sound

# OPERATION OF TOUCH CONTROL PANEL

The operation of the oven is controlled by pressing the appropriate pads arranged on the surface of the control panel.

An entry signal tone should be heard each time you press the control panel to make a correct entry.

## Before Operating

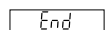
- When you first connect the microwave oven to an electrical socket, the digital display will show .
- Key pad entries can only be made when the door is shut.
- The programme or check mode is cancelled when any pads are not pressed for more than 3 minutes.
-  will appear on the display after the time reaches zero. It will disappear when the oven door is opened or the STOP/CLEAR pad is pressed.

## Sound Setting

- There is a choice of 2 different sounds and no sound on your oven.
- To set signal, touch the SET pad twice within 2 seconds and then touch the SIGNAL pad continuously until you hear desired tone.

## Stop/Clear

- If you want to stop the oven during cooking:
  - Press the STOP/CLEAR pad once.
  - Open the door (except memory cooking).  
To start the oven again, close the door and press the START pad within 1 minute.
- If you open the door during memory cooking, the programme is cancelled.
- If you want to cancel a programme during cooking, press the STOP/CLEAR pad twice.
- If you want to clear a mistake during programming, press the STOP/CLEAR pad once.

## MEMORY OPERATION

- This oven has 20 memory banks (1-20) which can store cooking programmes.
- The memory banks 1-0 have been programmed previously as shown in the table. These preprogrammed memory banks can be changed individually if required.
- In addition for all memory banks a time constant 1.7 for the double quantity is stored. The stored time constant can also be changed individually if required.
- Information in these memory banks is not lost due to power interruptions. If the power goes off, the oven does not need to be reprogrammed. No batteries are necessary for this type of memory.
- If you want to cook using memory 11-20, press the desired NUMBER pad twice within 1 second.



Memory No.	Cook Time	Output Power
1	10 sec.	100%
2	20 sec.	100%
3	30 sec.	100%
4	45 sec.	100%
5	1 min.	100%
6	1 min. 15 sec.	100%
7	1 min. 30 sec.	100%
8	2 min.	100%
9	2 min. 30 sec.	100%
0	3 min.	100%

To check the stored programmes please refer to "Memory check" on page 9.

To change the stored programmes please refer to "Memory programme entry" on page 6.



## Cooking with Memory

\* Suppose you want to cook by using memory 1, which was programmed for 10 seconds at 100%.

Step	Procedure	Pad Order	Display
1	Press the NUMBER pad  .		<div style="border: 1px solid black; padding: 5px; text-align: center;">                     NO. 1                 </div> <p>After about 1 sec.</p> <div style="border: 1px solid black; padding: 5px; text-align: center;">                     ON . 10                 </div>

## Cooking Double Quantity with Memory

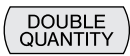
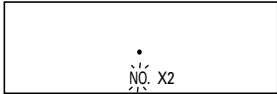
\* Suppose you want to cook a double quantity using memory 1.

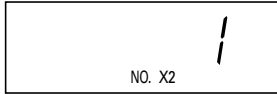
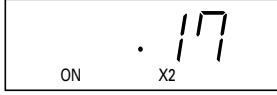
Step	Procedure	Pad Order	Display
1	Press the DOUBLE QUANTITY pad.		 NO. will flash on and off.
2	Press the NUMBER pad  .		 After about 1 sec. 

- Note:
1. If the cooking time of double quantity is over the max. time, the display will show "EE9". See page 14.
  2. Double quantity means best time for cooking double quantity; it is not double the time.
  3. The "MEMORY" cooking system does not require the use of the START pad. MEMORY cannot be used to start the oven if any programme is on display.

## Memory Programme Entry

You can change memory programmes for memory banks.

**Memory banks** 20

### Cooking stage

**Memory NO. 1-10** Max.3 stages

**Memory NO.11-20** Max.2 stages

**Microwave power level** 0~100%

**Cooking time** Max. 30 minutes for each stage.  
And total cooking time is max.30 minutes.

## COOKING GUIDE AND POWER LEVEL











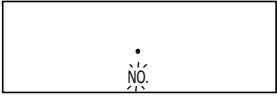

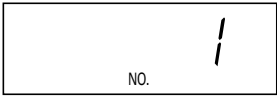

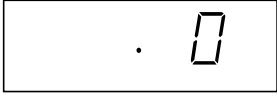





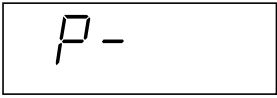

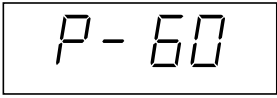
Use the correct NUMBER pad after pressing the SELECT POWER pad.

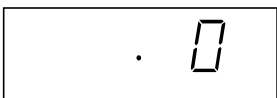
The following chart gives examples of foods typically cooked on microwave power levels.

Number Pads	Microwave Power Levels	Display	Examples of Foods
SELECT POWER	100%	P-HI	Beverage, Fruit, Vegetables, Rice/Pasta
9	90%	P-90	
8	80%	P-80	
7	70%	P-70	Seafood, Cakes, Muffins, Slices, Casseroles, Lasagne
6	60%	P-60	
5	50%	P-50	
4	40%	P-40	
3	30%	P-30	Defrosting, Softening butter
2	20%	P-20	
1	10%	P-10	Keeping food warm
0	0%	P- 0	No microwave power

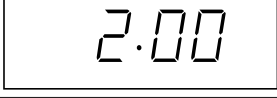
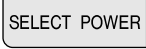
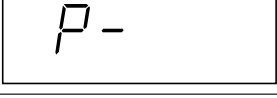
## TO PROGRAMME TIME AND POWER LEVEL INTO A MEMORY

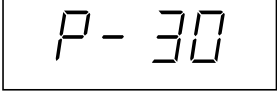
\* Suppose you want to set 4 minutes at 60% at the 1st sequence and 2 minutes at 30% at the 2nd sequence for 1 serving in the memory 1.

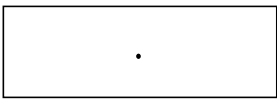
Step	Procedure	Pad Order	Display
1	Press the SET pad twice within 2 seconds.	 X 2 Within 2 sec.	 NO. will flash on and off.
2	Press the NUMBER pad  .		
3	Press the SELECT TIME pad.		
4	Enter desired cooking time for the 1st sequence. (4 minutes)	  	
5	Press the SELECT POWER pad.		
6	Enter desired power level for the 1st sequence. (60%)		
7	Press the SELECT TIME pad.		
8	Enter desired cooking time for the 2nd sequence. (2 minutes)	  	
9	Press the SELECT POWER pad.		
10	Enter desired power level for the 2nd sequence. (30%)		
11	Press the SET pad twice to complete the setting.	 X 2	









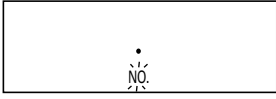
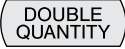
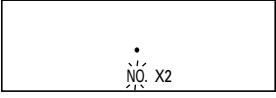

- Note:
1. If the cooking time is over the max. time, the display will show "EE9". See page 14.
  2. If your programmed time is over max. time at Double Quantity, you cannot use Double Quantity for the memory. You can cook only 1 serving.
  3. It is not necessary to press the SELECT POWER pad for 100%.
  4. At step 1, any audible signals will not sound when the SET pad is pressed first and then an audible signal will sound when the SET pad is pressed second.

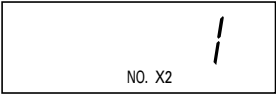

## TO CHANGE THE TIME CONSTANT FOR DOUBLE QUANTITY

The time constant for double quantity is preset 1.7 times the single quantity cooking time, but you can alter this constant to suit your needs.

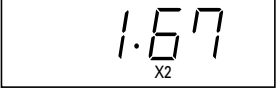
\* Suppose you want to change the time constant to 1.67 in memory 1.

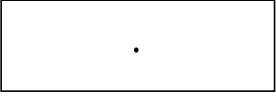
Step	Procedure	Pad Order	Display
1	Press the SET pad twice within 2 seconds.	 X 2 Within 2 sec.	 NO. will flash on and off.
2	Press the DOUBLE QUANTITY pad.		
3	Press the NUMBER pad  .		
4	Press the SELECT TIME pad.		
5	Set the time constant (1.67).	  	
6	Press the SET pad twice to complete the setting.	 X 2	





- Note:
1. In case you want to change the time constant it must be set for each key separately.
  2. The time constant can be set from 0.00 to 9.99.
  3. At step 1, any audible signals will not sound when the SET pad is pressed first and then an audible signal will sound when the SET pad is pressed second.

# Memory Check

You can check the information programmed into the memory.

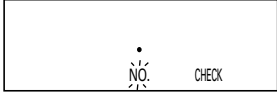
## CHECKING TIME AND POWER LEVEL

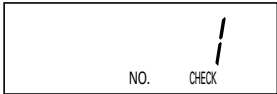
\* Suppose you want to know the information programmed into the memory 1, programmed for 4 minutes at 60% at the 1st sequence and 2 minutes at 30% at the 2nd sequence.

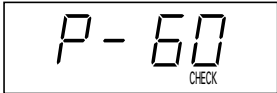
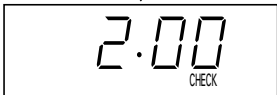
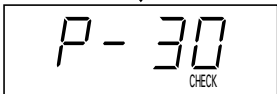
Step	Procedure	Pad Order	Display
1	Press the CHECK pad.		 NO. will flash on and off.
2	Press the NUMBER pad  .		 After about 1 sec.     REPEAT









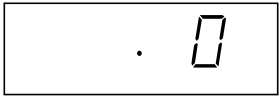

- Note:
1. To cancel MEMORY CHECK, press the CHECK pad.
  2. When  is displayed at Step 2, the memory is not set.
  3. To check the time constant for double quantity, press the DOUBLE QUANTITY pad and the desired NUMBER pad in step 2.

# MANUAL OPERATION

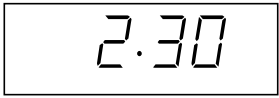
Your oven can be programmed for up to 3 cooking sequences and has 11 preset microwave power levels. See page 6.

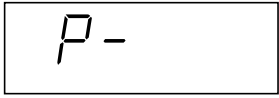
## Time Cooking

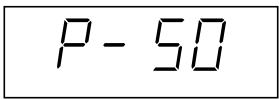

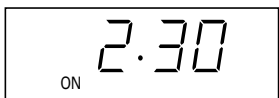





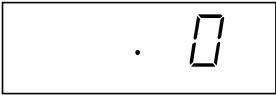

\* Suppose you want to cook for 2 minutes and 30 seconds at 50%.

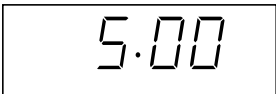
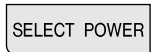
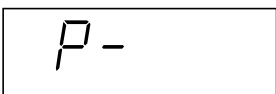
Step	Procedure	Pad Order	Display
1	Press the SELECT TIME pad.		
2	Enter desired cooking time. (2 minutes 30 seconds)	  	
3	Press the SELECT POWER pad.		
4	Enter desired power level. (50%)		
5	Press the START pad.		

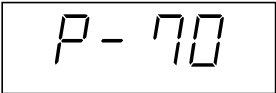
- Note:
1. It is not necessary to press the SELECT POWER pad for 100%.
  2. If the cooking time is over the max. time, the display will show "EE9". See page 14.
  3. During cooking mode, the oven stops when the door is opened, and the programme is cancelled if the START pad is not pressed within 1 minute after the door is closed.

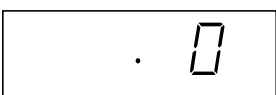
## Multiple Sequence Cooking

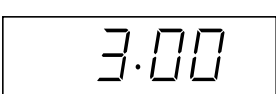
\* Suppose you want to cook for 5 minutes at 70% followed by 3 minutes at 100%

Step	Procedure	Pad Order	Display
1	Press the SELECT TIME pad.		
2	Enter desired cooking time for the 1st sequence.(5 minutes)		
3	Press the SELECT POWER pad.		
4	Enter desired power level for the 1st sequence.(70%)		
5	Press the SELECT TIME pad.		
6	Enter desired cooking time for the 2nd sequence.(3 minutes)		
7	Press the START pad.		





Note: If you want to programme 3 cooking sequences, repeat step 1-4 after step 6.

# OTHER CONVENIENT FEATURES

## Express Defrost

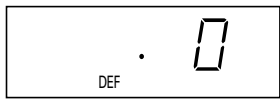
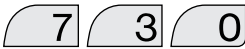
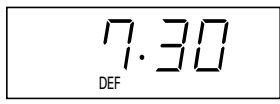
Use Express Defrost to defrost meat and poultry more rapidly. Enter desired defrost time, referring to express defrost chart.

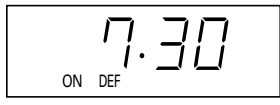
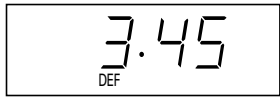
\* Suppose you want to defrost for 7 minutes and 30 seconds.

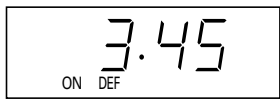
Step	Procedure	Pad Order	Display
1	Press the EXPRESS DEFROST pad.		
2	Enter desired defrost time.		
3	Press the START pad.		
4	Halfway through defrost time CHECK will flash and the oven will "beep" 4 times. Open the door. Turn food over and shield any warm portions. Close the door.		
5	Press the START pad within 1 minute after closing the door.		

Note: If you do not open the door when an audible signal sounds, the defrosting cycle will continue and the defrosting time will count down to 0.

## Express Defrost Chart

The following chart gives approx times per 500g for defrosting meat.

Food	Time(min./500g)	Procedure
Steak/Chops	6-8 min./500g	<ul style="list-style-type: none"> <li>* Shield thin end of chops or steaks with foil.</li> <li>* Position the food with thinner parts in the centre in a single layer on a defrost rack. If pieces are stuck together, try to separate as soon as possible.</li> <li>* The oven will beep 4 times. Turn food over.</li> <li>* After defrost time, stand covered with foil for 10-15 minutes.</li> </ul>
See Note below		
Poultry	7-9 min./500g	<ul style="list-style-type: none"> <li>* Remove from original wrapper. Shield wing and leg tips with foil.</li> <li>* Place breast side down on a defrost rack. The oven will beep 4 times. Turn food over.</li> <li>* After defrost time, stand covered with foil for 15-50 minutes.</li> <li>N.B. After standing rinse under cold water to remove giblets if necessary.</li> </ul>
Minced Beef	7-9 min./500g	<ul style="list-style-type: none"> <li>* Place frozen minced beef on a defrost rack. The oven will beep 4 times, remove defrosted portion of mince, turn food over and shield edges with foil strips.</li> <li>* After defrost time, stand covered with foil for 10-15 minutes.</li> </ul>
See Note below		
Chicken Pieces	6-8 min./500g	<ul style="list-style-type: none"> <li>* Shield the exposed bone with foil.</li> <li>* Place chicken pieces on a defrost rack.</li> <li>* The oven will beep 4 times. Turn food over and shield the warm portions.</li> <li>* After defrost time, stand covered with foil for 10-15 minutes.</li> </ul>
See Note below		
Roast Beef Pork Lamb	6-9 min./500g	<ul style="list-style-type: none"> <li>* Shield the edge with foil strips about 2.5 cm wide.</li> <li>* Place joint with lean side face upwards (if possible) on a defrost rack.</li> <li>* The oven will beep 4 times. Turn food over and shield the warm portions.</li> <li>* After defrost time, stand covered with foil for 10-50 minutes.</li> </ul>

Check food after standing. If additional time is needed, continue to defrost with 20% power and additional time.

Food not listed in the Chart can be defrosted using 20% setting.

Note: When freezing minced beef, shape it into flat even sizes. For chicken pieces, steaks and chops, freeze separately in single flat layers and if necessary interleave with freezer plastic to separate layers. This will ensure even defrosting. It is also a good idea to label the packs with the correct weights.



## Counter Check

The number of times when the oven will be used are automatically accumulated for each key. You can check how many times the oven was used.

Set the counters to "0" before using your new oven (see COUNTER CLEAR below) to keep a record of the oven use.

### COUNTER CHECK

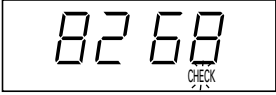
\* Suppose you want to know the total times the oven was used, and the number of times each programme was used. In the following example, the total time was 8268 and memory 1 was 513.

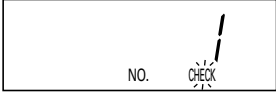
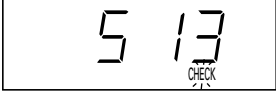
Step	Procedure	Pad Order	Display
1	To choose checking mode, press the CHECK pad twice.	 X 2	 CHECK will flash on and off. (Total times used)
2	To check the times of using the memory 1, press the NUMBER pad  .		 After about 1 sec.  (Times memory 1 was used)

Note: 1. To cancel Counter Check mode, press the CHECK pad.





2. Each counter can count the times up to 9999, and it will return to 0 if it is over 9999.

3. To check the times of manual cooking, press the SELECT TIME pad at Step 2 instead of the NUMBER pad.  
 To check the times of EXPRESS DEFROST cooking, press the EXPRESS DEFROST pad at Step 2 instead of the NUMBER pad.

### COUNTER CLEAR

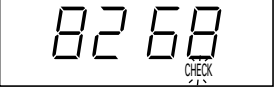
Each number of times can be cleared.

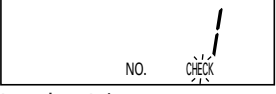
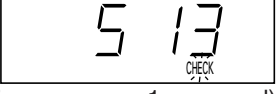
\* Suppose you want to clear the times of memory 1.

Step	Procedure	Pad Order	Display
1	Press the CHECK pad twice.	 X 2	 CHECK will flash on and off. (Total times used)
2	Press the NUMBER pad  .		 After about 1 sec.  (Times memory 1 was used)
3	Press the SET pad.		

Note: 1. To cancel Counter clear mode, press the CHECK pad.

2. To clear the times of manual cooking, press the SELECT TIME pad at Step 2 instead of the NUMBER pad.  
 To clear the times of EXPRESS DEFROST cooking, press the EXPRESS DEFROST pad at Step 2 instead of the NUMBER pad.

3. To clear total using times, skip Step 2.

## Demonstration Mode

To demonstrate, touch SELECT TIME, 0 and then touch START and hold for 3 seconds. **SH0** will appear in the display. Cooking operations can now be demonstrated with no power in the oven. The timer will count down rapidly.

To cancel, touch SELECT TIME, then 0 and STOP/ CLEAR.

## Error Mode

If ERROR message is displayed, follow the below instructions.

ERROR MESSAGE	
EE9	Cooking time exceeds the max. time. Press the STOP/CLEAR pad and programme again.

## CARE AND CLEANING

### IMPORTANT

- Disconnect the power supply cord before cleaning or leave the door open to inactivate the oven.
- Do not use commercial oven cleaners, abrasive or harsh cleaners or scouring pads on any part of your microwave oven.
- Do not sprinkle water onto the oven directly. It may cause electric shock, leakage of electricity or damage of the oven.
- The oven should not be cleaned with a water jet.

**CLEAN THE OVEN AT REGULAR INTERVALS** - Keep the oven clean, or it could lead to deterioration of the surface. This could adversely affect the life of the appliance and possibly result in a hazardous situation.

### Exterior:

The outside may be cleaned with mild soap and warm water, wipe clean with a damp cloth. Avoid the use of harsh abrasive cleaners.

**NOTE:** Please ensure the oven is not splashed with excessive water at all times as it could lead to an electrical failure.

### Door:

Wipe the door and window on both sides, the door seals and adjacent parts frequently with a damp cloth to remove any spills or splatters. Do not use abrasive cleaners.

### Touch Control Panel

Wipe the panel with a cloth dampened slightly with water only.

Do not scrub or use any sort of chemical cleaners. Avoid the use of excess water.

### Interior walls:

To clean the interior surfaces, wipe with a soft cloth and warm water at the end of each day for hygienic reasons. Built-up splashes may overheat and begin to smoke or catch fire. **DO NOT USE A COMMERCIAL OVEN CLEANER, ABRASIVE OR HARSH CLEANERS AND SCOURING PADS ON ANY PART OF YOUR MICROWAVE OVEN. NEVER SPRAY OVEN CLEANERS DIRECTLY ONTO ANY PART OF YOUR OVEN.**

Avoid using excess water. After cleaning the oven, ensure any water is removed with a soft cloth.

For heavier soil, use mild soap; wipe thoroughly with a soft cloth and warm water. Make sure that mild soap or water does not penetrate through the small vents in the walls which may cause damage to the oven.

### Ceramic shelf:

The ceramic shelf should be kept clean at all times. Minor spills may be wiped with a damp cloth. **DO NOT REMOVE THE CERAMIC SHELF FROM OVEN.**

# SERVICE CALL CHECK

Please check the following before calling for service:

1. When the door is opened, does the oven lamp come on? YES \_\_\_\_\_ NO \_\_\_\_\_
2. Place one cup of water (approx. 250 ml) in a glass measure in the oven and close the door securely. Programme the oven for 1 minute at 100%.



- A. Does the oven lamp light? YES \_\_\_\_\_ NO \_\_\_\_\_
- B. Does the cooling fan work? YES \_\_\_\_\_ NO \_\_\_\_\_  
(Put your hand over the rear ventilation openings.)
- C. After one minute, did an audible signal sound and heating indicator "ON" go off? YES \_\_\_\_\_ NO \_\_\_\_\_
- D. Is the water inside the oven hot? YES \_\_\_\_\_ NO \_\_\_\_\_

If "NO" is the answer to any of the above questions, please check your wall socket and the fuse in your meter box. If both the wall socket and the fuse are functioning properly, CONTACT YOUR NEAREST SERVICE CENTRE APPROVED BY SHARP.

## SPECIFICATIONS

AC Line Voltage:	Single phase 230-240 V, 50 Hz
AC Power Required:	1.55 kW
Output Power:	1000 W *(IEC test procedure)
Microwave Frequency:	2450 MHz (Class B/Group 2)**
Outside Dimensions:	520 mm(W) x 309 mm(H) x 406 mm(D)
Cooking Uniformity:	Stirrer fan system
Weight:	Approx. 17 kg

\* When tested in accordance with AS/NZS 2895.1.1995.

\*\* This is the classification of ISM (Industrial, Scientific and Medical) equipment described in the International Standard CISPR11.



# HELPFUL HINTS

## 1. THE ARRANGEMENT

Arrange foods carefully. Place thickest areas toward outside of dish.



## 3. COVERING

Cover foods in the microwave if you would normally cover the food in your ordinary oven, or to retain moisture. Cover foods such as Vegetables, Casseroles, or when Reheating.

Use to cover foods:



LID



PLASTIC WRAP

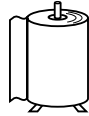

PAPER TOWEL

## 5. SHIELDING

Shield using small pieces of aluminium foil to shield thin areas of meat, fish and poultry or edges of cakes to prevent overcooking.



FISH



CHICKEN

## 7. STIRRING

Stir foods from the outside to the centre of the dish, once or twice during cooking if possible. Eg. Casseroles and Sauces.

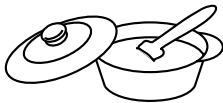

## 9. DENSITY

The depth to which microwaves penetrate food varies depending on the food's density. Porous foods like minced beef or mashed potatoes microwave faster than dense ones like steak or whole potatoes

## 11. STARTING TEMPERATURE

Frozen or refrigerated foods take longer to heat than food at room temperature. Cooking times in this book are based on normal storage temperatures. Since rooms, refrigerators and freezers differ in temperature, check cooking result at the minimum time.



## 13. CONDENSATION

Condensation is a normal part of microwave cooking. The humidity and moisture in food will influence the amount of condensation in the oven. Generally, covered foods will not cause as much condensation as uncovered foods. Ensure that the ventilation openings are not blocked.

## 2. TURNING

Foods such as poultry and joints of meat should be turned over after half the cooking time.

## 4. PIERCING

Pierce potatoes, eggs, tomatoes or any foods with a skin or membrane to allow steam to escape.



TOMATO



EGG

## 6. STANDING TIME

Standing time is important. After cooking or defrosting ensure adequate standing time. This allows the food to continue cooking or heating.

## 8. SIZE

Small pieces cook faster than large ones. To speed cooking, cut pieces smaller than 5 cm so microwaves can penetrate to the centre from all sides. For even cooking, make all the pieces the same size.

## 10. FAT AND BONE

Marbling within meat, or a thin, even layer of fat on a roast, speeds cooking. Large fatty areas or excess drippings in dish attract energy away from meat, and slows cooking. Centre bones do not affect cooking, but bone on the side of meat conducts heat to the areas next to it.







## 12. QUANTITY

Microwave cooking times are directly related to the amount of food in the oven. Because energy is absorbed by the food itself, one potato or a single piece of chicken cooks rapidly. When the energy is divided among several items, cooking takes more time.

## 14. GENERAL

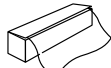
Your microwave oven is capable of heating food and beverages very quickly therefore, it is very important that you select the appropriate cooking time and power level for the type and quantity of food to be heated. If you are unsure of the cooking time and power level required, begin with low cooking times and power levels until the food is sufficiently heated evenly throughout.

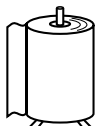
# COOKWARE AND UTENSIL GUIDE

Utensil	Use	Advice
GLASSWARE/ CERAMIC (HEAT RESISTANT) 	YES	<b>GLASSWARE</b> <ul style="list-style-type: none"> <li>• Ordinary glass is not suitable for cooking but may be used for short periods for heating foods.</li> </ul> <b>CERAMIC</b> <ul style="list-style-type: none"> <li>• Most ovenproof china, and ceramics, are suited.</li> <li>• Avoid dishes that are decorated with gold or silver leaf.</li> <li>• Avoid using antique pottery.</li> <li>• If unsure, check with the manufacturer.</li> </ul>
METAL COOKWARE 	NO	<ul style="list-style-type: none"> <li>• Metal cookware should be avoided when cooking in the microwave oven.</li> <li>• Microwave energy is reflected by metal.</li> </ul>
PLASTIC WRAP OVEN BAGS  ( MICROWAVE ) ( SAFE ONLY )	YES	<ul style="list-style-type: none"> <li>• Plastic wrap can be used to cover food.</li> <li>• Some shrinkage of the wrap may occur, over an extended cooking time.</li> <li>• When removing wrap, lift it in such a way to avoid steam burns.</li> <li>• Do not tie oven bags with metal twist ties, substitute with string.</li> <li>• For cooking food with high fat content, do not bring the wrap in contact with the food as it may melt.</li> </ul>
ALUMINIUM FOIL 	FOR SHIELDING	<ul style="list-style-type: none"> <li>• Small amounts may be used to shield certain parts of meat and fish when cooking or defrosting.</li> <li>• Remove food in foil trays, if possible, and place in a microwave safe dish.</li> <li>• If not possible, place the foil tray onto a heat proof plate allowing 2.5 cm room between the walls of the oven.</li> </ul>
STRAW AND WOOD 	NO	<ul style="list-style-type: none"> <li>• Excessive over heating of these materials may cause a fire in the microwave oven.</li> </ul>
PAPER 	YES	<ul style="list-style-type: none"> <li>• Paper towels and waxed paper are suitable to use to prevent splatters.</li> <li>• These are suitable for use when reheating foods or for short cooking times.</li> </ul>
PLASTIC COOKWARE MICROWAVE SAFE 	YES	<ul style="list-style-type: none"> <li>• Ideal for cooking, reheating and defrosting.</li> <li>• Some microwave safe plastic cookware are not suitable for cooking foods with high fat and sugar content.</li> </ul>
BROWNING DISH	YES	<ul style="list-style-type: none"> <li>• Ensure that the preheating time of the dish is not exceeded.</li> <li>• Ensure that a microwave heat proof dinner plate or suitable insulator be placed between the turntable and the browning dish.</li> </ul>
THERMOMETERS •MICROWAVE SAFE •CONVENTIONAL	YES NO	

# SHARP

## WARRANTY

### *Consumer Electronic Products*

#### **Congratulations on Your Purchase!**

This Sharp product is warranted against faults in material and manufacture for the period as stated in the table below.

If service is required during the warranty period, please contact your nearest Sharp Approved Service Centre. These repairs would be carried out at no charge to the owner, subject to the conditions specified herein.

This warranty does not extend to defects or injuries caused by or resulting from causes not attributable to faulty parts or the manufacture of the product, including but not limited to, defect or injury caused by or resulting from misuse, abuse, neglect, lack of maintenance, accidental damage, improper voltage, liquid spillage, vermin infestation, software, or any alterations made to the product which are not authorised by Sharp.

Please retain your sales documentation, as this should be produced to validate a warranty claim. This warranty is in addition to and in no way limits, varies or excludes any implied rights and remedies under any relevant legislation in the country of sale.

This warranty does not cover transportation to and from the Sharp Approved Service Centre. Goods presented for repair may be replaced by refurbished goods of the same type rather than being repaired. Refurbished parts may be used to repair the goods. The repair of your goods may result in the loss of user generated data, please ensure that you have saved this data elsewhere prior to repair.

Australian customers: Our goods come with guarantees that cannot be excluded under the Australian Consumer Law. You are entitled to a replacement or refund for a major failure and for compensation for any other reasonably foreseeable loss or damage. You are also entitled to have the goods repaired or replaced if the goods fail to be of acceptable quality and the failure does not amount to a major failure. The criteria of a major failure is defined in the Australian Consumer Law. Should you require any assistance with a major failure please contact Sharp Customer Care.

#### **WARRANTY PERIODS**

Home Theatre Projector	12 months	(excluding lamps and air filters)
Audio/Home Theatre	12 months	
Microwave / Steam Oven	12 months	
Slow Juicer	12 months	
Refrigerator	24 months	
DVD/Blu-ray	12 months	
Washing Machine	24 months	
Portable Air Conditioner	12 months	
LCD Television	12 months	
Air Purifier	12 months	
Vacuum Cleaner	24 months	

**SHARP**  
SHARP CORPORATION OF  
AUSTRALIA PTY. LIMITED  
A/BV 40 003 039 405  
1 Huntingwood Drive  
Huntingwood NSW 2148  
SHARP CORPORATION OF  
NEW ZEALAND LIMITED  
59 Hugo Johnston Drive  
Penrose, Auckland

SPform 040 (SEPT 2013)

**IMPORTANT NOTICE: This warranty applies only to products sold in Australia & New Zealand**

**SHARP®**

FOR LOCATION ENQUIRIES WITHIN

**AUSTRALIA**

REGARDING YOUR LOCAL

SHARP APPROVED SERVICE CENTRE

VISIT OUR WEBSITE AT

**[www.sharp.net.au](http://www.sharp.net.au)**

OR CALL SHARP CUSTOMER CARE

**1300 135 022**

(LOCAL CALL COSTS APPLY WITHIN AUSTRALIA)

SHARP CORPORATION OF AUSTRALIA PTY LTD

**SHARP®**

FOR LOCATION ENQUIRIES WITHIN

**NEW ZEALAND**

REGARDING YOUR LOCAL

SHARP APPROVED SERVICE CENTRE

VISIT OUR WEBSITE AT

**[www.sharp.net.nz](http://www.sharp.net.nz)**

CONTACT YOUR SELLING DEALER/RETAILER

OR CALL











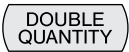





















**SHARP CUSTOMER SERVICES**

TELEPHONE: 09 573 0111

FACSIMILE: 09 573 0113

SHARP CORPORATION OF NEW ZEALAND LIMITED

# QUICK REFERENCE GUIDE

FEATURE	QUICK OPERATION GUIDE	
Cooking with memory.	Memory Number  – Just one touch	* To cook by using memory 11-20, press the desired NUMBER pad twice within 1 second.
Cooking double quantity with memory.	 → 	* To cook by using memory 11-20, press the desired NUMBER pad twice within 1 second.
Memory programme entry.	To enter 4 minutes 60% for 1 serving in the memory 1.	
	Memory Number  →  →  →    → <small>x 2 Within 2 sec.</small>	Cooking Time
	 →  →  <small>x 2</small>	Power Level
Variable cooking control	To cook for 2 minutes 30 seconds at 50%.	
	 →    →  →  → 	Cooking Time Power Level
Express Defrost	To defrost 500g of steak for 3 minutes 30 seconds.	
	 →    → 	Defrost Time
Memory check	To check the programme memorised in memory 1.	
	 →  → 	Memory Number To cancel memory check mode.
Counter check	To check the total times used and the times memory 1 was used.	
	 →  →  <small>x 2</small> (Total times used) (Times memory 1 was used)	Memory Number To cancel counter check mode.
Counter clear	To clear the times of memory 1.	
	 →  →  →  <small>x 2</small>	Memory Number To cancel counter clear mode.

# SHARP

SHARP CORPORATION Osaka Japan

TINSEB030 WRRZ-J31  
Printed in Thailand