

**SPECIFICATION, INSTALLATION
AND OPERATION MANUAL**
READ ALL INSTRUCTIONS BEFORE USE

Woodson Induction



Models:

WI.HBCT.1.2400 / WI.HBCT.1.3500 / WI.HBCT.1L.3500 / WI.WKCT.1.3500

A guide on the use, care and maintenance
of your quality Woodson product

Page Intentionally Left Blank

Introduction

Your New Woodson Product 3

Introduction

Australia and New Zealand Warranty 4
Warranty Period
Warranty Registration
 General Precautions 4
 Product Overview. 5

Installation

Setting Up 6
Handling
Unpacking
Positioning
Disposal
 Electrical Connection 7
Information

Specification

General Drawing 8
WI.HBCT.1.2400
WI.HBCT.1.3500
WI.WKCT.1.3500

Operation

Initial Start-up & Operation 10
Power On
Power Level
Temperature:
Timer:

Cleaning and Maintenance

Cleaning 11
General Information
Corrosion Protection
Surface Finish
Cleaning Schedule
Materials Required
Cleaning Procedure
Ventilation Panels
 Troubleshooting 13

Your New Woodson Product

Thank you for choosing this quality Woodson product.

All Woodson products are designed and manufactured to meet the needs of food service professionals. By caring for and maintaining your new Woodson product in accordance with these instructions, will provide many years of reliable service.

Stoddart is a wholly Australian owned company, which manufactures and/or distributes a comprehensive range of food service equipment for kitchens, food preparation and presentation. Stoddart products are manufactured and/or engineered in Australia to provide excellent results whilst offering value-for-money, ease-of-use and reliability.

**Carefully read this instruction booklet, as it contains important advice for safe installation, operation and maintenance.
Keep this booklet on hand in a safe place for future reference by other operators or users.**

Disclaimer

The manufacturer and distributor cannot be held responsible or liable for any injuries or damages of any kind occurred to persons, units or others, due to abuse and misuse of this unit in regards to installation, removal, operation, servicing or maintenance, or lack of conformity with the instructions indicated in this documentation.

All units made by the manufacturer are delivered assembled, where possible, and ready to install. Any installation, removal, servicing, maintenance and access or removal of any parts, panels or safety barriers that is not permitted, does not comply in accordance to this documentation, or not performed by a **TRAINED AND AUTHORISED SPECIALIST** will result in the **IMMEDIATE LOSS OF THE WARRANTY.**

The manufacturer cannot be held responsible or liable for any unauthorised modifications or repairs. All modifications or repairs must be approved by the manufacturer in writing before initiating. All modifications or repairs performed to this unit must be performed at all times by a **TRAINED AND AUTHORISED SPECIALIST.**

**Stoddart design, manufacture & distribute Food Service Equipment (appliances) exclusively for the commercial market.
This appliance is not designed nor intended for household or domestic use & must not be used for this purpose.**

This product is intended for commercial use, and in line with Australian electrical safety standards the following warnings are provided:

- This product is not intended for use by persons (including children) with reduced physical, sensory or mental capabilities, or lack of experience and knowledge, unless they have been given supervision or instruction concerning the use of the product by a person responsible for their safety. Children should be supervised to ensure that they do not play with the product
- If the supply cord is damaged, it must be replaced by the manufacturer, its service agent or similarly qualified persons in order to avoid a hazard



Warranty & Registration

Australia and New Zealand Warranty

Warranty Period

Stoddart 12 month on-site parts and labour warranty (terms and conditions apply), from the time of purchase.

To view or download the warranty terms and conditions visit: <http://www.stoddart.com.au/warranty-information>

Warranty Registration

To register your new product, go to the Stoddart warranty page: <http://www.stoddart.com.au/warranty-registration>



General Precautions

When using any electrical unit, safety precautions must always be observed.

Our units have been designed for high performance. Therefore, the unit must be used exclusively for the purpose for which it has been designed.

- All units **MUST** be installed according to the procedures stated in the installation section of this manual
- In the case of new personnel, training is to be provided before operating the equipment
- **DO NOT** use this unit for any other purpose than its intended use
- **DO NOT** store explosive substances such as aerosol cans with a flammable propellant in or near this unit
- Magnetic objects (credit cards, calculators, etc.) should not be placed near the cooktop when in use
- **DO NOT** place any metallic objects except for induction Pots/Pans on the glass surface. In case of untimely activation or residual heat, they may heat, melt or even burn
- If objects or cookware fall on the glass, the surface can be damaged
- Cookware made of cast iron, cast aluminium or with damaged bottoms can scratch the surface of the glass
- **DO NOT** let pots/pans boil dry, to prevent the damage to cookware and glass
- **DO NOT** use the cooking zones with empty pots/pans
- **DO NOT** put aluminium foil on the unit
- Unit is not waterproof **DO NOT** use jet sprays, hoses or pour water over/on the exterior of the unit
- Only use this unit with voltage specified on the rating label
- **DO NOT** remove any cover panels that may be on the unit
- **DO NOT** use sharp objects to activate controls
- If any fault is detected, refer to troubleshooting
- The manufacturer declines any liability for damages to persons and/or things due to an improper/wrong and/or unreasonable use of the machine
- Only specifically trained/qualified Technicians (Stoddart, one of our service agents, or a similarly qualified persons) should carry out any and all repairs, maintenance and services

Product Overview

	CAUTION
	Surface is Hot

	CAUTION
	Do not leave unattended when cooking with oil. Fats and oils can become hot very quickly with ignition

	IMPORTANT
	Persons with an implanted pacemaker must keep their upper body a minimum of 30cm from induction cooking zones that are activated.



Setting Up

	WARNING
	<p>Improper installation, adjustments, alterations, service or maintenance can cause property damage, injury or death.</p>

Handling

- Use suitable means to move the unit;
 - For smaller items use two people
 - For large items a fork lift, pallet trolley or similar (the forks should reach completely beneath the pallet)

Unpacking

- Check the unit for damage before and after unpacking. If unit is damaged, contact the distributor and manufacturer
- Should any item have physical damage, report the details to the freight company and to the agent responsible for the dispatch within seven (7) days of receipt. No claims will be accepted or processed after this period
- The unit is supplied fully assembled
- Remove all protective plastic film, tapes, ties and packers before installing and operating
- Clean off any remaining residue from the interior/exterior of the unit using a clean cloth dampened with warm soapy water

Positioning

- Choose an area that is well ventilated and provides access for future maintenance
- Place the unit on a level stable work surface capable of supporting its weight
- Do not position the unit in:
 - Wet areas
 - Near heat and/or steam sources
 - Near flammable substances
- Allow an air gap between the unit and other objects or surfaces. A minimum gap of 100mm from all sides is recommend for normal operational use (if the unit is near any heat sensitive material we suggest you allow additional space)

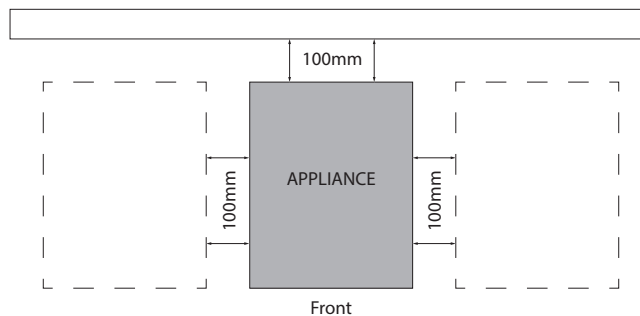

- Please consult national and local standards to ensure that your unit is positioned in accordance with any existing requirement

Disposal

- At the end of the appliance's working life, make sure it is scrapped & components recycled properly
- Current environmental protection laws in the state/country of use must be observed
- Doors must be removed before disposal (if applicable)
- Power supply cable must be removed before disposal
- For further information on the recycling of this product, contact the local dealer/agent or the local body responsible for waste disposal

Electrical Connection

Information

	WARNING
	<p>This unit must be installed in accordance with AS/NZS 60335.1</p> <p>Some procedures in this manual require the power to the equipment to be turned off and isolated. Turn the power OFF at the power point and unplug the power supply lead by the plug body. If the power point is not readily accessible turn the equipment off at the isolation switch or the circuit breaker in the switchboard. Attach a yellow “CAUTION-DO NOT OPERATE” tag. This must be performed where relevant unless the procedures specify otherwise.</p> <p>FAILURE TO DO SO MAY RESULT IN ELECTRIC SHOCK.</p>

Single Phase Units:

- Supplied and fitted with an appropriately rated plug and lead, indicated as:
 - 10A plug & lead fitted
 - 15A plug & lead fitted

Notes:

- If the supply cord is damaged, it must be replaced by the manufacturer, its service agent or similarly qualified persons in order to avoid a hazard. Please contact Stoddart for parts and we will advise how to do this in order to avoid any electrical hazard
- The power cable should be dry and/or isolated from moisture or water

General Drawing

WI.HBCT.1.2400

Specifications

Model	WI.HBCT.1.2400
Height	122mm
Width	340mm
Depth	440mm
Power	2.4kW / 10A plug & lead fitted
Pan Size	Min - Ø120mm Max - Ø260mm

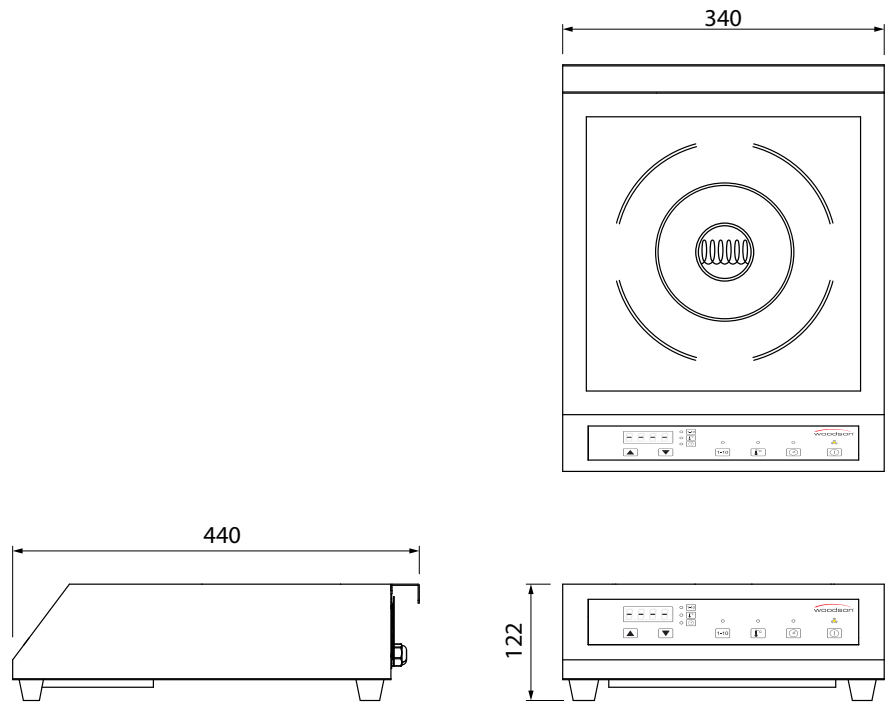

WI.HBCT.1.3500

Specifications

Model	WI.HBCT.1.3500
Height	122mm
Width	340mm
Depth	440mm
Power	3.5kW / 15A plug & lead fitted
Pan Size	Min - Ø120mm Max - Ø260mm

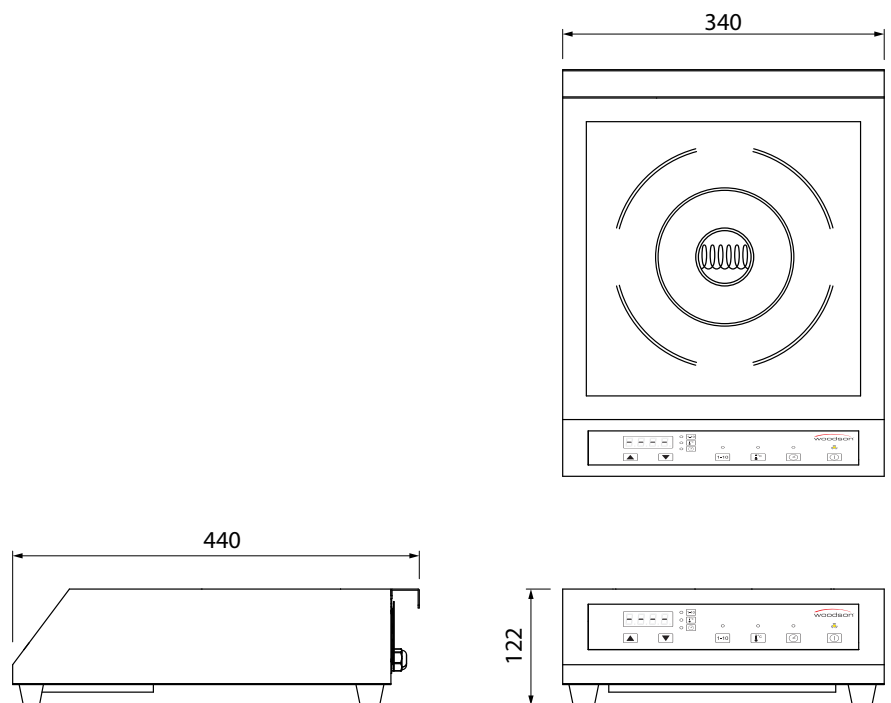

Due to continuous product research and development, the information contained herein is subject to change without notice.

WI.HBCT.1L.3500

Specifications

Model	WI.HBCT.1L.3500
Height	122mm
Width	440mm
Depth	540mm
Power	3.5kW / 15A plug & lead fitted
Pan Size	Min - Ø120mm Max - Ø360mm

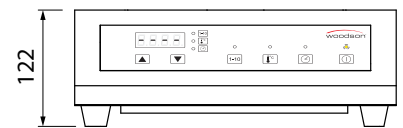
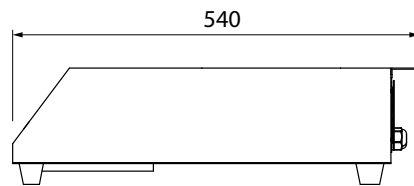
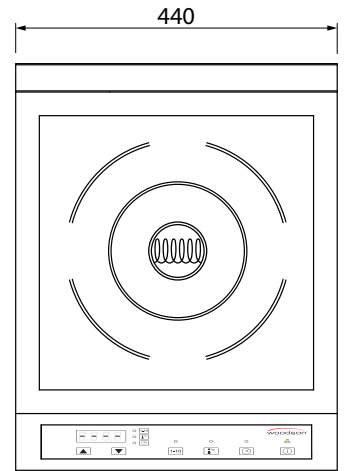

WI.WKCT.1.3500

Specifications

Model	WI.WKCT.1.3500
Height	126mm
Width	340mm
Depth	440mm
Power	3.5kW / 15A plug & lead fitted
Wok Size	Suits Woodson 14" induction wok: WI.WKPN

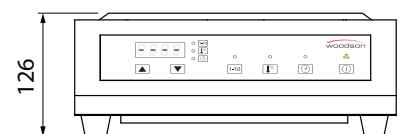
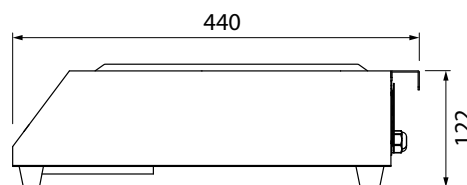
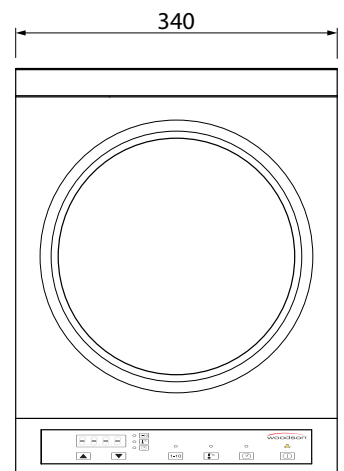

Initial Start-up & Operation

Power On

Press the Power On button. The unit will turn on and automatically go into standby mode. If a pan/pot has not been placed onto the unit, the unit will turn off after four minutes.

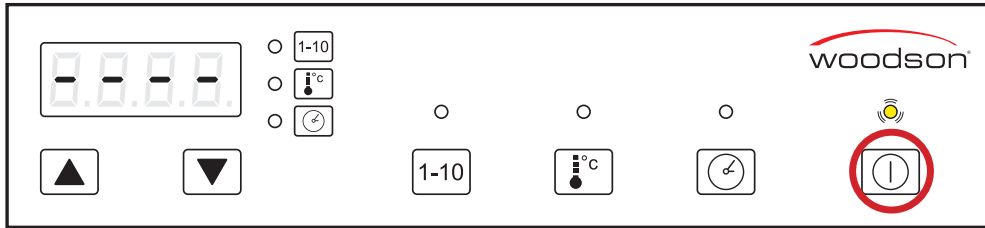

Power Level

Press the Power Level button. The power level can be set from 1-10 (1=LO, 10=HI), use the navigation buttons to adjust the power level. When a power level has been selected the unit display will flash the selected power level and the word "ON" while emitting an audible beep, this will happen until a pan/pot has been placed on the unit.

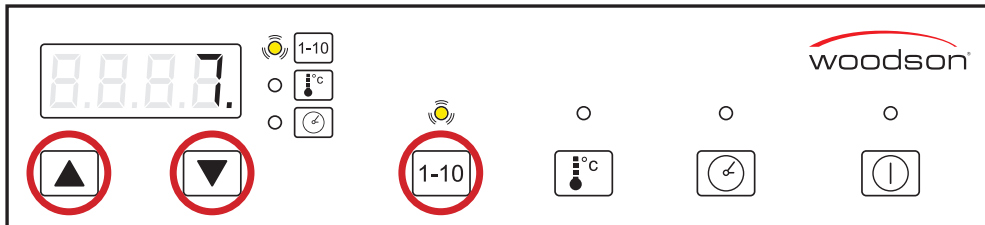

Temperature:

Press the Temperature button. The temperature can be set from 60-240°C (temperature increases in 20° increments), use the navigation buttons to adjust the temperature.

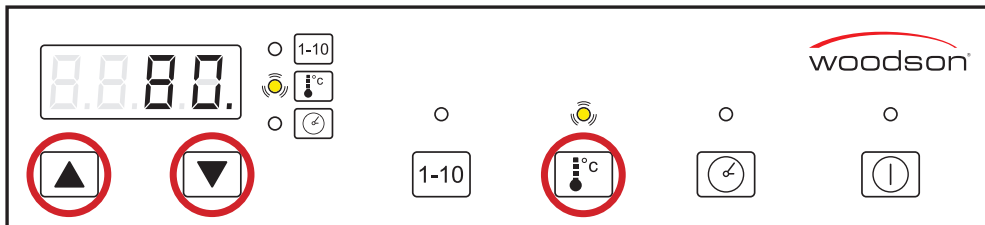

Timer:

Press the Timer button. The timer can be set from 1-180 minutes, use the navigation buttons to adjust the temperature. At the end of a timer cycle the unit will emit an audible beep then go into standby mode.

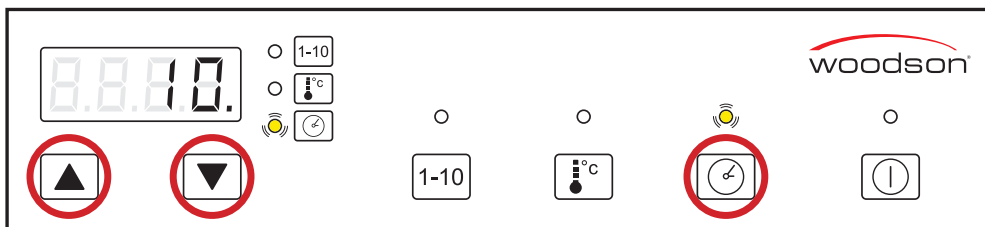

Note: After 4 hours of continuous use the unit will automatically switch off to prevent overheating.

Cleaning

General Information





- Cleaning is recommended for health and safety purposes and to prolong the life of the unit
- **DO NOT** use abrasive pads or cleaners on the stainless steel or any other metal parts of the unit
- **DO NOT** use industrial chemical cleaners, flammable cleaners, caustic based cleaners or bleaches and bleaching agents, as many will damage the metals and plastics used on this unit
- **DO NOT** remove any screws and/or panels for cleaning (unless directed)
- This unit is **NOT** waterproof, **DO NOT** hose, **DO NOT** pour water directly onto the unit, **DO NOT** immerse in water

Corrosion Protection

- Stainless steel exhibits good resistance to corrosion however, if not properly maintained stainless steel can rust and/or corrode
- Any sign of mild rust and/or corrosion should be thoroughly cleaned with warm soapy water and dried as soon as possible
- NEVER use abrasive pads or cleaners for cleaning
- All metal surfaces should be checked while cleaning for damage, scuffs or scrapes as these can lead to rust and further damage to the product
- Mild rust and/or corrosion can be treated with a commercial cleaning agent that contains citric/oxalic/nitric/phosphoric acid. **DO NOT** use cleaning agents with chlorides or other harsh chemicals as this can cause corrosion. After treatment, wash with warm (not hot) soapy water and dry thoroughly
- Thoroughly wipe the surfaces dry after cleaning. **DO NOT** let water pool on the unit. Check crevices and folds for pooling
- When using, ensure all liquids and moisture is cleaned up straight away. Food liquids such as juices from vegetables and fruits should not be left on preparation surfaces
- **DO NOT** leave items on the stainless steel such as cutting boards, rubber mats and bottles

Surface Finish

- To protect the polished surface of the stainless steel, it should be dried using a clean dry soft cloth. A light oil can be applied to enhance the stainless steel surface, using a clean cloth apply the oil in the same direction as grained polished finish
- Some commercial stainless steel cleaners can leave residue or film on the metal; this may trap fine particles of food on the surface, thus deeming the surfaces not food safe

	<p style="text-align: center;">IMPORTANT</p> <p>Threaded fasteners can loosen in service. Regular inspection and adjustment should be carried out as required</p>		<p style="text-align: center;">WARNING</p> <p>This unit is NOT waterproof, do NOT hose. DO NOT pour water directly onto the unit. DO NOT immerse in water</p>
	<p style="text-align: center;">IMPORTANT</p> <p>Some commercial stainless steel cleaners leave residue or film on the metal that may entrap fine particles of food, deeming the surface not FOOD SAFE</p>		<p style="text-align: center;">WARNING</p> <p>Wait until the unit has cooled to a safe temperature before undertaking any cleaning or maintenance. Contact with hot surfaces can cause burns and serious injury</p>

Cleaning Schedule

- Daily cleaning is required for the unit. This will help to maintain and prolong the efficiency of your unit
- The unit should be cleaned at the end of each work day

Materials Required

- Stainless Cleaner
- Non Abrasive Cleaning pad
- Clean Sanitised Cloth
- Paper Towel
- Container of warm water
- Appropriate PPE (Personal Protective Equipment)

Cleaning Procedure

1. Isolate the unit from the power supply
2. Using a good quality nylon brush remove crumbs and small food items
3. Wipe clean using a cloth dampened (not wet) with clean warm water until all soil has been removed
4. Using a clean sanitised cloth, thoroughly wipe the stainless steel and metal parts dry. Do NOT let water pool on the unit. Check crevices and folds

Ventilation Panels

1. Use a vacuum to remove dust and debris from all ventilation panels
2. Do NOT use water to remove dust or debris

Troubleshooting

- If any faults/issues occur with the unit, follow the below troubleshooting procedures
- If the troubleshooting procedures do not correct the problem, contact the Stoddart Service Department

	WARNING
	Technician tasks are only to be completed by qualified service people. Check faults before calling service technician.

Problem	Possible Causes	Possible Corrective Action
Unit won't turn on	Unit is not plugged into a suitable power point	Plug unit in
	Power switch is in the "Off" position	Change the power switch to the "ON" position
	Power Point is faulty	Arrange a qualified electrician to repair the power point
Unit is not heating / over heating	Induction hob not working	Contact the Stoddart Service Department at 1300 307 289.
	Temp switch / Computer board not working	Contact the Stoddart Service Department at 1300 307 289.

Error Code	Possible Causes
E0	Unsuitable pans/woks
E1	Fan failure Bad hob ventilation Abnormal temperature
E2	Temperature sensor failure
E3	Abnormal supply voltage

Australia

Service / Spare Parts

Tel: 1300 307 289

Email: service@stoddart.com.au

Email: spares@stoddart.com.au



Service Request

www.stoddart.com.au

Australian Business Number: 16009690251

Sales

Tel: 1300 79 1954

Email: sales@stoddart.com.au

New Zealand

Service / Spare Parts

Tel: 0800 935 714

Email: service@stoddart.co.nz

Email: spares@stoddart.co.nz



Service Request

www.stoddart.co.nz

New Zealand Business Number: 6837694

Sales

Tel: 0800 79 1954

Email: sales@stoddart.co.nz

International

Service / Spare Parts

Tel: +617 3440 7600

Email: service@stoddart.com.au

Email: spares@stoddart.com.au



Service Request

www.stoddart.com.au

Sales

Tel: +617 3440 7600

Email: sales@stoddart.com.au