

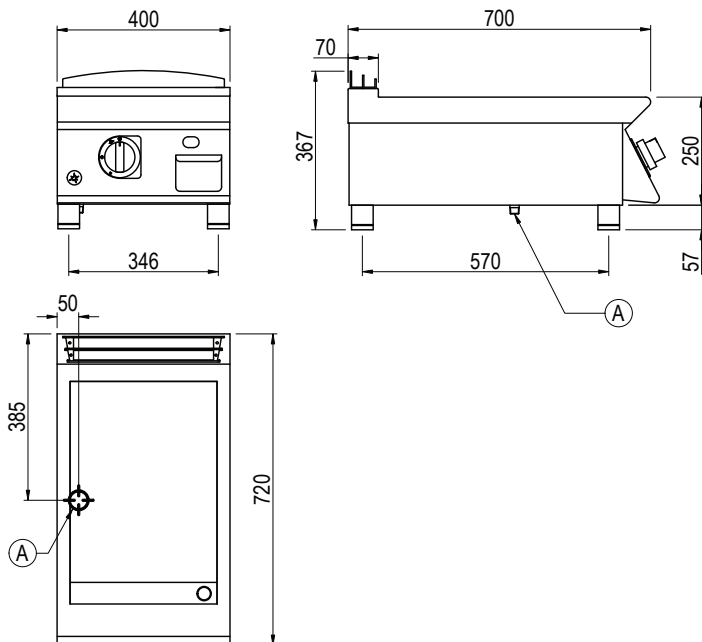

Product Information:

- Class leading, European style, professional quality and reliability since 1963
- 700 series, gas frytop with 12mm smooth mild steel plate (25 MJ/h) (also available in 12mm ribbed mild steel plate)
- Piezo ignition burners with flame failure device and pilot burner
- Temperature regulation via variable power flame control
- Robust 304 grade stainless steel construction with rounded corners for improved cleaning
- Hermetically sealed, pressed work surface with raised edges to protect from overflow
- Removable grease tray
- 24-month warranty

General Drawing:



Specifications:

Model - Smooth	FLG72TFT	
Model - Ribbed	FRG72TFT	
W x D x H (mm)	400 x 720 x 367	
Weight	50kg	
Cooktop (mm)	340 x 460	
Packed Dimensions (mm)	450 x 825 x 570	
Packed Weight (mm)	55kg	
	Natural	Universal LPG
Gas Connection	1/2" BSP	1/2" BSP
Minimum Normal Test Gas Pressure	1.3 kPa	2.75 kPa
Maximum Normal Test Gas Pressure	3.5 kPa	3.5 kPa
Nominal Test Point Pressure	1.0 kPa	2.65 kPa
Total Nominal Gas Consumption	25 MJ/h	25 MJ/h

Note: It is the responsibility of the installing gas plumber to ensure correct supply and connection sustaining appropriate pressure, when all installed gas appliances are operating at maximum.

Legend:

A Gas Connection