

**INSTALLATION  
AND OPERATION MANUAL**  
**READ ALL INSTRUCTIONS BEFORE USE**

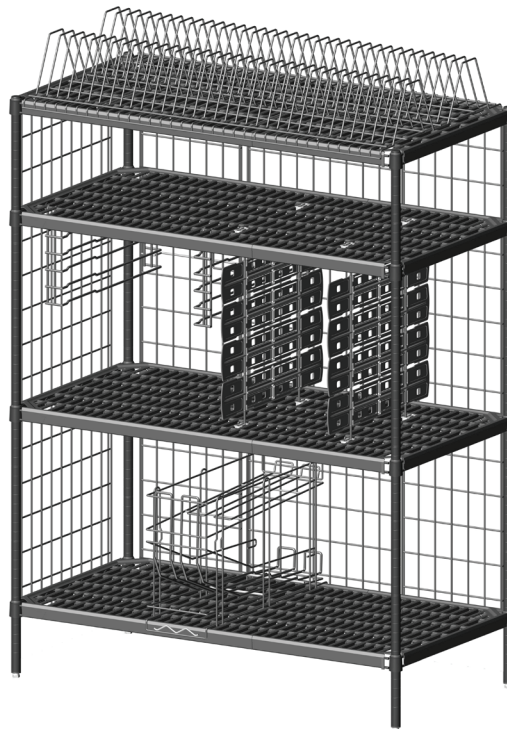

**Models:**  
Metro Pro Series



**Page Intentionally Left Blank**



Due to continuous product research and development,  
the information contained herein is subject to change without notice.

[www.stoddart.com.au](http://www.stoddart.com.au)

[www.stoddart.co.nz](http://www.stoddart.co.nz)



## 1.0 Introduction

1.1 Your New Metro Product . . . . .	3
1.2 Australia and New Zealand Warranty . . . . .	4
1.2.1 Warranty Period	
1.2.2 Warranty Registration	
1.3 General Precautions . . . . .	4

## 2.0 Installation

2.1 Product Overview. . . . .	5
2.2 Setting Up . . . . .	6
2.2.1 Handling	
2.2.2 Unpacking	
2.2.3 Positioning	

## 3.0 Assembly

3.1 Super Erecta Pro Series . . . . .	7
---------------------------------------	---

## 4.0 Cleaning and Maintenance

4.1 Metro Pro Series / MaxQ . . . . .	13
4.2 Disposal . . . . .	13
5.0 Troubleshooting . . . . .	14
5.1.1 Troubleshooting Procedures	

Due to continuous product research and development,  
the information contained herein is subject to change without notice.

[www.stoddart.com.au](http://www.stoddart.com.au)

[www.stoddart.co.nz](http://www.stoddart.co.nz)



## 1.1 Your New Metro Product

Thank you for choosing this quality Metro product.

All Metro products are designed and manufactured to meet the needs of food service professionals. By caring for and maintaining this new Metro product in accordance with these instructions, will provide many years of reliable service.

Stoddart is a wholly Australian owned company, which manufactures and/or distributes a comprehensive range of food service equipment for kitchens, food preparation and presentation. Stoddart products are manufactured and engineered to provide excellent results whilst offering value-for-money, ease-of-use and reliability.

---

**Carefully read this instruction booklet, as it contains important advice for safe installation, operation and maintenance. Keep this booklet on hand in a safe place for future reference by other operators or users.**

### Disclaimer

The manufacturer/distributor cannot be held responsible or liable for any injuries or damages of any kind that occur to persons, units or others, due to abuse and misuse of this unit in regards to installation, removal, operation, servicing or maintenance, or lack of conformity with the instructions indicated in this documentation.

All units made by the manufacturer/distributor are delivered assembled, where possible, and ready to install. Any installation, removal, servicing, maintenance and access or removal of any parts, panels or safety barriers that is not permitted, does not comply in accordance to this documentation, or not performed by a **TRAINED AND AUTHORISED SPECIALIST** will result in the **IMMEDIATE LOSS OF THE WARRANTY.**

The manufacturer/distributor cannot be held responsible or liable for any unauthorised modifications or repairs. All modifications or repairs must be approved by the manufacturer/distributor in writing before initiating. All modifications or repairs performed to this unit must be performed at all times by a **TRAINED AND AUTHORISED SPECIALIST.**

**Stoddart design, manufacture & distribute Food Service Equipment (appliances) exclusively for the commercial market.  
This appliance is not designed nor intended for household or domestic use and must not be used for this purpose.**

This product is intended for commercial use, and in line with Australian electrical safety standards the following warnings are provided:

- This product is not intended for use by persons (including children) with reduced physical, sensory or mental capabilities, or lack of experience and knowledge, unless they have been given supervision or instruction concerning the use of the product by a person responsible for their safety. Children should be supervised to ensure that they do not play with the product
- If the supply cord is damaged, it must be replaced by the manufacturer, its service agent or similarly qualified persons in order to avoid a hazard



## Warranty & Registration

### 1.2 Australia and New Zealand Warranty

#### 1.2.1 Warranty Period

All Stoddart manufactured and distributed products are covered by Stoddart's standard Australia and New Zealand Product Warranty (minimum 12 month on-site parts and labour, terms and conditions apply). Further to this standard warranty, certain products have access to an extended warranty. Full terms, conditions and exclusions can be found using the below Link/QR code.

#### 1.2.2 Warranty Registration

To register your new product, Follow the below Link/QR code.

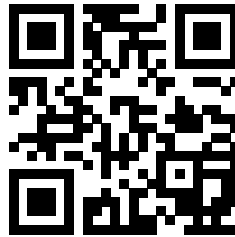

[www.stoddart.com.au/warranty-information](http://www.stoddart.com.au/warranty-information)

### 1.3 General Precautions

When using any electrical unit, safety precautions must always be observed.



Our units have been designed for high performance. Therefore, the unit must be used exclusively for the purpose for which it has been designed.

- All units **MUST** be installed according to the procedures stated in the installation section of this manual
- In the case of new personnel, training is to be provided before operating the equipment
- **DO NOT** use this unit for any other purpose than its intended use
- **DO NOT** store explosive substances such as aerosol cans with a flammable propellant in or near this unit
- Keep fingers out of "pinch point" areas
- Unit is not waterproof **DO NOT** use jet sprays, hoses or pour water over/on the exterior of the unit
- Only use this unit with voltage specified on the rating label
- **DO NOT** remove any cover panels that may be on the unit
- **DO NOT** use sharp objects to activate controls
- If any fault is detected, refer to troubleshooting
- The manufacturer declines any liability for damages to persons and/or things due to an improper/wrong and/or unreasonable use of the machine
- Only specifically trained/qualified Technicians (Stoddart, one of our service agents, or a similarly qualified persons) should carry out any and all repairs, maintenance and services

2.1 Product Overview

	<b>WARNING - TIPPING HAZARD</b>
	<ul style="list-style-type: none"> <li>• Do not stand or climb on shelving.</li> <li>• Place heavy objects on lowest shelf.</li> <li>• Distribute weight as evenly as possible.</li> <li>• Do not drop heavy objects on shelves or subject units to shock such as forklifts or dollies.</li> <li>• Move mobile units along long axis only. 203mm diameter casters should not be used on units less than 533mm wide.</li> <li>• Strictly follow weight capacity guidelines below</li> <li>• Stem Caster Units: Bottom shelf must be installed no higher than groove #5.</li> <li>• <b>Truck Dolly Units:</b> The bottom shelf <b>MUST</b> be on groove #5</li> <li>• <b>Stationary Units:</b> The bottom shelf must be as low as possible (NSF requires that the lowest shelf be at least 152mm above the floor).</li> <li>• Use with non-InterMetro parts and components could result in personal injury or property damage and may void warranty.</li> </ul> <p><b>Failure to follow these instructions could result in personal injury or property damage.</b></p>

	<b>IMPORTANT</b>
	<p>Notice: Regularly inspect the product. Tighten loose fasteners and replace worn or damaged parts with new InterMetro approved parts. For mobile units, replace worn or damaged casters immediately; lubricate casters regularly.</p> <p>Units over 1270mm high must be assembled with at least three shelves, and preferably four or more.</p> <p>Place shelving on solid and level floors.</p> <p>Level the unit by adjusting the leveling feet.</p> <p>Install bottom shelf as low as possible. NSF requires that the lowest shelf be at least 152mm above the floor.</p> <p>Super Erecta Pro shelves and posts are designed to be used with standard Metro Super Erecta shelves when assembling a given unit.</p>

	<b>CAUTION - WEIGHT CAPACITY</b>
	<p>Shelves 610mm up to 1220mm in length = 360 kg maximum equally distributed.</p> <p>Shelves longer than 1220mm = 270 kg maximum equally distributed.</p> <p><b>NEVER</b> exceed 900 kg on any Storage System.</p> <p><b>NEVER</b> exceed 450 kg or three times the caster load rating (whichever is less) on any Storage System.</p> <p>Distribute weight as evenly as possible. See this symbol for specific weight capacities:</p> <div style="text-align: right;">  </div>

### 2.2 Setting Up

#### 2.2.1 Handling

- Use suitable means to move the unit;
  - For smaller items use two people
  - For large items a fork lift, pallet trolley or similar (the forks should reach completely beneath the pallet)

#### 2.2.2 Unpacking

- Check the unit for damage before and after unpacking. If unit is damaged, contact the distributor and manufacturer
- Should any item have physical damage, report the details to the freight company and to the agent responsible for the dispatch within seven (7) days of receipt. No claims will be accepted or processed after this period
- The unit is supplied flat packed and will require assembly.
- Remove all protective plastic film, tapes, ties and packers before installing and operating
- Remove shelf transport springs and zipties
- Clean off any remaining residue from the unit using a clean cloth dampened with warm soapy water

#### 2.2.3 Positioning

##### Super Erecta Pro Stability Guide

###### Stationary Units (Free-standing without footplates or wall brackets)

Shelf Depth	Maximum Allowable Post Height
356mm	1600mm (63")
457 mm	2184mm (86")
533 mm	2184mm (86")
610 mm	2438mm (96")

\*For all stationary units with footplates or wall brackets properly attached to the floor or wall, the maximum allowable post height is 2438mm.

###### Mobile Units with Stem Casters

Shelf Depth	Maximum Allowable Post Height
356mm	1372mm (54")
457 mm	1880mm (74")
533 mm	1880mm (74")
610 mm	2184mm (86")

###### Mobile Units with Dolly Platforms

Shelf / Dolly Depth	Maximum Allowable Post Height	
	127mm & 153mm Casters	203mm Casters
457 mm	1660mm (63")	N/A
533 mm	1880mm (74")	1600mm (63")
610 mm	2184mm (86")	1880mm (74")

3.1 Super Erecta Pro Series

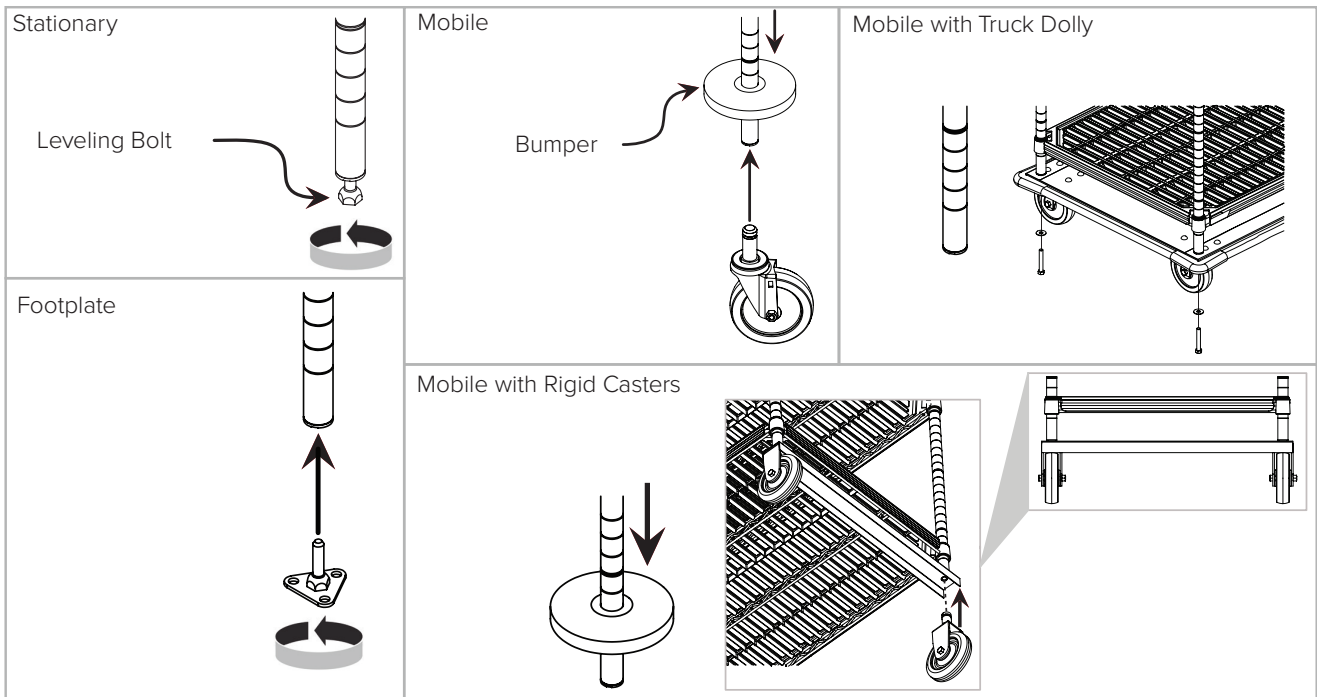

Quick Assembly (Stationary only)

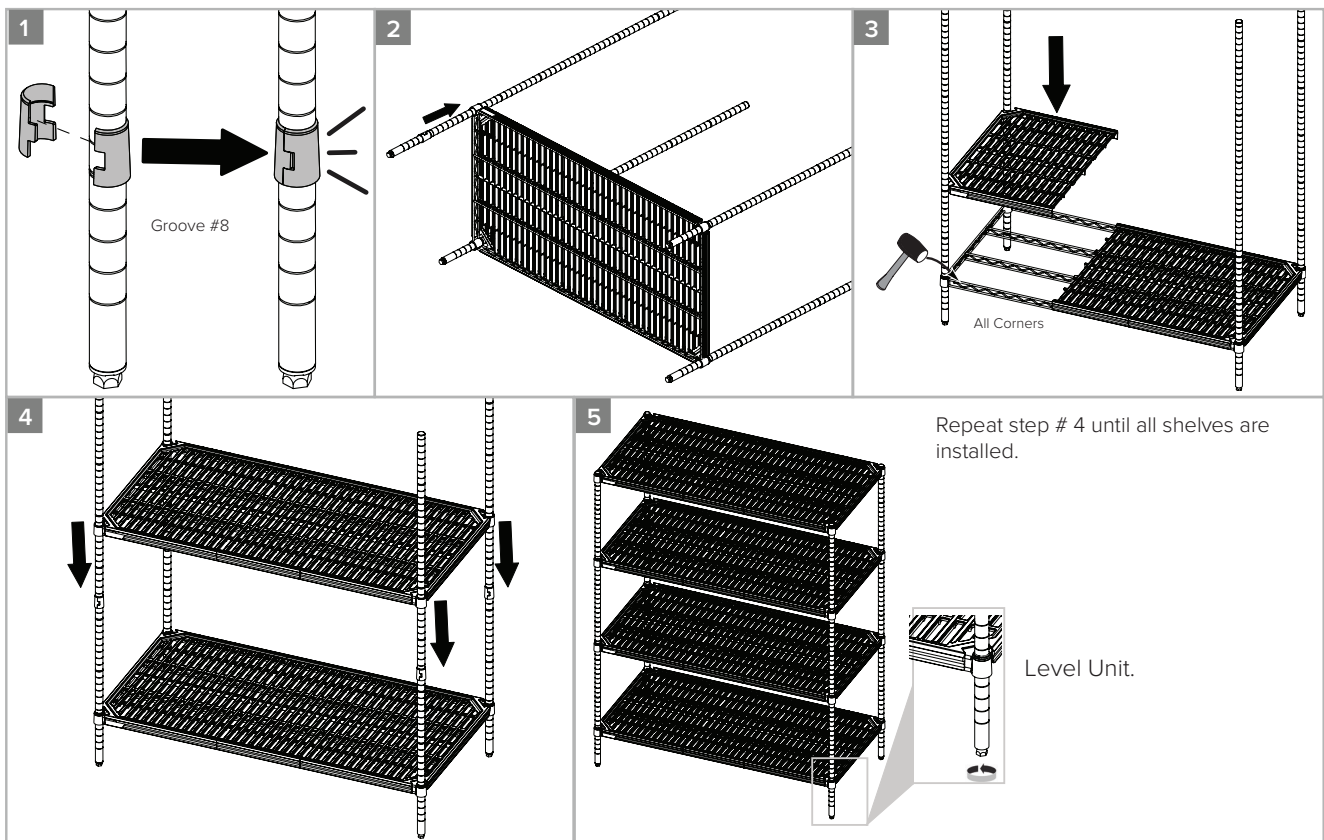

Mobile Unit

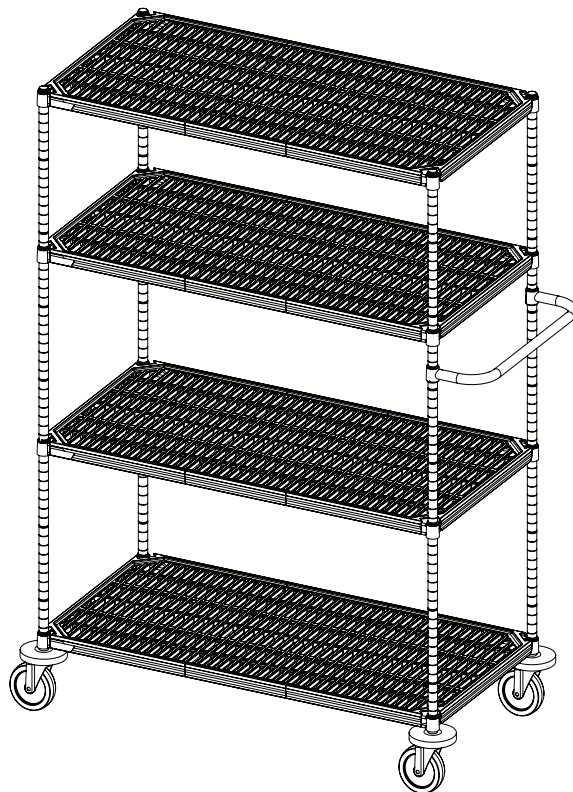
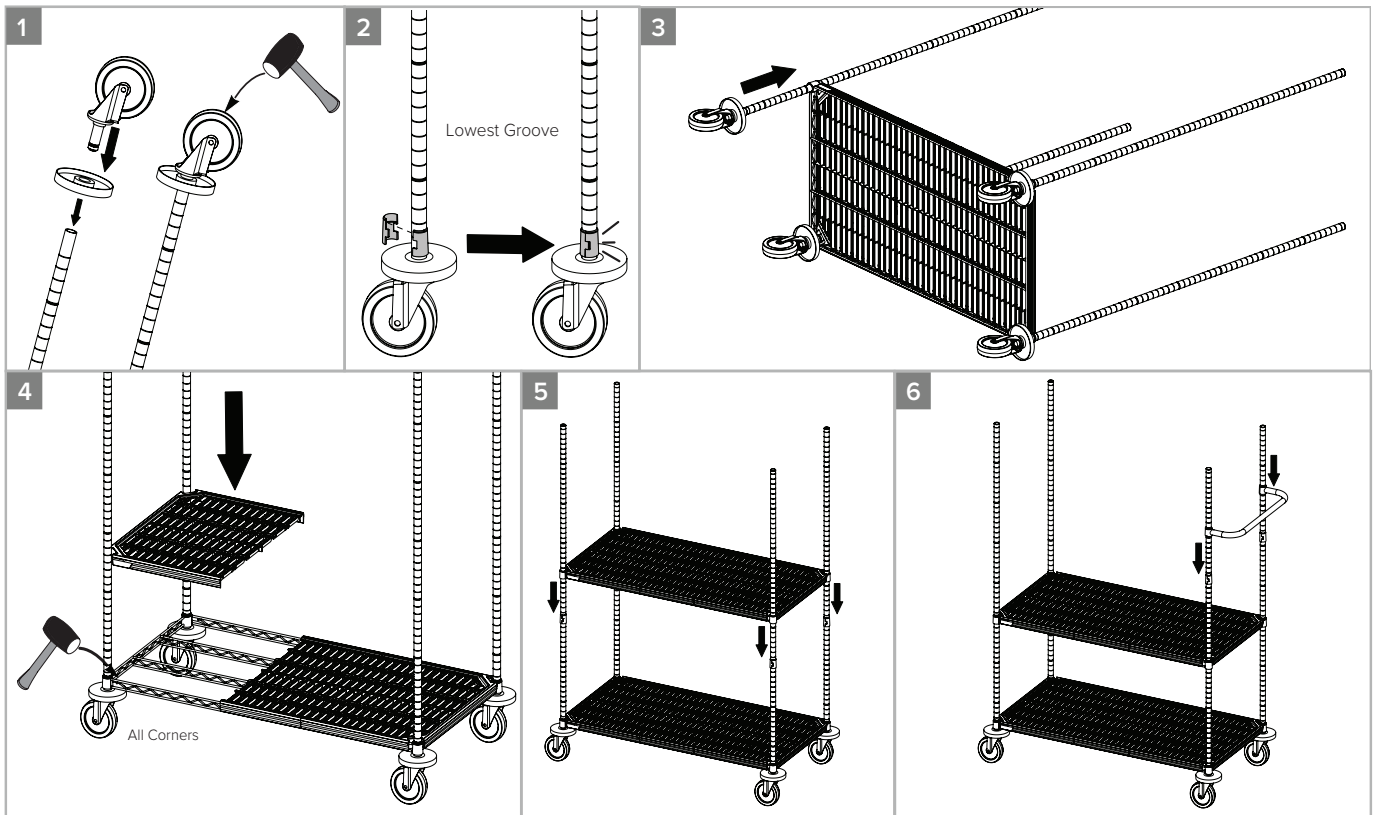

If using a handle, please note that handles MUST be installed while the cart is being assembled.

Due to continuous product research and development, the information contained herein is subject to change without notice.

**Universal Poly Divider (203mm)**

Fits all grid and wire systems

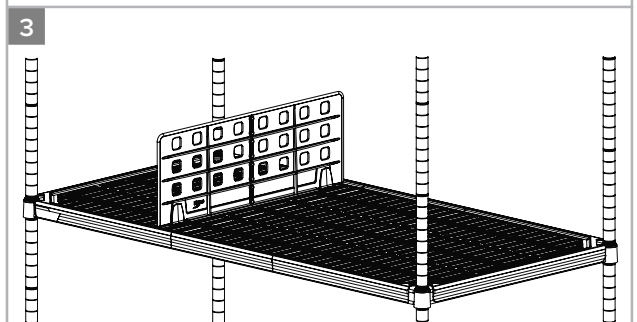
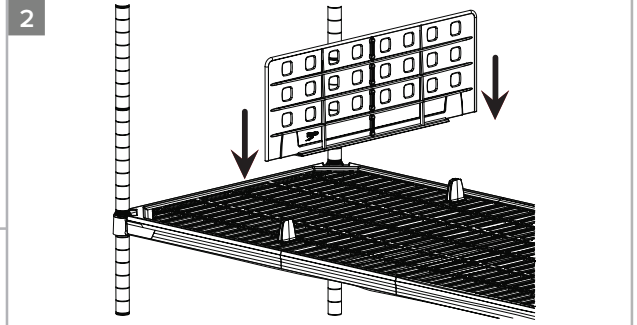
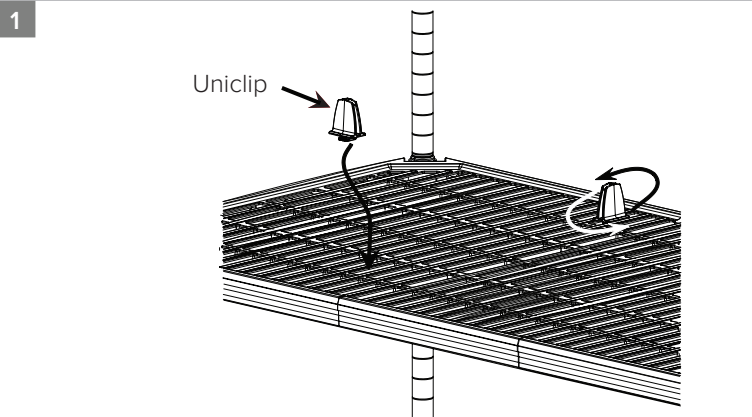

**Polymer Divider (203mm) - MetroMax Q**

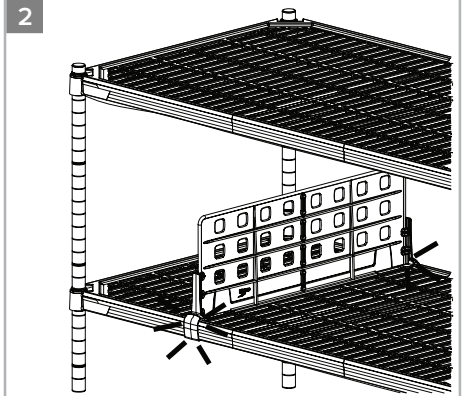
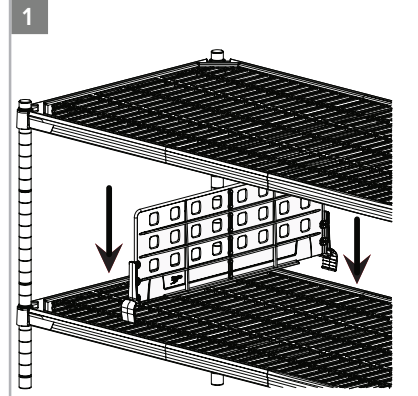

**Drying Rack**

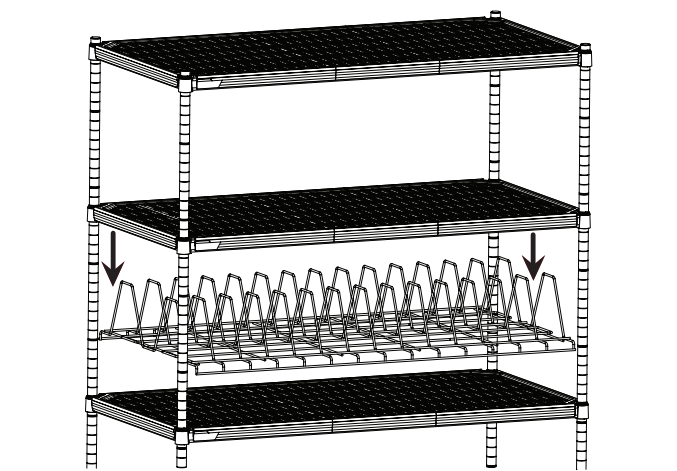

**Can Rack /**

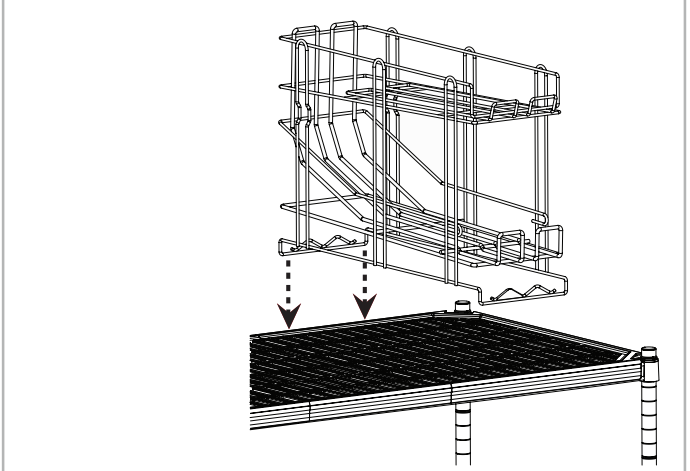

Shelf-to-Shelf Divider System

Detailed instructions are included in the cartons with Shelf-to-shelf dividers.

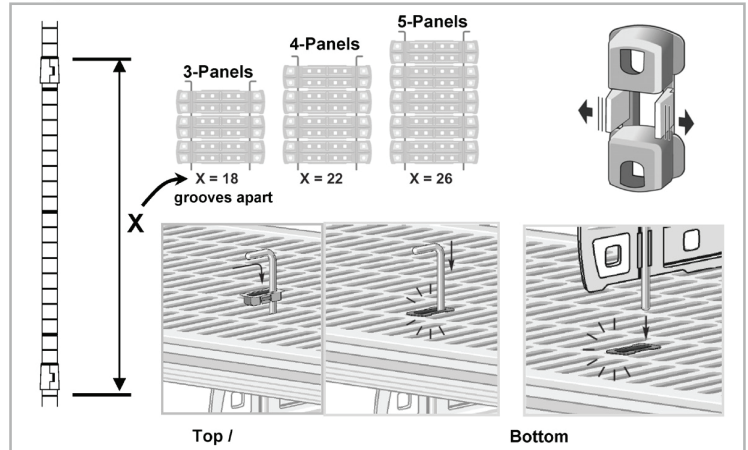
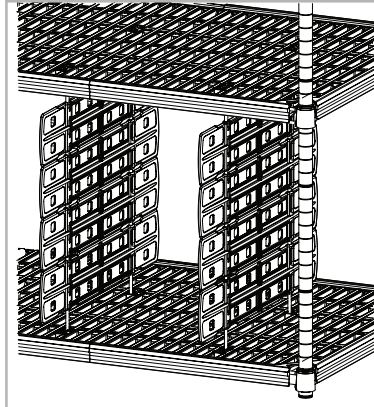

Adjustable Tray & Pan Slides



for each set of slides



max. for one level

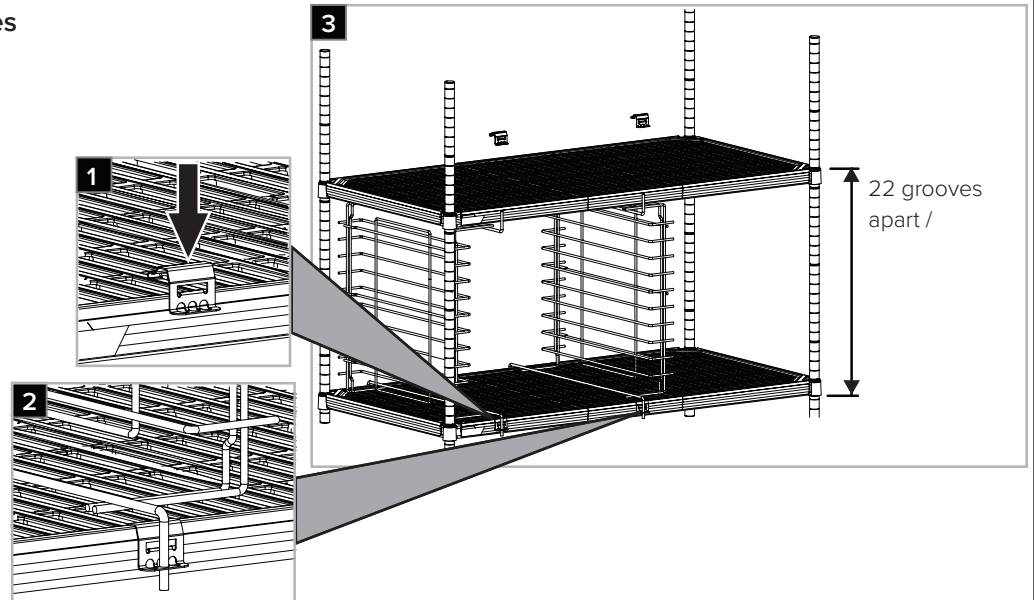

Super Slide for Metro tote boxes



for each set of slides



max. for one level

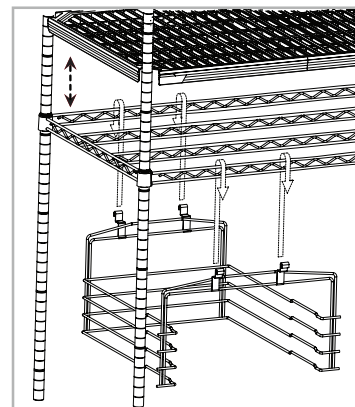

Due to continuous product research and development, the information contained herein is subject to change without notice.

Enclosure Panels

\* Super Erecta enclosures (Models starting with "EP") or MetroMax Q enclosures (Models starting with "MEP") may be used.

End Panels (shelf width)

Post	18" 457mm	21" 530mm	24" 610mm
54" / 1385mm	EP35 *	EP35 *	EP55 *
63" / 1590mm	EP36 *	EP36 *	EP56 *
74" / 1895mm	EP37 *	EP37 *	EP57 *

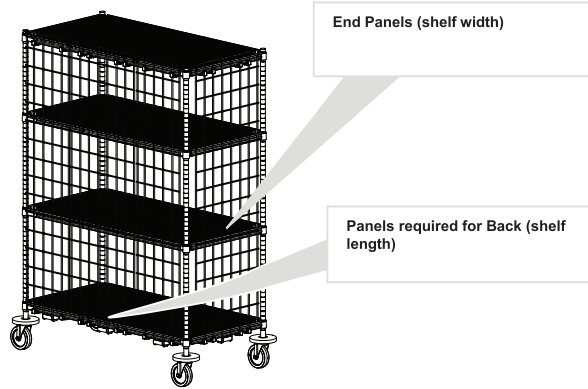

Panels required for Back (shelf length)  
 Panneaux nécessaires pour l'arrière (longueur de panneau)  
 Paneles posteriores necesarios (largo de estante)

	30" 760mm	36" 914mm	42" 1066mm	48" 1219mm	54" 1370mm	60" 1524mm	72" 1829mm
54" 1385mm	(2) EP35 *	(1) EP35 * (1) EP55 *	(2) EP55 *	(2) EP35 * (1) EP55 *	(1) EP35 * (2) EP55 *	(3) EP55 *	(1) EP35 * (3) EP55 *
63" 1590mm	(2) EP36 *	(1) EP36 * (1) EP56 *	(2) EP56 *	(2) EP36 * (1) EP56 *	(1) EP36 * (2) EP56 *	(3) EP56 *	(1) EP36 * (3) EP56 *
74" 1895mm	(2) EP37 *	(1) EP37 * (1) EP57 *	(2) EP57 *	(2) EP37 * (1) EP57 *	(1) EP37 * (2) EP57 *	(3) EP57 *	(1) EP37 * (3) EP57 *

If using Super Erecta wire enclosures, refer to instructions # L01-296 REV A, which is included in the carton with the Super Erecta enclosures.

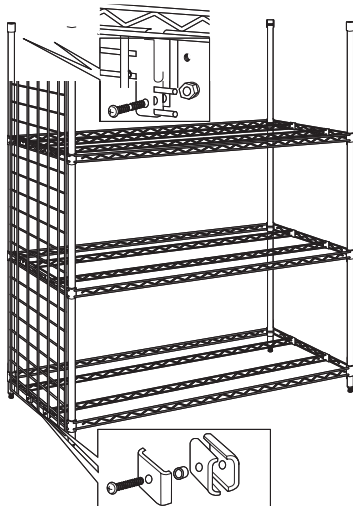

Once complete, replace shelf mats.

If using MetroMax Q enclosures, please see instructions # INSTR-MPNL, which is included in the carton with the MetroMax Q enclosures.

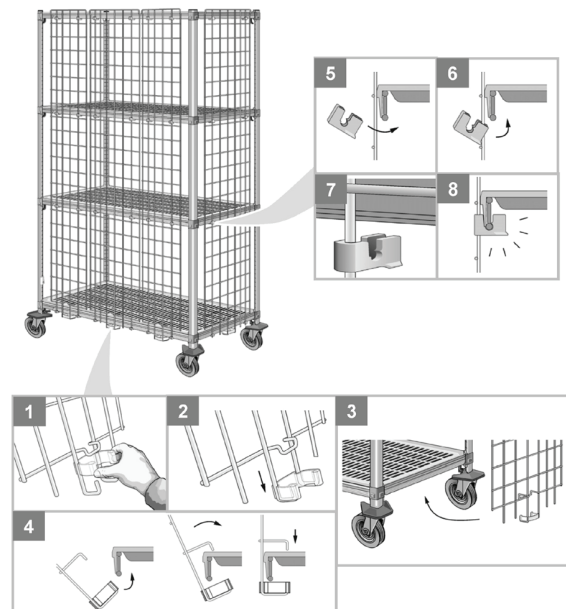

Intermediate S-hook Bracket

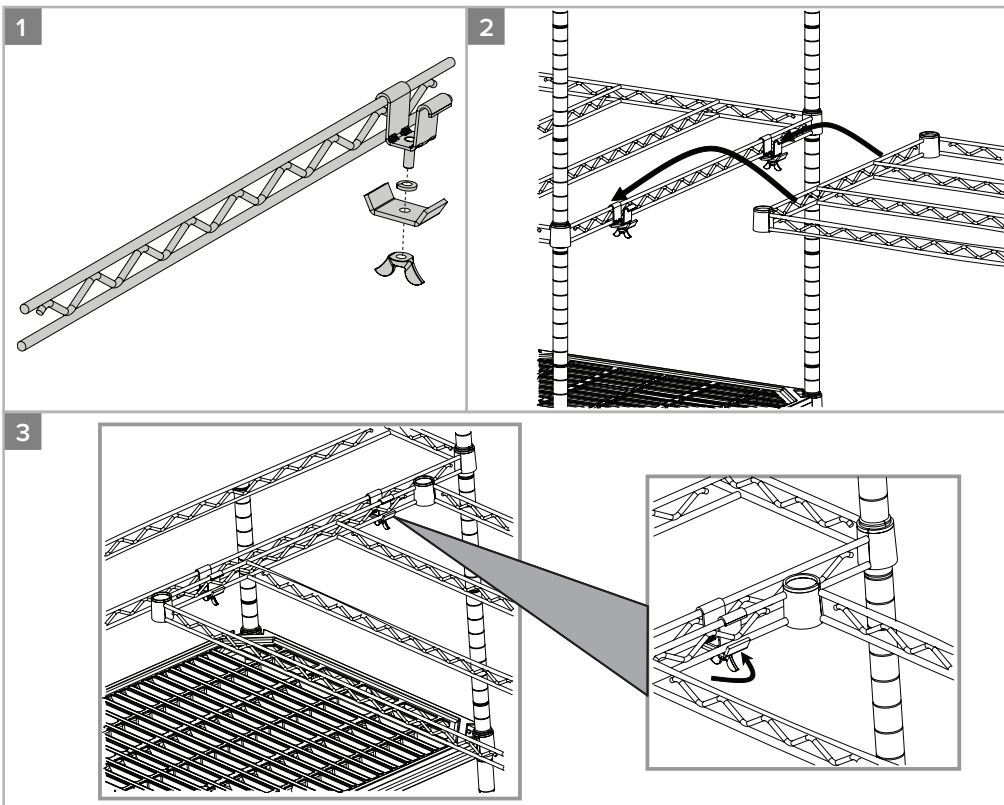
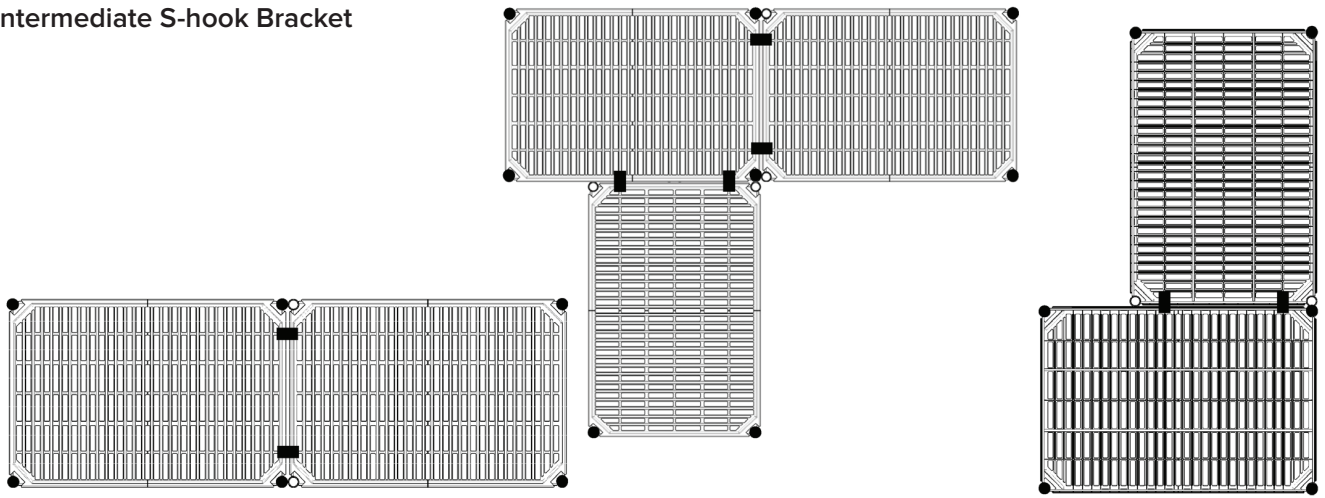

Due to continuous product research and development, the information contained herein is subject to change without notice.

### 4.0 Cleaning

#### 4.1 Metro Pro Series

1. Remove all products.
2. Remove lift-off Polymer mats.
3. Place in dish washing machine or sink to clean.
4. Replace mats and place product back on shelf.

#### 4.2 Disposal

If the appliance is no longer of use, please dispose in an environmentally correct way.

The distributor / retailer can contact their local metal recycling centre to collect the remaining cabinet, shelves, etc.

There may be special requirements or conditions. Information on the disposal of refrigeration appliances can be obtained from:

- Your supplier
- Government authorities (The local council, Ministry of the Environment, etc.)



Discarded electric appliances are recyclable and should not be discarded in the domestic waste! Please actively support us in conserving resources and protecting the environment by returning this appliance to the collection centres (if available).



Dispose of packaging in accordance to applicable legal regulations.

## 4.0 Cleaning and Maintenance



### 5.0 Troubleshooting

#### 5.1.1 Troubleshooting Procedures

- If any faults/issues occur with the unit, follow the below troubleshooting procedures
- If the troubleshooting procedures do not correct the problem, contact the Stoddart Service Department

Problem	Possible Causes	Possible Corrective Action
	Shelving is not level	<ul style="list-style-type: none"><li>• Ensure each post clip/wedge are on the same post number</li><li>• Ensure the unit has been positioned on a level floor and posts are the same finished height</li><li>• Adjust post feet to ensure unit is level</li></ul>
	Mobile units feel unsecure	<ul style="list-style-type: none"><li>• Ensure caster wheels have been fixed securely</li></ul>



## Australia

Australian Business Number: 16009690251

### Service / Spare Parts

<https://customerservice.stoddart.com.au>

### Sales

Tel: 1300 79 1954

Email: [sales@stoddart.com.au](mailto:sales@stoddart.com.au)

Web: [www.stoddart.com.au](http://www.stoddart.com.au)

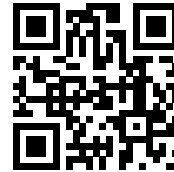

Customer  
Service Portal

---

## New Zealand

New Zealand Business Number: 6837694

### Service / Spare Parts

<https://customerservice.stoddart.com.au>

### Sales

Tel: 0800 79 1954

Email: [sales@stoddart.co.nz](mailto:sales@stoddart.co.nz)

Web: [www.stoddart.co.nz](http://www.stoddart.co.nz)

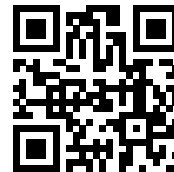

Customer  
Service Portal