

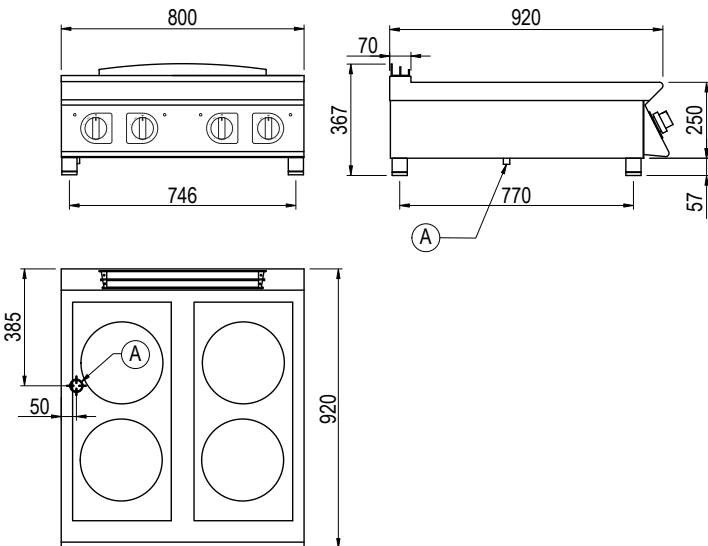

Product Information:

- Class leading, European style, professional quality and reliability since 1963
- 900 series, 6mm, ceramic glass induction boiling top, with two independent cooking zones (4 x 5.4kW)
- Automatic heat generation when induction specific pan is placed on the cooktop
- Automatic shut off when pan is removed from the cooktop
- Precise heat transfer for shorter cook times and enhanced operator safety and comfort
- Independent temperature regulation via 6 position selectors
- LED lights to monitor the correct operation of the appliance
- Robust 304 grade stainless steel construction with rounded corners for improved cleaning
- 24-month warranty

General Drawing:



Specifications:

Model	CI940TT
W x D x H (mm)	800 x 920 x 367
Weight	75kg
Cooking Zone	4 x Ø270mm
Packed Dimensions (mm)	845 x 825 x 570
Packed Weight (mm)	87kg
Electrical Connection	3Ø + N + E 415VAC / 50Hz / 21.6kW

Legend:

A Electrical Connection

