

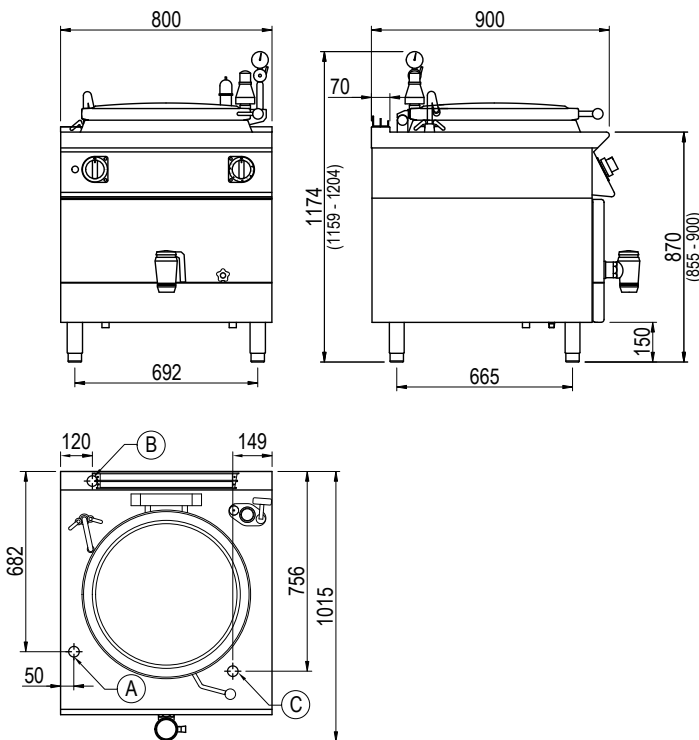

Product Information:

- Class leading, European style, professional quality and reliability since 1963
- 900 series, indirect heating electric boiling pan with 150 litre capacity (22.7kW)
- Steam jacketed kettle for even indirect heat over the entire cooking surface. Limit burning.
- Heating elements positioned inside the jacket gap with Hi-limit temperature protection
- Temperature regulation via 6 position selector
- Indicator lights to monitor the correct operation of the appliance
- Automatic fill jacket with pressure control via pressure gauge, safety valve and condensation valve
- Hot and cold water fill via integrated valve and spout
- Double skinned counterbalanced lid
- Pan emptied through front positioned tap with insulated grip
- 316 grade stainless steel pan base for superior corrosion resistance
- Robust 304 grade stainless steel construction with rounded corners for improved cleaning
- Height adjustable stainless steel feet for a 900mm working height
- All units are supplied with either (SF) - 1 x Standard filter and 1 x storage tank, or (RO) – 1 x Reverse osmosis filter and 1 x storage tank
- 24-month warranty

General Drawing



Specifications

Reverse Osmosis Model	PEI915T.RO
Standard Filter Model	PEI915T.SF
W x D x H (mm)	800 x 1015 x 1174
Weight	200kg
Capacity	150L
Packed Dimensions (mm)	845 x 1025 x 1200
Packed Weight (mm)	212kg
Electrical Connection	3Ø + N + E 415VAC / 50Hz / 22.7kW

Legend

A	Electrical Connection
B	Cold Water Connection 1/2" BSP
C	Filtered Water Connection 1/2" BSP
SF	Standard filter 140w x 500h (mm)
RO	Reverse Osmosis 380w x 248d x 500h (mm)
TANK	18 litre storage tank 280w x 370h (mm)

*Note – Recommended to house filter and storage tank in Giorik ambient top on open base in line up, or under a Simply Stainless - SS02.7.0450

Due to continuous product research and development, the information contained herein is subject to change without notice.

Revision: 02 - 22/01/2026 - A

www.stoddart.com.au

www.stoddart.co.nz

