

# INFINITY<sup>®</sup>

MASSAGE CHAIRS



**User Manual**

SMART CHAIR PRO

# Your Chair

## External Structure

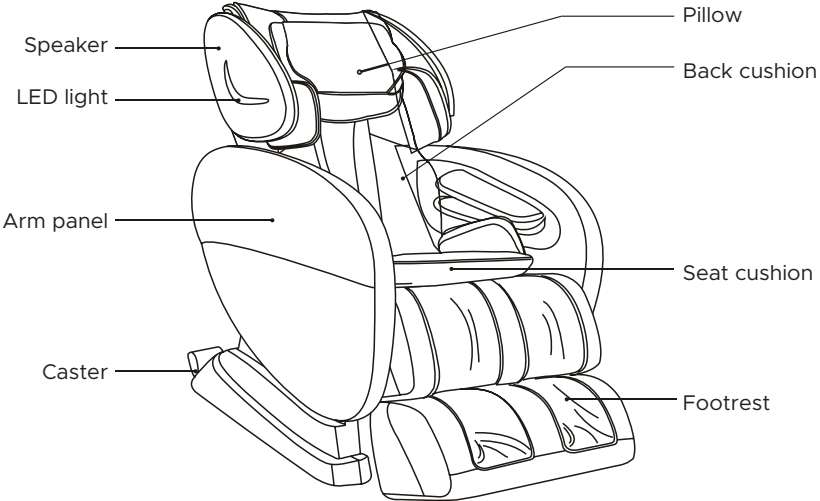

## Internal Structure

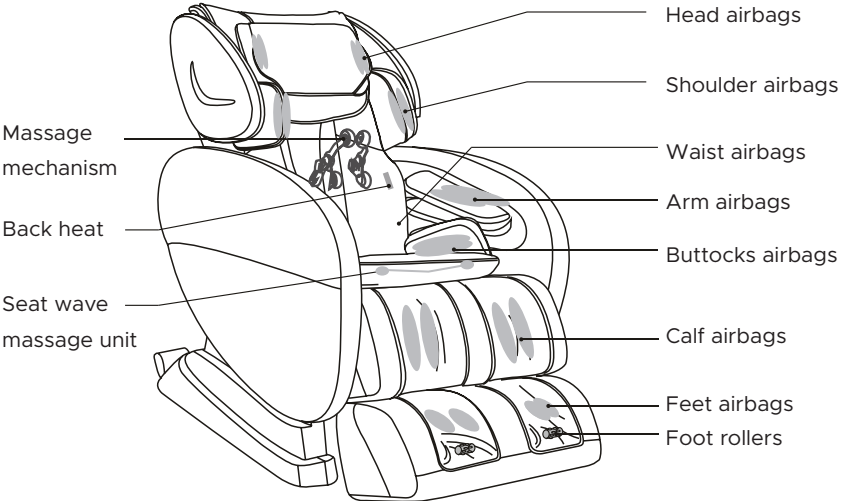

Welcome to

# INFINITY<sup>®</sup>

THE ULTIMATE MASSAGE EXPERIENCE

Thank you and congratulations on purchasing an Infinity Massage Chair - you've made a great choice.

With over a decade of experience designing, building and servicing massage chairs, Infinity takes pride in every chair sold, including yours. We are here for you. The US-based Customer Care team can be reached at (603) 910-5000 or visit us online at [www.infinitymassagechairs.com](http://www.infinitymassagechairs.com) and find valuable self service resources under the SUPPORT tab, including electronic copies of all documents and video tutorials.

Inside this manual, you will find everything you need to setup and safely enjoy your chair. Please review the entire manual before assembling or using your chair. If you are assembling the chair yourself, please see the Assembly Guide next and reference the online assembly video.

For convenience, we've also created a Quick Start Guide. We suggest you keep it in the remote pocket as a tool to get to know all the features of your new chair.

**Get ready to sit back, Relax and enjoy the Ultimate Massage Experience.**

Register your product at [www.infinitymassagechairs.com/warranty](http://www.infinitymassagechairs.com/warranty) to ensure it is in our system. This will simplify the warranty process should you ever need it.

Alternatively, **scan the QR code** to go directly to the URL above.



SCAN CODE



@infinitymassagechairs



@infinity\_chairs



@infinitymassagechairs

We know you cant wait to sit in your new Infinity Massage chair!  
Take a picture of you enjoying the ultimate massage experience  
and make sure to tag us on social media with the hashtag  
**#lovemyinfinitychair**

# Chair Features

Body Scanning



See page 9

Lumbar heat



See page 13

Bluetooth



See page 14

Nature Sounds



See page 15

Voice Demo



See page 16

Changing Language



See page 16

Manual Massage Customization



See page 18

Foot Rollers



See page 13 & 19

Zero Gravity



See page 19

Waist twist seat



See page 19

# Table of Contents

## Before Getting Started

Installation Site	6
Clearance Space for the Chair	6
Floor Protection	6
Move Methods	7
Connect to Power	7

## Chair Setup

Getting Comfortable	8
Main Power Switch	8
Adjust Pillow	8
Body Scanning	9
Reduce the Intensity of Your Massage	9
Getting Out Of The Chair	9

## Taking Control

Auto Programs	10
Airbag Massage	12
Airbag Region	12
Airbag Intensity	12
Back Heat	13
Foot Rollers	13

## Set Your Environment

Time	14
Bluetooth Audio	14
Sounds	15
Volume	16
Demo Voice	16

## Settings

Language	16
Bluetooth Audio	17
Beep	17
Remote Control Screen Idle	17

## Build Your Own

Manual Programs	18
Back Massage Technique Mode	18
Massage Part (Back Region)	18
Back Node Width	18
Massage Speed	19
Foot Rollers	19
Zero Gravity	19
Sway	19

## Staying Safe

## Fixing Issues

Specifications	22
Trouble Shooting	22
Frequently Asked Questions	23

# Before Getting Started

## Installation Site

### Clearance Space for the Chair

- 14" clearance for the recline of the backrest; 16" clearance for the extension of footrest and sliding forward of the chair.
- Keep it 3 feet away from the TV, radio or other audio & video appliance to avoid signal interference.

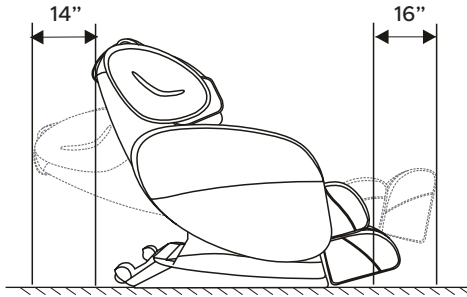

- Keep the distance between the power socket and power switch within 60" to avoid damage of power cord while massage chair sliding forward.
- Straighten the power cord while in use to avoid tangle or damage.
- When the massage chair sliding forwards or back, please check to make sure there is no children, pets or other obstacles around to avoid accident.

## Floor Protection

We recommend to place a piece of thin carpet or soft mat underneath it to avoid damaging the floor.

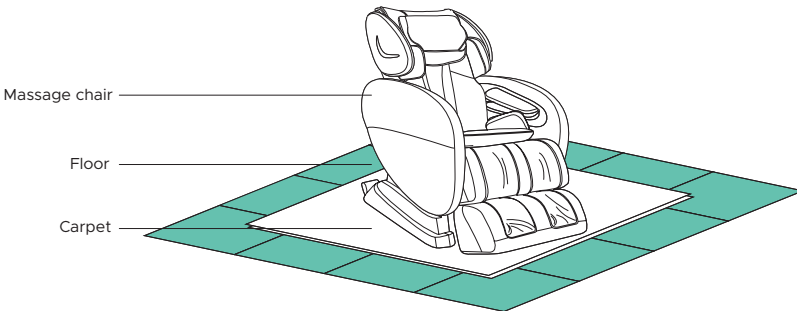

- Do not use the massage chair in high moisture environment such as near swimming pool or bathroom to prevent electric shock accident.
- Please keep the massage chair away from heated surfaces to prevent fire hazard or damage to the product.

## Move Methods

- Apply pressure to the back of the massage chair from behind to pivot on the Castors. Have a second person up front to guide the Footrest until in the correct position. Maintain clearances as mentioned above. Gently lower into place. Do not pull on the side arms.

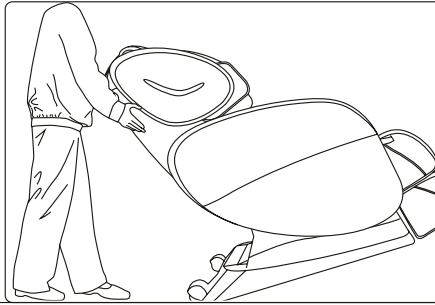

- Do not move the chair when there is user inside.
- To carry this product, do not lift by the footrest or armrest, hold the chassis and steady the backrest (have 4 or more people to carry the product).

## Connect to Power

Plug into a 110V grounded outlet.

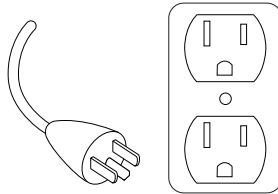

This product must be grounded. If it should malfunction or breakdown, grounding provides a path of least resistance for electric current to reduce the risk of electric shock. This product is equipped with a cord having an equipment-grounding conductor and a grounding plug. The plug must be plugged into an appropriate outlet that is properly installed and grounded in accordance with all local codes and ordinances.



- Ensure there is no damage to the supply cord before switching on the massage chair.
- Ensure that the main power switch is turned off before connecting to power

# Chair Setup

## Getting Comfortable

### Main Power Switch

To power up the chair, flip the main power switch located on the back of the base of the chair to **ON**.

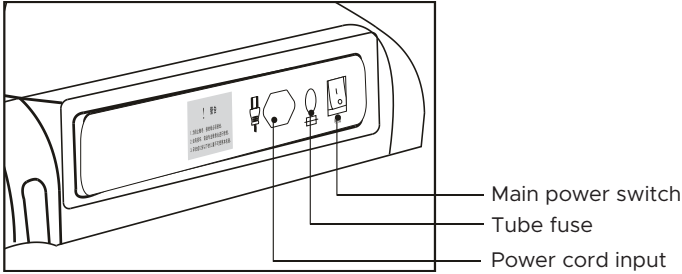

- Children should be supervised to ensure that they do not play with the chair or touch the power box.
- Always unplug the massage chair from the electrical outlet immediately after use.
- Unplug from outlet during thunder or lightening storms, and before putting on or taking off parts.
- Turn off the power switch and unplug the massage chair from the electrical outlet while not in use to avoid children power on the massage chair accidentally.
- When not in use for a long period of time, we recommend that the chair be covered, the power cord be coiled and that the unit be placed in an environment free of dust and moisture.

### Adjust Pillow

Take a seat in the chair and take note of where the neck pillow rests on your neck. Adjust the pillow so that it rests comfortably in the arch of your neck. Do this by removing it from the velcro, aligning it, and then reattaching to the velcro once it is in the desired position.

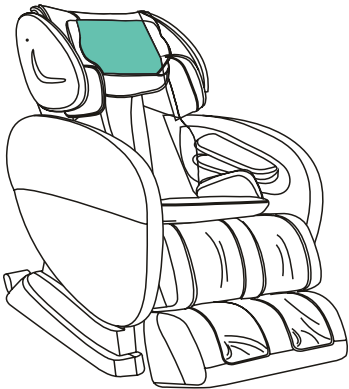



**Smart tip:** To increase intensity in the neck and shoulder region, flip the pillow or the pillow and pillow pad up so you lay directly on the seat backpad.

## Body Scanning

Select any auto program and press the **OK** button. The chair will automatically begin scanning your body, mapping your back, shoulders, and neck. During this process it's important to remain seated back into the chair without lifting your head.

The scan can be viewed on the remote control screen. If fine tuning is needed just after your body scan, wait for the **shoulder adjust prompt** to appear and then use the **Back Adjustment** buttons to move the massage rollers up or down for the perfect shoulder kneading position.

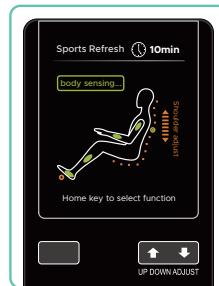
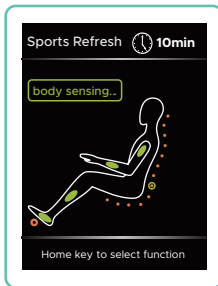

## Reduce the Intensity of your Massage - Manually

To make the massage less intense, you can **add the back pad** to the seat back of your chair, or you can also **fold down the neck rest** to provide more cushioning between you and the massage mechanism in the seat back. To make the foot rollers less intense, make sure the **foot pads** that came with the chair are inserted into the bottom of the footrest.

## Getting out of the Chair

To easily exit the chair at any time, press the **ON/OFF** power button on the remote control to restore the chair to the upright position.

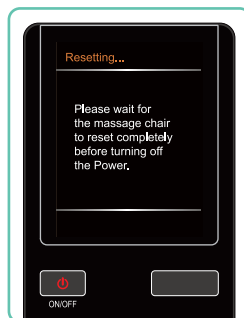

# Taking Control

## Auto Programs

Press **AUTO** to jump to the Auto Program menu. Select among 7 Auto Programs by navigating down to it, then select by hitting **OK**. The display screen will show the In-Use screen.

While running any Auto Program, you can select a different Auto Program or go into Manual mode at any time. You do not need for that program to end.

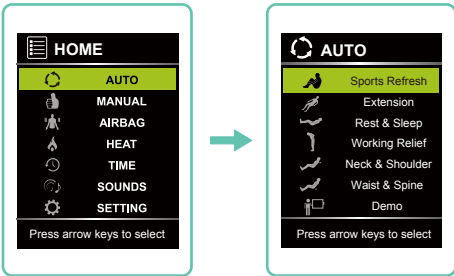

Program	Icon
Sports Refresh	
Extension	
Rest & Sleep	
Working Relief	
Neck & Shoulder	
Waist & Spine	
Demo	

What for?	Description
Soothe muscles after sports activities and exercise.	Relaxes muscles and speeds up recovery time after intense exercise by promoting circulation.
This program is the best choice to relax tired muscles and increase physical vigor.	Inspired by Thai massage. The strong kneading and stretching functions effectively decompress the entire body.
Try this program as you prepare your body to rest for the night.	Kneads the entire body with a gradual lightening of intensity massage to relieve tired muscles.
This is a great program for people who work at a desk or travel a lot.	Performs a strong massage to ease muscles and recuperate the body.
This program relieves neck and shoulder pain	Selected neck & shoulder massage techniques for soothing pain and tension in the neck and shoulders.
To relieve lower back pain	Focuses on the lumbar vertebra with targeted massage to relieve tension in this area.
To gain a quick understanding of what each auto program has to offer.	A quick show of massage chair's features and functions. That can be accompanied by an explanatory voice over. The voice can be turned off and on in SOUNDS.

# Taking Control

## Airbag Massage

Press **AIRBAG** from Home display, press up or down button to navigate among **PART** and **FORCE**. Select by pressing **OK**.

**PART** allows you to select which airbags to use. Select Full for all airbags. Otherwise pick and choose amongst the other Parts to turn them on or off. You may select more than one Part. To turn off all Airbags, select any lit parts and hit OK to turn off. When no Parts are lit, all airbags are off.

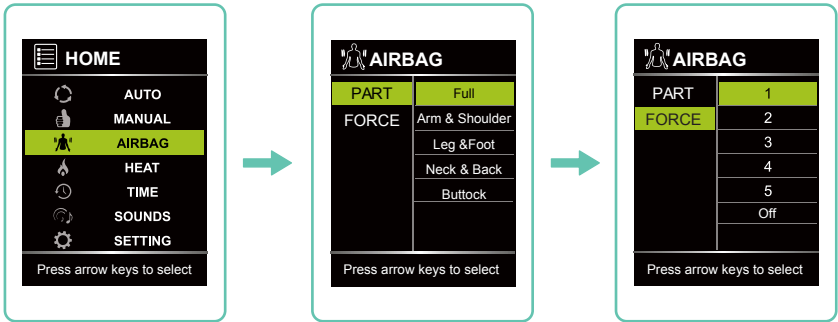

## Airbag Region

Navigate to **PART**, press right button, then use the up or down button to select your desired airbag region: Full, Arm & Shoulder, Back and Waist, Leg & Foot, Buttock. Press **OK** button to select the airbag region.

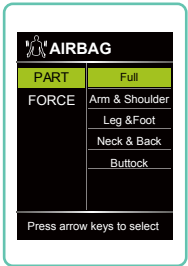

## Airbag Intensity

Navigate to **FORCE**, press right button, then use the up or down button to select your desired intensity: 1 = light, 5 = firm, or Off. Press **OK** button to select the airbag intensity.

While the in-use screen is displayed during a massage program, press the **left or right button** to adjust the airbag intensity (this feature works in both Auto and Manual program).

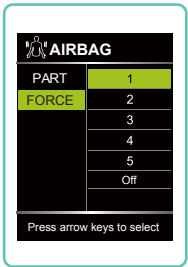

**Smart tip:** Alternatively, you can adjust **Foot Roller Speed** by pressing the Foot Roller button on your remote control. Pressing this button will cycle through the 3 speeds, and then turn off.

## Back Heat

Press **HEAT** from Home display, press right button, then press up or down button to navigate to desired heat setting: On or Off. Press **OK** button to select the heat setting.

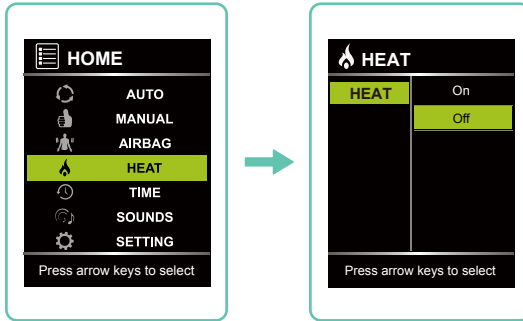

## Foot Rollers

Select **MANUAL** from Home display, then press up or down button to navigate to **ROLLER**. Press right button, then use the up and down buttons to select your desired foot roller speed: 1 = slow, 2, 3 = fast, or OFF (deactivate foot roller). Press **OK** button to select the speed level you desire.

Alternatively, press the **Foot Roller** button on your remote control. Pressing this button will cycle you through the 3 different speed settings, and then turn the foot rollers off. Your current foot roller speed is displayed in the in-use screen.

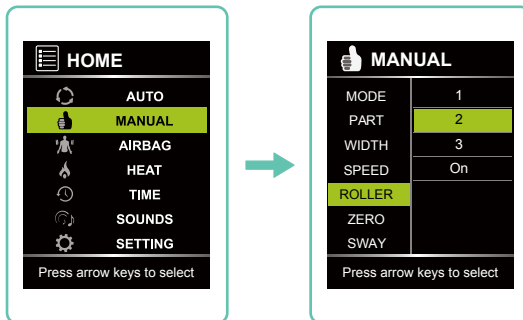

# Set your Environment

## Time

Select **TIME** from Home display, press right button, then press up or down button to select your desired timer: 10 minutes, 20 minutes, or 30 minutes. Press **OK** to select your desired message timer length. 20 minutes is the default setting.

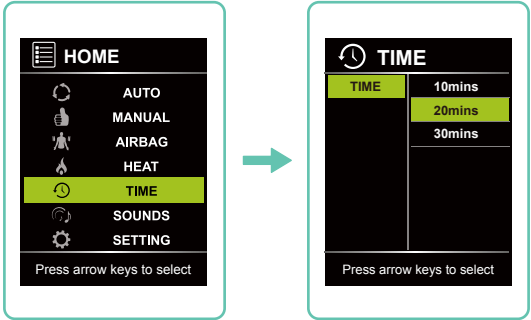

## Bluetooth Audio

Your massage chair includes Bluetooth compatibility so you can play and enjoy your favorite music. To connect your Android or Apple device, press **SETTING** from Home display, then press up or down button to navigate to **BLUETOOTH**. Press right button, then press up or down button to select your desired bluetooth setting: On or Off. Press **OK** to select bluetooth setting.

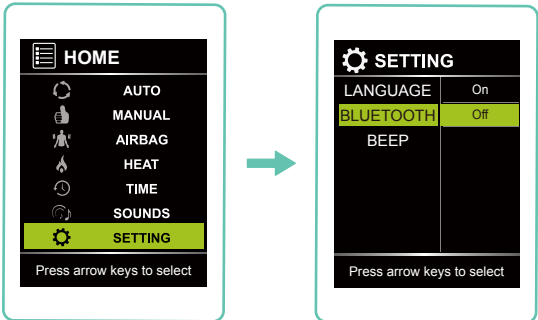

**Smart tip:** Bluetooth must be **ON** for sounds to work. Make sure to go into **settings** and turn on **Bluetooth** before attempting to listen to sounds.

## Sounds

Press **SOUNDS** from Home display, press right button then press up or down button to navigate among: **PLAY** and **VOLUME**. Press **OK** button to enter the sounds setting you desire to control.

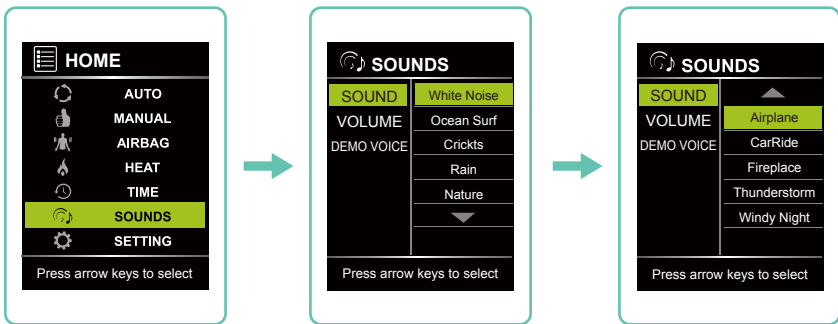

Sounds	What is it?
<b>White Noise</b>	A constant, even loop of pure white noise to mask out distractions
<b>Ocean Surf</b>	Soothing ocean waves rolling onto the shore
<b>Crickets</b>	Night time in the suburbs. Churping Crickets, water trickling from a pond, and faint traffic noises
<b>Rain</b>	Quiet, light, refreshing rain falling to the ground
<b>Nature</b>	Refreshing sounds of small birds peacefully singing along a tranquil stream.
<b>Air Plane</b>	A Cessna propeller airplane motor idling
<b>Car Ride</b>	Calming inner-city traffic featuring cars, trucks, and motorcycles
<b>Fireplace</b>	Crackling of fire in a fireplace
<b>Thunderstorm</b>	Heavy rainstorm with thunder
<b>Windy Night</b>	Heard from inside a cabin, a howling wind blows constantly outside

**Note:** Bluetooth must be **ON** for sounds to work.

# Set your Environment

## Volume

Navigate to **VOLUME**, press right button, then press up or down button to select your desired volume setting: 1 (lowest), 2, 3, 4, 5 (highest). Press **OK** button to select the volume setting.

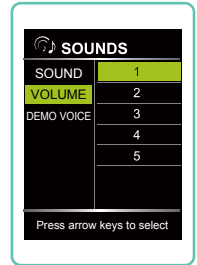

## Demo Voice

The Auto Program called **Demo** has a spoken word audio that plays through the speakers when active. To turn off this Demo Voice, Navigate to **DEMO VOICE** press right arrow and select Off then press **OK**. If you want to re-active the demo voice you may do so by selecting On. The Demo Voice is only available in English.

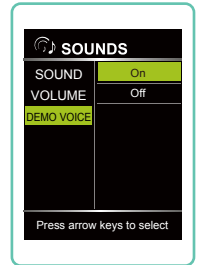

# Settings

## Setting

Press **SETTING** from Home display, then use the up or down button to toggle between **Language**, **Bluetooth**, or **Beep**.

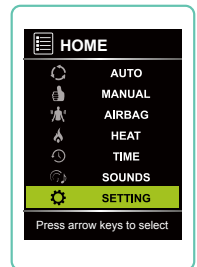

## Language

Navigate to **LANGUAGE**, press right button, then use the up or down button to select your desired language: ENGLISH or CHINESE. Press **OK** button to select language.

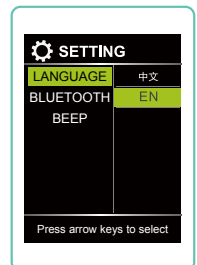



**Smart tip:** All settings listed below will be **memorized** when you turn off the massage chair.

## Bluetooth Audio

To connect your Android or Apple device, press **SETTING** from Home display, then press up or down button to navigate to **BLUETOOTH**. Press right button, then press up or down button to select your desired bluetooth setting: On or Off. Press **OK** to select bluetooth setting.

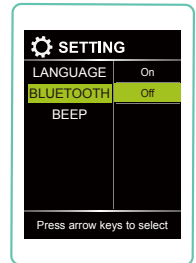

## Beep

The remote control provides an audible “beep” as feedback. You may turn this audible beep off. Navigate to **BEEP**, press right button, then use the down button to Off. Press **OK**. To restore the beeping, select On.

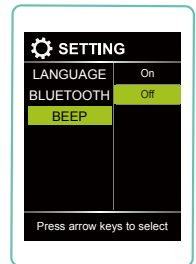

## Remote Control Screen Idle

Whilst running an Auto Program or Manual mode, the remote control screen will return to the in-use screen (as shown below) after 10 seconds of being idle.

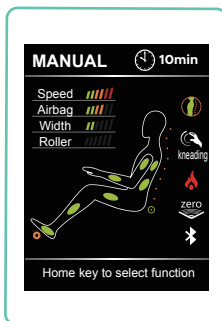

Manual in-use screen

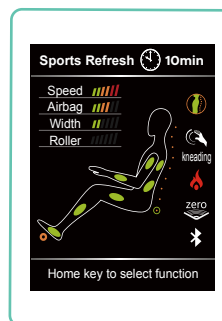

Auto Program in-use screen



- Please do not spill water or other liquids on the controller in order to avoid key malfunctions and error codes.
- Please do not place heavy objects on the controller or power cord.

# Build your own

## Manual Programs

In Manual mode you can operate components of your massage chair individually or combine them to create unique massage scenarios.

Press **MANUAL** from Home display, press up or down button to navigate among: **MODE**, **PART**, **WIDTH**, **SPEED**, **ROLLER**, **ZEROG**, and **SWAY**.

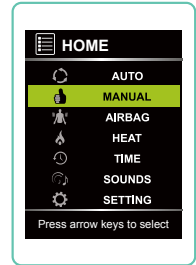

## Back Massage Technique Mode

Navigate to **MODE**, press right button, then use the up or down button to select your desired mode: Kneading, Tapping, Knocking, Shiatsu, Sync. Press **OK** button to select mode.

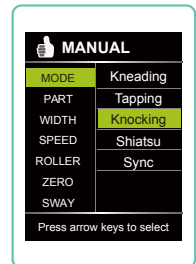

## Massage Part (Back Region)

Navigate to **PART**, press right button, then use the up or down button to select your desired region: Whole, Partial, and Point massage. Press **OK** button to select region.

**Whole** travels the entire length of the track. **Partial** travels a short distance and reverses direction for focused relief. **Point** stops on the track for targeted relief. Partial and Point location can be fine tuned using the Back Adjustment arrow up or arrow down buttons

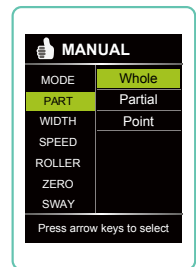

## Back Node Width

Navigate to **WIDTH**, press right button, then use the up or down button to select your desired width: Wide, Medium, and Narrow roller width. Press **OK** button to select mode. (Massage Width can't be adjusted when in Kneading, or Sync Manual modes).

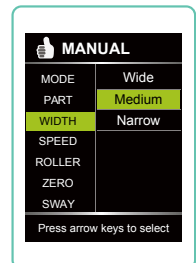

**Smart tip:** **Massage Width** can't be adjusted when in Kneading, or Sync mode techniques. **Massage Speed** can't be adjusted when in Shiatsu.

## Massage Speed

Navigate to **SPEED**, press right button, then use the up or down button to select your desired speed: 1 = slow, 6 = fast. Press **OK** button to select the speed. (Massage Speed can't be adjusted when in Shiatsu).

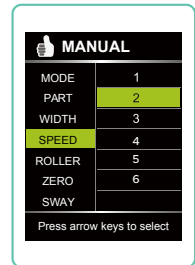

## Foot Rollers

Navigate to **ROLLER**. Press right button, then use the up and down buttons to select your desired foot roller speed: 1 = slow, 2, 3 = fast, or OFF (deactivate foot roller). Press **OK** button to select the speed level you desire.

Alternatively, press the **Foot Roller** button on your remote control. Pressing this button will cycle you through the 3 different speed settings, and then turn the foot rollers off. Your current foot roller speed is displayed in the in-use screen.

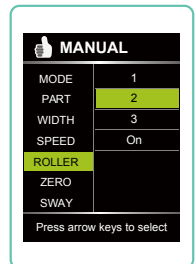

## Zero Gravity

Zero Gravity mode will recline the back and elevate the feet to reduce the gravitational force on your spine. Navigate to **ZERO**, press right button, then use the up or down button to select your desired Zero Gravity setting: On or Off. Press **OK** button to select the setting.

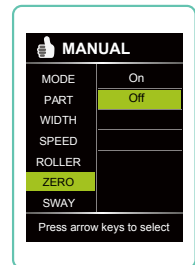

## Sway

Wave provides a twisting motion at the hips to enhance the effectiveness of the massage. You can control the speed or turn off this feature. Navigate to **SWAY**, press right button, then use the up or down button to select your desired seat wave speed: 1 = slow, 2, 3 = fast, or Off (deactivate wave massage). Press **OK** button to select the wave speed.

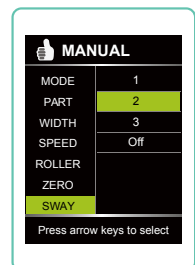

# Staying Safe

## Safety Precautions

Precautions listed below will help to ensure proper use of this appliance. Read all instructions before using this appliance.



WARNING

- Improper operation may cause severe personal injury or substantial property damage.



CAUTION

- Improper operation may cause personal injury or product damage.



- Prohibited.



- No Disassemble.

## Not Suitable For Below Persons

We recommend those with any of the following conditions consult your physician before using.



WARNING

- Those who are using electronic medical instruments embedded in the body, such as a cardiac pacemaker.
- Those undergoing treatment, especially those who are not feeling well.
- Those with malignant tumors or malignant abscesses. (Need to be supervised)
- Women who are pregnant.
- Those with osteoporosis or a fractured spine.
- Those with skin diseases or those with skin injuries.
- Those with a high fever.
- Close supervision is necessary when this product is used by, on, or near children, invalids, or disabled persons.
- The appliance has a heated surface. Persons insensitive to heat must be careful when using the appliance.
- This appliance can be used by children aged 8 years and above and persons with reduced physical, sensory, or mental capabilities, or lack of experience and knowledge, if they have been given supervision or instruction concerning the use of the appliance in a safe way and understand the hazards involved.
- Children shall not play with the appliance.
- Cleaning and user maintenance shall not be made by children without supervision.

## Control Buttons Precautions



WARNING

- Do not operate the control buttons with wet hands.
- Do not spill water or other liquids onto the control buttons to avoid fault.
- Do not lay heavy objects on the controller.

## Best Circumstances



CAUTION

- Do not operate under blanket or pillow. Excessive heating can occur and cause fire, electric shock, or injury to persons.
- Do not use this appliance when ambient temperature is over 40 C.
- Women who are pregnant should not use this chair.
- Do not use this appliance in humid or dusty environment, or when any part of the body is in contact with plumbing or any similar ground.
- Never operate the appliance with the air openings blocked. Keep the air openings free of lint, hair, and the like.
- Do not use outdoors.
- Do not operate where aerosol (spray) products are being used or where oxygen is being administered.
- Please place the product on a flat level floor.
- Do not store near heat or open flame.
- Connect this unit to a properly grounded outlet only. See Grounding Instructions.

## Cautions Regarding the Adapters and Cord



CAUTION

- Always unplug this appliance from the electrical outlet immediately after using and before cleaning.
- An appliance should never be left unattended when plugged in. Unplug from outlet when not in use.
- Unplug from outlet during thunder or lightening storms, and before putting on or taking off parts.
- Check that the power voltage stated on the rating label corresponds to your local electricity supply.
- Do not use a damp hand to unplug the cord to avoid electric shock
- Do not drag the cord, reach to the front plastic end to unplug it.
- Do not squeeze, over bend, pull hard, or twist the cord.
- Keep the cord away from heated surfaces.
- Do not carry this appliance by supply cord or use cord as a handle.
- Never operate this appliance if it has a damaged cord or plug, if it is not working properly, if it has been dropped or damaged, or dropped into water. Return the appliance to a service center for examination and repair.
- To disconnect, turn all controls to the off position, then remove plug from outlet
- The appliance is only to be used with the power supply unit provided with the appliance.
- It must only be supplied at safety extra low voltage corresponding to the marking on the appliance.
- If the supply cord is damaged, it must be replaced by the manufacturer or its service agent or a similarly qualified person in order to avoid a hazard.

## Best Practices for Safe Use



CAUTION

- Only for users who weigh below 300 lbs.
- Use this product only for its intended use as described in this manual. Do not use attachments not recommended by the manufacturer.
- Appliance should only be used by one person, do not use by two or more persons at the same time to avoid damage to the product.
- Do not use the product right after a meal, it may cause discomfort.
- Remove personal accessories from arms and empty pockets while using the massage services.
- Check the upholstery under the cushions and other spots, if any damages are present, do not use it and refer to a qualified service professional for servicing.
- If you feel any abnormal discomfort during the operation of this product, turn off the power immediately and do not use the product.
- Use of the appliance for 20 minutes each time is highly recommended.
- Make sure there are no obstacles behind the chair and there is enough clearance before adjusting the backrest or legrest angle.
- Make sure there is no other excessive load pressed on the backrest or legrest besides the user.
- Make sure there are no children, pets or other objects under the backrest or legrest.
- Please be seated properly while using the product.
- Do not drag or push the chair or roll on its caster on wood floor or carpet to avoid damage



- Do not stand on or stack heavy objects on the footrest.
- Do not fall asleep while the product is operating.
- Avoid using the product under the influence of alcohol.
- Never drop or insert any object into any openings.
- If there is any smoke or unusual smell while using, stop using immediately, and unplug the power cord.



- Do not disassemble this product yourself to avoid failure.
- Do not dismantle, fix or modify the product yourself. Please contact authorized dealer or service agent.

# Fixing Issues

## Specifications

Model	Smart Chair Pro
Dimension of Main Body (in)	59 x 36 x 46 (L x W x H)
Necessary Clearance to Wall (in)	14"
Net Weight (lbs)	222
Shipping Weight (lbs)	334
Max. User Weight (lbs)	300
Voltage	110V
Fuse	3.15 AMP
Power Consumption	260W
Safety Standards	Type 1

## Trouble Shooting

No.	Symptoms	Possible Causes	Possible Solution
1	Noise is heard while in use	These noises are normal and arise from friction between the massage rollers and the faux leather cover	No need to take any measures
2	Massage Chair does not start	<ul style="list-style-type: none"> <li>- The power cord is not secured into the socket</li> <li>- Not switched ON</li> <li>- The fuse is blown</li> </ul>	<ul style="list-style-type: none"> <li>- Insert the power plug properly into the power socket</li> <li>- Turn on the switch found on chair side. Then push power button on remote</li> <li>- Replace only with a fuse of same type and rating</li> </ul>
3	No music comes from the speaker	The volume is turned to the lowest setting	Adjust the speaker volume from the mobile device. Make sure Bluetooth setting on chair and phone are both ON
4	Backrest or footrest can not raise or recline	Excessive load has been pressed on the backrest or legrest	Reduce the load and try again
5	Airbag malfunction	The air hose is blocked	Straight the air hose and clearout the blockage
6	Nature sounds are not playing	Bluetooth is OFF	Make sure Bluetooth is set to ON

If problem remains, please contact Infinity for maintenance.

**Tip:** Do not attempt to repair this product yourself, our company shall not be liable for the injury or damage caused by any servicing without authorizations. Thank you for your cooperation

## Frequently Asked Questions

### **Q: I find the chair is too intense to be comfortable. What can I do?**

**A:** Your body needs to become acclimated to therapeutic massage. To be effective, the massage techniques must compress the tissue in your body. We recommend the following steps to help get started. Then over time as your body acclimates you can increase the intensity by reducing the layers between you and the chair.

1. Use the body pillow and pillow pad to reduce upper body intensity
2. Use the back pad that came with your chair to reduce back intensity
3. Use the foot bed pads that came with your chair
4. Go into Airbag on the main menu, select air intensity setting 1
  - If a specific airbag is too intense, turn off Full and turn only the airbags you want
5. Press the foot roller button until you feel the foot rollers turn off
6. Adjust the recline on the remote. More upright will be less intense. Zero Gravity will be more intense

### **Q: I'm not a foot massage person, what should I do?**

**A:** Turn off foot rollers, press the Foot Roller button on your remote control until the rollers stop. You may also want to turn off the Foot/Calf airbags or reduce the air intensity to level 1. Finally make sure the foot pads are inserted into the foot beds on the foot rest.

### **Q: My chair is not performing as expected. What should I do?**

**A:** Your Infinity massage chair is an amazing combination of programming and robotics. On occasion the chair just may need to be rebooted. To do this power down the chair and unplug from the wall for 5 minutes then plug back in and power back up to see if it self-healed. If you are still having an issue, give Infinity a call at 603-910-5000.

### **Q: Nature sounds are not working on my chair**

**A:** Go to Bluetooth under Settings and make sure it is set to On. Then go to Volume under Sounds and make sure it is not set on OFF, 1 or 2.

### **Q: I can never seem to get in my Infinity Massage chair, someone is always in it.**

**A:** We know. It happens. Tell your friends to get their own Infinity Chair.

For more information and access to further questions, and resources, visit our website at [www.infinitymassagechairs.com](http://www.infinitymassagechairs.com)

# INFINITY®

72 Stard Road, Seabrook, NH  
03874

(603) 910-5000

[www.infinitymassagechairs.com](http://www.infinitymassagechairs.com)

Version 2.7