

**KYOTA**<sup>®</sup>

The World's Most  
Advanced Massage Chairs<sup>®</sup>

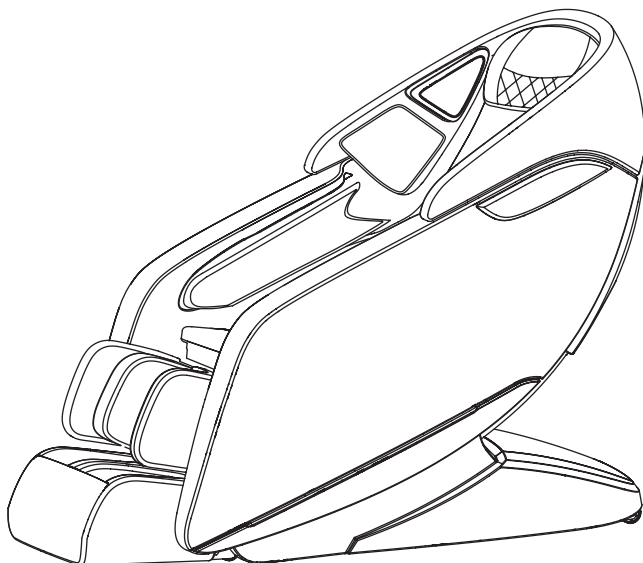

# User Manual

# Genki M380 Massage Chair

# Staying Safe

## Important Safety Instructions

### Read all instructions before using this appliance.

When using and electrical appliance, basic precautions should always be followed, including the following:

### **DANGER** – To reduce the risk of electric shock:

1) Always unplug this appliance from the electrical outlet immediately after using and before cleaning.

### **WARNING** – To reduce the risk of burns, fire, electric shock, or injury to persons:

- 1) An appliance should never be left unattended when plugged in. Unplug from outlet when not in use, and before putting on or taking off parts.
- 2) Do not operate under blanket or pillow. Excessive heating can occur and cause fire, electric shock, or injury to persons.
- 3) Close supervision is necessary when this appliance is used by, on, or near children, invalids, or disabled persons.
- 4) Use this appliance only for its intended use as described in this manual. Do not use attachments not recommended by the manufacturer.
- 5) Never operate this appliance if it has a damaged cord or plug, if it is not working properly, if it has been dropped or damaged, or dropped into water. Return the appliance to a service center for examination and repair.
- 6) Do not carry this appliance by supply cord or use cord as a handle.
- 7) Keep the cord away from heated surfaces.
- 8) Never operate the appliance with the air openings blocked. Keep the air openings free of lint, hair, and the like.
- 9) Never drop or insert any object into any opening.
- 10) Do not use outdoors.
- 11) Do not operate where aerosol (spray) products are being used or where oxygen is being administered.
- 12) To disconnect, turn all controls to the off position, then remove plug from outlet.
- 13) Use heated surfaces carefully. May cause serious burns. Do not use over insensitive skin areas or in the presence of poor circulation. The unattended use of heat by children or incapacitated persons may be dangerous.
- 14) Do not stand on or in appliance. Use only while seated.
- 15) Keep children away from extended foot support (or other similar parts).
- 16) Connect this appliance to a properly grounded outlet only. See Grounding Instructions.
- 17) Do not use this massage chair in close proximity to loose clothing or jewelry.
- 18) Keep long hair away from massager while in use.

## SAVE THESE INSTRUCTIONS.

### Not Suitable For Below Persons

We recommend those with any of the following conditions consult your physician before using.

- Those who are using electronic medical instruments embedded in the body, such as a cardiac pacemaker.
- Those undergoing treatment, especially those who are not feeling well.
- Those with malignant tumors or malignant abscesses. (Need to be supervised)
- Women who are pregnant.
- Those with osteoporosis or a fractured spine.
- Those with skin diseases or those with skin injuries.
- Those with a high fever.
- This appliance can be used by children aged 8 years and above and persons with reduced physical, sensory, or mental capabilities, or lack of experience and knowledge, if they have been given supervision or instruction concerning the use of the appliance in a safe way and understand the hazards involved.
- Children shall not play with the appliance.
- Cleaning and user maintenance shall not be made by children without supervision.



### Best Circumstances

- Do not use this appliance when ambient temperature is over 40 C.
- Women who are pregnant should not use this chair.
- Do not use this appliance in humid or dusty environment, or when any part of the body is in contact with plumbing or any similar ground.
- Please place the product on a flat level floor.
- Do not store near heat or open flame.



## Control Buttons Precautions



- Do not operate the control buttons with wet hands.
- Do not spill water or other liquids onto the control buttons to avoid fault.
- Do not lay heavy objects on the controller.

## Cautions Regarding the Adapters and Cord



- Always unplug this appliance from the electrical outlet immediately after using and before cleaning.
- An appliance should never be left unattended when plugged in. Unplug from outlet when not in use.
- Unplug from outlet during thunder or lightening storms, and before putting on or taking off parts.
- Check that the power voltage stated on the rating label corresponds to your local electricity supply.
- Do not use a damp hand to unplug the cord to avoid electric shock
- Do not drag the cord, reach to the front plastic end to unplug it.
- Do not squeeze, over bend, pull hard, or twist the cord.
- To disconnect, turn all controls to the off position, then remove plug from outlet
- The appliance is only to be used with the power supply unit provided with the appliance.
- It must only be supplied at safety extra low voltage corresponding to the marking on the appliance.
- If the supply cord is damaged, it must be replaced by the manufacturer or its service agent or a similarly qualified person in order to avoid a hazard.

## Best Practices for Safe Use



- Only for users who weigh below 300 lbs.
- Appliance should only be used by one person, do not use by two or more persons at the same time to avoid damage to the product.
- Do not use the product right after a meal, it may cause discomfort.
- Check the upholstery under the cushions and other spots, if any damages are present, do not use it and refer to a qualified service professional for servicing.
- If you feel any abnormal discomfort during the operation of this product, turn off the power immediately and do not use the product.
- Use of the appliance for 20 minutes each time is highly recommended.
- Make sure there are no obstacles behind the chair and there is enough clearance before adjusting the backrest or legrest angle.
- Make sure there is no other excessive load pressed on the backrest or legrest besides the user.
- Make sure there are no children, pets or other objects under the backrest or legrest.
- Please be seated properly while using the product.
- Do not drag or push the chair or roll on its caster on wood floor or carpet to avoid damage
- Do not fall asleep while the product is operating.
- Avoid using the product under the influence of alcohol.
- If there is any smoke or unusual smell while using, stop using immediately, and unplug the power cord.
- Do not disassemble this product yourself to avoid failure.
- Do not dismantle, fix or modify the product yourself. Please contact authorized dealer or service agent.

## Grounding Instructions

This product must be grounded. If it should malfunction or breakdown, grounding provides a path of least resistance for electric current to reduce the risk of electric shock. This product is equipped with a cord having an equipment-grounding conductor and a grounding plug. The plug must be plugged into an appropriate outlet that is properly installed and grounded in accordance with all local codes and ordinances.

**DANGER** - Improper connection of the equipment-grounding conductor can result in a risk of electric shock. Check with a qualified electrician or serviceman if you are in doubt as to whether the product is properly grounded. Do not modify the plug provided with the product - if it will not fit the outlet, have a proper outlet installed by a qualified electrician.

This product is for use on a nominal 120-V circuit and has a grounding plug that looks like the plug illustrated. Make sure that the product is connected to an outlet having the same configuration as the plug. No adapter should be used with this product.

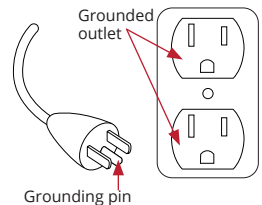

# Your Chair

## External Structure

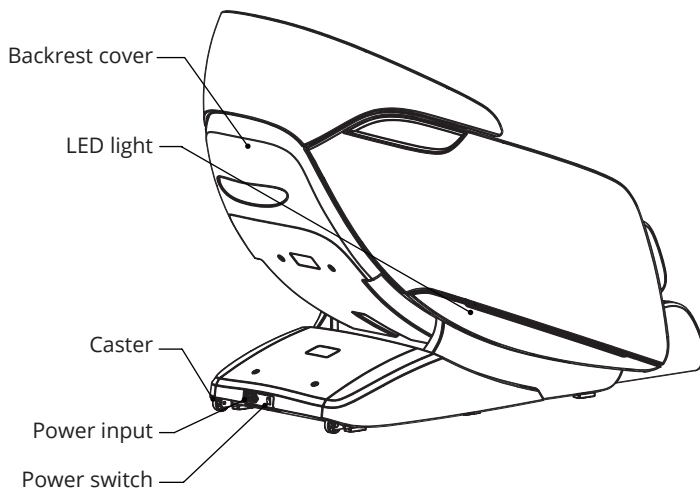

## Remote Control

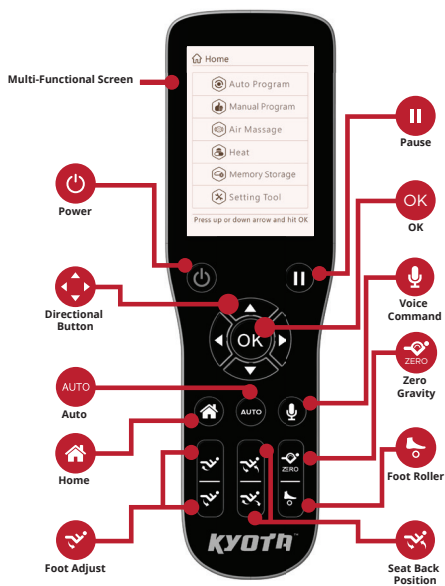

Welcome to

# KYOTA<sup>®</sup>

Thank you, and congratulations on purchasing your very own Kyota Massage Chair product - you've made a great buying decision. Welcome to the Kyota family.

Inside this manual, you will find everything you need to setup and safely enjoy your chair. Please review the entire manual before assembling or using your chair. If you are assembling the chair yourself, please see the Assembly Guide next and reference the online assembly video.

For convenience, we've also created a Quick Start Guide. We suggest you keep it in the remote pocket as a tool to get to know all the features of your new chair.

**Sit back, relax, and enjoy your new Kyota massage chair!**

## Warranty Registration

Register your product at [www.kyotamassagechairs.com/warranty/registration](http://www.kyotamassagechairs.com/warranty/registration) to ensure it is in our system. This will simplify the warranty process should you ever need it.

Alternatively, **scan the QR code** to go directly to the URL above.



SCAN CODE

## Assembly Video

Before assembling your chair, watch an assembly video at: [www.kyotamassagechairs.com/assembly-tutorials](http://www.kyotamassagechairs.com/assembly-tutorials)

Alternatively, **scan the QR code** to go directly to the URL above.



SCAN CODE

# Chair Features

- **43" L-Track**
- **Zero Gravity**
- **Zero Wall Space-saving Technology**
- **Calf Rollers & Oscillation**
- **Bluetooth Technology**
- **Decompression Stretch**
- **Reflexology**
- **Automatic Footrest Extension**
- **USB Charging Port**
- **Lumbar Heat**
- **Body Scanning**
- **Four Wheel Massage Mechanism**
- **Airbag Compression Therapy**
- **Intelligent Voice Control**
- **Massage Program Memory Storage**

# Table of Contents

<b>Staying Safe</b>	2	<b>Settings</b>	
<b>Preparation</b>		Timer	18
Installation Site	8	LED Lights	18
Clearance Space for the Chair	8	Language	18
Floor Protection	8	Bluetooth Audio	19
Move Methods	9	Remote Control Beep	19
Connect to Power	9	Remote Control Screen Idle	19
<b>Chair Setup</b>		<b>Create a Massage</b>	
Main Power Switch	10	Manual Programs	20
Adjust Pillow	10	Massage Mode	20
Body Scanning	11	Massage Position	20
Reduce the Intensity of your Massage - Manually	11	Massage Speed	21
Getting out of the Chair	11	Massage Width	21
		Foot Rollers	21
		Calf Rollers	21
<b>Getting Started</b>		<b>Fixing Issues</b>	
Auto Programs	12	Troubleshooting	22
Airbag Massage	14	FCC Information	22
Airbag Region	14	Frequently Asked Question	23
Airbag Intensity	14	Specifications	23
Back Heat	15		
Foot Rollers	15		
Calf Rollers	15		
Intelligent Voice Control	16		
Program Memory Storage	17		
USB Charging Port	17		

# Preparation

## Installation Site

### Clearance Space for the Chair

- 2" clearance for the recline of the backrest; 14" clearance for the extension of footrest and sliding forward of the chair.
- Keep it 3 feet away from the TV, radio or other audio & video appliance to avoid signal interference.

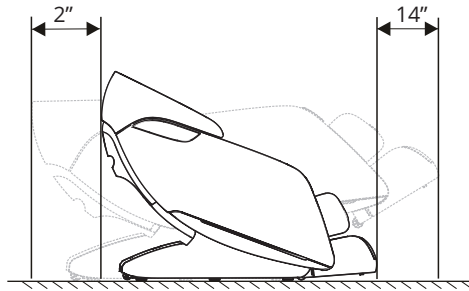

- Keep the distance between the power socket and power switch within 60" to avoid damage of power cord while massage chair sliding forward.
- Straighten the power cord while in use to avoid tangle or damage.
- When the massage chair sliding forwards or back, please check to make sure there is no children, pets or other obstacles around to avoid accident.

## Floor Protection

We recommend to place a piece of thin carpet or soft mat underneath it to avoid damaging the floor.

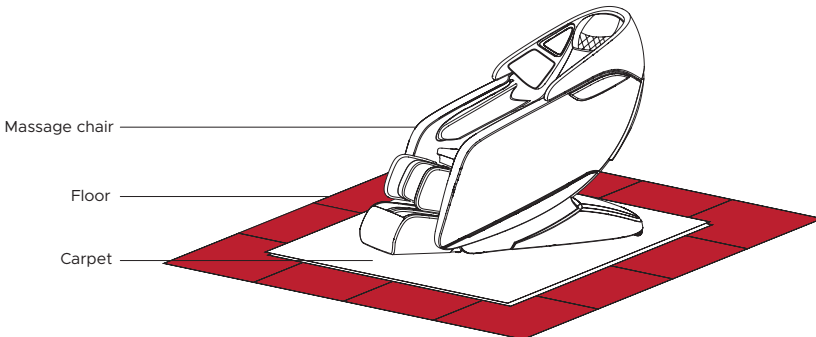

- Do not use the massage chair in high moisture environment such as near swimming pool or bathroom to prevent electric shock accident.
- Please keep the massage chair away from heated surfaces to prevent fire hazard or damage to the product.



## Move Methods

- Apply pressure to the back of the massage chair from behind to pivot on the Castors. Have a second person up front to guide the Footrest until in the correct position. Maintain clearances as mentioned above. Gently lower into place. Do not pull on the side arms.

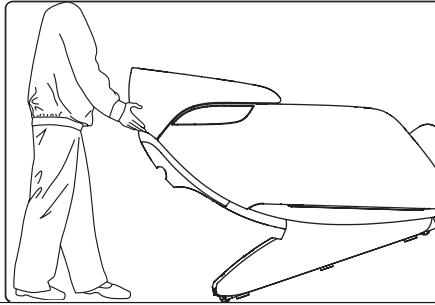

- Do not move the chair when there is a user inside.
- To carry this product, do not lift by the footrest or armrest, hold the chassis and steady the backrest (have 4 or more people to carry the product).

## Connect to Power

Plug into a 110V grounded outlet.

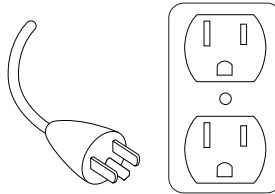

This product must be grounded. If it should malfunction or breakdown, grounding provides a path of least resistance for electric current to reduce the risk of electric shock. This product is equipped with a cord having an equipment-grounding conductor and a grounding plug. The plug must be plugged into an appropriate outlet that is properly installed and grounded in accordance with all local codes and ordinances.



- Ensure there is no damage to the supply cord before switching on the massage chair.
- Ensure that the main power switch is turned off before connecting to power

# Chair Setup

## Getting Comfortable

### Main Power Switch

To power up the chair, flick the main power switch located on the back of the base of the chair to **ON**.

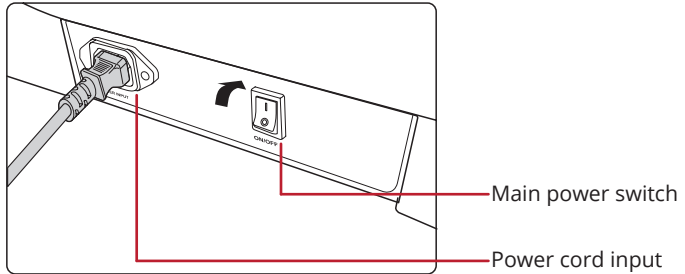

- Children should be supervised to ensure that they do not play with the chair or touch the power box.
- Always unplug the massage chair from the electrical outlet immediately after use.
- Unplug from outlet during thunder or lightening storms, and before putting on or taking off parts.
- Turn off the power switch and unplug the massage chair from the electrical outlet while not in use to avoid children power on the massage chair accidentally.
- When not in use for a long period of time, we recommend that the chair be covered, the power cord be coiled and that the unit be placed in an environment free of dust and moisture.

### Adjust Pillow

Take a seat in the chair and take note of where the neck pillow rests on your neck. Adjust the pillow so that it rests comfortably in the arch of your neck. Do this by removing it from the velcro, aligning it, and then reattaching to the velcro once it is in the desired position.

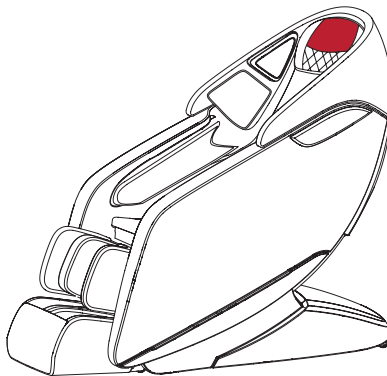

## Body Scanning

Select any auto program and press the **OK** button. The chair will automatically begin scanning your body, mapping your back, shoulders, and neck. During this process it is important to remain seated back into the chair without lifting your head.

The scan can be viewed on the remote control screen. If fine tuning is needed just after your body scan, wait for the **shoulder adjust prompt** to appear and then use the **Back Adjustment** buttons to move the massage rollers up or down for the perfect shoulder kneading position.

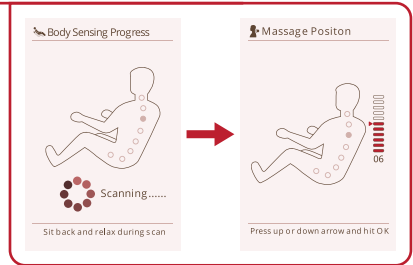

## Reduce the Intensity of your Massage - Manually

To make the massage less intense, you can **add the back pad** to the seat back of your chair, or you can also **fold down the neck rest** to provide more cushioning between you and the massage mechanism in the seat back. To make the foot rollers less intense, insert the foot pads that came with your chair into the foot bed of the footrest.

## Getting out of the Chair

To easily exit the chair, press the **power** button on the remote control to restore the chair to the upright position.



# Getting Started

## Auto Programs

When massage chair is operating, press the **AUTO** button on the remote control to enter Auto Program Menu. Choose from **Quick, Full Body, Rest & Relax, Recharge, Recovery, Stretch, Neck & Shoulder, Back Relief, Lower Body, Stress Relief, Renew, and Athlete**. Press **OK** to enter the program you desire. Selected program will show on the home screen.

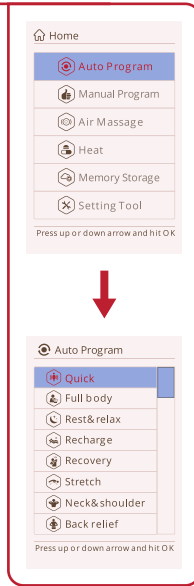

## Navigating the remote

*To show the Auto Programs list:* Use the directional buttons to highlight **AUTO PROGRAM** from Home display, press **OK** button to select. Press up or down button to navigate amongst the 12 auto programs.

*To select an auto program:* Use the up and down directional buttons to highlight the program you wish to run. Press **OK** button to select and begin program.



## Programs

## Icon

**Quick**



**Full Body**



**Rest & Relax**



**Recharge**



**Recovery**



**Stretch**



**Neck & Shoulder**



**Back Relief**



**Lower Body**



**Stress Relief**



**Renew**



**Athlete**



## What for?

## Description

A quick way to feel all the massage techniques and chair movements in a brief 8 minute session.

Rapid demonstration of all massage techniques and chair motions.

This program is the best choice to relax tired muscles and increase physical vigor.

Comprehensive massage session using deep tissue kneading, and tapping.

Best for winding down and re-energizing yourself after a long day.

Inspired by Thai massage. This strong kneading and shiatsu massage effectively decompresses the entire body.

Recharge and re-vitalize your tired muscles after physical exertion.

Uses moderate pressure to decrease recovery time after physical exertion, relieve the body of stress and improve circulation.

Helps to relax and recover the main back muscles along your spine.

Assists in relieving lower and upper back pain through a series of massage techniques.

Designed for morning or midday relaxing.

Yoga like stretching motions combined with deep shiatsu massage helps to boost the vitality of muscles.

Soothing pain and tension in the neck and shoulders.

A sequence of neck, shoulder, and upper back massage techniques.

This program is recommended to relieve lower back pain.

Focuses on the lumbar vertebra with targeted kneading and tapping massage to relieve tension.

Alleviate tension in the lower half of the body.

Targets the lower back, buttocks and feet.

Reduce built up tension carried in the body from everyday stress.

Designed to help minimize stress carried in the neck, shoulders, lower back, and feet.

Relieving lower and upper back pain.

Assists in relieving lower and upper back pain through focused kneading of the hip area.

Try this program after sports activities and exercise.

Featuring neck, back, and waist kneading this massage relaxes muscles, improves circulation and aids in recovery.

# Getting Started

## Airbag Massage

Select **AIR MESSAGE** from Home display, press up or down button to navigate among: **POSITION** and **INTENSITY**.

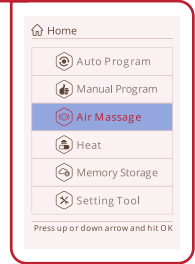

## Airbag Region

Navigate to **POSITION**, press right button, then use the up or down button to select your desired airbag region: Full Body, Upper Body, or Lower Body. Press **OK** button to select the airbag region.

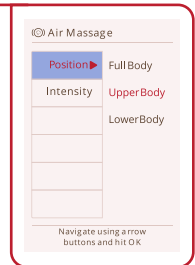

## Airbag Intensity

Navigate to **INTENSITY**, press right button, then use the up or down button to select your desired intensity: 1 = light, 2, 3, 4 = firm, or Off. Press **OK** button to select the airbag intensity.



## Back Heat

Select **HEAT** from Home display, press right button, then press up or down button to navigate to desired heat level: 1 = low, 2, 3 = high, or OFF. Press **OK** button to select the heat level.

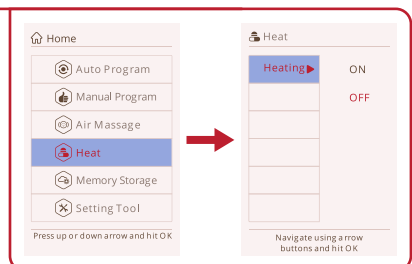

## Foot Rollers

Select **MANUAL PROGRAM** from Home display, press right button, then use the up or down button to navigate to **FOOT ROLLERS**. Press right button, then use the up and down buttons to select your desired foot roller speed: 1 = slow, 2, 3 = fast, or Off (deactivate foot roller). Press **OK** button to select the speed level you desire.

Alternatively, press the **Foot Roller button** on your remote control. Pressing this button will turn off Foot rollers, press again to also turn off Calf rollers, press again to resume both. Your current foot roller speed is displayed in the in-use screen in the top left corner.

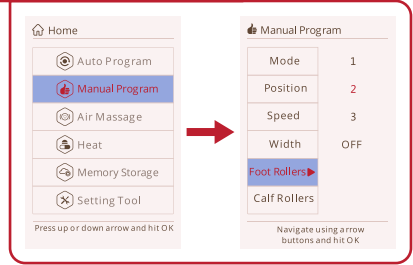

## Calf Rollers

Select **MANUAL PROGRAM** from Home display, press right button, then use the up or down button to navigate to **CALF ROLLERS**. Press right button, then use the up and down buttons to select your desired calf roller speed: 1 = slow, 2, 3 = fast, or Off (deactivate foot roller). Press **OK** button to select the speed level you desire.

Alternatively, press the **Foot Roller button** on your remote control. Pressing this button will turn off Foot rollers, press again to also turn off Calf rollers, press again to resume both. Your current foot roller speed is displayed in the in-use screen in the top left corner.

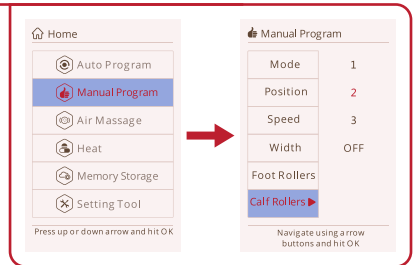

# Getting Started

## Intelligent Voice Control

Your chair comes with built in intelligent voice control. This feature allows you to control your chair and massage experience completely hands-free by using one of the many voice commands. Voice Control will only work when the chair is powered on and active or within 20 minutes of an auto program ending.

To activate the intelligent voice control function, simply say **'Hey Kyota'**, pronounced **'Key-oh-ta'**, or press the voice control button on the remote control. You may now give your chair any of the commands below **within 6 seconds**. Make sure to speak clearly and slowly. After 6 seconds the Intelligent Voice Command function will turn off automatically and must be awakened again.

You can also activate intelligent voice control by using the remote control. Press the **Voice Command button** on your remote control, once to awaken Voice Command, or hold down for 4 seconds to turn off voice control listening.



## Turn Off Listening

At any time, Simply **press and hold the Voice Command button** for 4 seconds then release. Turn back on by pressing the Voice Command button again.

## Commands

"Quick"	"Lower Body"
"Full Body"	"Stress Relief"
"Rest and Relax"	"Renew"
"Recharge"	"Athlete"
"Recovery"	"Turn Chair OFF"
"Stretch"	
"Neck & Shoulder"	
"Back Relief"	

## Manual Commands

"Change to Point Mode"
"Go a Little Down"
"Go a Little Up"



## Program Memory Storage

Your chair has the ability to save your favorite customized massage programs to memory.

To create a custom memory setting you first need to set up the chair for what it is you want to record. To do this, create a manual massage program with all of your desired air, heat, speed, and intensity settings.

To save a massage program, select **MEMORY STORAGE** from Home Display, press up or down button to navigate to: Memory 1, Memory 2 or Memory 3. Press right button, then press **OK** button to save the current massage settings to memory.

Once a memory program is saved it will show Saved in Red. If you hit save in a position with a program already saved, it will record over the previous setting. To run a memory program, select that program from the bottom of the Auto Programs Menu.

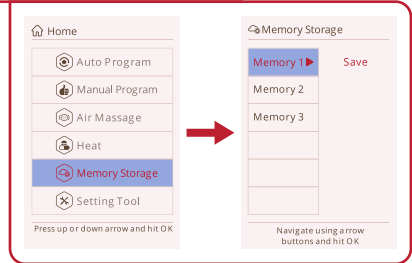

## USB Charging Port

Another feature of your chair is an in-built USB port for charging your devices. The USB charging port can be found on the left hand side of the seat opposite the remote cord.

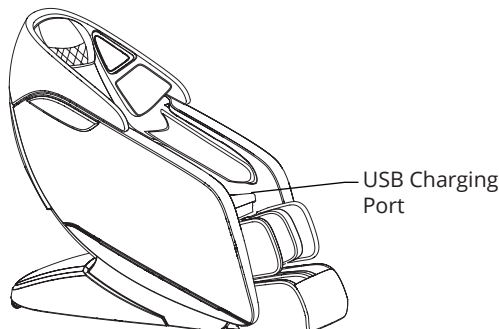

# Settings

## Setting Tool

Select **SETTING TOOL** from Home display, then use the up or down button to toggle between **TIMER**, **LANGUAGE**, **BLUETOOTH**, or **BEEP**.

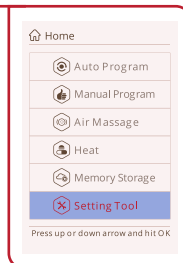

## Timer

Navigate to **TIMER**, press right button, then press up or down button to select your desired timer: 10 minutes, 20 minutes, or 30 minutes. Press **OK** to select your desired massage timer length. 20 minutes is the default setting.

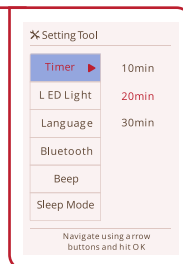

## LED Lights

Navigate to **LED LIGHT**, press right button then press up or down button to select your desired LED light setting: On or Off. Press **OK** to select LED light setting.

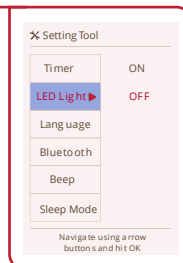

## Language

Navigate to **LANGUAGE**, press right button, then use the up or down button to select your desired language: ENGLISH, CHINESE, VIETNAMESE, or KOREAN. Press **OK** button to select language.



## Bluetooth Audio

Your massage chair includes Bluetooth compatibility so you can play and enjoy your favorite music. To turn on your chair's Bluetooth, navigate to **BLUETOOTH**, press right button, then press up or down button to select your desired Bluetooth setting: On or Off. Press **OK** button to select Bluetooth setting.

Open Bluetooth from audio device and pair with **M380 Genki** to play music.

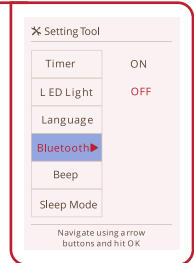

## Remote Control Beep

Navigate to **BEEP**, press beep button, then use the up or down button to select your desired remote control beep function: On or Off. Press **OK** button to select beep function.

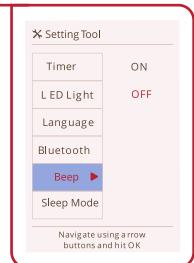

## Remote Control Screen Idle

Whilst running an Auto Program or Manual mode, the remote control screen will return to the in-use screen (as shown below) **after 10 seconds of being idle**.

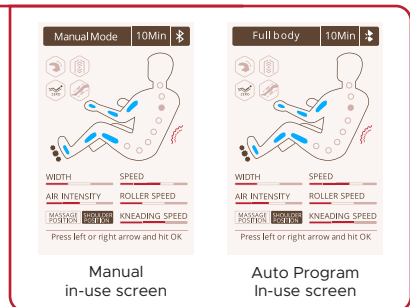

- Please do not spill water or other liquids in order to avoid key malfunctions and error codes.
- Please do not place heavy objects on the controller or power cord.

# Create a Massage

## Manual Programs

Select **MANUAL PROGRAM** from Home display, press up or down button to navigate among: **MODE**, **POSITION**, **SPEED**, **WIDTH**, **FOOT ROLLERS**, and **CALF ROLLERS**.

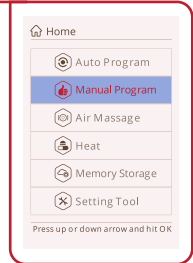

## Massage Mode

Navigate to **MODE**, press right button, then use the up or down button to select your desired mode: 360° Knead, Clockwise Knead, Counter-Clockwise Knead, Upper Knead, Lower Knead, Tap, Knead&Tap, Shiatsu, and Knock. Press **OK** button to select mode.

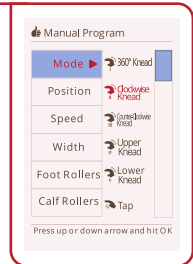

## Massage Position

Navigate to **POSITION**, press right button, then use the up or down button to select your desired massage position: Full, Upper, Lower, Partial, and Spot. Press **OK** button to select position.

**Full** travels the entire length of the massage track.

**Upper** travels from the neck down to lumbar.

**Lower** travels along the lumbar and glutes.

**Partial** travels a few inches above and below the current position.

**Spot** stops the massage mechanism in current position.

Partial and Point location can be fine tuned using the arrow up or arrow down buttons.

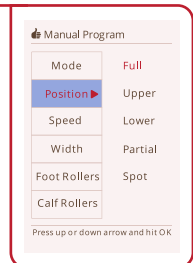

## Massage Speed

Navigate to **SPEED**, press right button, then use the up or down button to select your desired speed: 1 = slowest, 2, 3, 4, 5 = fastest. Press **OK** button to select the speed. (Massage speed can only be adjusted when in manual mode).



## Massage Width

Navigate to **WIDTH**, press right button, then use the up or down button to select your desired roller width: Wide, Medium, or Narrow. Press **OK** button to select width. (Massage Width only works in tap shiatsu and knock techniques).



## Foot Rollers

Navigate to **FOOT ROLLERS**, press right button, then use the up or down button to select your desired foot roller setting: 1 = slowest, 2, 3 = fastest, or Off (deactivate foot rollers). Press **OK** button to select the foot roller setting.



## Calf Rollers

Navigate to **CALF ROLLERS**, press right button, then use the up or down button to select your desired calf roller setting: 1 = slowest, 2, 3 = fastest, or Off (deactivate calf rollers). Press **OK** button to select the calf roller setting.



# Fixing Issues

## Trouble Shooting

Symptoms	Possible Causes	Possible Solution
Noise is heard while in use	These noises are normal and arise from friction between the massage rollers and the leather cover	No need to take any measures
Massage Chair does not start	The power cord is not secured into the socket Not switched ON The fuse is blown	Insert the power plug properly into the power socket Turn on the switch found on chair side. Then push power button on remote Replace only with a fuse of same type and rating
No music comes from the speaker	The volume is turned to the lowest setting	Adjust the speaker volume from the mobile device. Make sure Bluetooth setting on chair and phone are both ON
Backrest or footrest can not raise or recline	Excessive load has been pressed on the backrest or legrest	Replace the load and try again
Airbag malfunction	The air hose is blocked	Straight the air hose and clear out the blockage
Pause and Chair Adjustment Buttons are disabled	Chair is in the Demo Program	Exit the Demo by selecting another program, or by hitting the power button.

## FCC Information

This device complies with part 15 of the FCC Rules. Operation is subject to the following two conditions: (1) This device may not cause harmful interference, and (2) this device must accept any interference received, including interference that may cause undesired operation. Changes or modifications not expressly approved by the party responsible for compliance could void the user's authority to operate this device.

**NOTE:** This equipment has been tested and found to comply with the limits for a Class B digital device, pursuant to part 15 of the FCC Rules. These limits are designed to provide reasonable protection against harmful interference in a residential installation. This equipment generates, uses, and can radiate radio frequency energy and, if not installed and used in accordance with the instructions, may cause harmful interference to radio communications, however, there is no guarantee that interference will not occur in a particular installation. If this equipment does cause harmful interference to radio or television reception, which can be determined by turning the equipment off and on, the user is encouraged to try to correct the interference by one or more of the following measures:

- Reorient or relocate the receiving antenna.
- Increase the separation between the equipment and receiver.
- Connect the equipment into an outlet on a circuit different from that to which the receiver is connected.
- Consult the dealer or an experienced radio/TV technician for help.

## Frequently Asked Questions

### Q: I find the chair is too intense to be comfortable. What can I do?

**A:** Your body needs to become acclimated to therapeutic massage. To be effective, the massage techniques must compress the tissue in your body. We recommend the following steps to help get started. Then over time as your body acclimates you can increase the intensity by reducing the layers between you and the chair.

1. Use body the Pillow and Pillow pad to reduce upper body intensity
2. Go into Airbag on the main menu, select air intensity setting 1
  - If a specific airbag is too intense, turn off Full and turn only the airbags you want
3. Press the foot roller button until you feel the foot rollers turn off
4. Adjust the recline on the remote. More upright will be less intense. Zero Gravity will be more intense

### Q: I'm not a foot massage person, what should I do?

**A:** Turn off foot rollers, press the **Foot Roller button** on your remote control until the rollers stop. You may also want to turn off the Foot/Calf airbags or reduce the air intensity to level 1.

### Q: My chair is not performing as expected. What should I do?

**A:** Your Kyota massage chair is an amazing combination of programming and robotics. On occasion the chair just may need to be rebooted. To do this power down the chair and unplug from the wall for 5 minutes then plug back in and power back up to see if it self-healed. If you are still having an issue, give Kyota a call at 800-242-0761.

## Specifications

<b>Model</b>	Genki M380
<b>Dimension of Main Body (in)</b>	53 x 29.5 x 45 (L x W x H)
<b>Necessary Clearance to Wall (in)</b>	4"
<b>Net Weight (lbs)</b>	185
<b>Shipping Weight (lbs)</b>	367
<b>Max. User Weight (lbs)</b>	305
<b>Voltage</b>	120V
<b>Fuse</b>	1.25 AMP
<b>Power Consumption</b>	150W
<b>Safety Standards</b>	Type 1

**KYOTA**<sup>®</sup> | **The World's Most  
Advanced Massage Chairs**<sup>®</sup>

72 Stard Road, Seabrook, NH 03874

Toll Free #: (800) 242-0761

[www.kyotamassagechairs.com](http://www.kyotamassagechairs.com)

Version 1.7