

INFINITY[®]

MASSAGE CHAIRS



User Manual

SOLSTICE 4D

Welcome to

INFINITY®

THE ULTIMATE MESSAGE EXPERIENCE

Thank you and congratulations on purchasing an Infinity Massage Chair - you've made a great choice.

With over a decade of experience designing, building and servicing massage chairs, Infinity takes pride in every chair sold, including yours. We are here for you. The US-based Customer Care team can be reached at (603) 910-5000 or visit us online at www.infinitymassagechairs.com and find valuable self service resources under the SUPPORT tab, including electronic copies of all documents and video tutorials.

Inside this manual, you will find everything you need to setup and safely enjoy your chair. Please review the entire manual, including all safety information, before assembling or using your chair. If you are assembling the chair yourself, please see the Assembly Guide next and reference the online assembly video.

For convenience, we've also created a Quick Start Guide. We suggest you keep it in the remote pocket as a tool to get to know all the features of your new chair.

Get ready to sit back, relax and enjoy the Ultimate Massage Experience.

Warranty Registration

Register your product at www.infinitymassagechairs.com/warranty to ensure it is in our system. This will simplify the warranty process should you ever need it.

Alternatively, **scan the QR code** to go directly to the URL above.



SCAN CODE

Assembly Video

Before assembling your chair, watch an assembly video at:
www.infinitymassagechairs.com/assembly-tutorials

Alternatively, **scan the QR code** to go directly to the URL above.



SCAN CODE



We know you can't wait to sit in your new Infinity Massage chair! Take a picture of you enjoying the ultimate massage experience and make sure to tag us on social media with the hashtag [#infinitymassagechairs](https://www.instagram.com/explore/tags/infinitymassagechairs)

Table of Contents

Your Chair

Chair Features	5
External Structure	5

Before Getting Started

Installation Site	6
Clearance Space for the Chair	6
Floor Protection	6
Move Methods	7
Connect to Power	7

Chair Setup

Getting Comfortable	8
Main Power Switch	8
Adjust Pillow	8
Reduce the Intensity of Your Massage - Manually	8
Truefit™ Body Scanning	9
Getting Out Of The Chair	9
USB Charging Station	10

Chair Entry & Exit

Chair Entry and Exit Hazards	11
------------------------------	----

Taking Control

Remote Control Layout	12
Remote Control Operation	13
Auto Programs	14
Program Descriptions	15
Airbag Massage	16
Airbag Region	16
Airbag Intensity	16

Taking Control

Calf Heat	17
Foot Reflexology Rollers	17
Joystick Control	17

Settings

Language	18
Bluetooth Audio®	18
Power Save	19
Timer	19
Remote Control Screen Idle	19

Build Your Own

Manual Programs	20
Back Massage Technique Mode	20
Massage Part (Back Region)	20
Back Node Width	21
Massage Speed	21
Foot Reflexology Rollers	21
Weightless Zero Gravity Recline	21

Staying Safe

22

Fixing Issues











Trouble Shooting	25
Specifications	25
Frequently Asked Questions	26



Warning! Read important safety information found on page 22 before using or operating chair.

Your Chair

Chair Features

<p>4D Back Massage Mechanism</p>  <p>See page 6</p>	<p>Zero Wall Fit™ Space-Saving Technology</p>  <p>See page 6</p>	<p>Truefit™ Body Scanning</p>  <p>See page 9</p>	<p>USB Charging Station</p>  <p>See page 11</p>	<p>Calf Heat</p>  <p>See page 17</p>
<p>Foot Reflexology Rollers</p>  <p>See page 17 & 21</p>	<p>Joystick Control</p>  <p>See page 17</p>	<p>Bluetooth® Speakers</p>  <p>See page 18</p>	<p>Manual Massage Customization</p>  <p>See page 20</p>	<p>Weightless Zero Gravity Recline</p>  <p>See page 21</p>

External Structure

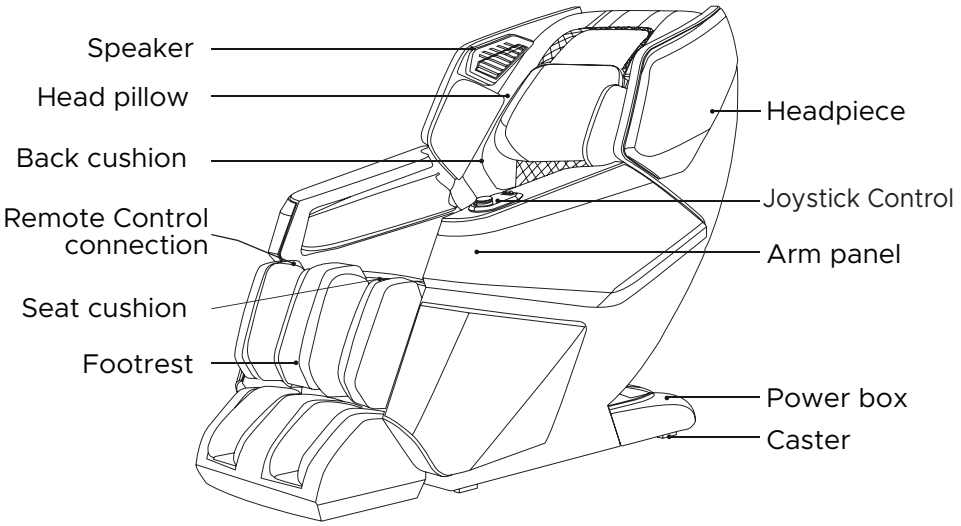

Before Getting Started

Installation Site

Clearance Space for the Chair

- 4" clearance for the recline of the backrest; 24" clearance for the extension of footrest and sliding forward of the chair.
- Keep it 3 feet away from the TV, radio or other audio & video appliance to avoid signal interference.

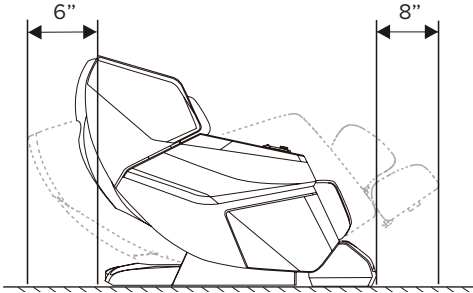

- Keep the distance between the power socket and power switch within 60" to avoid damage of power cord while massage chair sliding forward.
- Straighten the power cord while in use to avoid tangle or damage.



- To avoid serious injury or death, before sliding chair forward or backward check to make sure area is clear of children, pets, or obstacles.

Floor Protection

We recommend to place a piece of thin carpet or soft mat underneath it to avoid damaging the floor.

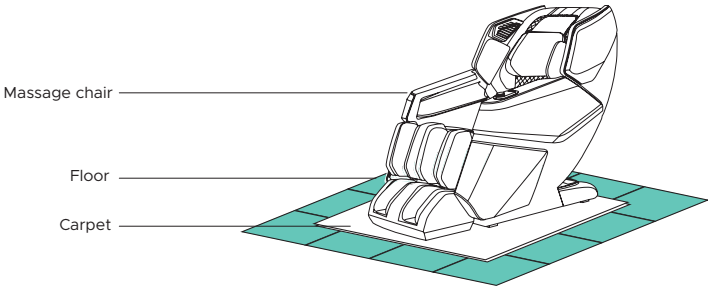

- Do not use the massage chair in high moisture environment such as near a swimming pool or bathroom to prevent electric shock accident.
- Please keep the massage chair away from heated surfaces to prevent fire hazard or damage to the product.

Move Methods

Apply pressure to the back of the massage chair from behind to pivot on the Castors. Have a second person up front to guide the Footrest until in the correct position. Maintain clearances as mentioned above. Gently lower into place. Do not pull on the side arms.

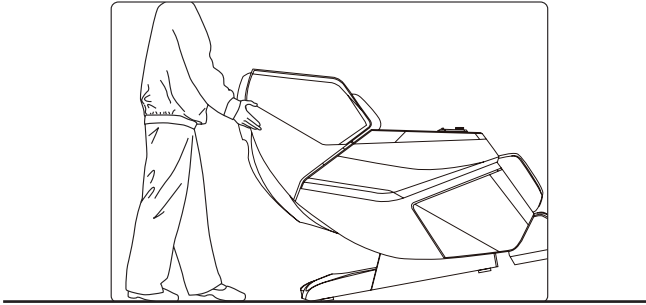

- Do not move the chair when there is user inside.
- Chair is heavy. Use caution and get assistance when lifting to avoid injury. Do NOT lift chair by footrest or armrests to avoid damage to product.

Connect to Power

Plug into a 110V grounded outlet.



WARNING

Grounding Instructions

To avoid risk of electrical shock, turn power switch off before plugging unit into electrical outlet. Use only with properly grounded outlet (3 prong). Do not plug into ungrounded outlet.

WARNING

– Improper connection of the equipment-grounding conductor can result in a risk of electric shock. Check with a qualified electrician or serviceman if you are in doubt as to whether the product is properly grounded. Do not modify the plug provided with the product – if it will not fit the outlet, have a proper outlet installed by a qualified electrician.

This product is for use on a nominal 120-V circuit and has a grounding plug that looks like the plug illustrated. Make sure that the product is connected to an outlet having the same configuration as the plug. No adapter should be used with this product.

Earthing

This massage chair is a Class 1 electrical appliance. Make sure to use a grounded outlet to the grounded power supply circuit and a properly installed earth grounding rod with ground connection, to avoid electric shock.

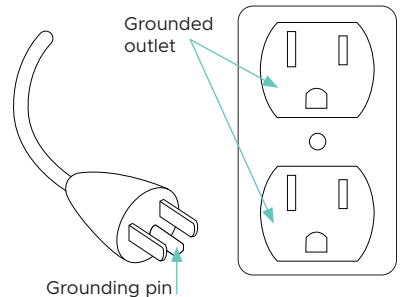

Chair Setup

Getting Comfortable

Main Power Switch

To power up the chair, flip the main power switch located on the side of the base of the chair to **ON**. Ensure the electrical cord is connected to a 110V grounded outlet and plugged into the power cord port located on the back of the base of the chair.

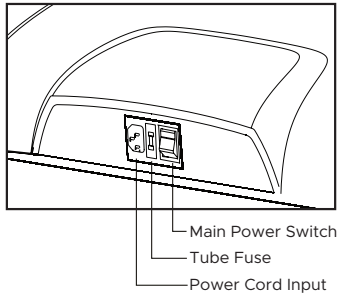

- To avoid possible damage to product or injury to unsupervised children, always turn off power switch and unplug massage chair from electrical outlet immediately after use.
- When not in use for a long period of time, we recommend that the chair be covered, the power cord be coiled and that the unit be placed in an environment free of dust and moisture.

Adjust Pillow

Take a seat in the chair and take note of where the neck pillow rests on your neck. Adjust the pillow so that it rests comfortably in the arch of your neck. Do this by removing it from the velcro, aligning it, and then reattaching to the velcro once it is in the desired position.

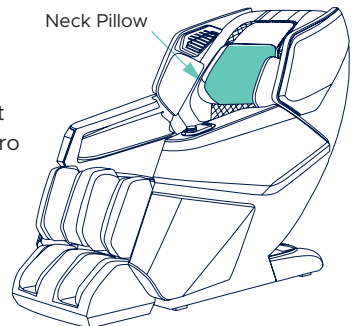

Reduce the Intensity of your Massage - Manually

To make the massage less intense, you can **add the back pad** to the seat back of your chair, or you can also **fold down the neck rest** to provide more cushioning between you and the massage mechanism in the seat back. To make the foot rollers less intense, insert the foot pads that came with your chair into the foot bed of the footrest.

Smart tip: To increase intensity in the neck and shoulder region, flip the pillow or the pillow and pillow pad up so you lay directly on the seat back pad.

Truefit™ Body Scanning

Select any auto program and press the **OK** button. The chair will automatically begin scanning your body, mapping your back, shoulders, and neck. During this process it is important to remain seated back into the chair without lifting your head.

The scan can be viewed on the remote control screen. If fine tuning is needed just after your body scan, wait for the **shoulder adjust prompt** to appear and then use the **Back Adjustment** buttons to move the massage rollers up or down for the perfect shoulder kneading position.

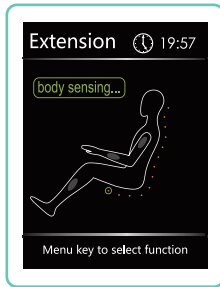

Body Scanning

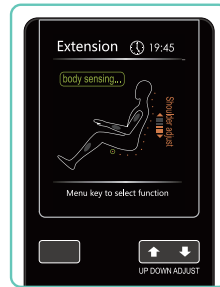

Shoulder Adjust Prompt

Getting out of the Chair

To easily exit the chair at any time, press the **ON/OFF** power button on the remote control to restore the chair to the upright position.

WARNING! Check to make sure children and pets are clear of chair **before** pressing on/off button to return chair to upright position. See next page for detailed hazard warnings.

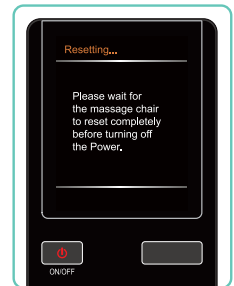

Chair Setup

USB Charging Station

Your massage chair includes a USB-A port to charge your phone or tablet while using the chair. This feature is especially helpful when using the app to control the chair.

The port is located on the left arm panel on the **Joystick Control**.

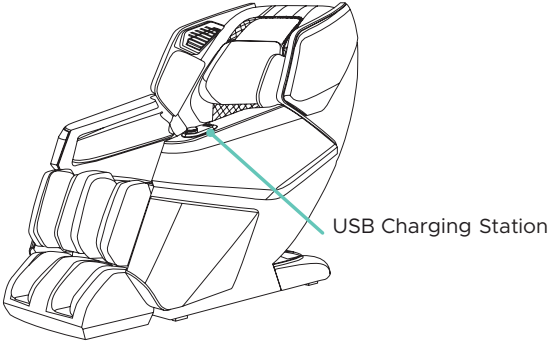

Chair Entry & Exit

Chair Entry and Exit Hazards

WARNING! The areas under the footrest and behind the back rest are potentially dangerous for a child or pet. The chair back is heavy and reclines with force. A small child or pet located behind the chair could be crushed as chair is reclined resulting in serious injury or death. When chair is reclined, small children or pets who have crawled under the leg rest may not be visible to the user and could be crushed when leg rest is lowered or when chair is returned to upright position. **To avoid serious injury or death, check these areas carefully before reclining, lowering leg rest, or returning chair to upright position.**

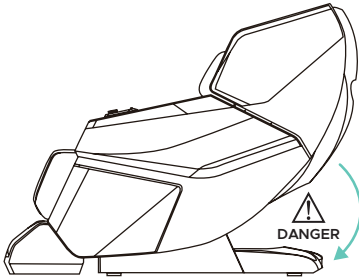

Make sure to check for children or pets **between the chair back and the base of the chair** before entering zero gravity recline.

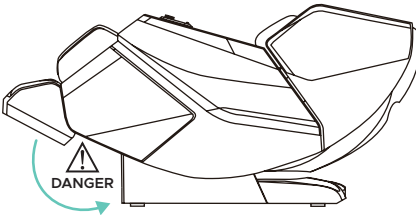

Make sure to check for children or pets **underneath the footwell** before exiting zero gravity recline and returning to upright position.

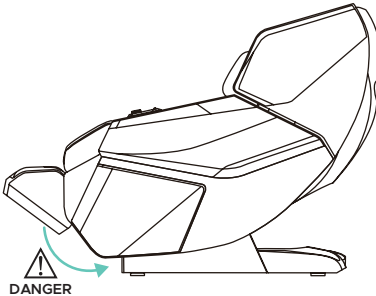

Make sure to check for children or pets **between the footrest and the chair body** before lowering the legrest.

Taking Control

Remote Control Layout

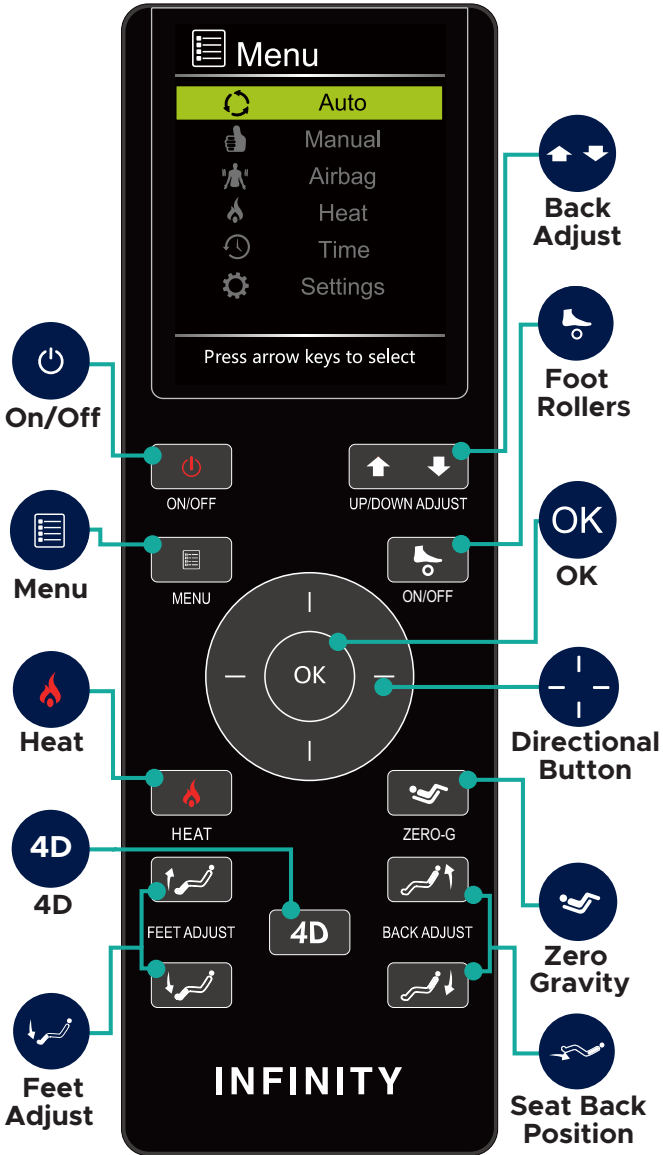

Remote Control Operation



On/Off – Powers up the remote or returns the chair to the exit position and powers down remote.



Menu – Shortcut to the home page of all menu screens.



Feet Adjust – Press and hold up arrow to bring foot rest up, press and hold down arrow to bring foot rest down.



4D – Press to increase or decrease 4D intensity of back mechanism. In-use screen displays intensity dial.



Heat – Press to turn On/Off calf heat function. The heat icon on display screen will indicate whether heat is turned on/off.



Back Adjust – Back mechanism position adjustment; press and hold up to raise, press and hold down to lower. Use during initial body scan fine tuning or in manual point zone mode.



Foot Rollers – Press this button to toggle the foot reflexology rollers on or off.



OK – After navigating to the command desired on the display, push OK to select. During the massage, press OK button to switch to zero gravity.



Directional Button – Press up, down, left or right to navigate the display screen. During the massage, press up or down buttons to adjust mechanism speed. Press left or right button to adjust airbag intensity.



Seat Back Position – Press and hold down arrow to recline the seat back, press and hold the up arrow to upright the seat back.



Zero Gravity – Press once for weightless zero gravity recline, press again to return to the upright position.

Taking Control

Auto Programs

When massage chair is operating, press the **AUTO** button on the remote control to enter Auto Program Menu. Choose from **Extension, Release, Full Body, Thai, Chinese, Post Workout, Vigor, Night, Calm, Neck & Shoulder, Waist & Glutes, or Back & Spine**. Press **OK** to enter the program you desire. Selected program will show on the home screen.

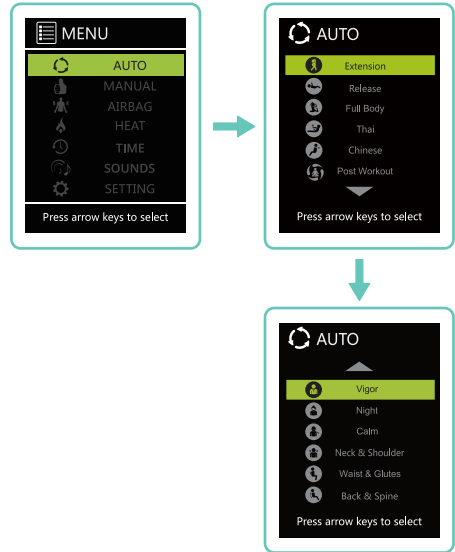

Program	What for?	Description
Extension	Best used to achieve a full body, deep stretching massage.	Targeted airbag compression provides a full body stretch while the double back-mechanism performs a combination of massage techniques to help awaken and ignite your muscles for the day ahead.
Release	Great for a quick midday break to relieve any built up morning stress.	A revitalizing massage that is ideal for a mid-day boost. Full body kneading relieves built up stress, reduces fatigue, and improves metabolism so you can finish your day off strong.
Full Body	Don't have time to leave the house for yoga? Try this massage to achieve a gentle stretch and relax your tired muscles.	Uses moderate kneading and stretching techniques to simulate the deep stretching of yoga movements and relax tired muscles after a long day .
Thai	This program is the best choice to re-energize stiff muscles and boost energy levels.	Inspired by traditional Thai massage techniques, this strong series of grab, hold and stretch progressions gently extends the body to help re-adjust the skeletal structure, increase flexibility, and re-balance your body's energy.
Chinese	Reduce built up tension carried in the body or unwinding after a stressful day.	Designed to clear the mind and increase blood circulation. Breathe in deeply and exhale your stress while this rhythmic massage program works to alleviate your tired muscles and reinvigorate your spirit.
Post Workout	This program is the best choice to re-energize tired muscles and reset your mind.	Performs a strong massage with deep, penetrating massage techniques to alleviate your aches and pains, improve circulation, and recuperate the body after intense physical activity.
Vigor	Best for those who prefer a more intense massage, and for soothing muscles after physical activity.	This program is designed to relax the body both physically and emotionally. A unique combination of varying intensities brings the mind into a peaceful state, while specific massage techniques increase circulation to help relieve muscular tension, and reduce recovery time.
Night	Try this program as you prepare your body to rest for the night.	A progression of mild massage techniques and chair movements brings harmony to your body. This program helps you unwind from a long day, and prepares you for a restful night's sleep.
Calm	Those looking for a softer, less intense massage.	As the lowest intensity massage, this series of massage techniques is perfect for those who are more sensitive, or looking for a light kneading motion on the back, waist and hips.
Neck & Shoulder	Soothing pain and tension in the neck and shoulders.	A powerful combination of kneading, grabbing, and pressing massage techniques target the neck, shoulder, and upper back to help ease unwanted pain and stiffness.
Waist & Glutes	Improve hip mobility and reduce lower back pain.	Designed to stimulate the waist, hips and buttock, this sequence of massage and air bag compression can help to improve your range of motion, and reduce lower back pain so you can return to your feet feeling renewed.
Back & Spine	Helps to relax, recover, and revitalize the main back muscles along your spine.	Designed to be an incredible injury prevention program, this massage focuses on the lumbar vertebra with targeted massage to loosen rigid muscles, relieve tension, improve circulation, and revitalize your energy levels.

Taking Control

Airbag Massage

Select **AIRBAG** from Home display, press up or down button to navigate among: **PART** and **FORCE**. Select by pressing **OK**.

PART allows you to select which airbags to use. Select Full for all airbags. Otherwise pick and choose amongst the other Parts to turn them on or off. You may select more than one Part. To turn off all Airbags, select any lit parts and hit **OK** to turn off. When no Parts are lit, all airbags are off.

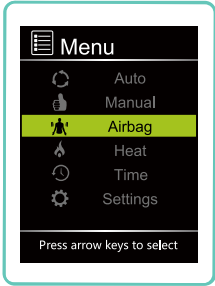

Airbag Region

Navigate to **PART**, press right button, then use the up or down button to select your desired airbag region: Full, Arm & Shoulder, Leg & Foot, Buttock. Press **OK** button to select the airbag region.

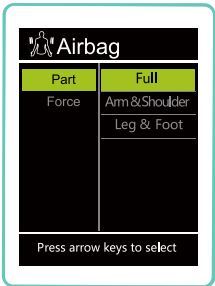

Airbag Intensity

Navigate to **FORCE**, press right button, then use the up or down button to select your desired intensity: 1 = light, 5 = firm, or Off. Press **OK** button to select the airbag intensity.

While the in-use screen is displayed during a massage program, press the **left** or **right directional button** to adjust the airbag intensity (this feature works in both Auto and Manual programs).

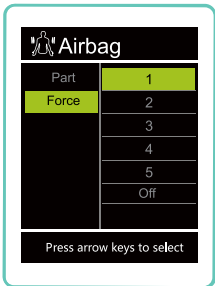

Smart tip: While the in-use screen is displayed during a massage program, press the **left** or **right directional button** to adjust the airbag intensity (this feature works in both Auto and Manual programs).

Calf Heat

Select **HEAT** from Home display, press right button, then press up or down button to navigate to desired heat setting: 1 = low, 2, 3 = high or Off. Press **OK** button to select the heat setting.

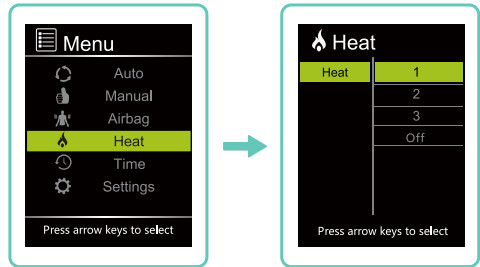

Foot Reflexology Rollers

Select **MANUAL** from Home display, then press up or down button to navigate to **ROLLER**. Press right button, then use the up and down buttons to select your desired foot roller speed: 1 = slow, 2, 3 = fast, or Off (deactivate foot rollers). Press **OK** button to select the foot roller setting.

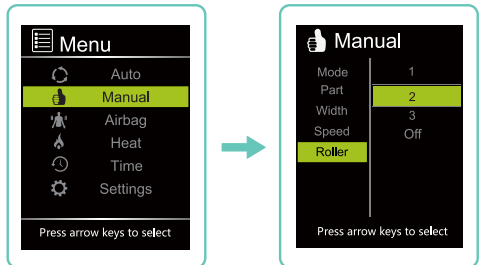

Joystick Control

As well as having a corded remote control, your chair also comes with a built in joystick controller which is located on the top of the left arm panel. The joystick controller allows you to turn the chair on and off, select from six of the auto program's, adjust the recline angle of the seat back, and charge your mobile device.

USB Port: Plug device directly into USB port to charge.

Button: Press and hold to turn chair ON. Press again to cycle through six of the auto program's. The program name is announced through the speakers and starts immediately. Press and hold to turn chair OFF.

Dial: Use dial to recline and upright the Solstice 4D massage chair by turning left or right.

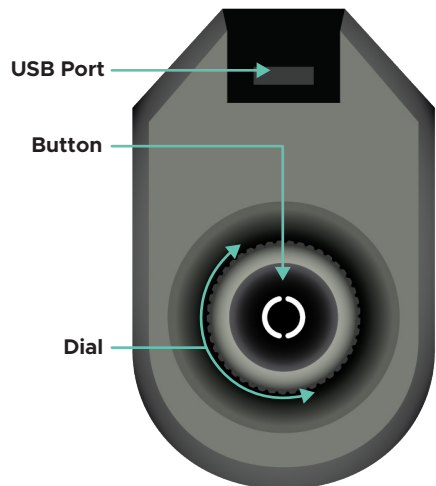

Settings

Setting

Select **SETTING** from Home display, then use the up or down button to toggle between **Language, Bluetooth, Power Save** or **Voice**.

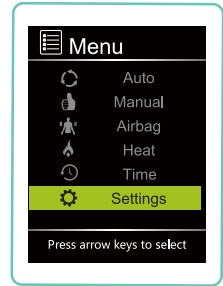

Language

Navigate to **LANGUAGE**, press right button, then use the up or down button to select your desired language: Chinese or English. Press **OK** button to select language.

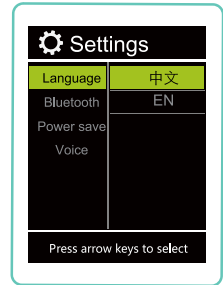

Bluetooth Audio*

Your massage chair includes Bluetooth® compatibility so you can play and enjoy your favorite music. To turn on your chair's Bluetooth®, select **SETTING** from Home display, then press up or down button to navigate to **BLUETOOTH**. Press right button, then press up or down button to select your desired Bluetooth® setting: On or Off. Press **OK** to select setting.

To connect your audio device, open Bluetooth® from audio device and pair with **Solstice** to play music.

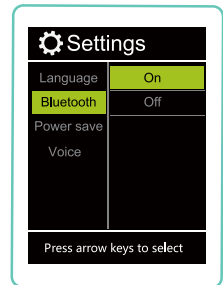

Smart tip: In order to play music from your Bluetooth enabled audio device, **Bluetooth** must first be turned on in settings.

Power Save

Navigate to **POWER SAVE** press right button, then use the up or down button to toggle power save mode on or off. Press **OK** button to select.

Turning on power save will lower power consumption while the chair is in stand-by mode. To put your chair in stand-by mode, simply turn your chair off using the remote control.

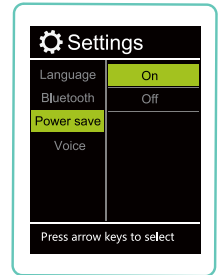

Timer

Select **TIME** from Home display, then use the up or down button to select your desired timer: 10mins, 20mins, or 30mins. Press **OK** button to select timer.

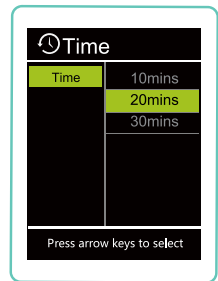
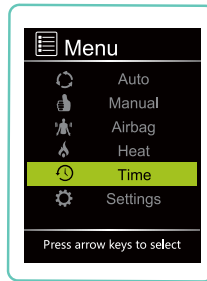

Remote Control In-Use Screen

Whilst running an Auto Program or Manual mode, the remote control screen will return to the in-use screen (as shown below) **after 10 seconds of being idle**.

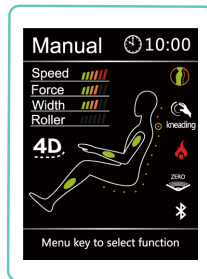

Manual in-use screen

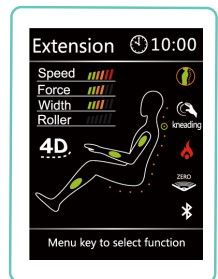

Auto Program in-use screen



- Do not spill liquids on remote control and avoid placing heavy objects on remote control or power cord to avoid damage or malfunction.

Build your own

Manual Programs

In Manual mode you can operate components of your massage chair individually or combine them to create unique massage scenarios.

Press **MANUAL** from Home display, press up or down button to navigate among: **MODE**, **PART**, **WIDTH**, **SPEED**, and **ROLLER**.

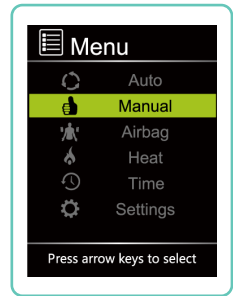

Back Massage Technique Mode

Navigate to **MODE**, press right button, then use the up or down button to select your desired mode: Kneading, Knocking, Tapping, Shiatsu, Sync, or 4D Shiatsu. Press **OK** button to select mode.

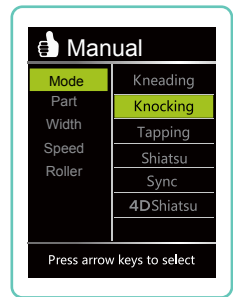

Massage Part (Back Region)

Navigate to **PART**, press right button, then use the up or down button to select your desired region: Whole, Partial, and Point massage. Press **OK** button to select region.

Whole travels the entire length of the track.

Partial travels a short distance and reverses direction for focused relief.

Point stops on the track for targeted relief.

Partial and Point location can be fine tuned using the **Back Adjustment** arrow up or arrow down buttons

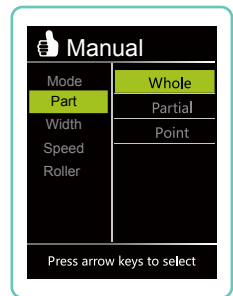

Smart tip: Message **Width** can't be adjusted when in Kneading, or Sync mode techniques. Message **Speed** can't be adjusted when in Shiatsu.

Back Node Width

Navigate to **WIDTH**, press right button, then use the up or down button to select your desired width: Wide, Medium, and Narrow roller width. Press **OK** button to select mode. (Message Width can't be adjusted when in Kneading, or Sync Manual modes).

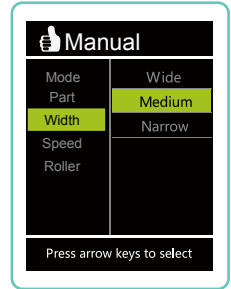

Massage Speed

Navigate to **SPEED**, press right button, then use the up or down button to select your desired speed: 1 = slow, 6 = fast. Press **OK** button to select the speed. (Message Speed can't be adjusted when in Shiatsu).

While the in-use screen is displayed during a massage program, press the **up** or **down directional button** to adjust the massage speed (this feature works in both Auto and Manual programs).

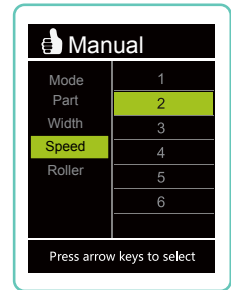

Foot Reflexology Rollers

Navigate to **ROLLER**. Press right button, then use the up and down buttons to select your desired foot roller speed: 1 = slow, 2, 3 = fast, or Off (deactivate foot roller). Press **OK** button to select the speed level you desire.

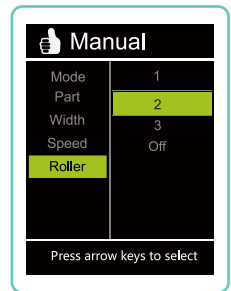

Weightless Zero Gravity Recline

Zero Gravity mode will recline the back and elevate the feet to reduce the gravitational force on your spine. To activate, simply press the **ZERO-G** button on your remote control.



Staying Safe

SAFETY INFORMATION

To ensure safe use of the massage chair and avoid injury or unsafe conditions, please read and follow all instructions before using product.

WARNING

USE NOT RECOMMENDED FOR CERTAIN PERSONS

Use of massage chair may not be safe or suitable for persons with certain medical conditions and could cause serious injury or death in some circumstances. If you have any of the following conditions, please consult a physician before using the massage chair:

- Use of implanted electronic medical devices (such as a cardiac pacemaker)
- Pregnancy
- Cancer, malignant tumors, or other growths
- Osteoporosis or spinal fracture
- Other fractures or musculoskeletal injuries
- Loss of or reduced sensitivity to heat
- Implanted medical fixation devices such as rods, pins, etc.
- Recent surgery or sutures
- Skin diseases or skin injury
- High fever
- Certain pulmonary or breathing conditions
- Impaired circulation

WARNING

To avoid possible death or serious injury to user or others, please read and follow these instructions:

WARNING

- **The areas under the footrest and behind the back rest are potentially dangerous for a child or pet. The chair back is heavy and reclines with force. A small child or pet located behind the chair could be crushed as chair is reclined resulting in serious injury or death. When chair is reclined, small children or pets who have crawled under the leg rest may not be visible to the user and could be crushed when leg rest is lowered or when chair is returned to upright position. To avoid serious injury or death, check these areas carefully before reclining, lowering leg rest, or returning chair to upright position.**
- **Chair should not be used by children under age 14.** Small children could be trapped or injured by airbags, heating mechanism, or moving parts. When chair is not in use, unplug unit and secure chair so that children cannot accidentally power on and operate chair.
- Children over age 14, persons with reduced physical, sensory, or mental capabilities, and elderly or frail persons should exercise caution and use massage chair only when supervised or assisted by a person over 16 years of age.
- Chair has a heated surface and could cause burns, particularly in persons with reduced sensitivity to heat. Such persons should use the chair only after consulting with a physician and should use extreme caution during any physician-approved use.

CAUTION

To avoid the risk of minor injury or discomfort, or damage to the massage chair or other property, please read and follow these instructions for safe use of massage chair:

CAUTION

- Do not stand or stack heavy objects on footrest.
- Do not operate heating features of chair while under a blanket or pillow. Excessive heating can occur and cause fire, electric shock, or injury to persons.
- To avoid pinching or crushing, please do not place body parts, especially fingers and toes, between parts of chair and keep clear of moving parts.
- To avoid overheating, injury or discomfort from overuse, do not fall asleep while using massage chair and do not use for extended periods of time (longer than 20 minutes).
- Avoid use while under the influence of alcohol, medications or other substances that may cause drowsiness, disorientation, or impairment of judgment or motor skills.
- Do not use the massage chair right after a meal, as it may cause discomfort.
- If you feel any abnormal discomfort during the operation of the massage chair, turn off the power immediately and discontinue use.
- Do not use this appliance when ambient temperature is over 40 C (104 F).
- Do not use this appliance in humid or dusty environment, or when any part of the body is in contact with plumbing or any similar ground.
- Never operate the appliance with the air openings blocked. Keep the air openings free of lint, hair, dust and the like.
- Do not use outdoors.
- Do not operate where aerosol (spray) products are being used or where oxygen is being administered.
- Place the product on a flat, level floor to reduce risk of tipping or overturning.
- Do not use or store near heat or open flame.
- Intended only for users who weigh below 300 lbs.
- Use this product only for its intended use as described in this manual. Do not use attachments not recommended by the manufacturer.
- Massage chair intended only for use by one person. Do not use by two or more persons at the same time to avoid damage to the product.
- Do not allow children to stand, jump, or play on or around massage chair, even when it is not powered on or in use.
- Remove personal accessories from arms and empty pockets while using the massage features of the chair.
- Check the upholstery under the cushions and other spots for damage or loose objects that may cause injury or damage chair while operating. If any damage is present, do not use the massage chair and refer to a qualified service professional for servicing.
- To avoid damage to chair, walls, or other objects, make sure there are no obstacles behind the chair and there is enough clearance before adjusting the backrest or leg rest angle.
- Please be seated properly while using the product.
- To avoid damage to chair or floors, do not drag or push the chair or roll its casters on wood floor or carpet. See instructions on p.6 for safely moving chair.
- If massage chair is not working properly, has been dropped or damaged, or has been dropped into water or exposed to flooding, return the appliance to a service center for examination and repair before attempting to use.
- Do not drop or insert any object into any openings in chair.

Staying Safe

WARNING

Read and follow these instructions concerning safe use of the power cord and power unit to avoid possible electric shock, fire hazard, use of chair by and injury to unattended children, or damage to chair or other property.

WARNING

- To avoid risk of electric shock, connect this unit to a properly grounded outlet only. See Grounding Instructions on pg. 7.
- Always unplug massage chair from the electrical outlet immediately after use and before cleaning. An appliance should never be left unattended when plugged in. To disconnect, turn all controls to the off position, then remove plug from outlet.
- Do not use massage chair and unplug from outlet during thunder or lightning storms, and before putting on or taking off parts.
- To ensure safe operation, power must be supplied only at standard 110 voltage, to the specifications of the appliance. Confirm that the power voltage stated on the rating label corresponds to your local electricity supply.
- The massage chair should be used only with the power supply unit provided. Do not use with any other power source.
- Do not use a wet or damp hand to unplug the cord to avoid electric shock.
- Do not pull on the power cord to unplug. Grip by plastic end nearest outlet to unplug power cord.
- Do not squeeze, over bend, pull hard, or twist the power cord.
- Keep the power cord away from heated surfaces.
- Do not carry or drag the chair by power cord or use cord as a handle.
- If there is any smoke or unusual smell while using massage chair, stop using immediately and unplug the power cord.
- Never operate the chair if it has a damaged power cord or plug. If the power cord is

Do not disassemble, dismantle or attempt to repair massage chair. Such actions, as well as misuse of product, may cause damage to or failure of massage chair and may void the manufacturer's warranty. For repairs, please contact an authorized dealer or repair agent at 603-910-5000. For additional details concerning terms, conditions and limitations of warranty, see <https://infinitymassagechairs.com/warranty-info>.

Fixing Issues

Trouble Shooting

No.	Symptoms	Possible Causes	Possible Solution
1	Noise is heard while in use	These noises are normal and arise from friction between the massage rollers and the faux leather cover	No need to take any measures
2	Massage Chair does not start	<ul style="list-style-type: none"> - The power cord is not secured into the socket - Not switched ON - The fuse is blown 	<ul style="list-style-type: none"> - Insert the power plug properly into the power socket - Turn on the switch found on chair side. Then push power button on remote - Replace only with a fuse of same type and rating
3	No music comes from the speaker	The volume is turned to the lowest setting	Adjust the speaker volume from the mobile device. Make sure Bluetooth setting on chair and phone are both ON
4	Backrest or footrest can not raise or recline	Excessive load has been pressed on the backrest or legrest	Reduce the load and try again
5	Airbag malfunction	The air hose is blocked	Straight the air hose and clearout the blockage

If problem remains, please contact Infinity for maintenance.

Tip: Do not attempt to repair this product yourself, our company shall not be liable for the injury or damage caused by any servicing without authorizations. Thank you for your cooperation

Specifications

Model	Solstice 4D
Dimension of Main Body (in)	66 x 35 x 48 (L x W X H)
Necessary Clearance to Wall (in)	6"
Net Weight (lbs)	188
Shipping Weight (lbs)	225
Max. User Weight (lbs)	265
Voltage	110-120V
Rated Current	0.7A
Power Consumption	130W

Fixing Issues

Frequently Asked Questions

Q: I find the chair is too intense to be comfortable. What can I do?

A: Your body needs to become acclimated to therapeutic massage. To be effective, the massage techniques must compress the tissue in your body. We recommend the following steps to help get started. Then over time as your body acclimates you can increase the intensity by reducing the layers between you and the chair.

1. Use body the Pillow and Pillow pad to reduce upper body intensity.
2. Go into Airbag on the main menu, scroll down to FORCE, select air intensity setting 1
- If a specific airbag is too intense, scroll down to PART, turn off Full and turn on only the airbags you want.
3. Go into Manual, select Rollers, and turn the foot reflexology rollers off.
4. Adjust the recline on the remote. More upright will be less intense. Weightless Zero Gravity Recline will be more intense.
5. If after adjustments and attempt to acclimate, you still experience discomfort, discontinue use and consult a physician.

Q: I'm not a foot massage person, what should I do?

A: Turn off foot reflexology rollers, navigate to Manual on the home display, arrow down and select Rollers, then switch to off. You may also want to turn off the Leg/Foot airbags, or reduce the air intensity to level 1.

Q: My chair is not performing as expected. What should I do?

A: Your Infinity massage chair is an amazing combination of programming and robotics. On occasion the chair just may need to be rebooted. To do this power down the chair and unplug from the wall for 5 minutes then plug back in and power back up to see if it self-healed. If you are still having an issue, give Infinity a call at 603-910-5000.

Q: I can never seem to get in my Infinity Massage chair, someone is always in it.

A: We know. It happens. Tell your friends to get their own Infinity Chair.

For more information and access to further questions, and resources, visit our website at www.infinitymassagechairs.com

INFINITY[®]

72 Stard Road, Seabrook, NH 03874
603-910-5000
www.infinitymassagechairs.com

Version 2.1