

INFINITY[®]

MASSAGE CHAIRS



User Manual

MOSAIC
4D MASSAGE CHAIR

Welcome to

INFINITY[®]

THE ULTIMATE MESSAGE EXPERIENCE

Thank you and congratulations on purchasing an Infinity Massage Chair - you've made a great choice.

With over a decade of experience designing, building and servicing massage chairs, Infinity takes pride in every chair sold, including yours. We are here for you. The US-based Customer Care team can be reached at (603) 910-5000 or visit us online at www.infinitymassagechairs.com and find valuable self service resources under the SUPPORT tab, including electronic copies of all documents and video tutorials.

Inside this manual, you will find everything you need to setup and safely enjoy your chair. Please review the entire manual, including all safety information, before assembling or using your chair. If you are assembling the chair yourself, please see the Assembly Guide next and reference the online assembly video.

For convenience, we've also created a Quick Start Guide. We suggest you keep it in the remote pocket as a tool to get to know all the features of your new chair.

Get ready to sit back, relax and enjoy the Ultimate Massage Experience.

Warranty Registration

Register your product at www.infinitymassagechairs.com/warranty to ensure it is in our system. This will simplify the warranty process should you ever need it.

Alternatively, **scan the QR code** to go directly to the URL above.



SCAN CODE

Assembly Video

Before assembling your chair, watch an assembly video at:
www.infinitymassagechairs.com/assembly-tutorials

Alternatively, **scan the QR code** to go directly to the URL above.



SCAN CODE



@infinitymassagechairs



@infinity_chairs



@infinitymassagechairs

We know you can't wait to sit in your new Infinity Massage chair! Take a picture of you enjoying the ultimate massage experience and make sure to tag us on social media with the hashtag [#infinitymassagechairs](https://www.instagram.com/explore/tags/infinitymassagechairs)

Table of Contents

Your Chair

Chair Features	4
External Structure	5

Before Getting Started

Installation Site	6
Clearance Space for the Chair	6
Floor Protection	6
Move Methods	7
Connect to Power	7

Chair Setup

Main Power Switch	8
Adjust Pillow	8
Increase Intensity of Massage - Manually	8
TrueFit™ Body Scanning	8
Getting out of the Chair	9
Chair Entry and Exit Hazards	9
Tablet Remote Display	10
Tablet Remote Operation	11

Taking Control

Auto Programs	12
TrueFit™ Body Scanning	12
In-Use Screen	12
Auto Program Descriptions	13

Set Your Environment

Custom Selections from Auto Programs	14
Adjustments	14
4D Intensity	15
Kneading Speed	15
Tapping Speed	15
Air (Air Bag) Intensity	15
Leg/Back Angle Adjust	15
Weightless Zero Gravity Recline	15
Airbag Massage	16
Air Region	16
Sounds	16
SootheMe™ Sound Therapy	17
Voice Demo	17
Touch-Tone	17
Bluetooth	17
Volume Level	17
Quick Access Control Panel	18

Settings

System	19
Language	19
Display Brightness	19
Sleep Mode	19
Massage Time	19
Engineering Mode	19

Build Your Own

Infinity Control	20
Back Massage Technique	20
Focus Zone	20
Back Mechanism Adjust	20
Massage Width	21
Additional Settings	21
Back Heat	21
Foot Rollers	21
Calf Kneading	21
Adjustments	21
Air Massage	21

Staying Safe

Fixing Issues

Troubleshooting	25
Specifications	25
Frequently Asked Questions	26
Warranty	27



Warning! Read important safety information found on page 30 before using or operating chair.

Your Chair

Chair Features

Zero Wall Fit™ Space-Saving Technology



See page 6

Truefit™ Body Scanning + Leg Extension



See page 8

Tablet Remote



See page 10 & 11

4D Back Massage Mechanism



See page 14 & 15

Weightless Zero Gravity Recline



See page 15

SoothMe™ Sound Therapy



See page 17

Premium Bluetooth® Speakers



See page 17

Quick Access Panel

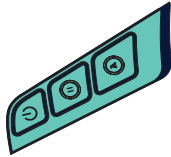

See page 18

Infinity Control Manual Settings



See page 20

Dual Reflexology Foot Rollers



See page 14 & 21

Calf Kneading



See page 14 & 21

Lumbar Heat



See page 14 & 21

External Structure

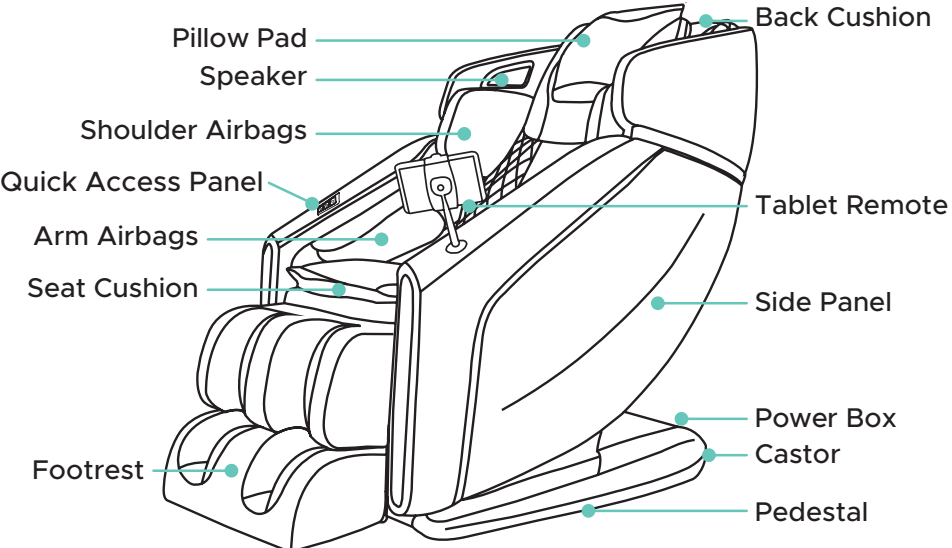

Before Getting Started

Installation Site

Clearance Space for the Chair

- 6" clearance for the recline of the backrest; 20" clearance for the extension of footrest and sliding forward of the chair.
- Keep it 3 feet away from the TV, radio or other audio & video appliance to avoid signal interference.

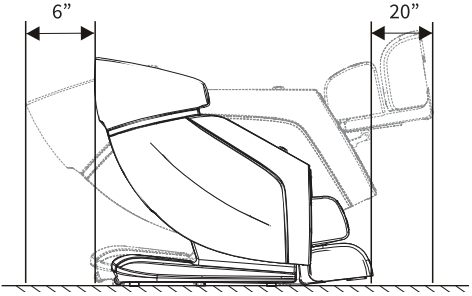

- Keep the distance between the power socket and power switch within 60" to avoid damage of power cord while massage chair sliding forward.
- Straighten the power cord while in use to avoid tangle or damage.



- To avoid serious injury or death, before sliding chair forward or backward check to make sure area is clear of children, pets, or obstacles.

Floor Protection

To protect ANY floor type, hard surface or carpeted, from scratches or other markings, place the chair on a sacrificial pad or mat that extends from under the footrest to the rear of the chair.

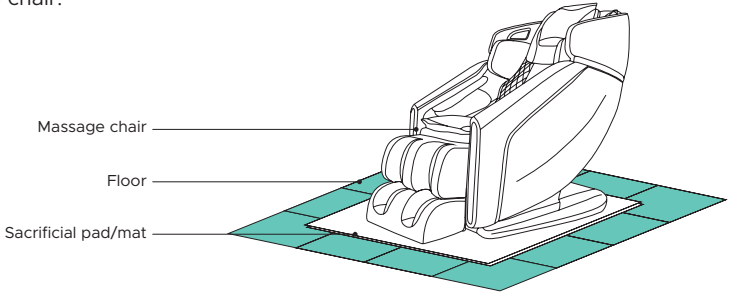

- Do not use the massage chair in high moisture environment such as near a swimming pool or bathroom to prevent electric shock accident.
- Please keep the massage chair away from heated surfaces to prevent fire hazard or damage to the product.

Move Methods

Apply pressure to the back of the massage chair from behind to pivot on the Castors. Have a second person up front to guide the Footrest until in the correct position. Maintain clearances as mentioned above. Gently lower into place. Do not pull on the side arms.

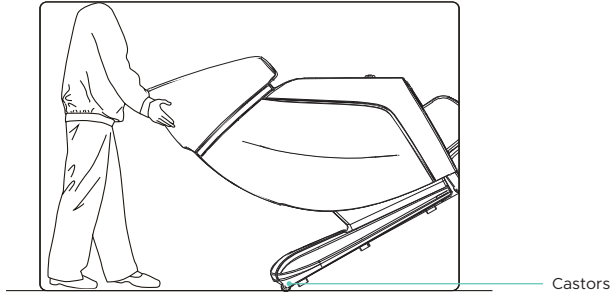

- Do not move the chair when there is user inside.
- Chair is heavy. Use caution and get assistance when lifting to avoid injury. Do NOT lift chair by footrest or armrests to avoid damage to product.

Connect to Power

Plug into a 120V grounded outlet.



WARNING

Grounding Instructions

To avoid risk of electrical shock, turn power switch off before plugging unit into electrical outlet. Use only with properly grounded outlet (3 prong). Do not plug into ungrounded outlet.

WARNING

– Improper connection of the equipment-grounding conductor can result in a risk of electric shock. Check with a qualified electrician or serviceman if you are in doubt as to whether the product is properly grounded. Do not modify the plug provided with the product – if it will not fit the outlet, have a proper outlet installed by a qualified electrician.

This product is for use on a nominal 120-V circuit and has a grounding plug that looks like the plug illustrated. Make sure that the product is connected to an outlet having the same configuration as the plug. No adapter should be used with this product.

Earthing

This massage chair is a Class 1 electrical appliance. Make sure to use a grounded outlet to the grounded power supply circuit and a properly installed earth grounding rod with ground connection, to avoid electric shock.

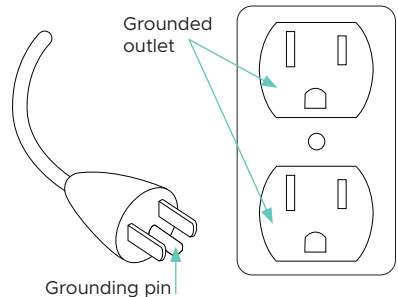

Chair Setup

Getting Comfortable

Main Power Switch

To power up the chair, flip the main power switch located on the back of the base of the chair to ON. Ensure the electrical cord is connected to a 110V grounded outlet and plugged into the power cord port located on the back of the base of the chair.

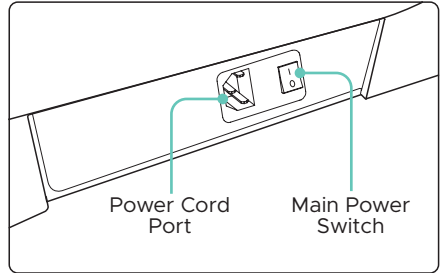

- To avoid possible damage to product or injury to unsupervised children, always turn off power switch and unplug massage chair from electrical outlet immediately after use.

- When not in use for a long period of time, we recommend that the chair be covered, the power cord be coiled and that the unit be placed in an environment free of dust and moisture.

Adjust Pillow

Take a seat in the chair and take note of where the neck pillow rests on your neck. Adjust the neck pillow so that it rests comfortably in the arch of your neck. Do this by removing it from the velcro, aligning it, and then reattaching to the velcro once it is in the desired position.

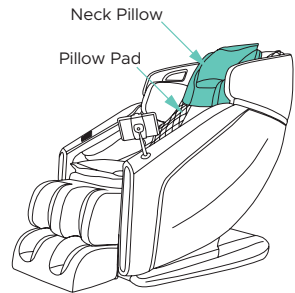

Increase Intensity of your Massage - Manually

To make the massage more intense, remove the **neck pillow** and **pillow pad** cushioning between you and the massage mechanism in the seat back. To remove the neck pillow, simply remove it from the velcro. To remove the pillow pad, un-zip the zipper.

TrueFit™ Body Scanning

Select any auto program. The chair will automatically begin scanning your body, mapping your back, shoulders, and neck. During this process it is important to remain seated back into the chair without lifting your head.

The scan can be viewed on the Tablet Remote screen. If fine tuning is needed just after your body scan, wait for the **shoulder adjust prompt** to appear and then use the **Back Adjustment** buttons to move the massage rollers up or down for the perfect shoulder kneading position.

Smart tip: To increase intensity in the neck and shoulder region, flip the pillow or the pillow and pillow pad up so you lay directly on the seat back pad.

TrueFit™ Body Scanning

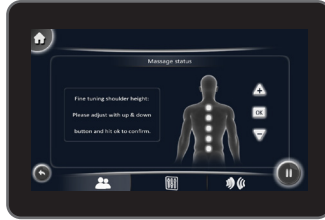

Press **OK** to start massage.

Getting Out of The Chair

To easily exit the chair at any time, tap the **POWER** button on the top right of the home display, on the Tablet Remote to restore the chair to the upright position. Alternatively, you can also press and hold the joystick power button, found on the right arm panel next to the Quick Access Control Panel, until the chair starts resetting.

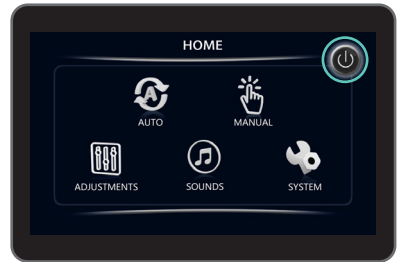

WARNING! Check to make sure children and pets are clear of chair **before** tapping power button to return chair to upright position.

Chair Entry and Exit Hazards

WARNING! The areas under the footrest and behind the back rest are potentially dangerous for a child or pet. The chair back is heavy and reclines with force. A small child or pet located behind the chair could be crushed as chair is reclined resulting in serious injury or death. When chair is reclined, small children or pets who have crawled under the leg rest may not be visible to the user and could be crushed when leg rest is lowered or when chair is returned to upright position. **To avoid serious injury or death, check these areas carefully before reclining, lowering leg rest, or returning chair to upright position.**

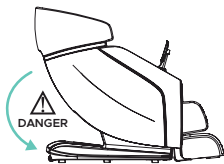

Make sure to check for children or pets **between the chair back and the base of the chair** before entering zero gravity recline.

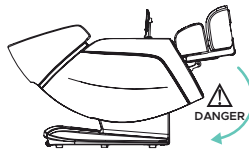

Make sure to check for children or pets **underneath the footwell** before exiting zero gravity recline and returning to upright position.

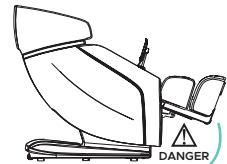

Make sure to check for children or pets **between the footrest and the chair body** before lowering the legrest.

Taking Control

Tablet Remote Display

Power Buttons – Use the main power button on the top right edge of the tablet remote to turn the chair on/off. Once the chair is on, you can now also tap the circular power button on the screen to turn the chair on/off.

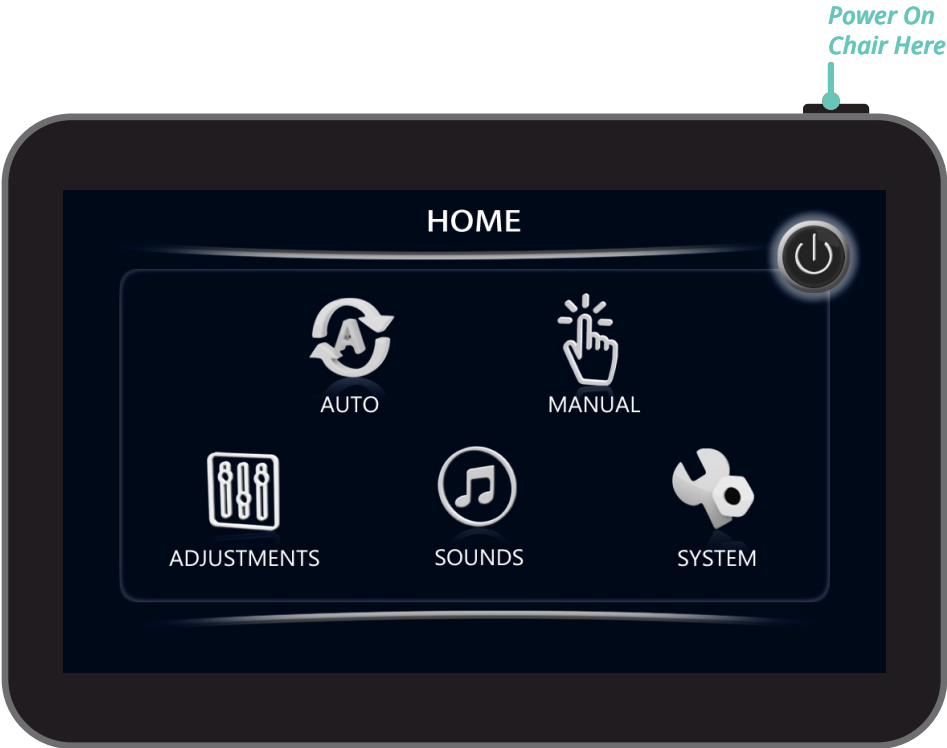

Tablet Remote Operation

HOME – After turning on your chair, this is the first screen you will see on your Tablet Remote. Use this screen to navigate all menu options. To select, simply tap the screen with your finger. Choose from the following: **AUTO**, **MANUAL**, **ADJUSTMENTS**, **SOUNDS**, or **SYSTEM**.



AUTO – Select from 16 pre-set auto programs. To select simply tap the auto program you wish to run.



MANUAL – Have a particular spot that needs more work? Take the power of massage into your own hands with Infinity Control. Use this screen to fully customize your own massage and find the perfect treatment for you.



ADJUSTMENTS – While your massage program is running, use this screen to make adjustments to massage strength & speed, airbag intensity, or chair angles.



SOUNDS – Use this screen to select and control the SootheMe™ Sound Therapy feature of your chair. The selected sound will play from the Intersound™ speakers. To turn SootheMe™ Sound Therapy off, select the **Sound Off** option.



SYSTEM – Use this screen to adjust and personalize your chair and Tablet Remote

Taking Control

Auto Programs

From the home display, tap the **AUTO** button to enter Auto Program Menu. Choose from **Demo, Working Relief, Sports Refresh, Extension, Morning, Neck & Shoulder, Lower Body, Waist & Glutes, Shiatsu, Rise & Shine, Mid-day, Rest & Sleep, Vigor, Full Body, Night, or Rest & Restore.** To enter the program you desire tap the screen. Selected program will show on the In-use screen.

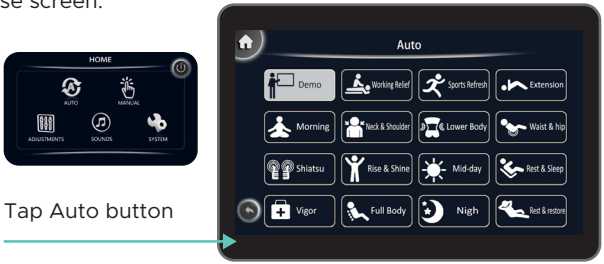

TrueFit™ Body Scanning

After a Massage program is selected, you will be taken to the Body Scanning screen. Here you can use the arrows to adjust the back mechanism up and down to match your specific shoulder height. After the countdown timer has elapsed, your massage will start.



In-Use Display Screen

After adjusting your shoulder height, you will be taken to the In-use screen where you can observe all current settings and session information.

CAUTION - Do not spill liquids on Tablet Remote and avoid placing heavy objects on Tablet Remote or power cord to avoid damage or malfunction.



Program	What for?	Description
Demo	A quick way to feel all the massage techniques and chair movements in a brief 8 minute session.	A quick show of massage chair's features and functions, that can be accompanied by an explanatory voice over. To turn off voice over, tap System from home display, then toggle Voice Demo to off.
Working Relief	This is a great program for people who work at a desk or travel a lot.	The most intense of the massage programs. This strong kneading and shiatsu massage effectively decompresses the entire body.
Sports Refresh	Refresh your muscles and reduce tension carried in the body from everyday stress.	Total body relaxation with shiatsu and rolling massage techniques, and air cell massage.
Extension	Soothe muscles after sports activities and exercise.	Yoga like stretch motions grab, hold and gently extend the body, while deep shiatsu massage helps to boost the vitality of muscles.
Morning	Need a quick break? Soothe tired and sore muscles so that you can get back to what you love doing most.	A revitalising massage that is ideal for a mid-day boost. Full body kneading relieves built up stress, reduces fatigue, and improves metabolism so you can finish your day off strong.
Neck & Shoulder	Soothing pain and tension in the neck and shoulders.	A powerful combination of kneading, grabbing, and pressing massage techniques target the neck, shoulder, and upper back to help ease unwanted pain and stiffness.
Lower Body	Improve hip mobility and reduce lower back pain.	Designed to stimulate the waist, hips and buttock, this sequence of massage and air bag compression can help to improve your range of motion, and reduce lower back pain so you can return to your feet feeling renewed.
Waist & Glutes	Feeling tight and worked up? Use this program to melt away stress and relax.	Featuring slow kneading in the waist and glutes, this massage relaxes muscles, improves circulation and aids in recovery.
Shiatsu	Helps to relax and recover tired and sore muscles. Whole body massage with a focus on the main back muscles along your spine.	Deep shiatsu on the back for 10 minutes.
Rise & Shine	Try this program first thing in the morning to prepare your muscles for the stress of the day.	Targeted airbag compression provides a full body stretch while the 4D back-mechanism performs a combination of massage techniques to help awaken and ignite your muscles for the day ahead.
Mid-day	Great for mid-day recovery to relieve any built up morning stress.	Relaxes muscles and speeds up recovery time after intense exercise by promoting circulation.
Rest & Sleep	Designed for relaxing. Try this program as you prepare your body to rest for the night.	A progression of mild massage techniques and chair movements brings harmony to your body. This program helps you unwind from a long day, and prepares you for a restful night's sleep.
Vigor	Recharge and re-vitalize your tired muscles after physical exertion.	Uses moderate pressure to decrease recovery time after physical exertion, relieve the body of stress and improve circulation.
Full Body	This program is the best choice to re-energize tired muscles and reset your mind.	This program is designed to relax the body both physically and emotionally. A unique combination of varying intensities brings the mind into a peaceful state, while specific massage techniques increase circulation to help relieve muscular tension, and reduce recovery time.
Night	Best for winding down and re-energizing yourself after a long day.	As the lowest intensity massage, this series of massage techniques is perfect for those who are more sensitive, or looking for a light kneading motion on the back, waist and hips.
Rest & Restore	Unwinding after a stressful day.	Designed to clear the mind and increase blood circulation. Breath in deeply and exhale your stress while this rhythmic massage program works to alleviate your tired muscles and reinvigorate your spirit.

Set your Environment

Custom Selections from In-Use Screen

To personalize your massage to your exact needs, you can adjust settings straight from the In-use display screen.

Simply tap the screen to adjust **4D Intensity**, or toggle on/off **lumbar heat**, **foot rollers**, and **calf rollers**.



4D Intensity

Use this control to increase or decrease the intensity of the 4D back mechanism that works the back and shoulder regions. Use the + button to increase the 4D intensity, use the - button to decrease the 4D intensity.

Heating

Use this control to activate heat in the lumbar region to soothe muscles. Press once to turn **on** lumbar heat, press again to turn **off** lumbar heat.

Foot Rollers

Use this control to activate the dual reflexology foot rollers. Press once to turn **on** foot rollers, press again to turn **off** foot rollers.

Calf Kneading

Kneading combines with compression air cells to simulate hands gently relieving tension and pain in the calf region of each leg. Use this control to activate calf kneading. Press once to turn **on** calf kneading, press again to turn **off** calf kneading.

Adjustments

The **Adjustments** display screen can also be used to further tailor your massage exactly to your needs. Here you will have complete control over massage strength, and chair angles.

You can enter the adjustments screen from the home display screen, or by pressing the  icon at the bottom of your tablet remote whilst on the in-use display screen.

To return to the In-use screen, simply tap the  icon on the bottom of the Tablet Remote screen. Press the return button on the bottom left of the screen to return to the previous screen.

Smart tip: **Partial** and **Point** location can be fine tuned by using the **Adjust** setting. Press and hold arrow up or arrow down buttons to control the location of the back mechanism.



4D Intensity

Use this control to increase or decrease the intensity of the 4D back mechanism that works the back and shoulder regions. Tap anywhere on setting to increase 4D intensity 1 step per tap. Once maximum setting is reached, the next tap will cycle back to the lowest 4D intensity setting.

Kneading Speed

Use this control to increase or decrease the kneading speed of the 4D back mechanism. Tap anywhere on setting to increase kneading speed 1 step per tap. Once maximum setting is reached, the next tap will cycle back to the lowest kneading speed setting.

Tapping Speed

Use this control to increase or decrease the tapping speed of the 4D back mechanism. Tap anywhere on setting to increase tapping speed 1 step per tap. Once maximum setting is reached, the next tap will cycle back to the lowest tapping speed setting.

Air (Air bag) Intensity

Use this control to increase or decrease the intensity of the airbag massage. Tap anywhere on setting to increase airbag intensity 1 step per tap. Once maximum setting is reached, the next tap will cycle back to the lowest airbag intensity setting.

Leg/Back Angle Adjust

Need to adjust the position of the footrest or backrest? Use the **Leg up/down buttons** or **Back up/down buttons** to fine tune your angles. To adjust the footrest or backrest angle up or down, press the corresponding button. Press and hold for faster adjustment.

Weightless Zero Gravity Recline

Weightless zero gravity recline elevates your feet up over your heart to improve overall circulation and reduces gravitational force on your spine for a sense of weightlessness.

Set your Environment

Airbag Massage

Your massage chair also has the ability to control the air massage feature. Simply tap the  icon to enter the **Air Massage display screen**, where you can adjust the airbag massage region. Press the return button on the bottom left of the screen to return to the previous screen.



Air Region

Choose your desired airbag region/s: **Full Body, Waist, Leg, Shoulder, Arm, or Foot**. Tap screen to select setting. To turn a particular airbag region off, de-select the activated region. Selecting **Full Body** will over ride any selections and ALL airbags become active.

Sounds

Tap **Sounds** on the home display screen to enter the **Sound display screen**. Use this screen to select and control SootheMe™ Sound Therapy, toggle on/off Voice Demo, Touch-tones, and Bluetooth, or adjust volume

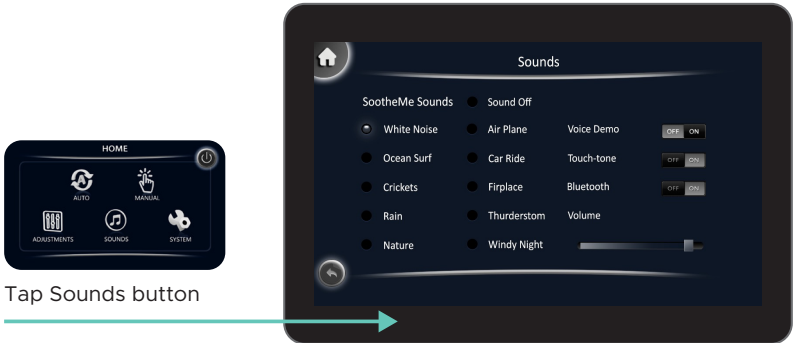

SootheMe™ Sound Therapy

No need to find something to stream with on-board **SootheMe™ Sound Therapy** Nature Sounds to choose from. Envelope yourself in soundscapes that are designed to help you relax. Use this setting to select and control the SootheMe™ Sound Therapy feature of your chair. The selected sound will play from the speakers next to your head. To turn SootheMe™ Sound Therapy off, select the **Sound Off** option.

Note: Bluetooth must first be turned on in Sounds display screen.

Sounds	What is it?
White Noise	A constant, even loop of pure white noise to mask out distractions
Ocean Surf	Soothing ocean waves rolling onto the shore
Crickets	Night time in the suburbs. Churping Crickets, water trickling from a pond, and faint traffic noises
Rain	Quiet, light, refreshing rain falling to the ground
Nature	Refreshing sounds of small birds peacefully singing along a tranquil stream.
Air Plane	A Cessna propeller airplane motor idling
Car Ride	Calming inner-city traffic featuring cars, trucks, and motorcycles
Fireplace	Crackling of fire in a fireplace
Thunderstorm	Heavy rainstorm with thunder
Windy Night	Heard from inside a cabin, a howling wind blows constantly outside

Note: Bluetooth must be ON for sounds to work.

Voice Demo

Voice demo talks you through the functionality of the chair in the Demo auto program. Toggle your desired voice demo setting: **On** or **Off**. Tap screen to select setting.

Touch Tone

Control whether you receive audible feedback after tapping the screen to select a setting. Toggle your desired touch-tone setting: **On** or **Off**. Tap screen to select setting.

Bluetooth

Toggle your chair's Bluetooth® setting: **On** or **Off**. Tap screen to toggle setting. Open Bluetooth from audio device and pair with **Mosaic** to play music.

In order to use the chair app, play in-built sounds from your chair, or to play music from your Bluetooth® enabled audio device, Bluetooth® must first be turned **on**.

Volume Level

Increase or decrease volume of SootheMe™ Nature Sounds. **1 = low, 9 = high, or Off**. Tap screen to select setting.

Set your **Environment**

Quick Access Control Panel

The Quick Access Panel allows you to turn the chair on and off, pause your massage, cycle through auto programs, and toggle the foot rollers on/off.

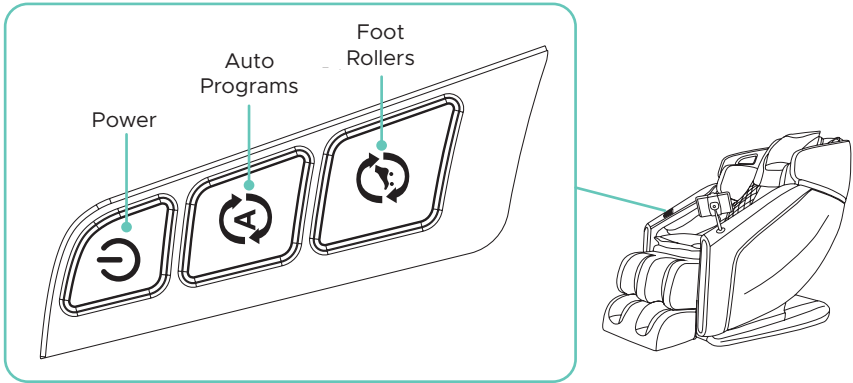

Power – Press for power on. When chair is operating, *short press* to pause, *long press* to power down.

Auto Programs – Cycle through Auto programs (Tablet remote shows program change).

Foot Rollers – Toggle foot rollers On/Off.

Settings

System

Tap **System** on the home display screen to enter the system display screen. Use this screen to adjust and personalize your chair and Tablet Remote settings. Press the return button on the bottom left of the screen to return to the previous screen.



Tap System button

Language

Control your desired language setting: **English** or **Chinese**. Tap screen to select setting.

Backlight (Display Brightness)

Control your desired Tablet Remote screen brightness setting; press and drag dial to adjust screen brightness up or down.

Sleep Mode

Toggle your desired sleep mode setting: **On** or **Off**. Tap screen to select setting. When sleep mode is **on** the chair will stop in the reclined position after Auto Programs, when sleep mode is **off** the chair will return to a fully upright position after each Auto Program.

Massage Time

Tap screen to select your desired massage timer length: **5 minutes, 10 minutes, 15 minutes, 20 minutes, 25 minutes, or 30 minutes**. 15 minutes is the default setting. The massage chair will turn off automatically and reset after the timer is up.

Engineering Mode

Tap screen to enter engineering mode. This is for tech support to run tests should your chair need servicing.

Build your own

Infinity Control

Have a particular spot that needs more work? Take the power of massage into your own hands with Infinity Control. Tap **Infinity Control** on the home display to enter the Infinity Control display screen. Use this screen to fully customize your own massage and find the perfect treatment for you.

Simply tap the screen to choose your desired massage technique, massage position, massage focus zone, and to toggle on/off back heat, foot rollers, and calf kneading. Your first selection on this screen will start your massage.



Tap Manual button

Back Massage Technique

Controls the massage technique of the back mechanism. Select from: **Kneading, Sweedish, Knocking, Tapping, or Rolling.** Tap screen to select. Tap technique a second time to enter a faster variation of that technique.

Note: Number in top right corner represents active variation. Rolling has only one speed.

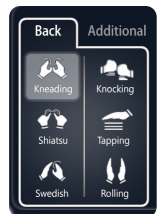

Focus Zone

Controls the range of motion of the back mechanism, **Full** travels the entire length of the track, **Partial** travels a short distance and reverses direction for focused relief, **Point** stops on the track for targeted relief. Tap screen to select setting.

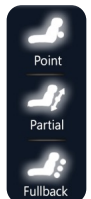

Back Mechanism Adjust

Partial and Point location can be fine tuned by using the Adjust setting. Use the arrow up or arrow down buttons to control the location of the back mechanism.



Smart tip: Message **Width** can't be adjusted when in Kneading, or Sync mode techniques.

Massage Width

Press to cycle through varying width settings of back mechanism. Choose from: **Narrow, Medium, or Wide**. Tap screen to select setting.

Note: Width can't be adjusted when in Kneading, or Sync modes.



Additional Settings

Tap **Additional**, located next to Back, to control features of your chair such as heat, foot rollers, and calf kneading. To return to the **Back menu display** to change your massage technique, simply tap Back.

Back Heat

Use this control to activate heating nodes in the lumbar region to soothe muscles. Press once to turn **on** lumbar heat, press again to turn **off** lumbar setting.

Foot Rollers

Use this control to activate the dual reflexology foot rollers. Press once to turn **on** foot rollers, press again to turn **off** foot rollers.

Calf Kneading

Kneading combines with compression air cells to simulate hands gently relieving tension and pain in the calf region of each leg. Use this control to activate calf kneading. Press once to turn **on** calf kneading, press again to turn **off** calf kneading.

Adjustments

The **Adjustments display screen** can also be used to further tailor your massage exactly to your needs. Here you will have complete control over massage strength, and chair angles. **See page 14** for detailed breakdown of adjustments display screen settings.

You can enter the adjustments screen from the home display screen, or by pressing the  icon at the bottom of your tablet remote whilst on the in-use display screen.

To return to the In-use screen, simply tap the  icon on the bottom of the Tablet Remote screen. Press the return button on the bottom left of the screen to return to the previous screen.

Air Massage

The **Air Massage display screen** can be used to adjust the airbag massage region. **See page 16** for detailed breakdown of air massage display screen settings.

To enter the Air Massage display screen, simply press the  icon on the bottom of the tablet remote screen.

To return to the In-use display screen, simply tap the  icon on the bottom of the tablet remote screen. Press the return button on the bottom left of the screen to return to the previous screen.

Staying Safe

SAFETY INFORMATION

To ensure safe use of the massage chair and avoid injury or unsafe conditions, please read and follow all instructions before using product. **SAVE THESE INSTRUCTIONS.**
Household use only

WARNING

USE NOT RECOMMENDED FOR CERTAIN PERSONS

Use of massage chair may not be safe or suitable for persons with certain medical conditions and could cause serious injury or death in some circumstances. If you have any of the following conditions, please consult a physician before using the massage chair:

- Use of implanted electronic medical devices (such as a cardiac pacemaker)
- Pregnancy
- Cancer, malignant tumors, or other growths
- Osteoporosis or spinal fracture
- Other fractures or musculoskeletal injuries
- Loss of or reduced sensitivity to heat
- Implanted medical fixation devices such as rods, pins, etc.
- Recent surgery or sutures
- Skin diseases or skin injury
- High fever
- Certain pulmonary or breathing conditions
- Impaired circulation

WARNING

To avoid possible death or serious injury to user or others, please read and follow these instructions:

WARNING

- **The areas under the footrest and behind the back rest are potentially dangerous for a child or pet. The chair back is heavy and reclines with force. A small child or pet located behind the chair could be crushed as chair is reclined resulting in serious injury or death. When chair is reclined, small children or pets who have crawled under the leg rest may not be visible to the user and could be crushed when leg rest is lowered or when chair is returned to upright position. To avoid serious injury or death, check these areas carefully before reclining, lowering leg rest, or returning chair to upright position.**
- **Chair should not be used by children under age 14.** Small children could be trapped or injured by airbags, heating mechanism, or moving parts. When chair is not in use, unplug unit and secure chair so that children cannot accidentally power on and operate chair.
- Children over age 14, persons with reduced physical, sensory, or mental capabilities, and elderly or frail persons should exercise caution and use massage chair only when supervised or assisted by a person over 16 years of age.
- Chair has a heated surface and could cause burns, particularly in persons with reduced sensitivity to heat. Such persons should use the chair only after consulting with a physician and should use extreme caution during any physician-approved use.

CAUTION

To avoid the risk of minor injury or discomfort, or damage to the massage chair or other property, please read and follow these instructions for safe use of massage chair:

CAUTION

- Do not stand or stack heavy objects on footrest.
- Do not operate heating features of chair while under a blanket or pillow. Excessive heating can occur and cause fire, electric shock, or injury to persons.
- To avoid pinching or crushing, please do not place body parts, especially fingers and toes, between parts of chair and keep clear of moving parts.
- To avoid overheating, injury or discomfort from overuse, do not fall asleep while using massage chair and do not use for extended periods of time (longer than 20 minutes).
- Avoid use while under the influence of alcohol, medications or other substances that may cause drowsiness, disorientation, or impairment of judgment or motor skills.
- Do not use the massage chair right after a meal, as it may cause discomfort.
- If you feel any abnormal discomfort during the operation of the massage chair, turn off the power immediately and discontinue use.
- Do not use this appliance when ambient temperature is over 40 C (104 F).
- Do not use this appliance in humid or dusty environment, or when any part of the body is in contact with plumbing or any similar ground.
- Never operate the appliance with the air openings blocked. Keep the air openings free of lint, hair, dust and the like.
- Do not use outdoors.
- Do not operate where aerosol (spray) products are being used or where oxygen is being administered.
- Place the product on a flat, level floor to reduce risk of tipping or overturning.
- Do not use or store near heat or open flame.
- Intended only for users who weigh below 265 lbs.
- Use this product only for its intended use as described in this manual. Do not use attachments not recommended by the manufacturer.
- Massage chair intended only for use by one person. Do not use by two or more persons at the same time to avoid damage to the product.
- Do not allow children to stand, jump, or play on or around massage chair, even when it is not powered on or in use.
- Remove personal accessories such as jewelry from arms and empty pockets, and remove loose clothing while using the massage features of the chair.
- Check the upholstery under the cushions and other spots for damage or loose objects that may cause injury or damage chair while operating. If any damage is present, do not use the massage chair and refer to a qualified service professional for servicing.
- To avoid damage to chair, walls, or other objects, make sure there are no obstacles behind the chair and there is enough clearance before adjusting the backrest or leg rest angle.
- Please be seated properly while using the product.
- To avoid damage to chair or floors, do not drag or push the chair or roll its casters on wood floor or carpet. See instructions on p.9 for safely moving chair.
- If massage chair is not working properly, has been dropped or damaged, or has been dropped into water or exposed to flooding, return the appliance to a service center for examination and repair before attempting to use.
- Do not drop or insert any object into any openings in chair.

Staying Safe

WARNING

Read and follow these instructions concerning safe use of the power cord and power unit to avoid possible electric shock, fire hazard, use of chair by and injury to unattended children, or damage to chair or other property.

WARNING

- To avoid risk of electric shock, connect this unit to a properly grounded outlet only. See Grounding Instructions on pg. 9.
- Always unplug massage chair from the electrical outlet immediately after use and before cleaning. An appliance should never be left unattended when plugged in. To disconnect, turn all controls to the off position, then remove plug from outlet.
- Do not use massage chair and unplug from outlet during thunder or lightning storms, and before putting on or taking off parts.
- To ensure safe operation, power must be supplied only at standard 110 voltage, to the specifications of the appliance. Confirm that the power voltage stated on the rating label corresponds to your local electricity supply.
- The massage chair should be used only with the power supply unit provided. Do not use with any other power source.
- Do not use a wet or damp hand to unplug the cord to avoid electric shock.
- Do not pull on the power cord to unplug. Grip by plastic end nearest outlet to unplug power cord.
- Do not squeeze, over bend, pull hard, or twist the power cord.
- Keep the power cord away from heated surfaces.
- Do not carry or drag the chair by power cord or use cord as a handle.
- If there is any smoke or unusual smell while using massage chair, stop using immediately and unplug the power cord.
- Never operate the chair if it has a damaged power cord or plug. If the power cord is damaged, it must be replaced by the manufacturer or its service agent or a similarly qualified person to avoid a hazard.

Do not disassemble, dismantle or attempt to repair massage chair. Such actions, as well as misuse of product, may cause damage to or failure of massage chair and may void the manufacturer's warranty. For repairs, please contact an authorized dealer or repair agent at 603-910-5000. For additional details concerning terms, conditions and limitations of warranty, see <https://infinitymassagechairs.com/warranty-info>.

Fixing Issues

Trouble Shooting

No.	Symptoms	Possible Causes	Possible Solution
1	Noise is heard while in use	These noises are normal and arise from friction between the massage rollers and the faux leather cover	No need to take any measures
2	Massage Chair does not start	<ul style="list-style-type: none"> - The power cord is not secured into the socket - Not switched ON - The fuse is blown 	<ul style="list-style-type: none"> - Insert the power plug properly into the power socket - Turn on power switch on the back of the base of the chair. Then tap power button on tablet - Replace only with a fuse of same type and rating
3	No music comes from the speaker	The volume is turned to the lowest setting	Adjust the speaker volume from the mobile device. Make sure Bluetooth setting on chair and phone are both ON
4	Backrest or footrest can not raise or recline	Excessive load has been pressed on the backrest or legrest	Reduce the load and try again
5	Airbag malfunction	The air hose is blocked	Straight the air hose and clearout the blockage

If problem remains, please contact Infinity for maintenance.

Tip: Do not attempt to repair this product yourself, our company shall not be liable for the injury or damage caused by any servicing without authorizations. Thank you for your cooperation

Specifications

Model	Mosaic 4D
Dimension of Main Body (in)	48.4 x 32.1 x 48.8 (LxWxH)
Necessary Clearance to Wall (in)	6"
Net Weight (lbs)	192
Shipping Weight (lbs)	223
Max. User Weight (lbs)	300
Voltage	120V~
Rated Current	1.5A
Power Consumption	150W

Fixing Issues

Frequently Asked Questions

Q: I find the chair is too intense to be comfortable. What can I do?

A: Your body needs to become acclimated to therapeutic massage. To be effective, the massage techniques must compress the tissue in your body. We recommend the following steps to help get started. Then over time as your body acclimates you can increase the intensity by reducing the layers between you and the chair.

1. Use Pillow and Pillow pad to reduce upper body intensity.
2. From the auto program in-use display screen, use the **4D intensity** setting to decrease the intensity of the back massage mechanism. While in Infinity control display screen, navigate to the adjustment display screen to decrease 4D intensity setting.
3. From the in-use display screen tap the **Air Massage icon** to adjust air massage region
- If a specific airbag is too intense, turn off full body and turn on only the airbags you want.
4. From the Adjustments display screen, use **Air Intensity** setting to decrease the air massage intensity.
5. Adjust the recline on the remote. More upright will be less intense. Weightless Zero Gravity Recline will be more intense.
6. If after adjustments and attempt to acclimate, you still experience discomfort, discontinue use and consult a physician.

Q: I'm not a foot massage person, what should I do?

A: Turn off Foot Reflexology Rollers. While in auto program in-use display screen simply tap the foot rollers setting to turn off. While in Infinity control display screen, select additional settings, and then tap the foot rollers setting to turn off.

Q: My chair is not performing as expected. What should I do?

A: Your Infinity massage chair is an amazing combination of programming and robotics. On occasion the chair just may need to be rebooted. To do this power down the chair and unplug from the wall for 5 minutes then plug back in and power back up to see if it self-healed. If you are still having an issue, give Infinity a call at 603-910-5000.

Q: I can never seem to get in my Infinity Massage chair, someone is always in it.

A: We know. It happens. Tell your friends to get their own Infinity Chair.

For more information and access to further questions, and resources, visit our website at www.infinitymassagechairs.com

Warranty

This Infinity Massage Chairs is protected by Infinity's 5 Year U.S Residential Limited Warranty. For more information, scan the QR code below and click on the **Infinity Care Residential Warranty** tab.



INFINITY[®]

72 Stard Road, Seabrook, NH 03874
603-910-5000
www.infinitymassagechairs.com

Version 1.0