

**KYOTA®**

The World's Most  
Advanced Massage Chairs®

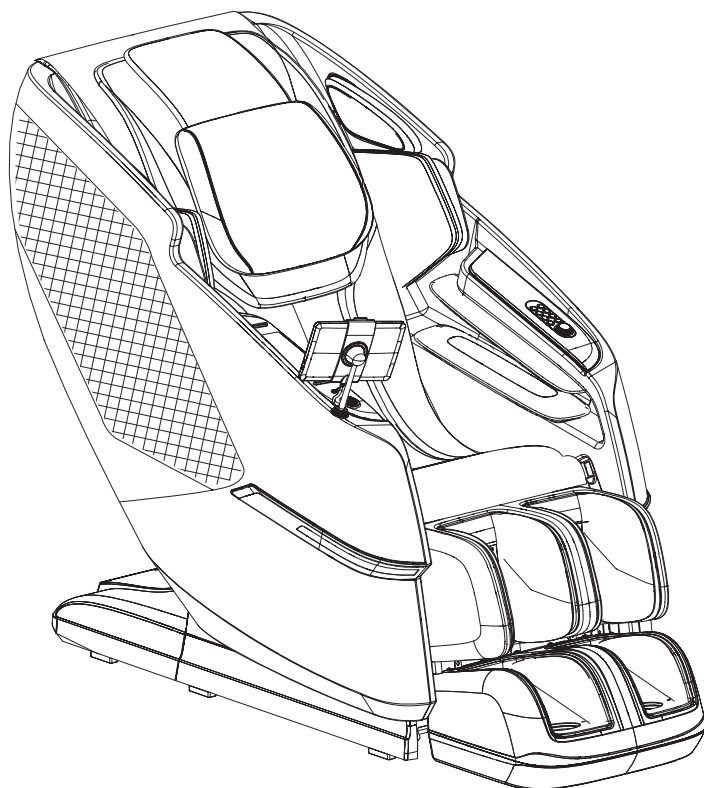

# User Manual

**Kizuna M688  
Massage Chair**

# Your Chair

## External Structure

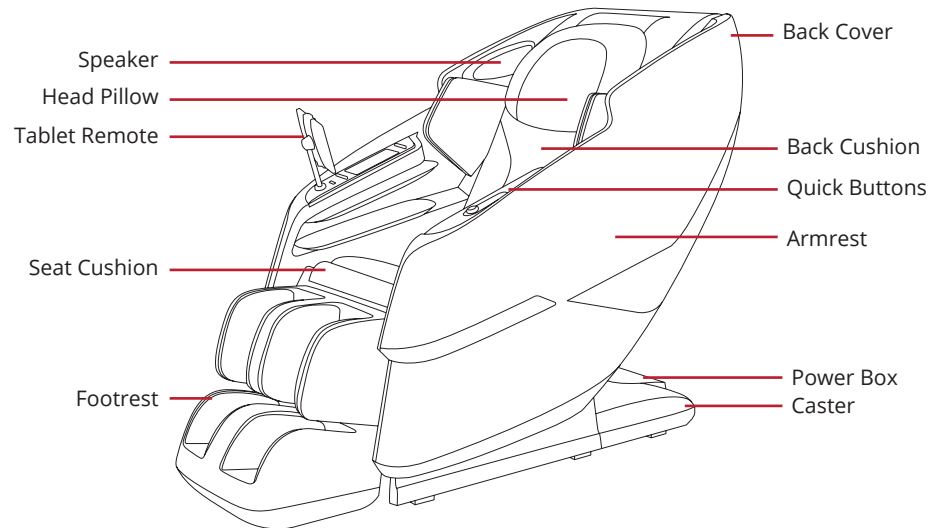

## Welcome to

# KYOTA<sup>®</sup>

Thank you, and congratulations on purchasing your very own Kyota Massage Chair product - you've made a great buying decision. Welcome to the Kyota family.

Please review the entire manual, including all safety information, before assembling or using your chair. If you are assembling the chair yourself, please see the Assembly Guide next and reference the online assembly video.

For convenience, we've also created a Quick Start Guide. Use it as a tool to get to know all the features of your new chair.

**Sit back, relax, and enjoy your new Kyota massage chair!**

## Warranty Registration

Register your product at [www.kyotamassagechairs.com/warranty/registration](http://www.kyotamassagechairs.com/warranty/registration) to ensure it is in our system. This will simplify the warranty process should you ever need it.

Alternatively, **scan the QR code** to go directly to the URL above.



SCAN CODE

## Assembly Video

Before assembling your chair, watch an assembly video at: [www.kyotamassagechairs.com/assembly-tutorials](http://www.kyotamassagechairs.com/assembly-tutorials)

Alternatively, **scan the QR code** to go directly to the URL above.



SCAN CODE

# Chair Features

<b>Dual Back Mechanism</b>
<b>7" Tablet Touch Screen Controller</b>
<b>Zero Wall Fit™ Space-saving Technology</b>
<b>TrueFit™ Body Scanning</b>
<b>Airbag Compression Therapy</b>
<b>Intelligent Voice Command + Control</b>
<b>Smart Health Sensors &amp; Massage</b>
<b>Meditation Programs</b>
<b>Bluetooth Speakers</b>
<b>Wireless Charging Pad</b>
<b>USB Charging Port</b>
<b>Weightless Zero Gravity Recline</b>
<b>Soothing Lumbar Cooling</b>
<b>Gentle Back &amp; Calf Heat</b>
<b>Quick Access Control Panel</b>
<b>Dual Foot Rollers</b>

# Table of Contents

<b>Preparation</b>		
Installation Site	6	
Clearance Space for the Chair	6	
Floor Protection	6	
Move Methods	7	
Connect to Power	7	
<b>Chair Setup</b>		
Main Power Switch	8	
Adjust Pillow	8	
TrueFit™ Body Scanning	8	
Getting out of the Chair	9	
Chair Entry and Exit Hazards	9	
Tablet Remote Layout	10	
Tablet Remote Operation	11	
<b>Getting Started</b>		
Auto Programs	12	
In-Use Screen	13	
Custom Selections	13	
Manual Settings	15	
Smart Massage	16	
Favorite Programs	17	
<b>Personalize Experience</b>		
Adjustments	18	
Sounds	19	
Quick Access Panel	20	
Wireless Charging Pad	22	
USB Charging Port	22	
Intelligent Voice Command	23	
<b>Settings</b>		
Sleep Mode		24
Bluetooth		24
Voice Control		24
Voice Commands List		24
Display Brightness		25
Language		25
Firmware Version		25
Help		25
<b>Staying Safe</b>		26
<b>Fixing Issues</b>		
Troubleshooting		29
Specifications		29
Frequently Asked Questions		30
Warranty		31

# Preparation

## Installation Site

### Clearance Space for the Chair

- 3" clearance for the recline of the backrest; 24" clearance for the extension of footrest and sliding forward of the chair.
- Keep it 3 feet away from the TV, radio or other audio & video appliance to avoid signal interference.

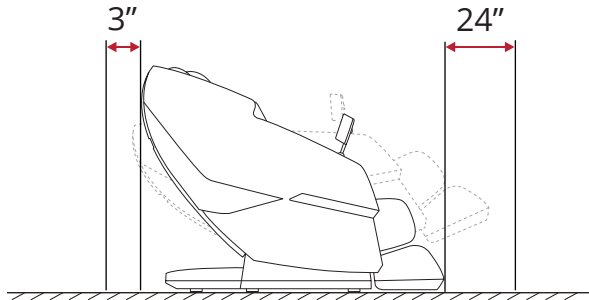

- Keep the distance between the power socket and power switch within 60" to avoid damage of power cord while massage chair sliding forward.
- Straighten the power cord while in use to avoid tangle or damage.



- To avoid serious injury or death, before sliding chair forward or backward check to make sure area is clear of children, pets, or obstacles.

### Floor Protection

We recommend to place a piece of thin carpet or soft mat underneath it to avoid damaging the floor.

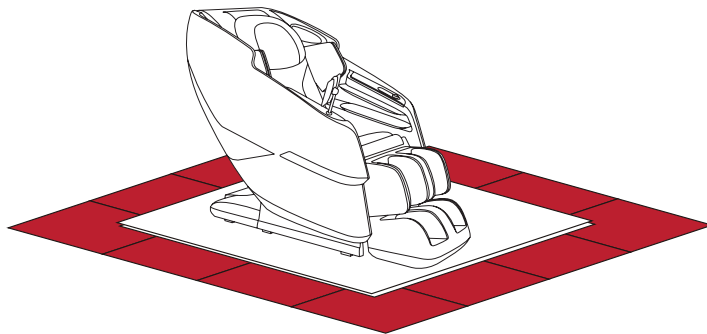

- Do not use the massage chair in high moisture environment such as near a swimming pool or bathroom to prevent electric shock accident.
- Please keep the massage chair away from heated surfaces to prevent fire hazard or damage to the product.

## Move Methods

Apply pressure to the back of the massage chair from behind to pivot on the Castors. Have a second person up front to guide the Footrest until in the correct position. Maintain clearances as mentioned above. Gently lower into place. Do not pull on the side arms.

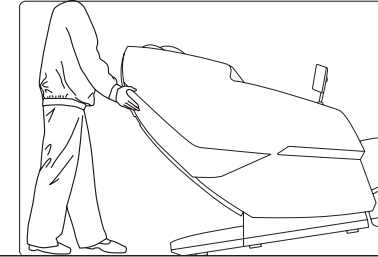

- Do not move the chair when there is user inside.
- Chair is heavy. Use caution and get assistance when lifting to avoid injury. Do NOT lift chair by footrest or armrests to avoid damage to product.

## Connect to Power

Plug into a 110V grounded outlet.



### Grounding Instructions

To avoid risk of electrical shock, turn power switch off before plugging unit into electrical outlet. Use only with properly grounded outlet (3 prong). Do not plug into ungrounded outlet.

**WARNING** – Improper connection of the equipment-grounding conductor can result in a risk of electric shock. Check with a qualified electrician or serviceman if you are in doubt as to whether the product is properly grounded. Do not modify the plug provided with the product – if it will not fit the outlet, have a proper outlet installed by a qualified electrician.

This product is for use on a nominal 120-V circuit and has a grounding plug that looks like the plug illustrated. Make sure that the product is connected to an outlet having the same configuration as the plug. No adapter should be used with this product.

### Earthing

This massage chair is a Class 1 electrical appliance. Make sure to use a grounded outlet to the grounded power supply circuit and a properly installed earth grounding rod with ground connection, to avoid electric shock.

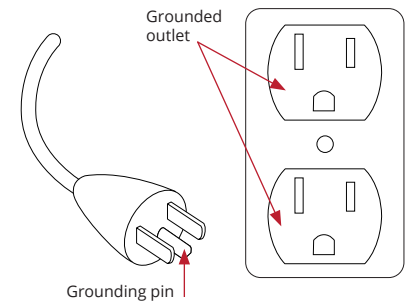

# Chair Setup

## Getting Comfortable

### Main Power Switch

To power up the chair, flip the main power switch located on the back of the base of the chair to ON. Ensure the electrical cord is connected to a 110V grounded outlet and plugged into the power cord port located on the back of the base of the chair.

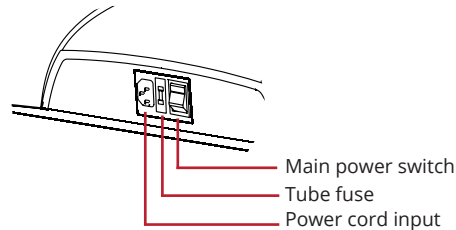

### Tablet Power Switch

With the main power switch ON, touch the display to wake up the screen then press the Power button on the screen. A yellow warning screen will appear, please read and acknowledge by tapping to confirm.



- To avoid possible damage to product or injury to unsupervised children, always turn off the main power switch and unplug massage chair from electrical outlet immediately after use.
- When not in use for a long period of time, we recommend that the chair be covered, the power cord be coiled and that the unit be placed in an environment free of dust and moisture.

### Adjust Pillow

Take a seat in the chair and take note of where the neck pillow rests on your neck. Adjust the pillow so that it rests comfortably in the arch of your neck. To increase intensity to the neck & shoulders, flip it up out of the way, or use the zipper to remove it all together.

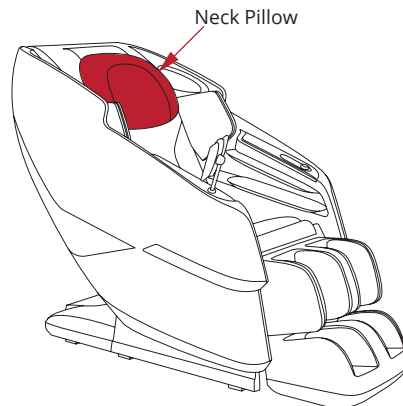

### TrueFit™ Body Scanning

Body scanning is a feature in advanced massage chairs that uses sensors and technology to map the user's body dimensions and contours, identifying key areas such as the shoulders, spine, and hips. This process allows the chair to customize the massage experience by adjusting the position and pressure of the massage mechanisms to suit the user's unique body shape and specific needs. Choose any auto program, let the chair scan your body, then the program will start afterwards. Fine tuning adjustments can be made to the back mechanism locating the highest point for the mechanism to travel during a program. If necessary, reset this position using the up & down arrows after the scan, while the countdown timer is active.

8

### TrueFit™ Body Scanning

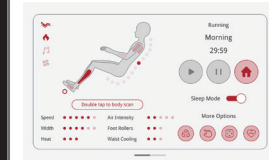
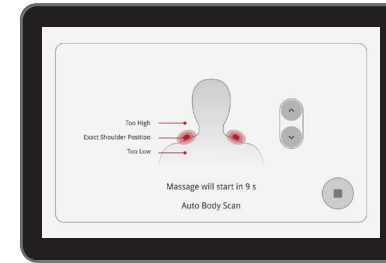

Message program will start after countdown timer

### Getting Out of The Chair

To easily exit the chair at any time, tap the **POWER** button on the upper right of the home display. Alternatively, you can also press and hold the power button found on the left arm panel on the Quick Access Control Panel, until the chair starts resetting.

**WARNING!** Check to make sure children and pets are clear of chair **before** tapping power button to return chair to upright position.

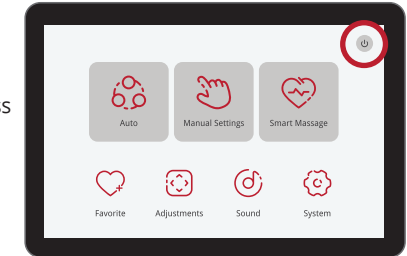

### Chair Entry and Exit Hazards

**WARNING!** The areas under the footrest and behind the back rest are potentially dangerous for a child or pet. The chair back is heavy and reclines with force. A small child or pet located behind the chair could be crushed as chair is reclined resulting in serious injury or death. When chair is reclined, small children or pets who have crawled under the leg rest may not be visible to the user and could be crushed when leg rest is lowered or when chair is returned to upright position. **To avoid serious injury or death, check these areas carefully before reclining, lowering leg rest, or returning chair to upright position.**

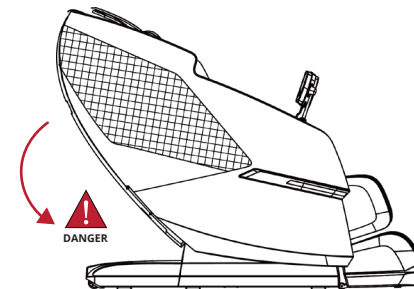

Make sure to check for children or pets **between the chair back and the base of the chair** before entering zero gravity recline.

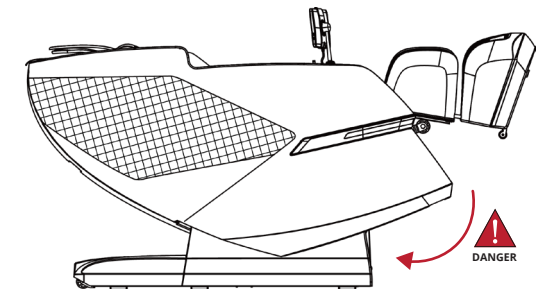

Make sure to check for children or pets **underneath the footwell** before exiting zero gravity recline and returning to upright position.

9

# Chair Setup

## Tablet Remote Layout

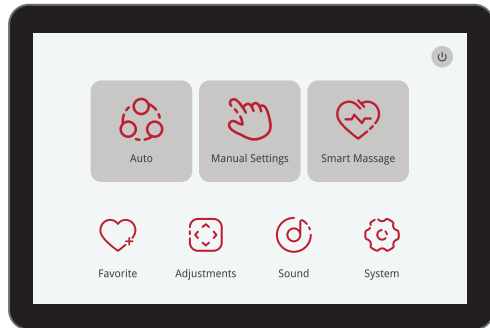

1.

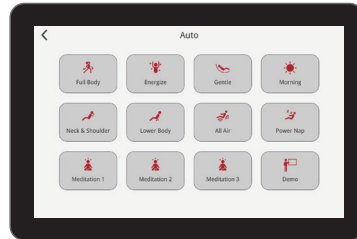

2.

3.

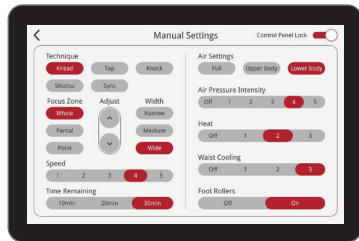

4.

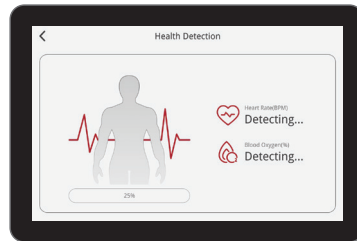

5.

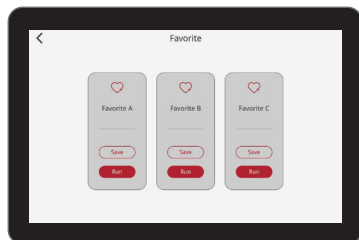

6.

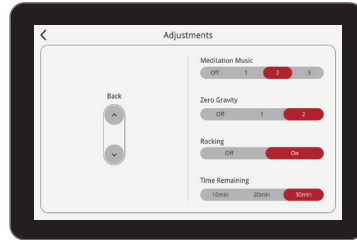

7.

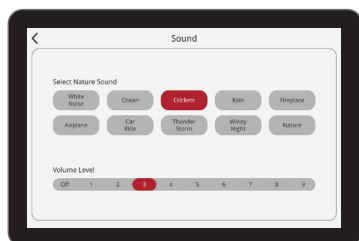

8.

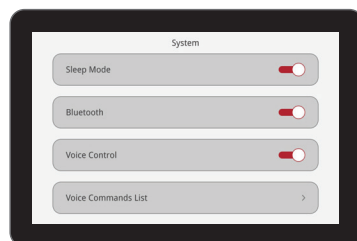

## Tablet Remote Operation

**1. Home Page** – After turning on your chair, this is the first screen you will see on your Tablet Remote. Use this screen to navigate all menu options. To select, simply tap the screen with your finger.

**2. Auto Programs** – Select from 12 pre-set auto programs. To select simply tap the auto program you wish to run.

**3. Manual Settings** – Have a particular spot that needs more work? Take the power of massage into your own hands with Manual Settings. Use this screen to fully customize your own massage and find the perfect treatment for you.

**4. Smart Massage** – A customized program that integrates artificial intelligence and custom massage work into one. Place your finger on the health detection module on the bottom right of the armrest. Wait until the scan stops and your chair will recommend programs to try.

**5. Favorite** – Recalls programs saved to memory.

**6. Adjustments** – While your massage program is running, use this screen to make adjustments to the programs and chair.

**7. Sound** – Use this screen to select and control Nature Sounds feature of your chair. The selected sound will play from the Bluetooth speakers. To turn nature sounds off, de-select the activated sound.

**8. System** – Access the system settings from this page such as sleep mode, Bluetooth, voice control, help, and more.

# Getting Started

## Auto Programs

From the home display, tap the **AUTO** button to enter Auto Program Menu. From here you can choose from a selection of 12 pre-choreographed massage programs. To start, tap the program you wish to run, wait for the body scan, and enjoy your massage.



**Full Body** – Reduce built up tension carried in the body or unwinding after a stressful day.

**Energize** – Re-invigorate stiff muscles and boost energy levels after physical activity.

**Gentle** – A gentle approach in fine tuning a massage perfect for beginners.

**Morning** – Start your routine right, set for the morning, easy stretching and mobility.

**Neck & Shoulder** – Designed to be an incredible injury prevention program. Mainly targets the neck and shoulders.

**Lower Body** – Focused specifically on the glutes. This program brings relaxation to your lower body to relieve built up tension.

**All Air** – Air compression therapy relieves the whole body, best for tired or weak muscles.

**Power Nap** – A revitalising massage that is ideal for a mid-day boost.

**Meditation 1** – This program is designed to relax the body both physically and emotionally. A unique combination of varying intensities brings the mind into a peaceful state with melodic music.

**Meditation 2** – Breathe in deeply and exhale your stress while this rhythmic massage program works to alleviate your tired muscles, reinvigorate your spirit, and plays meditative music.

**Meditation 3** – This program is crafted to provide relaxation for both the body and mind, using a distinctive blend of varying intensities to induce a state of emotional and physical calm with the addition of meditative music.

**Demo** – Quick 6 minute show of the massage chair's functions and features.

## In-Use Screen

After adjusting your shoulder height, you will be taken to the In-Use screen where you can observe all current settings and session information.

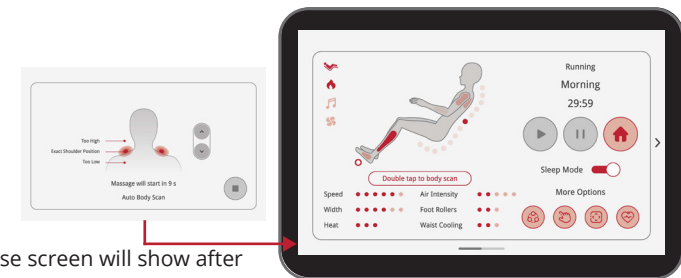

The In-Use screen will show after the body scan is complete

## Custom Selections

To personalize your massage to your exact needs, tap the right arrow or swipe right on the Tablet Remote from the In-Use Screen to be taken to the **Custom Selections** screen.

The **Custom Selections** screen can be used to tailor your massage exactly to your needs. Here you will have complete control over the duration, airbag settings/intensity, foot rollers, back & calf heat plus soothing cooling options. To return to the In-Use screen, simply swipe left or tap the arrow on the Tablet Remote screen, which will take you to the In-Use screen.

If you slide on the **Control Panel Lock** (top right corner of screen), this screen will not revert back to the In-Use screen so you can make continuous adjustments. Slide off to unlock again.

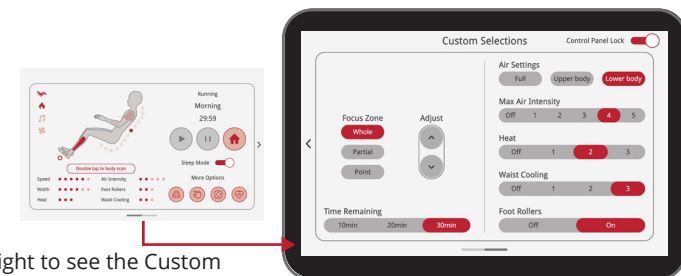

Swipe Right to see the Custom Selections screen

# Getting Started

## Focus Zone

Targets for concentrated massage therapy, using specialized techniques and adjustable settings such as Whole, Partial, and Point, to relieve tension and enhance relaxation.

## Adjust

Customizable settings that allow users to move the back mechanism to a different location when in Partial or Point mode.

## Time Remaining

Tap screen to select your desired massage timer length; **10 minutes**, **20 minutes**, or **30 minutes**. The massage chair will turn off automatically and reset after the timer is up.

## Air Settings

Choose your desired airbag region/s: **Full**, **Upper Body**, or **Lower**. Tap screen to select setting. To turn a particular airbag region off, de-select the activated region. Selecting **Full** will override any selections and ALL airbags become active.

## Max Air Intensity

Increase or decrease maximum intensity of airbag massage. All auto massages are pre-programmed to have varying levels of airbag intensity, this setting will set the upper limit of these fluctuations. **1 = light**, **5 = firm**, or **Off**. Tap screen to select setting.

## Heat

Activate gentle back & calf heat and choose your desired heating intensity level: **1 = low**, **2, 3 = high**, or **Off** (deactivate heating). Tap screen to select setting.

## Cooling

Activate lumbar cooling and choose your desired cooling intensity level: **1 = low**, **2, 3 = high**, or **Off** (deactivate lumbar cooling). Tap screen to select setting.

## Foot Rollers

Choose your desired foot roller selection to either be On or Off. Tap screen to select setting.

## Manual Settings

From the home display, tap the **MANUAL SETTINGS** button to enter manual settings screen. From here you can choose from a selection of manual settings customized for your massage.

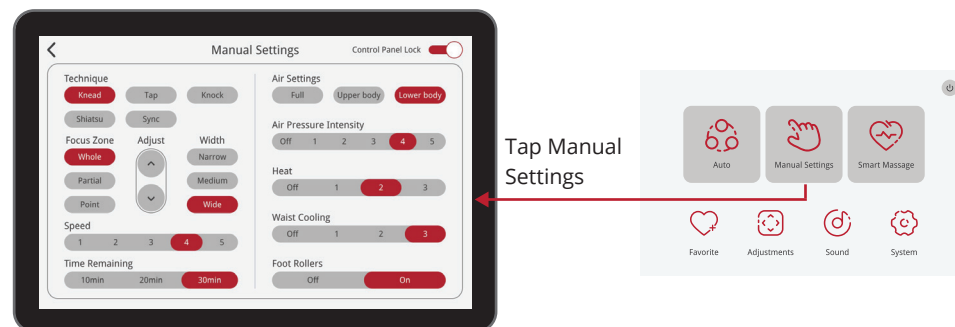

## Technique

Utilizes mechanical movements and features, such as Kneading, Tapping, Knocking, Shiatsu, and Sync, to mimic the hands-on methods of a massage therapist, providing targeted relief and relaxation to various muscle groups in the body.

## Focus Zone

Targets for concentrated massage therapy, using specialized techniques and adjustable settings such as Whole, Partial, and Point, to relieve tension and enhance relaxation.

## Adjust

Customizable settings that allow users to move the back mechanism to a different location when in Partial or Point mode.

## Width

Adjust the distance between the massage rollers or nodes, enabling the chair to accommodate different body sizes and provide a tailored massage experience by targeting specific muscle groups more effectively.

## Speed

Controls the rate at which the massage rollers or mechanisms move, allowing users to adjust the pace of the massage to either a gentle, soothing rhythm or a more vigorous, invigorating experience.

## Time Remaining

Set the run time of your massage shorter or longer depending on your needs.

## Air Settings

Air settings regulate the distribution of air compression applied by the chair's airbags, allowing users to customize the location of their massage.

# Getting Started

## Air Pressure Intensity

Air pressure intensity refers to the level of force applied by an air compression system in massage devices, which can vary to provide different degrees of pressure and stimulation to targeted body areas for therapeutic benefits.

## Back & Calf Heat

Back & calf heat refers to the application of therapeutic heat to the upper back area, which can help alleviate muscle tension, reduce pain, and promote relaxation by increasing blood flow to the affected region.

## Lumbar Cooling

Lumbar cooling involves applying therapeutic cold to the lower back area, which can help reduce pain and inflammation, alleviate muscle tension, and promote relaxation by constricting blood vessels and numbing sore tissues.

## Foot Rollers

Foot rollers are massage tools designed to relieve tension and improve circulation in the feet by allowing users to roll their feet over the textured surface, applying pressure to specific areas and stimulating acupressure points.

## Smart Massage

Smart Massage uses sensors and AI to personalize the massage experience. The AI system automatically adjusts the massage intensity and techniques, aiming to replicate the adaptive nature of a human masseuse for a customized and effective treatment. From the home page tap Smart Massage then tap Start Scanning.

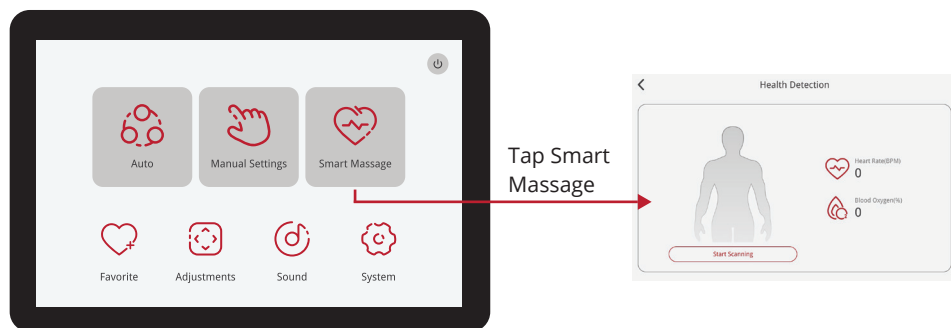

## Heart Rate

Heart rate refers to the number of times a person's heart beats per minute and is a vital indicator of cardiovascular health. It can vary based on factors such as physical activity, stress, illness, and overall fitness levels for adults.

## Blood Oxygen

Blood oxygen levels refer to the amount of oxygen circulating in the blood, typically measured as a percentage known as oxygen saturation (SpO2). Reviewing Blood Oxygen is important to ensure that organs and tissues receive the oxygen they need to function properly.

## Favorite Programs

Saving favorite programs in a massage chair allows users to quickly access their preferred massage settings and routines without having to reconfigure them each time. This feature enhances convenience and personalization by storing user-specific preferences for a more tailored and consistent massage experience. From the home display, select FAVORITE to go to the Favorite screen, tap save or run to initiate the program.

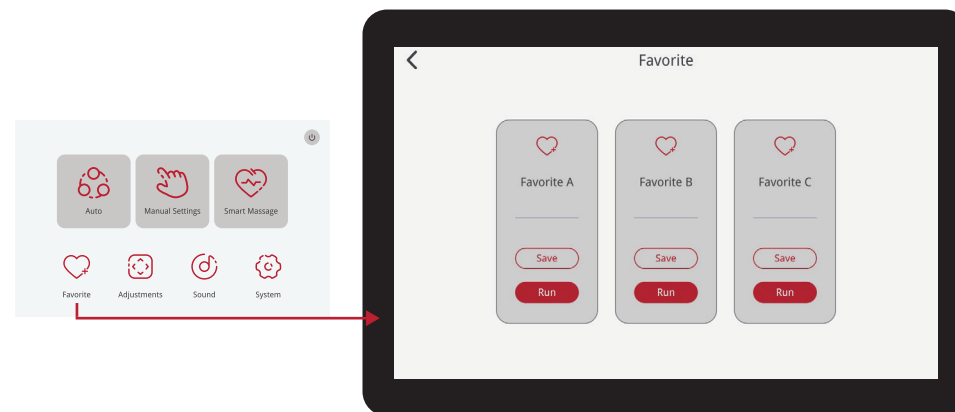

## Save

To save a program, tap save. This will allow you to save your favorite program to one of the slots. Tapping Save on a previously saved memory slot will erase the old program and replace it with the new program.

## Run

After saving a program, you can tap run to initiate the program.

# Personalize Experience

## Adjustments

While your massage program is running, use the **Adjustment** screen to make adjustments to your chair angle, Meditation Music, Zero Gravity, Rocking, and Time Remaining.

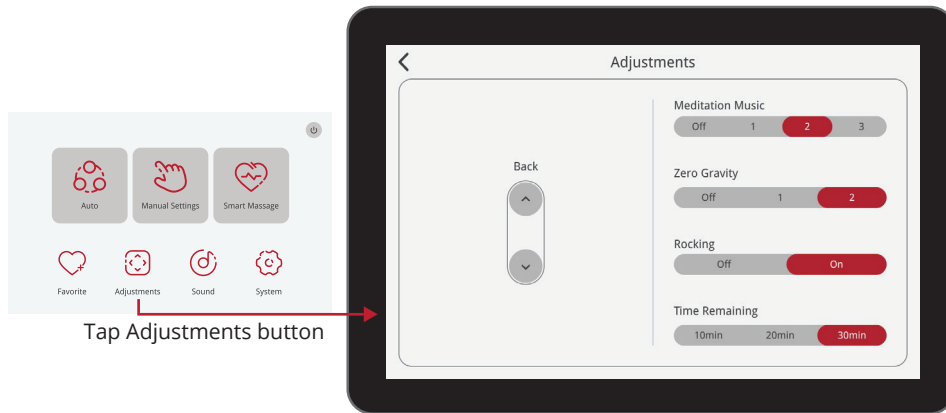

### Back

Press the up arrow to incline the chair, press the down arrow to recline the chair.

### Meditation Music

Sit back and relax as the chair takes you into a deep relaxing massage as meditative music plays in the background through the speakers when running Meditation 1,2, and 3 programs.

### Zero Gravity

Use this setting to enter Weightless Zero Gravity Recline. Zero Gravity elevates your feet up over your heart to improve overall circulation and reduces gravitational force on your spine for a sense of weightlessness.

### Rocking

Use this setting to enter a state of rocking back and forth, this feature is great for those who want a traditional method of a rocking chair. Select Rocking ON to add chair movement to any massage Auto program.

### Time Remaining

Choose between 10 Minutes, 20 Minutes, and 30 Minutes, choosing one of these options will reduce or expand the time of your current session by up to that amount of time.

## Sounds

Tap **Sound** on the home display to enter the **Sound** display screen. Use this screen to select and control the Nature Sounds feature of your chair. The selected sound will play from the speakers next to your head. To turn Nature Sounds off, de-select the activated sound.

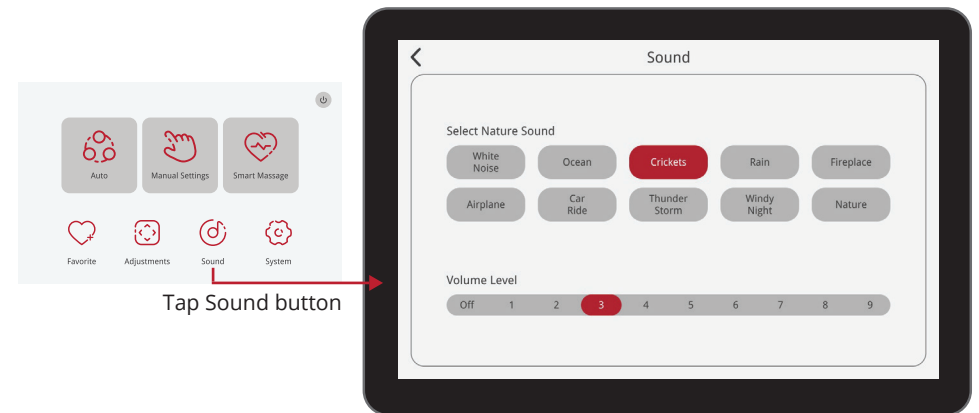

### Volume Level

Increase or decrease volume of Nature Sounds. **1 = low, 9 = high, or Off.** Tap screen to select setting.

Sounds	What is it
<b>White Noise</b>	A constant, even loop of pure white noise to mask out distractions
<b>Ocean</b>	Soothing ocean waves rolling on the shore
<b>Crickets</b>	Night time in the suburbs. Churping crickets, water trickling from a pond, and faint traffic noises
<b>Rain</b>	Quiet, light, refreshing rain falling to the ground
<b>Fireplace</b>	Crackling of fire in a fireplace
<b>Airplane</b>	A Cessna propeller airplane motor idling
<b>Car Ride</b>	Calming inner-city traffic featuring cars, trucks, and motorcycles
<b>Thunderstorm</b>	Heavy rainstorm with thunder
<b>Windy Night</b>	Heard from inside a cabin, a howling wind blows constantly outside
<b>Nature</b>	Refreshing sounds of small birds peacefully singing along a tranquil stream

# Personalize Experience

## Quick Access Panel + Dial & Button Control

The Quick Access Panel + Dial & Button Control allows you to turn the chair on and off, cycle through auto programs, and adjust recline settings.

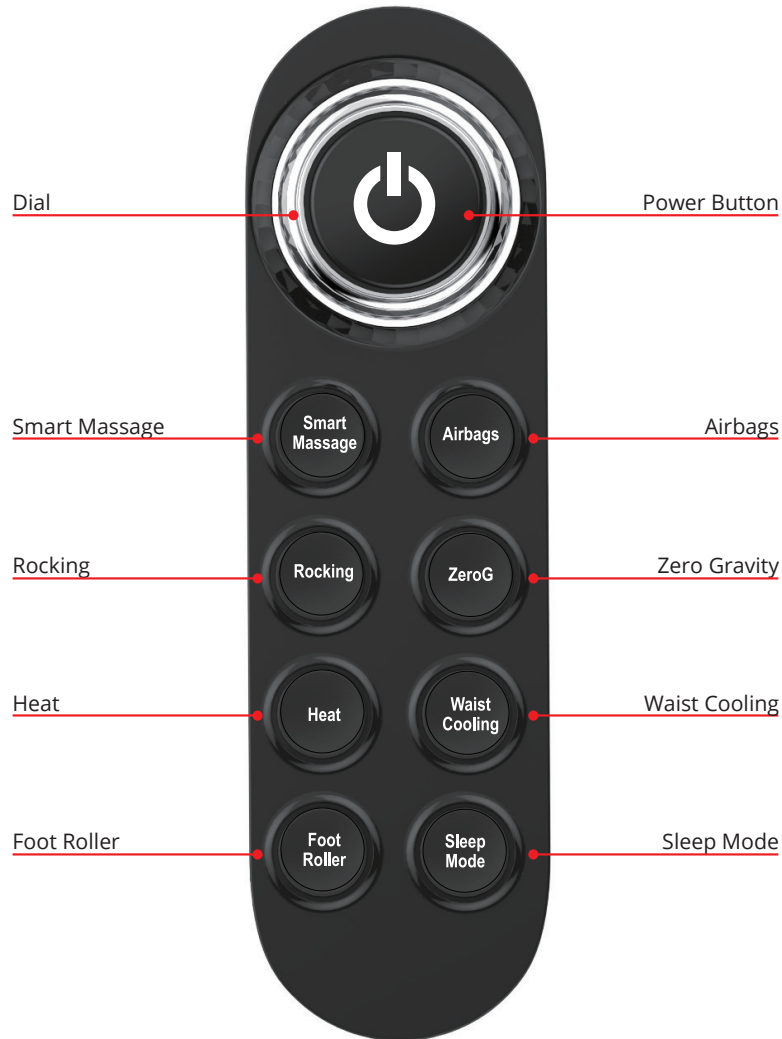

## Power Button

Press and hold the power button to turn on the massage chair, the light will illuminate. Press and hold the power button again to turn off, the light will no longer be illuminated. When the chair is On, a quick press of the power button will advance to the next Auto Program.

## Dial Button

Turn the dial left to reduce the recline, or right to increase the recline.

## Smart Massage

Smart Massage uses sensors and AI to personalize the massage experience.

## Airbags

Increase or decrease Airbag intensity. Cycles up in intensity then resets to the lowest intensity sequentially.

## Rocking

Turns Rocking feature on and off.

## Zero Gravity

One touch to full recline, touch again to Zero Gravity recline, touch a third time to upright the chair.

## Back & Calf Heat

Heating cycles through low, medium, high and off.

## Waist Cooling

Turns waist cooling on and off.

## Foot Roller

Cycles through foot roller speeds slow, medium, fast, and off.

## Sleep Mode

Sleep mode on or off.

# Personalize Experience

## Wireless Charging Pad

Your message chair has a built-in **Wireless Charging Pad** which allows you to charge your smart devices\* simply by placing them on the pad located on the right arm panel.

*Note: If the chair is powered on the charging always works. If the chair is powered down the wireless charging pad will also shut off. If the main switch at the base is turned off, charging will not work.*

\*Requires phone with wireless charging capabilities.

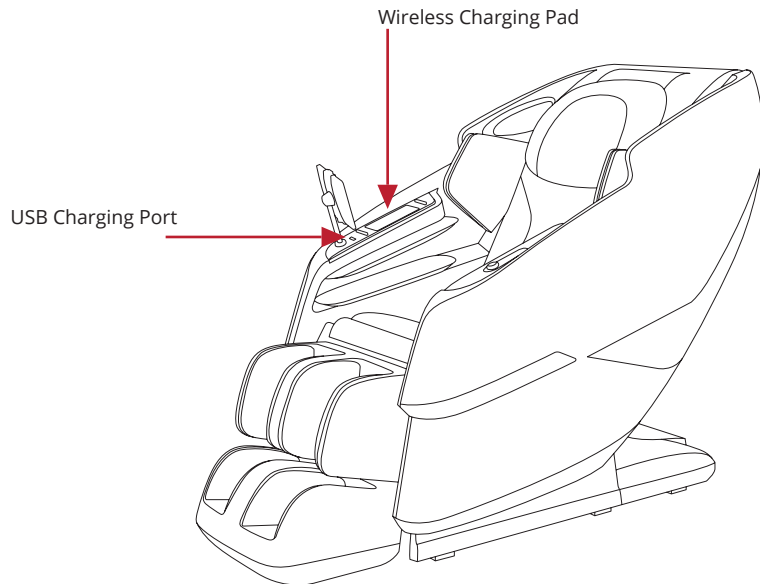

## USB Charging Port

In addition to your wireless charging pad, there is a USB Charging Port next to the 7" Tablet Remote. Plug your favorite electronic device in to recharge.

## Intelligent Voice Command + Control

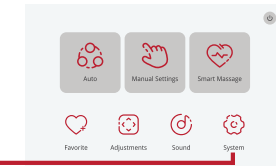
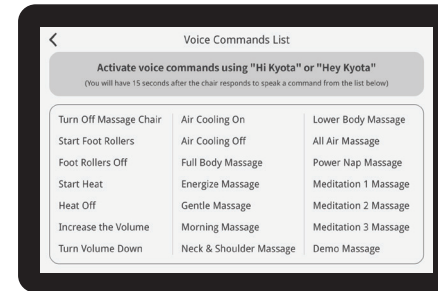

A Voice Commands listing can be found in System. Tap the back arrow to exit when done.

Your chair comes with built in intelligent voice command + control. This feature allows you to control your chair and massage experience completely hands-free by using one of the many voice commands. *Voice Commands work best when the Audio is either off or on a low volume so your voice can be clearly heard.*

### Turn On Listening

To turn on the intelligent voice control function, tap **Setting** from Home display, then tap **Voice Control** to turn **On**.

### Turn Off Listening

You can turn off intelligent voice control listening by using the tablet remote. Tap **Setting** from Home display, then tap **Voice Control** to turn **Off**. Intelligent voice control will now no longer activate until turned back on.

### Activating Voice Control

To activate, simply say **"Hey Kyota" OR "Hi Kyota" (Key-Oh-Ta)**. You may now give your chair any of the listed commands **within 15 seconds**. Make sure to speak clearly and slowly. After 15 seconds the Intelligent Voice Command function will go to sleep automatically and must be awakened again by saying the activation phrase **"Hey Kyota" OR "Hi Kyota"**.

**Kyota is pronounced:  
"Key-Oh-Ta"**

Say Phrase

**"Hey Kyota" OR "Hi Kyota"**

Then speak one of the following  
**Commands**

- Turn Off Massage Chair**
- Start Foot Rollers**
- Foot Rollers Off**
- Start Heat**
- Heat Off**
- Increase the Volume**
- Turn Volume Down**
- Air Cooling On**
- Air Cooling Off**
- Full Body Massage**
- Energize Massage**
- Gentle Massage**
- Morning Massage**
- Neck & Shoulder Massage**
- Lower Body Massage**
- All Air Massage**
- Power Nap Massage**
- Meditation 1 Massage**
- Meditation 2 Massage**
- Meditation 3 Massage**
- Demo Massage**

# Settings

## Settings

Tap **Setting** on the home display to enter the system display screen. Use this screen to adjust and personalize your chair and Tablet Remote settings. Tap the arrow on the top left screen to return to the main menu.

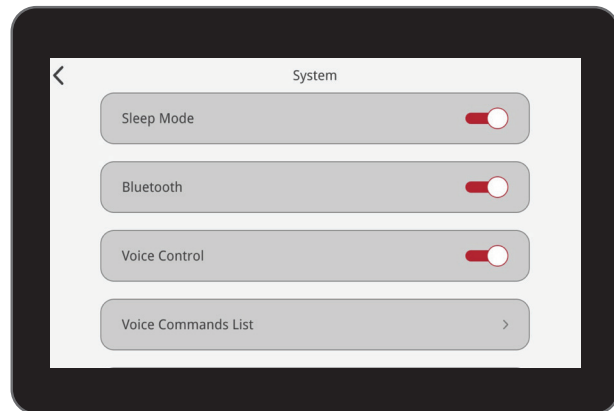

### Sleep Mode

Toggle your desired sleep mode setting: **On or Off**. Tap screen to toggle setting. When sleep mode is **on** the chair will stop in the reclined position after Auto Programs, when sleep mode is **off** the chair will return to a fully upright position after each Auto Program.

### Bluetooth

Toggle your chair's Bluetooth® setting: **On or Off**. Tap screen to toggle setting. Open Bluetooth from audio device and pair with **M688 Kizuna** to play music.

To play music from your Bluetooth® enabled audio device, Bluetooth® must first be turned **on**.

### Voice Control

Toggle your chair's voice control. Select to activate intelligent voice command + control and turn on active voice listening. Once activated, simply say 'Hey/Hi Kyota'. After the chair responds, you may use this feature.

### Voice Commands List

Use this screen option to quickly pull up the voice commands list.

## Display Brightness

Increase or decrease the brightness of the Tablet controller.

## Language

Your chair comes with two different languages, choose between English and Chinese.

## Firmware Version

Displays the current firmware version.

## Help

If you need additional help with your chair, this setting will provide Kyota's customer service number.

# Staying Safe

## Safety Information

To ensure safe use of the massage chair and avoid injury or unsafe conditions, please read and follow all instructions before using product.

### ⚠️ WARNING

#### USE NOT RECOMMENDED FOR CERTAIN PERSONS

Use of massage chair may not be safe or suitable for persons with certain medical conditions and could cause serious injury or death in some circumstances. If you have any of the following conditions, please consult a physician before using the massage chair:

- Use of implanted electronic medical devices (such as a cardiac pacemaker)
- Pregnancy
- Cancer, malignant tumors, or other growths
- Osteoporosis or spinal fracture
- Other fractures or musculoskeletal injuries
- Loss of or reduced sensitivity to heat
- Implanted medical fixation devices such as rods, pins, etc.
- Recent surgery or sutures
- Skin diseases or skin injury
- High fever
- Certain pulmonary or breathing conditions
- Impaired circulation

### ⚠️ WARNING

To avoid possible death or serious injury to user or others, please read and follow these instructions:

- **The areas under the footrest and behind the back rest are potentially dangerous for a child or pet. The chair back is heavy and reclines with force. A small child or pet located behind the chair could be crushed as chair is reclined resulting in serious injury or death. When chair is reclined, small children or pets who have crawled under the leg rest may not be visible to the user and could be crushed when leg rest is lowered or when chair is returned to upright position. To avoid serious injury or death, check these areas carefully before reclining, lowering leg rest, or returning chair to upright position.**
- **Chair should not be used by children under age 14.** Small children could be trapped or injured by airbags, heating mechanism, or moving parts. When chair is not in use, unplug unit and secure chair so that children cannot accidentally power on and operate chair.
- Children over age 14, persons with reduced physical, sensory, or mental capabilities, and elderly or frail persons should exercise caution and use massage chair only when supervised or assisted by a person over 16 years of age.
- Chair has a heated surface and could cause burns, particularly in persons with reduced sensitivity to heat. Such persons should use the chair only after consulting with a physician and should use extreme caution during any physician-approved use.

### ⚠️ CAUTION

To avoid the risk of minor injury or discomfort, or damage to the massage chair or other property, please read and follow these instructions for safe use of massage chair:

- Do not stand or stack heavy objects on footrest.
- Do not operate heating features of chair while under a blanket or pillow. Excessive heating can occur and cause fire, electric shock, or injury to persons.
- To avoid pinching or crushing, please do not place body parts, especially fingers and toes, between parts of chair and keep clear of moving parts.
- To avoid overheating, injury or discomfort from overuse, do not fall asleep while using massage chair and do not use for extended periods of time (longer than 20 minutes).
- Avoid use while under the influence of alcohol, medications or other substances that may cause drowsiness, disorientation, or impairment of judgment or motor skills.
- Do not use the massage chair right after a meal, as it may cause discomfort.
- If you feel any abnormal discomfort during the operation of the massage chair, turn off the power immediately and discontinue use.
- Do not use this appliance when ambient temperature is over 40 C (104 F).
- Do not use this appliance in humid or dusty environment, or when any part of the body is in contact with plumbing or any similar ground.
- Never operate the appliance with the air openings blocked. Keep the air openings free of lint, hair, dust and the like.
- Do not use outdoors.
- Do not operate where aerosol (spray) products are being used or where oxygen is being administered.
- Place the product on a flat, level floor to reduce risk of tipping or overturning.
- Do not use or store near heat or open flame.
- Intended only for users who weigh below 300 lbs.
- Use this product only for its intended use as described in this manual. Do not use attachments not recommended by the manufacturer.
- Massage chair intended only for use by one person. Do not use by two or more persons at the same time to avoid damage to the product.
- Do not allow children to stand, jump, or play on or around massage chair, even when it is not powered on or in use.
- Remove personal accessories from arms and empty pockets while using the massage features of the chair.
- Check the upholstery under the cushions and other spots for damage or loose objects that may cause injury or damage chair while operating. If any damage is present, do not use the massage chair and refer to a qualified service professional for servicing.
- To avoid damage to chair, walls, or other objects, make sure there are no obstacles behind the chair and there is enough clearance before adjusting the backrest or leg rest angle.
- Please be seated properly while using the product.

# Staying Safe

- To avoid damage to chair or floors, do not drag or push the chair or roll its casters on wood floor or carpet. See instructions on p.6 for safely moving chair.
- If massage chair is not working properly, has been dropped or damaged, or has been dropped into water or exposed to flooding, return the appliance to a service center for examination and repair before attempting to use.
- Do not drop or insert any object into any openings in chair.

## WARNING

**Read and follow these instructions concerning safe use of the power cord and power unit to avoid possible electric shock, fire hazard, use of chair by and injury to unattended children, or damage to chair or other property.**

- To avoid risk of electric shock, connect this unit to a properly grounded outlet only. See Grounding Instructions on pg. 7.
- Always unplug massage chair from the electrical outlet immediately after use and before cleaning. An appliance should never be left unattended when plugged in. To disconnect, turn all controls to the off position, then remove plug from outlet.
- Do not use massage chair and unplug from outlet during thunder or lightning storms, and before putting on or taking off parts.
- To ensure safe operation, power must be supplied only at standard 110 voltage, to the specifications of the appliance. Confirm that the power voltage stated on the rating label corresponds to your local electricity supply.
- The massage chair should be used only with the power supply unit provided. Do not use with any other power source
- Do not use a wet or damp hand to unplug the cord to avoid electric shock.
- Do not pull on the power cord to unplug. Grip by plastic end nearest outlet to unplug power cord.
- Do not squeeze, over bend, pull hard, or twist the power cord. - Keep the power cord away from heated surfaces.
- Do not carry or drag the chair by power cord or use cord as a handle.
- If there is any smoke or unusual smell while using massage chair, stop using immediately and unplug the power cord.
- Never operate the chair if it has a damaged power cord or plug. If the power cord is damaged, it must be replaced by the manufacturer or its service agent or a similarly qualified person to avoid a hazard.

**Do not disassemble, dismantle or attempt to repair massage chair. Such actions, as well as misuse of product, may cause damage to or failure of massage chair and may void the manufacturer's warranty. For repairs, please contact an authorized dealer or repair agent at 1-603-910-5333. For additional details concerning terms, conditions and limitations of warranty, see <https://kyotamassagechairs.com/warranty-info>.**

## Trouble Shooting

Symptoms	Possible Causes	Possible Solution
<b>Noise is heard while in use</b>	These noises are normal and arise from friction between the massage rollers and the leather cover	No need to take any measures
<b>Massage Chair does not start</b>	The power cord is not secured into the socket Not switched ON The fuse is blown	Insert the power plug properly into the power socket Turn on the switch found on chair side. Then push power button on remote Replace only with a fuse of same type and rating
<b>No music comes from the speaker</b>	The volume is turned to the lowest setting	Adjust the speaker volume from the mobile device. Make sure the Bluetooth setting on chair and phone are both ON
<b>Backrest or footrest can not raise or recline</b>	Excessive load has been pressed on the backrest or legrest	Replace the load and try again
<b>Airbag malfunction</b>	The air hose is blocked	Straighten the air hose and clear out the blockage

## Specifications

<b>Model</b>	Kizuna M688 Massage Chair
<b>Dimension of Main Body (in)</b>	60.23" x 29.52" x 45.27" (L X W X H)
<b>Necessary Clearance to Wall (in)</b>	3"
<b>Net Weight (lbs)</b>	174.6lbs
<b>Shipping Weight (lbs)</b>	202.4lbs
<b>Max. User Weight</b>	300lbs
<b>Voltage</b>	110-120V~
<b>Rated Current</b>	1.32A
<b>Power Consumption</b>	105W

# Fixing Issues

## Frequently Asked Questions

**Q: I find the chair is too intense to be comfortable. What can I do?**

**A:** Your body needs to become acclimated to therapeutic massage. To be effective, the massage techniques must compress the tissue in your body. We recommend the following steps to help get started. Then over time as your body acclimates you can increase the intensity by reducing the layers between you and the chair.

1. Use the body pillow and pillow pad to reduce upper body intensity.
2. Go into settings and turn Airbag intensity setting to 1.
  - If a specific airbag is too intense, turn on only the airbags you want.
3. Turn foot rollers off.
4. Adjust the recline on the remote. More upright will be less intense. Zero Gravity will be more intense.

**Q: I'm not a foot massage person, what should I do?**

**A:** Turn off Foot Rollers. From the Controls screen, Use the Foot Rollers control to deactivate the Foot Rollers. You may also want to use the Airbag Setting control to turn off the Leg/Foot airbags.

**Q: My chair is not performing as expected. What should I do?**

**A:** Your Kyota massage chair is an amazing combination of programming and robotics. On occasion the chair just may need to be rebooted. To do this power down the chair and unplug from the wall for 5 minutes then plug back in and power back up to see if it self-healed. If you are still having an issue, give Kyota a call at 603-910-5333.

**Q: I can never seem to get in my Kyota Massage chair, someone is always in it.**

**A:** We know. It happens. Tell your friends to get their own Kyota Chair.

## Warranty

This Kyota Massage Chairs is protected by Kyota's 4 Year U.S./Canada Residential Limited Warranty. For more information, scan the QR code below and click on the **Kyota Promise** tab.



**KYOTA<sup>®</sup>** | **The World's Most  
Advanced Massage Chairs<sup>®</sup>**

72 Stard Road, Seabrook, NH 03874

1-603-910-5333

[www.kyotamassagechairs.com](http://www.kyotamassagechairs.com)

Version 1.3