

User Manual

020-000883-04

HS Series D13HD-HS/D13WU-HS



CHRISTIE[®]

The CD included with this printed manual contains an electronic copy in English. Please read all instructions before using or servicing this product.

手册中包含的光盘，带有着中文的电子副本，使用或维修本产品前，请仔细查阅所有的指示。

Le DC fourni avec ce manuel imprimé contient une copie électronique en français. S'il vous plaît lire toutes les instructions avant d'utiliser ou de réparer ce produit.

Das CD, das mit diesem gedruckten Handbuch eingeschlossen ist, enthält eine elektronische Kopie auf in deutscher Sprache. Vor der Anwendung oder der Instandhaltung dieses Produktes lesen Sie bitte alle Anweisungen.

Il CD fornito con il manuale stampato contiene una copia elettronica in lingua italiano. Si prega di leggere tutte le istruzioni prima di utilizzare o riparare questo prodotto.

この印刷されたマニュアルに同梱されております CD には、日本語での説明書が入っております。この製品を使用あるいは修理点検される際に、ご参照下さい。

매뉴얼과 함께 포함되어 있는 CD 에는 한글로 된 전자사본을 포함하고 있습니다 . 본 제품을 사용 혹은 서비스하기 전에 모든 지침 사항들을 읽어 보시기 바랍니다 .

Поставляемый в комплекте с документацией компакт-диск (CD) содержит электронную копию руководства пользователя на русском языке. Перед началом использования изделия или проведения сервиса пожалуйста прочтите все инструкции изложенные в руководстве.

El DC incluido con este manual impreso contiene una copia electrónica en español. Por favor, lea todas las instrucciones antes de usar o dar servicio a este producto.

Компакт диск, що постачається з цим друковане керівництво містить електронну копію українською мовою. Будь ласка, прочитайте всі інструкції перед використанням або обслуговуванням цього продукту.

O CD incluído com o impresso livro contém um eletrônico cópia em Português. Por favor lido todas as instruções antes de usar ou prestando serviço esse resultado.

NOTICES

COPYRIGHT AND TRADEMARKS

Copyright © 2017 Christie Digital Systems USA Inc. All rights reserved.

All brand names and product names are trademarks, registered trademarks or trade names of their respective holders.

REGULATORY

The product has been tested and found to comply with the limits for a Class A digital device, pursuant to Part 15 of the FCC Rules. These limits are designed to provide reasonable protection against harmful interference when the product is operated in a commercial environment. The product generates, uses, and can radiate radio frequency energy and, if not installed and used in accordance with the instruction manual, may cause harmful interference to radio communications. Operation of the product in a residential area is likely to cause harmful interference in which case the user will be required to correct the interference at the user's own expense.

WARNING! Changes or modifications not expressly approved by Christie could void the user's authority to operate the product.

FOR COMMERCIAL USE ONLY - POUR USAGE COMMERCIAL UNIQUEMENT

THIS DEVICE COMPLIES WITH PART 15 OF THE FCC RULES. OPERATION IS SUBJECT TO THE FOLLOWING 2 CONDITIONS: (1) THIS DEVICE MAY NOT CAUSE HARMFUL INTERFERENCE (2) THIS DEVICE MUST ACCEPT ANY INTERFERENCE RECEIVED, INCLUDING ANY INTERFERENCE THAT MAY CAUSE UNDESIRE OPERATION.

THIS CLASS A DIGITAL APPARATUS MEETS ALL REQUIREMENTS OF THE CANADIAN INTERFERENCE-CAUSING EQUIPMENT REGULATIONS.

CET APPAREIL NUMÉRIQUE DE CLASSE A EST CONFORME AUX NORMES DÉFINIES DANS LES RÉGLEMENTATIONS CANADIENNES SUR LES APPAREILS CAUSANT DES INTERFÉRENCES RADIO (CANADIAN INTERFERENCE-CAUSING EQUIPMENT REGULATIONS, ICES-003, CLASS A).

声明 此为 A 级产品，在生活环境中，该产品可能会造成无线干扰。在这种情况下，可能需要用户对其干扰采取切实可行的措施。

이 기기는 업무용 (A 급) 으로 전자파적합등록을 한 기기이오니 판매자 또는 사용자는 이점을 주의하시기 바라며, 가정 외의 지역에서 사용하는 것을 목적으로 합니다.

GENERAL

Every effort has been made to ensure accuracy, however in some cases changes in the products or availability could occur which may not be reflected in this document. Christie reserves the right to make changes to specifications at any time without notice. Performance specifications are typical, but may vary depending on conditions beyond Christie's control such as maintenance of the product in proper working conditions. Performance specifications are based on information available at the time of printing. Christie makes no warranty of any kind with regard to this material, including, but not limited to, implied warranties of fitness for a particular purpose. Christie will not be liable for errors contained herein or for incidental or consequential damages in connection with the performance or use of this material.

The product is designed and manufactured with high-quality materials and components that can be recycled and reused. This symbol  means that electrical and electronic equipment, at their end-of-life, should be disposed of separately from regular waste. Please dispose of the product appropriately and according to local regulations. In the European Union, there are separate collection systems for used electrical and electronic products. Please help us to conserve the environment we live in!

Canadian manufacturing facility is ISO 9001 and 14001 certified.

GENERAL WARRANTY STATEMENTS

For complete information about Christie's limited warranty, please contact your Christie dealer. In addition to the other limitations that may be specified in Christie's limited warranty, the warranty does not cover:

- a. Damage occurring during shipment, in either direction.
- b. Problems caused by combination of the product with non-Christie equipment, such as distribution systems, cameras, video tape recorders, etc., or use of the product with any non-Christie interface device.
- c. Damage caused by misuse, improper power source, accident, fire, flood, lightning, earthquake or other natural disaster.
- d. Damage caused by improper installation/alignment, or by product modification, if by other than a Christie authorized repair service provider.
- e. For LCD projectors, the warranty period specified applies only where the LCD projector is in "normal use". "Normal use" means the LCD projector is not used more than 8 hours a day, 5 days a week. For any LCD projector where "normal use" is exceeded, warranty coverage under this warranty terminates after 6000 hours of operation.
- f. Failure due to normal wear and tear.

PREVENTATIVE MAINTENANCE

Preventative maintenance is an important part of the continued and proper operation of your product. Failure to perform maintenance as required, and in accordance with the maintenance schedule specified by Christie, will void the warranty.

Content

Safety	8
Laser safety warnings	9
Laser label	10
Light intensity hazard distance	11
Introduction	13
Projector components	13
Front view	13
Rear view	14
Left view	15
Right view	16
Built-in keypad	16
Input/Output (I/O) panel	17
IR remote keypad	18
LED status indicators	20
Status LED	20
Shutter LED	20
Installation	21
Connecting to a computer	22
Connecting to video equipment	23
Turning the projector on	24
Turning the projector off	25
Adjusting the projector position	26
Calculating the lens offset	27
WUXGA projectors	27
HD Projectors	29
Removing and installing the lens	30
Installing the fuse	31
Cleaning or replacing the filter	32
Installing the ceiling mount	33
Installing the projector in the rigging frame	33
Operation	34
Size and Position menu	35

- Geometry correction 37
- Image Settings menu 39
- Configuration Menu 42
 - Color matching 47
- Light Source menu 49
- Status menu 50
 - For DHD models 50
 - For DWU models 51
- Input Switching & PIP menu 52
 - PIP/PBP layout and size 53
- Language menu 54
- Test Pattern menu 54
- Web user interface 55
 - Logging on to the web user interface 55
 - Main tab–General 56
 - Main tab–Status 56
 - Main tab–Lens 57
 - Network 58
 - Tools 61
 - Administrator Page 61
 - About Page 61
- Christie Presenter 62
 - Connecting to the Projector 62
 - Installing the Christie Presenter software 63
 - Using the Christie Presenter 65
 - Connecting and searching the network display 66
 - Selecting the display region 67
 - Configuring Christie Presenter 68
 - Managing all connected network displays 69
 - Operating the card reader 70

Troubleshooting 73

- No image appears on screen 73
- Incorrectly displayed image 73
- Presentation is not displayed 74
- Unstable or flickering images 75
- Vertical flickering bar 75
- Image is out of focus 75
- Image is stretched 75

Image is not the correct size	76
Specifications	77
Inputs	78
PIP/PBP compatibility	82
Key features	82
List of components	83
Physical specifications	84
Physical operating environment	84
Power requirements	85
Warnings	85
Regulatory	86
Safety	86
Laser safety	86
Electro-Magnetic Compatibility	87
Environmental	87
Federal Communications Commission (FCC) warning	87
On-screen display tree	88

Safety

Read through this document in its entirety and understand all warnings and precautions before attempting to operate the projector.



Warning! Failure to comply with the following could result in death or serious injury.

- Please carefully review and follow the installation instruction included in this manual.
- Do not look into the projector lens when the laser is on. The bright light may result in permanent eye damage.
- To reduce the risk of fire or electric shock, do not expose this projector to rain or moisture.
- Do not open or disassemble the projector as this may cause electric shock.
- All installations must be performed by Christie qualified authorized trained installers.
- Keep all combustible material away from the concentrated light beam of the projector.
- Position all cables where they cannot contact hot surfaces or be pulled or tripped over.
- Always power down the projector and disconnect all power sources before servicing or cleaning.
- Use a soft cloth moistened with a mild detergent to clean the display housing.
- Disconnect the power plug from the AC outlet if the product is not being used for an extended period of time.
- Only use the AC power cord supplied. Do not attempt operation if the AC supply and cord are not within the specified voltage and power range for your region.
- Remove the lens plug from the lens opening in the projector before installing the lens. Retain the lens plug to protect the optical components from dust and debris during transport.
- Do not block the ventilation slots and openings on the projector.
- Do not use abrasive cleaners, waxes, or solvents to clean the projector.
- Do not allow anything to rest on the power cord.
- Not for household use.
- No direct exposure to beam shall be permitted.

Laser safety warnings

This product is classified as CLASS 1 LASER PRODUCT - RISK GROUP 3 according to IEC 60825-1:2014 and IEC 62471:2006.

IEC 60825-1:2014 CLASS 1 LASER PRODUCT RISK GROUP 3.
Warning
Possibly hazardous optical radiation emitted from this product.
Do not look at operating beam.
Permanent eye damage may result.
No direct exposure to beam shall be permitted.
Not for household use.

IEC 60825-1:2014 PRODUIT LASERDE CLASSE 1 GROUPE DE RISQUE 3.
AVERTISSEMENT
Le rayonnement optique dangereux potentiellement émis par ce produit.
Ne pas regarder directement sur le faisceau.
Ce peut provoquer des dommages permanents aux yeux.
Aucun faisceau direct d'exposition ne sera autorisé.
Ne pas pour l'usage domestique.

IEC 60825-1:2014 1类激光产品 RG3危险等级。
注意
此产品可能会产生危险光辐射。请勿直视操作光束，可能对眼睛造成永久性伤害。应避免直接暴露于激光下。
非家用。

IEC 60825-1:2014 1등급 레이저 제품 위험 그룹 3.
경고
이 제품으로부터 위험한 광선이 방출될 수 있음 작동 중 광선을 정면으로 바라보지 마시오 영구적인 안구 손상을 유발할 수 있음
광선에 직접적인 노출을 피하십시오
가정용으로 사용하지 마시오

IEC 60825-1:2014 クラス1レーザー製品リスクグループ3。
警告
本製品より危険となりうる 光放射あり。動作中のビームを見ないこと。
眼に永久に残る障害をもたらす恐れあり。
ビームに対する直接曝露のなきこと。
家庭用途の使用なきこと。

Christie Digital Systems Canada Inc.
809 Wellington Street North
Kitchener, ON N2G 4Y7
Canada

This product complies with performance standards for laser products under 21 CFR Part 1040 except with respect to those characteristics authorized by Variance Number 2016-V-1838 effective June 20, 2017.

U.S.A Only

Laser label

CLASS 1 LASER PRODUCT IEC 60825-1:2014



Warning! Failure to comply with the following could result in death or serious injury.

- Please carefully review and follow the installation instruction included in this manual.
- This product must be installed to prevent exposure to the RG3 hazard zone. If human access is possible, additional safety measures must be taken. See Installation section for additional details.
- PERMANENT/TEMPORARY BLINDNESS HAZARD! Operators must control access to the beam within the hazard distance or install the product preventing potential exposure of the spectators' eyes from being in the hazard distance. Hazard zone shall be no lower than 3.0 meters above the floor. In addition, horizontal clearance to the hazard zone shall be a minimum 2.5 meters.
- Possibly hazardous optical radiation emitted from this product. (Risk group 3).
- This projector has a built-in Class 4 laser module. Never attempt to disassemble or modify the projector.
- Any operation or adjustment not specifically instructed in the User manual creates the risk of hazardous laser radiation exposure.
- Do not open or disassemble the projector as this may cause damage from exposure of laser radiation.
- PERMANENT/TEMPORARY BLINDNESS HAZARD! No direct exposure to the beam must be permitted. RG3 IEC 62471:2006.
- Install the product so users and the audience cannot enter the restricted area at eye level.
- Follow the control, adjustment, or operation procedures to avoid damage or injury from exposure of laser radiation.
- The instructions for the assembly, operation, and maintenance include clear warnings concerning precautions to avoid possible exposure to hazardous laser radiation.
- Installing or replacing a lens must be done by a Christie qualified authorized service technicians or installers to avoid exposure to dangerous emission levels.
- Not for household use.

Light intensity hazard distance

This projector has been classified as Risk Group 3 per the IEC 62471:2006 standard due to possible hazardous optical and thermal radiation being emitted.



Warning! Failure to comply with the following could result in serious injury.

- PERMANENT/TEMPORARY BLINDNESS HAZARD! No direct exposure to the beam must be permitted. RG3 IEC 62471:2006.
- PERMANENT/TEMPORARY BLINDNESS HAZARD! Operators must control access to the beam within the hazard distance or install the product preventing potential exposure of the spectators' eyes from being in the hazard distance. Hazard zone shall be no lower than 3.0 meters above the floor. In addition, horizontal clearance to the hazard zone shall be a minimum 2.5 meters.
- EXTREME BRIGHTNESS! Do not place reflective objects in the product light path.
- The bright light may result in permanent eye damage.
- The use of the projector with lenses PN: 140-109101-XX, 140-110103-XX, 140-114107-XX, and 140-115108-XX, where the throw ratio is less than or equal to 2.0:1 result in risk group 2 emissions from the projector. No hazard distance has been identified for use of the projector with these lenses. Precautions must be taken to follow the warnings listed above to avoid serious injury.

The following diagram and table shows the zones for optical and thermal radiation hazard distances:

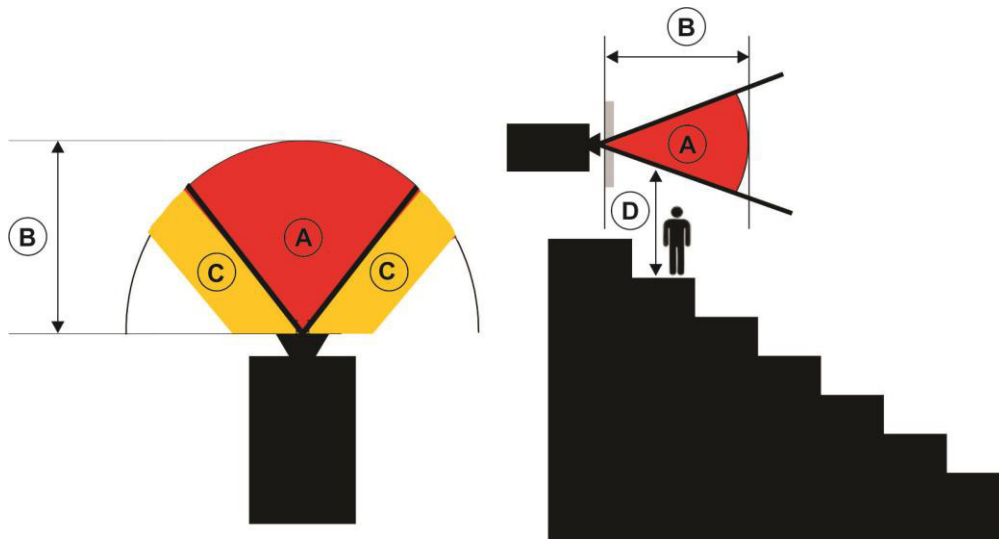

- A — Hazard zone. The region of space where the projection light from the laser illuminated projector is above emission limits for Risk Group 2. The light intensity may cause eye damage after a momentary or brief exposure (before a person can avert his or her eyes away from the light source). The light may cause skin burns to occur.
- B — Hazard distance. Operators must control access to the beam within the hazard distance or install the product preventing potential exposure of the spectators' eyes from being in the hazard distance.
- C — No access zone. Horizontal clearance of the no access zone shall be a minimum of 2.5 meters.
- D — Vertical distance to hazard zone. The hazard zone shall be no lower than 3.0 meters above the floor.

For US market only, hazard distances based upon FDA guidance document 1400056, Classification and Requirements for Laser Illuminated Projectors (LIPs), dated February 18, 2015:

Projection lens	Part number	Hazard distance (m)	Category
0.84:1 - 1.02:1	140-114107-XX	-	RG2
1.02:1 - 1.36:1	140-115108-XX	-	RG2
1.2:1 - 1.5:1	140-109101-XX	-	RG2
1.5:1 - 2.0:1	140-110103-XX	-	RG2
2.0:1 - 4.0:1	140-111104-XX	2.1	RG3
4.0:1 - 7.2:1	140-116109-XX	4.1	RG3

For all other markets, hazard distances based upon IEC 62471-5:2015, Photobiological safety of lamps and lamp systems - Part 5: Image projectors:

Projection lens	Part number	Hazard distance (m)	Category
0.84:1 - 1.02:1	140-114107-XX	-	RG2
1.02:1 - 1.36:1	140-115108-XX	-	RG2
1.2:1 - 1.5:1	140-109101-XX	-	RG2
1.5:1 - 2.0:1	140-110103-XX	-	RG2
2.0:1 - 4.0:1	140-111104-XX	1.9	RG3
4.0:1 - 7.2:1	140-116109-XX	3.3	RG3

Introduction

The HS Series is a high brightness, high-resolution video graphics one-chip laser-based projector. The projector is available in HD and WUXGA resolutions and uses Digital Light Processing (DLP®) technology from Texas Instruments. It is primarily designed for fixed installation and secondary applications including rental-staging and LBE (Location Based Entertainment). This product is used for professional applications and is not for domestic use.

Projector components

Identify the main components of the projector.

Front view

Identify the main components on the front of the projector.

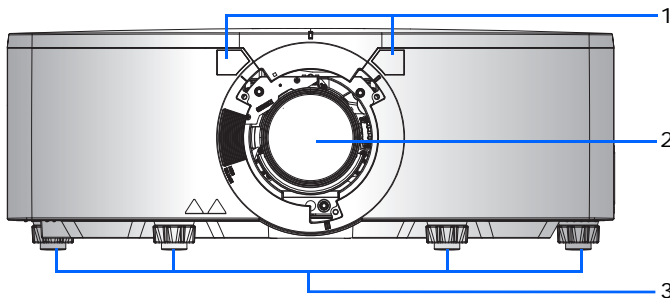

ID	Part name	Description
1	Front IR sensors	Receives signals from the IR remote keypad. Keep the signal path to the sensor unobstructed for uninterrupted communication with the projector.
2	Projection lens	Allows automated lens control and adjustment: vertical and horizontal offsets, zoom, and focus.
3	Adjustable feet	Raises or lowers the feet to level the projector.

Rear view

Identify the main components on the rear of the projector.

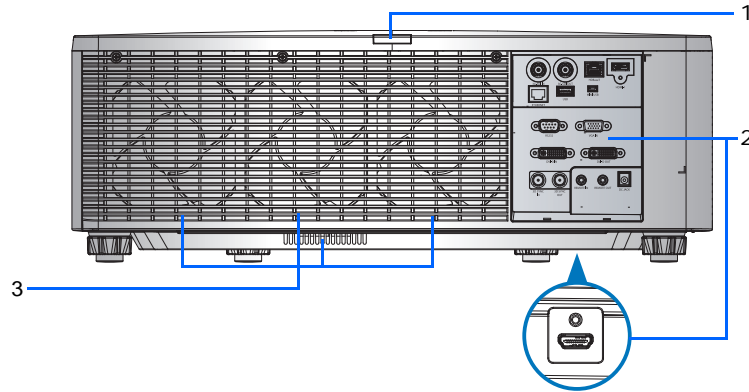

ID	Part name	Description
1	Rear IR sensor	Receives signals from the IR remote keypad. Keep the signal path unobstructed for uninterrupted communication with the projector.
2	Input/Output (I/O) panel	Connects the projector to external devices.
3	Cooling air vents (exhaust)	Provides cooling to the projector. Keep these vents unobstructed to prevent the projector from overheating.

Left view

Identify the main components on the left side of the projector.

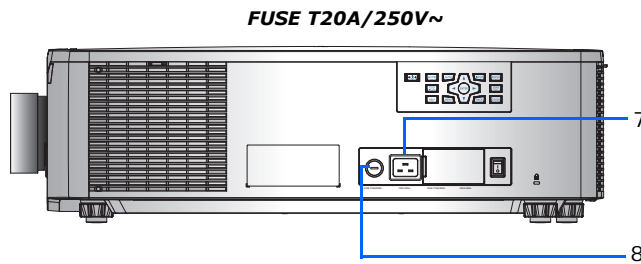
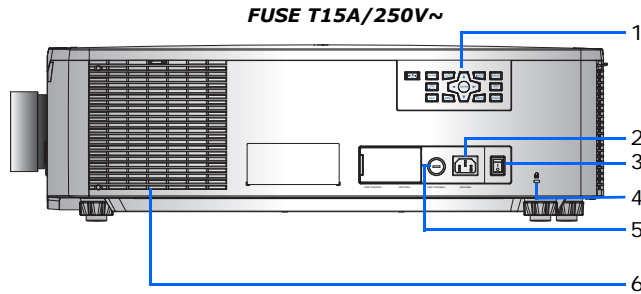

ID	Part Name	Description
1	Built-in keypad	Controls the projector.
2	AC input	Connects to the supplied power adapter (200 to 240V~).
3	Power button	Powers the projector on or off.
4	Kensington lock	Secures the projector to counter tops, tables, and so on.
5	Fuse	FUSE T15A/250V~.
6	Cooling air vents (intake)	Provides cooling to the projector. Keep these vents unobstructed to prevent the projector from overheating.
7	AC input	Connects to the supplied power adapter (100V to 120V~).
8	Fuse	FUSE T20A/250V~.

Right view

Identify the main component on the right side of the projector.

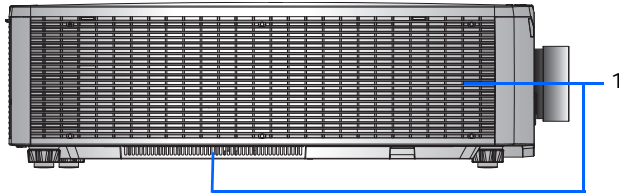

ID	Part Name	Description
1	Cooling air vents (intake)	Provides cooling to the projector. Keep these vents unobstructed to prevent the projector from overheating.

Built-in keypad

The built-in keypad controls the projector.

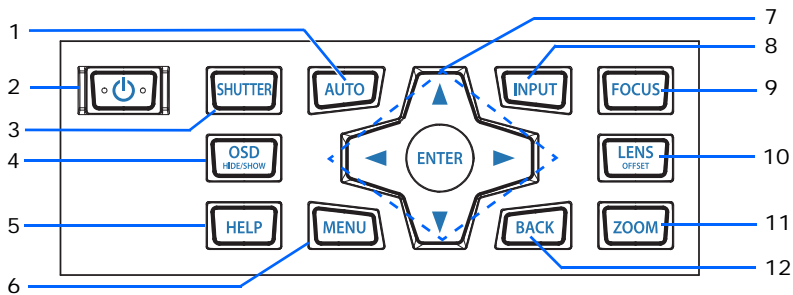

ID	Part Name	Description
1	Auto	Automatically optimizes an image.
2	Power	Turns the projector on or off.
3	Shutter	Displays or blanks the video image.
4	OSD	Hides or shows the on-screen display (OSD) menus.
5	Help	Displays the instructions for source connection.
6	Menu	Displays the menus.
7	Arrow keys	Adjusts a setting up or down, or navigate within a menu.
8	Input	Selects an input for the main or PIP/PBP image.
9	Focus	Adjusts the focus.
10	Lens	Adjusts the lens vertical or horizontal offset setting.

ID	Part Name	Description
11	Zoom	Adjusts the zoom.
12	Back	Returns to the previous level or exits the menus if at top level.

Input/Output (I/O) panel

Identify the components of the Input/Output (I/O) panel.

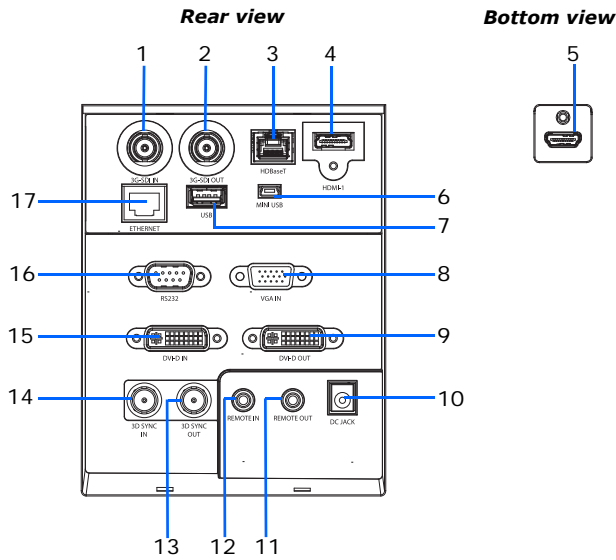

ID	Connector name	ID	Connector name
1	3G-SDI IN	10	DC JACK
2	3G-SDI OUT	11	REMOTE OUT
3	HDBaseT	12	REMOTE IN
4	HDMI-1	13	3D SYNC OUT
5	HDMI-2	14	3D SYNC IN
6	MINI USB	15	DVI-D IN
7	USB	16	RS232
8	VGA IN	17	ETHERNET
9	DVI-D OUT		

IR remote keypad

The IR remote keypad communicates with the projector by way of wireless communications. Use a cable length of 20 m or less. If the length of cable exceeds 20 m, the IR remote keypad may not work correctly.

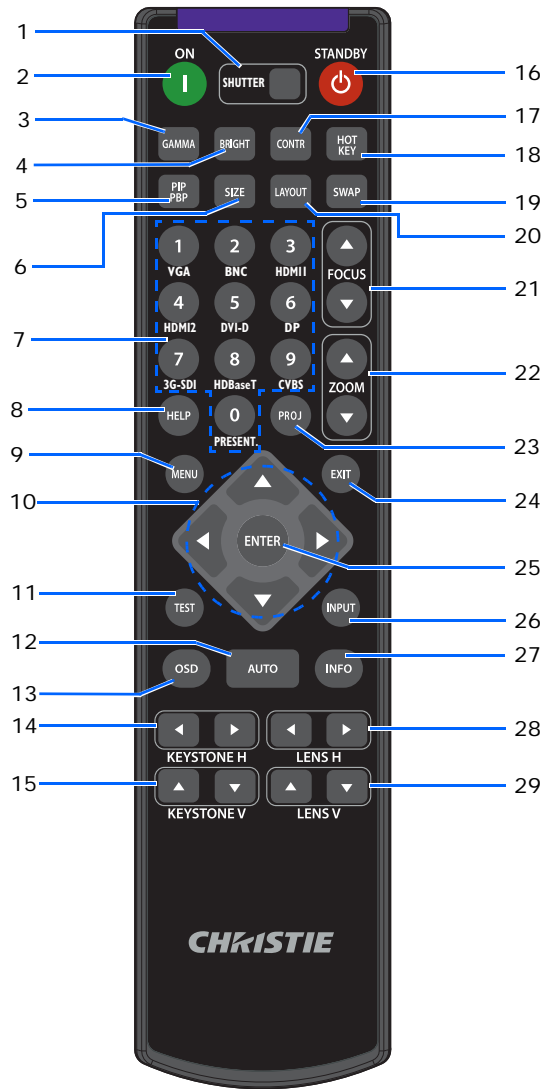

ID	Part Name	Description
1	SHUTTER	Displays or blanks the video image.
2	Power on	Turns the projector on.
3	Gamma	Adjusts the mid-range levels.
4	Bright	Adjusts the amount of light in the image.
5	PIP/PBP	Turns PIP/PBP on or off.

ID	Part Name	Description
6	Size	Adjusts the PIP/PBP size.
7	Number Keys	Enter a number, such as a channel, value, and so on. The on-screen display indicates if a function is not supported.
8	Help	Displays the instructions for source connection.
9	Menu	Displays the menus.
10	Arrow Keys	Adjusts a setting up or down to navigate within a menu.
11	Test	Displays a test pattern.
12	Auto	Automatically optimizes an image.
13	OSD	Use to hide or show on-screen display (OSD) menus.
14	Keystone H	Adjusts the horizontal keystone.
15	Keystone V	Adjusts the vertical keystone.
16	Standby	Turns the projector off.
17	Contrast	Adjusts the difference between dark and light.
18	Hot key	Selects your preset key quickly.
19	Swap	Swaps the main and PIP/PBP images.
20	Layout	Adjusts the PIP/PBP layout.
21	Focus	Adjusts the focus to improve image clarity as required.
22	Zoom	Adjusts the zoom to achieve a required image size.
23	Proj	Changes the IR remote keypad ID. <ul style="list-style-type: none"> • To assign an ID, press Proj + <1 to 9>. • To return to the universal IR remote ID, press Proj + 0.
24	Exit	Returns to previous level or exit menus if at top level.
25	Enter	Selects a highlighted menu item, or changes or accepts a value.
26	Input	Selects an input for the main or PIP/PBP image.
27	Info	Displays the source image information.
28	Lens H	Adjusts the position of the image horizontally.
29	Lens V	Adjusts the position of the image vertically.

LED status indicators

LEDs are defined below.

Status LED

Identify the LED state colors and meaning.

LED Status	Projector State
Off	AC power is off (without AC plugged in).
Green (flashing)	Projector is in startup or cool down mode.
Green (solid)	System is operating normally.
Blue (flashing)	Projector is cooling down.
Blue (solid)	AC has been applied, projector is in standby mode.
Yellow (flashing)	A problem exists with the projector that does not cause it to shut down. Examples of warnings include: filter needs changing, one of the pumps is damaged, or a fan is operating at full speed due to over temperature of LD driver.
Yellow (solid)	The end user is turning off the projector while it is in a warning state.
Red (flashing)	An error with the projector exists that has caused or may inevitably cause it to shut down. Examples of errors include: fan failure, over temperature, wrongly installed filter, color wheel (CW) failure.
Red (solid)	The end user is turning off the projector while it is in an error state.
White (flashing)	Projector is in a flash (LAN) update state.

Shutter LED

Identify the shutter LED state colors and meaning.

LED Status	Projector State
Off	Projector is on and an image is displayed. Shutter is open.
Magenta (solid)	Projector is on and the image is blank. Shutter is closed.

Installation



- A Hazard Zone is the region of space where the projection light from the LIP is above Emission Limits for RG2. RG3 LIPs for installations other than in cinema theaters shall be installed at a height vertically above the floor such that the bottom plane of the Hazard Zone shall be no lower than 3.0 meters above the floor. Horizontal clearance to the hazard zone shall be 2.5 meters. If human access is possible in an unsupervised environment, the horizontal or vertical clearances shall be increased to prevent exposure to the RG3 hazard zone.

For Installations in the United States

- Any human access horizontally to the Hazard Zone, if applicable, shall be restricted by barriers.
- Permanent show installations containing RG3 LIPs shall be installed by Christie or by Christie-authorized and trained installers. Show installations must be performed in accordance with Christie's instructions. The projection system shall be securely mounted or immobilized to prevent unintended movement or misalignment of the projections.
- Temporary show installations containing RG3 LIPs may be installed by Christie or sold or leased only to valid laser light show variance holders (laser light show manufacturers) for image projection applications. Such manufacturers may currently hold a valid variance for production of Class IIIb and IV laser light shows and/or for incorporation of the RG3 LIPs into their shows. This requirement applies also to dealers and distributors of these LIPs.
- Christie Laser Projection System (Enterprise) Installation Checklist needs to be filled out completely after the installation and sent to [.lasercompliance@christiedigital.com](mailto:lasercompliance@christiedigital.com). A copy can remain onsite. This checklist can be found as a separate document in the accessory box with the manual.
- If you are installing in the following US states: Arizona, Florida, Georgia, Illinois and Massachusetts, please see www.christiedigital.com for additional regulatory requirements.

Learn how to install, connect, and optimize the projector display.

Connecting to a computer

Learn what cables/connectors that may be used to connect to various devices.

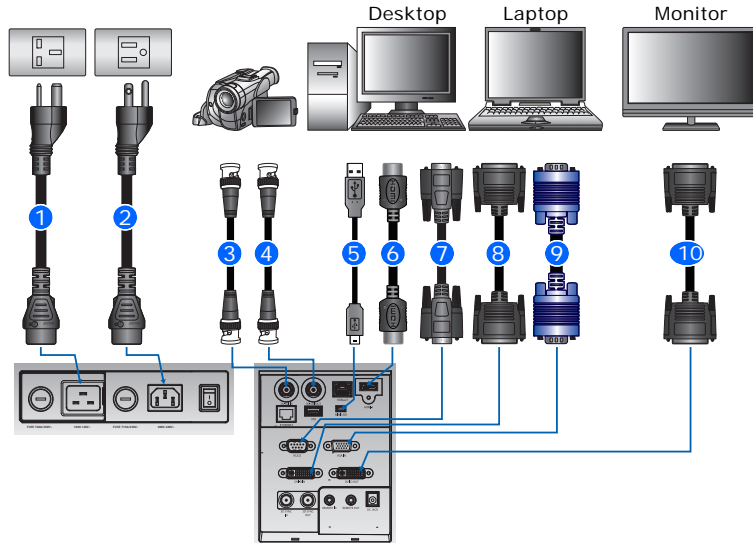

ID	Connector name	ID	Connector name	ID	Connector name
1	Power Cord (100-120V). Power cord (100-120V) rated for North America and Japan.	5	USB type B Mini cable	9	VGA in cable
2	Power Cord (200 to 240V). Power cord (200 to 240V) rated for North America, UK, EU, Russia, Korea, India, Australia/Nz, South Africa, and Argentina.	6	HDMI cable	10	DVI-D out cable
3	3G-SDI In with BNC cable + Camcorder	7	RS232 cable		
4	3G-SDI Out with BNC cable	8	DVI-D in cable		



- Due to the difference in applications for each country, the accessories required in some regions may differ from those shown.
- This diagram is for illustrative purposes only and does not indicate that these accessories are supplied with the projector.

Connecting to video equipment

Learn what cable/connectors may be used to connect to various devices.

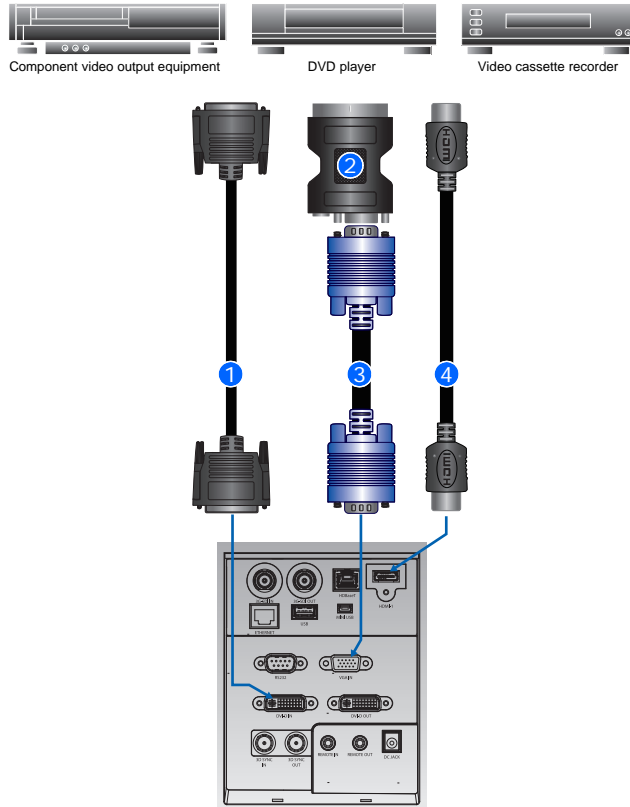

Ind.	Connector name	Ind.	Connector name
1	DVI-D IN Cable	3	VGA IN Cable
2	VGA to Component	4	HDMI Cable



- Due to the difference in applications for each country, the accessories required in some regions may differ from those shown.
- This diagram is for illustrative purposes only, and does not indicate that these accessories are supplied with the projector.

Turning the projector on

The projector cables must be securely connected before turning the power on.



Warning! Failure to comply with the following could result in death or serious injury.

- Do not look into the projector lens when the laser is on. The bright light may result in permanent eye damage

1. Ensure the correct power input has been selected.

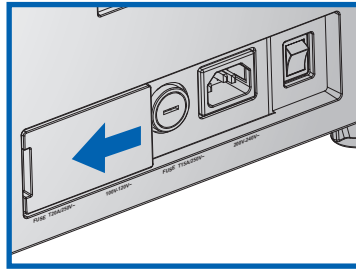

Condition	Power Input	AC Inlet selected	Projector Behavior	Applicable Regions
1	100-120V	100-120V	Full power (100%)	<ul style="list-style-type: none"> • North America • Japan
2	100-120V	200-240V	<ul style="list-style-type: none"> • Warning message appears on screen • ECO 2 mode (50% power) 	
3	200-240V	100-120V	<ul style="list-style-type: none"> • Warning message appears on screen • ECO 2 mode (50% power) 	
4	200-240V	200-240V	Full power (100%)	<ul style="list-style-type: none"> • North America • UK • EU • Russia • Korea • India • Australia/Nz • South Africa • Argentina



The Power button on the built-in keypad is illuminated when the power cables are connected.

2. Ensure the lens has been installed in the projector by a Christie qualified service technician.



Warning! Failure to comply with the following could result in death or serious injury.

- Installing or replacing a lens must be done by a Christie qualified service technician to avoid exposure to dangerous emission levels.

3. Ensure that no one or no objects are in the beam path before turning on the projector.
4. To turn on the projector, on the IR remote keypad press  or on the built-in keypad press .

The status LED is green with a long blink. ❷

5. To select an input source and turn it on, on the IR remote keypad select **Input Key**. ❸

Available input sources are VGA, HDMI1, HDMI2, DVI, 3G-SDI, and HD-BaseT.

The projector detects the source you selected and displays the image.

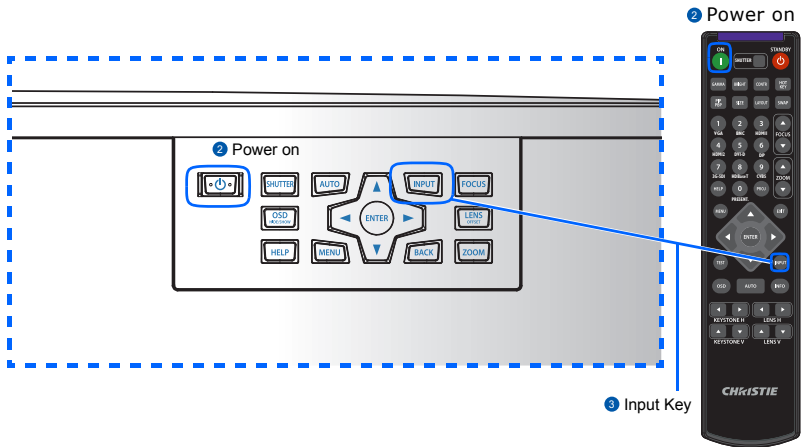

The first time the projector is used, select the preferred language from the Main Menu after the startup screen is displayed.

Turning the projector off

Power off the projector in preparation for inspection or maintenance.

1. To turn the projector off, on the IR remote keypad or built-in keypad press **Power off**.
A warning message appears on the displayed image.
2. To confirm your selection, press **Power off** again.

If you do not press **Power off** again, the warning message disappears after three seconds and the projector remains on.

Adjusting the projector position

When you select a position for the projector, consider the size and shape of your screen, the location of your power outlets, and the distance between the projector and the rest of your equipment. Follow these general guidelines:

- Position the projector on a flat surface at a right angle to the screen. The projector (with the standard lens) must be at least 3 feet (0.9 m) from the projection screen.
- Position the projector to the required distance from the screen. The distance from the lens of the projector to the screen, the zoom setting, and the video format determine the size of the projected image.
- Determine the lens throw ratio:
 - Lens 0.84~1.02 (WU/HD)
 - Lens 1.02~1.36 (WU/HD)
 - Lens 1.2~1.5 (WU/HD)
 - Lens 1.5~2.0 (WU/HD)
- 360 degree free orientation operation

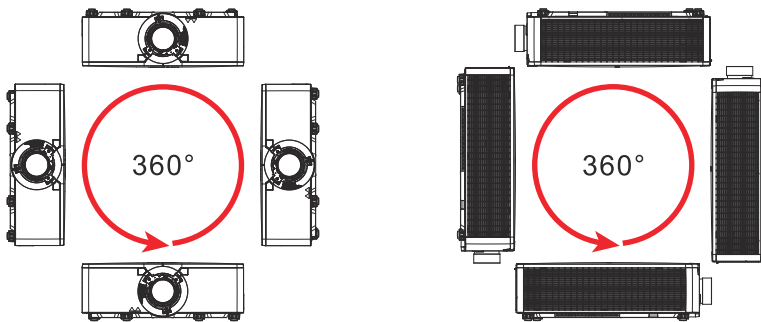

When installing the projector in portrait orientation, it is recommended that the built-in keypad and power inputs face upwards. This allows access to the built-in keypad and power connections during operation.

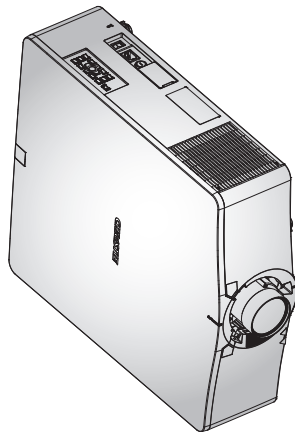

Calculating the lens offset

Adjust the offset to align the image on the screen with full image size.

- The vertical image offset (shift) ranges for the projector are +/-60% (WUXGA) and +/-70% (HD).
- The horizontal image offset (shift) range for the projector is +/-25% (HD/WUXGA).
- The method for calculating lens offset complies with industry standards. For example for Vertical lens offset:
 - At 0% offset (or on axis), the center of the image is on the lens center, so half of the image appears above and half appears below the lens center.
 - At +50% offset, all of the image appears above the lens center.
 - The percentage (%) offset is calculated as the ratio of the number of pixels shifted up or down to full image size. For example for WUXGA:
 - Shifting up 600 pixels gives an offset of $600/1200 * 100\% = 50\%$
 - Shifting down 600 pixels gives an offset of $-600/1200 * 100\% = -50\%$
 - Shifting up 720 pixels gives an offset of $720/1200 * 100\% = 60\%$
 - Shifting up 240 pixels gives an offset of $240/1200 * 100\% = 20\%$

WUXGA projectors

The following show vertical image offsets for the WUXGA projectors:

- Vertical image offset: 0%

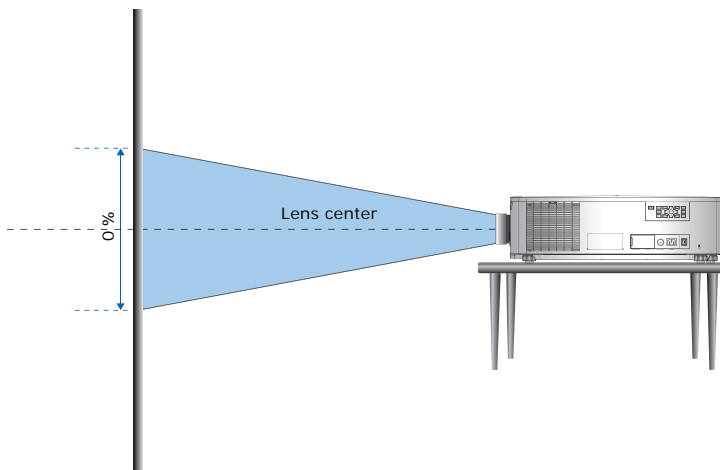

- Vertical image offset: +60%

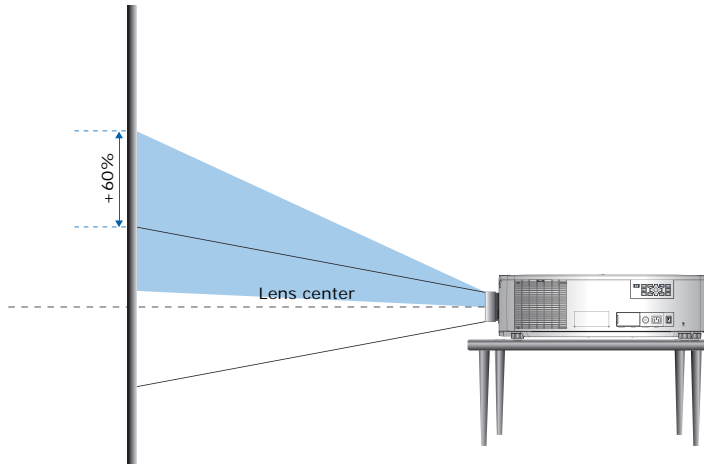

- Vertical image offset: -60%

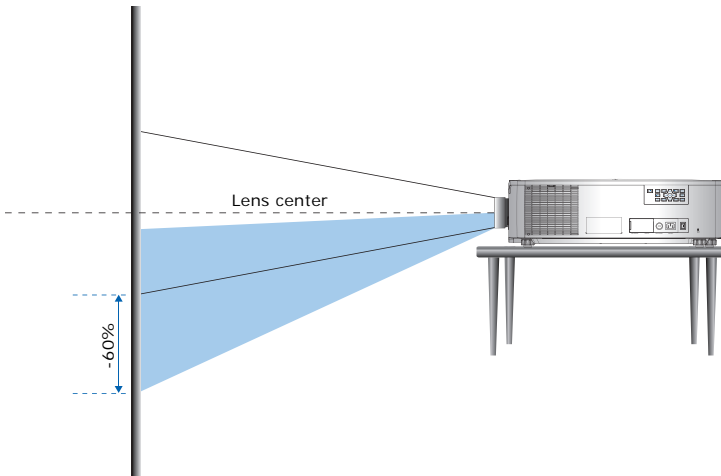

HD Projectors

The following show vertical and horizontal image offset for HD projectors:

- Vertical image offset: +70%

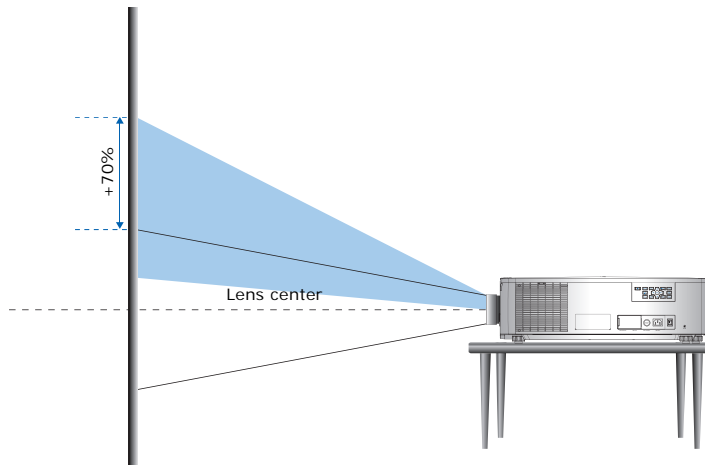

- Vertical image offset: -70%

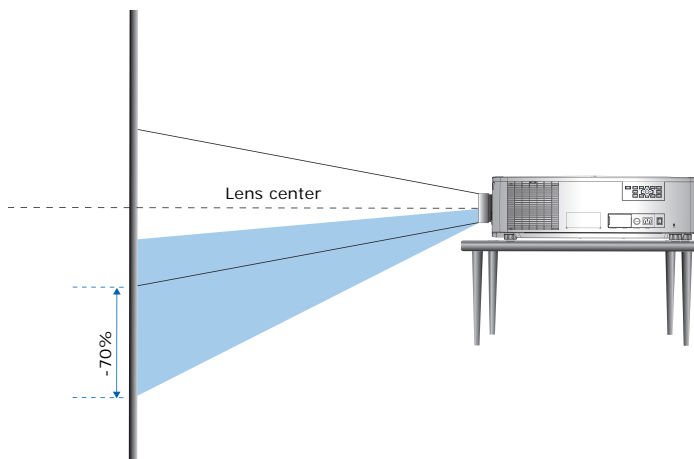

- Horizontal image offset: +/-25%

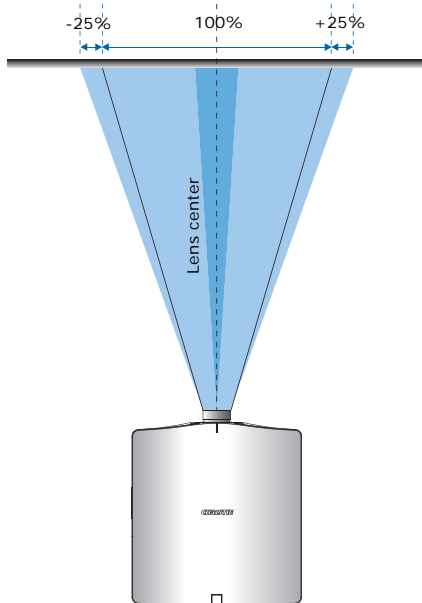

Removing and installing the lens



Warning! Failure to comply with the following could result in death or serious injury.

- Installing or replacing a lens must be done by a Christie qualified authorized service technicians or installers to avoid exposure to dangerous emission levels.
- Turn off the projector and remove the power cord, before installing or replacing a lens.

Installing the fuse

A fuse must be installed in the projector for it to power on.

1. Turn the projector off.
2. Choose the 20A or 15A fuse by sliding the AC cover to the right or to the left.
3. Remove the screw on the fuse with a flat-head screwdriver.
4. Remove the fuse and replace it with the new one.

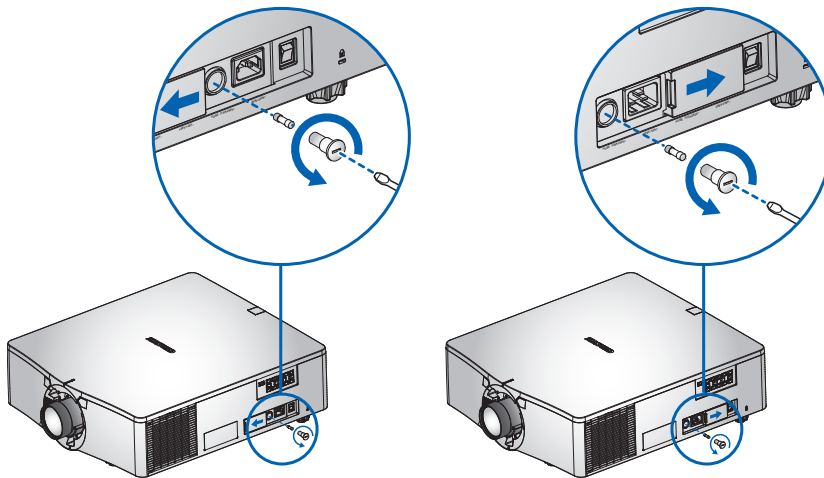

- For regions using 200 to 240V-15A fuse.
- For regions using 100 to 120V-20A fuse.
- To order a fuse, see [page 83](#).

Cleaning or replacing the filter

Regularly clean or replace the filters in the projector to ensure dust and other foreign materials are kept out of the projector.

1. Turn off the projector.
2. Remove the screws on the filter cover using a 3 mm hex key.

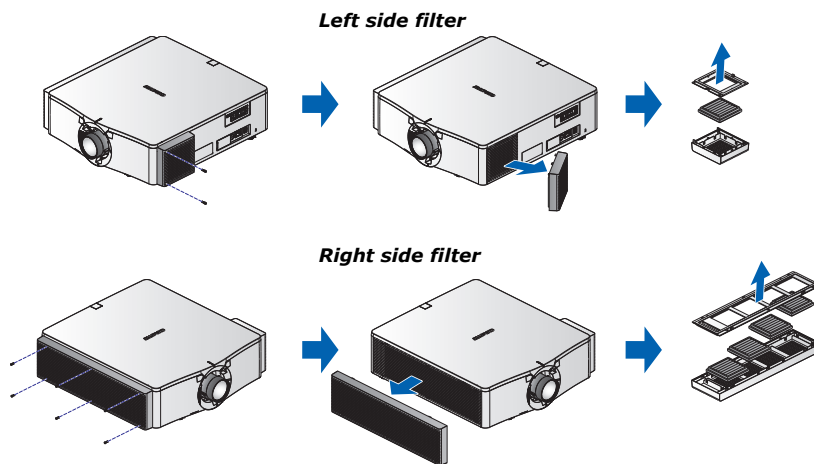

3. Remove the filter cover.
4. Remove the filter from its compartment.
5. Clean or replace the filter.

Fog filters should be replaced after each use of the projector to a maximum of 20 hours. The life of the filter is approximately 20 hours based on environmental conditions. Leave the filters in their sealed packaging until ready for use.



Do not re-use the fog filters as they clog up with oil and the projector overheats and shuts down.
For more details, see [page 83](#).

Installing the ceiling mount

Mount the projector with a Christie-approved mount (such as the Christie One Mount Plus, P/N: 140-117100-XX), using the four mounting points on the underside of the projector.



Warning! Failure to comply with the following could result in death or serious injury.

- When not mounted properly, the projector may fall.
- The warranty on this projector does not cover damage caused by the use of a non-recommended ceiling mount kit or installation of the ceiling mount kit in an improper location.

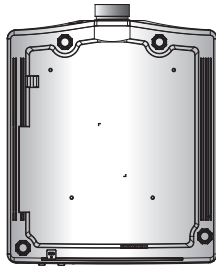

1. Refer to the installation instructions and safety guidelines provided in the kit (such as the Christie One Mount Plus, P/N: 140-117100-XX).

Installing the projector in the rigging frame

Install the projector in a Christie-approved rigging frame (such as the Christie One Rigging Frame, P/N: 140-113106-XX), using the four mounting points on the underside of the projector.



Warning! Failure to comply with the following could result in death or serious injury.

- When not mounted properly, the projector may fall.
- The warranty on this projector does not cover damage caused by the use of a non-recommended ceiling mount kit or installation of the ceiling mount kit in an improper location.

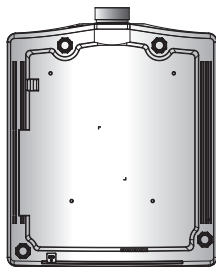

1. Refer to the installation instructions and safety guidelines provided in the kit (such as the Christie One Rigging Frame, P/N: 140-113106-XX).

Operation

The projector has multilingual on-screen display (OSD) menus so you can make image adjustments and change a variety of settings.

Most of the projector controls are accessed from within the projector menu system. Several groups of related functions are selectable from the Main Menu as shown below.

- To display the Main Menu, on the IR remote keypad or on the built-in keypad on the rear of the projector, press **MENU**.
- To navigate within the menu and adjust a setting up or down, use the arrow keys.
- To select a highlighted menu item or use it to change or accept a value, press **ENTER**.
You can then select the next item that you want to adjust in the menu and adjust it.
- To return to the previous menu or exit menus if at top level, press **EXIT**.

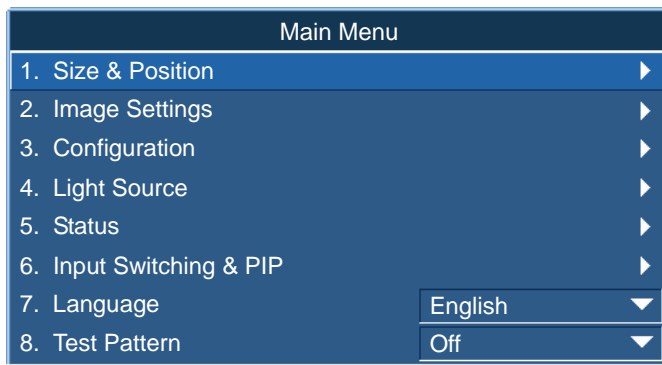

Size and Position menu

The Size and Position menu determines the size and position of the image on the screen.

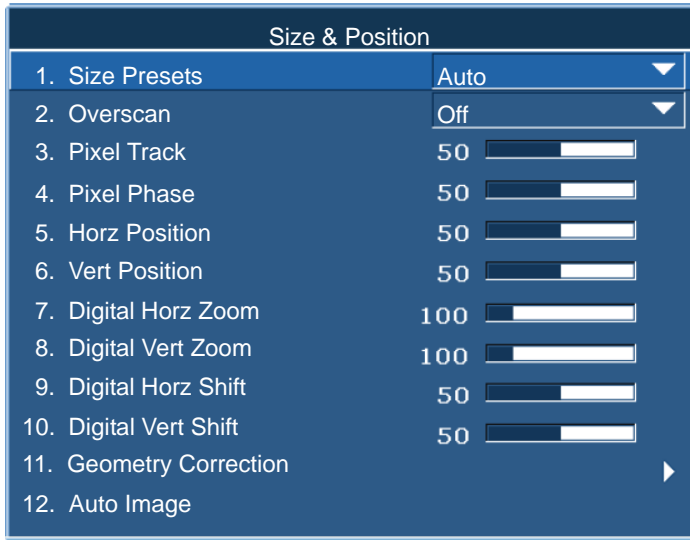

Menu item	Description	Options
Size Presets	Displays an image with the detected size, or resizes the image by maximizing either the height, width, both, or resizes to the maximum size possible while keeping the original aspect ratio.	<ul style="list-style-type: none"> • Auto—Displays with the detected size. • Native—Displays in its native resolution. • 4:3—Retains 4:3 aspect ratio. • Letterbox—Make the active content enlarge to the full screen. • Full Size—Fills the screen (regardless of the source). • Full Width—Fills display width and keep aspect ratio. • Full Height—Fills display height and keep aspect ratio. • Custom—Stretches the display horizontally or vertically without cutting the image display. • 3D Mode—Displays 3D content. If 3D Mode is selected, all other Size Presets items are grayed out.
Overscan	Removes noise around the image.	<ul style="list-style-type: none"> • Overscan Zoom enlarges image 6% from the original size. • Overscan Crop cuts 6% of the active pixels in four edges of original image.

Menu item	Description	Options
Pixel Track	Steady flickering or several soft vertical stripes or bands across the entire image indicates poor pixel tracking. Proper pixel tracking ensures that the image quality is consistent across the screen, the aspect ratio is maintained, and that the pixel phase can be optimized. (Analog RGB signals only.)	
Pixel Phase	Adjust the pixel phase when the image shows shimmer or noise after pixel tracking is optimized. Pixel phase can adjust the phase of the pixel-sampling clock relative to the incoming signal. (Analog RGB signals only.)	
Horz Position	Moves the image right or left within the area of available pixels.	
Vert Position	Moves the image up or down within the area of available pixels.	
Digital Horz Zoom	Changes the size of projector's display area horizontally. If the display area has been resized by this setting, it can be moved by changing the Digital Horz Shift and Digital Vert Shift settings.	
Digital Vert Zoom	Changes the size of projector's display area vertically. If the display area has been resized by this setting, it can be moved by changing the Digital Horz Shift and Digital Vert Shift settings.	
Digital Horz Shift	Moves the display area horizontally if its size has been changed by the Digital Zoom setting.	
Digital Vert Shift	Moves the display area vertically if its size has been changed by the Digital Zoom setting.	
Geometry Correction	Provides two ways for warping control.	<ul style="list-style-type: none"> • PC Mode off—User can do simple horizontal and vertical keystone, pincushion, and 4-corner control by using the on-screen display. • PC Mode on—User can do arbitrary warping or blending control by using PC APP provided separately.
Auto Image	Forces the projector to reacquire and lock to the input signal. This is useful when signal quality is marginal.	<ul style="list-style-type: none"> • Normal mode—Supports all of the 4:3 input sources. • Wide mode—Supports all of the 16:9 input source and most of the 4:3 input source. For the 4:3 input sources not recognized by Wide mode (for example, 1400 x 1050), perform Auto Image using Normal mode.

Geometry correction

Geometry correction provides two ways for warping control:

- PC Mode off—User can do simple horizontal and vertical keystone, pincushion, and 4-corner control by using the on-screen display.
- PC Mode on—User can do arbitrary warping or blending control by using the PC APP provided separately.

The following table provides information about the geometry correction feature compatibility:

Warp Function	4-Corner	Keystone	Pincushion
4-Corner	--	✓	✓
Keystone	✓	--	✓
Pincushion	✓	✓	--

Horz Keystone

Adjust the keystone horizontally to make the image more square. Horz Keystone corrects a keystoneed image shape in which the left and right borders of the image are unequal in length, and the top and bottom are slanted to one of the sides. Use Horz Keystone with horizontally on-axis applications. For horizontally offset applications, use 4-Corner correction using the OSD control or the PC APP provided separately.

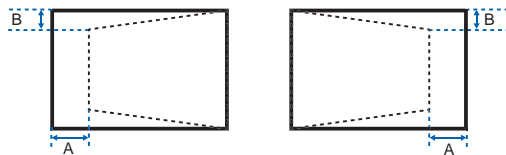

Ind.	1080P	WUXGA
A	30.60%	30.34%
B	14.20%	12.86%

Vert Keystone

Adjust the keystone vertically to make the image more square. Vert Keystone corrects a keystoneed image shape in which the left and right borders of the image are unequal in length, and the top and bottom are slanted to one of the sides. Use with vertically on-axis applications. For vertically offset images, use 4-Corner correction using the OSD control or the PC APP provided separately.

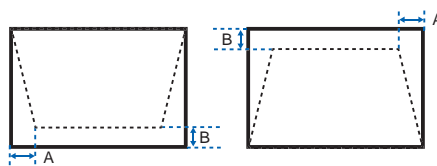

Ind.	1080P	WUXGA
A	5.12%	5.04%
B	11.00%	10.52%

Horz Pincushion

Adjust the pincushion horizontally and make the image more square.

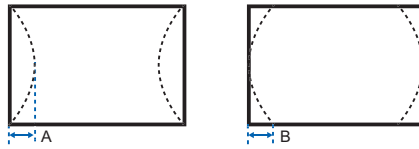

Ind.	1080P	WUXGA
A	5.17%	5.39%
B	5.17%	4.24%

Vert Pincushion

Adjust the pincushion vertically and make the image more square.

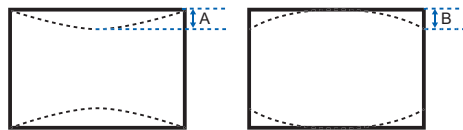

Ind.	1080P	WUXGA
A	9.67%	7.44%
B	9.83%	7.58%

4-Corner

Allow the image to be squeezed to fit an area defined by moving each of the four corners' x and y position.

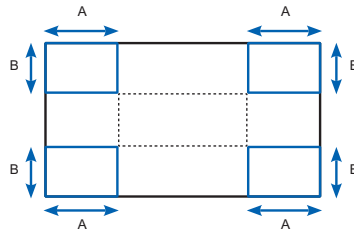

Ind.	1080P	WUXGA
A	6.25%	6.25%
B	6.67%	6.67%

Wrap Filter

Wrap filter corrects the distorted image, which is caused by projection to a curved surface or by lens distortion.

Auto Warp Filter

- Auto warp filter on—Apply preset warp filter values for distortion correction.
- Auto warp filter off—Disable the warp filter functions.

Manual Warp Filter

- Horz Filter—Adjust horizontal filter for distortion correction.
- Vert Filter—Adjust vertical filter for distortion correction.

Reset

Reset all Geometry Correction parameters.

Image Settings menu

The Image Settings menu sets the brightness, contrast, and other settings for images.

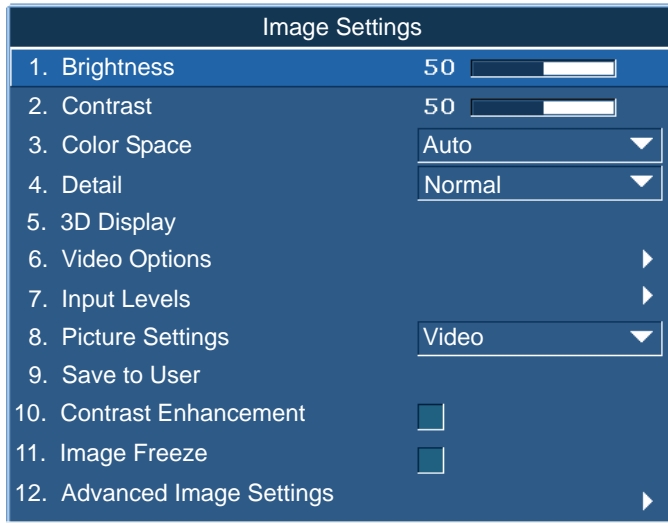

Menu item	Description	Options
Brightness	Adjusts the intensity of the image.	—
Contrast	Adjusts the degree of difference between the lightest and darkest parts of the image and changes the amount of black and white in the image.	—
Color Space	Selects a color space specifically tuned for the input signal. Only useful for analog signals and certain digital sources.	—
Detail	Selects the edge clarity of the image.	—
3D Display	Selects the 3D relating settings.	<ul style="list-style-type: none"> • 3D Enable—Sets the 3D format. Supports mandatory 3D formats and frame sequential 3D@60/120Hz. • 3D Invert—Inverts the 3D sync signal when using a single projector. • Toggle 3D Blending—Inverts 3D sync signal when using multiple projectors for 3D blending. • 3D Sync Out—Transmit 3D sync signal by 3D sync out corrector to emitter or to next projector for 3D blending purpose. • Frame Delay—Correct asynchronous displaying image under 3D blending.

Menu item	Description	Options
Video Options	Applies only to video sources.	<ul style="list-style-type: none"> • Color—Adjusts a video image from black and white to fully saturated color. (Video sources only.) • Tint—Adjusts the red-green color balance in the image of NTSC video images. (NTSC video sources only.) • Detect Film—Controls film mode detection and determine whether the original source of the input video was film or video.
Input Levels	Applies to VGA or component signals only.	<ul style="list-style-type: none"> • Gain—Adjusts the gain of the red, green, or blue channel of the image. It affects the black and white. • Offset—Adjusts the offset of the red, green, or blue channel of the image. It affects the black and white. • Sync Threshold—Helps to sync when connecting to the projector, if a hardware device, such as a DVD player, is not syncing properly with the projector. (Progressive signals only.)
Picture Settings	<p>Optimizes the projector for displaying images under certain conditions, such as:</p> <ul style="list-style-type: none"> • Presentation • Video • Bright • Enhanced • REC709 • Real • DICOM SIM • 2D High Speed • 3D • Blending • User-definable preset. <p>It affects the following:</p> <ul style="list-style-type: none"> • Gamma • Sharpness • White Peaking • Overscan • Brightness • Contrast • Color • Tint • Red Gain • Green Gain • Blue Gain • Red Offset • Green Offset • Blue Offset 	—

Menu item	Description	Options
Save to User	<p>Saves the user settings.</p> <p>Adjust the image settings and Select Save to User as a picture setting. To recall these settings in the future, select the User in the Picture Settings menu.</p> <p>You can save the following settings:</p> <ul style="list-style-type: none"> • Brightness • Contrast • Color • Tint • Red Gain • Green Gain • Blue Gain • Red Offset • Green Offset • Blue Offset • Color Temperature • Gamma • Detail • White Peaking • Overscan 	—
Contrast Enhancement	<p>Enables or disables the contrast enhancement function. Enable this function to raise the contrast ratio.</p>	<ul style="list-style-type: none"> • DynamicBlack™— Auto adjust the contrast ratio for video contents. • RealBlack— Lower down the black level for dark images to raise the contrast ratio.
Image Freeze	<p>Pauses the screen image.</p>	—
Advanced Image Settings	<p>Provides access to advanced image settings such as gamma, white peaking, and so on.</p>	<ul style="list-style-type: none"> • Gamma—Selects the appropriate gamma from Video, Film, Bright, CRT, and DICOM. • White Peaking—Increases the brightness of whites near 100%. (Video source only.) • Color Temperature—Changes the intensity of the colors. Select a listed relative warmth value. • Edge Enhancement—Applies the edge enhancement process. • Color Wheel Speed—Selects the color wheel speed from 2x or 3x. The color wheel speed defines the delay between the color wheel and the DMD. The higher the speed, the less rainbow effect on the screen.

Configuration Menu

The Configuration menu sets the language, projection orientation, power usage, and other preferences for the projector.

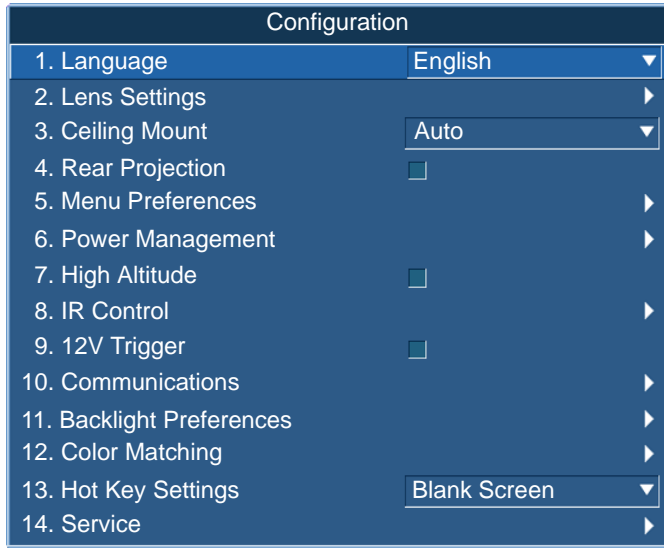

Menu item	Description	Options
Language	Selects an available language for the on-screen display.	<ul style="list-style-type: none"> • English • French • German • Italian • Spanish • Chinese (Simplified) • Japanese • Korean • Russian
Lens Settings	Adjusts the lens.	<ul style="list-style-type: none"> • Focus and Zoom—Adjust the focus and zoom the image in or out. • Lens Shift—Shifts the lens up and down, or left and right. • Lens Shift Memory—Applies zoom, focus, and lens position according to the chosen set of lens memory position. Save the current zoom, focus, and lens position to the projector memory. • Lock All Lens Motors—Selects this function to prevent all lens motors from moving. It may disable the zoom, focus, horizontal and vertical position settings, locking any changes and overriding all other lens features. This helps to prevent accidental lens position changes in multi-projector installations. • Lens Calibration—Calibrates the lens center.

Menu item	Description	Options
Ceiling Mount	Turns the image upside down for ceiling-mounted projection.	—
Rear Projection	Reverse the image so you can project from behind a translucent screen.	—
Menu Preferences	Sets the on-screen display menu preferences, and the password for the projector.	<ul style="list-style-type: none"> • Menu Horz Offset—Changes the horizontal position of the on-screen display. • Menu Vert Offset—Changes the vertical position of the on-screen display. • Show Messages—Displays status messages on the screen. • Menu Transparency—Changes the on-screen display menu background to be transparent. As the value increases, more of the image behind the menu is visible. • Splash Screen Setup—Selects the splash screen. • PIN Protect—Protects your projector with a password. Once enabled, you must enter the password before you can project an image. • Change PIN—Allows you to change the password.
Power Management	Determines the power modes for the projector.	<ul style="list-style-type: none"> • Standby Mode—Determines if the projector is in standby mode when connected to AC power (<0.5 W). • AC Power On—Automatically turns the projector on when electrical power is connected. • Auto Shutdown—Automatically turns the projector off after no signals are detected for a preset number of minutes. If an active signal is received before the projector powers down, the image is displayed. • Sleep Timer—Allows the projector to automatically power off after it has been on for a specified amount of time (two, four, or six hours). • Cool Down—Configure the cool down time period (instantly off, after 1 minute, or after 2 minutes).
High Altitude	Enables or disables high altitude mode.	<ul style="list-style-type: none"> • On—Enables high altitude mode for altitudes \geq 2000 m. The fan operates at high speed to ensure sufficient air flow for high altitudes. • Off—Disables high altitude mode. For altitudes below 2000 m.
IR Control	Enables or disables the IR sensors.	<ul style="list-style-type: none"> • Top—Enables or disables the signal from the top IR sensor. • Front—Enables or disables the signal from the front IR sensor. • HDBaseT—Enables or disables the signal from the HDBaseT Box.

Menu item	Description	Options
12V Trigger	Sets the 12V trigger on or off. The 12V trigger is used for electrical projector screens. The projector screen is automatically lowered or raised when the projector is switched on or off.	—
Communications	Determines the communication settings such as network setup, serial port information, and so on.	<p>Network—Allow you to set up network settings.</p> <ul style="list-style-type: none"> • DHCP—Turns the DHCP on or off. • IP Address—Assigns the network IP address. • Subnet Mask—Assigns the network subnet mask. • Default Gateway—Assigns the network default gateway. • MAC Address—Displays the network MAC address value. • Apply—Triggers the modifying of the LAN setting. • Enable—Enables or disables the WLAN functionality. • Start IP—Enter the start IP address for wireless network. • End IP—Enter the end IP address for wireless network. • SSID—Enter a unique wireless network name (SSID). • Show Network Messages—Turns network messages on or off. • Restart Network—Restarts the network. • Network Factory Reset—Performs factory reset on the network settings. The Projector Name, IP Address (LAN), Start IP and End IP, and SNMP settings can be reset. <p>Serial Port Baud Rate—Selects the serial port and baud rate.</p> <p>Serial Port Echo—Controls whether the serial port echoes characters.</p> <p>Serial Port Path—Sets the serial port path to RS232 or HDBaseT.</p> <p>Projector Address—Sets the projector address (0 to 9). The projector responds to the IR remote set to the same address as the projector or to the IR remote set to address 0.</p>
Backlight Preferences	Controls the back light behavior and timeout setting for the keypad and status LED.	—

Menu item	Description	Options
Color Matching	<p>Enables the selected method (Manual Adjustment or HSG) to define the precise hue of each primary color component (red, green, blue and white).</p> <p>When one method is enabled, the other method is automatically disabled. For both methods, if Auto Test Pattern is enabled, the solid colored test pattern can be displayed according to the menu item on which you are positioned.</p> <p>For more information on color matching, see Color matching on page 47.</p>	<ul style="list-style-type: none"> • Manual Adjustment—Manually defines the precise hue of each primary color component. • HSG Adjustment—Adjusts the hue, saturation, and gain (HSG) of the projected image. The HSG function independently controls each of the color regions R, G, B, C, M, Y, and W. • Wall Color—Sets the wall color so the projector can enhance the color performance customized for the specific wall.
Hot Key Settings	<p>Assigns a different function to the hot key on the IR remote keypad by highlighting the function in the list and pressing ENTER.</p> <p>Choose a function that does not already have a dedicated button, and assign the hot key to that function, allowing you to quickly and easily use the chosen function.</p>	—

Menu item	Description	Options
Service	Displays projector information, sets test patterns, error logs, and high temperature warnings.	<ul style="list-style-type: none"> • Projector Info—Displays the current projector settings. (Read-only) • Factory Reset—Restores all settings to their default value. It does not reset network but it resets RS232. • Test Pattern—Sets the required internal test pattern to display. To turn off a test pattern, select Off. • Wheel Index (2X)—Sets the wheel index to Speed 2X. Only use this setting when a new main board is installed, and the picture quality needs to be optimized. • Wheel Index (3X)—Sets the wheel index to Speed 3X. Only use this setting when a new main board is installed, and the picture quality needs to be optimized. • Error Log—Shows the projector error log for debug. • Mode Adjustment—Fine tunes the horizontal (H) and vertical (V) start position for a signal in the EDID timing table and record the values in the system to override the timing table. To keep the settings, before exiting the menu, select Saved to Record. To revert to original timing table settings, manually clear each setting. Factory Defaults do not clear these override settings. • Laser Diode Info—Displays the information of each laser diode bank including its voltage, current, and temperature. • ADC Calibration— <ul style="list-style-type: none"> • Calibration Condition—Displays required equipment for ADC Calibration. • ADC Calibration—Calibrates RGB Gain or offset for analog signal only. • Light Sensor—Calibration must be performed before using Rental mode or after laser diode driver board replacement.

Color matching

You may require a unique color gamut (range) for a single projector or application, or you may need to precisely match colors across multiple adjacent displays. Use color matching by Manual Adjustment or HSG to define the precise hue of each primary color component (red, green, blue and white).

HSG

Hue, Saturation, and Gain (HSG) software controls the color regions R, G, B, C, M, Y, and W independently.

1. Select HSG, select **Color Matching > HSG**.

Hue

Note the following about adjusting hue:

- Adjust the hue independently for each color (R,G,B,C,M, and Y).
- White does not have a hue input.
- A negative hue input provides a clockwise rotation of the color's hue.
- A positive hue input provides a counter-clockwise rotation of the color's hue.
- A zero input does not change the hue of the color.

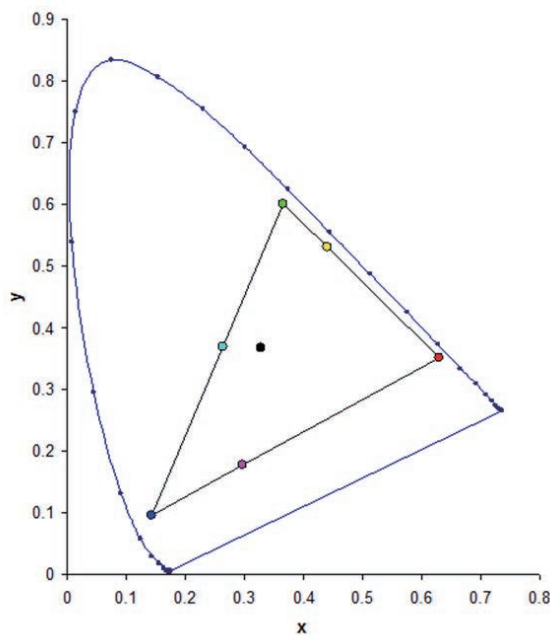

Saturation

Note the following about adjusting saturation:

- The saturation can be adjust independently for each color (R,G,B,C,M, and Y).
- A saturation level of 0 removes all color from that region.
- A saturation level of 254 sets the color region to have maximum color.
- A saturation level of 127 does not change the saturation.

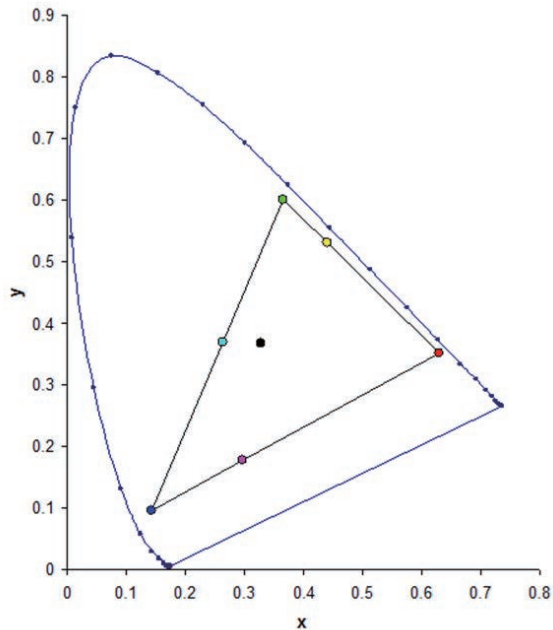

Gain

Note the following about adjusting gain:

- The gain can be adjust independently for each color (R,G,B,C,M,Y, and W).
- The range of input is 0 to 254.
- The gain changes the intensity level of the respective color.
- A gain level of 127 disables the HSG controls for that color.
- A gain level less than 127 darkens the respective color.
- A gain level of 254 sets the color region to have maximum gain; however, clipping occurs on the signal.
- A gain of 127 is the nominal setting.
- White provides three gain level controls, one each for the R,G,B component of white.

Light Source menu

The Light Source menu sets the light source mode and power preferences.



Menu item	Description	Options
Light Source Mode	Sets the light source mode.	<ul style="list-style-type: none"> Constant Power Constant Intensity—Set the value in Constant Power mode and change to Constant Intensity mode to maintain constant brightness and color settings. The light sensor monitors the light level and consumes more power than the laser brightness decays naturally over time. When the laser setting sets to maximum power, it remains at this setting for longer period of time than Constant Power mode. Note the following: <ul style="list-style-type: none"> This mode is used for long term projecting or blending purpose. When Constant Intensity is enabled, Dynamic Black and RealBlack function are automatically disabled. When Picture Settings is changed under Constant Intensity mode, it would automatically change back to Constant Power mode. ECO 1/ECO 2 Rental Mode—Remains at 90% constant brightness and color settings. Light sensor calibration must be performed before enable Rental mode.
Constant Power	Sets the value of the laser diode power.	—
Light Source Info	Display information about the light source in the projector.	<ul style="list-style-type: none"> Total Projector Hours—Displays the current total number of hours the projector has been used. LD Hours—Displays the current total number of hours the laser diode has been used.
Light Sensor Calibration	Set the time for light calibration.	<ul style="list-style-type: none"> Default—Process light calibration at cooling stage. Auto—Process light calibration for every 168 hours. Manual—User performs light calibration manually.

Status menu

The read-only Status menu lists a variety of details about the standard and optional components currently detected in the projector.

For DHD models

Status	
Model Name	D13HD-HS
Serial Number	H1YYWWXXX
Native Resolution	1920 x 1080
Firmware	V02.00,A02.00,B01.00
Main Input	VGA 1
Main Signal Format	720P
Main Pixel Clock	74.256 MHz
Main Sync Type	Sync On Green
Main Horz Refresh	45.1 KHz
Main Vert Refresh	60.0 Hz
PIP/PBP Input	-
PIP/PBP Signal Format	-
PIP/PBP Pixel Clock	-
PIP/PBP Sync Type	-
PIP/PBP Horz Refresh	-
PIP/PBP Vert Refresh	-
Light Source Power	99
Total Projector Hours	0
Light Source Hours	0
LC Hours	0
Standby Mode	0.5W Mode
Lens Lock Settings	Allow
IP Address	192.168.0.100
DHCP	No
System Temperature	29 C, No Filter

For DWU models

	Status
Model Name	D13WU-HS
Serial Number	H1YYWWXXX
Native Resolution	1920 x 1200
Firmware	V02.00,A02.00,B01.00
Main Input	VGA 1
Main Signal Format	720P
Main Pixel Clock	74.256 MHz
Main Sync Type	Sync On Green
Main Horz Refresh	45.1 KHz
Main Vert Refresh	60.0 Hz
PIP/PBP Input	-
PIP/PBP Signal Format	-
PIP/PBP Pixel Clock	-
PIP/PBP Sync Type	-
PIP/PBP Horz Refresh	-
PIP/PBP Vert Refresh	-
Light Source Power	99
Total Projector Hours	0
Light Source Hours	0
LC Hours	0
Standby Mode	0.5W Mode
Lens Lock Settings	Allow
IP Address	192.168.0.100
DHCP	No
System Temperature	29 C, No Filter

Input Switching & PIP menu

The Input Switching & PIP menu determines how the main and PIP/PBP inputs are handled.

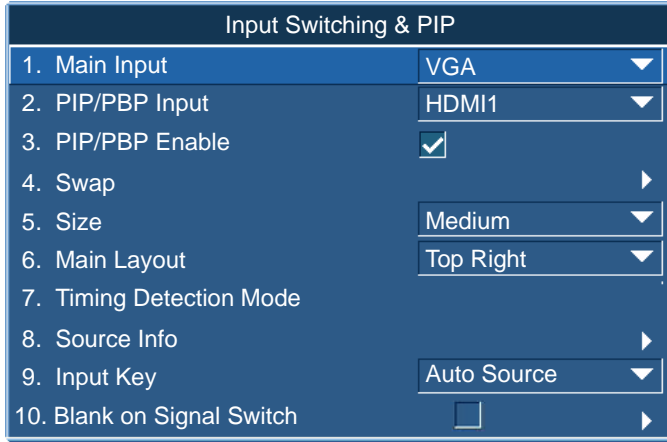

Menu item	Description	Options
Main Input	Selects an active input to be used as the main image.	—
PIP/PBP Input	Selects an active input to be used as the PIP/PBP.	—
PIP/PBP Enable	Toggles between displaying two sources at once (main and PIP/PBP images) or one source only. Refer to <i>Inputs</i> on page 78 and <i>PIP/PBP compatibility</i> on page 82.	<ul style="list-style-type: none"> Selected checkbox—Turns the PIP/PBP source on. Cleared checkbox—Turns the PIP/PBP source off.
Swap	Changes the main image to PIP/PBP, and the PIP/PBP to main image. Swapping is available only when PIP/PBP is enabled.	—
Size	Selects the PIP/PBP size to small, medium, or large.	—
Main Layout	Sets the location of the PIP/PBP image on the screen.	—
Timing Detection Mode	Sets timing detection mode to wide or normal to support additional PC timings. When the projected picture is not completed, this function is used to adjust the picture. For 4:3 input sources not recognized by Wide mode (for example 1400 x 1050), perform Auto Image using Normal mode.	<ul style="list-style-type: none"> Normal mode—Supports 4:3 input sources. Wide mode—Supports the 16:9 input source and most 4:3 input sources.
Source Info	Displays the current source settings. (Read-only)	—
Input Key	Lists or changes the sources.	—

Menu item	Description	Options
Blank On Signal Switch	Blanks the screen before timing is stable when changing the source.	<ul style="list-style-type: none"> • Enabled—Blanks the screen before timing is stable when charging source. • Disabled—Disables blanking the screen.

PIP/PBP layout and size

A P indicates the primary source region (lighter color) and an asterisk (*) indicates both regions are the same size.

PIP/PBP Layout	PIP/PBP Size		
	Small	Medium	Large
PBP, Main Left			
PBP, Main Top			
PBP, Main Right			
PBP, Main Bottom			
PIP-Bottom Right			
PIP-Bottom Left			
PIP-Top Left			
PIP-Top Right			

Language menu

Select an available language for the on-screen display.



Test Pattern menu

Choose the required internal test pattern to display, or select Off to turn off a test pattern.

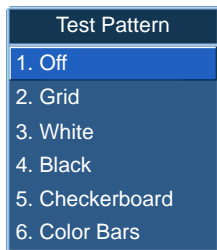

Web user interface

The web user interface provides an alternate way to access the menu functionality on the projector.

Logging on to the web user interface

Log onto the web user interface by following the steps below.

1. Open a web browser and type the IP address (in the address bar) assigned to your projector.

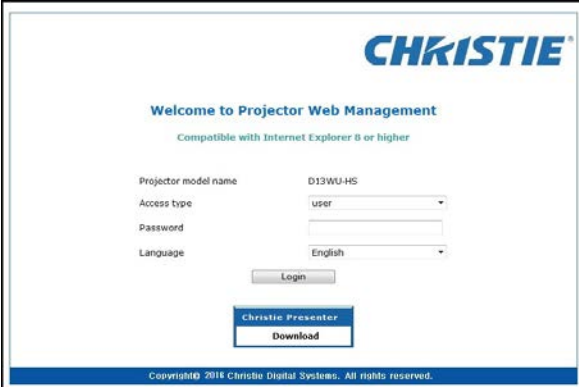

The screenshot shows the Christie Projector Web Management login page. At the top, the Christie logo is displayed. Below it, the text reads "Welcome to Projector Web Management" and "Compatible with Internet Explorer 8 or higher". The form includes the following fields and options:

- Projector model name: D13WU-HS
- Access type: user (dropdown menu)
- Password: (text input field)
- Language: English (dropdown menu)

Below the form are two buttons: "Login" and "Christie Presenter Download". At the bottom of the page, the copyright notice reads "Copyright © 2016 Christie Digital Systems. All rights reserved."

2. From the Access type list, select the log in level.
3. In the Password field, type the password.
4. From the Language list, select the appropriate language.
5. To access the Main window, click **Login**.

Main tab-General

Displays information about the projector, its power status, and what is selected for the main and PIP/PBP input sources.

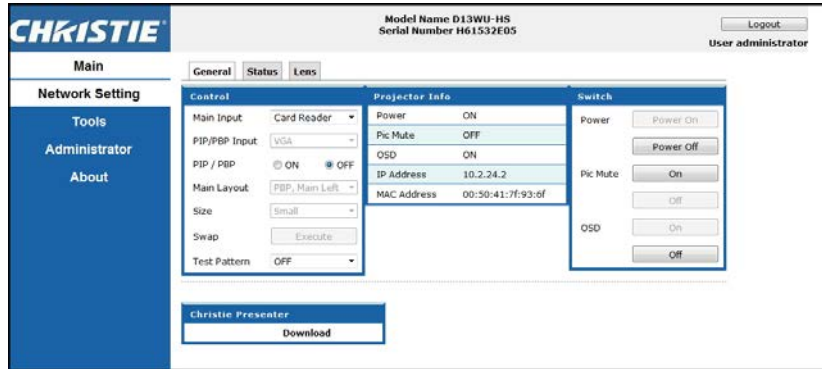

Panel	Description
Control	Selects main source/PIP source, enables or disables PIP/PBP, changes the layout or PIP size, swap, and change the test pattern.
Projector Information	Check the projector information for power status, Pic mute status, on-screen display status, IP address, and MAC address.
Switch	Switches the on or off status of Power, Pic Mute, and on-screen display.

Main tab-Status

Displays the current status of light source, cooling (fans), version numbers and signal (source) information.

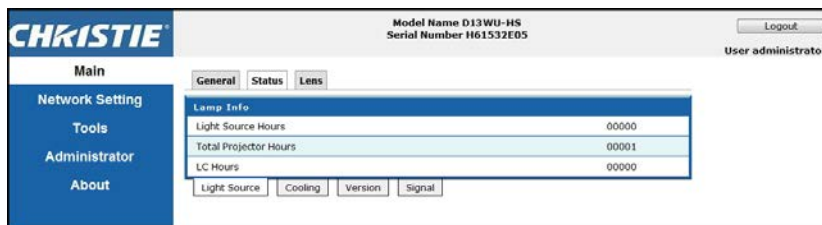

Main tab-Lens

Controls the focus, lens shift, and zoom adjustments for the lens.

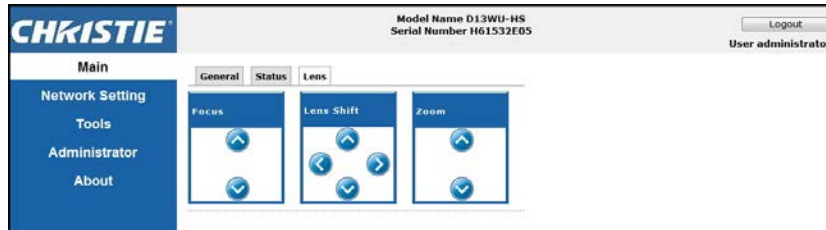

Network

If you change a setting, the network subsystem of the projector may restart, and you may be logged off.

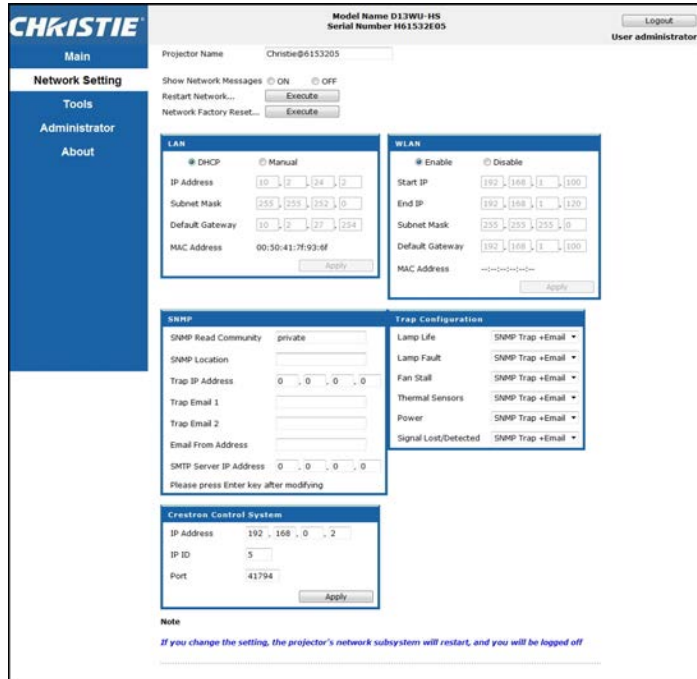

Panel	Description
Restart Network	Execute a network restart. This does not change any of the network settings.

Panel	Description
Network Factory Reset	<p>Execute a network factory reset. Network settings may be reset to the following default values.</p> <p>Projector Name = Christie@ + Serial Number</p> <p>Show Network Messages = ON</p> <p>LAN settings:</p> <ul style="list-style-type: none"> • Manual • IP Address = 192.168.0.100 • Subnet Mask = 255.255.255.0 • Default Gateway = 192.168.0.100 <p>WLAN settings:</p> <ul style="list-style-type: none"> • Enabled • Start IP = 192.168.1.100 • End IP = 192.168.1.120 • Subnet Mask = 255.255.255.0 • Default Gateway = 192.168.1.100 <p>SNMP settings:</p> <ul style="list-style-type: none"> • SNMP Read Community = private • Trap IP Address = 0.0.0.0 • SMTP IP Address = 0.0.0.0 • All other settings are cleared or blanked <p>Trap Configuration:</p> <ul style="list-style-type: none"> • All items = SNMP Trap + Email
LAN Setting Panel	<ul style="list-style-type: none"> • Sets if the projector must obtain an automatically assigned IP address through DHCP or if the user sets the address manually. • For the TCP/IP setting, enter the IP address, netmask, and default gateway address.
WLAN Setting Panel	<ul style="list-style-type: none"> • Enables or disables the wireless LAN of the projector. • Enter the IP address range, netmask, and default gateway for the wireless LAN.

Panel	Description
SNMP Panel	<p>Provides network administrators with a common way to manage their network devices from a single remote location. Administrators can use the Simple Network Management Protocol (SNMP) interface to query a number of devices to see their current status or configuration. Operators can change configuration values and configure trap notifications to be sent when certain events occur (for example, loss of signal, power state change, and so on).</p> <p>Emails are sent to the mail server configured in the projector settings. Up to two user email accounts can be selected. Important information regarding the event is located in the body content of the email.</p> <p>SNMP Traps are notifications that are sent from the projector. They are only received by a trap receiver (MIB Browser) in the computer.</p> <ul style="list-style-type: none"> • SNMP Read Community (default setting: private)—Plain text password that must also be entered in the MIB browser. This password allows various settings in the projector to be queried. • SNMP Location (default setting: blank)—Use as a description to where a projector is located in a building. SNMP emails sent specify this location. • Trap IP Address (default setting: 0.0.0.0)—Fill in this field with the IP address of the computer, on which you want to view received traps from the projector. • Trap Email 1/2 (default setting: Blank)—Set the Trap Email 1 and 2 to an email address configured under the mail server entered in the SMTP Server IP Address field. • Email from Address (default setting: blank)—Set the name of the source of the SNMP emails. • SMTP Server IP Address (default setting: 0.0.0.0)—Enter the IP address of the mail server.
Trap Configuration Panel	<p>Set the SNMP actions for the system events. The options are:</p> <ul style="list-style-type: none"> • SNMP Trap • + Email • Email • SNMP Trap • Disabled
Crestron Control System Panel	<p>Enter the IP address, IP ID, and port of Crestron device for the connection.</p>

Tools

Use the Tools pages to control size and position, image settings, configuration, light source, input switching, PIP, and test patterns.



Administrator Page

Add or delete a user or change password.

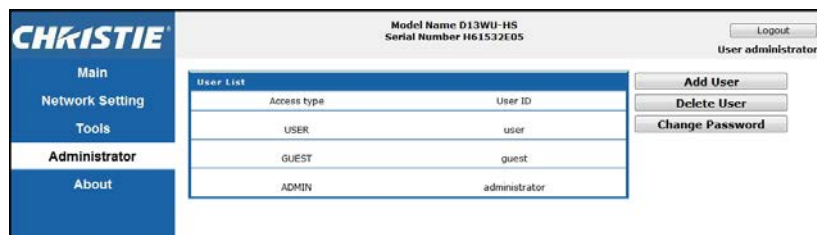

About Page

The About page provides version and license information about HS Series.

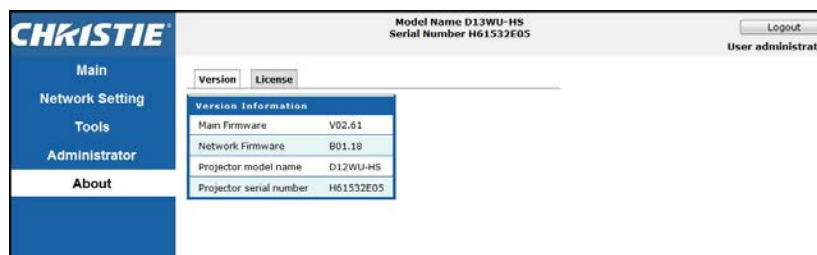

Tab	Description
Version	Views the main firmware version, network firmware version, projector model name, and projector serial number.
License	Displays the license information of the computer program.

Christie Presenter

The Christie Presenter application allows a remote desktop from a host PC to be displayed on the network display through Ethernet or wireless transports. It can adapt to different network settings (DHCP, fixed IP, and direct link by Ethernet cable).

Download Christie Presenter from the Christie website or from the web page of the projector.

Connecting to the Projector

Before using Christie Presenter, you must connect to the projector.

1. Connect to the projector using WiFi or Ethernet.

Ethernet connection:

- a. To determine the projector's IP address, select **Main Menu > Configuration > Communications > LAN**.

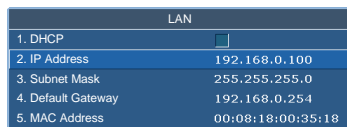

LAN	
1. DHCP	<input type="checkbox"/>
2. IP Address	192.168.0.100
3. Subnet Mask	255.255.255.0
4. Default Gateway	192.168.0.254
5. MAC Address	00:08:18:00:35:18

- b. Configure your PC IP address to be on the same network as the projector.
- c. The projector and computer must be connected directly or over the network using Ethernet.

WiFi Wireless connection:

- a. Insert the WiFi USB dongle (1DWUSB-BGN) into the USB port on the projector input panel.

For more information about the WiFi USB dongle, see [page 83](#).

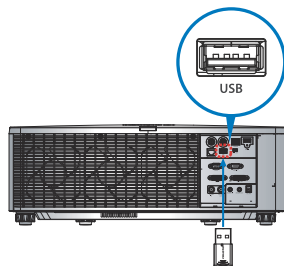

- b. Power on the projector.
- c. Obtain the WiFi SSID from **Main Menu > Configuration > Communications > WLAN**.

- d. Connect your PC device to the wireless SSID for the selected projector, for example: Christie@0111000123.



Installing the Christie Presenter software

Install and configure the Christie Presenter software.

1. In a web browser, connect to the projector's network address.
The default address is 192.168.1.100.
2. Download and install the Christie Presenter software.

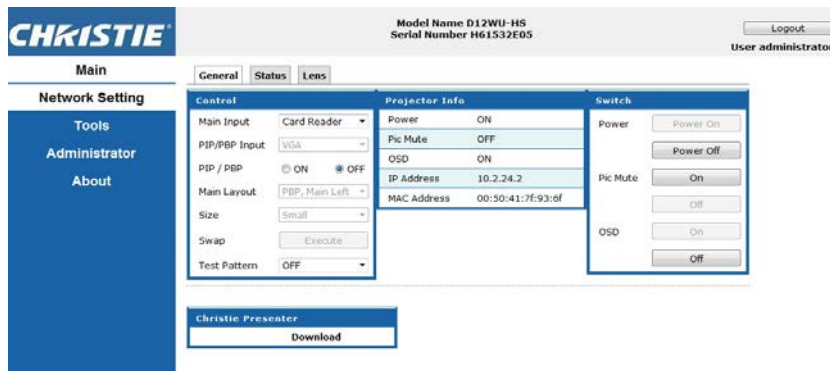

3. Configure the Christie Presenter software.



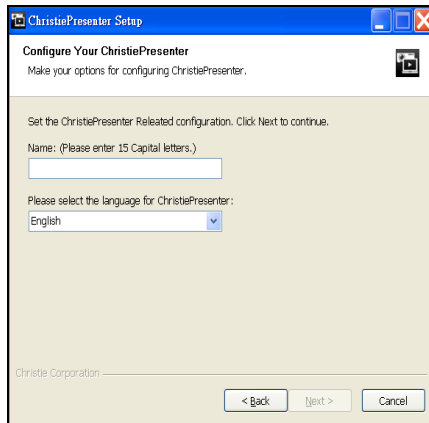



The name entered identifies all computers connected to the projector by the Christie Presenter software—either wired or wireless connections. The **Network Display Management > Device Management** tab shows all current connections.



Using the Christie Presenter

After starting the Christie Presenter application, the main window appears.



Icon	Description
	Connects and searches the network display.
	Stops or starts displaying desktop contents to the connected network display.
	Selects a display region.
	Configures Christie Presenter.
	Manages all connected network displays.
	Disconnects all connections.

Connecting and searching the network display

1. To enter into the connection menu section, click .
2. If the IP address of the projector is known, type the IP address and click **Connect**.
3. If the IP address is not known:
 - a. To search for the projector on the network, click **Search**.
 - b. Select the projector to which you want to connect.
 - c. To access the Login dialog, click **Connect directly**.

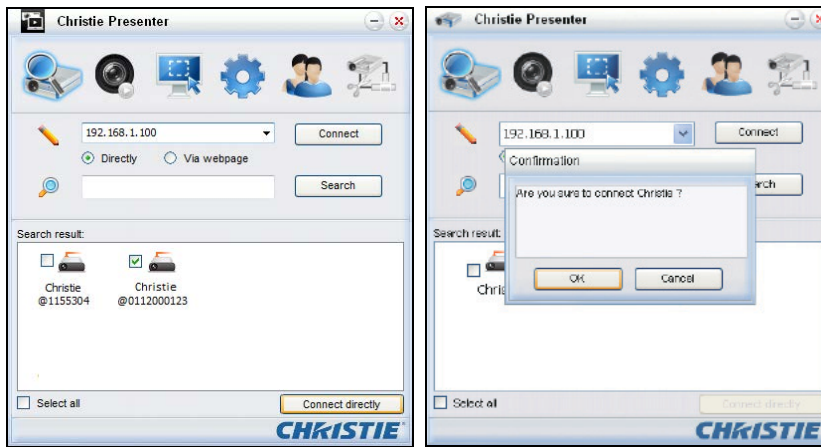

4. In the Login dialog, select the user type and type the password.

The default password for the Normal user is left blank. If the password was previously set, it appears in the bottom-left corner of the on-screen display. The default password for the Admin user is admin.

- In the Select display port window, select the display port.

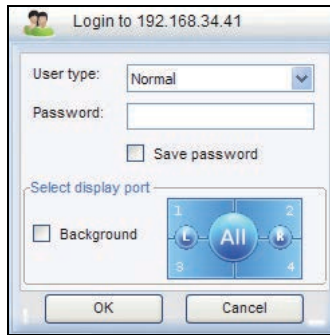

Selecting the display region

When the connection is set up, you must select the display region.

- To select the size of the projection region, click  and select an option: FullScreen, FixedSize, or Alterable.

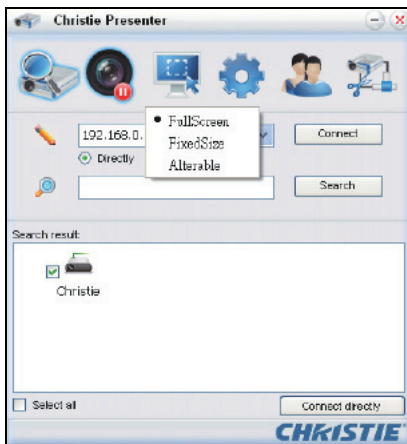

Tab	Description
FullScreen	Turns the default capture mode to full screen when the program is launched. If screen capture starts, the image of the entire screen is transferred to a remote network display.
FixedSize	Transfers on the image enclosed inside the frame (after a user places a frame on the desktop) to remote network display.
Alterable	Encloses only the captured region by the frame. To enlarge or downsize the region, drag the eight small black squares scattered on eight edges of the frame.

Configuring Christie Presenter

Set the language for Christie Presenter, the region size of fixed size capture mode, if a notification message dialog is allowed, the quality of JPEG images, YUV sample formats, and the network port setting.

1. To configure Christie Presenter for basic and advanced settings, click  .

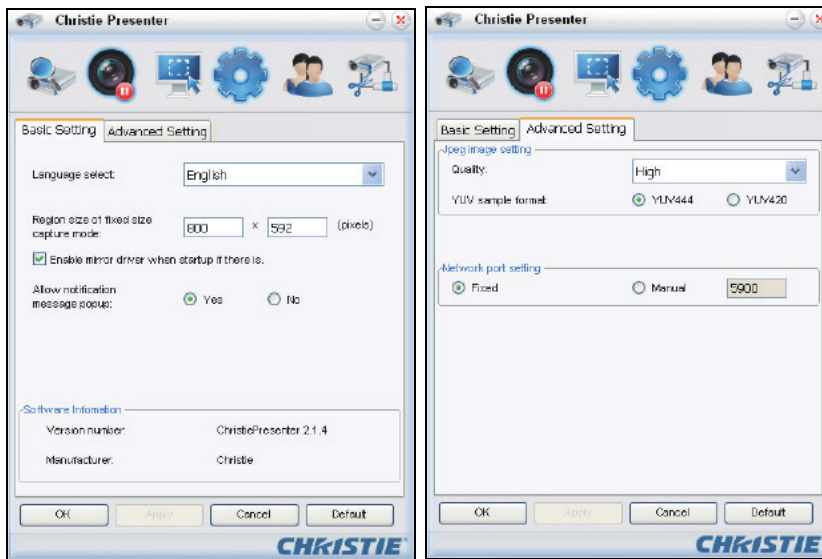









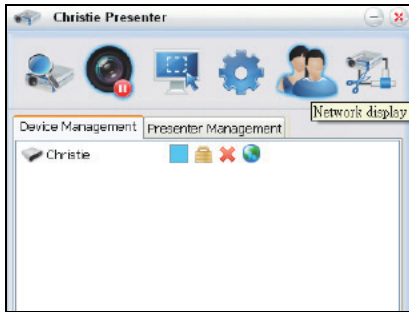

Tab	Description
Basic Setting	Selects the language, changes the region size of fixed size capture mode, and selects if a notification message dialog is allowed.
Advanced Setting	Selects the quality of JPEG image, YUV sample formats and the network port setting. The fixed port is port 5900.

Managing all connected network displays

You can manage all connected network displays and users at the same time.

1. To control all users connected to the same projector, click .



Icon	Description
	Indicates the administrator is logged in.
	Indicates a normal user logged in.
	Indicates the device is connected.
	Indicates the device is not connected.
	Shows the current status and display position of the local screen on the network display. Click to change the display position. A dialog appears.
	Changes the password to the target network display. Only an Administrator user can change the password.
	Does not require a response. If user logs in as Admin, the key icon is displayed and the Presenter password can be changed. If user log in as Normal, the lock icon is displayed and the Presenter password cannot be changed.
	Disconnects from the target network display.
	Connects to a target network display using a web page.

Operating the card reader

The Card Reader application has four available operation modes:

- USB Flash Devices Detection screen
- Thumbnail Display mode
- Images Display mode
- Images Slide Show mode

USB Flash Device Detection screen

In this mode, the Card Reader application detects any USB flash devices hot-plug events and displays the flash device icon. When the flash device is removed from USB, the icon disappears. Christie recommends removing the USB flash devices only when the Card Reader is changed to the USB Flash Devices Detection Screen state.

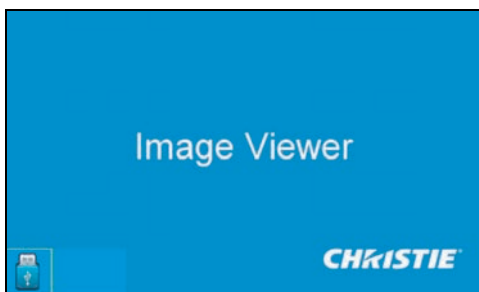

Thumbnail Display mode

1. To access the Thumbnail Display mode, press the **Enter**.
Different photos in different folders can be chosen.
2. To access the Card Reader operation UI, press **Menu**.

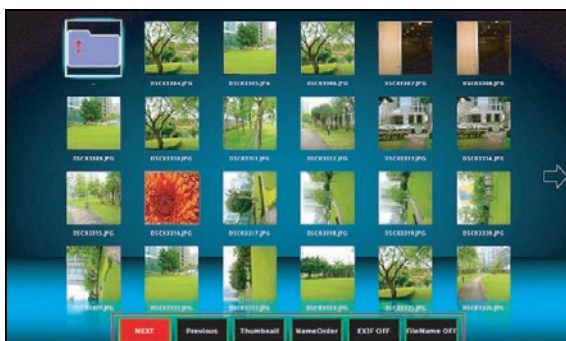

3. Operate the Card Reader application with the **Enter**, **Left**, **Right**, **Up**, and **Down** keys.

The following buttons are supported in the user interface:

Button	Description
Previous	Moves the selected item left or goes to previous page when this is the left-most item.

Button	Description
Next	Moves the selected item right or goes to next page when this is the right most item.
Display	Displays the selected image or folder.
Thumbnail	Enter the Thumbnail Display mode.
SlideShow	Enter the Slide Show mode.
NameOrder	Sorts files and folders by name.
ExtendOrder	Sorts files and folders by extended order.
SizeOrder	Sorts files and folders by size.
TimeOrder	Sorts files and folders by time.
EXIF ON/OFF	Enables or disables the auto image rotate accordingly to EXIF information.
FileName ON/OFF	Enables or disables the filename display in Thumbnail Display mode.

Image Display mode

1. In the Thumbnail Display mode, to enter the Image Display mode, press **ENTER**.
2. To display the last or next image in the Image Display mode, use the **Left** and **Right** keys.
3. To exit Image Display mode and return to Thumbnail Display mode, press **ENTER**.



4. To display an image in the Image Display mode use the operation UI.

The following operations are supported in the operation UI.

Button	Description
Display	Enter the Image Display mode.
Thumbnail	Enter the Thumbnail Display mode.
SlideShow	Enter the Slide Show mode.
Actual Size	Displays the image in actual size.
Best Fit	Display the image in a size that best fits the screen.
EXIFDisp OFF/On	Enables or disables the EXIF information display.
+90deg	Rotates the image 90 degrees.
-90deg	Rotates the image -90 degrees.

Image Slide Show mode

1. In the Thumbnail Display mode, to enter the Slide Show mode, press **SlideShow**.
2. In the Slide Show mode, to enter the Image Display Mode, press **ENTER**.
3. To display an image in the Slide Show mode use the operation UI.



The following operations are supported in the Slide Show Mode operation UI.

Button	Description
Stop	Stops Slide Show mode.
Next	Displays the next image.
Previous	Displays the previous image.
Delay 3/4/5	Sets a slide show delay in seconds.
Slide Effect	Supports for the following slide effects: <ul style="list-style-type: none"> • Slide Right • Blocks • RightDown • XLines • Slide Up • Ylines
Repeat ON/OFF	Enables or disables Slide Show Repeat mode.

When the image cannot be displayed due to a memory limitation or an unsupported image format, the specific image is displayed on the center of the screen.

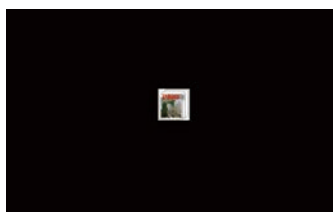

Troubleshooting

If you cannot resolve an issue using the information provided in this section, contact your reseller or service center.

No image appears on screen

The image does not appear on the screen.

Resolution

- Make sure all the cables and power connections are correctly and securely connected.
See [Installation](#) on page 21 for more details.
- Make sure the projector is switched on.

Incorrectly displayed image

The image is partial, is scrolling, or is otherwise incorrectly displayed.

Resolution

If using a PC (for Windows 95, 98, 2000, XP, Windows 7):

1. On control panel or IR remote keypad, press **AUTO**.
2. Select **My Computer > Control Panel**.
3. Double-click **Display**.
4. Select the **Settings** tab.
5. Verify your display resolution setting is lower than or equal to WUXGA (1920 × 1200).
6. Click **Advanced Properties**.
7. If the projector is still not projecting the entire image, change the monitor display:
 - a. Verify the resolution setting is lower than or equal to WUXGA (1920 × 1200).
 - b. Switch to the **Monitor** tab.
 - c. Click **Change**.

- d. Click **Show all devices**.
- e. Under the SP box, select **Standard monitor types**.
- f. Under the Models box, select the appropriate resolution mode.
- g. Verify that the resolution setting of the monitor display is lower than or equal to WUXGA (1920 × 1200).

If using a Notebook:

1. On control panel or IR remote keypad, press **AUTO**.
2. Adjust resolution of the computer.
3. To send signal out from notebook to projector, press the keys listed below for your Notebook manufacturer (for example, [Fn]+[F4]):

Notebook brand	Function keys
Acer	[Fn]+[F5]
Asus	[Fn]+[F8]
Dell	[Fn]+[F8]
Gateway	[Fn]+[F4]
IBM/Lenovo	[Fn]+[F7]
HP/Compaq	[Fn]+[F4]
NEC	[Fn]+[F3]
Toshiba	[Fn]+[F5]
Mac Apple	System Preference > Display > Arrangement > Mirror display

4. If you experience difficulty changing resolutions or your monitor freezes, restart all equipment including the projector.

Presentation is not displayed

The screen of the Notebook or PowerBook computer is not displaying your presentation.

Details

Some Notebook PCs may deactivate their own screens when a second display device is in use. Each has a different method of reactivation.

Resolution

Refer to your computer manual for information on changing the method of reactivation.

Unstable or flickering images

The image is unstable or is flickering when projected.

Resolution

- To correct the pixels, use Pixel Track and Pixel Phase.
- Change the monitor color setting on your computer.

Vertical flickering bar

The image has a vertical, flickering bar when projected.

Resolution

- To make an adjustment, use **Auto Image**.
- Check and reconfigure the display mode of your graphic card to make it compatible with the projector.

Image is out of focus

The image is out of focus on the screen.

Resolution

- Make sure both lens caps (front and back) are removed.
- Adjust the lens focus to fit the screen.
- Make sure the projection screen is between the required distance.

Image is stretched

The image is stretched when displaying a 16:9 DVD title.

Details

When you play anamorphic DVD or 16:9 DVD, the projector shows the best image if the projector display mode is set to 16:9 in the on-screen display.

Resolution

- If you play 4:3 format DVD titles, change the format to 4:3 in the projector on-screen display.
- If the image is still stretched, adjust the aspect ratio by setting the display format as 16:9 (wide) aspect ratio type on your DVD player. For more details, see [Size and Position menu](#) on page 35.

Image is not the correct size

The image is too small or too large.

Resolution

- Adjust the lens zoom to fit.
- Verify you are using the correct lens.
- Change the position of the projector.

Specifications

Learn about the product specifications. Due to continuing research, specifications are subject to change without notice.

Inputs

The following table details the inputs for HS Series. RB in the Resolution column indicates reduced blanking.

Signal Type	Resolution	Frame rate (Hz)	VGA	HDMI	DVI	3G-SDI	HDBaseT
PC	640x480	60	•	•	•		•
	640x480	72	•	•	•		•
	640x480	75	•	•	•		•
	640x480	85	•	•	•		•
	640x480	66.6		•	•		•
	720x400	70	•	•	•		•
	800x600	60	•	•	•		•
	800x600	72	•	•	•		•
	800x600	75	•	•	•		•
	800x600	85	•	•	•		•
	800x600	120	•	•	•		•
	832x624	75	•	•	•		•
	848x480	50		•	•		•
	848x480	60		•	•		•
	848x480	75		•	•		•
	848x480	85		•	•		•
	1024x768	60	•	•	•		•
	1024x768	75	•	•	•		•
	1024x768	85	•	•	•		•
	1024x768	120	•	•	•		•
	1152x720	50		•	•		•
	1152x720	60		•	•		•
	1152x720	75		•	•		•
	1152x720	85		•	•		•
	1152x864	60	•	•	•		•
	1152x864	70	•	•	•		•
	1152x864	75	•	•	•		•
	1152x864	85	•	•	•		•
	1152x870	75		•	•		•
	1280x720	50		•	•		•
	1280x720	60	•	•	•		•

Signal Type	Resolution	Frame rate (Hz)	VGA	HDMI	DVI	3G-SDI	HDBaseT
PC	1280x720	75	•	•	•		•
	1280x720	85	•	•	•		•
	1280x720	120	•	•	•		•
	1280x768	60	•	•	•		•
	1280x768	75	•	•	•		•
	1280x768	85	•	•	•		•
	1280x800	50	•	•	•		•
	1280x800	60	•	•	•		•
	1280x800	75	•	•	•		•
	1280x800	85	•	•	•		•
	1280x960	50	-	•	•		•
	1280x960	60	•	•	•		•
	1280x960	75	•	•	•		•
	1280x960	85	•	•	•		•
	1280x1024	50		•	•		•
	1280x1024	60	•	•	•		•
	1280x1024	75	•	•	•		•
	1280x1024	85	•	•	•		•
	1360x768	50		•	•		•
	1360x768	60		•	•		•
	1360x768	75		•	•		•
	1360x768	85		•	•		•
	1368x768	60	•	•	•		•
	1400x1050	50		•	•		•
	1400x1050	60		•	•		•
	1400x1050	75	•	•	•		•
	1440x900	60	•	•	•		•
	1440x900	75		•	•		•
	1600x900	60		•	•		•
	1600x1200	60	•	•	•		•
	1680x1050	60	•	•	•		•
	1920x1080	50		•	•		•
	1920x1080	60	•	•	•		•
1920x1200RB	60	•	•	•		•	

Signal Type	Resolution	Frame rate (Hz)	VGA	HDMI	DVI	3G-SDI	HDBaseT
PC	1920X1200RB	50	•	•	•		•
NTSC	NTSC (M, 4.43)	60					
PAL	PAL (B,G,H,I)	50					
	PAL (N)	50					
	PAL (M)	60					
SECAM	SECAM (M)	50					
SDTV	480i	60	•	•	•		•
	576i	50	•	•	•		•
EDTV	480p	60	•	•	•		•
	576p	50	•	•	•		•
HDTV	1080i	25	•	•	•		•
	1080i	29	•	•	•		•
	1080i	30	•	•	•		•
	720p	50	•	•	•		•
	720p	59	•	•	•		•
	720p	60	•	•	•		•
	1080p	23	•	•	•		•
	1080p	24	•	•	•		•
	1080p	25	•	•	•		•
	1080p	29	•	•	•		•
	1080p	30	•	•	•		•
	1080p	50	•	•	•		•
	1080p	59	•	•	•		•
	1080p	60	•	•	•		•
Mandatory 3D	Frame Packing 1080p	24		•			•
	Frame Packing 720p	50		•			•
	Frame Packing 720p	60		•			•
	Side by Side 1080i	50		•			•
	Side by Side 1080i	60		•			•
	Top and Bottom 720p	50		•			•

Signal Type	Resolution	Frame rate (Hz)	VGA	HDMI	DVI	3G-SDI	HDBaseT	
Mandatory 3D	Top and Bottom 720p	60		•			•	
	Top and Bottom 1080p	24		•			•	
Frame sequential 3D	800x600	120		•			•	
	1024x768	120		•			•	
	1280x720	120		•			•	
SD-SDI	480i YCbCr422 10bit	59.94				•		
	576i YCbCr422 10bit	50				•		
HD-SDI	720p YCbCr422 10bit	50				•		
		59.94				•		
		60				•		
	1080i YCbCr422 10bit	50					•	
		59.94					•	
		60					•	
	1080p YCbCr422 10bit	23.98					•	
		24					•	
		25					•	
		29.97					•	
		30					•	
		30					•	
	1080sF YCbCr422 10bit	25					•	
		29.97					•	
		30					•	
3GA-SDI	1080p YCbCr422 10bit	50				•		
		59.94				•		
		60				•		
3GB-SDI	1080p YCbCr422 10bit With 352M Payload ID	50						
		59.94				•		
		60				•		

PIP/PBP compatibility

The following table details the PIP/PBP compatibility.

PIP/PBP Matrix	3G-SDI	VGA	DVI	HDMI1	HDMI2	HDBaseT RJ45-1	USB A	Mini USB	Ethernet RJ45-2
3G-SDI	-	-	-	•	•	•	•	•	•
VGA	-	-	-	•	•	•	•	•	•
DVI	-	-	-	•	•	•	•	•	•
HDMI1	•	•	•	-	-	-	-	-	-
HDMI2	•	•	•	-	-	-	-	-	-
HDBaseT RJ45-1	•	•	•	-	-	-	-	-	-
USB A	•	•	•	-	-	-	-	-	-
Mini USB	•	•	•	-	-	-	-	-	-
Ethernet RJ45-2	•	•	•	-	-	-	-	-	-

- Dot (•): PIP/PBP combinations are enabled.
- Dash (-): PIP/PBP combinations are disabled.

Key features

- HD 0.95" 1920 × 1080 resolution or WUXGA 0.96" 1920 × 1200 resolution
- Projection lens compatibility:
 - Horizontal offset ranges with full image size: +/-25%
 - Vertical offset ranges with full image size: +/-60% (WUXGA) and +/-70% (HD)

Measurements comply with industry standards where offset is calculated as a ratio of the number of pixels shifted up or down to full image size.
- 360 degree orientation
- 3D blending and auto warping
- Supports fog filter as an optional accessory
- Wireless desktop display using wireless dongle (optional)
- SNMP traps and email notifications
- 10-bit image processor electronics with modular design
- All video formats can be resized to full screen either horizontally or vertically while maintaining aspect ratio

- The projector can be operated using any of the following:
 - The built-in keypad, the infrared (IR) remote keypad, a wired remote keypad, a PC/ device using serial communications (Ethernet or RS232)
 - A web page using Ethernet or from a PC or device using a wireless USB dongle (optional)

List of components

This projector comes with all the items listed below. Check to make sure your package is complete. If anything is missing, contact your dealer.

- IR remote keypad (P/N: 003-004468-XX)
- Power cords supplied with the projector:
 - UK
 - North America (125V)
 - North America (250V)
 - Europe, Korea, and Russia
 - Japan
 - India
 - South Africa
 - Australia and New Zealand
 - Argentina

- User manual (CD)

Due to the difference in applications for each country, some regions may have different accessories.

The following accessories are available for the projector:

- 2.0-4.0:1 long zoom lens (P/N: 140-111104-XX)
- 4.0-7.2:1 long zoom lens (P/N: 140-116109-XX)
- 0.84-1.02:1 short zoom lens (P/N: 140-114107-XX)
- 1.02-1.36:1 short zoom lens (P/N: 140-115108-XX)
- 1.2-1.5:1 short zoom lens (P/N: 140-109101-XX)
- 1.5-2.0:1 short zoom lens (P/N: 140-110103-XX)



Warning! Failure to comply with the following could result in death or serious injury.

- Installing or replacing a lens must be done by a Christie qualified authorized trained service technicians or installers to avoid exposure to dangerous emission levels.

- 1DWUSB-BGN/wireless dongle (P/N: 133-113106-XX)
- H-Series adapter For E Series lenses (P/N: 140-112105-XX)
- Christie One Mount Plus (P/N: 140-117100-XX)

- One Mount extender rod (P/N: 121-125109-XX)
- One Mount Rigging kit (P/N: 121-126100-XX)
- Christie One rigging frame (P/N: 140-113106-XX)
- Fog filter with frame (P/N: 003-005714-XX)
- Fog filter module (003-005715-XX)

Physical specifications

Learn the dimensions and weight of the projector.

Description	Dimensions
Projector size	
Overall size (L x W x H) (excluding lens, feet)	677 mm (26.6 in) x 596 mm (23.5 in) x 203 mm (8.0 in)
Overall size, shipping without lens (L x W x H) (includes packaging)	923 mm (36.3 in) x 843 mm (22.2 in) x 513 mm (20.2 in)
Projector Weight	
Without lens	42.5 kg (93.7 lb)
Shipping without lens (includes packaging)	54.0 kg (119.0 lb)
Operating position	
360 degrees front to back and portrait capable	Free orientation and no tilt range constraint.

Physical operating environment

Provides specifications for the operating environment.

- Operating: 0°C to 40°C
 - 0 to 40 degrees C (0 to 2500 ft)
 - 0 to 35 degrees C (2500 to 5000 ft)
 - 0 to 30 degrees C (5000 to 10000 ft)
- Storage temperature range: -10°C to 60°C
- Humidity range: 10% to 85% RH (maximum), non condensing
- Storage humidity range: 5% to 90% RH (maximum), non condensing
- Operating altitude: 10,000 ft maximum

Power requirements

Learn the power requirements for the projector.

Parameter	Requirement
Rated voltage	
Input 1	100V-120V
Input 2	200V-240V
Rated current	
Input 1	14A
Input 2	7A
Line frequency	50/60Hz
AC input coupler	
Input 1	C20
Input 2	C14
Inrush current	80A max
Maximum power consumption	
Input 1	1500W
Input 2	1400W

Warnings

- If the condition of the power input is abnormal, the projector displays the following warning:

Incorrect AC power detected. The projector is running in reduced brightness mode (ECO 2). Ensure the proper power is being provided to the selected projector input.

The following table provides information about the power input behavior.

Condition	Input		Projector Behavior (Light Source Mode)
	AC Socket	Input Voltage	
Normal	110V	110V	Full (100% power)
Abnormal	110V	220V	ECO 2 (50% power); displays warning message
Normal	220V	220V	Full (100% power)
Abnormal	220V	110V	ECO 2 (50% power); displays warning message

- If the filter is installed incorrectly, the projector displays the following warning:

Filter is installed incorrectly. Power off the projector and check the filter installation.

- Pump is malfunctioning, for example the motor or pump has stopped operating. The projector displays one of the following warnings:

Pump 1 is not working as expected. Check pump functionality.

Pump 2 is not working as expected. Check pump functionality.

- If the end-user presses the source key on the IR remote keypad that is not supported, for example **BNC(2)**, the projector displays the following warning:

Not supported

Regulatory

This product conforms to the following regulations related to product safety, environmental requirements and electromagnetic compatibility (EMC).

Safety

- CSA C22.2 No. 60950-1
- UL 60950-1
- IEC 60950-1
- EN 60950-1

Laser safety

- IEC 60825-1
- IEC 62471
- FDA CDRH CFR 1040.10
- FDA CDRH CFR 1040.11

Electro-Magnetic Compatibility

Emissions

- FCC CFR47, Part 15, Subpart B/ANSI C63.4, Class A - Unintentional Radiators
- CISPR32/EN55032 Class A - Information Technology Equipment
- ICES/NMB003 (A) - Information Technology Equipment

Immunity

- CISPR 24/EN55024 EMC Requirements - Information Technology Equipment

Environmental

- The product conforms to:
 - EU Directive (2011/65/EU) on the restriction of the use of certain hazardous substances (RoHS) in electrical and electronic equipment and the applicable official amendment(s).
 - EU Regulation (EC) No. 1907/2006 on the registration, evaluation, authorization and restriction of chemicals (REACH) and the applicable official amendment(s).
 - EU Directive (2012/19/EU) on waste and electrical and electronic equipment (WEEE) and the applicable official amendment(s).
 - China Ministry of Information Industry Order No.39 (02/2006) on the control of pollution caused by electronic information products, the hazardous substances concentration limits (SJ/T11363-2006), and the applicable product marking requirement (SJ/T11364-2006).

Federal Communications Commission (FCC) warning

- Only use the supplied power cord.

On-screen display tree

The following table provides the on-screen display menu tree.

Level 1	Level 2	Level 3 (Or List)	Level 4 (Or List)	Level 5 (Or List)	Level 6 (Or List)	Default	
Size & Position	Size Presets	Auto				Auto	
		Native					
		4:3					
		Letterbox					
		Full Size					
		Full Width					
		Full Height					
		Custom					
		3D Mode					
	Overscan	Off				By source set	
		Zoom					
		Crop					
	Pixel Track	0 to 100				50	
	Pixel Phase	0 to 100				50	
	Horz Position	0 to 100				50	
	Vert Position	0 to 100				50	
	Digital Horz Zoom	50% to 400%				100	
	Digital Vert Zoom	50% to 400%				100	
	Digital Horz Shift	0 to 100				50	
	Digital Vert Shift	0 to 100				50	
	Geometry Correction	PC Mode		On/Off			Off
		Warp	Keystone		Horz Keystone	0 to 40	20
					Vert Keystone	0 to 40	20
Pincushion				Horz Pincushion	0 to 100	50	
				Vert Pincushion	0 to 100	50	

Level 1	Level 2	Level 3 (Or List)	Level 4 (Or List)	Level 5 (Or List)	Level 6 (Or List)	Default	
Size & Position	Geometry Correction	Warp	4-Corner	Top Left Horz Adjust	0 to 120 (pixel)	0	
				Top Left Vert Adjust	0 to 80 (pixel)	0	
				Top Right Horz Adjust	0 to 120 (pixel)	0	
				Top Right Vert Adjust	0 to 80 (pixel)	0	
				Bottom Left Horz Adjust	0 to 120 (pixel)	0	
				Bottom Left Vert Adjust	0 to 80 (pixel)	0	
				Bottom Right Horz Adjust	0 to 120 (pixel)	0	
				Bottom Right Vert Adjust	0 to 80 (pixel)	0	
			Auto Warp Filter	Off		On	
				On			
	Horz Filter	0 to 9					
	Vert Filter	0 to 9					
	Reset	Command					
	Auto Image	Normal				Wide	
		Wide					
Image settings	Brightness	0 to 100				50	
	Contrast	0 to 100				By source set	
	Color Space	Auto					Auto
		RGB	RGB Full				RGB Full
			RGB Limited				
	REC709						
YUV	REC709					REC709	
	REC601						

Level 1	Level 2	Level 3 (Or List)	Level 4 (Or List)	Level 5 (Or List)	Level 6 (Or List)	Default
Image settings	Detail	Maximum				By source set
		High				
		Normal				
		Low				
		Minimum				
	3D Display	3D Enable	Auto			Auto
			Frame Packing			
			Side by Side			
			Top and Bottom			
			Frame Sequential			
			Off			
		3D Invert	Off			Off
			On			
		Toggle 3D Blending	Enter key			N/A
		3D Sync Out	To Emitter			To Emitter
			To Next Projector			
		Frame Delay	1 ~ n (by timing, Max 200)			1
	Video Options	Color	0 to 100			50
		Tint	0 to 100			50
		Detect Film	Off			Off
	On					
	Input Levels	Red Gain	0 to 100			50
		Green Gain	0 to 100			50
		Blue Gain	0 to 100			50
		Red Offset	0 to 100			50
		Green Offset	0 to 100			50
		Blue Offset	0 to 100			50
		Sync Threshold	0 to 100			50
Reset RGB Gain/Offset		Command				

Level 1	Level 2	Level 3 (Or List)	Level 4 (Or List)	Level 5 (Or List)	Level 6 (Or List)	Default	
Image settings	Picture Settings	Presentation				By source set	
		Video					
		Bright					
		Enhanced					
		REC709					
		Real					
		DICOM SIM					
		2D High Speed					
		3D					
		Blending					
		User					
	Save to User	command					
	Contrast Enhancement	Off				Off	
		DynamicBlack™					
		RealBlack					
	Image Freeze	Off				Off	
		On					
	Advanced Image Settings	Gamma	Video				By source set
			Film				
			Bright				
			CRT				
			DICOM				
		White Peaking	0 to 100				By source set
		Color Temperature	Warmest				By source set
			Warm				
			Cool				
		Edge Enhancement	Off				Off
Normal							
Maximum							
Color Wheel Speed	2X				3X		
	3X						
Configuration	Language	SPEC define				English	
	Lens Settings	Focus	Command				
		Zoom	Command				

Level 1	Level 2	Level 3 (Or List)	Level 4 (Or List)	Level 5 (Or List)	Level 6 (Or List)	Default	
Configuration	Lens Settings	Lens Shift	Command				
		Lens Shift Memory	Apply Position	Record 1			
				Record 2			
				Record 3			
				Record 4			
				Record 5			
			Save Current Position	Record 1			
				Record 2			
				Record 3			
				Record 4			
				Record 5			
	Lock All Lens Motors	Allow				Allow	
		Locked					
	Lens Calibration	Command					
	Ceiling Mount	Off				Auto	
		On					
		Auto					
	Rear Projection	Off				Off	
		On					
	Menu Preferences	Menu Horz Offset	0 to 100				0
		Menu Vert Offset	0 to 100				0
		Show Messages	Off				On
			On				
		Menu Transparency	0 to 90				0
		Splash Screen Setup	Factory Logo				Factory Logo
			Blue				
Black							
PIN Protect	Command						
Change PIN	Command						

Level 1	Level 2	Level 3 (Or List)	Level 4 (Or List)	Level 5 (Or List)	Level 6 (Or List)	Default
Configuration	Power Management	Standby Mode	0.5W Mode			Communication Mode
			Communication Mode			
		AC Power On	Off			Off
			On			
		Auto Shutdown	Never			Never
			5 Mins			
			10 Mins			
			15 Mins			
			20 Mins			
			25 Mins			
			30 Mins			
		Sleep Timer	Off			Off
			2 Hrs			
			4 Hrs			
			6 Hrs			
		Cool Down	Instant Off			Instant Off
			1 Min			
			2 Min			
	High Altitude	Off			Off	
		On				
	IR Control	Top	Off		On	
			On			
		Front	Off		On	
			On			
		HDBaseT	Off		On	
			On			
	12V Trigger	Off			Off	
		On				
	Communications	LAN	DHCP			By set
			IP Address			
			Subnet Mask			
			Default Gateway			
MAC Address						

Level 1	Level 2	Level 3 (Or List)	Level 4 (Or List)	Level 5 (Or List)	Level 6 (Or List)	Default
Configuration	Communications	WLAN	Enable			By set
			Start IP			
			End IP			
			Subnet Mask			
			Default Gateway			
			MAC Address			
			SSID			
		Network	Projector Name			By set
			Show Network Messages			
			Restart Network			By set
			Network Factory Reset			
		Serial Port Baud Rate	2400			115200
			4800			
			9600			
			14400			
			19200			
			38400			
			57600			
			115200			
			1200			
		Serial Port Echo	Off			Off
On						
Serial Port Path	RS232			RS232		
	HDBaseT					
Projector Address	0 to 9			0		

Level 1	Level 2	Level 3 (Or List)	Level 4 (Or List)	Level 5 (Or List)	Level 6 (Or List)	Default
Configuration	Backlight Preferences	Keypad Backlight	Timeout 5 Secs			Timeout 5 Secs
			Timeout 10 Secs			
			Timeout 20 Secs			
			Timeout 30 Secs			
			Always On			
			Always Off			
		Status LED	Always On			Always On
			Always Off			
			Warnings/ Errors Only			
	Color Matching	Manual Adjustment	Enable	On		Off
				Off		
			Auto Test Pattern	On		On
				Off		
			Red Part of Red	0 to 1000		1000
			Green Part of Red	0 to 1000		0
			Blue Part of Red	0 to 1000		0
			Green Part of Green	0 to 1000		1000
			Red Part of Green	0 to 1000		0
			Blue Part of Green	0 to 1000		0
Blue Part of Blue	0 to 1000		1000			
Red Part of Blue	0 to 1000		0			
Green Part of Blue	0 to 1000		0			
Red Part of White	0 to 1000		1000			
Green Part of White	0 to 1000		1000			

Level 1	Level 2	Level 3 (Or List)	Level 4 (Or List)	Level 5 (Or List)	Level 6 (Or List)	Default	
Configuration	Color Matching	Manual Adjustment	Blue Part of White	0 to 1000		1000	
			Reset to Default	Yes			
		No					
		HSG Adjustment	HSG Enable	On			Off
				Off			
			Auto Test Pattern	On			On
				Off			
			Red	Hue	0 to 254	127	
				Saturation	0 to 254	127	
				Gain	0 to 254	127	
			Green	Hue	0 to 254	127	
				Saturation	0 to 254	127	
				Gain	0 to 254	127	
			Blue	Hue	0 to 254	127	
				Saturation	0 to 254	127	
				Gain	0 to 254	127	
			Cyan	Hue	0 to 254	127	
				Saturation	0 to 254	127	
				Gain	0 to 254	127	
			Magenta	Hue	0 to 254	127	
				Saturation	0 to 254	127	
				Gain	0 to 254	127	
			Yellow	Hue	0 to 254	127	
				Saturation	0 to 254	127	
				Gain	0 to 254	127	
			White Gain	Red	0 to 254	127	
				Green	0 to 254	127	
				Blue	0 to 254	127	
			Reset to Default	Yes			
				No			
			Color Enhance	Off		CE 1	
				CE 1			
				CE 2			

Level 1	Level 2	Level 3 (Or List)	Level 4 (Or List)	Level 5 (Or List)	Level 6 (Or List)	Default	
Configuration	Color Matching	Wall Color	White			White	
			Gray 130				
	Hot Key Settings	Blank Screen	Aspect Ratio				
			Freeze Screen				
			Projector Info				
			Overscan				
			Service	Projector Info	Model Name		
			Serial Number				
			Native Resolution				
			Firmware				
			Configuration				
			Boot Code				
			Standby Mode				
			Lens Lock Settings				
			Input Power Rating				
			Wheel Index				
			FactoryReset	Command			
			Test Pattern	Off			
				Grid			
				White			
				Black			
				Checkerboard			
				Color Bars			
				Red			
				Green			
				Blue			
				Yellow			
		Magenta					
		Cyan					
		Boresight					

Level 1	Level 2	Level 3 (Or List)	Level 4 (Or List)	Level 5 (Or List)	Level 6 (Or List)	Default	
Configuration	Service	Wheel Index (2X)	Phosphor Index	0 to 719			
			Filter Index	0 to 719			
		Wheel Index (3X)	Phosphor Index	0 to 719			
			Filter Index	0 to 719			
		Error Log	Show Log				
			Clear Log				
		Mode Adjustment					
		Laser Diode Info	LD1				Voltage/ Current/ Temperature
			LD2				Voltage/ Current/ Temperature
			LD3				Voltage/ Current/ Temperature
			LD4				Voltage/ Current/ Temperature
			LD5				Voltage/ Current/ Temperature
			LD6				Voltage/ Current/ Temperature
			LD7				Voltage/ Current/ Temperature
			LD8				Voltage/ Current/ Temperature
			LD9				Voltage/ Current/ Temperature
LD10					Voltage/ Current/ Temperature		
LD11				Voltage/ Current/ Temperature			

Level 1	Level 2	Level 3 (Or List)	Level 4 (Or List)	Level 5 (Or List)	Level 6 (Or List)	Default
Configuration	Service	Laser Diode Info	LD12			Voltage/ Current/ Temperature
			LD13			Voltage/ Current/ Temperature
		ADC Calibration	Calibration Condition			
			ADC Calibration			
		Light Sensor	Light Sensor Info			
			Calibration			
Light Source	Light Source Mode	Constant Power				Constant Power
		Constant Intensity				
		ECO 1 (80%)				
		ECO 2 (50%)				
		Rental Mode (90%)				
	Constant Power	0 to 99 (30% to 100%)				99
	Light Source Info	Total Projector Hours				
		LD Hours				
	Light Sensor Calibration	Default				Default
		Auto				
Manual						
Status	Model Name					
	Serial Number					
	Native Resolution					
	Firmware					Vxx, Ayy, Bzz
	Main Input					
	Main Signal Format					
	Main Pixel Clock					
	Main Sync Type					

Level 1	Level 2	Level 3 (Or List)	Level 4 (Or List)	Level 5 (Or List)	Level 6 (Or List)	Default
Status	Main Horz Refresh					
	Main Vert Refresh					
	PIP/PBP Input					
	PIP/PBP Signal Format					
	PIP/PBP Pixel Clock					
	PIP/PBP Sync Type					
	PIP/PBP Horz Refresh					
	PIP/PBP Vert Refresh					
	Light Source Power					
	Total Projector Hours					
	Light Source Hours					BLD/RLD
	LC Hours					
	Standby Mode					
	Lens Lock Settings					
	IP Address					
	DHCP					
System Temperature						
Input Switching & PIP	Main Input	SPEC define				
	PIP/PBP Input	SPEC define				
	PIP/PBP Enable	Off				Off
		On				
	Swap					
Size	(Small/Medium/Large)					

Level 1	Level 2	Level 3 (Or List)	Level 4 (Or List)	Level 5 (Or List)	Level 6 (Or List)	Default
Input Switching & PIP	Main Layout	(PBP, Main Left/ PBP, Main Top/ PBP, Main Right/ PBP, Main Bottom/PIP- Bottom Right/ PIP-Bottom Left/ PIP-Top Left/ PIP-Top Right)				
	Timing Detection Mode	Normal				Wide
		Wide				
	Source Info	Active Source				
		Signal Format				
		Aspect Ratio				
		Resolution				
		Vert Refresh				
		Horz Refresh				
		Pixel Clock				
		Sync Type				
		Color Space				
		PIP/PBP (When PIP/PBP active)				
	<PIP/PBP source lines> (When PIP/PBP active)					
	Input key	Change Sources				Auto Source
		List All Sources				
		Auto Source				
Blank on Signal Switch	Off				Off	
	On					
Language	SPEC define					English
Test pattern	Off					
	Grid					
	White					
	Black					
	Checkerboard					
	Color Bars					

Corporate offices

USA – Cypress
ph: 714-236-8610

Canada – Kitchener
ph: 519-744-8005

Consultant offices

Italy
ph: +39 (0) 2 9902 1161

Worldwide offices

Australia
ph: +61 (0) 7 3624 4888

Brazil
ph: +55 (11) 2548 4753

China (Beijing)
ph: +86 10 6561 0240

China (Shanghai)
ph: +86 21 6278 7708

Eastern Europe and
Russian Federation
ph: +36 (0) 1 47 48 100

France
ph: +33 (0) 1 41 21 44 04

Germany
ph: +49 2161 664540

India
ph: +91 (080) 6708 9999

Japan
ph: 81-3-3599-7481

Korea (Seoul)
ph: +82 2 702 1601

Republic of South Africa
ph: +27 (0)11 510 0094

Singapore
ph: +65 6877-8737

Spain
ph: + 34 91 633 9990

United Arab Emirates
ph: +971 4 3206688

United Kingdom
ph: +44 118 977 8000



For the most current technical documentation,
please visit www.christiedigital.com

CHRISTIE®