



## USE AND MAINTENANCE



**S1500 - S4500**

Gas Analyzer

**Seitron Americas Inc. - ALL RIGHTS RESERVED -**  
**Total or partial reproduction of this document by any means (including photocopying or storage on any electronic medium) and transmittal of same to third parties in any manner, even electronically, is strictly prohibited unless explicitly authorized in writing by Seitron Americas Inc.**

<b>1.0</b>	<b>IMPORTANT INFORMATION</b>	<b>07</b>
1.1	Information about this manual	07
1.2	Safety warnings	07
<b>2.0</b>	<b>SAFETY</b>	<b>08</b>
2.1	Intended use of the product	08
2.2	Improper use of the product	08
<b>3.0</b>	<b>WORKING PRINCIPLE</b>	<b>09</b>
3.1	Working principle	09
3.2	Measuring sensors	09
<b>4.0</b>	<b>DESCRIPTION OF THE PRODUCT</b>	<b>10</b>
4.1	General Description of the Combustion Analyzer	10
4.2	General Characteristics of the Combustion Analyzer	10
4.3	Description of the Components of the Combustion Analyzer	12
4.3.1	Keypad	13
4.3.2	Display	13
4.3.3	Printer	14
4.3.4	B-Type USB connector	14
4.3.5	Serial connector (Mini Din 8 poles)	14
4.3.6	Pneumatic connector inputs / TC-K	14
<b>5.0</b>	<b>MAIN CONFIGURATIONS</b>	<b>15</b>
<b>6.0</b>	<b>TECHNICAL SPECIFICATIONS</b>	<b>16</b>
6.1	Technical specifications	16
6.2	Measurement and Accuracy Ranges	17
<b>7.0</b>	<b>STARTUP</b>	<b>18</b>
7.1	Preliminary operations	18
7.2	Warnings	18
7.3	Power supply of the Analyzer	18
7.3.1	Checking and replacing the batteries	18
7.3.2	Use with external power pack	19
7.4	QR code generation	19
7.5	Connection diagram	20
7.5.1	Gas Sampling Probe	21
7.5.2	Smoke sampling probe for average CO measurement	21
7.5.3	Condensate trap and fine dust filter	22
7.5.4	Connecting the gas sampling probe (Standard / average CO) and water trap assembly	22
7.5.5	Connecting the TcK probe	22
7.5.6	Combustion air temperature probe	23
7.5.7	Connection of combustion air temperature probe	23
7.5.8	Burner pressure verification probe (available soon)	23
7.5.9	Ionisation current measuring probe	23
7.5.10	Ambient CO measurement probe	23
7.5.11	Gas probe for industrial engines	23
7.5.12	Measurement of differential pressure	23
7.5.13	Connection to PC	23
7.5.14	Connection to battery charger	24
7.5.15	NOx measurement	24

<b>8.0</b>	<b>POWER ON - OFF</b>	<b>25</b>
8.1	Starting the device	25
<b>9.0</b>	<b>CONFIGURATION</b>	<b>26</b>
9.1	Configuration Menu	26
9.2	Analysis Menu	27
9.2.1	Configuration=>Analysis=>Fuel	28
9.2.2	Configuration=>Analysis=>Condensation	29
9.2.3	Configuration=>Analysis=>O <sub>2</sub> reference	30
9.2.4	Configuration=>Analysis=>NO <sub>x</sub> /NO ratio	31
9.2.5	Configuration=>Analysis=>Measurement units	32
9.2.6	Configuration=>Analysis=>Autozero	33
9.2.7	Configuration=>Analysis=>Measures list	34
9.2.8	Configuration=>Analysis=>Air temperature	36
9.3	Instrument Menu	37
9.3.1	Configuration=>Instrument=>Bluetooth	38
9.3.2	Configuration=>Instrument=>Time/Date	39
9.3.3	Configuration=>Instrument=>Brightness	40
9.3.4	Configuration=>Instrument=>Pump	41
9.3.5	Configuration=>Instrument=>CO dilutor	42
9.3.6	Configuration=>Instrument=>Micromanometer	43
9.4	Configuration=>Operator	44
9.5	Configuration=>Alarm	46
9.6	Information Menu	48
9.6.1	Configuration=>Information=>Battery	49
9.6.2	Configuration=>Information=>Sensors	50
9.6.3	Configuration=>Information=>InfoService	51
9.6.4	Configuration=>Information=>Reminder	52
9.6.5	Configuration=>Information=>Probes	53
9.7	Configuration=>Diagnostic	54
9.7.1	Configuration=>Diagnostic=>Sensors	55
9.7.2	Configuration=>Diagnostic=>Gas probe	56
9.7.3	Configuration=>Diagnostic=>Memory	57
9.7.4	Configuration=>Diagnostic=>Pump	58
9.7.5	Configuration=>Diagnostic=>Cal. on site	59
9.7.6	Calibration procedure	60
9.8	Configuration=>Language	67
9.9	Configuration=>Restore	68
<b>10.0</b>	<b>MEMORY</b>	<b>69</b>
10.1	Memory Menu	69
10.1.1	Memory Organization	71
10.2	Memory=>Save	72
10.3	Memory=>Average	74
10.4	Memory=>Select	75
10.4.1	Memory=>Memory recall	76
10.5	Memory=>Data logger	79
10.6	Memory=>Delete	80
10.6.1	Memory=>Delete=>Single	81
10.6.2	Memory=>Delete=>All	82
10.7	Memory=>Usage	83
<b>11.0</b>	<b>PRINT</b>	<b>84</b>
11.1	Print Menu	84

11.2	Print=>Report	85
11.3	Print=>Configuration	86
11.4	Print=>Test	88
11.5	Print=>Header	88
11.6	Print=>Printer	90
11.6.1	Print=>Printer=>Pairing	91
11.7	Print=>Measures list	93

## **12.0 MEASUREMENTS 95**

12.1	Measurements Menu	95
12.2	Measurements=>Draft	97
12.3	Measurements=>Smoke	98
12.3.1	Smoke pump operative manual	99
12.4	Measurements=>Ambient CO	101
12.5	Measurements=>Temperature	102
12.6	Measurements=>Pressure	103
12.7	Measurements=>Leak detector	104
12.7.1	Connecting the probe for gas leak	104
12.7.2	Performing the test	104
12.8	Measurements=>AUX measurements	105
12.9	Measurements=>Velocity	106
12.9.1	How to connect the Pitot tube to the instrument	107
12.9.2	Test execution	108
12.10	Measurements=>Power of burner	109
12.10.1	Testing in 'Manual' mode	110
12.10.2	Testing in 'Measure' mode (based on Flow rate)	111
12.10.3	Testing in 'Measure' mode (based on meter)	112
12.11	Measurements=>Ionization Current	114
12.12	Measurements=>Ventilation	115

## **13.0 COMBUSTION ANALYSIS 118**

13.1	Combustion Analysis	118
13.1.1	Startup and e auto-calibration of the device	118
13.1.2	Inserting the probe in the chimney	118
13.1.3	Simultaneous measurement of pressure, O <sub>2</sub> , pollutants	119
13.1.4	Combustion Analysis	120
13.1.5	End of Analysis	120
13.2	Combustion Analysis - Preliminary operations	121
13.3	Combustion Analysis - Manual mode	123
13.4	Combustion Analysis - Data logger mode	125

## **14.0 SENSORS 127**

14.1	Sensors arrangement	127
14.2	Sensor types and relevant positioning	127
14.3	Gas sensors life	128
14.4	Gas sensors life table	128
14.5	Expandability to 4 sensors	129
14.6	CxHy sensor for measurement of the unburnt hydrocarbons	130
14.6.1	Installing the CxHy sensor	130
14.7	CO <sub>2</sub> sensor for Carbon Dioxide measurement in combustion processes	131
14.7.1	Installing the CO <sub>2</sub> sensor	131
14.8	Sensor for combustible gas leaks	132
14.8.1	Installation of the sensor for combustible gas leaks	132
14.8.2	Performing the test	132

<b>15.0 MAINTENANCE</b>	<b>133</b>
15.1 Routine maintenance	133
15.2 Preventive maintenance	133
15.3 Cleaning the sample probe	133
15.4 Maintaining the water trap / filter unit	134
15.5 Replacing the particulate filter	134
15.6 Replacing the gas sensors	134
15.7 Replacing the battery pack	138
15.8 Replacing the printer paper roll	139
15.9 Firmware update	140
<b>16.0 TROUBLESHOOTING</b>	<b>141</b>
16.1 Troubleshooting guide	141
<b>17.0 SPARE PARTS AND SERVICING</b>	<b>143</b>
17.1 Spare parts	143
17.2 Accessories	144
17.3 Service Centers	145
<b>ANNEX A - Data Management with “SEITRON SMART ANALYSIS” app</b>	<b>146</b>
<b>ANNEX B - Analysis report examples</b>	<b>148</b>
<b>ANNEX C - Coefficients of the fuels and Formulas</b>	<b>151</b>
<b>ANNEX D - Optional measures list</b>	<b>153</b>
<b>WARRANTY CERTIFICATE</b>	<b>155</b>

## 1.1 Information about this manual

- This manual describes the operation and the characteristics and the maintenance of the Combustion Analyzer S1500/S4500.
- Read this operation and maintenance manual before using the device. The operator must be familiar with the manual and follow the instructions carefully.
- This use and maintenance manual is *subject to change due to technical improvements - the manufacturer assumes no responsibility for any mistakes or misprints.*



**Respect your environment: think before printing the full manual on paper.**

## 1.2 Danger levels and other symbols



The magnets in the back of the instrument can damage credit cards, hard driver, mechanical watches, pacemakers, defibrillators and other devices proven sensitive to magnetic fields. It is recommended to keep the instrument at a distance of at least 25cm away from these devices.

Symbol	Meaning	Comments
	WARNING	<b>Read information carefully and prepare safety appropriate action!</b> To prevent any danger from personnel or other goods. Disobey of this manual may cause danger to personnel, the plant or the environment and may lead to liability loss.
	Information on LCD	
	Ensure correct disposal	Dispose of the battery pack at the end of its working life only at the dedicated collecting bin.  The customer takes care, on his own costs, that at the end of its working life the product is collected separately and it gets correctly recycled.
	Keyboard with preformed keys with main control functions.	

## 2.1 Intended purpose

**This chapter describes the areas of application for which the S1500/S4500 is intended.**

Using the S1500/S4500 in other application areas is on the risk of the operator and the manufacturer assumes no responsibility and liability for loss, damage or costs which could be a result. It is mandatory to read and pay attention to the operating/maintenance manual.

All products of the series S1500/S4500 are handheld measuring devices in professional flue gas analysis for:

- Small furnaces (burning oil, gas, wood, coal)
- Low-temperature and condensing boilers
- Gas heaters

Due to other configuration with electrochemical sensors it is possible to use the measuring instrument in following application area:

- Service engineers/mechanics of burner/boiler manufacturers
- Service industrial combustion plants

Additional functions of the measuring instrument:

- Flue gas analysis according 1. BImSchV or qA-mean value (selectable)
- Calculating of stack heat loss and efficiency
- CO- and NO environment measurement
- Store Smoke value, calculating mean value
- Measuring differential pressure
- Draft measurement

## 2.2 Improper use of the product

The use of S1500/S4500 in application areas other than those specified in Section 2.1 "Intended use of the product" is to be considered at the operator's risk and the manufacturer assumes no responsibility for the loss damage or costs that may result. It is compulsory to read and pay attention to the instructions in this use and maintenance manual.

S1500/S4500 should not be used:

- For continuous measurements > 1h
- As safety alarm instrument



## 3.0 WORKING PRINCIPLE

### 3.1 Working principle

The gas sample is taken in through the gas probe, by a diaphragm suction pump inside the instrument.

The measuring probe has a sliding cone that allows the probe to be inserted in holes with a diameter of 0.4 to 0.6 inches (11 mm to 16 mm) and to adjust the immersion depth: **the gas picking point must be roughly in the center of the flue section.**

The gas sample is cleaned of humidity and impurities by a condensate trap and filter positioned along the rubber hose that connects the probe to the analyzer.

The gas is then analyzed in its components by electrochemical and infrared sensors.

The electrochemical sensor guarantees high precision results in a time interval of up to about 60 minutes during which the instrument can be considered very stable. When measurement is going to take a long time, we suggest auto-zeroing the instrument again and flushing the inside of the pneumatic circuit for three minutes with clean air.

During the zero calibrating phase, the instrument aspirates clean air from the environment and detects the sensor drifts from zero (20.95% for the O<sub>2</sub> sensor), then compares them with the programmed values and compensates them. The pressure sensor autozero must, in all cases, be done manually prior to measuring pressure.

The values measured and calculated by the microprocessor are viewed on the LCD display which is backlit to ensure easy reading even when lighting is poor.

### 3.2 Measurement sensors

Oxygen (%O<sub>2</sub>) is measured with an electrochemical sensor that acts like a battery which, over time, is apt to lose sensitivity.

The toxic gases (CO, SO<sub>2</sub>, NO, NO<sub>2</sub>) are measured with electrochemical sensors that are not subject to natural deterioration being intrinsically lacking of oxidation processes.

The measurement sensors are electrochemical sensors made up of an anode, a cathode, and an electrolytic solution, which depends on the type of gas to be analyzed. The gas penetrates the sensor through a selective diffusion membrane and generates an electric current proportional to the absorbed gas.

Such current is measured, digitalized, temperature-compensated, processed by the microprocessor, and displayed.

The gas shall not be at a pressure such to damage or destroy sensors. The maximum estimated allowed pressure is ±100mbar gage.

The response times of the measurement sensors used in the analyzer are:

O <sub>2</sub>	=	20 sec. at 90% of the measured value
CO(H <sub>2</sub> )	=	50 sec. at 90% of the measured value
CO	=	50 sec. at 90% of the measured value
NO	=	40 sec. at 90% of the measured value
NO <sub>2</sub>	=	50 sec. at 90% of the measured value
SO <sub>2</sub>	=	50 sec. at 90% of the measured value

It is therefore suggested to wait 5 minutes (anyway not less than 3 minutes) in order to get reliable analysis data.

If sensors of poison gases are submitted to concentrations higher than 50% of their measurement range for more than 10 minutes continuously, they can show up to ±2% drift as well as a longer time to return to zero. In this case, before turning off the analyzer, it is advisable to wait for the measured value be lower than 20ppm by in taking clean air. If there is an automatic calibration solenoid, the device performs an automatic cleaning cycle and it turns off when the sensors return to a value close to zero.

The CO sensor can be protected from high gas concentrations through the dilution function which allows for a wider measurement range of the sensor without overcharging the sensor itself.

The dilution function allows the CO sensor to always be efficient and ready to respond even in the case of very high concentrations of CO.

## 4.1 General Description of the Combustion Analyzer

The design of the handheld combustion analyzer "S1500/S4500" is clean and ergonomic with an extremely clear and user-friendly keypad.

"S1500/S4500" immediately suggests just how even the most sophisticated engineering can give life to an incredibly comfortable and easy to use work instrument.

Devised to analyze flue gases, monitor the pollutants emitted and measure environmental parameters, "S1500/S4500" uses two electrochemical sensors that provide the oxygen and carbon monoxide values while a third sensor is used to measure the pollutants NO and NO<sub>x</sub>.

The most complete version can house a fourth sensor for measuring NO<sub>2</sub>, SO<sub>2</sub> and C<sub>x</sub>H<sub>y</sub>. CO, NO, NO<sub>2</sub> and SO<sub>2</sub> measuring sensors are also available with a reduced measuring range, with a resolution of 0.1 ppm and better accuracy.

Two external sensors measure the environmental parameters; it is also possible to measure flue draft and carbon black and, with the measuring range of up to 200mbar, system pressure and pressure in the combustion chamber can be measured and the pressure switches checked.

Intended for eleven main types of combustibles amongst which natural gas, LPG, diesel and fuel oil, it is also possible to insert into the memory of "S1500/S4500" another 16 combustibles of which the chemical composition is known. The functions of "S1500/S4500" include the storage and the average of the data acquired, the printing (on a roll of thermal polyester paper) of the results and the possibility of connecting the device to a computer to store to data via USB connection.

Its memory is able to store 1000 complete analyses and using the dedicated SW and mini-USB serial communication cable it is possible to download the data to a PC. It is also interesting to know that "S1500/S4500" is equipped with a single "Li-Ion" rechargeable battery pack used both to power the unit and for the printer: it also has a bright and wide (2,17 x 3,74 inches) TFT color display that has an excellent readability also thanks to the zoom function and the backlight.

Another characteristic that distinguishes it from other similar products in the market is the fact the power supply that comes with the product can carry out the dual function of battery charger and power supply for the instrument which means the user can carry out analyses even if the batteries are completely flat.

Another important function is the possibility of carrying out an autozero cycle with the probe inside the stack, exploiting a sophisticated flow deviation system.

As for maintenance, it is useful to know that the sensors can be replaced by the user himself without having to send the device to a service center because the sensors are pre-calibrated; it will however be necessary to get the device calibrated at least once a year.

Also:

- **Operator interface:** user-friendly - so much so that it can be used without the instruction manual.
- **Wide and bright TFT color display:** great readability thanks to the Zoom function and to an efficient backlight.
- **Integrated thermal printer:** with thermal polyester paper or thermal paper you get maximum readability and durability and heat resistance.
- **One battery pack:** rechargeable for powering the instrument and the printer, indicating the charge level and is accessible from outside.
- **Pneumatic input connectors (gas and pressure/draft) staying inside the profile of the instrument:** for greater resistance to knocks.
- **Precalibrated sensors, directly replaceable by the user.**

## 4.2 General features of the Flue Gas Analyzer

The portable analyzer S1500/S4500 has been carefully designed in accordance with regulatory requirements and the specific needs of the customers.

The device contains a single board with all the basic operating circuits, pre-calibrated measuring sensors, a gas extraction pump, a solenoid valve, a dilution pump, a membrane keyboard, a TFT backlit graphic display, a high-capacity "Li-Ion" rechargeable battery pack and an integrated thermal printer. The two halves of the casing are securely fastened together with seven screws on the back of the device.

The pneumatic circuit and the measuring sensors with electronic module are positioned in the back of the casing and they are accessible, for rapid maintenance and replacement, by removing the magnet cover in the lower part of the device. The roll of paper is located at the top, above the display, and it can be replaced easily by removing the pressure-locked door. On the bottom part of the analyzer are the pneumatic connectors for gas sampling and for the measurement of the pressure/draft: the T1 connector to connect the gas probe thermocouple plug and the T2 connector to connect the combustion air probe thermocouple plug. On the right side of the device are the B-type USB connector for the connection of the external power source or of the PC and the 8-pole mini DIN connector for the serial interface or for an external probe (optional).

The user interface includes a TFT graphic display with back light always active and a membrane keyboard. The menu screens and all the operator messages can be set in the desired language.

The use of the analyzer is simplified by the symbol keys with direct access to the most important functions. Navigation through the various menu screens is easy and intuitive.

## Gas extraction pump

The sample pump located inside the instrument is a DC-motor-driven diaphragm pump, powered by the instrument, and is such as to obtain optimal flow of the sampled gas being analyzed; an internal sensor that measures the flow allows to:

- Keep the flow rate of the pump constant
- Check the efficiency of the pump
- Check the degree of clogging of the filters

## Simultaneous measurement of pressures, O<sub>2</sub>, pollutants

The instrument, to obtain boiler's perfect combustion parameters, allows to measure simultaneously the input and output pressure of the gas valve, the level of O<sub>2</sub>, the levels of pollutants and all the calculated parameters needed to obtain the correct value of yield.

[See section 13.1.3.](#)

## Measurement sensors

The instrument uses pre-calibrated gas sensors of the long-lasting FLEX-Sensor series for measuring oxygen (O<sub>2</sub>), carbon monoxide CO (compensated in hydrogen H<sub>2</sub>), nitrogen oxide (NO), nitrogen dioxide (NO<sub>2</sub>) and Sulphur dioxide (SO<sub>2</sub>). An automatic internal device dilutes the concentration of CO when the instrument measures high concentrations. The diluting system also allows the CO sensor measuring range to be extended up to 100.000 ppm (for full scale 8,000ppm sensor). The valve for the optional automatic fast autozero lets the operator turn the instrument on with the probe inserted in the flue. Up to 4 alarms can be programmed with visual and acoustic warning for the same number of measuring parameters.

The measuring sensors are the electrochemical type.

When the sensors are flat they can be replaced easily by the user without having to send the instrument away and without complicated calibration procedures requiring sample mixtures as they are supplied already calibrated.

Seitron Americas does, however, certify measurement accuracy only when a calibration certificate has been issued by its own laboratory or by an authorized laboratory.

## Pressure sensor

The device is internally provided with a piezoresistive differential pressure sensor to measure the draft (depression) of the chimney, for the tightness test of the piping and possible for other measurements (gas pressure in the network, loss of pressure through filters, etc.).

## Fuel types

The device is provided with the technical data of the most common types of fuels stored in its memory. By using the PC configuration program, available as an optional, it is possible to add combustibles and their coefficients in order to define up to a maximum of 16 combustibles, other than the default ones.

For more details see [Annex C](#).

## Smoke measurements

It is possible to enter the smoke values measured according to the Bacharach scale. The instrument will calculate the average and print the results in the analysis report.

An external pump, available as an optional, must be used to effect this measurement.

## Calibration certificate

The device comes with a calibration certificate compliant with standard ISO/IEC 17025.

## Electromagnetic compatibility

The instrument was designed to comply with Council Directive 2014/30/EC governing electromagnetic compatibility. Seitron Americas declaration of conformity may be found in Annex E.

### 4.3 Overview of Flue Gas Analyzer Components

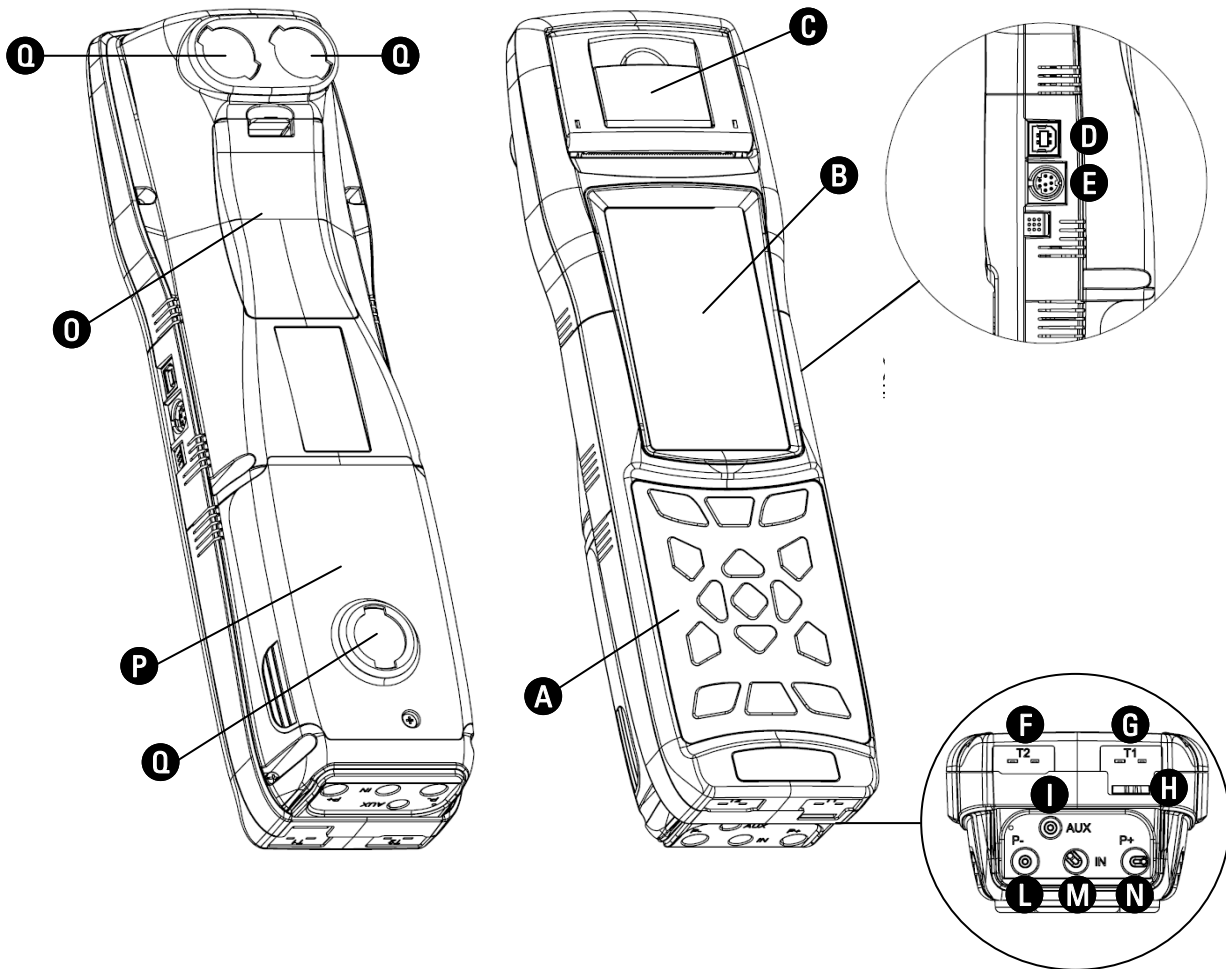

#### LEGEND

- A** Keypad
- B** Display
- C** Cover for access to the printer to replace the roll of paper
- D** B-type USB connector to connect the device to the power source or to a PC
- E** Serial cable connector for connection with accessory probes
- F** T2 - Tc-K female connector to connect combustion air temperature probe
- G** T1 - Tc-K female connector to connect gas probe
- H** Gas output
- I** AUX connector (input for optional external probes)
- L** P connector- (negative input to measure draft)
- M** IN connector (gas exhaust probe input by means of a complete condensate separator unit)
- N** P+ connector (positive input to measure differential pressure)
- O** Cover to access battery compartment
- P** Cover to access sensor compartment
- Q** Magnets

### 4.3.1 Keypad

Adhesive polyester keypad with preformed keys featuring main control functions:

KEYS	FUNCTION
	Activates the context keys shown on the display
	Access to the Memory menu
	Access to the Printing menu
	Access to the Configuration menu
	Performs the analysis of the combustion
	Access to the Measurements menu

KEYS	FUNCTION
	Turns the device On/Off
	Exits the current screen
	Select and/or Modify
	Confirm settings
	Backlight turn-off.

### 4.3.2 Display

01/01/13 00:10 — Date, time and battery status.

Combustion analysis — Selected menu.

Text 01  
Text 02  
Text 03  
Text 04  
Text 05  
Text 06  
Text 07

15/01/14 10:00 — Selected menu.

Combustion analysis — Parameters relative to the selected menu.

O<sub>2</sub> % 4.2  
CO<sub>2</sub> % 9.3  
Efficiency 1.25  
T flue °C 190.1  
T air °C 15.4  
ΔT °C 74.7  
E % 8.6  
LHV % 91.4



◀ OK ▶ — Context keys. In the various menus the functions vary depending on the type of operation being carried out.

TFT 272 x 480 pixel backlit colour display with 21 characters available and 8 lines. Allows the user to view the measured parameters in the most comfortable format; a Zoom function displays the measured values in magnified form.

**CAUTION:**

If the instrument is exposed to extremely high or extremely low temperatures, the quality of the display may be temporarily impaired. Display appearance may be improved by acting on the contrast key.

### Backlight

The backlight can be turned off with the simultaneous pressure on keys  +  .  
The backlight is turned on when any key is pressed, except '  ' key.

### 4.3.3 Printer

Thermal on thermal polyester or thermal paper. Thermal polyester cannot be altered and it is resistant to light, to temperature, to humidity and to water.

The print menu is accessed by pressing the relative key and, besides enabling read-out printing, the menu also allows you to modify print settings and to advance the paper manually so as to facilitate paper roll replacement.

### 4.3.4 B-Type USB connector

Connector to connect the device to a personal computer or to the battery charger.

The device comes with a feeder with output 5V  $\overline{=}$  , 2A to charge the internal batteries. In **D** (section 4.3) you can see the socket to connect the battery charger to the device. Once it has started charging, the display turns on and the charging state is displayed.

### 4.3.5 Serial connector (Mini Din 8-pole)

In **E** (section 4.3) we find the socket of the serial cable for connecting the instrument to an external probe, for example, to the draft gauge (optional), or to the ionisation current probe (optional).

### 4.3.6 Pneumatic connector inputs / TC-K

Pneumatic connector "A": input for the connection of the branch of the gas sampling probe with the condensation separating and anti-dust filter assembly.

Pneumatic connector "P-": negative input (P-) to be used in case of differential pressure measurements together with P+ input.

Pneumatic connector "P+": positive input (P+) to be used to measure the pressure in general. It must be connected to the second branch of the gas sampling probe in order to measure the draft and analyze combustion at the same time.

**WARNING: the inputs "P+" and "P-" are respectively the positive and the negative inputs of the internal differential pressure sensor, therefore they are used simultaneously to measure the differential pressure.**

Female connector TC-K "T1": input for the connection of the male TC-K connector of the gas sampling probe.

Female connector TC-K "T2": input for the connection of the male TC-K connector of the combustion air temperature probe.

# 5.0 MAIN CONFIGURATIONS

	S1500-P	S4500-2	S4500-3-Low	S4500-3	S4500-N-Low	S4500-C	S4500-N	S4500-S	S4500-S-Low
O2 SENSOR	✓	✓	✓	✓	✓	✓	✓	✓	✓
CO+H2 SENSOR	✓	✓	✓	✓	✓	✓	✓	✓	✓
NO SENSOR				✓			✓	✓	
NO SENSOR LOW RANGE			✓		✓	✓			✓
NO2 SENSOR							✓		
NO2 SENSOR LOW RANGE					✓				
CxHy SENSOR						✓			
SO2 SENSOR								✓	
SO2 SENSOR LOW RANGE									✓
NOT EXPANDABLE	✓								
EXPANDABLE TO 4 SENSORS		✓	✓	✓	✓	✓	✓	✓	✓
AUTOMATIC AUTOZERO	✓	✓	✓	✓	✓	✓	✓	✓	✓
CO DILUTION	✓	✓	✓	✓	✓	✓	✓	✓	✓
BLUETOOTH	✓	✓	✓	✓	✓	✓	✓	✓	✓
DRAFT MEASUREMENT	✓	✓	✓	✓	✓	✓	✓	✓	✓
CALIBRATION CERTIFICATE	✓	✓	✓	✓	✓	✓	✓	✓	✓
QUICK GUIDE	✓	✓	✓	✓	✓	✓	✓	✓	✓
GAS SAMPLE PROBE 300mm	✓	✓	✓	✓	✓	✓	✓	✓	✓
COMBUSTION AIR TEMPERATURE PROBE	OPTION	OPTION	OPTION	OPTION	OPTION	OPTION	OPTION	OPTION	OPTION
CONDENSATE TRAP	✓	✓	✓	✓	✓	✓	✓	✓	✓
PRESSURE MEASURING KIT	✓	OPTION	OPTION	OPTION	OPTION	OPTION	OPTION	OPTION	OPTION
BATTERY CHARGER	✓	✓	✓	✓	✓	✓	✓	✓	✓
US PLUG FOR BATTERY CHARGER	✓	✓	✓	✓	✓	✓	✓	✓	✓
PC SOFTWARE	✓	✓	✓	✓	✓	✓	✓	✓	✓
HARD CASE	✓	✓	✓	✓	✓	✓	✓	✓	✓
ROLL OF PAPER PRINTER	✓	✓	✓	✓	✓	✓	✓	✓	✓

## 6.1 Technical Specifications

Autozero:	Automatic autozero cycle.
Dilution (where provided):	Expansion system of the CO sensor measuring range up to 100.000ppm (10.00%) programmable as a simple protection of the CO sensor with triggering threshold programmable by the user. Preset triggering threshold at 1500 ppm.
Gas measurement sensors:	Up to 4 configurable sensors: electrochemical, NDIR and pellistor
Self-diagnosis:	All the functions and internal functions are checked and anomalies signaled.
Temperature measurement:	Double K thermocouple input with mini connector (ASTM E 1684-96 ) to measure differential temperature (supply and return)
Measurement of ambient temp.:	Via internal sensor or T2 thermocouple input with remote probe.
Type of combustible:	12 predefined by the factory and 16 that can be programmed by the user.
Power:	Li-Ion battery pack with internal protection circuit.
Battery charger:	External 5Vdc 2A battery charger with female A-type USB connector + connection to the device with the same serial communication cable supplied.
Charging time:	5 hours to charge from 0% to 90% (6 hours for 100%). The device can also be charged by connecting it to the PC, the device must be turned off, the charging time depends on the output current from the PC and may be more than 12 hours.
Instrument working time:	12 hours of non-stop operation (excluding printing).
Printer:	Thermal integrated with easy loading paper and sensor for the presence of paper
Printer powered:	By the analyzer batteries.
Printer autonomy:	Up to 40 analysis reports with the batteries fully charged.
Internal data memory:	1000 complete data analyses, time and name of the customer can be stored.
User data:	8 programmable user names.
Print-out heading:	4 lines x 24 characters, customizable by the user.
Display:	Graphic 272 x 480 pixels, backlit, color TFT 4.3".
Communication port:	USB with B-type connector.
Bluetooth (where provided):	Class 1 / Communication distance: <100 meters (in open range).
Line filter:	With replaceable cartridge, 99% efficient with 20um particles.
Suction pump:	1.0 l/min heads at the flue up to 135mbar.
Measurement of flow:	Internal sensor to measure the flow of the pump.
Condensate trap:	Outside the instrument.
Carbon black:	Using an external hand pump; it is possible to enter and print the smoke index.
Leak test:	Gas pipes tested for leaks with separate printout of the result, by means of the attachment AACKT02.
Condensing boiler efficiency:	Automatic recognition of the condensing boiler, with calculation and printout of efficiency (>100%) on the LHV (Lower Heating Value).
Environmental gases:	Measurement and separate printout of the ambient CO values.
Draft test:	Draft test by using the internal sensor connected to the port P-, resolution 0,1 Pa , accuracy 0,5 Pa.
Operating temperature range:	23°F to 113°F (-5°C to +45°C)
Storage temperature range:	-4°F to 122°F (-20°C to +50°C)
Operating humidity range:	20% to 80% RH
Protection grade:	IP42
Air pressure:	Atmospheric
Outer dimensions:	Analyzer: 3.5" x 12.2" x 2.4" (9 x 31 x 6 cm) (L x A x P) Case: 6" x 19" x 15" (15 x 48 x 38 cm) (L x A x P)
Weight:	Analyzer: ~ 2 lbs (0.9 Kg)



## 6.2 Measurement and Accuracy Ranges

MEASUREMENT	SENSOR	RANGE	RESOLUTION	ACCURACY	
O <sub>2</sub>	Electrochemical sensor	0 .. 25.0% vol	0.1% vol	±0.2% vol	
CO with H <sub>2</sub> compensation	Electrochemical sensor	0 .. 8000 ppm	1 ppm	±10 ppm	0 .. 200 ppm
				±5% measured value	201 .. 2000 ppm
diluted	Electrochemical sensor	10.00% vol	0.01% vol	±20% measured value	
CO Low range with H <sub>2</sub> compensation	Electrochemical sensor	0 .. 1000 ppm	0.1 ppm	±2 ppm	0 .. 40.0 ppm
				±5% measured value	40.1 .. 1000 ppm
diluted	Electrochemical sensor	100000 ppm	10 ppm	±20% measured value	
CO Mid range	Electrochemical sensor	0 .. 20000 ppm	1 ppm	±100 ppm	0 .. 2000 ppm
				±5% measured value	2001 .. 4000 ppm
diluted	Electrochemical sensor	25% vol	0.01% vol	±20% measured value	
CO Hi range	Electrochemical sensor	0 .. 10.00% vol	0.01% vol	±0.1% vol	0 .. 2.00 %
				±5% measured value	2.01 .. 10.00 %
CO high immunity H <sub>2</sub>	Electrochemical sensor	0 .. 8000 ppm	1 ppm	±20 ppm	0 .. 400 ppm
				±5% measured value	401 .. 4000 ppm
diluted	Electrochemical sensor	100000 ppm	10 ppm	±20% measured value	
NO	Electrochemical sensor	0 .. 5000 ppm	1 ppm	±5 ppm	0 .. 100 ppm
				±5% measured value	101 .. 5000 ppm
NO Low range	Electrochemical sensor	0 .. 500 ppm	0.1 ppm	±2 ppm	0 .. 40.0 ppm
				±5% measured value	40.1 .. 500.0 ppm
NO <sub>x</sub>	Calculated				
SO <sub>2</sub>	Electrochemical sensor	0 .. 5000 ppm	1 ppm	±5 ppm	0 .. 100 ppm
				±5% measured value	101 .. 5000 ppm
SO <sub>2</sub> (J57-2017)	Electrochemical sensor	0 .. 1000 ppm	0,1 ppm	±2 ppm	0 .. 40 ppm
			1 ppm	±5% measured value	41 .. 1000 ppm
SO <sub>2</sub> Low range	Electrochemical sensor	0 .. 500 ppm	0.1 ppm	±2 ppm	0 .. 40.0 ppm
				±5% measured value	40.1 .. 500.0 ppm
NO <sub>2</sub>	Electrochemical sensor	0 .. 1000 ppm	1 ppm	±5 ppm	0 .. 100 ppm
				±5% measured value	101 .. 1000 ppm
NO <sub>2</sub> Low range	Electrochemical sensor	0 .. 500 ppm	0.1 ppm	±2 ppm	0 .. 40.0 ppm
				±5% measured value	40.1 .. 500.0 ppm
C <sub>x</sub> H <sub>y</sub>	Pellistor sensor	0 .. 5.00% vol	0.01% vol	±0.25% vol	
CO <sub>2</sub>	Calculated	0 .. 99.9% vol	0.1% vol		
CO <sub>2</sub>	NDIR sensor	0 .. 20.0% vol	0.1% vol	±0.3% vol	0.00 .. 6.00 %
				±5% measured value	6.01 .. 20.0 %
PI* (CO/CO <sub>2</sub> ratio)	Calculated		0.01%		
Air temperature	TcK sensor	-4 .. 2282 °F	33,8 °F	±41 °F	32 .. 212 °F
				±0.5% measured value	213,8 .. 2282 °F
Flue gas temperature	TcK sensor	-4 .. 2282 °F	33,8 °F	±41 °F	32 .. 212 °F
				±0.5% measured value	213,8 .. 2282 °F
Pressure	Piezoelectric sensor	-250.0 .. 250.0 Pa	0.1 Pa	±0,5 Pa	-10.0 .. +10.0 Pa
				±2 Pa	+10.1 .. +250.0 Pa
				±2 Pa	-10.1 .. -250.0 Pa
Pressure (draft & differential)	Piezoelectric sensor	-10.00 .. 200.00 hPa	0.01hPa	±1% measured value	-2.01 .. -10.00 hPa
				±0.02 hPa	- 2.00 .. +2.00 hPa
				±1% measured value	+2.01 .. +200.00 hPa
Differential temperature	Calculated	32 .. 2282 °F	33,8 °F		
Air index	Calculated	0.00 .. 9.50	0.01		
Excess air	Calculated	0 .. 850 %	1 %		
Stack loss	Calculated	0.0 .. 100.0 %	0.1 %		
Efficiency	Calculated	0.0 .. 100.0 %	0.1 %		
Efficiency (condensing)	Calculated	0.0 .. 120.0 %	0.1 %		
Smoke index	External instrument	0 .. 9			

\* The Poison Index ratio (P.I.) is a reliable indicator of a boiler or burner good operation. It only takes a simple flue gas test to determine whether or not a service is needed to fix the system.

## 7.1 Preliminary operations

Remove the instrument from its packing and check it for damage. Make sure that the content corresponds to the items ordered. If signs of tampering or damage are noticed, notify the SEITRON AMERICAS service center or agent immediately and keep the original packing. A label at the rear of the analyzer bears the serial number. This serial number should always be stated when requesting technical assistance, spare parts or clarification on the product or its use.

Seitron Americas maintains an updated database for each and every instrument. Before using for the first time we recommend you charge the batteries completely.

## 7.2 WARNING

- Use the instrument with an ambient temperature between 23° and 113°F (-5° and +45°C).

**IF THE INSTRUMENT HAS BEEN KEPT AT VERY LOW TEMPERATURES (BELOW OPERATING TEMPERATURES) WE SUGGEST WAITING A WHILE (1 HOUR) BEFORE SWITCHING IT ON TO HELP THE SYSTEM'S THERMAL BALANCE AND TO PREVENT CONDENSATE FORMING IN THE PNEUMATIC CIRCUIT.**

- When it has finished being used, before turning the instrument off remove the probe and let it aspirate ambient clean air for at least 30 seconds to purge the pneumatic path from all traces of gas.
- Do not use the instrument if the filters are clogged or damp.
- Before putting the measuring probe back in its case after use, make sure it has cooled down enough and there is no condensate in the tube. It might be necessary to periodically disconnect the filter and the condensate separator and blow compressed air inside the tube to eliminate all residues.
- Remember to have the instrument checked and calibrated once a year in order to comply with the existing standards.

**IF ENABLED BY FACTORY OR THE ASSISTANCE CENTER, FROM 30 DAYS PRIOR TO THE CALIBRATION TO EXPIRE, THE DISPLAY WILL SHOW A MESSAGE TO REMIND THE USER THAT THE INSTRUMENT HAS TO BE SENT TO THE ASSISTANCE CENTER.**

Example:

Press and hold for a few seconds

15/01/14  
10:00

Password  
Reminder

0000

OK

Enter the reminder menu password  
1111.

15/01/14  
10:00

Password  
Reminder

1111

OK

15/01/14  
10:00

Reminder  
Calibration

Annual calibration reminder.

Expiration date: 15/07/19

F1: Info service

F2: Ignore

F3: Ignore forever

F1 F2 F3

CONTEXT KEY	FUNCTION
<b>F1</b>	<b>Displays the information about the assistance center.</b>
<b>F2</b>	<b>Ignores temporarily the message. Next time the instrument will be turned on, the remainder will be displayed again.</b>
<b>F3</b>	<b>Ignores permanently the message.</b>

### 7.3 Analyzer power supply

The instrument contains a high-capacity Li-Ion rechargeable battery. The battery feeds the instrument, built-in printer and any other probes or remote devices that may be connected. The instrument runs for approximately 18 hours if the printer is not used. Should the battery be too low to effect the necessary measurements, the instrument can be hooked up to the mains via the power pack provided, allowing operations (and analysis) to proceed. The battery will be recharged whilst the instrument is being used. The battery charging cycle takes up to 3 hours for a complete charge and finishes automatically.

**ATTENTION: If the instrument is not going to be used for a long time we suggest recharging it at least once every 4 months.**

#### 7.3.1 Checking and replacing the batteries

The state of the internal battery can be displayed during the auto-calibration of the device and possibly later via the information menu.

In the menu, the remaining battery power is displayed.

If battery charge appears to be low, let it discharge completely and then carry out a full 100% charge cycle by connecting the instrument to the power pack for 3 hours.

If the problem persists, replace the battery pack with a SEITRON AMERICAS original or contact the SERVICE CENTRE to carry out the necessary repairs.

The average life of the battery pack is 500 charging/discharging cycles. To exploit this characteristic to the full it is advisable to always use the instrument powered by the internal batteries and to charge it only when it gives the battery flat message.

	<p><b>THE INSTRUMENT IS SHIPPED WITH A BATTERY LEVEL LOWER THAN 30% AS REQUIRED BY CURRENT AIR TRANSPORTATION STANDARDS. BEFORE USE PERFORM A COMPLETE CHARGING CYCLE OF 8 HOURS.</b></p> <p><b>IT IS ADVISABLE TO CHARGE THE BATTERY AT AN AMBIENT TEMPERATURE RANGING BETWEEN 10°C AND 30°C.</b></p>
--	--

The instrument can be left in stock for a period of time depending on the charging level of the battery; below there is a table showing the correlation between stock time and charging level.



BATTERY LEVEL	STOCK TIME
100%	110 days
75%	80 days
50%	45 days
25%	30 days

#### 7.3.2 Use with external power pack

The instrument can work with the batteries fully discharged by connecting the external power pack provided.

	<p><b>THE POWER SUPPLY/BATTERY CHARGER IS A SWITCHING TYPE ONE. THE APPLICABLE INPUT VOLTAGE RANGES BETWEEN 90Vac AND 264Vac. INPUT FREQUENCY: 50-60Hz. THE LOW VOLTAGE OUTPUT IS 5 VOLT WITH AN OUTPUT CURRENT GREATER THAN 1.5A.</b></p> <p><b>LOW VOLTAGE POWER CONNECTOR: A-TYPE USB CONNECTOR + CONNECTION CABLE WITH B-TYPE PLUG.</b></p>
---	---

### 7.4 QR code generation

With the key combination  +  it is possible to generate and display a QR code.

This solution has been introduced to avoid the Bluetooth compatibility issues of the Apple devices. This code can be scanned with an Apple device, prior to the installation of the Seitron Smart Analysis App available from the AppStore (iOS) with the purpose to download the data of the taken measures.

	<p><b>THE QR CODE IS GENERATED ONLY WHETHER A MEASUREMENT SCREEN IS DISPLAYED ON THE INSTRUMENT.</b></p>
---	--

### 7.5 Connection diagram

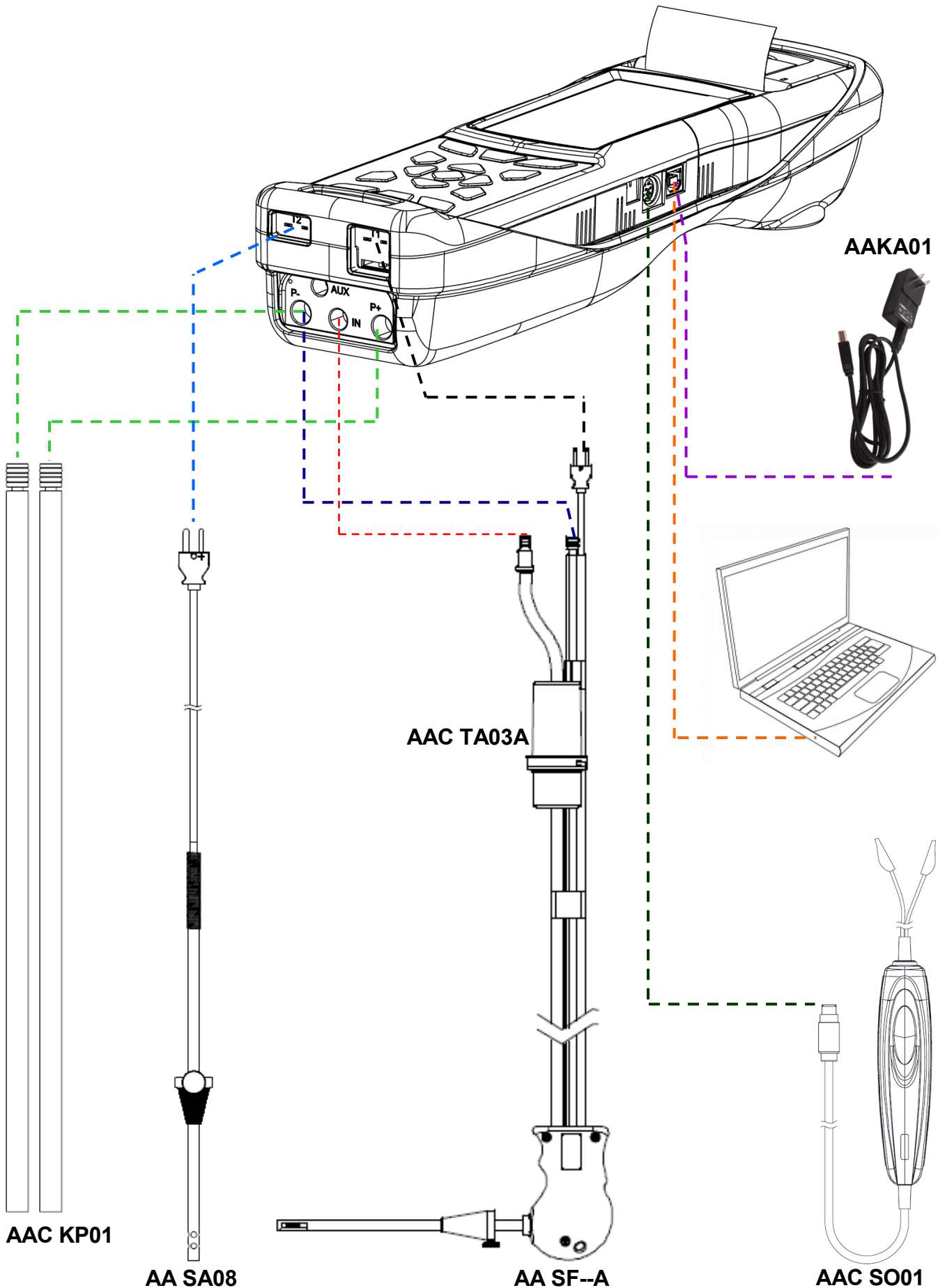

## 7.5.1 Gas sampling probe

### General description

The gas sampling probe is made of a stainless steel tube with a plastic hand grip and includes an internal K-type thermocouple (Ni-NiCr) for measuring the gas temperature of the gas.

The thermocouple is located in the probe tip. It is connected to the instrument via a compensated cable running in a specific slot of the rubber hose of the sample probe.

The compensation of the cold junction is performed with a Pt100 RTD (Resistance Temperature Detector) that measures the temperature in correspondence of the thermocouple connector.

The K-type thermocouple (Ni-NiCr) allows continuous measurements at high temperatures.

The instrument has another internal Pt100 RTD for measuring the internal temperature; this sensor is also used for measuring the ambient temperature. In case you wish to detect the temperature of the combustion air directly into the intake duct you will have to use the Tc-K type optional remote sensor.

It is suggested to perform this measurement to carry out the calculation of the efficiency of the system when the temperature of the combustion air is different than the temperature of the environment where the instrument is positioned.

### Technical features:

Temperature sensor:		K-type thermocouple (Ni-NiCr) - IEC584 - class 1
Pneumatic connectors:		Male- diameter 0.35 inches pressure connection Male - diameter 0.31 inches gas entrance connection
Temperature sensor connector:		TC-K mignon
Tube:	Material:	EPDM
Adaptor for pockets:	Material:	Galvanized steel
	External diameter:	10 .. 22 mm.
Handle:	Material:	Nylon
	Color:	Black
Tip:	Material:	AISI 304 stainless steel
	Diameter:	8 mm

CODE	TIP LENGTH	EPDM TUBE LENGTH	MAXIMUM WORKING TEMPERATURE
AASF51A	180 mm // 7 inches	2 m // 6.6 ft.	752°F - immersion depth 3.9 inches
AASF52A	300 mm // 11.8 inches	3 m // 9.8 ft.	1112°F - immersion depth 6.3 inches
AASF62A	300 mm // 11.8 inches	3 m // 9.8 ft.	1112°F - immersion depth 6.3 inches
AASF65A	750 mm // 29.5 inches	3 m // 9.8 ft.	1472°F - immersion depth 19.6 inches
AASF66A	1000 mm // 39 inches	3 m // 9.8 ft.	2192°F - immersion depth 19.6 inches
AASL05A	300 mm // 11.8 inches	2 m // 6.6 ft.	266°F - immersion depth 6.3 inches

**WARNING:** in case of measurement of very high temperatures it is recommended to remove the tip slowly in order to let it cool down without suffering heat stress; once extracted from the measurement point do not place it on a cold surface, otherwise this could affect the internal temperature sensor; in case of failure of the thermocouple it is possible to replace the bare element with a compensated cable (see [section 17 'Spare parts and service'](#)).

## 7.5.2 Smoke sampling probe for average CO measurement

This probe, is made up by an INOX AISI 304 steel multi-perforated stiff tip, provided with a adjustable well adapter, it allows to take the smoke from different spots of the chimney, so to obtain the average CO measure.

The smoke temperature is measured through a thermocouple type K (Ni-NiCr) inserted in the probe tip. This is connected to the instrument through a compensated cable inserted in a proper seat of the smoke sampling probe rubber pipe.

Because of the technical construction of the tip, the internal thermocouple does not detect immediately the correct smoke temperature.

The compensation of the cold junction is made with a Pt100 thermistor which detect the temperature in correspondence of the thermocouple connector.

The thermocouple type K (Ni-NiCr) allows continuous measures at high temperatures.

This probe can be also used for the combustion analysis.

### Technical specifications

Temperature sensor:	Thermocouple type K (Ni-NiCr) - IEC584 - class 1
Pneumatic connectors:	Male- diameter 0.35 inches pressure connection Male - diameter 0.31 inches gas entrance connection
Temperature sensor connector:	TC-K mignon

Tube:	Material:	EPDM
	Length:	6.6 ft
Well adapter:	Material:	Galvanized steel
	External diameter:	0.39 .. 0.87 inches
Handle:	Material:	Nylon
	Color:	Black
Tip:	Material:	AISI 304 Steel
	Diameter:	0.31 inches
	Length:	11.8 inches
Working temperature:		max. 1112°F

### 7.5.3 Condensate trap and fine dust filter

The sample gas to be analysed shall reach the measurement sensors after being properly dehumidified and purified from the residual combustion products. To this purpose, a condensate trap is used, which consists of a transparent polycarbonate cylinder placed along the rubber hose of the sampling probe. Its purpose is to decrease the air speed so that the heavier fine dust particles can precipitate and the vapour in the combustion gases can condensate.

The condensate trap must be always kept in the vertical position in order to prevent condensate from touching the measurement sensors. This is also the reason why it is important to periodically drain the trap, anyhow at the end of each test (see chapter 'MAINTENANCE').

A replaceable low-porosity line filter is placed after the condensate trap aimed at keeping the solid particles suspended in the gases. It is recommended to replace the filter whenever visibly dirty (see chapter 'MAINTENANCE').



**KEEP THE CONDENSATE TRAP IN THE VERTICAL POSITION DURING THE ANALYSIS; A WRONG POSITIONING MAY CAUSE CONDENSATE SEEPAGES IN THE INSTRUMENT AND DAMAGE SENSORS.**

**AFTER EACH ANALYSIS, CHECK FOR ANY PRESENCE OF WATER IN THE CONDENSATE COLLECTION BOWL AND ELIMINATE IT, IF ANY. PUT THE PROBE BACK IN THE CASE ONLY AFTER YOU HAVE ELIMINATED CONDENSATE FROM THE TUBE AND THE EXPANSION TANK (SEE CHAPTER 'MAINTENANCE').**

**REPLACE THE FINE DUST FILTER IF IT IS VISIBLY DIRTY OR WET (SEE CHAPTER 'MAINTENANCE'). DO NOT PERFORM ANY MEASUREMENT WHEN THE FILTER IS REMOVED OR DIRTY IN ORDER TO AVOID ANY RISK OF IRREVERSIBLE DAMAGES ON SENSORS.**

### 7.5.4 Connecting the gas sampling probe (Standard / average CO) and water-trap assembly

As shown in [section 7.5](#) the gas sampling probe must be connected to the device as follows:

- The polarized male connector of the thermocouple must be connected to the lower part of the device in the **T1** socket. The improper insertion of the same is not possible thanks to the different lengths of the tips.
- The shorter tube of the probe must be inserted in the condensation trap with ant-dust filter (see [section 7.5.3](#)).
- The male connector of the filter assembly must be connected to the central female connector of the device marked with **"IN"**.
- The longer tube of the probe, which ends with a male connector, must be connected to the negative pressure input of the device marked with the letter **"P-"**.

The different diameter of the connectors does not allow improper connections: this avoids damage to the device.

### 7.5.5 Connecting the TcK probe

Using the same input as for the K thermocouple **"T1"** (the same used for gas temperature), it is possible to measure the water delivery and return temperature by connecting some **special probes**. If temperature is taken on the pipe, it is suggested to use arc probes with a suitable diameter.

### 7.5.6 Combustion air temperature probe

The probe to measure the temperature of the combustion air (necessary for an exact calculation of the efficiency of the boiler) features a stainless steel tube with an adapter for wells of the diameter of 0.30 / 0.67 inches and K-type internal thermocouple (Ni-NiCr) to measure the temperature between -4°F and 212°F.

The probe comes complete with a 6.6 ft cable with a connector for connection with the analyzer.

### 7.5.7 Connection of combustion air temperature probe

As shown in section 7.4 the probe must be connected to the device as follows:

- ♦ The polarized male connector of the thermocouple must be connected to the lower part of the device in the T2 socket. The improper insertion of the same is not possible thanks to the different lengths of the tips.

### 7.5.8 Burner pressure verification probe

It must be used to measure burner pressure of the gas-powered boiler so it can be regulated in real time. It is made of a silicone tube, 0.31x1.16 inches and 3.28 feet length, complete with connector for connecting to the analyzer.

### 7.5.9 Ionisation current measuring probe

With this special probe it is possible to measure the ionisation current of a boiler and check its value depending on the boiler's technical features.

### 7.5.10 Ambient CO measurement probe

This special probe allows the ambient CO measurement before accessing the boiler room and just then, to measure the CO in the environment while the combustion analysis is performed (as, for example, compelled by the Spanish standard ES.02173.ES, Gas Natural Fenosa), prior entering the data "CO amb. ext." in the parameter "configuration measurement list". The value of the ambient CO can be also printed along with the combustion analysis, if previously selected in the parameter "Print measurement list".

For further details refer to the probe instruction manual.

### 7.5.11 Gas probe for industrial engines

This type of probe is typically used in processes where the smoke sampled is very dirty and must be filtered out before reaching the measurement instrument. To preserve the internal system, it is necessary to filter the smoke from the dust directly on the tip of the probe, using an AISI 316L inox steel filter. The probe tip is provided with a flange that acts as a heatsink to make sure that, in case of very high temperature at the chimney, the handle is not damaged by a temperature that might exceed 212 .. 248° F (max. allowed temperature).

The condensation-smoke separation happens in the special anti-condensation trap placed on the probe tube.

#### Technical features:

Tip:	Material:	AISI 304 Steel
	Diameter:	0.3 inches
	Length:	29.5 inches rigid tip + heatsink, insertion depth 23.6 inches
Handle:	Material:	Nylon
	Color:	Black
Hose:	Material:	EPDM
	Length:	9.8 ft
Filter:		AISI 316L sintered stainless steel, washable with ultrasonic bath or with solvents and steel brush.
Temperature sensor:		Thermocouple type K (Ni-NiCr) - IEC584 - class 1
Pneumatic connectors:		Male - diameter 0.35"
		Male - diameter 0.31"
Temperature sensor connector:		TC-K mignon
Working temperature:		max. 1472°F

### 7.5.12 Measurement of differential pressure

The device is equipped with a temperature compensated piezoresistive internal pressure sensor to measure pressures and depressions. This sensor, mounted onto the device, is of the differential type.

Thanks to the positive and negative pressure connectors, it can therefore be used to measure the differential pressure by purchasing the special KIT. The measurement range is -1000 Pa ... +20000 Pa.

### 7.5.13 Connection to PC

By using the USB cable supplied or via Bluetooth connection (optional) it is possible to connect the device to a personal computer after installing the dedicated software supplied.

Functions:

- See the data plate of the device
- See and/or export (in csv format, importable into excel, and/or pdf) or delete the stored analyses.
- Configure the device.

### 7.5.14 Connection to battery charger

Supplied with the device is a feeder with output 5V ===, 2A to charge the internal batteries. In section 4.3 you can see the socket for the connection of the battery charger to the device. Once it has started charging, the display turns on and the state of charge of the battery is displayed.

---

### 7.5.15 NO<sub>x</sub> measurement (S4500 model only)

The measurement of the quantities of NO<sub>x</sub> and NO<sub>x</sub> referring to O<sub>2</sub>, can be displayed simultaneously in ppm and with another chosen measurement unit. Specifically, the following can be selected and displayed:

- NO<sub>x</sub> with a measurement unit selected in the special menu.
- NO<sub>x</sub> referring to O<sub>2</sub> (%) with O<sub>2</sub>%=0
- NO<sub>x</sub> in parts per million (ppm)
- NO<sub>x</sub> referring to O<sub>2</sub> (ppm)



## 8.1 Starting the device

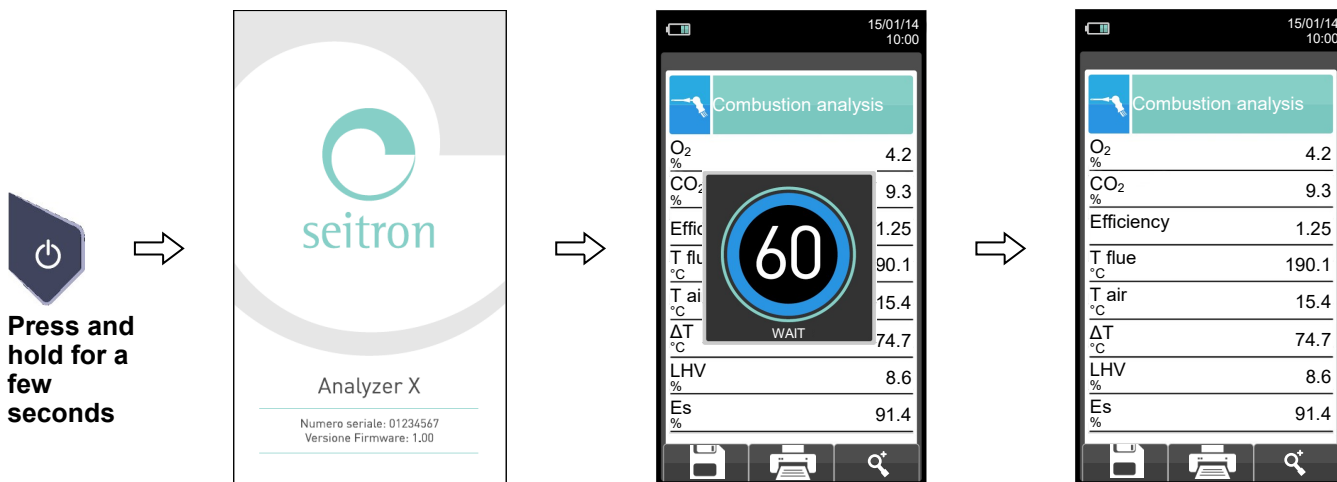

During autozero, you can only use the menus that do not require autozero.

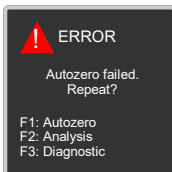

This error message is displayed if the autozero of the device is not carried out.

KEY	FUNCTION
	Activate the context keys shown on the display.
	Goes through the measurements available.
	Activates the context key located in the left side of the display.
	Returns to the previous screen.

CONTEXT KEY	FUNCTION
	Repeats autozero (is shown in the case of an error).
	The device will suspend autozero and display the screen "Combustion Analysis"; it is possible to carry out the analysis of combustion (displayed in the case of an error).
	The device displays the screen "Sensor Diagnostics" (displayed in the case of an error).
	Save analysis.
	Print the test ticket according to the settings.
	Zooms the screen

## 9.1 Configuration menu

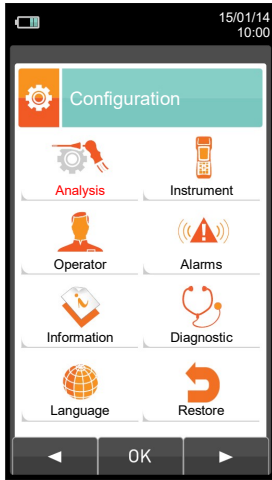

KEY	FUNCTION
	Activate the context keys shown on the display.
	Returns to the previous screen.

CONTEXT KEY	FUNCTION
	Selects the available parameters.
	Enters in the selected parameter setting.
	Selects the available parameters.

PARAMETER	FUNCTION
Analysis	Through this menu the user can configure the available parameters for a proper combustion analysis. <a href="#">SEE SECTION 9.2.</a>
Instrument	This menu is used to configure the instrument's reference parameters. <a href="#">SEE SECTION 9.3.</a>
Operator	In this sub menu you can enter or change the name of the operator that will carry out the analysis. Up to 8 lines are available. Also, you can select the name of the operator that will carry out the analysis and this will be printed on the analysis report. <a href="#">SEE SECTION 9.4.</a>
Alarm	This submenu allows the user to set and store 10 alarms, defining the monitored parameter for each (gas, pressure, Ta, Tf), the alarm threshold and relative unit of measurement and whether it is a low or high-level alarm. Low-level alarms are triggered when the reading drops below the defined threshold, whereas high-level alarms are triggered when the reading rises above the defined threshold. When an alarm threshold is crossed, the instrument emits an intermittent audible alarm besides activating a visible alarm wherein the background of the name of the relative reading will start flashing in the analysis screen. <a href="#">SEE SECTION 9.5.</a>
Information	This menu provides information regarding instrument status. <a href="#">SEE SECTION 9.6.</a>
Diagnostic	The user, with this menu, can check any anomalies of the device. <a href="#">SEE SECTION 9.7.</a>
Language	Set the desired language for the various menus and the test ticket. <a href="#">SEE SECTION 9.8.</a>
Restore	Restore factory settings. <a href="#">SEE SECTION 9.9.</a>

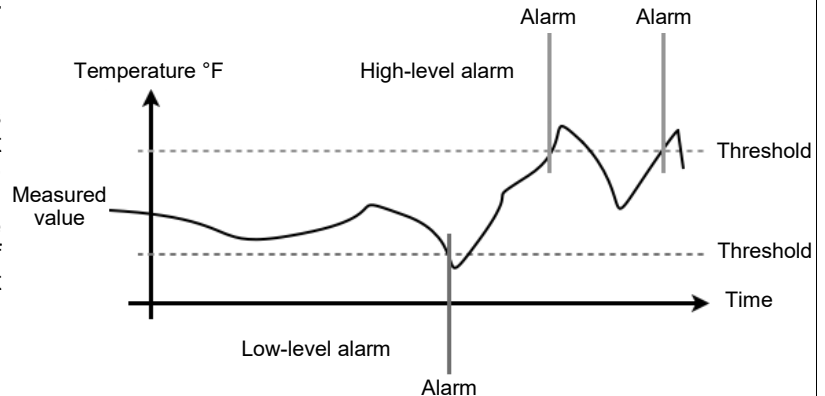

## 9.2 Configuration → Analysis

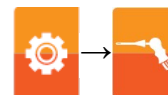

KEY	FUNCTION
	Activate the context keys shown on the display.
	Returns to the previous screen.

CONTEXT KEY	FUNCTION
	Selects the available parameters.
	Enters in the selected parameter setting.
	Selects the available parameters.

PARAMETER	DESCRIPTION
Fuel	Lets the user select the type of fuel to be used during analysis. This datum can be varied either from this menu or during the analysis itself. By selecting the sub menu <b>Fuel coefficients</b> the user can view the characteristics of the fuels used in the calculation of performance. <a href="#">SEE SECTION 9.2.1.</a>
Condensation	The burner efficiency figure when condensation takes place is influenced by atmospheric pressure and humidity of the combustion air. As the atmospheric pressure is hardly precisely known, the operator is asked to enter a related parameter, i.e. the altitude of the place above the sea level, from which the pressure is then derived once the dependency from atmospheric conditions is neglected. In calculations the value of 101325 Pa is assumed as atmospheric pressure at sea level. Further the air relative humidity input is allowed, being this calculated at the combustion air temperature as measured from the instrument; in case this value is unknown the operator is recommended to enter 50% for this value. <a href="#">SEE SECTION 9.2.2.</a>
O <sub>2</sub> reference	In this mode the user can set the oxygen percentage level to which pollutant emission values detected during analysis will be referenced. <a href="#">SEE SECTION 9.2.3.</a>
NO <sub>x</sub> NO <sub>x</sub> /NO ratio	NO <sub>x</sub> /NO: all the nitrogen oxides which are present in the flue emissions (Nitrogen oxide = NO, Nitrogen dioxide = NO <sub>2</sub> ); total nitrogen oxides = NO <sub>x</sub> (NO + NO <sub>2</sub> ). In the combustion processes, it is found out that the NO <sub>2</sub> percentage contained in the gas is not far from very low values (3%); hence it is possible to obtain the NO <sub>x</sub> value by a simple calculation without using a direct measurement with a further NO <sub>2</sub> sensor. The NO <sub>2</sub> percentage value contained in the gas can be however set at a value other than 3% (default value). <a href="#">SEE SECTION 9.2.4.</a>
Measure units	Through this submenu the user can modify the units of measurement for all the analysis parameters, depending on how they are used. <a href="#">SEE SECTION 9.2.5.</a>
Autozero	In this sub menu the user can change the length of the autozero cycle of the analyzer and start it manually. <a href="#">SEE SECTION 9.2.6.</a>
Measures list	In this sub menu the user can see the list of measurements that the device can perform. With the interactive keys, the user can add, delete or move a selected measurement. <a href="#">SEE SECTION 9.2.7.</a>
Air temp.	In this submenu there is a possibility to acquire or manually enter the combustion air temperature. <a href="#">SEE CHAPTER 9.2.8.</a>

### 9.2.1 Configuration → Analysis → Fuel

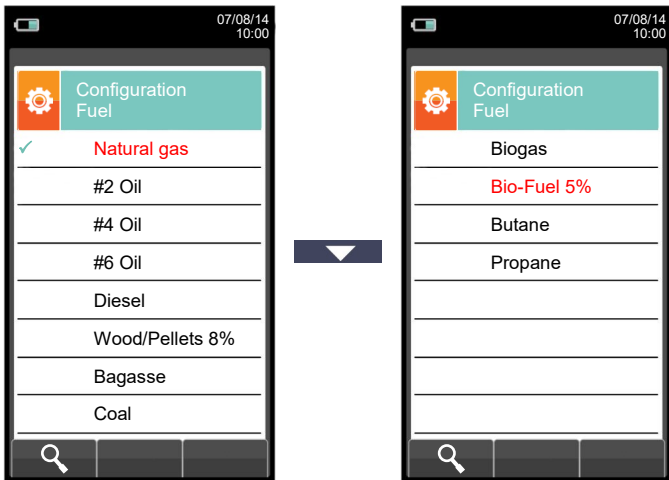
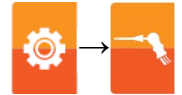

KEY	FUNCTION
	Activate the context keys shown on the display.
	The arrows select each line displayed.
	Confirms the choice of fuel to be used during the analysis.
	Returns to the previous screen.

CONTEXT KEY	FUNCTION
	Shows the details of the selected fuel (see example below).
	Returns to the previous screen.

Example:

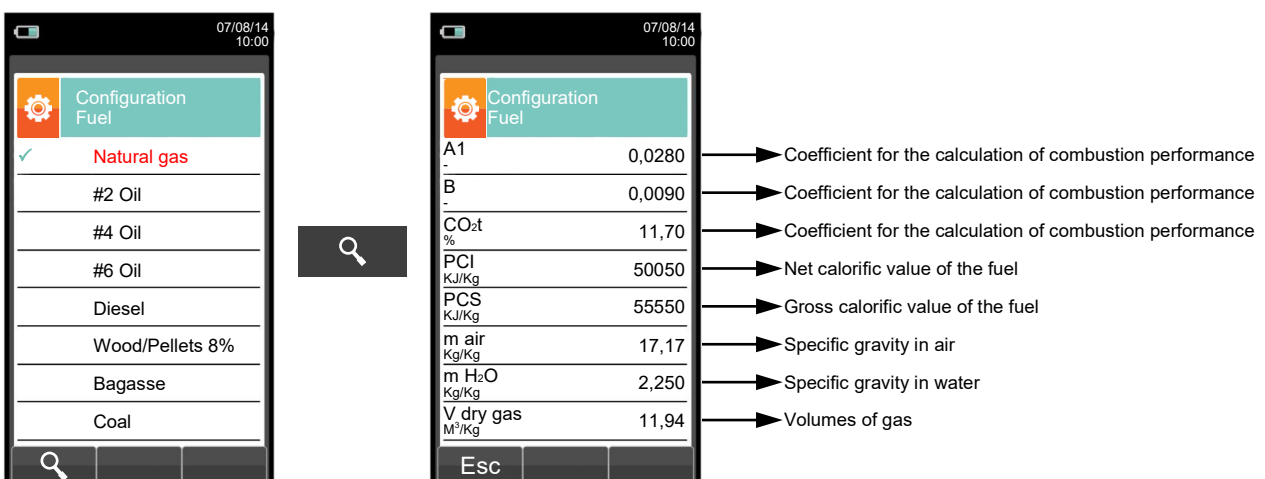

## 9.2.2 Configuration → Analysis → Condensation

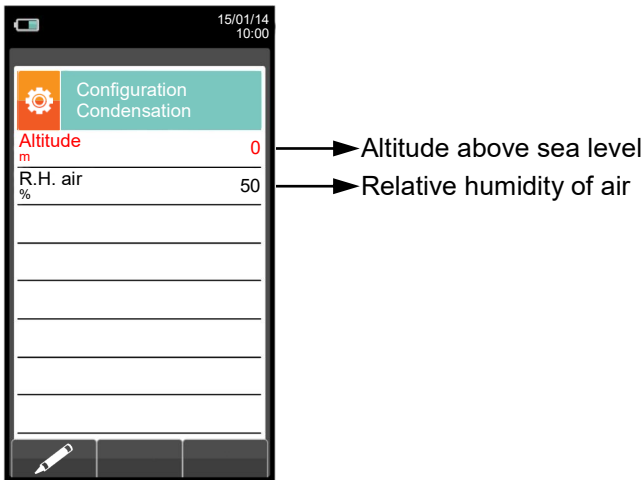
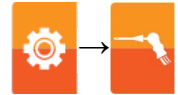

KEY	FUNCTION
	Activate the context keys shown on the display.
	The arrows select each line displayed (the selected line is red). In edit mode, it scrolls through the suggested values.
	Enters the modify mode for the selected parameter, then confirms the modification.
	When pressed in modify mode cancels the selection made, otherwise returns to the previous screen.

CONTEXT KEY	FUNCTION
	Enters the modification mode for the selected parameter.
	Confirms the modification.

Example:

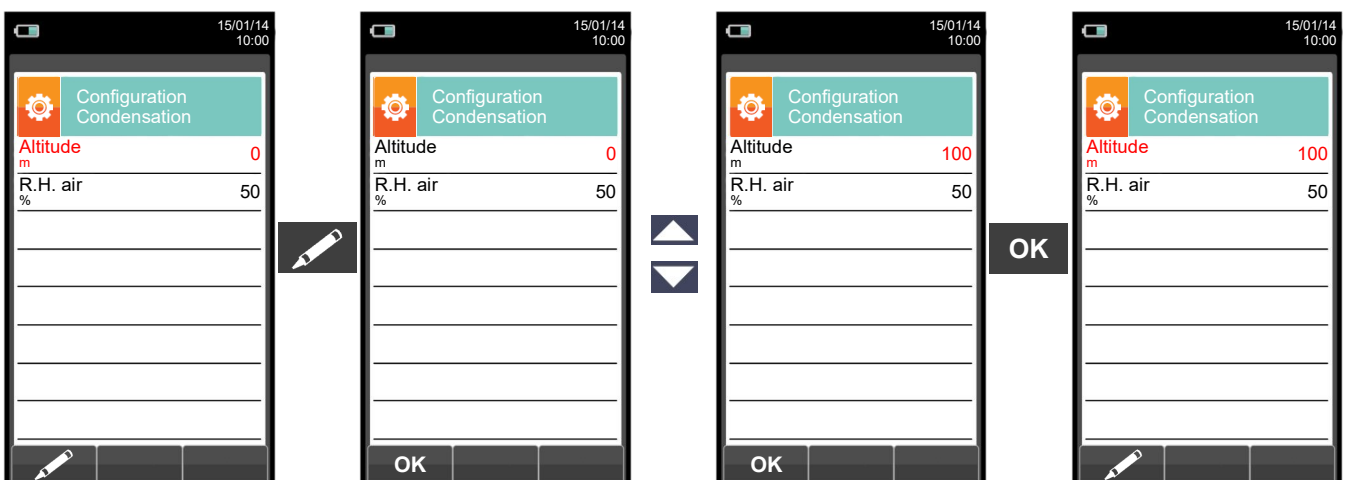

### 9.2.3 Configuration → Analysis → Reference O<sub>2</sub>

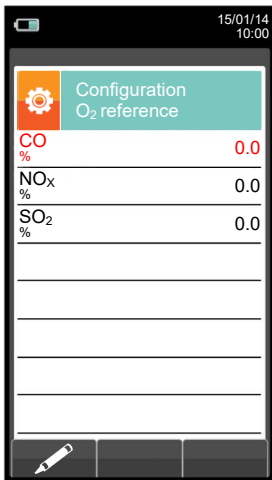
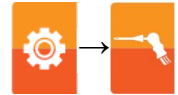

- ▶ Percentage of Oxygen in CO measurement
- ▶ Percentage of Oxygen in NO<sub>x</sub> measurement
- ▶ Percentage of Oxygen in SO<sub>2</sub> measurement

KEY	FUNCTION
	Activate the context keys shown on the display.
	Keys '▲' and '▼' select any line shown on the display (the selected line is evidenced in red). When in modify mode, sets the desired value.
	Enters the modify mode for the selected parameter, then confirms the modification.
	When pressed in modify mode cancels the selection made, otherwise returns to the previous screen.

CONTEXT KEY	FUNCTION
	Enters the modify menu for the selected parameter.
	Confirms the modification.

Example:

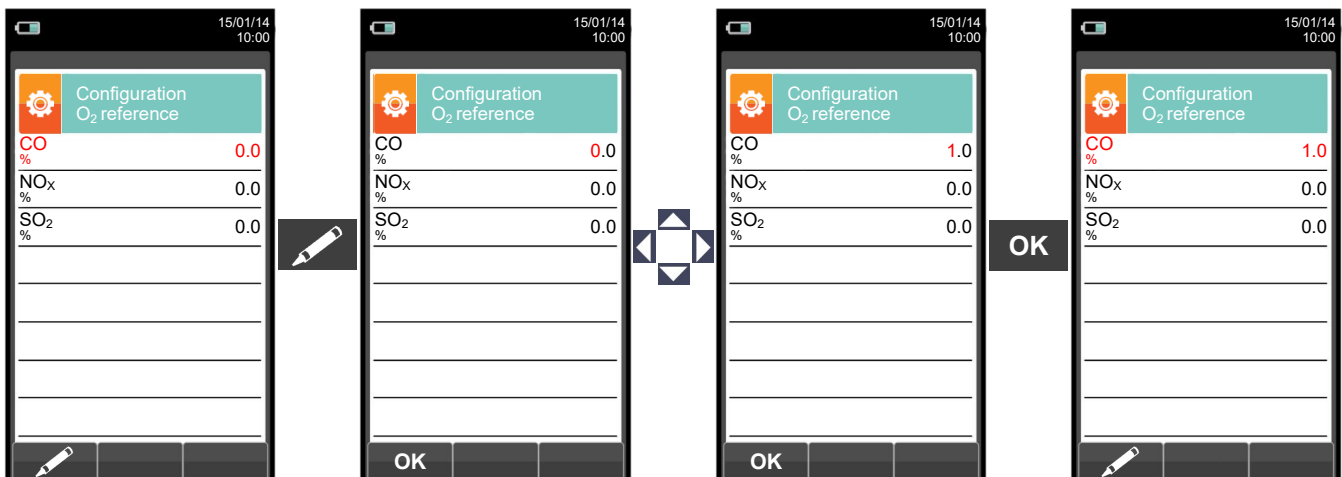

## 9.2.4 Configuration → Analysis → NO<sub>x</sub>/NO ratio

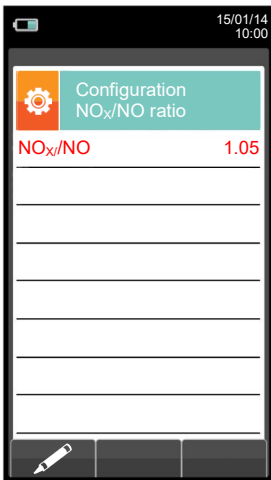
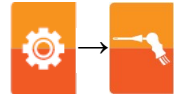

KEY	FUNCTION
	Activate the context keys shown on the display.
	When in modify mode, sets the desired value.
	Enters edit mode of the selected element and then confirms the change.
	When pressed in modify mode cancels the selection made, otherwise returns to the previous screen.

CONTEXT KEY	FUNCTION
	Enters edit mode.
	Confirms the modification.

Example:

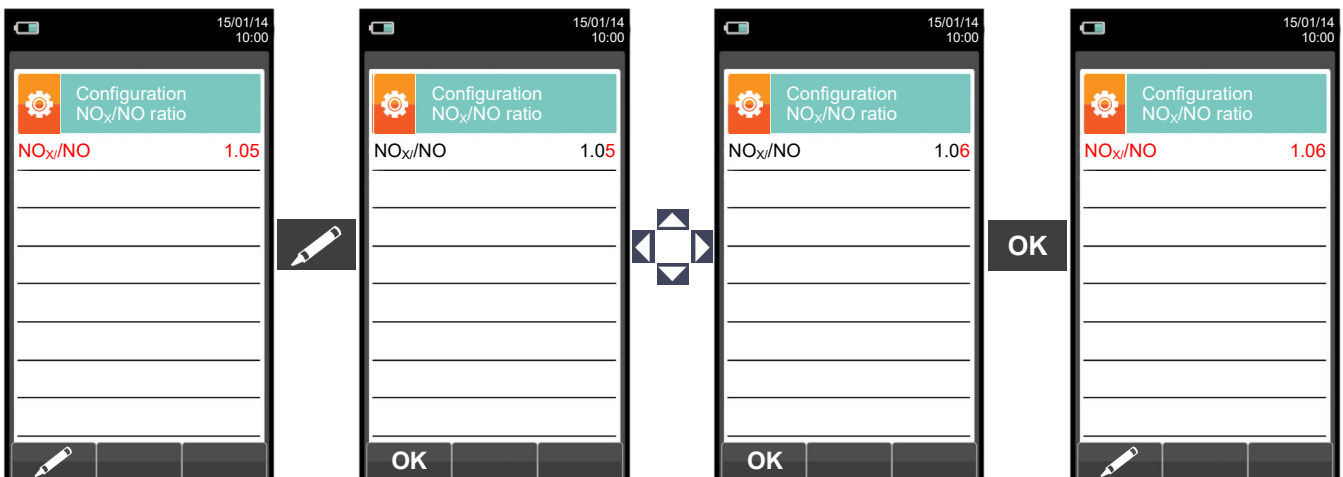

## 9.2.5 Configuration → Analysis → Measurement units

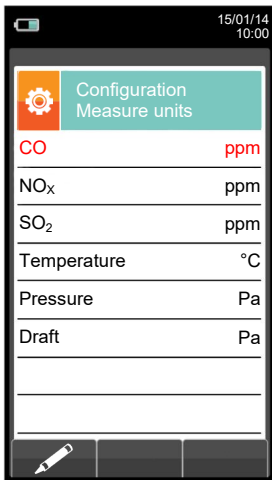
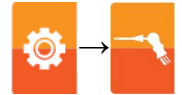

- Measurement unit can be set as: ppm - mg/m<sup>3</sup> - mg/kWh - g/GJ - g/m<sup>3</sup> - g/kWh - % - ng/J
- Measurement unit can be set as: ppm - mg/m<sup>3</sup> - mg/kWh - g/GJ - g/m<sup>3</sup> - g/kWh - % - ng/J
- Measurement unit can be set as: ppm - mg/m<sup>3</sup> - mg/kWh - g/GJ - g/m<sup>3</sup> - g/kWh - % - ng/J
- Measurement unit can be set as: °C - °F
- Measurement unit can be set as: hPa - Pa - mbar - mmH<sub>2</sub>O - mmHg - inH<sub>2</sub>O - psi
- Measurement unit can be set as: hPa - Pa - mbar - mmH<sub>2</sub>O - mmHg - inH<sub>2</sub>O - psi

The measurement units mg/m<sup>3</sup> and g/m<sup>3</sup> are referred to Normal pressure and temperature conditions, P = 101325 Pa and T = 0 °C.

KEY	FUNCTION
	Activate the context keys shown on the display.
	Keys '▲' and '▼' select any line shown on the display (the selected line is evidenced in red). When in modify mode, sets the desired value.
	Enters edit mode of the selected element and then confirms the change.
	When pressed in modify mode cancels the selection made, otherwise returns to the previous screen.

CONTEXT KEY	FUNCTION
	Enters the modification mode for the selected parameter.
	Confirms the modification.

Example:

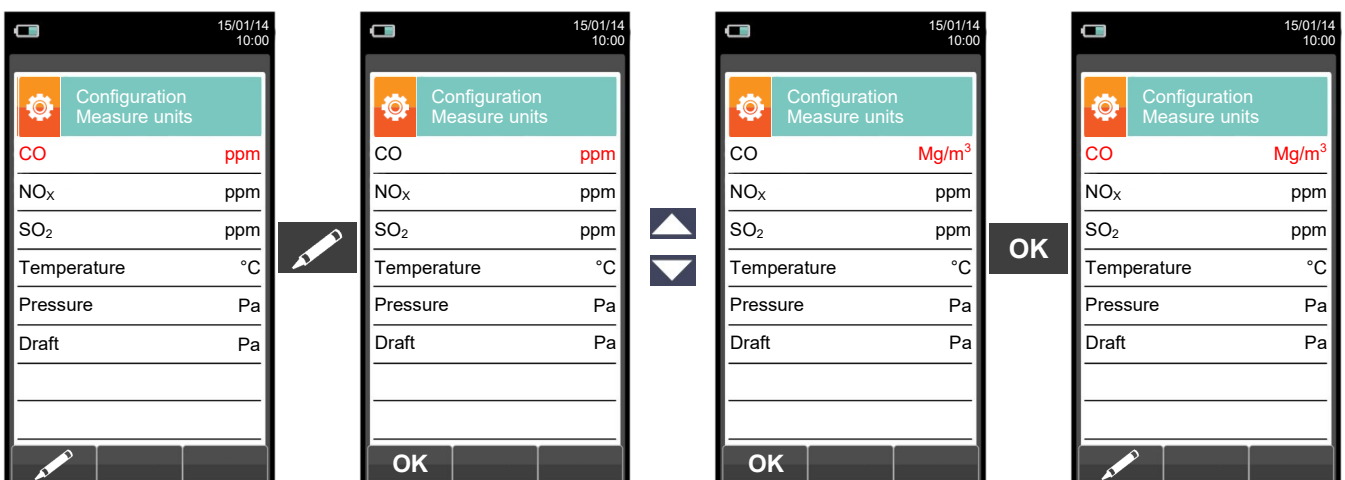



## 9.2.6 Configuration → Analysis → Autozero

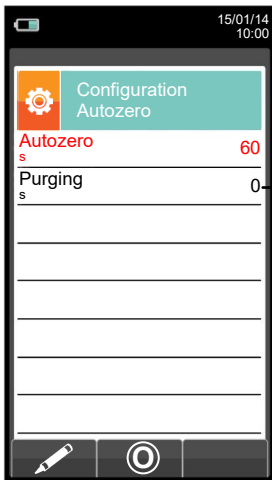
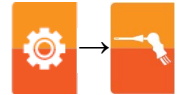

→ Duration of autozero, expressed in seconds.  
 → Duration of the cleaning cycle, expressed in seconds.

KEY	FUNCTION
	Activate the context keys shown on the display.
	When in modify mode, sets the desired value.
	Enters edit mode of the selected element and then confirms the change.
	When pressed in modify mode cancels the selection made, otherwise returns to the previous screen.

CONTEXT KEY	FUNCTION
	Enters the modify menu for the selected parameter.
	Confirms the modification.
	Starts autozero for the selected duration.



Example:



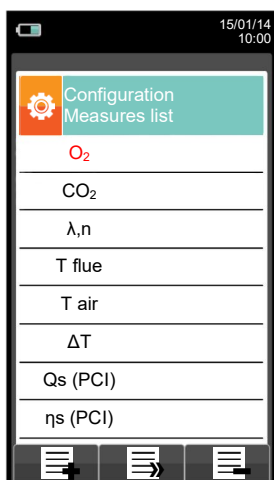
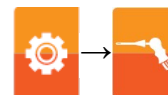







## 9.2.7 Configuration→Analysis→Measures list



 FOR FURTHER DETAILS SEE THE [ANNEX E](#)

KEY	FUNCTION
	Activate the context keys shown on the display.
	Select each line displayed (the line selected is red). In edit mode, it sets the desired value.
	When pressed in modify mode cancels the selection made, otherwise returns to the previous screen.

CONTEXT KEY	FUNCTION
	Adds a line to the list of available measurements.
	Activates the movement of a measurement from its current position.
	Deletes a measurement from the list of available measurements.
	After the activation of the function '  ': It scrolls through the available measurements. After the activation of the function '  ': It moves the element from its current position.
	Confirms the operation.
	Cancel the operation.



OTHER THAN THE MEASUREMENT LIST ABOVE, IT IS POSSIBLE TO VISUALIZE THE MEASURE OF THE DETECTED GAS ALSO IN PPM, DEPENDING ON THE KIND OF MEASUREMENT SENSOR IN THE INSTRUMENT. IF IT IS NECESSARY TO MEASURE THE VALUE OF GAS WITH TWO DIFFERENT MEASUREMENT UNITS, SELECT IN THE MEASUREMENTS LIST THE DESIRED GAS IN PPM AND CHANGE THE MEASUREMENT UNIT FOR THE SAME GAS IN THE "CONFIGURATION->ANALYSIS->MEASUREMENT UNIT" SCREEN. NOW THE INSTRUMENT ACQUIRES THE MEASURE WITH TWO DIFFERENT UNITS (PPM AND THE ONE PREVIOUSLY SET)

**Example:**

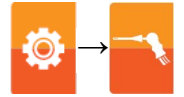

**1. Add a measurement to the list - example**

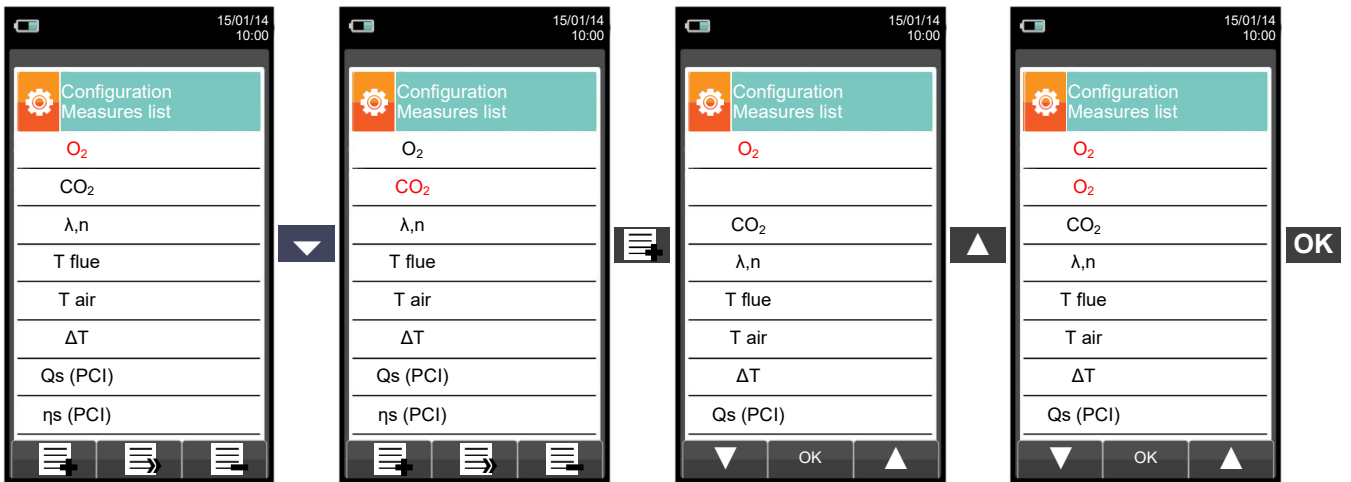

**2. Change the position of a measurement - example**

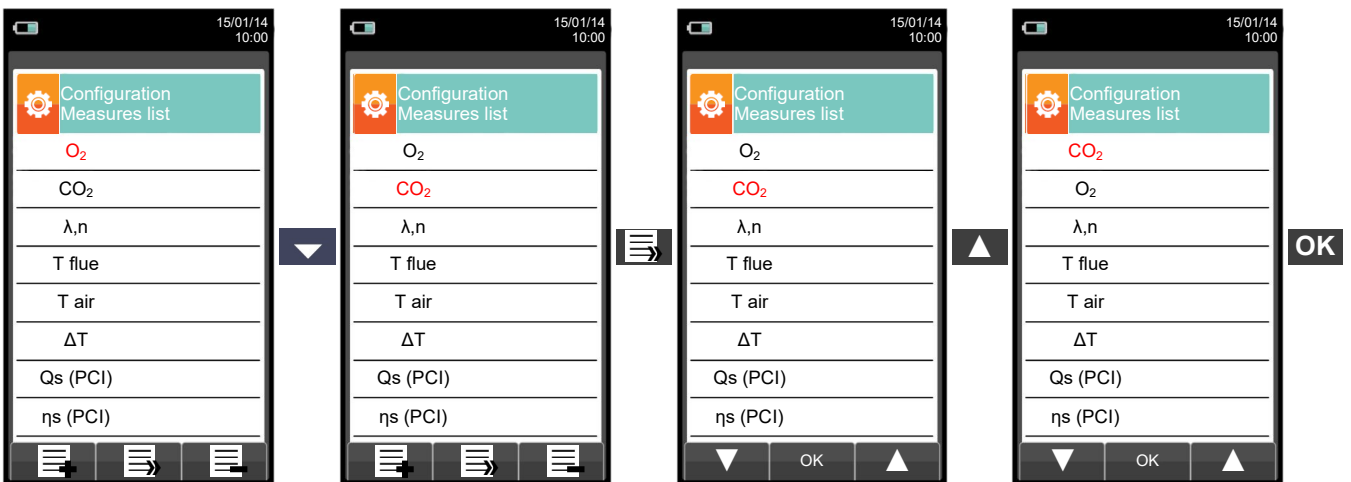

**3. Delete a measurement from the list - example**

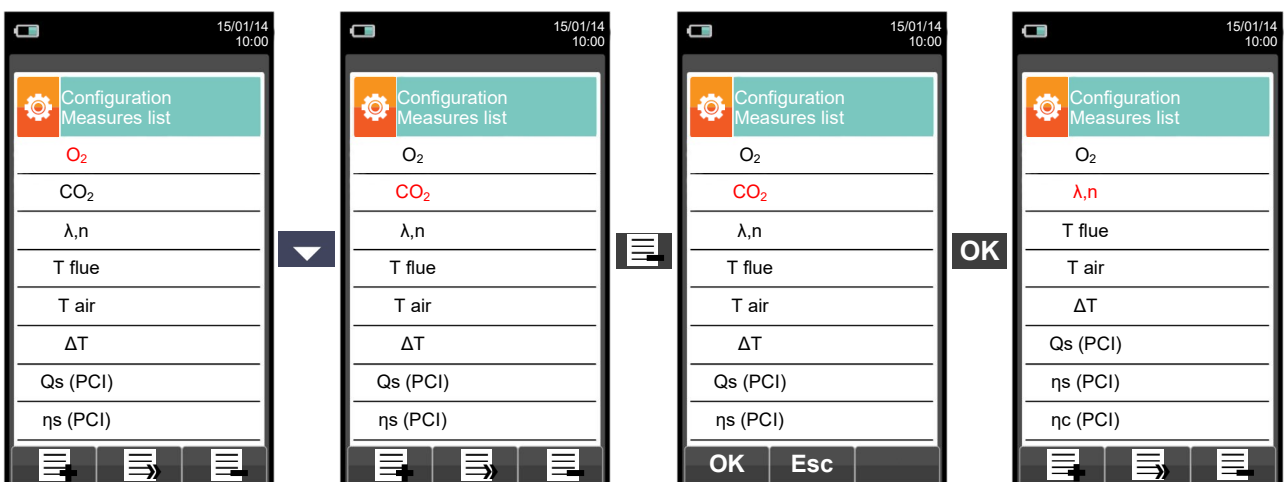

## 9.2.8 Configuration→Analysis→Air temperature

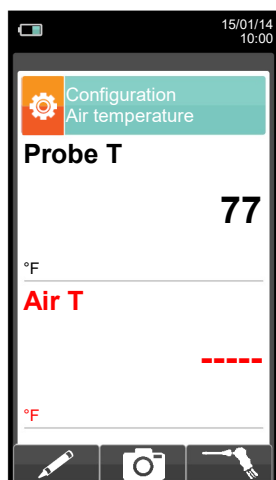
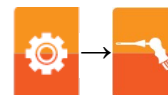

KEY	FUNCTION
	Activate the context keys shown on the display.
	When in modify mode, sets the desired value.
	Activates the context key located in the left side of the display.
	Returns to the previous screen without saving the changes made.

CONTEXT KEY	FUNCTION
	Accesses the Editing mode of the parameter 'Air T': it is possible to enter the desired value of the combustion air temperature that will be used in the combustion analysis.
	It saves the value, acquired or entered in the parameter 'Air T'.
	Acquires the temperature value detected from the sampling probe. That value is reported in the parameter 'Air T'.
	Confirms the operation.

### 9.3 Configuration→Instrument

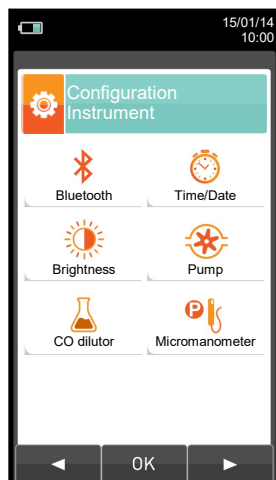
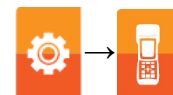

KEY	FUNCTION
	Activate the context keys shown on the display.
	Returns to the previous screen.

CONTEXT KEY	FUNCTION
	Selects the available parameters.
	Enters in the selected parameter setting.
	Selects the available parameters.

PARAMETER	DESCRIPTION
 Bluetooth	<p>Through this sub menu the user can turn on and off the instrument Bluetooth wireless communication with a PC or PDA.</p> <div style="border: 1px solid black; padding: 5px; text-align: center;"> <b>WHEN THE INSTRUMENT BLUETOOTH INTERFACE IS TURNED ON, THE BATTERY LIFE IS REDUCED DOWN TO 10 HOURS.</b> </div> <p><a href="#">SEE SECTION 9.3.1.</a></p>
 Time/Date	<p>This allows the current time and date to be set. The user can select the date and hour format either in EU (European) or USA (American) mode.</p> <p><a href="#">SEE SECTION 9.3.2.</a></p>
 Brightness	<p>The display contrast may be increased or decreased by acting on cursor keys. This operation may be performed even when the introductory screen is active.</p> <p><a href="#">SEE SECTION 9.3.3.</a></p>
 Pump	<p>In this sub menu the user can turn the gas suction pump off or back on. Also, if the pump is on, the user can view the flow of the pump in liters per minute. It is not possible to turn off the pump during an autozero cycle.</p> <p><a href="#">SEE SECTION 9.3.4.</a></p>
 CO dilutor	<p>The CO sensor is protected by a pump which, in case of need, can inject clean air in the gas path in order to dilute the gas concentration measured by the sensor. This function can be either triggered by the overcoming of a CO concentration threshold which can be set by the user or, in case it is known that the flue gases contain high CO concentration, kept enabled any time, independently of CO concentration.</p> <div style="border: 1px solid black; padding: 5px; text-align: center;"> <b>CO Auto-Dilution feature must only be considered as a means of protection for CO sensor, as its activation heavily deteriorates both accuracy and resolution of the CO measurement.</b> </div> <p><a href="#">SEE SECTION 9.3.5.</a></p>
 Micromanometer	<p>Allows to configure the micro manometer input (optional) as P+ or P- port. In case P- is selected, the sign of pressure is inverted.</p> <p><a href="#">SEE SECTION 9.3.6.</a></p>

### 9.3.1 Configuration → Instrument → Bluetooth

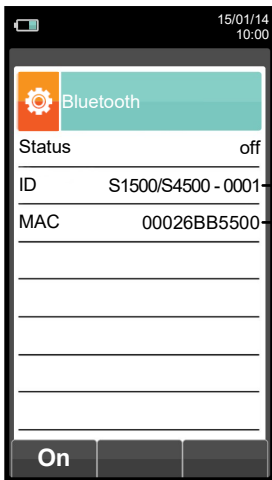

Bluetooth enabling / disabling  
 Instrument name  
 MAC address detected

KEY	FUNCTION
	Activate the context keys shown on the display.
	Also activates the context key shown on the display.
	Returns to the previous screen.

CONTEXT KEY	FUNCTION
	Turns on Bluetooth communication.
	Turns off Bluetooth communication.

### 9.3.2 Configuration→Instrument→Time/Date

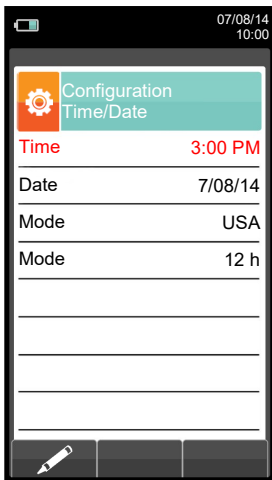

- ▶ Time, in the chosen format
- ▶ Date, in the chosen format
- ▶ Date format: USA (American) or EU (European)
- ▶ Time format: 12h or 24h

KEY	FUNCTION
	Activate the context keys shown on the display.
	When in modify mode, sets the desired value.
	Enters edit mode of the selected element and then confirms the change.
	When pressed in modify mode cancels the selection made, otherwise returns to the previous screen.

CONTEXT KEY	FUNCTION
	Enters edit mode of the selected parameter.
	Confirms the modification.

### 9.3.3 Configuration→Instrument→Brightness



KEY	FUNCTION
	Activate the context keys shown on the display.
	Increases or decreases the brightness of the display.
	Confirms the modification.
	When pressed in modify mode cancels the selection made, otherwise returns to the previous screen.

CONTEXT KEY	FUNCTION
	Decreases the brightness of the display.
	Confirms the setting.
	Increases the brightness of the display.



### 9.3.4 Configuration→Instrument→Pump

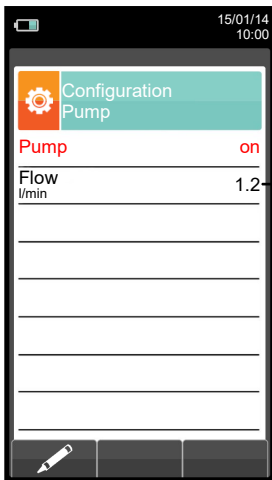

Displays the flow of the pump, expressed in litres per minute.

KEY	FUNCTION
	Activate the context keys shown on the display.
	When in modify mode, sets the desired value.
	Enters edit mode of the selected element and then confirms the change.
	When pressed in modify mode cancels the selection made, otherwise returns to the previous screen.

CONTEXT KEY	FUNCTION
	Enters edit mode: it is possible to turn the gas suction pump on or off.
	Confirms the modification.

### 9.3.5 Configuration→Instrument→CO dilutor

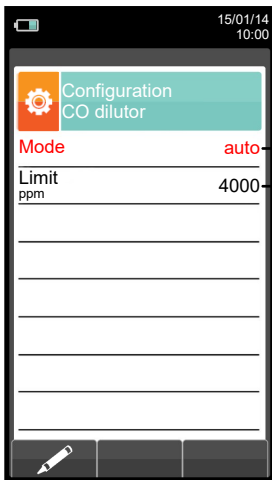

Available settings: auto, on or off  
 Threshold that activates the dilution pump (available only if the "Mode" parameter is set to "auto").

KEY	FUNCTION
	Activate the context keys shown on the display.
	Select each line displayed (the line selected is red). In edit mode, it sets the desired value.
	Enters edit mode of the selected element and then confirms the change.
	When pressed in modify mode cancels the selection made, otherwise returns to the previous screen.

CONTEXT KEY	FUNCTION
	Enters edit mode of the selected parameter.
	Confirms the modification.

### 9.3.6 Configuration→Instrument→Micromanometer

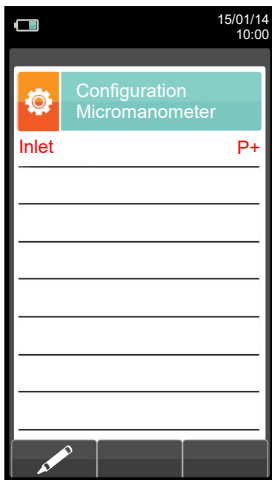

→ Sets the input used for the test: P+ o P-

KEY	FUNCTION
	Activate the context keys shown on the display.
	In edit mode, it sets the desired input.
	Enters edit mode of the selected element and then confirms the change.
	When pressed in modify mode cancels the selection made, otherwise returns to the previous screen.

CONTEXT KEY	FUNCTION
	Enters edit mode of the selected parameter.
	Confirms the modification.

## 9.4 Configuration→Operator

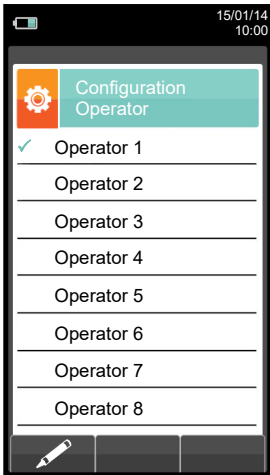
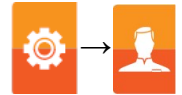

KEY	FUNCTION
	Activate the context keys shown on the display.
	In "edit text": Moves the cursor on the box corresponding to the letter or number required to form the word.
	In "Operator Configuration": Scrolls through the available operators.
	In "edit text": Confirms text input. In "Operator Configuration": selects the operator who will carry out the analysis; the operator is highlighted with the symbol "✓".
	Returns to the previous screen. In "edit mode" goes back to the previous screen without saving the changes made.

CONTEXT KEY	FUNCTION
	Enters edit mode of the selected line: it is possible to enter the name of the operator (24 characters available).
	Confirms the selected letter or digit.
	Cancel the letter or digit before the cursor.
	Cycles through uppercase, lowercase, symbols and special characters.

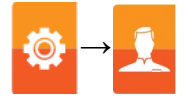

## Example:

### 1. Edit text

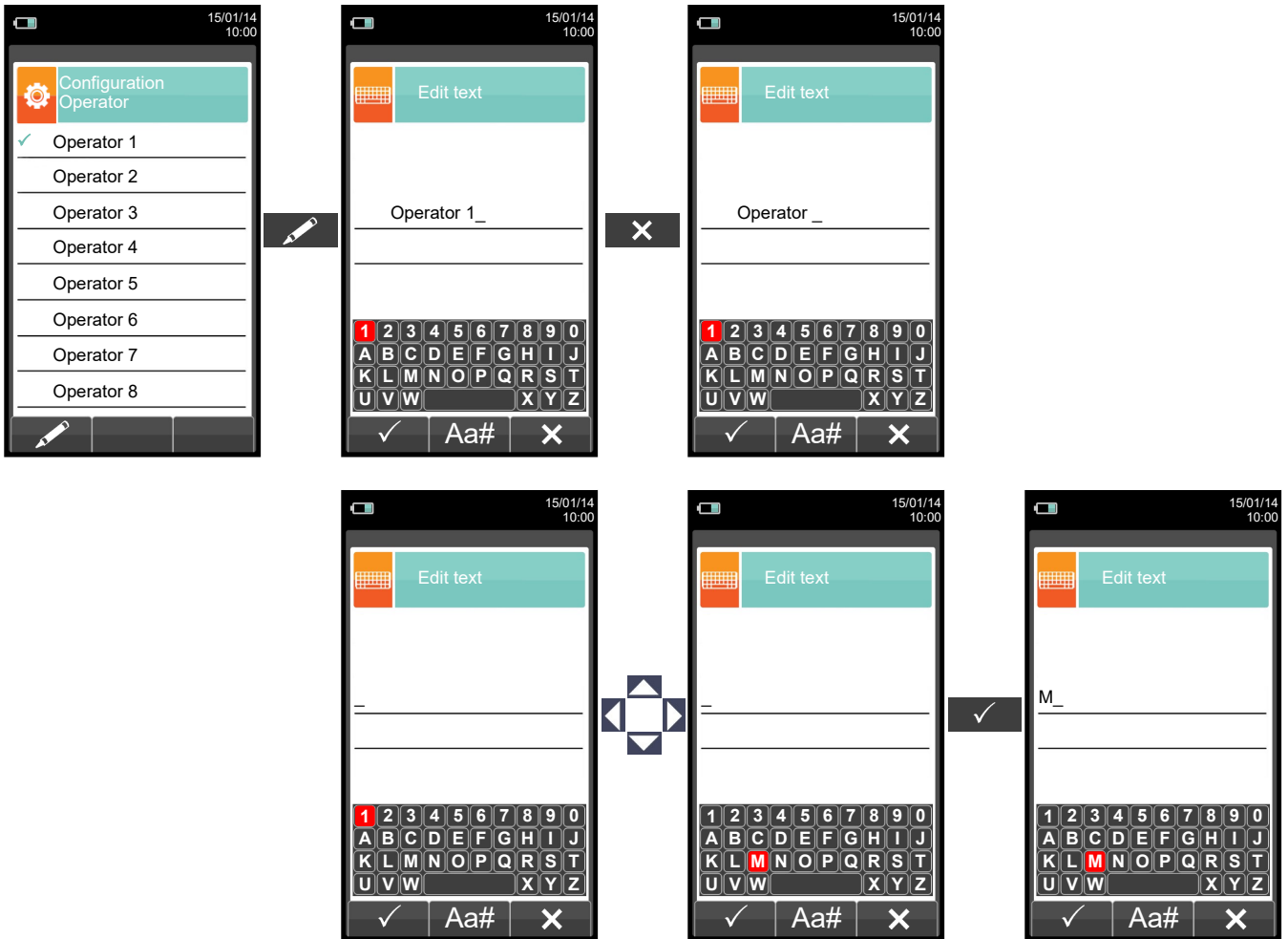

### 2. Select the operator who will carry out the analysis

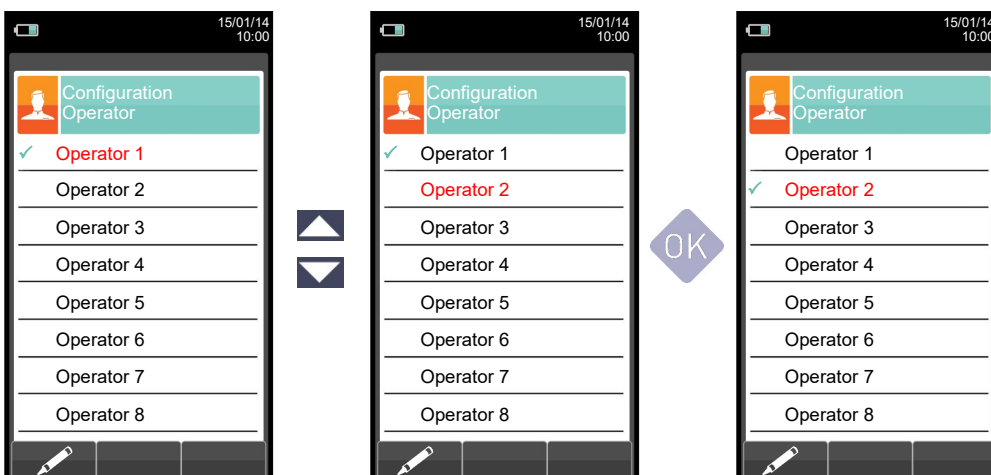

## 9.5 Configuration → Alarm

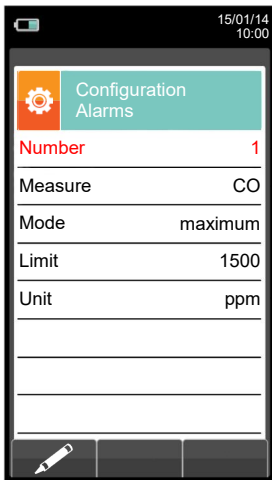

- ▶ Number of the alarm set
- ▶ Monitored parameter: O<sub>2</sub> - CO - NO - NO<sub>2</sub> - P diff - Plow - P ext - T1 - T2
- ▶ Type of alarm set: Maximum - Minimum - Off
- ▶ Threshold setting for the alarm: ±999999.999
- ▶ Measurement unit for the threshold set: ppm, mg/m<sup>3</sup>, mg/kWh, g/GJ, g/m<sup>3</sup>, g/kWh, %, ng/J

KEY	FUNCTION
	Activate the context keys shown on the display.
	Keys '▲' and '▼' select any line shown on the display (the selected line is evidenced in red). When in modify mode, sets the desired value.
	Enters the modify mode for the selected parameter, then confirms the modification.
	When pressed in modify mode cancels the selection made, otherwise returns to the previous screen.

CONTEXT KEY	FUNCTION
	Enters the modify menu for the selected parameter.
	Confirms the modification.



**Alarm activation flow chart and suggested correctional actions**

Type MAX. alarm activation

Type MIN. alarm activation

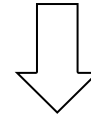
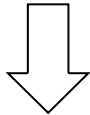

- Buzzer activation.
- The measure blinks on the display.

- Buzzer activation.
- The measure blinks on the display.

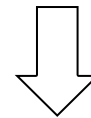
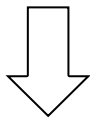

- Regulate the boiler correctly.
- The alarm is switched off automatically, if the gas concentration goes back below the set alarm threshold minus the hysteresis value.

- Regulate the boiler correctly.
- The alarm is switched off automatically, if the gas concentration is higher than the set alarm threshold plus the hysteresis value.

## 9.6 Configuration → Information

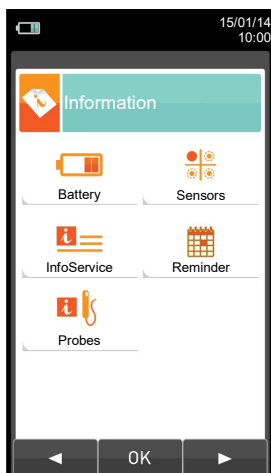

KEY	FUNCTION
	Activate the context keys shown on the display.
	Returns to the previous screen.

CONTEXT KEY	FUNCTION
	Selects the available parameters.
	Enters in the selected parameter setting.
	Selects the available parameters.

PARAMETER	DESCRIPTION
 Battery	Displays the state of charge of the internal battery. Displays the state of charge of the battery in percentage from 0 to 100%, both in text and graphically. <a href="#">SEE SECTION 9.6.1.</a>
 Sensors	It allows to check which sensors are installed on the instrument, and in which position they are installed. The instrument automatically detects whether a sensor has been either added or removed. The screen page allows whether to accept the new configuration or ignore the change performed. <a href="#">SEE SECTION 9.6.2.</a>
 Infoservice	This submenu contains details regarding the nearest Service Center to be contacted in the event of instrument fault or ordinary maintenance. The instrument model, serial number and firmware version are also displayed, thus allowing for a quick product identification. <a href="#">SEE SECTION 9.6.3.</a>
 Reminder	Accessing this menu you can see the calibration's expiration date of the instrument, inserted by factory or assistance center. <b>The menu is protected with a password: password is " 1111 ".</b> <a href="#">SEE SECTION 9.6.4.</a>
 Probes	Displays useful information on the probe connected to the serial cable connector visible in <b>E</b> in section 4.3 (Description of the Components of the Combustion Analyzer). <a href="#">SEE SECTION 9.6.5.</a>



### 9.6.1 Configuration→Information→Battery

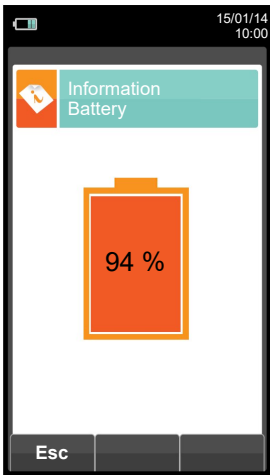

KEY	FUNCTION
	Activate the context keys shown on the display.
	Returns to the previous screen.

CONTEXT KEY	FUNCTION
	Returns to the previous screen.

## 9.6.2 Configuration→Information→Sensor

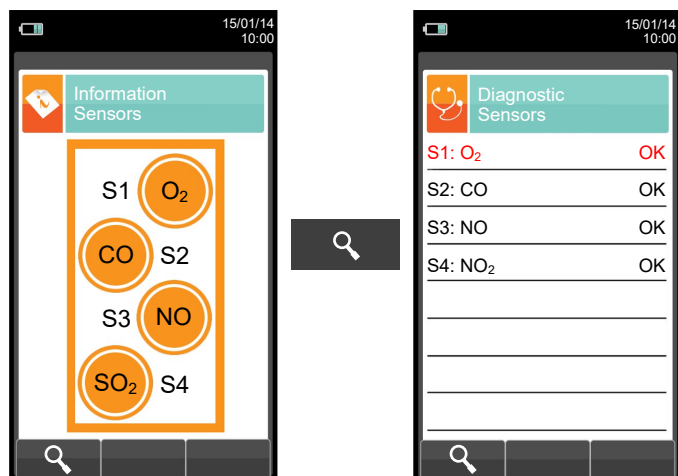
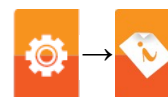

For further information, see [section 9.7.1](#).

KEY	FUNCTION
	Activate the context keys shown on the display.
	Returns to the previous screen.

CONTEXT KEY	FUNCTION
	Displays the details of the main features of the sensors installed.
	Returns to the previous screen.

This screen displays, for each position, the following messages (example referring to the sensor in position S3):

MESSAGE	DESCRIPTION
	Sensor configured OK (normal operation).
Flashing orange circle without writing indicating the gas detected	Sensor is not communicating or has been removed.
Flashing orange circle with writing indicating the gas detected	New sensor detected.
Flashing orange circle with writing indicating the new gas detected	Detected sensor different from the one previously installed.
	Detected sensor in wrong position.

### Error messages displayed:

MESSAGE	DESCRIPTION
Err cal	Calibration error.
Err dati	Sensor not recognized.
No cal	Sensor not calibrated.

### 9.6.3 Configuration → Information → InfoService

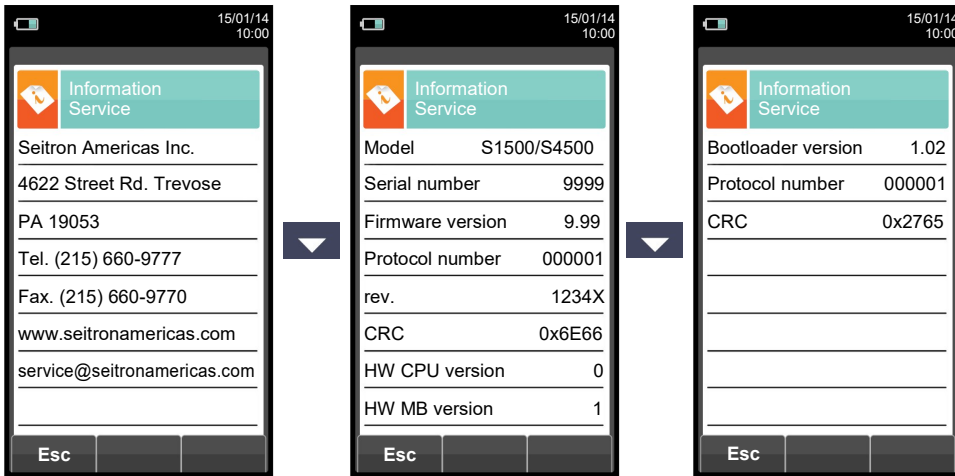
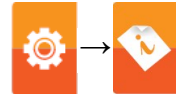

KEY	FUNCTION
	Activate the context keys shown on the display.
	Toggle view between next or previous screen.
	Returns to the previous screen.

CONTEXT KEY	FUNCTION
	Returns to the previous screen.

### 9.6.4 Configuration→Information→Reminder

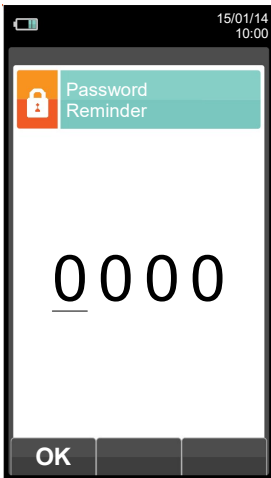

KEY	FUNCTION
	Activate the context keys shown on the display.
	Sets the password. The password is: 1111.
	Returns to the previous screen.

CONTEXT KEY	FUNCTION
	Confirm password and enter the menu "Reminder".
	Returns to the previous screen.
	Displays the information about the assistance center.
	Ignores temporarily the message. Next time the instrument will be turned on, the reminder will be displayed again.
	Ignores permanently the message.

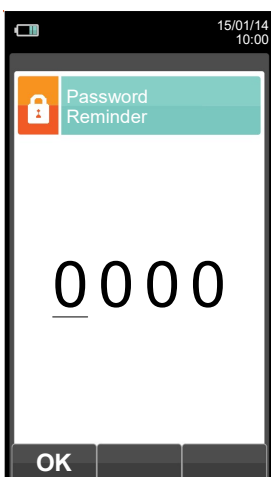

Enter the recalibration menu password 1111.

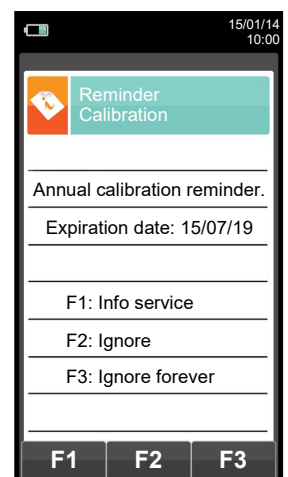

### 9.6.5 Configuration→Information→Probe

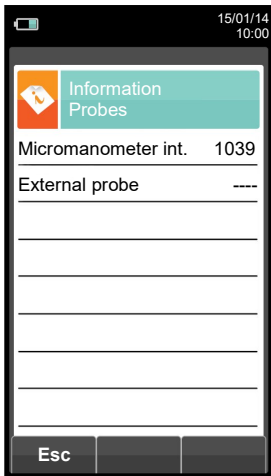

KEY	FUNCTION
	Activate the context keys shown on the display.
	Returns to the previous screen.

CONTEXT KEY	FUNCTION
	Returns to the previous screen.

## 9.7 Configuration → Diagnostic

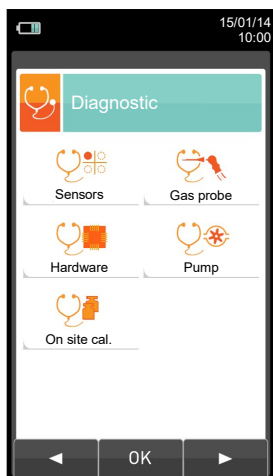
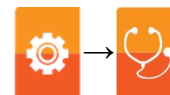

KEY	FUNCTION
	Activate the context keys shown on the display.
	Returns to the previous screen.

CONTEXT KEY	FUNCTION
	Selects the available parameters.
	Enters in the selected parameter setting.
	Selects the available parameters.

PARAMETER	DESCRIPTION
<p>Sensors</p>	<p>Displays information on the state and calibration of the electrochemical sensors:</p> <ul style="list-style-type: none"> <li><b>Ok</b> No problem detected</li> <li><b>absent</b> The sensor was not detected</li> <li><b>err data</b> Memory data error of the sensor</li> <li><b>unknown</b> It is necessary to update the FW of the device</li> <li><b>err pos</b> The sensor has been installed in the wrong position</li> <li><b>err cal</b> Calibration error (sensor not calibrated)</li> <li><b>err curr</b> Currents outside the range</li> <li><b>err cfg</b> Do not use this sensor as it has not been accepted on the screen "types of sensors".</li> </ul> <p>Also, from this screen the user can access the identification data of the sensor: type, serial number, date of manufacture and calibration. There are also the measured currents; in this way it is possible to perform a quick diagnosis in the event of a malfunction.</p> <p><a href="#">SEE SECTION 9.7.1.</a></p>
<p>Gas probe</p>	<p>Tests the tightness of the gas probe pneumatic path.</p> <p><a href="#">SEE SECTION 9.7.2.</a></p>
<p>Hardware</p>	<p>At instrument turn on the firmware performs a full check on the physical efficiency of all types of HW memories installed on the instrument, as well as on the integrity of the data stored into them. Any issue is evidenced in the screen 'Memories Diagnostics'. Should this happen it is advisable to turn the instrument off and then on again. In case the problem is permanent or frequently recurring, the user should contact the Service Center reporting the error code shown by the instrument.</p> <p><a href="#">SEE SECTION 9.7.3.</a></p>
<p>Pump</p>	<p>In this submenu the user can temporarily turn the gas suction pump on or off. Also, it is possible to view the actual flow rate of the pump in liters per minute. It will not be possible to turn off the pump during an autozero cycle.</p> <p><a href="#">SEE SECTION 9.7.4.</a></p>
<p>On site cal.</p>	<p>It is possible to make a recalibration of the instrument's gas sensors with suitable known concentration gas cylinders.</p> <p>For the sensors which are sensitive to other gases, called interfering gases (for example SO<sub>2</sub>), it is possible to perform the on-site calibration also for the related interfering gas.</p> <p><b>The sensor recalibration procedure is protected by password: ask Seitron Assistance center.</b></p> <p><a href="#">SEE SECTION 9.7.5.</a></p>

### 9.7.1 Configuration → Diagnostic → Sensors

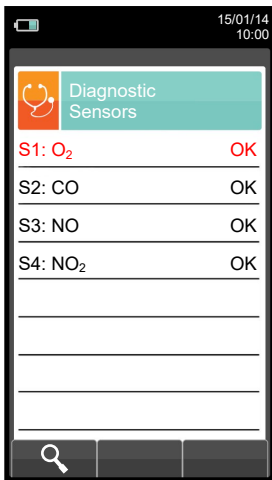

KEY	FUNCTION
	Activate the context keys shown on the display.
	Selects the fuel.
	Activates the context keys located in the left side of the display.
	Returns to the previous screen.

CONTEXT KEY	FUNCTION
	Displays the details of the selected sensor (see example below).
	Returns to the previous screen.

Example:

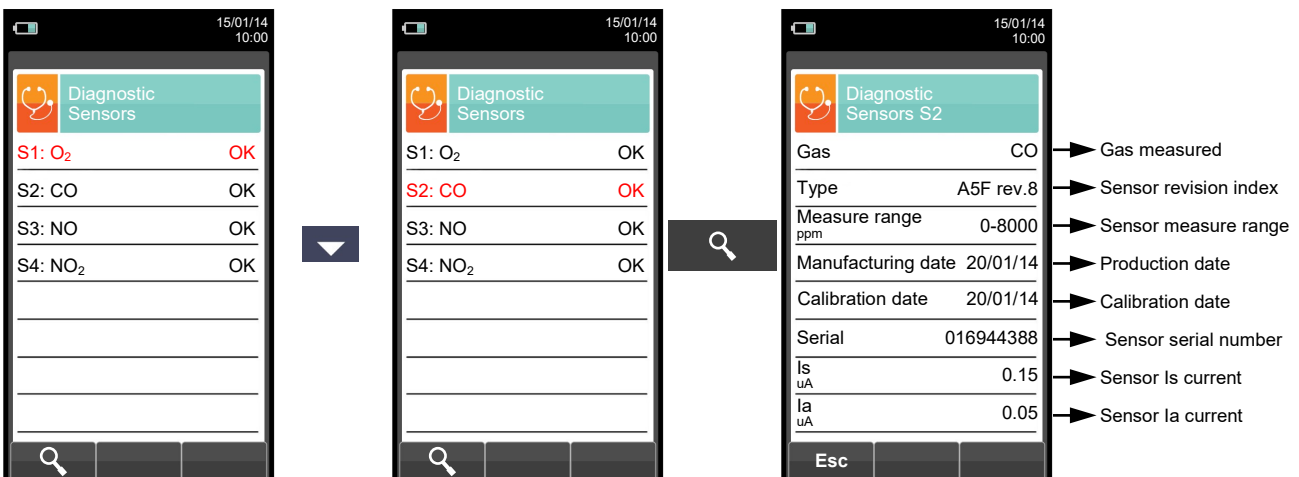



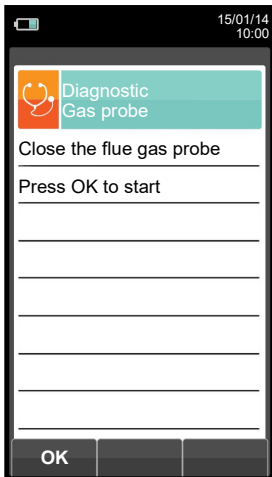

## 9.7.2 Configuration → Diagnostic → Gas probe

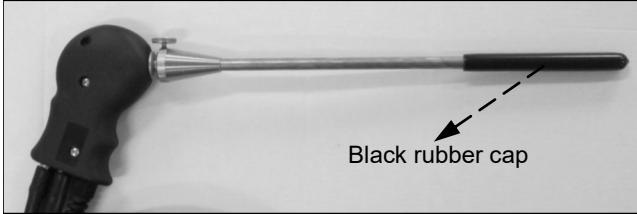

Connect the flue gas sampling probe and filter unit assembly to the instrument;  
Fully insert the black rubber cap on the gas probe tip, as shown in the following picture:

KEY	FUNCTION
	Activate the context keys shown on the display.
	Activates the context key located in the left side of the display.
	Returns to the previous screen.

CONTEXT KEY	FUNCTION
	Starts the test to check the tightness of the gas sampling probe.
	Starts the test of the gas sampling probe.

### Tightness test of the probe.

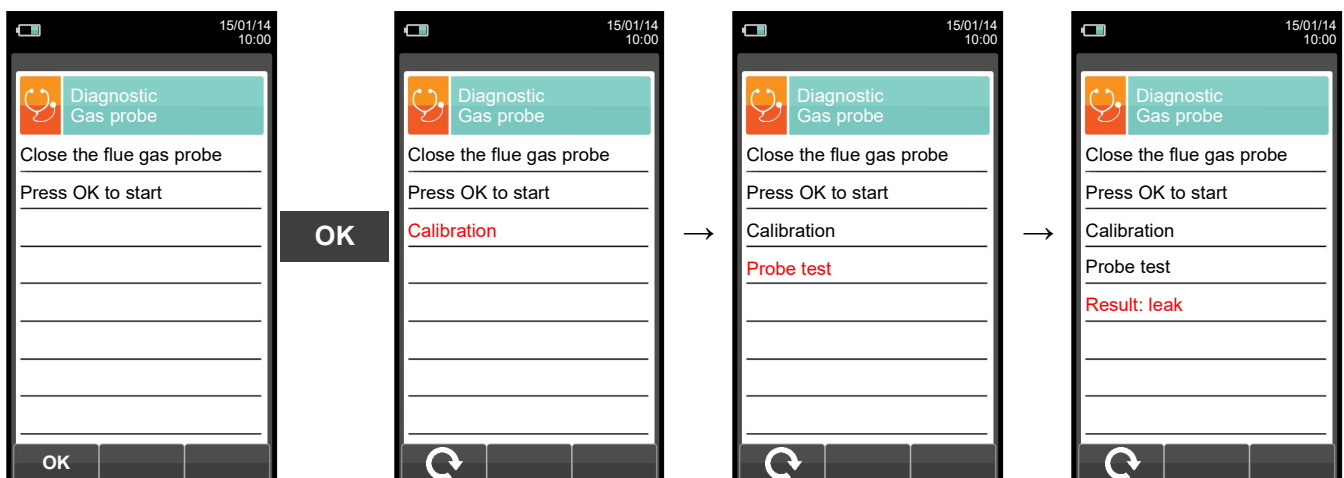

#### Results:

**Tightness:** The system is OK

**Error:** Make sure that the probe is connected to the input P-, check the seals of the pneumatic connections and/or the seal of the condensation trap and check that the test cap is correctly inserted on the tip of the probe. **WARNING: a damaged probe tip may impair the test.**



### 9.7.3 Configuration → Diagnostic → Hardware

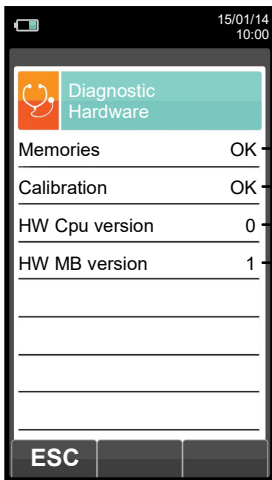
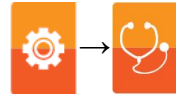





- State of memory.
- State of calibration.
- Version of CPU board
- Version of motherboard

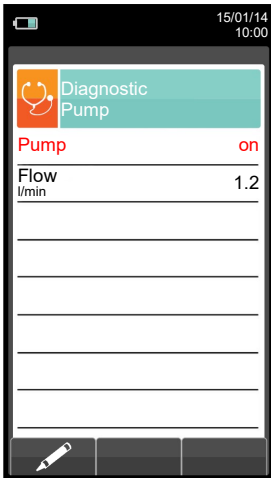
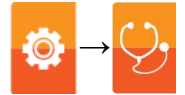

KEY	FUNCTION
	Activate the context keys shown on the display.
	Returns to the previous screen.

CONTEXT KEY	FUNCTION
	Returns to the previous screen.

## 9.7.4 Configuration→Diagnostic→Pump



KEY	FUNCTION
	Activate the context keys shown on the display.
	In edit mode, cycling between on and off.
	Enters edit mode of the selected element and then confirms the change.
	Returns to the previous screen.

CONTEXT KEY	FUNCTION
	Enters edit mode: it is possible to turn the gas suction pump on and off.
	Confirms the modification.

9.7.5 Configuration→Diagnostic→On site cal.

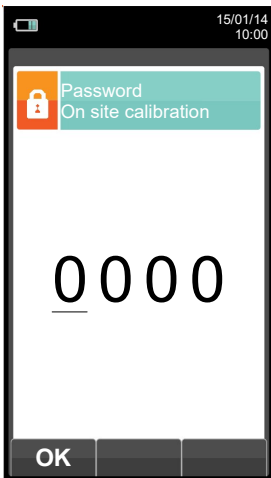
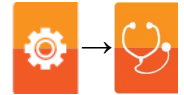

KEY	FUNCTION
	Activate the context keys shown on the display.
	Sets the password.
	Selects line; the selected line is evidenced in red. In modification sets the value or the desired mode.
	Activates the context key located in the left side of the display.
	Returns to the previous screen. When in modify mode cancels the modification just made.

CONTEXT KEY	FUNCTION
	Once password is entered, gives access to the 'On site calibration' menu.
	Shows details for the selected sensor.
	Zeroes the timer.
	Enters the modification mode for the selected parameter.

## 9.7.6 Calibration procedure

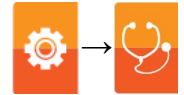

In order to perform the calibration, the following tools are needed:

- Test gas cylinder with certified gas concentration suitable for the concerned sensor, equipped with a pressure regulator.
- Flow meter.
- Hose with ' T ' shaped junction, in order to connect the cylinder to the instrument and the flow meter.

Following, the suggested stabilization times for the sensors on-site calibration.

O <sub>2</sub> sensor:	from 3 to 5 minutes
CO sensor:	from 3 to 5 minutes
NO sensor:	from 3 to 5 minutes
SO <sub>2</sub> sensor:	from 5 to 8 minutes
NO <sub>2</sub> sensor:	from 5 to 8 minutes
CxHy sensor:	from 3 to 5 minutes
CO <sub>2</sub> sensor:	from 3 to 5 minutes



### WARNING!

For the oxygen sensor on site calibration, the zero value calibration must be carried out with nitrogen or any other gas mixture which **DOES NOT** contain oxygen.

### 1. Start the instrument



**WARNING**

- Make sure autozero is execute in clean air and terminates correctly.
- Do not connect the gas probe to the instrument.
- Check the battery charge level or connect the power adapter to avoid data loss during recalibration.

### 2. Once autozero is completed press the key and select the diagnostic icon.

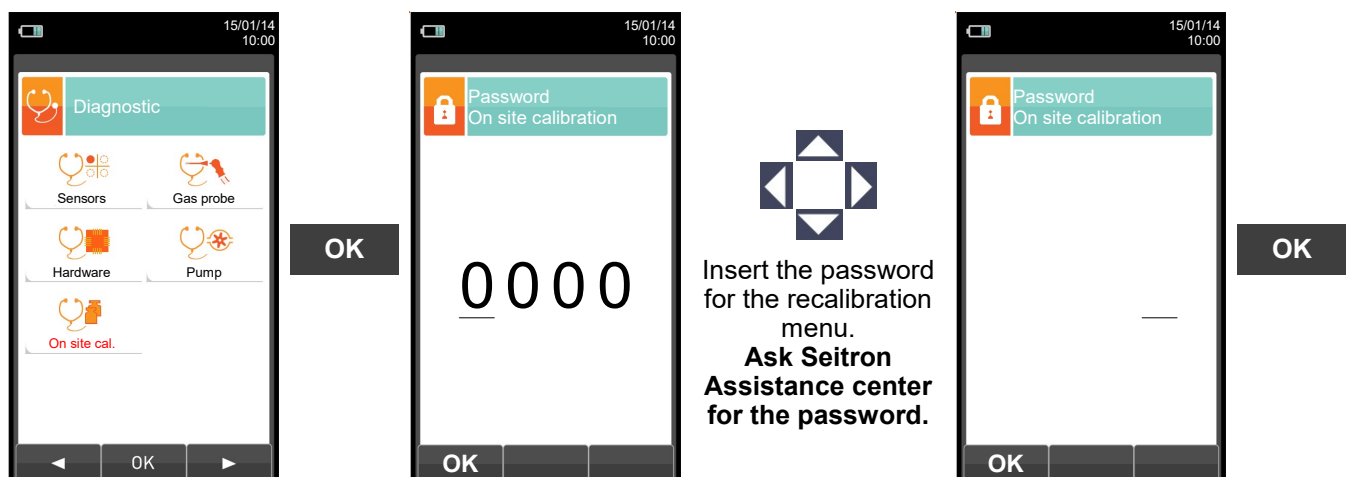

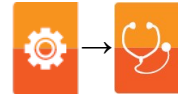

3. Once in the 'On site calibration' menu, is shown the list of the installed sensors for which the recalibration is available.

By selecting a sensor, on the recalibration screen are shown all the information related to the latest calibration.

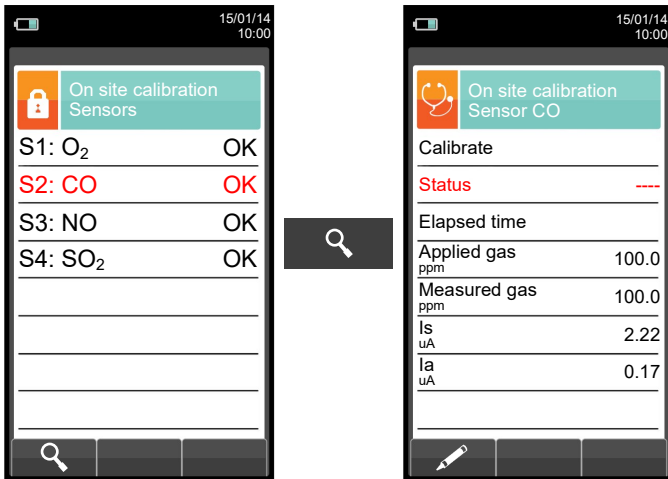

- Calibrate:** saves new calibration
- Status:** not active: returns to the factory calibration  
active: returns to the last calibration made by the user  
----: no 'on site calibration' has been previously stored
- Elapsed time:** timer
- Applied gas:** enters the concentration of the applied calibration gas
- Measured gas:** measures the concentration of the applied gas
- Is:** 'Is' current from the sensor
- Ia:** 'Ia' current from the sensor (available only on the CO sensor calibration)

**CHOOSE THE SENSOR TO BE CALIBRATED AND DO AS FOLLOWS**

4. Connect the known concentration gas cylinder to the instrument as shown in the following diagram:

**WARNING!**  
Adequate ventilation must be provided when working with toxic gases, particularly the flow meter and instrument outputs must be evacuated by a ventilation system.

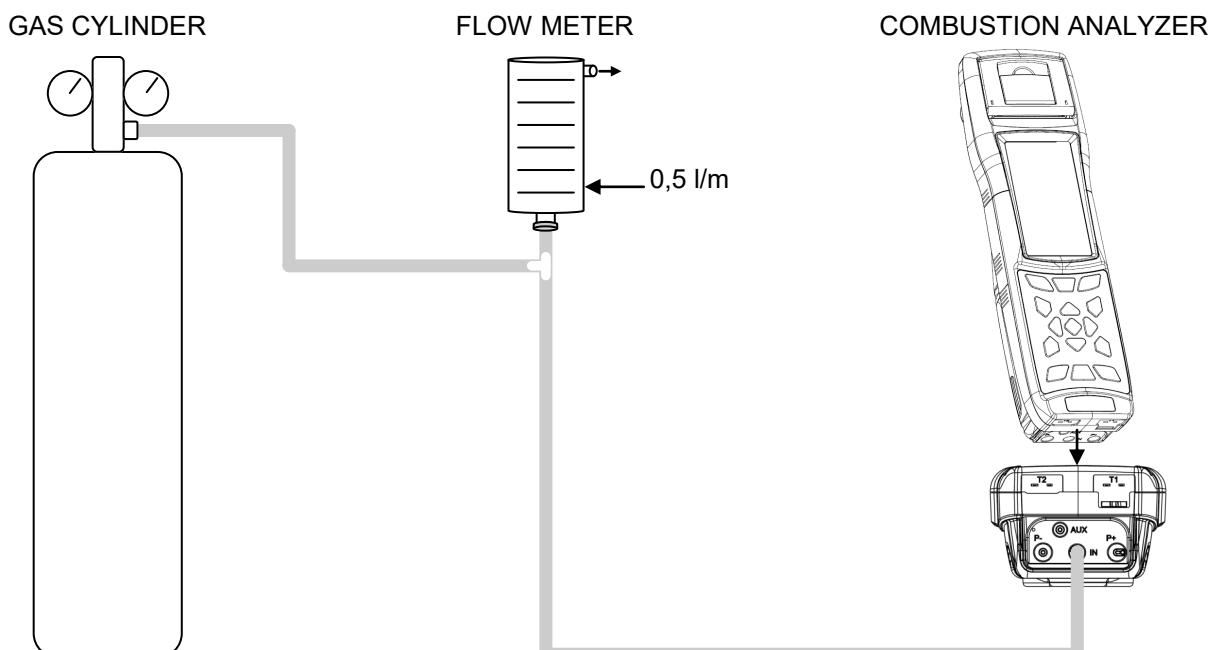

## OXIGEN SENSOR (O<sub>2</sub>) CALIBRATION DETAIL

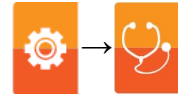

- The calibration is **possible** only when the status is set to '----' (sensors that have never been calibrated before) otherwise it is necessary to set the status on 'non active' (see example below).

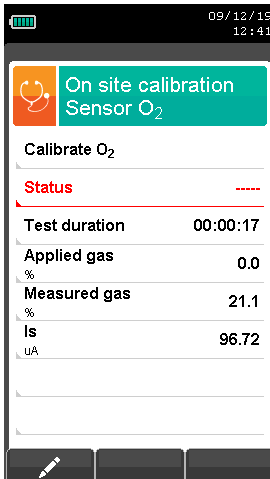

OR

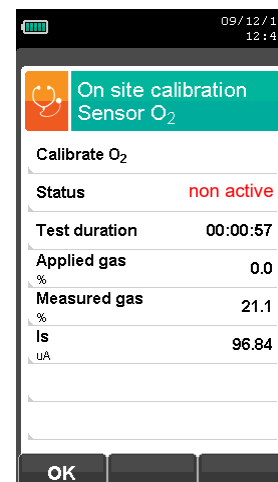
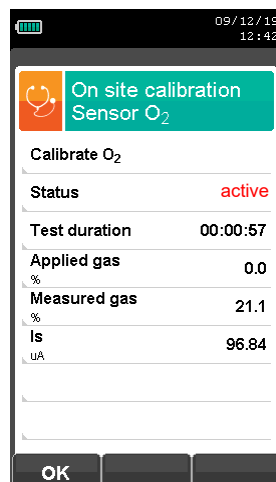
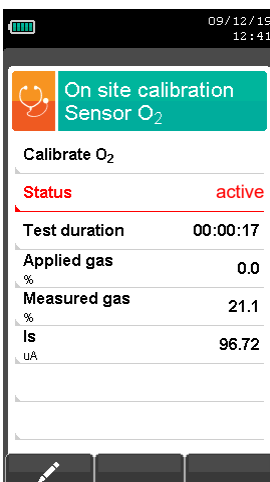

- Apply gas to the instrument** and adjust the output pressure of the gas from the cylinder so that the flow meter indicates a minimum flow of 0.5 l/m: this guarantees that the instrument is taking the exact amount of gas required by the internal pump.
- The instrument measures the concentration of gas applied; **wait at least 3 minutes to allow the reading to stabilize.** The reading is shown in line 'Gas measured'.

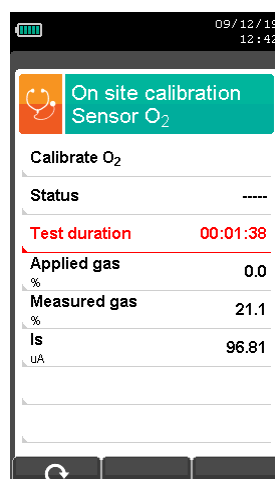
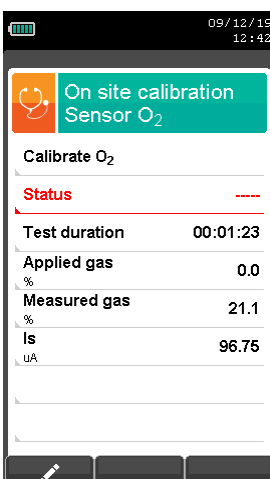

Zeroes the timer - helps to keep under control the time elapsing during the stabilization phase.

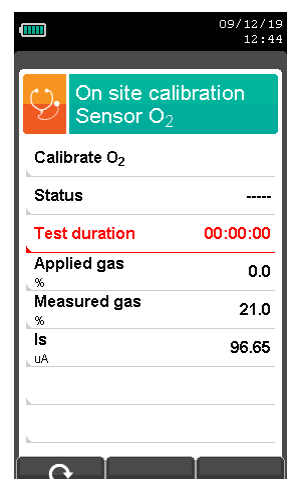

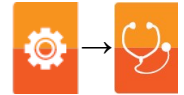

- When the stabilization time is over, select the row 'Calibrate' and store the new calibration.

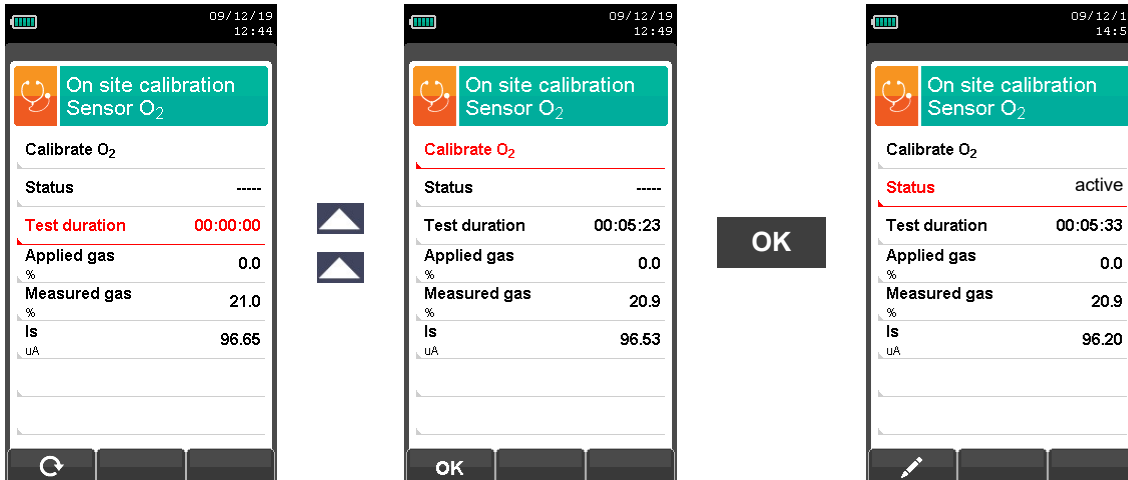

Messages in the 'Status' line:

**saving:** the instrument is saving the performed calibration

**error:** the sensor has NOT been recalibrated for any of the following reasons:

- The calibration gas cannot properly reach the instrument.
- Concentration for the calibration gas has not been set in the relevant line 'Applied gas'.
- The user didn't allow for the stabilization time to properly elapse.
- The sensor could be damaged or exhausted and must therefore be replaced.



**WARNING**

- At any time the user can restore the factory calibration in the instrument by setting the 'Status' line on 'not active'.
- The advised stabilization time for the on-site calibration of the sensors, is 3 minutes. For NO2 and SO2 sensors this time can be up to 5 minutes.

**SENSOR CALIBRATION DETAIL FOR TOXIC GASES (EXAMPLE REFERRED TO CO).**



- The calibration is **possible** only when the status is set to '----' (sensors that have never been calibrated before) otherwise it is necessary to set the status on 'non active' (see example below).

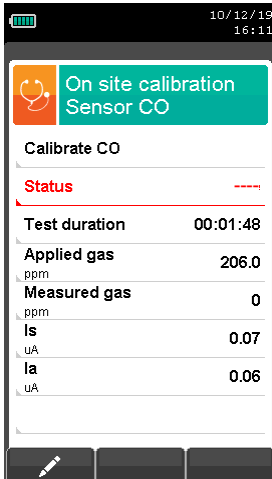

OR

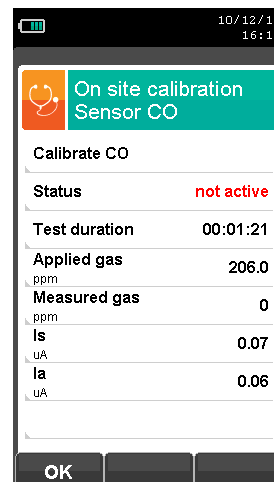
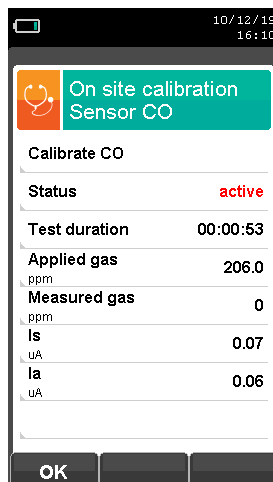
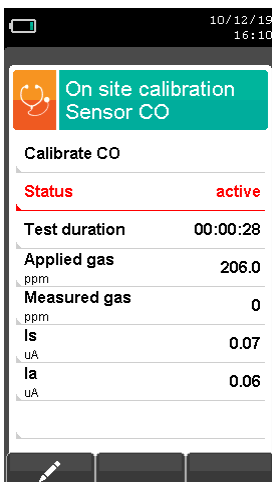

- Enter the value of the concentration of the gas applied.

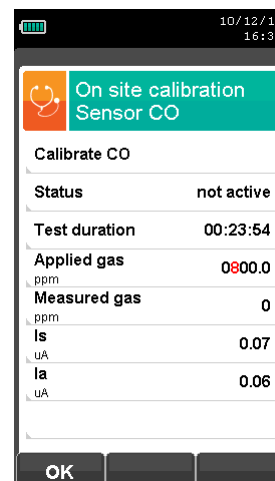
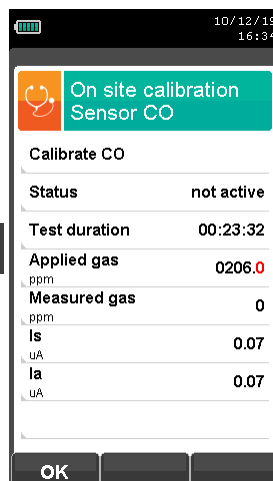
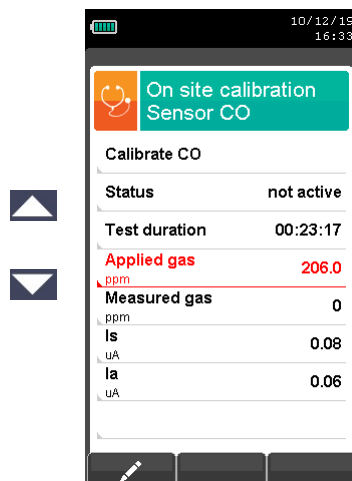

- Apply gas to the instrument and adjust the output pressure of the gas from the cylinder so that the flow meter indicates a minimum flow of 0.5 l/m: this guarantees that the instrument is taking the exact amount of gas required by the internal pump.





- The instrument measures the concentration of gas applied; **wait at least 3 minutes to allow the reading to stabilize**. The reading is shown in line 'Gas measured'.



  
 Zeroes the timer - helps to keep under control the time elapsing during the stabilization phase.

- When the stabilization time is over, select the row 'Calibrate' and store the new calibration.



Messages in the 'Status' line:

- saving:** the instrument is saving the performed calibration
- error:** the sensor has NOT been recalibrated for any of the following reasons:
- The calibration gas cannot properly reach the instrument.
  - Concentration for the calibration gas has not been set in the relevant line 'Applied gas'.
  - The user didn't allow for the stabilization time to properly elapse.
  - The sensor could be damaged or exhausted and must therefore be replaced.



**WARNING**

- At any time the user can restore the factory calibration in the instrument by setting the 'Status' line on 'not active'.
- The advised stabilization time for the on-site calibration of the sensors, is 3 minutes. For NO2 and SO2 sensors this time can be up to 5 minutes.

## SENSOR CALIBRATION DETAIL FOR TOXIC GASES WITH INTERFERING GASES

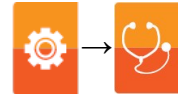

The sensors for toxic gases with interfering gases are those sensors which are sensible to other gases. The on-site calibration for these sensors allows to calibrate also the interfering gases.

The on-site calibration procedure for these sensors is the same described on the previous pages regarding the toxic gases and can be performed for all the interfering gases of the sensor itself.

The following procedure is for accessing the interfering gases of the sensor that must be recalibrated on-site (example referred to the SO<sub>2</sub> sensor).

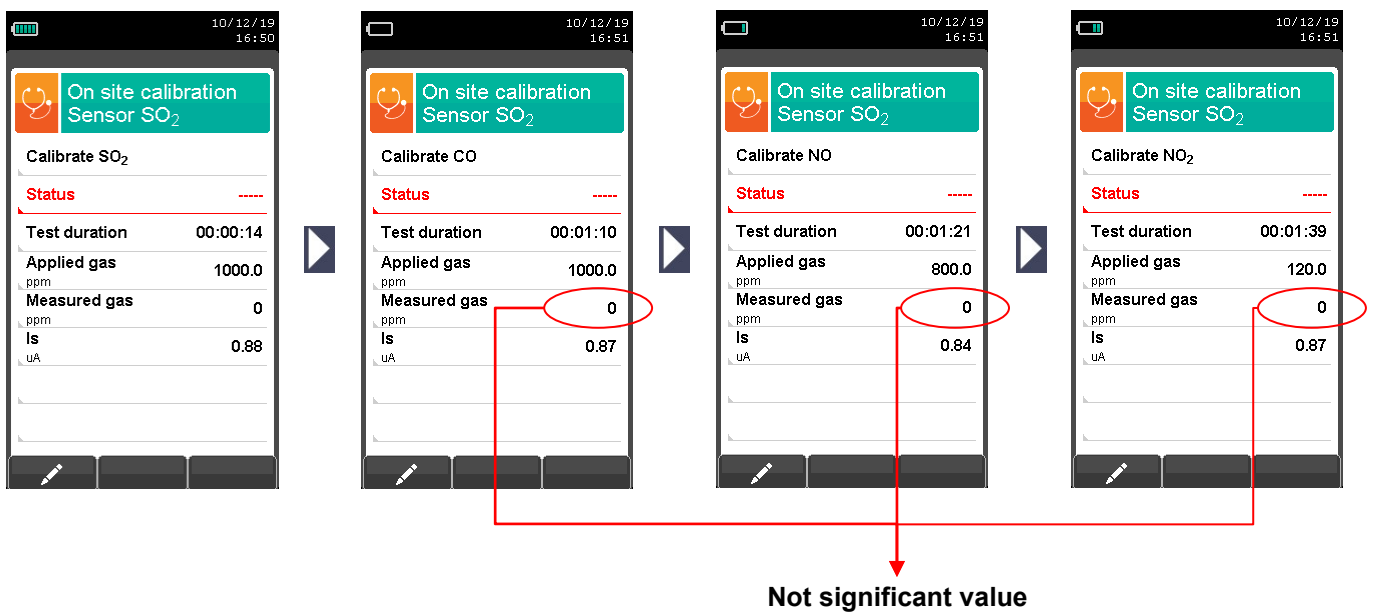

**WARNING**

- The stabilization time advised for the on-site calibration of these sensors is 5 minutes.



**WARNING**

When on analysis phase, the interfering gases are compensated only if on the instrument is also installed the sensor for the correspondent interfering gas.

## 9.8 Configuration → Language

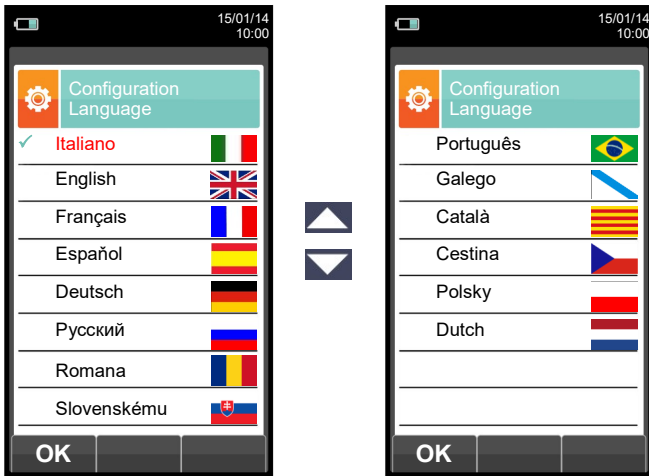

KEY	FUNCTION
	Activate the context keys shown on the display.
	Scrolls through the available languages.
	Sets the selected language.
	Returns to the previous screen.

CONTEXT KEY	FUNCTION
	Sets the selected language.



## 9.9 Configuration→Restore

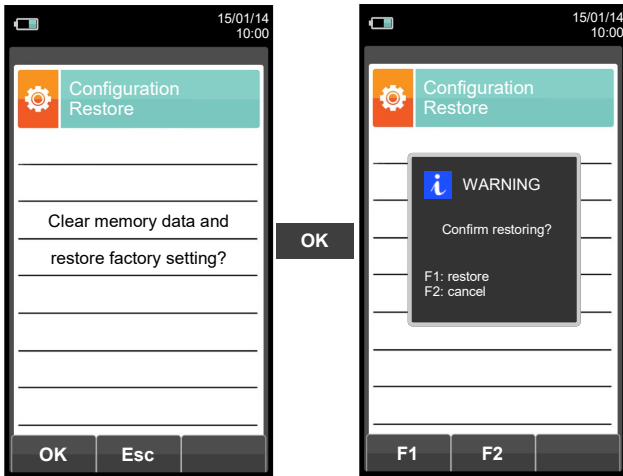

KEY	FUNCTION
	Activate the context keys shown on the display.
	Starts the factory data reset phase.
	Exits the current screen without resetting.

CONTEXT KEY	FUNCTION
	Starts the factory data reset phase.
	Exits the current screen without resetting.
	Factory reset.
	Cancels the factory data reset phase and goes back to the previous screen.

## 10.1 Memory Menu

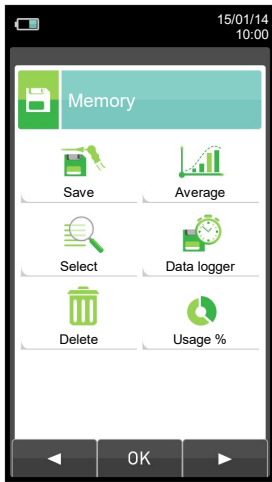



KEY	FUNCTION
	Activate the context keys shown on the display.
	Returns to the previous screen.

CONTEXT KEY	FUNCTION
	Selects the available parameters.
	Enters in the selected parameter setting.
	Selects the available parameters.

PARAMETER	DESCRIPTION
Save	From this screen the user can start the combustion analysis. The data shown summarizes the mode of analysis and the selected memory. <a href="#">SEE SECTION 10.2.</a>
Average	Allows the user to see the average of the analyses contained in the selected memory. <a href="#">SEE SECTION 10.3.</a>
Select	<ul style="list-style-type: none"> <li>- Allows the user to set the number of the memory to be used to save the combustion analysis and/or the measurement of the draft, carbon black, etc. For each memory it is possible to enter the personal information of the customer (name of the customer, address, telephone number, type of boiler, etc.).</li> <li>- Allows the user to see and print the stored analyses, individually or as an average. The analyses can be found (via the context key "find") by memory location or by the date they were saved; it is also possible to see the draft, carbon black and ambient CO. In the menu "Find Memory" the activation of the Print Memory is enabled only on the page where the analyses or the draft, carbon black and ambient CO data are displayed.</li> </ul> <a href="#">SEE SECTION 10.4.</a>
Data logger	<p>This submenu allows the user to define the mode of analysis and of memory selection:</p> <p><b>data logger</b></p> <p>This mode is entirely configurable by the user (it is necessary to set the number of samples to be acquired, the duration of acquisition of each sample and the printing mode).</p> <p>When the combustion analysis starts, the device will automatically carry out and store the number of samples set, spaced from one another according to the set time.</p> <p>After the combustion analysis (indicated by a beep), if the "Manual Print" mode has been selected, the device will display the average of the samples taken with the possibility to recall them individually; the user can then print them (total, complete, ...).</p> <p>On the contrary, if the user has selected the option "Automatic Print", the device will automatically proceed to print the analyses, according to the current printing settings, without displaying the average.</p>



 <p>Data logger</p>	<p><b>Warning: in automatic mode, the measurements of carbon black, draft and ambient CO must be taken before starting the combustion analysis.</b></p> <p><b>Manual analysis mode</b>                  If the user chooses the manual mode, he will perform the combustion analysis manually; in this case, the settings regarding printing and duration of the automatic analysis will not be considered. At this point the user can start the manual analysis after waiting two minutes so that the displayed values are stable: then he can proceed to save or directly print the test ticket of the analysis, which will be prepared in accordance with the previously configured settings.                  At the end of the three analyses, the screen with the average can be displayed, which also contains all the data necessary to fill in the booklet of the system or plant.                  In both modes, manual and automatic, the data displayed regarding the pollutants CO / NO / NO<sub>x</sub> can be translated into normalized values (with reference to the concentration of O<sub>2</sub> previously set).</p> <p><b>Memory selection mode</b>  <b>Manual:</b> the memory will have to be selected manually via the parameter "Select"  <b>Auto:</b> the memory, to which the measurements and combustion analyses will be saved, will be suggested automatically when the device is turned on.  <a href="#">SEE SECTION 10.5.</a></p>
 <p>Delete</p>	<p>Allows the user to delete the contents of each memory or of the entire 99 memories.  <a href="#">SEE SECTION 10.6.</a></p>
 <p>Usage %</p>	<p>The user, through this menu, can view the percentage of memory usage.  <a href="#">SEE SECTION 10.7.</a></p>

## 10.1.1 Memory Organization

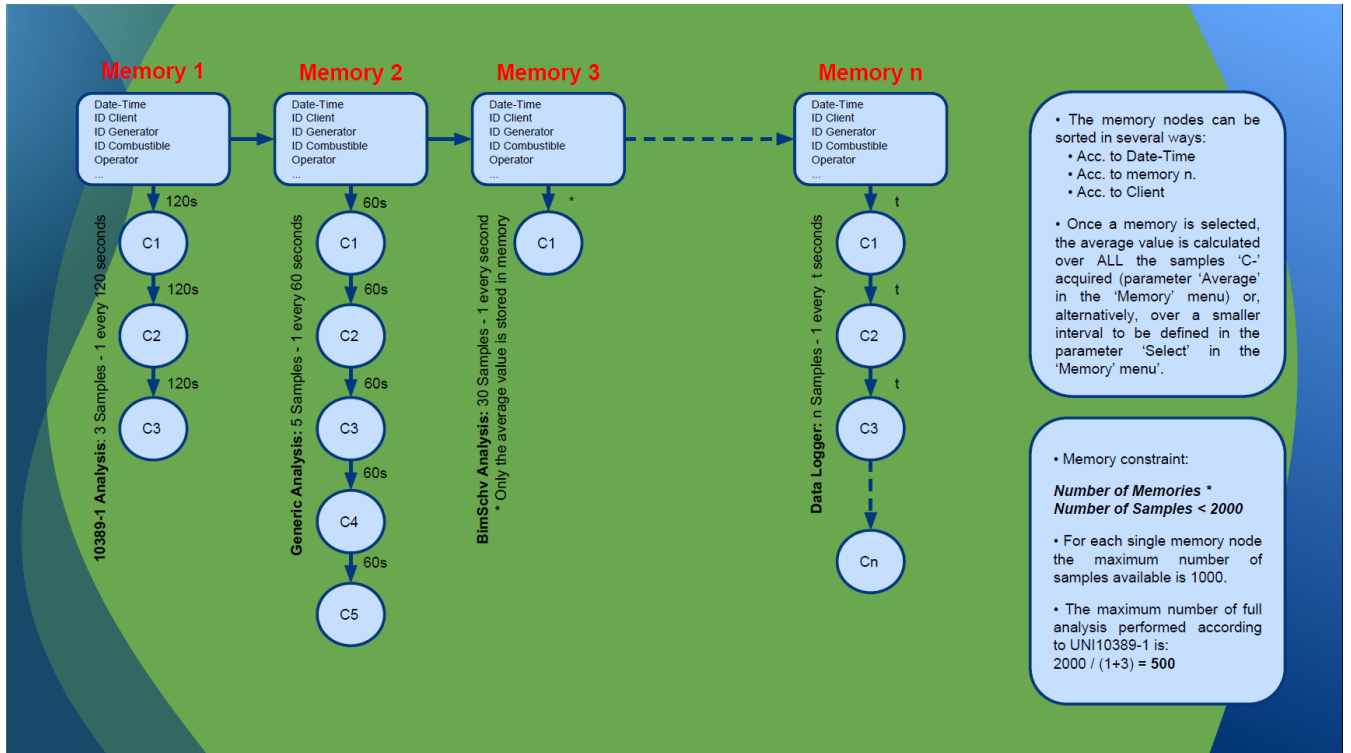

## 10.2 Memory Menu → Save

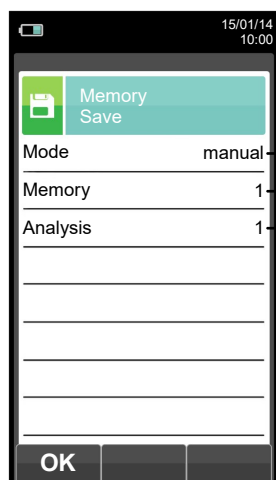

Manual analysis mode  
 Number of selected memory  
 Number of analyses carried out

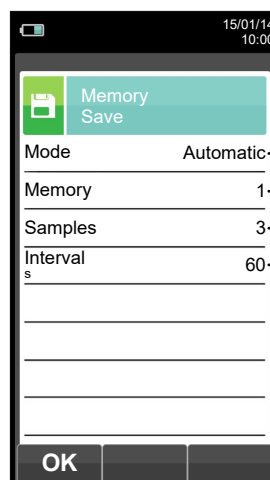

Automatic analysis mode  
 Number of selected memory  
 Number of samples to take  
 Interval between samples

KEY	FUNCTION
	Activate the context keys shown on the display.
	Starts saving the combustion analysis according to the mode set in the parameter 'Data logger'.
	Returns to the previous screen.

CONTEXT KEY	FUNCTION
	Starts saving the combustion analysis according to the mode set in the parameter 'Data logger'.
	Deletes the contents of the selected memory. (Visible when the selected memory contains previous analyses).
	Cancels the deletion of the contents of the selected memory. (Visible when the selected memory contains previous analyses).





**Example 1: Saving the combustion analysis in manual mode**

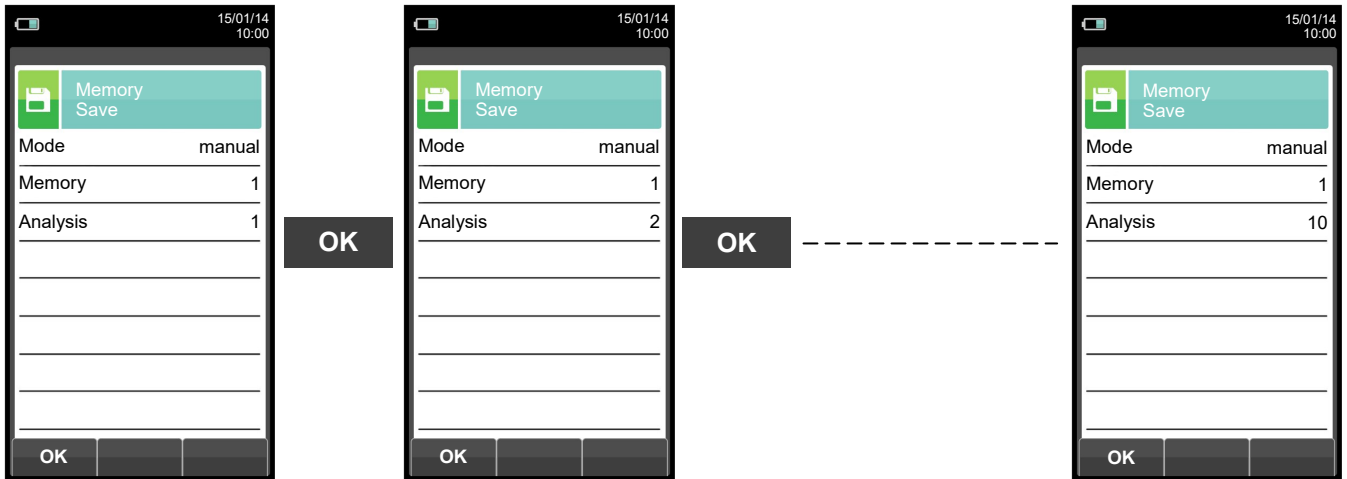



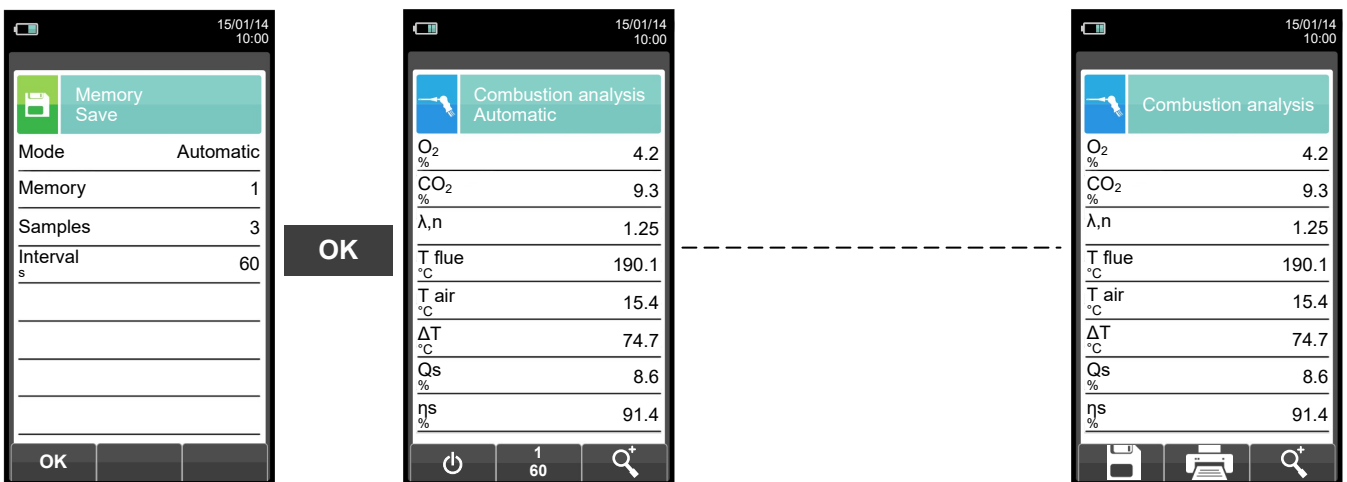

**Example 2: Saving the combustion analysis in automatic mode**



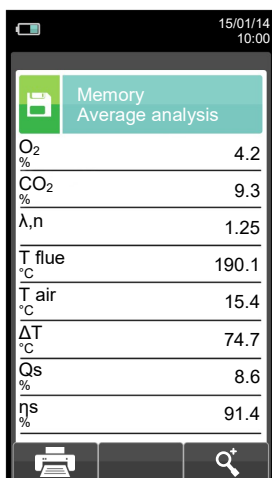

FOR ANY FURTHER INFORMATION SEE [CHAPTER 13 'FLUE GAS ANALYSIS'](#).

### 10.3 Memory Menu → Average



KEY	FUNCTION
	Activate the context keys shown on the display.
	Scrolls through the values of the average analysis.
	Activates the context key located in the left side of the display.
	Returns to the previous screen without saving the changes made.

CONTEXT KEY	FUNCTION
	Zoom. By pressing this interactive key repeatedly, the device displays the following sequence: AAA → <b>AAA</b> → <b>AAA</b> → AAA
	Starts printing the test ticket. <a href="#">SEE SECTION 11.</a>



## 10.4 Memory Menu → Select

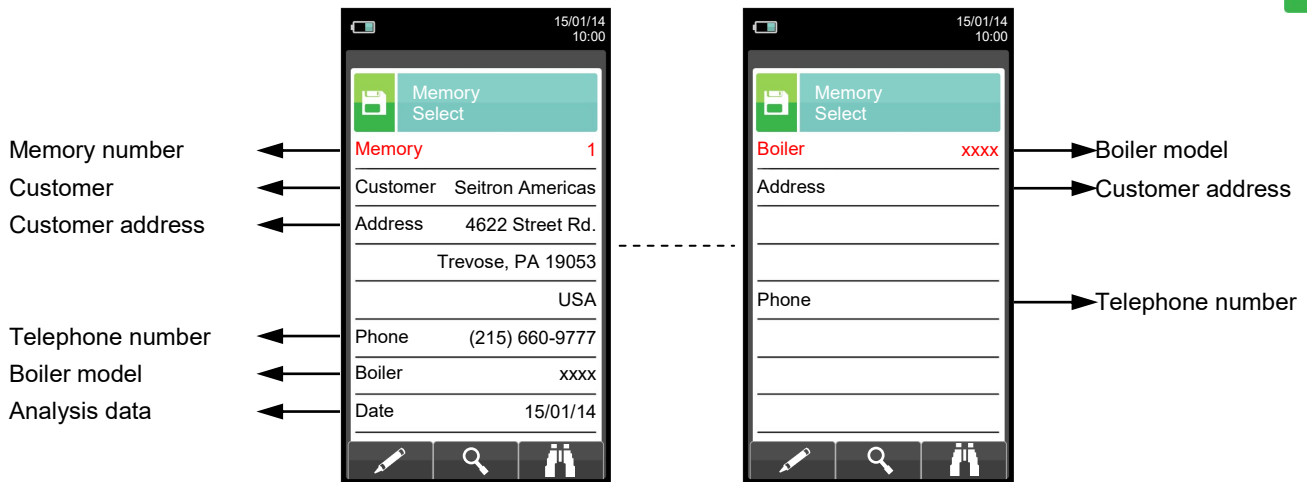

KEY	FUNCTION
	Activate the context keys shown on the display.
	In "edit text"/"search for data"/"search for memory number": it moves the cursor on the box corresponding to the desired letter or number.
	Selects line; the selected line is evidenced in red.
	Activates the context key located in the left side of the display.
	Returns to the previous screen without saving the changes made.

CONTEXT KEY	FUNCTION
	Enters the modification mode for the selected parameter. It is possible to select the number of the memory to use for the combustion analysis and/or to enter the information relative to the plant.
	Recall memory. By activating this function, the user has the possibility to view the data present in the selected memory. Measurement conditions, single analysis, average analysis. <a href="#">SEE SECTION 10.4.1</a>
	Search function. Thanks to this function, the user has the possibility to quickly search for a specific analysis. The search can be carried out considering the memory number (by selecting the parameter "Memory"), the customer (by selecting one of the following parameters: "Customer", "Address", "Telephone" or "Generator") or the date (by selecting the parameter "Date").
	Confirms the settings and, if the search function is enabled, it starts the research.
	In "Edit text" it confirms the input of the selected letter or number.
	In "Edit text" it cancels the letter or number that precedes the cursor.
	In "Edit text" it goes from uppercase to lowercase, to symbols, to special characters.
	Selects the memories within the range of the research carried out.
	Selects the memories within the range of the research carried out.



### 10.4.1 Memory Recall

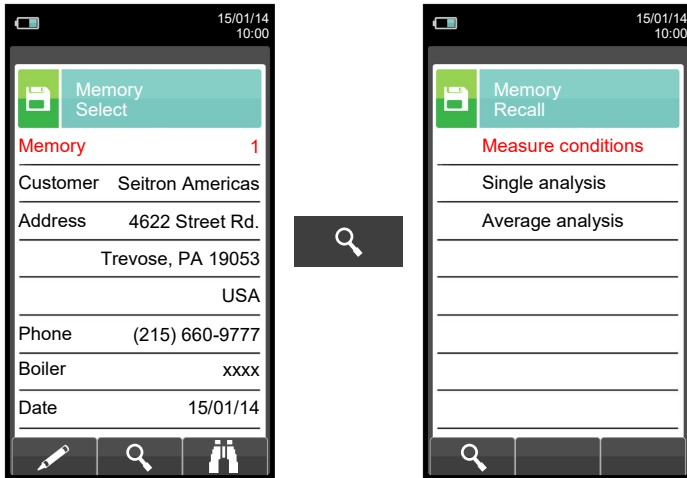

KEY	FUNCTION
	Activate the context keys shown on the display.
	Selects line; the selected line is evidenced in red.
	Activates the context key located in the left side of the display.
	Returns to the previous screen.

CONTEXT KEY	FUNCTION
	Displays the details of the selected parameter.

#### 1. Details of measurement conditions

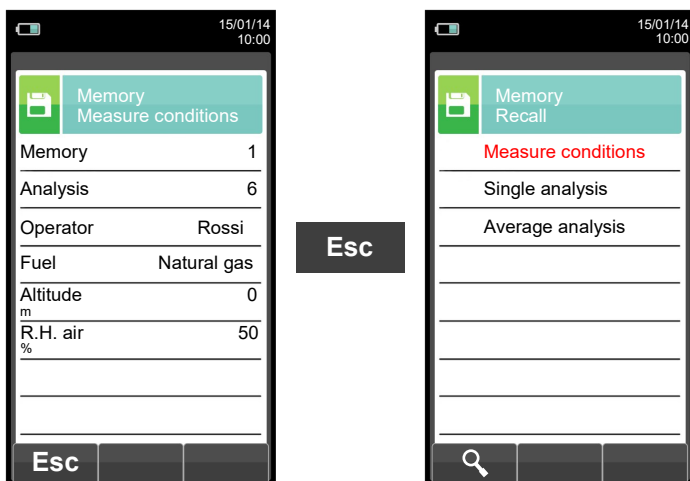

CONTEXT KEY	FUNCTION
	Returns to the previous screen.



## 2. Details of Single analysis

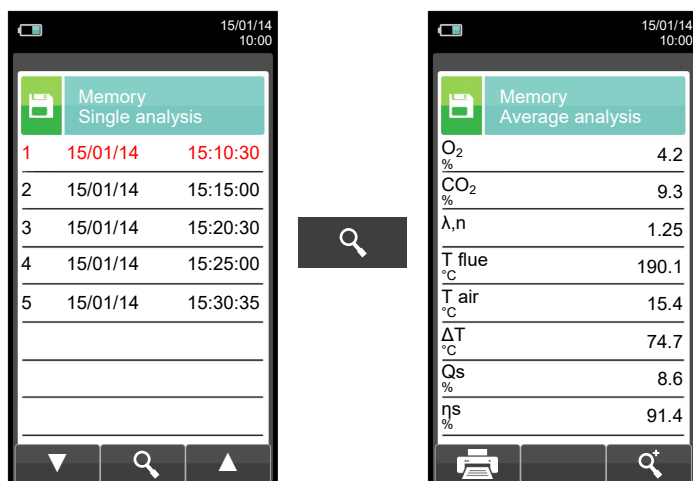

KEY	FUNCTION
	Activate the context keys shown on the display.
	Selects line; the selected line is evidenced in red. In "view detail" the previous or next pages are shown.
	Views the details of the selected parameter.
	Returns to the previous screen.

CONTEXT KEY	FUNCTION
	Selects line; the selected line is evidenced in red.
	Views the details of the selected parameter.
	Selects line; the selected line is red.
	Goes to next page.
	Goes to previous page.
	Starts printing the test ticket. <a href="#">See section 11.</a>
	Zoom. By pressing this interactive key repeatedly, the device displays the following sequence: AAA → <b>AAA</b> → <b>AAA</b> → AAA



### 3. Average interval details

Defines the starting sample to define the analysis average.

Defines the end sample to define the analysis average.

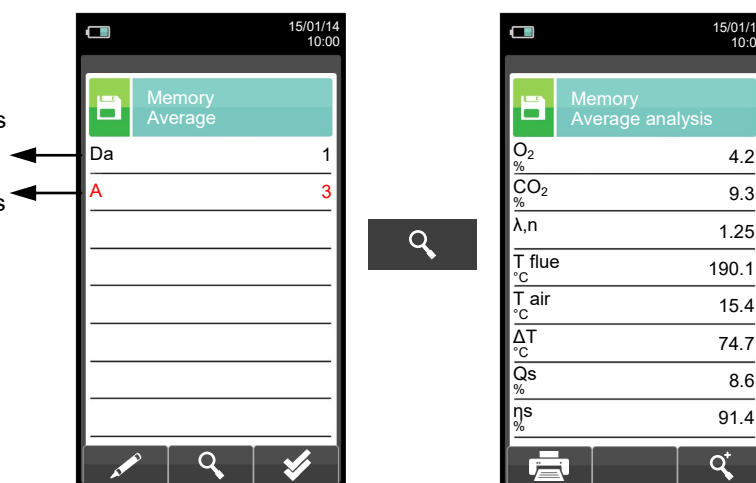

KEY	FUNCTION
	Activate the context keys shown on the display.
	In edit mode, it sets the number of the desired sample; the number to change is red.
	Selects line; the selected line is evidenced in red.
	Activates the context key located in the left side of the display.
	Returns to the previous screen without saving the changes made.

CONTEXT KEY	FUNCTION
	Enters edit mode: it is possible to select the number of the sample to use to have the average of the analysis carried out.
	Shows the average analysis in the interval set.
	Zoom. By pressing this interactive key repeatedly, the device displays the following sequence: AAA → <b>AAA</b> → <b>AAA</b> → AAA
	Sets all the samples of the analyses carried out: From 1 (first sample) To xxx (last sample).
	Confirms the settings.
	Starts printing the test ticket. <a href="#">SEE SECTION 11.</a>

## 10.5 Memory Menu → Data logger

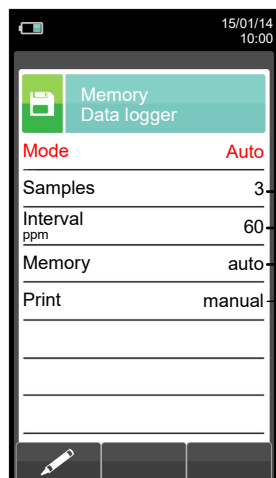



- The selectable analysis modes are: **Manual - Auto - BlmSchV - data logger**
- Number of samples to make (parameter not visible in manual analysis mode).
- Period of acquisition of each sample (parameter not visible in manual analysis mode).
- The memory selection modes are: **manual** or **auto**.  
If "**auto**" mode has been selected, the research of the available memory will be performed automatically when the device is turned on).
- The selectable printing modes are: **manual** or **auto**.  
If "**auto**" mode has been selected, the printing will be performed automatically at the end of the combustion analysis (parameter not visible in manual analysis mode).



KEY	FUNCTION
	Activate the context keys shown on the display.
	Selects line; the selected line is evidenced in red.
	Activates the context key located in the left side of the display.
	Returns to the previous screen.

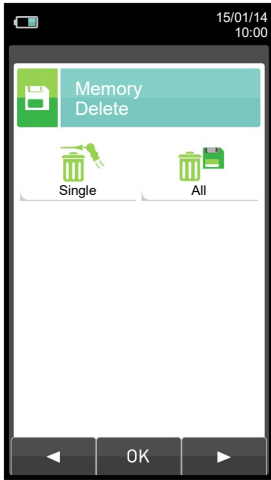

CONTEXT KEY	FUNCTION
	Enters the modification mode for the selected parameter.
	Confirms the settings.

## 10.6 Memory→Delete



KEY	FUNCTION
	Activate the context keys shown on the display.
	Returns to the previous screen.

CONTEXT KEY	FUNCTION
	Selects the available parameters.
	Enters in the selected parameter setting.
	Selects the available parameters.

PARAMETER	DESCRIPTION
 Single	This option allows the user to delete the contents of each individual memory; to do this, the user will have to confirm the operation so as to avoid losing previously saved data. <a href="#">SEE SECTION 10.6.1.</a>
 All	This option allows the user to delete the contents of the 99 memories; to do this, the user will have to confirm the operation so as to avoid losing previously saved data. <a href="#">SEE SECTION 10.6.2.</a>



### 10.6.1 Memory→Delete→Single

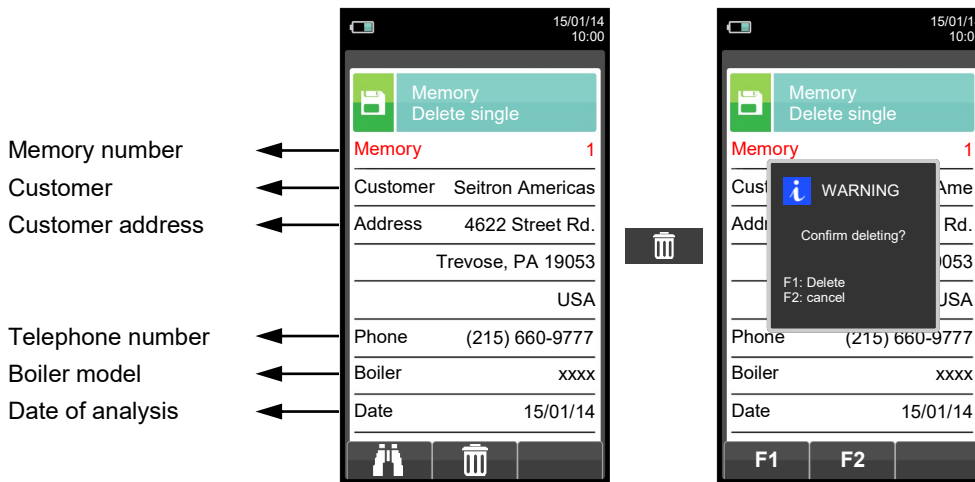

KEY	FUNCTION
	Activate the context keys shown on the display.
	In "edit text"/"search for data"/"search for memory number": it moves the cursor on the box corresponding to the desired letter or number.
	Selects line; the selected line is evidenced in red.
	Activates the context key located in the left side of the display. In "text edit": Confirm the text insertion.
	Returns to the previous screen.

CONTEXT KEY	FUNCTION
	Search function. Thanks to this function, the user has the possibility to quickly search for a specific analysis. The search can be carried out considering the memory number (by selecting the parameter "Memory"), the customer (by selecting one of the following parameters: "Customer", "Address", "Telephone" or "Generator") or the date (by selecting the parameter "Date").
	Confirms the settings and, if the search function is enabled, it starts the research.
	In "Edit text" it confirms the input of the selected letter or number.
	In "Edit text" it cancels the letter or number that precedes the cursor.
	In "Edit text" it goes from uppercase to lowercase, to symbols, to special characters.
	Selects the memories within the range of the research carried out.
	Selects the memories within the range of the research carried out.
	Starts deleting the selected memory.
	Deletes the selected memory.
	Cancel the deleting and goes back to the previous page.



## 10.6.2 Memory→Delete→All

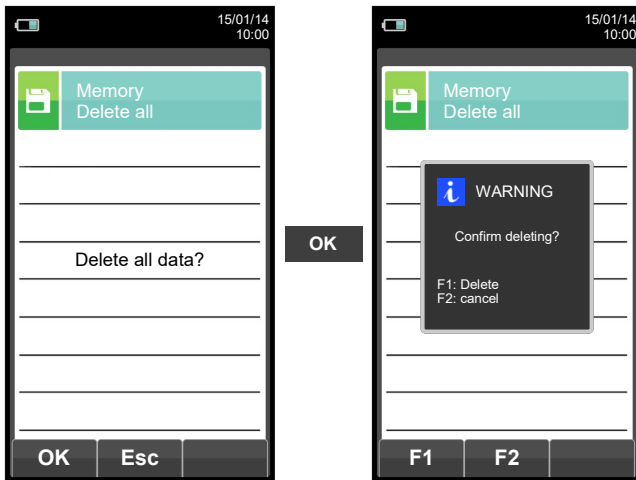



KEY	FUNCTION
	Activate the context keys shown on the display.
	Start erasing all memories.
	Returns to the previous screen.

CONTEXT KEY	FUNCTION
	Start erasing all memories.
	Returns to the previous screen.
	Deletes all memories.
	Cancel the deleting and returns to the previous page.

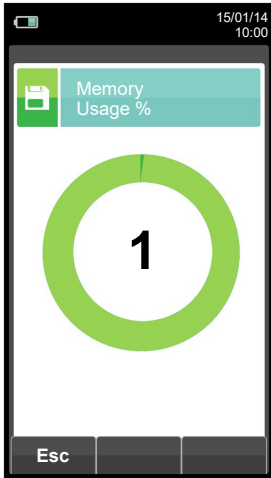
## 10.7 Memory→Usage %



KEY	FUNCTION
	Activate the context keys shown on the display.
	Returns to the previous screen.

CONTEXT KEY	FUNCTION
	Returns to the previous screen.

## 11.1 Print

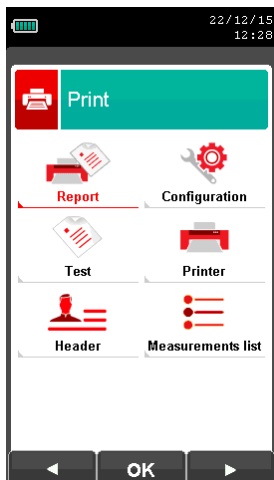

KEY	FUNCTION
	Activate the context keys shown on the display.
	Returns to the previous screen.

CONTEXT KEY	FUNCTION
	Selects the available parameters.
	Enters in the selected parameter setting.
	Selects the available parameters.

PARAMETER	DESCRIPTION
	<p>Enables the Print Menu. Allows to print the combustion analysis data on a paper ticket which reports the measurement values. The printed values are those shown on the display when the menu is enabled. This menu can be used for combustion analysis, even when recalled from the memory, for draft, smoke, ambient gas and for tightness test results.</p> <p><a href="#">SEE SECTION 11.2.</a></p>
	<p>The user, by means of this menu, can configure the test report format:</p> <p><b>Copies:</b> Allows to set the number of printed copies and layout of the paper print-out. Several copies of the test paper print-out can be printed, choosing among different layouts according to the information included.</p> <p><b>Report:</b> The paper print-out layout selection is only valid for combustion analysis and can be chosen among Complete, Partial and Total. Paper print-outs for draft, smoke, ambient gas concentration and tightness test only allow a specific layout. Layouts options for combustion analysis are specified as described in the following:</p> <p><b>Full:</b> includes a header with company data as well operator data previously programmed in the configuration menu, measurements sampled in the combustion analysis and, when sampled, the draft, smoke and CO ambient gas values.</p> <p><b>Partial:</b> only reports the combustion analysis measurement values and information, without any header, comments or blank lines for operator comments.</p> <p><b>Total:</b> prints full print-out of average values with individual test data.</p> <p><b>Date/Time:</b> It allows you to define whether or not to print the date and time at which the combustion analysis was performed.</p> <p><b>Manual:</b> The date and time are not printed in the header of the analysis report. It is the responsibility of the operator to enter the data manually.</p> <p><b>Auto:</b> The date and time are printed in the header of the analysis report.</p> <p><a href="#">SEE SECTION 11.3.</a></p>
	<p><b>Paper feed:</b> Feeds paper in the printer; this function is most useful when replacing the paper roll in the printer.</p> <p><b>Print:</b> Prints a graphical/alphanumeric test ticket for a complete check of the printer operation.</p> <p><a href="#">SEE SECTION 11.4.</a></p>
	<p>It allows the user to enter, in six lines of 24 characters the name of the Company or owner of the device or the information regarding the latter (e.g. address, telephone number), which will be printed in the header of the analysis report.</p> <p><a href="#">SEE SECTION 11.5.</a></p>
	<p>Selects the printer type: internal or Bluetooth.</p> <p>When Bluetooth printer is selected a pairing procedure will be needed in order to match the printer to the instrument. The pairing procedure has to be performed only once.</p> <p><a href="#">SEE SECTION 11.6.</a></p>
	<p>In this submenu the user has the possibility to view the list of measurements that the device performs. With the interactive keys, the user can add, delete or move a selected measurement.</p> <p><a href="#">SEE SECTION 11.7.</a></p>



## 11.2 Print→Report

```

Date: 15/01/14
Time: 10.10
Fuel: Natural gas
Altitude: 0 m
R.H. air: 50 %
O2          4.2 %
CO2         9.3 %
λ,n         1.25
T flue     190.2 °C
T air      15.4 °C
ΔT         174.8 °C
QS          8.6 %
ηs          91.4 %
ET          4.9 %
ηt          91.4 %
CO          148 ppm
NO           40 ppm
NOX/NO:     1.03
NOX         41 ppm
CO amb      0 ppm
Draft:      0.05 hPa
T out:      20 °C
Smoke:      3 1 2
Aver. n:    2
    
```

KEY	FUNCTION
	Activate the context keys shown on the display.
	Returns to the previous screen.

CONTEXT KEY	FUNCTION
	Starts printing the test ticket.
	Stops printing the test ticket.



### 11.3 Print→Configuration

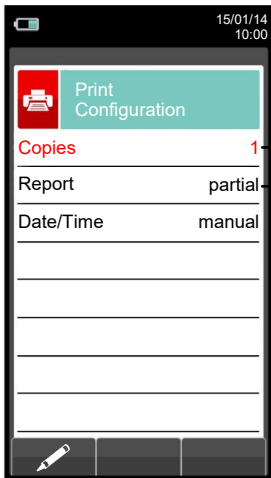

- Set the number of copies to print: 1 .. 5.
- The test ticket models that can be selected are: **partial - full - total**
- Set between: **Manual:** date and time are not printed on the analysis report.  
**Auto:** date and time are printed automatically on the analysis report.

KEY	FUNCTION
	Activate the context keys shown on the display.
	Selects line; the selected line is evidenced in red. In modification sets the value or the desired mode.
	Activates the context key located in the left side of the display.
	Returns to the previous screen. When in modify mode cancels the modification just made.

CONTEXT KEY	FUNCTION
	Enters the modification mode for the selected parameter.
	Confirms the settings.

**Example:**

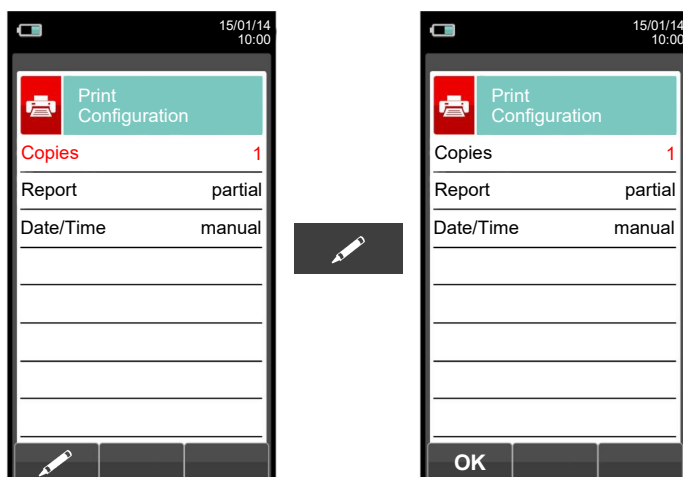



## 11.4 Print→Test

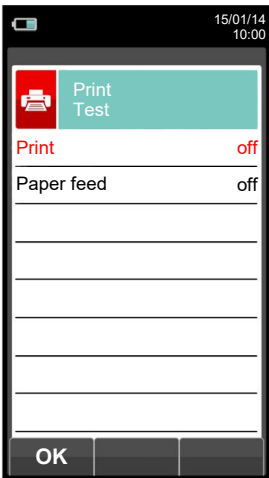

KEY	FUNCTION
	Activate the context keys shown on the display.
	Selects line; the selected line is evidenced in red. In modification sets the value or the desired mode.
	Activates the context key located in the left side of the display.
	Returns to the previous screen. When in modify mode cancels the modification just made.

CONTEXT KEY	FUNCTION
	Confirms the settings.

### Example:

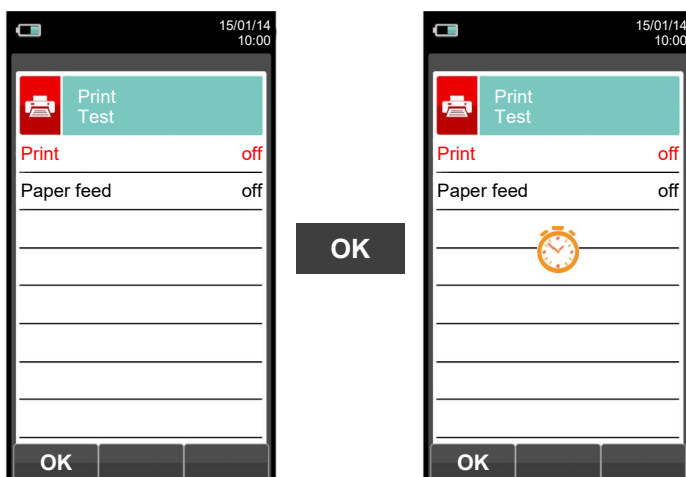



## 11.5 Print→Header

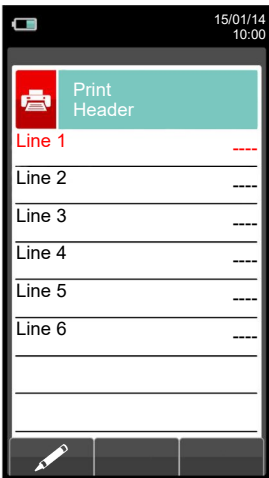

KEY	FUNCTION
	Activate the context keys shown on the display.
	In "edit text": It moves the cursor on the box corresponding to the letter or number required to form the desired word.
	In edit mode it moves the cursor through the available lines.
	In "edit text": it confirms the text input. In "Print header": It activates the context key displayed on the left.
	Returns to the previous screen. In "edit text" it goes back to the previous screen without saving the changes made.

CONTEXT KEY	FUNCTION
	Enters edit mode of the selected line: it is possible to enter the name of the operator (24 characters available).
	Confirms the selected letter or digit.
	Cancel the letter or digit before the cursor.
	Cycles through uppercase, lowercase, symbols and special characters.





# Example:

## 1. Edit text

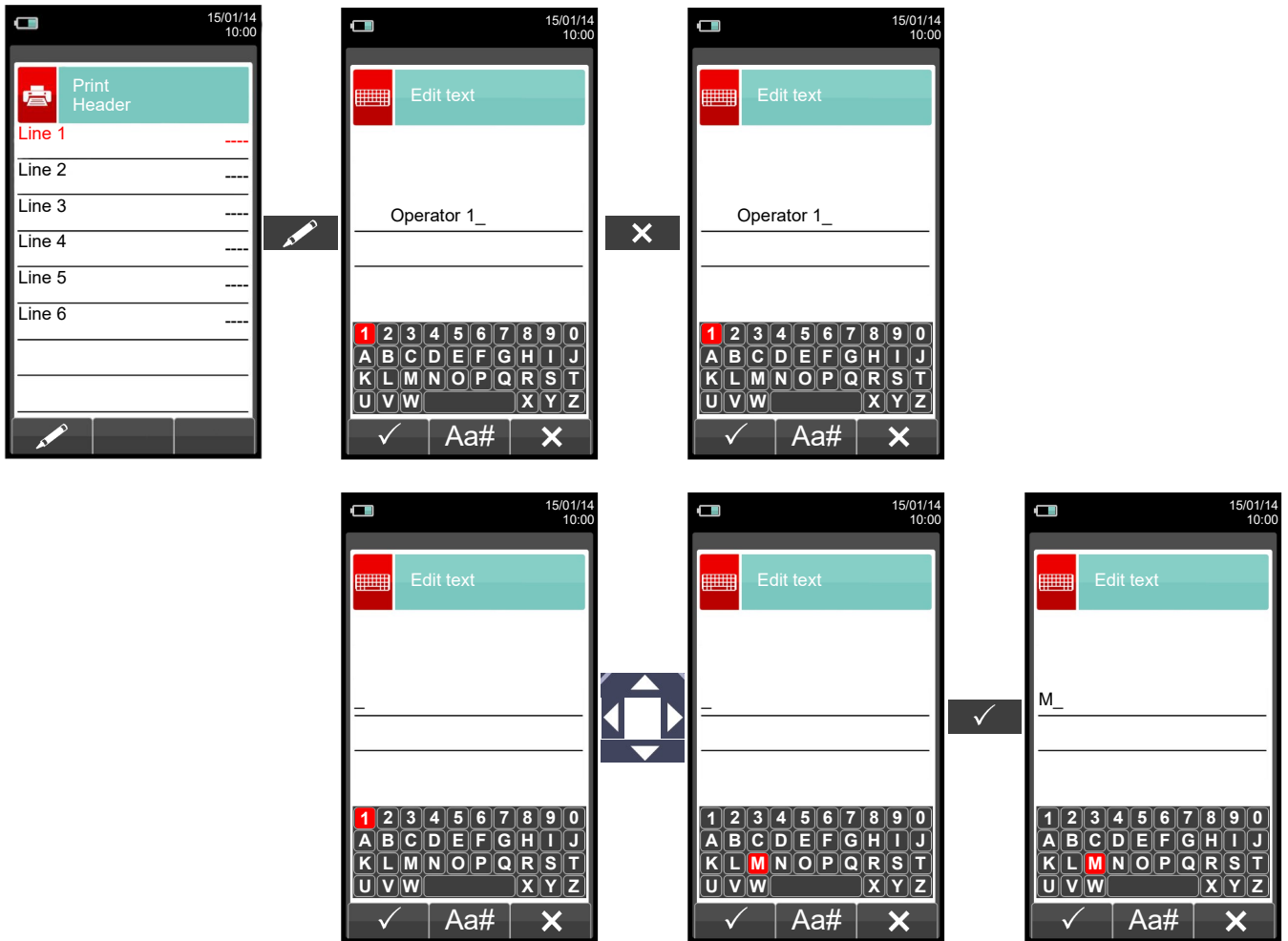



## 11.6 Print→Printer

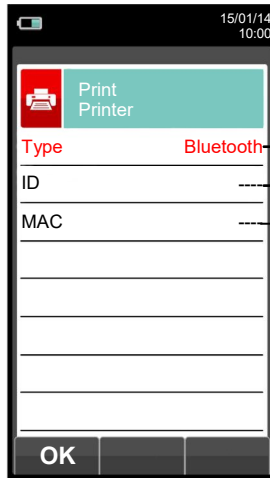
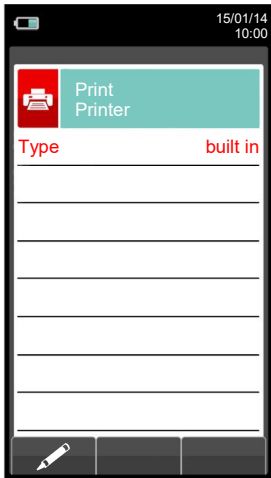

- Printer type: **built in (internal) - Bluetooth (external)**.
- Name of the Bluetooth printer associated with the instrument.
- Address of the Bluetooth printer associated with the instrument.

KEY	FUNCTION
	Activate the context keys shown on the display.
	Selects line; the selected line is evidenced in red. In modification sets the value or the desired mode.
	Activates the context key located in the left side of the display.
	Returns to the previous screen. When in modify mode cancels the modification just made.

CONTEXT KEY	FUNCTION
	Enters the modification mode for the selected parameter.
	Confirms the settings.

## 11.6.1 Print→Pairing

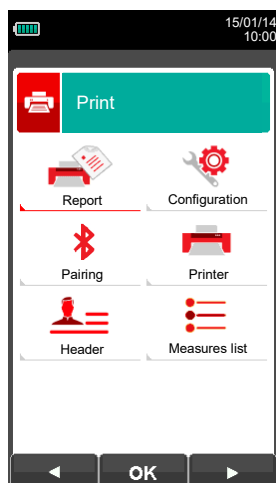

KEY	FUNCTION
	Activate the context keys shown on the display.
	Selects line; the selected line is evidenced in red. In modification sets the value or the desired mode.
	Activates the context key located in the left side of the display.
	Returns to the previous screen. When in modify mode cancels the modification just made.

CONTEXT KEY	FUNCTION
	Selects the available parameters.
	Enters in the selected parameter setting.
	Selects the available parameters.
	Starts the search for Bluetooth devices.
	Quits and returns to the previous screen.
	Enters the modification mode for the selected parameter.
	Repeats the pairing procedure.
	Confirms the settings.
	Confirms the selected letter or digit.
	Cancels the letter or digit before the cursor.
	Cycles through uppercase, lowercase, symbols and special characters.

In the following pages the pairing procedure between the instrument and a Bluetooth printer is described.



1. Once the Bluetooth printer is configured, proceed as follows:

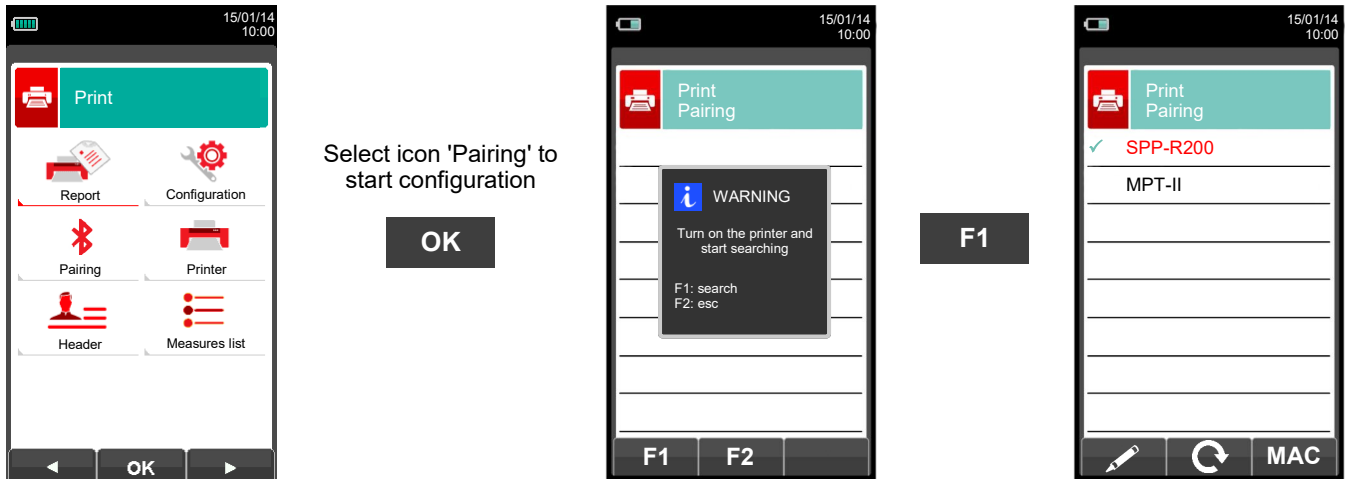

2. Select the line corresponding to the desired Bluetooth printer, then proceed as follows:

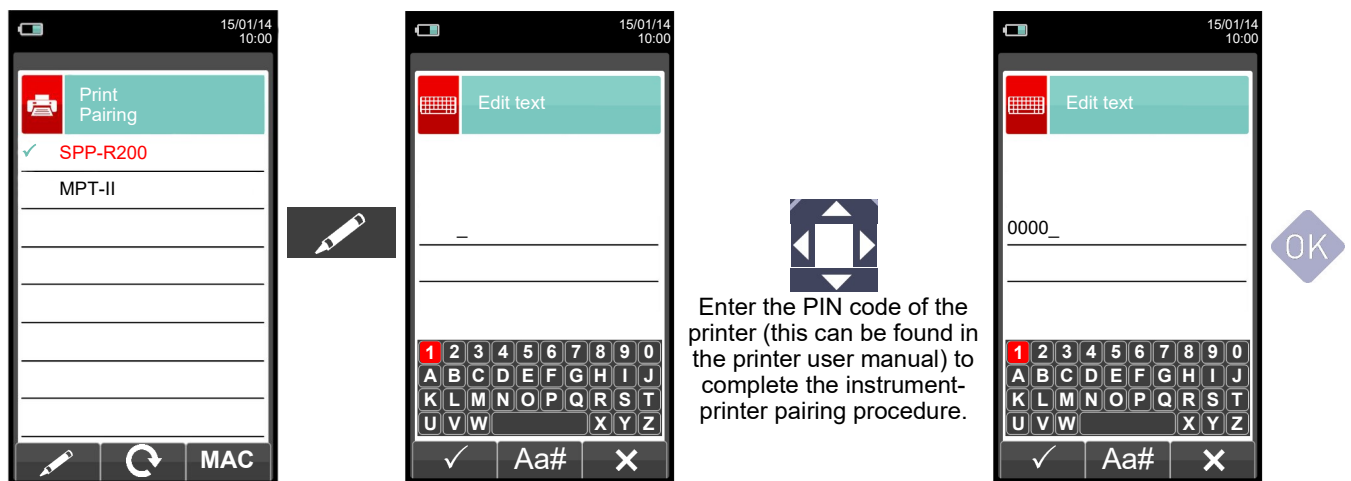

3. The instrument-printer pairing is completed. Press key 'ESC' to return to the previous screen.



## 11.7 Print→Measures list

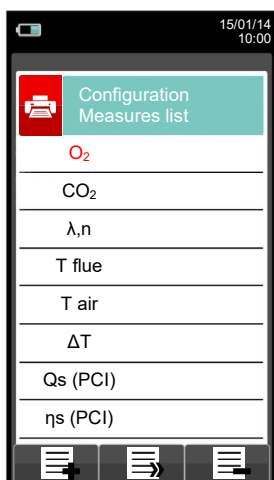

KEY	FUNCTION
	Activate the context keys shown on the display.
	Selects the available measurements from the suggested list. In edit mode, it scrolls through the measurements present.
	Confirms the modification.
	When pressed in modify mode cancels the selection made, otherwise returns to the previous screen.

CONTEXT KEY	FUNCTION
	Adds a measurement.
	Moves the position of a measurement.
	Deletes a measurement from the list.
	Scrolls through the available measurements.
	Confirms the change made.
	Scrolls through the available measurements.
	Cancels the change made.



**Example:**

**1. Add a measurement to the list**

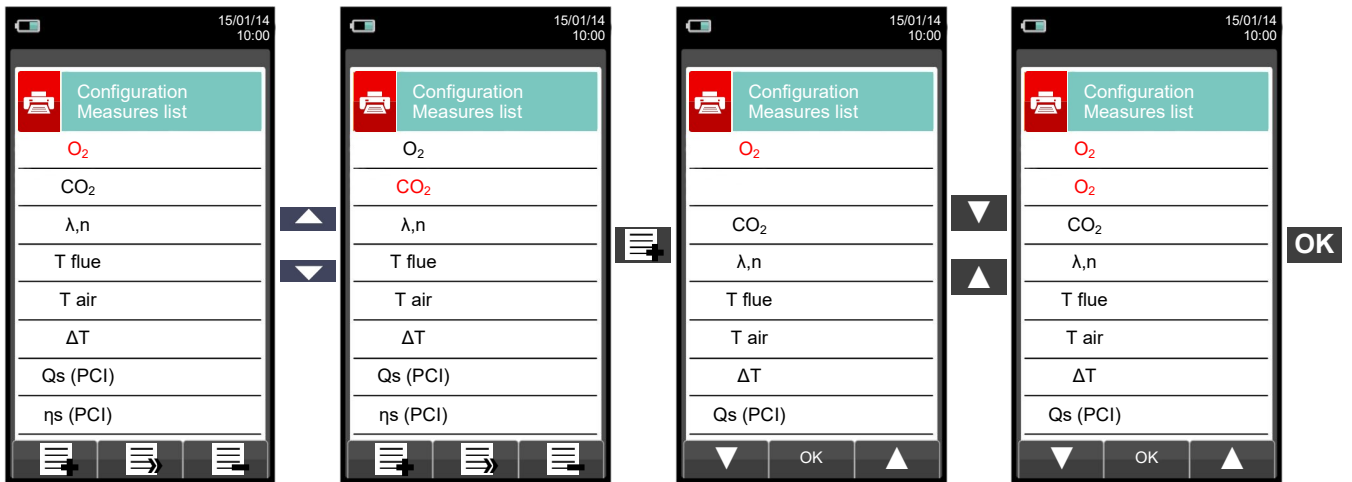

**2. Move the position of a measurement**

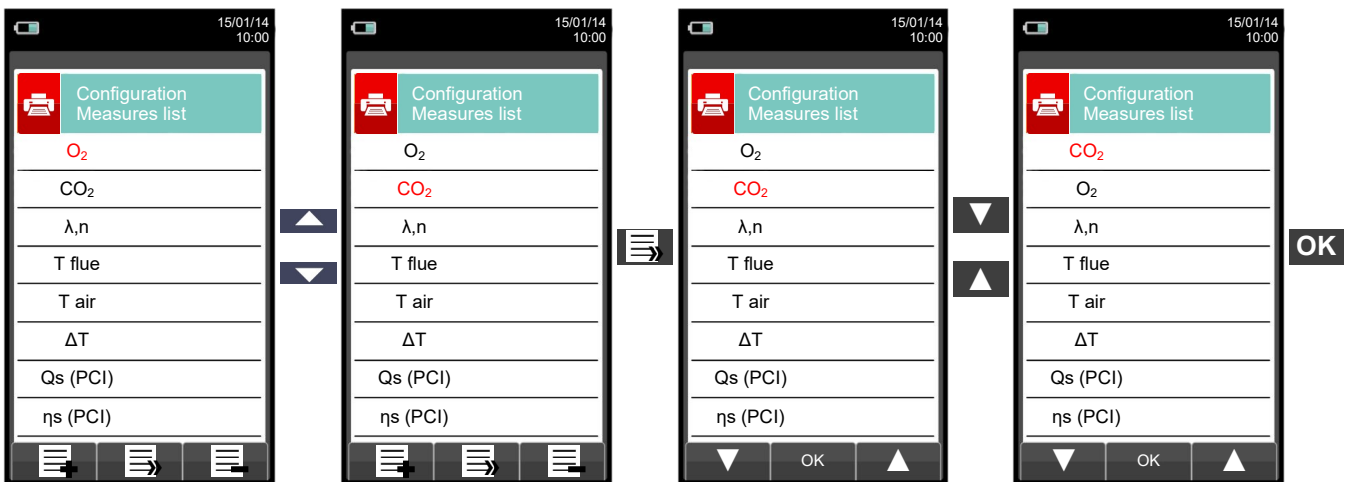

**3. Deletes a measurement from the list**

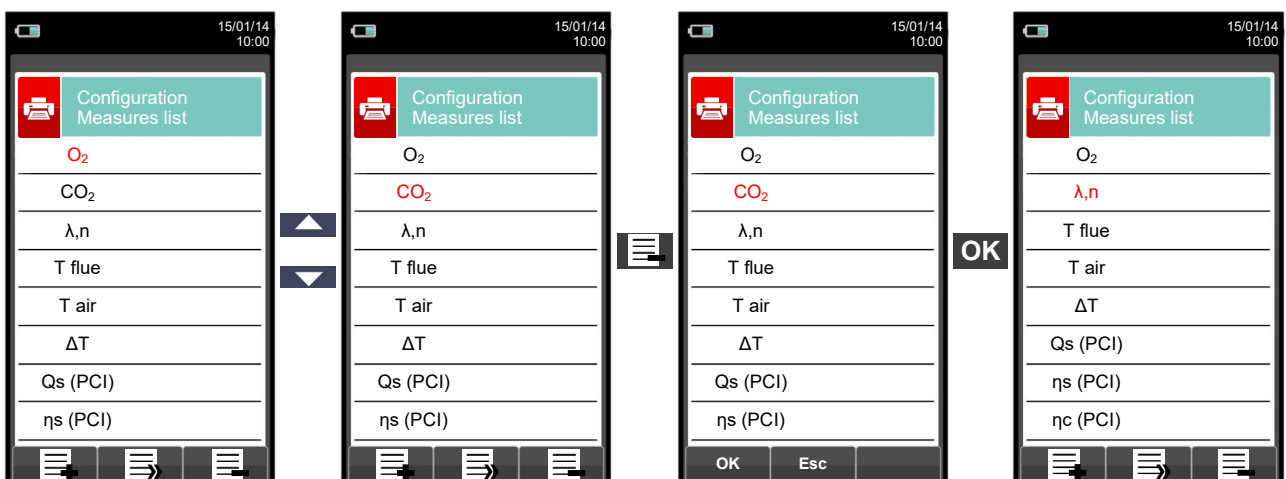

## 12.1 MEASUREMENTS

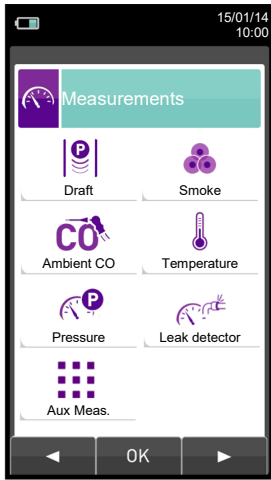





KEY	FUNCTION
	Activate the context keys shown on the display.
	Returns to the previous screen.

CONTEXT KEY	FUNCTION
	Selects the available parameters.
	Enters in the selected parameter setting.
	Selects the available parameters.

PARAMETER	DESCRIPTION
 Draft	<p>The DRAFT menu gives access to the stack draft measurement. Being a negative pressure, draft must be measured using the negative pressure input P-. The correct values for a natural draft boiler are therefore positive by definition. Before performing the measurement the instrument allows the user to input the external air temperature as required by the standard. When making the measurement and the temperature has been inserted, the instrument provides a stack draft value related (P diff ref) to the external temperature of 68° F as requested by law. When the inserted external temperature is higher than 68° F the instrument reports a stack draft value reference equal to the measured draft. Afterwards the user can acquire the value displayed in order to add it to the running analysis measurements or, alternatively, print the relevant paper print-out through the 'PRINT' menu.</p> <p><b>NOTE: The measurement may not be accurate due to condensation inside the gas probe. Should you notice an inaccurate or unstable reading on the instrument, it is advisable to disconnect the gas probe from the instrument itself, and purge pipes by blowing with a compressor. In order to be sure there is no humidity, it is suggested to perform the measurement by means of the transparent rubber pipe supplied on issue.</b></p> <p><a href="#">SEE SECTION 12.2.</a></p>
 Smoke	<p>It is possible to enter the data concerning one to three <b>Smoke Tests</b> measurements taken by means of an optional device (AAPM02–Manual Smoke Pump Kit); see the relevant instructions. The method consists in taking a certain quantity of combustion gas from the middle of the flue behind the surfaces of the exchangers at the end of the boiler, and make it pass through a special filter paper. The soot stain obtained is compared with the surfaces blackened in a different way according to a comparison scale; it is thus determined the "soot number", which will be entered in the instrument by hand.</p> <p>These measurements can be either stored in memory together with the combustion analysis data or printed on a ticket.</p> <p><a href="#">SEE SECTION 12.3.</a></p>
 Ambient CO	<p>This type of analysis lets the user measure the CO value present in the environment, with the scope of checking the personal safety conditions of a specific working environment. The instrument leaves our factory with the following pre-set threshold values:</p> <p><b>COmax:</b> 35 ppm Recommended exposure limit (REL) stipulated by the National Institute for Occupational Safety and Health (NIOSH), equivalent to 40 mg/m<sup>3</sup> and calculated as an 8-hour Time-Weighted Average (TWA).</p> <p> <b>It is compulsory to perform the autozero in the clean air, so that the ambient CO measurement is correct. It is advisable to turn on the instrument and wait for the autozero completion outside the area where the test is being performed.</b></p> <p><a href="#">SEE SECTION 12.4.</a></p>



PARAMETER	DESCRIPTION
 Temperature	With this menu it is possible to measure the temperature of the supply water, by means of an OPTIONAL thermocouple K-type contact probe to be connected to the input T1. Also, it is also possible to measure the temperature of the return water, by connecting an OPTIONAL thermocouple K-type contact probe to be connected to the input T1. With the function $\Delta T$ it is possible to obtain the relative temperature difference. <a href="#">SEE SECTION 12.5.</a>
 Pressure	It is possible, through the use of the external flexible pipe made in RAUCLAIR (supplied), to measure a pressure value within the range stated in the technical features (connect the pipe to P+ input). During the pressure measurement the 'HOLD' function is made available, which allows to 'freeze' the value shown on the display, by pressing 'HOLD' key. <a href="#">SEE SECTION 12.6.</a>
 Leak detector	THIS MENU IS AVAILABLE ONLY IF THE SENSOR FOR GAS LEAKS IS INSTALLED ON THE INSTRUMENT. It allows to identify gas leaks in plants, in pipes and in the devices. To perform the test it is required to have installed the specific internal semiconductor sensor for gas leaks detection and the relevant probe with flexible hose and metal tip, which allows to withdraw the gas in a localised point even in areas with very small leaks. The sensor is sensitive to both CH <sub>4</sub> (Methane) and LPG (IsoButane and IsoPropane) as well as several other combustible gases (hydrocarbons). <a href="#">SEE SECTION 12.7.</a>
 Aux meas.	The user through this menu, can access to more measures, which are: <b>Gas velocity</b> <b>Burner thermic power</b> <b>Ionization current</b> <b>Ventilation test</b> <a href="#">SEE SECTION 12.8.</a>





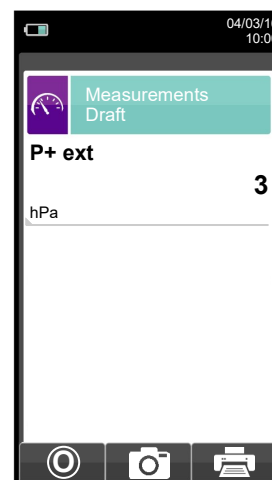



## 12.2 Measurements → Draft





To measure the draft proceed as follows:

- Connect the probe pressure input hose to the instrument **P+** input.
- Enter the external air temperature.
- Before starting the pressure zeroing sequence pay attention to remove the gas probe from the stack.

- Having carried out the pressure zeroing sequence, insert the probe in the chimney and measure the draft.
- The draft values to be stored in the memory must be acquired before storing the analysis data.
- To attach the draft value to the readings of the current analysis, activate the "save" function '  '.
- To print the test ticket with the value of the draft, activate the function '  '.
- It is possible to cancel an acquired draft from the memory; to overwrite a new one, activate the "save" function again '  '.
- After saving the draft measurement, to carry out the combustion analysis, press the key '  '.

KEY	FUNCTION
	Activate the context keys shown on the display.
	Sets the value of the external temperature.
	Returns to the previous screen.

CONTEXT KEY	FUNCTION
<b>F1</b> <b>F2</b> <b>F3</b>	The activation of one of these keys starts the Draft measurement.
	Carries out pressure zeroing.
	Saves, in the memory selected in the "Memory Select" menu, the value of the draft measured.
	Starts printing the test ticket. <a href="#">SEE SECTION 11.</a>

### 12.3 Measurements → Smoke

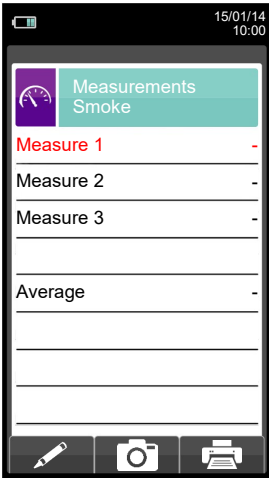

- Measure the carbon black using the specific optional kit.
- Enter the values found.
- The values of the carbon black that you want to save must be acquired before saving the analyses.
- To join the values of the carbon black to the measurements of the current analysis use the ' ' function.
- To print the ticket with the measurement of the carbon black, activate the ' ' function.
- It is possible to delete the values of the carbon black acquired in the memory by overwriting them by activating the ' ' function again.
- After saving the carbon black values, to carry out the combustion analysis, press the key ' '.

KEY	FUNCTION
	Activate the context keys shown on the display.
	Sets the "soot number" found by the device when measuring the carbon black.
	Returns to the previous screen.

CONTEXT KEY	FUNCTION
	Enters the modification mode for the selected parameter.
	Confirms the value entered.
	Saves, in the memory selected in the "Select Memory" menu, the values entered.
	Starts printing the ticket. <a href="#">SEE SECTION 11.</a>

## 12.3.1 Measurements → Optional AAPM02 - Smoke pump operative manual

### Field of application

The **smoke pump** determines the soot spot number in combustion.

### Basic safety instructions

#### !!! Warning !!!

- Before using the smoke pump, warm it up to room temperature.
- After approx. 10 measurements, check the withdrawal probe up to the valve for soot deposit and, if present clean it. Apply the same to all the others pump parts; this operation should be done regularly (See chapter: "Maintenance of the pump").
- Occasionally test the smoke pump for leaks (see chapter: "Testing the pump for leaks"). It is recommended to keep the soot picture comparison scale always in its wrapper and thus clean.

#### !!! Read carefully !!!

- It is precondition that the smoke pump is exclusively used according to the intended use.
- Do not apply excessive force to the testing instrument (It may break).

### Test operation. Smoke Sampling.

Before taking the smoke sample, the burner should already be in operation for at least 5 minutes.

- A. Insert the filter paper in the opening on the pump head and clamp it with a clockwise rotation of the probe head.

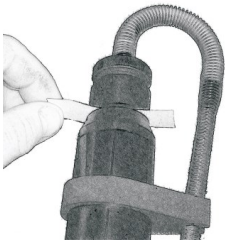

- B. Bring the probe tube through the measuring vent of the exhaust pipe in the middle of the flue-gas flow.

#### C. Perform 10 full suction strokes;

draw slowly and uniformly (suction stroke), shortly pause at the stop (pressure equalization), than move back fast. According to the prescription,  $1.63 \pm 0.07 \text{ dm}^3$  exhaust gas are thereby drawn through the filter paper.

**The operation time of the 10 strokes has to be 40-60 seconds.**

- D. Release the probe head with a left-hand rotation and extract the filter paper stripe. A measuring spot with the corresponding coloring remains on the filter paper.  
To define the exact soot number, you have to take at least 3 samples! The soot spot number is averaged out of them.

**In case of a sluggish operation of the pump, lubricate the piston packing (see the chapter: "Lubrication of the soot pump")!**

### Test for oil derivate

- A. Test the measuring spot for oil-derivate. For that purpose, drop some acetone solvent next to the measuring spot. If there is no grey coloration, no oil is contained in the sample, which is correct.

### Otherwise

If there is a grey coloration of the measuring spot: The exhaust gas contains oil! Inspect the oil burning installation!

- B. Hold the filter paper with the measuring spot behind the grey scales of the soot picture comparison scale until the spot appears fully in center and read off the soot spot number. The shade of grey looking more likely to the measuring spot density shows the soot spot number.

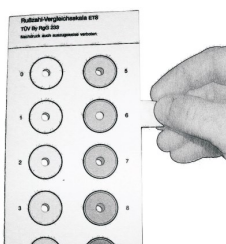

C. Now average over the soot spot numbers of all samples taken. This value, rounded up to the next whole number, is the value respectively the soot spot number of the installation.

## Maintenance

### Cleaning of the smoke pump.

#### Remove lightly adhering soot particles:

- For this purpose, make some firm pump strokes, the probe head slightly drawn and no filter paper inserted. Lightly adhering dirt will peel away also from the valve.

#### Disassembly of the smoke pump:

- Unscrew the cylinder cap with left-hand rotation.
- Carefully pull the piston out of the cylinder. Pay attention not to damage the piston packing on the thread inside of the cylinder!

#### When cleaning the piston package, do not take it off the piston rod!

- Unscrew the probe head with left-hand rotation.
- Screw off the valve using the supplied key through a left-hand rotation. Put the key securely into the keyhole.

#### To remove lubricant excesses, use only cleaning agents not affecting plastic material!

- Very dirty piston rods may be cleaned with fine-grained sandpaper.
- Clean the pump components with a cloth or a suitable brush.

#### Lubrication of the smoke pump

Before lubricating, the pump has to be cleaned (see chapter: "Cleaning of the smoke pump").

#### To lubricate the pump only use the provided lubricating oil!

#### Do not apply too much lubricant oil!

#### Do not use lubricants containing mineral oil!

- Drop some lubricant in the cylinder. Spread the lubricant oil on the piston packing and than put the piston back in.
- Move the piston in the cylinder until it runs smoothly.
- Mount the remaining components.

#### Testing the pump for leaks

- Turn the probe head under slight pressure to the valve support (clockwise rotation - clamping position)
- Hold the pump with handle towards the body so that the probe tube may be closed with the thumb (Of course you may also use other accessories for closing the probe tube).
- Pull the pump piston on the handle out for approx. 37,4 - 41 inches and let it loose. The handle should spring back in its initial position: in this case the pump is sealed.

or

- If the handle does not spring back in its initial position, the pump is leaked.





#### Possible causes:

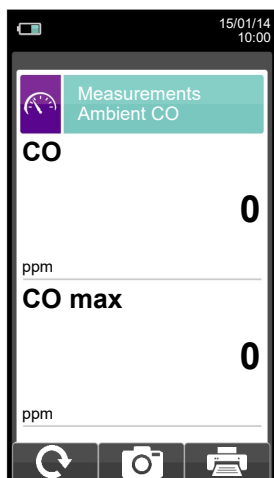

- rubber hose defect
- faulty valve or valve gasket
- crack in the piston packing



## 12.4 Measurements → Ambient CO



**It is compulsory to perform the autozero in the clean air, so that the ambient CO measurement is correct. It is advisable to turn on the instrument and wait for the autozero completion outside the area where the test is being performed.**

- The values of the ambient CO that you want to save must be acquired before saving the analyses.
- To join the values of the ambient CO to the measurements of the current analysis use the "  " function.
- To print the ticket with the measurement of the ambient CO, activate the "  " function
- It is possible to delete a draft value acquired by the memory by overwriting it by activating the "  " function again.
- After saving the draft values, to carry out the combustion analysis, press the key "  ".

KEY	FUNCTION
	Activate the context keys shown on the display.
	Returns to the previous screen.

CONTEXT KEY	FUNCTION
	Updates the measurement.
	Saves, in the memory selected in the "Select Memory" menu, the data acquired.
	Starts printing the ticket. <a href="#">SEE SECTION 11.</a>



## 12.5 Measurements → Temperature

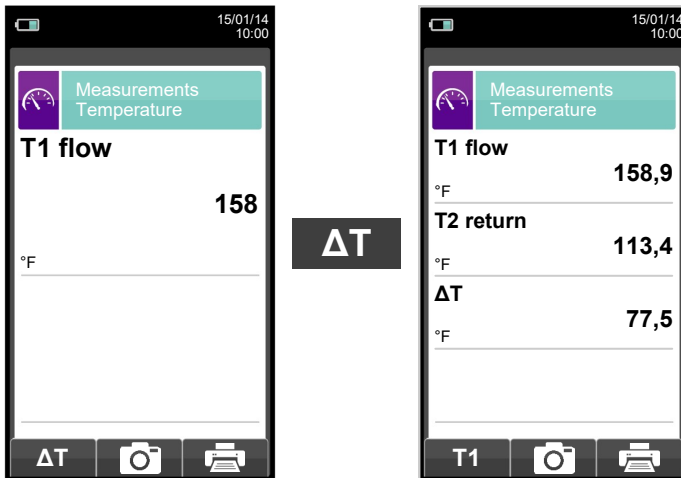

KEY	FUNCTION
	Activate the context keys shown on the display.
	Returns to the previous screen.

CONTEXT KEY	FUNCTION
	Accesses the acquisition of the temperature difference between the supply water (measured by the probe connected to the connector T1 of the device) and the return water (measured by the probe connected to the connector T2 of the device).
	Goes back to the visualisation of the supply water temperature.
	Saves, in the memory selected in the "Select Memory" menu, the data acquired.
	Starts printing the ticket. <a href="#">SEE SECTION 11.</a>

## 12.6 Measurements → Pressure



Measurement of the differential pressure by means of the internal pressure sensor.

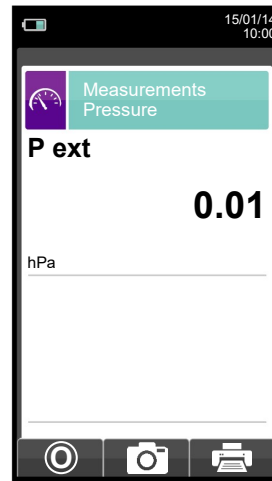

Measurement of the pressure by means of an external draft gauge.

KEY	FUNCTION
	Activate the context keys shown on the display.
	Returns to the previous screen.

CONTEXT KEY	FUNCTION
	Performs pressure zeroing.
	Saves, in the memory selected in the "Select Memory" menu, the data acquired.
	Starts printing the ticket. <a href="#">SEE SECTION 11.</a>

## 12.7 Measurements → Leak detector (Only for S4500 models with Methane sensor installed)

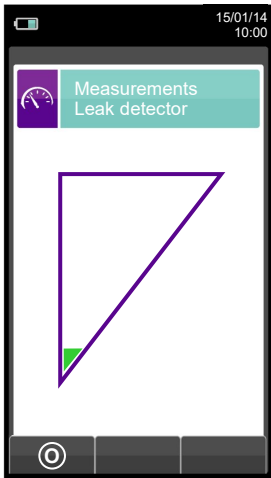

KEY	FUNCTION
	Activate the context keys shown on the display.
	Returns to the previous screen.
CONTEXT KEY	FUNCTION
	Make the zero for the measurement.

### 12.7.1 Connecting the probe for gas leak

- Plug the connector of the probe to the IN input of the instrument.

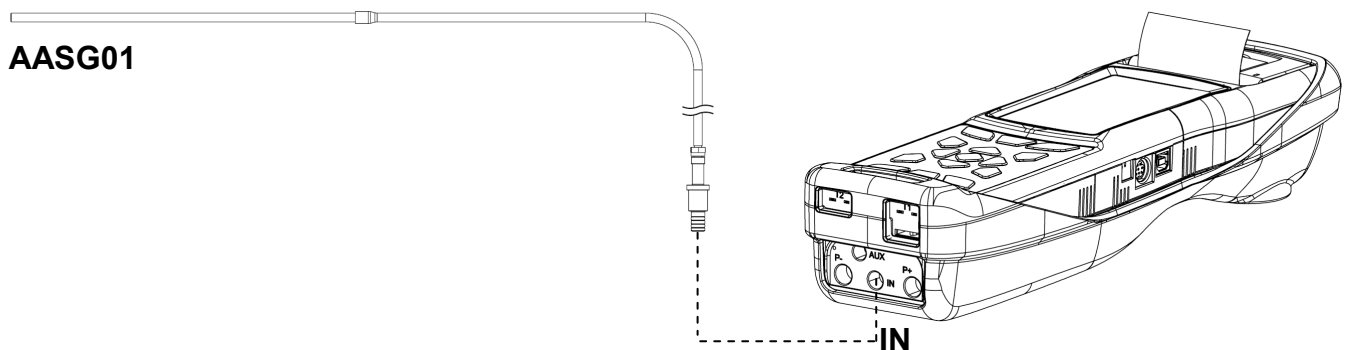

### 12.7.2 Performing the test

Once the autozero cycle is completed, perform the zero of the measure and proceed with the test.  
Outcome:

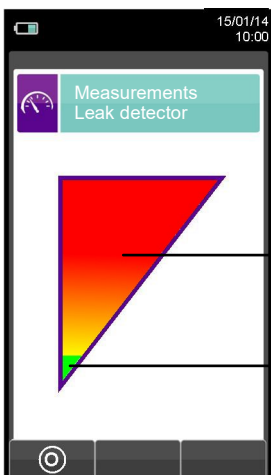

- The instrument has detected the presence of gas.  
Audible indication: the frequency of the beep increases as the concentration of gas detected increases.  
Visual indication: from yellow to red with increasing concentration of the gas detected.
- The tool did not detect the presence of gas.  
Audible indication: 1 beep / second  
Visual indication: green.





## 12.8 Measurements → AUX measurements

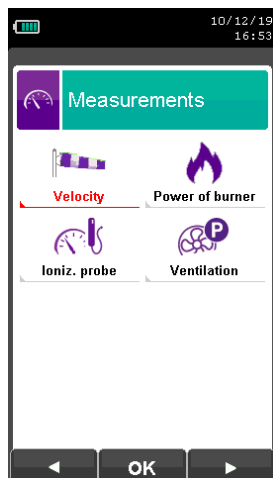

KEY	FUNCTION
	Activate the context keys shown on the display.
	Returns to the previous screen.

CONTEXT KEY	FUNCTION
	Selects the available parameters.
	Enters in the selected parameter setting.
	Selects the available parameters.

PARAMETER	DESCRIPTION
 Velocity	When a Pitot tube and a Tc-K thermocouple are connected, the instrument is capable to measure at the same time both temperature and velocity of a gas (air/flue gas). <a href="#">SEE CHAPTER 12.9</a>
 Power of burner	<b>Thermal power of the burner</b> The measurement of the thermal power at the burner can be performed in different ways, depending on the type of fuel selected. <b>Boilers using gaseous fuels</b> FLOW: if the system is equipped with a volumetric flow meter just enter the value of the fuel volume flow (m <sup>3</sup> / h). COUNTER: this mode can be used if the system is equipped with a volumetric flow meter. The volume flow is calculated by reading on the counter, while the generator is in steady operation, the volume of gas flown in a time interval of at least 120 s. MANUAL: if the procedure was provided by the manufacturer and appropriate instructions have been specified on the user manual, the operator can find out the thermal power of the burner and enter it manually. In the absence of counter or any other system for measuring the flow, the nominal thermal power of the boiler stated by the manufacturer is to be assumed as the proper value. <b>Boilers using liquid fuels</b> FLOW: the value of the mass flow rate (kg / h) of the fuel must be entered. MANUAL: if the procedure was provided by the manufacturer and appropriate instructions have been specified on the user manual, the operator can find out the thermal power of the burner and enter it manually. In the absence of counter or any other system for measuring the flow, the nominal thermal power of the boiler stated by the manufacturer is to be assumed as the proper value. <a href="#">SEE CHAPTER 12.10</a>
 Ioniz. probe	Connecting the ionization probe (optional) to the serial port, it will be possible to measure the ionization current in a burner and control the value according to the technical features of the burner. <a href="#">SEE CHAPTER 12.11</a>
 Ventilation	The menu VENTILATION allows to perform the test of the ventilation openings correct operation, through the measurement of the static differential pressure of the boiler room. <b>When on verification mode</b> , the difference between the atmospheric pressure measured at the beginning of the test and the average of the measures performed afterwards must be <b>≤4Pa</b> . After this, it is possible to acquire the value shown on the display in order to add it to the measures of the current analysis or proceed with printing the correspondent ticket through the PRINT menu. <a href="#">SEE CHAPTER 12.12</a>



## 12.9 Measurements → Velocity

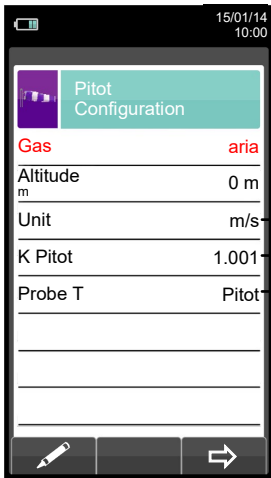

- ➔ Measurement: air or flue gas.
- ➔ Altitude above sea level.
- ➔ Measurement unit selectable across m/s, km/h, fpm, mph.
- ➔ Insert the K-factor of the Pitot tube stated by the tube manufacturer.
- ➔ Temperature acquisition mode:  
Pitot (with Tc-K thermocouple) or Flue gas probe (or external Tc-K thermocouple).

KEY	FUNCTION
	Activate the context keys shown on the display.
	Selects line; the selected line is evidenced in red. In edit mode, it sets the desired value.
	Activates the context key located in the left side of the display.
	Returns to the previous screen. When in modify mode cancels the modification just made.

CONTEXT KEY	FUNCTION
	Enters the modification mode for the selected parameter.
	Confirms the value entered.
	Go to next step.
	Make the zero for the measurement.
	Saves, in the memory selected in the "Select Memory" menu, the data acquired.
	Starts printing the ticket. <a href="#">SEE SECTION 11.</a>



### 12.9.1 How to connect the Pitot tube to the instrument

- Connect the Pitot tube (accessory) to inputs P+ and P- (which are normally used for the differential pressure measurement)
- Connect the Tc-K thermocouple cable from the flue gas probe to connector T1 of the instrument.

**WARNING:** when a Pitot tube integrated to a Tc-K thermocouple is used, remember to connect the thermocouple connector to T1 input at instrument side. In this case the flue gas probe must not be connected.

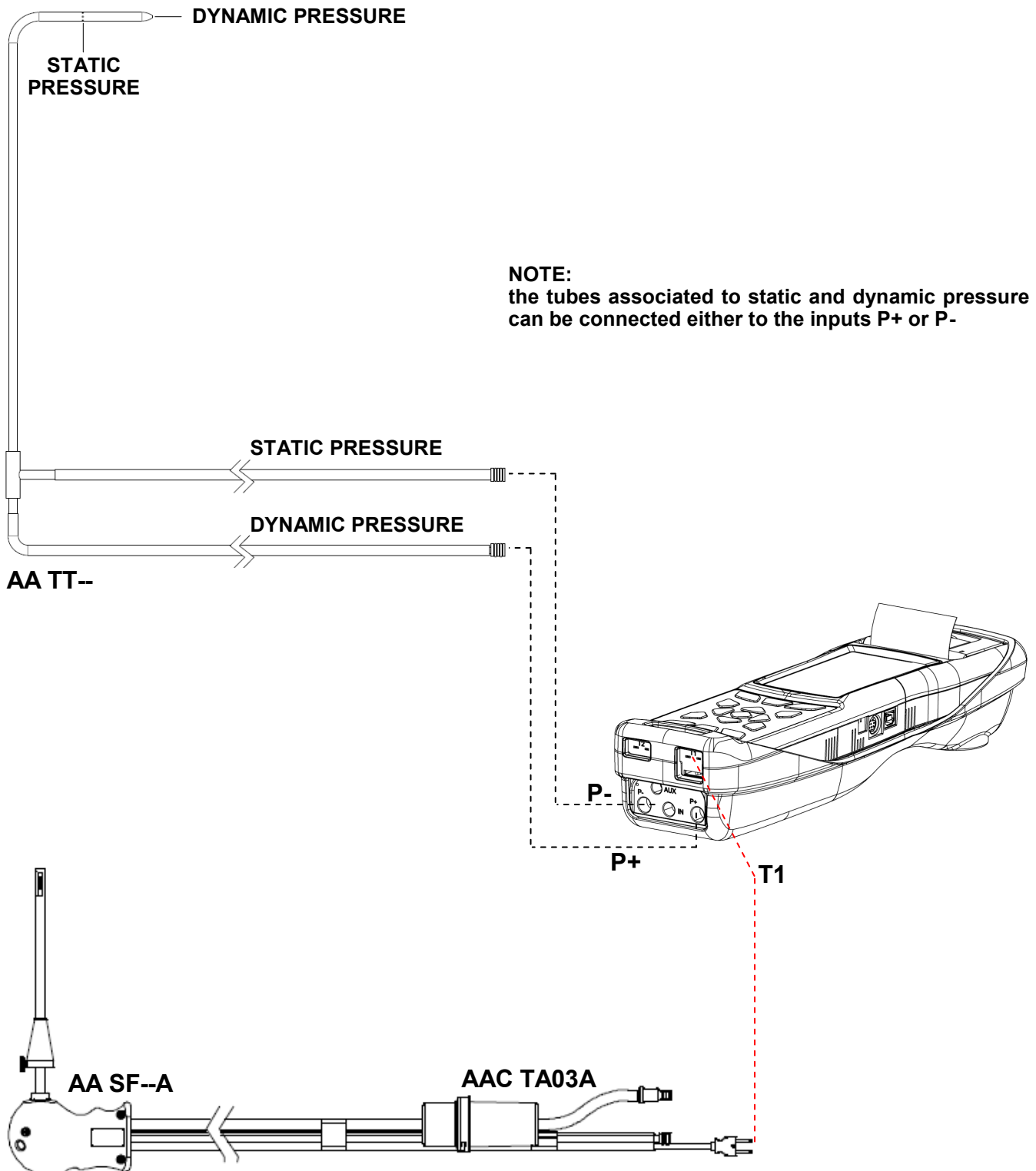

## 12.9.2 TEST EXECUTION

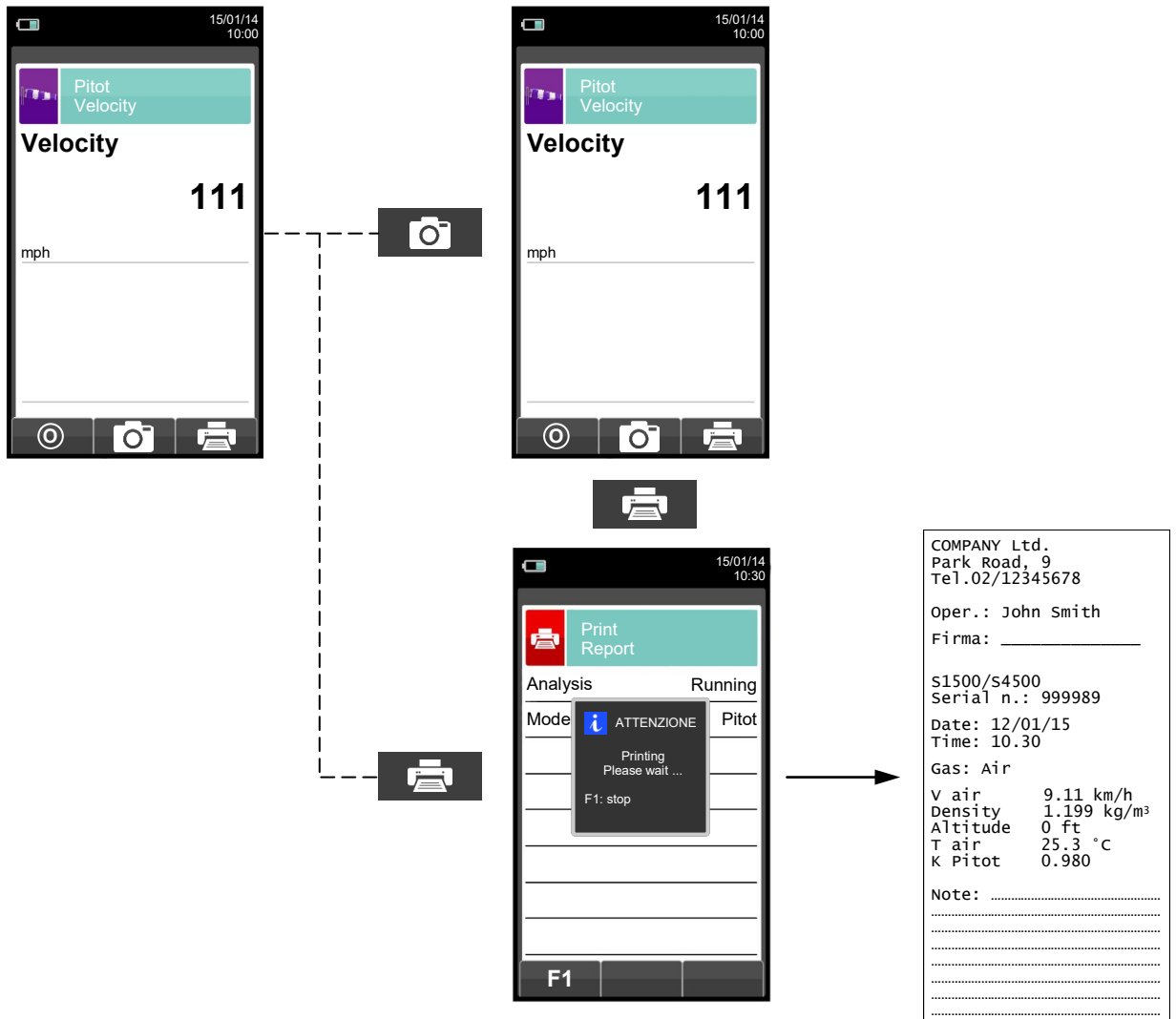
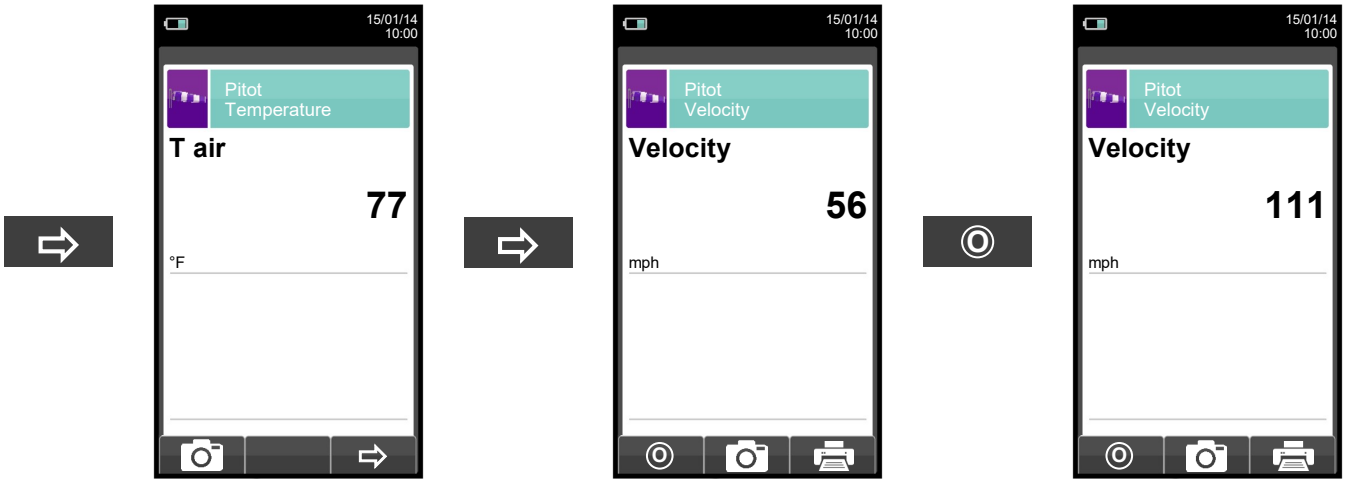



## 12.10 Measurements → Power of burner

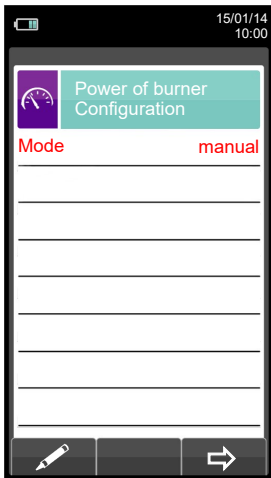

Enter the thermal power value calculated manually by the operator.

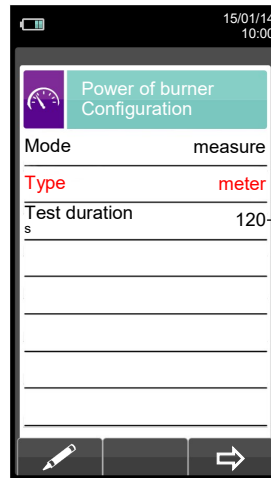

Test mode: you can choose to calculate the thermal power by entering a flow value, or by reading the volumetric counter (gaseous fuels only).

Duration of test: the option is displayed only for the test mode 'COUNTER', available for gaseous fuels. It is possible to enter the number of seconds between the reading of the initial and final gas volume. The minimum time required by law is 120 s.

KEY	FUNCTION
	Activate the context keys shown on the display.
	Selects line; the selected line is evidenced in red. When in modify mode, sets the desired value.
	In change moves the cursor to the box corresponding to the desired number to set the desired value.
	Activates the context key located in the left side of the display.
	Returns to the previous screen. When in modify mode cancels the modification just made.

CONTEXT KEY	FUNCTION
	Enters the modification mode for the selected parameter.
	Confirms the settings.
	Go to next step.
	Saves, in the memory selected in the "Memory Select" menu, the value of the draft measured.
	Stops the test.

## 12.10.1 TESTING IN 'MANUAL' MODE

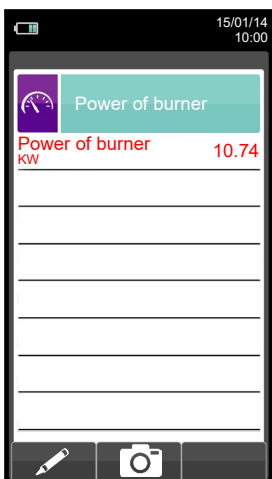
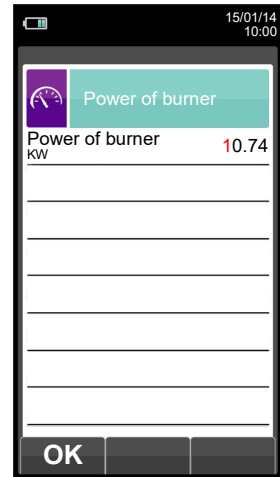
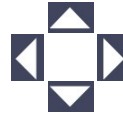
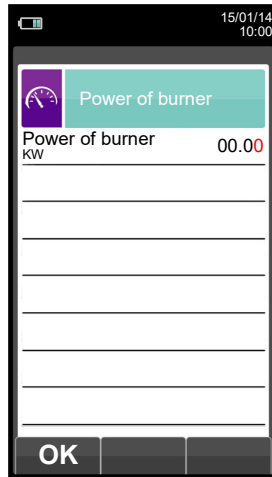
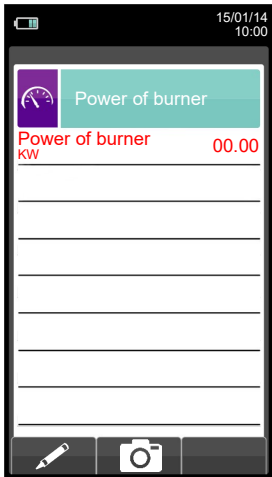

## 12.10.2 TESTING IN 'MEASURE' MODE (based on Flow rate)

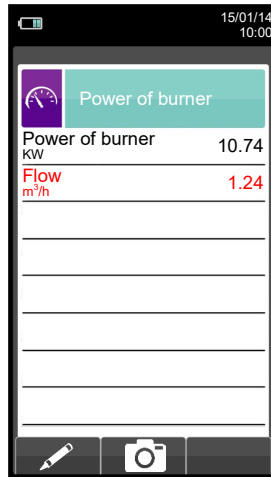
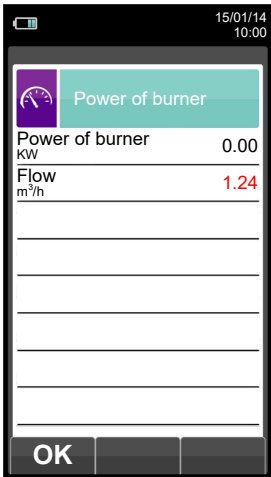
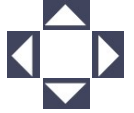
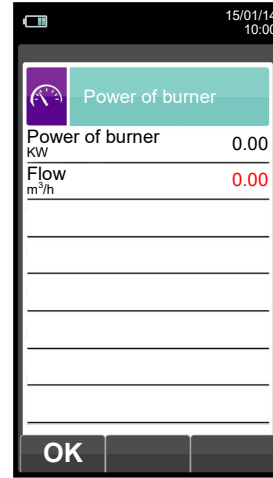
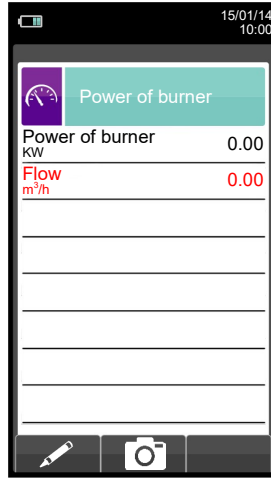
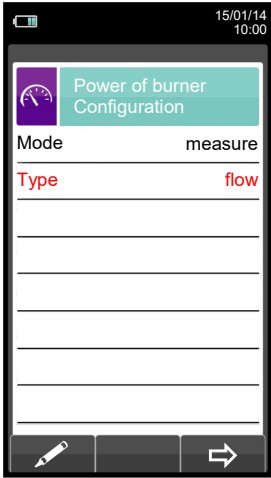

### 12.10.3 TESTING IN 'MEASURE' MODE (based on meter)

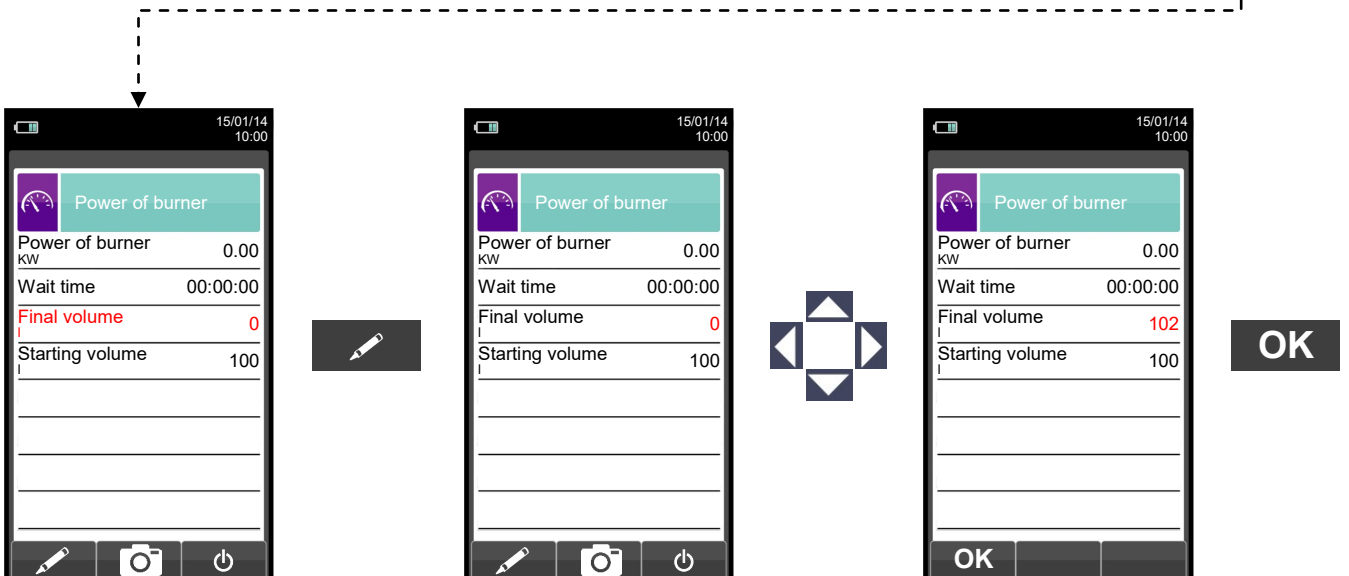
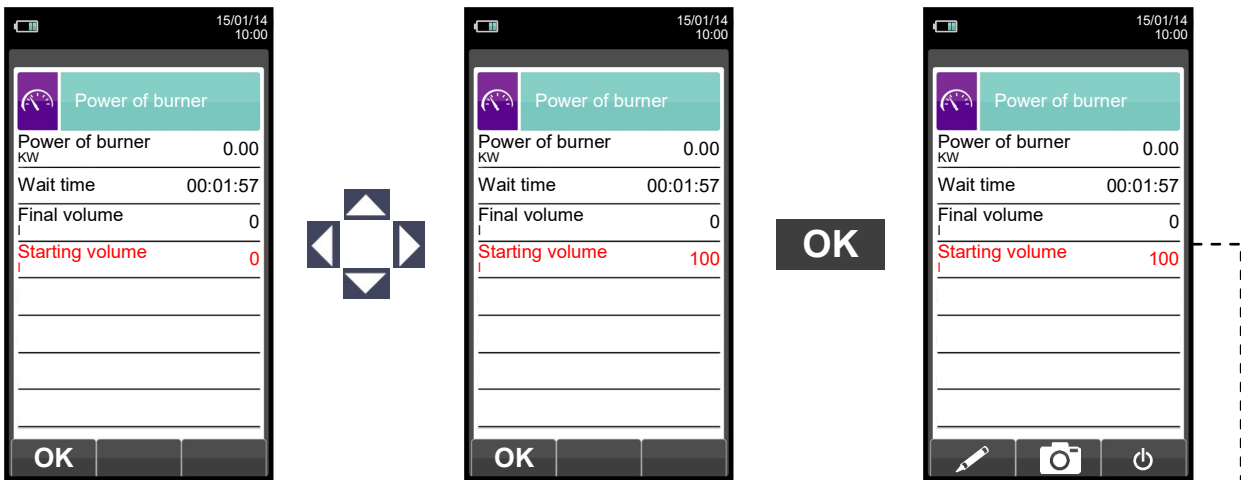





15/01/14  
10:00

Power of burner	
Power of burner KW	0.56
Wait time	00:00:00
Final volume	102
Starting volume	100

✎ 📷 🔌



## 12.11 Measurements → Ionization Current

Optional Ionization Probe Part AACSO01 needed for this measurement

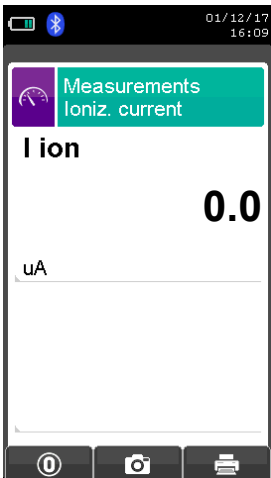

KEY	FUNCTION
	Activate the context keys shown on the display.
	Selects line; the selected line is evidenced in red. In edit mode, it sets the desired value.
	Activates the context key located in the left side of the display.
	Returns to the previous screen. When in modify mode cancels the modification just made.

CONTEXT KEY	FUNCTION
	Performs pressure zeroing.
	Saves, in the memory selected in the "Select Memory" menu, the data acquired.
	Starts printing the ticket. <a href="#">See chapter 11.</a>

### Example:

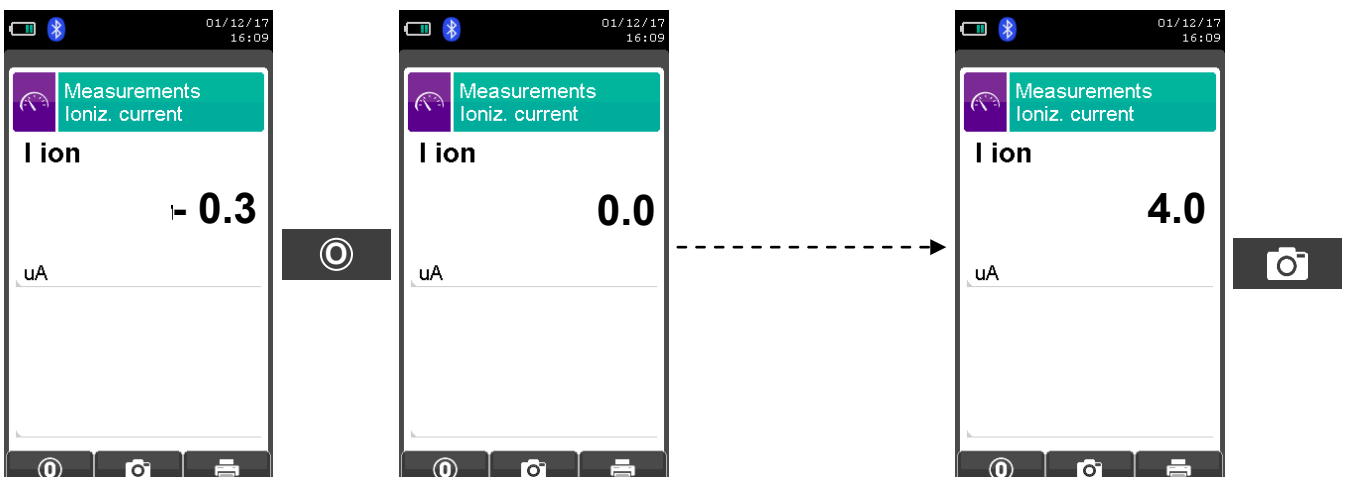



## 12.12 Measurements → Ventilation

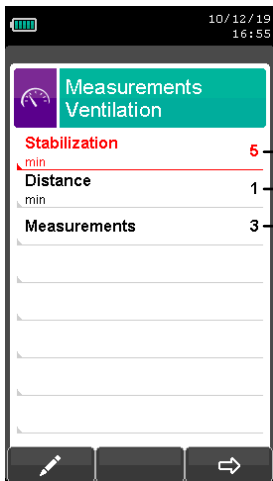

- System stabilization time after turning on the appliances and with the windows and doors closed (expressed in minutes)
- Time interval between one measure and the next (expressed in minutes)
- Number of measures

KEY	FUNCTION
	Activate the context keys shown on the display.
	Selects line; the selected line is evidenced in red. In edit mode, it sets the desired value.
	Activates the context key located in the left side of the display.
	Returns to the previous screen. When in modify mode cancels the modification just made.

CONTEXT KEY	FUNCTION
	Enters the modification mode for the selected parameter.
	Confirms the inserted data.
	Go to the next phase of the test.
	Repeat the measure.
	Interrupt the current phase.
	Stores, on the memory selected on the menu "Memory Select", the result of the test.
	Print the ticket. <a href="#">See chapter 11.</a>



### 12.12.1 Test execution

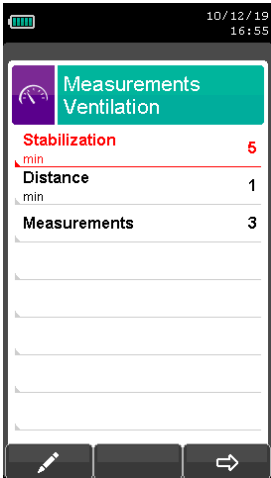

**MODIFY THE SELECTED ROW**

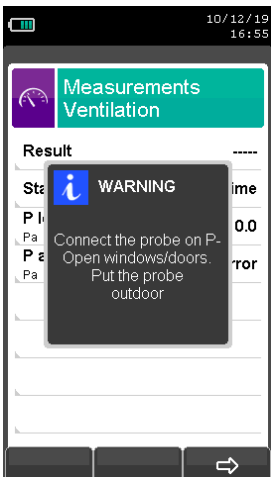

**INSERT THE PIPE THROUGH THE ROOM VENTILATION OPENING.**

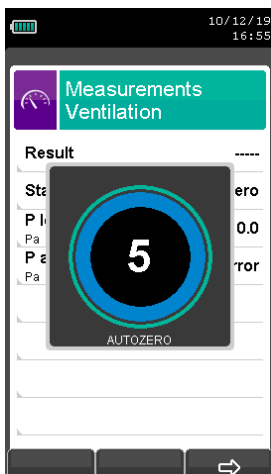
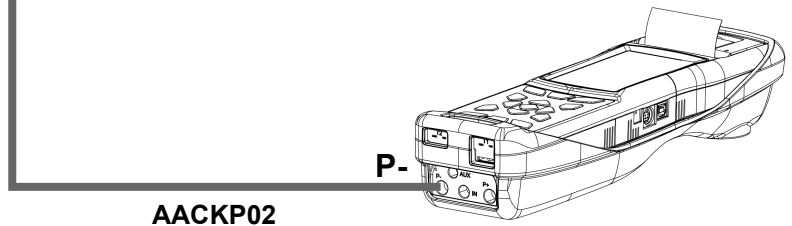

**WARNING**  
ON THIS PHASE KEEP DOORS / WINDOWS COMMUNICATING WITH THE EXTERNAL OF THE ROOM, OPEN.

**THE INSTRUMENT PERFORMS THE AUTO ZERO OF THE PRESSURE SENSOR.**





ONCE THE AUTO ZERO IS OVER PROCEED AS FOLLOWS:

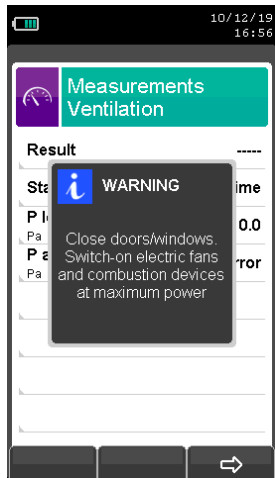

KEEP THE PIPE INSERTED THROUGH THE ROOM VENTILATION OPENING.

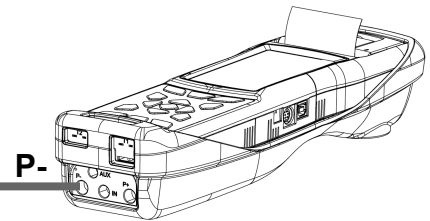

**WARNING**  
ON THIS PHASE KEEP DOORS / WINDOWS COMMUNICATING WITH THE EXTERNAL OF THE ROOM OR ROOMS NEXT TO THIS LATTER, OPEN.

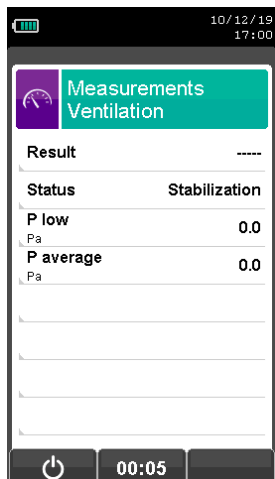

THE INSTRUMENT WAITS FOR THE SET STABILIZATION TIME AND WHEN THIS IS OVER PERFORMS THE 3 SET MEASUREMENTS.

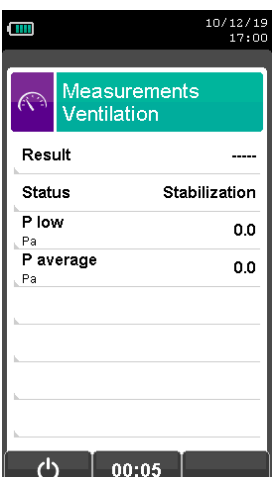

WHEN THE 3 MEASURES ARE DONE 3 THE DISPLAY SHOWS THE MEDIUM VALUE AND THE RESULT OF THE TEST.



## 13.1 FLUE GAS ANALYSIS



To perform complete flue gas analysis, follow the instructions below.



**SOME IMPORTANT WARNINGS TO CONSIDER DURING THE COMBUSTION ANALYSIS ARE LISTED BELOW:**

**FOR A CORRECT ANALYSIS NO AIR MUST FLOW INTO THE PIPE FROM OUTSIDE DUE TO A BAD TIGHTENING OF THE CONE OR A LEAK IN THE PIPELINE.**

**THE GAS PIPE MUST BE CHECKED IN ORDER TO AVOID ANY LEAKAGES OR OBSTRUCTIONS ALONG THE PATH.**

**THE CONNECTORS OF THE GAS SAMPLING PROBE AND OF THE CONDENSATE FILTER MUST BE WELL CONNECTED TO THE INSTRUMENT.**

**KEEP THE CONDENSATE TRAP IN THE VERTICAL POSITION DURING THE ANALYSIS; A WRONG POSITIONING MAY CAUSE CONDENSATE INFILTRATIONS IN THE INSTRUMENT AND THUS DAMAGE THE SENSORS.**

**DO NOT PERFORM ANY MEASUREMENT WHEN THE FILTER IS REMOVED OR DIRTY IN ORDER TO AVOID ANY RISK OF IRREVERSIBLE DAMAGES ON SENSORS.**

### 13.1.1 Switching on the instrument and auto-calibration

Press the On/Off key to switch on the instrument - an introductory screen will appear. After a couple of moments the instrument will zero itself and will state that the sample probe should not be inserted in the stack.

In case the instrument is equipped with the electro valve for automatic auto-zeroing, it will ask for the insertion of the gas probe in the stack. On the other hand if the instrument has not the electro valve, it will require not to insert the gas probe in the stack.

In the latter it is important that the sample probe is not inside the stack since, during auto-calibration, the instrument draws fresh air from the environment and detects the zero value of the O<sub>2</sub>, CO and NO sensors, the details of which are then memorized and used for reference during the analysis. It is equally important that this phase is performed in a fresh-air environment.

The pressure sensor is also zeroed during auto-calibration.

### 13.1.2 Inserting the probe inside the stack

When auto-calibration is complete the instrument will instruct the user to insert the sample probe that has been previously connected to the relative input on the instrument, and the analysis screen will appear automatically.

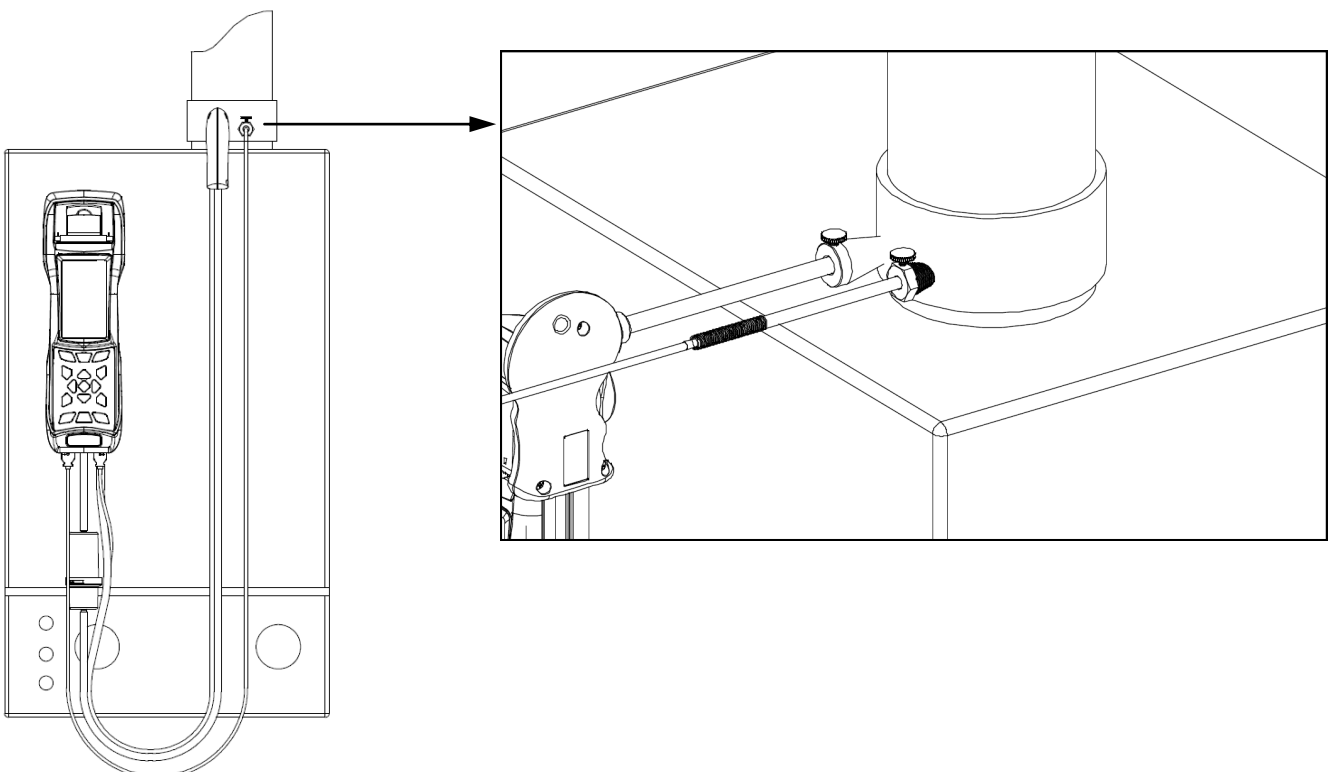



In order for the probe to be inserted at the right point within the stack, its distance from the boiler has to be twice the diameter of the stack pipe itself or, if this is not possible, must comply with the boiler manufacturer's instructions.

In order to position the probe correctly, a reliable support must be provided by drilling a 13/16 mm hole in the manifold (unless already present) and screwing in the positioning cone provided with the probe - in this way no air is drawn from the outside during sampling.

The screw on the cone allows the probe to be stopped at the right measuring depth - this usually corresponds to the centre of the exhaust pipe. For greater positioning accuracy, the user may insert the probe gradually into the pipe until the highest temperature is read. The exhaust pipe must be inspected before carrying out the test, so as to ensure that no constrictions or losses are present in the piping or stack.

### 13.1.3 Simultaneous measurement of pressure, O<sub>2</sub>, pollutants

In order to measure simultaneously pressure, O<sub>2</sub> and pollutants levels as well as all the others calculated parameters necessary to obtain the correct performance value, connect the instrument as follows:

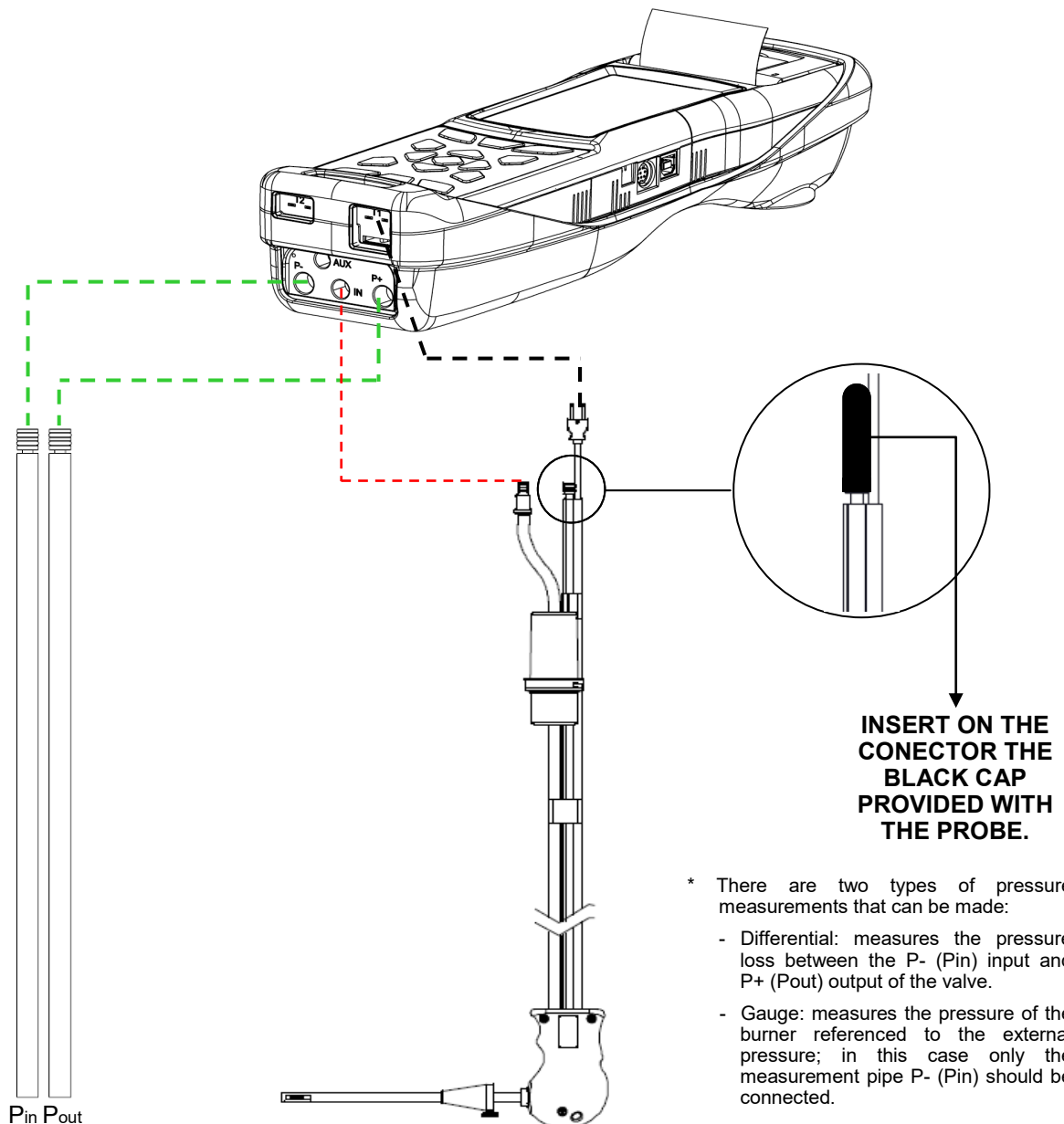



### 13.1.4 Flue Gas Analysis

After the sample probe has been inserted in the stack and the combustion air temperature probe (if used) has been inserted in the relative sample manifold, if the instrument has not been configured during auto-calibration, the following data must be configured:

**Memory:** use this submenu to define the memory in which the test data and client details are to be stored.

**Fuel:** the user will be asked to define the type of fuel used by the plant.

**Operator:** this is where the name of the test operator can be entered.

**Mode:** by entering this submenu, the user can determine the analysis mode - manual or automatic.

If automatic mode is chosen, the reading duration of each and every test must be set, besides the printing mode - manual or automatic. When flue gas analysis begins, the instrument will perform and memorise the three tests automatically, at the respective intervals set: at least 60 seconds.

At the end of each test the instrument will emit an audible alarm (one "beep" after the first test, two "beeps" after the second test and three "beeps" after the third test).

At this point, when all three tests are over, if "Manual Printing" has been chosen the instrument will display the average of the three tests with the possibility of recalling the individual values.

If desired, the user can then print the relative data (total, complete, etc...). On the contrary, if "Automatic Printing" was selected, the instrument will print the test data automatically, based on the current print settings, without displaying the average test values.

**Caution: when in automatic mode Draft, Smoke and ambient CO (NO) measurements must be taken before initiating the flue gas analysis.**



If, on the other hand, manual analysis mode is chosen, flue gas analysis will proceed manually (please see relative Flow Chart). In this case the print settings and automatic test duration will not be considered.

At this point manual analysis may commence, first waiting at least two minutes until the displayed values stabilise: The user can then proceed with data storage, if required, or print the analysis report directly.

The latter will be printed in the format set beforehand.

When all three tests are over, the user can recall the average analysis screen containing all the data necessary for compiling the maintenance log of the boiler or plant.

While in manual analysis, holding pressed both keys  and  makes the instrument switch off the suction fumes pump and blocks the refresh of any current measure.

To switch on the suction fumes pump again and reactivate the refresh of the current measure, press again the keys  and .

In both modes, automatic and manual, the displayed data of the pollutants CO / NO / NO<sub>x</sub> can be translated into normalised values (with reference to the concentration of O<sub>2</sub> previously set).

### 13.1.5 End of Analysis

At the end of the combustion analysis, carefully remove the sample probe and remote air temperature probe, if used, from their relative ducts, taking care not to get burnt.

Switch off the instrument by pressing the On/Off key.

At this point, if the instrument has detected a high concentration of CO and/or NO, a self-cleaning cycle will be initiated during which the pump will draw fresh outside air until the gas levels drop below acceptable values.

At the end of the cycle (lasting no longer than 3 min.) the instrument will switch itself off automatically.



### 13.2 FLUE GAS ANALYSIS - PRELIMINARY OPERATIONS

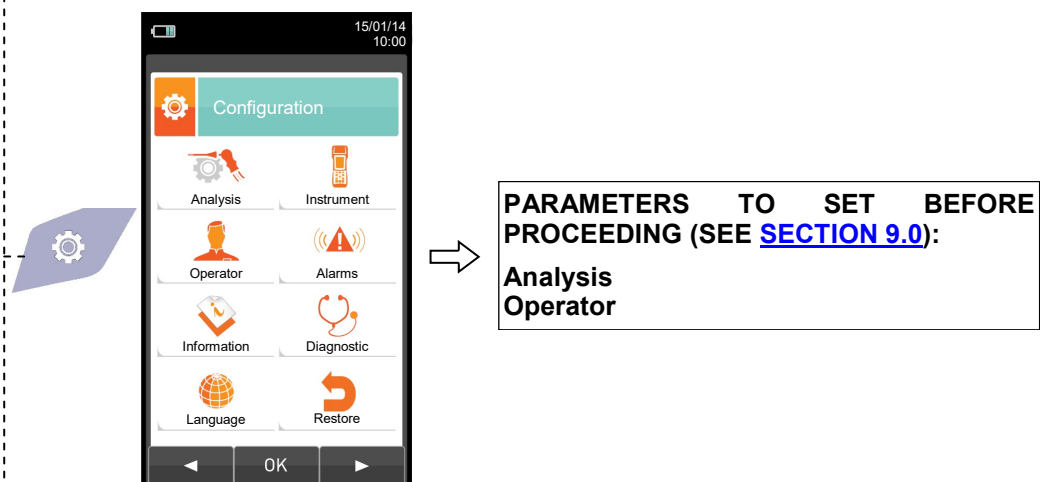
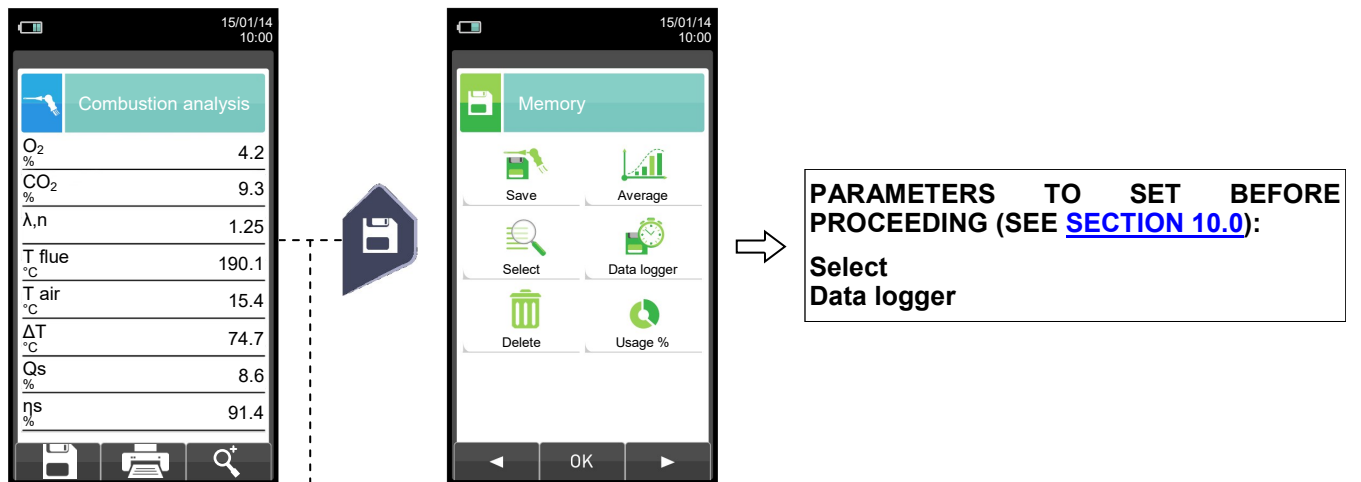
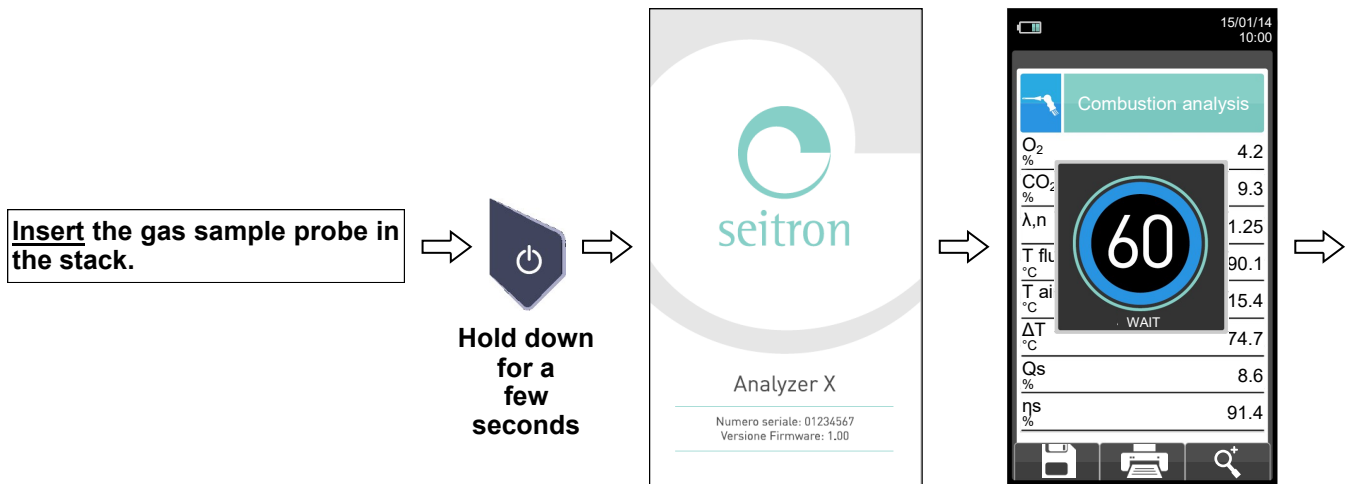

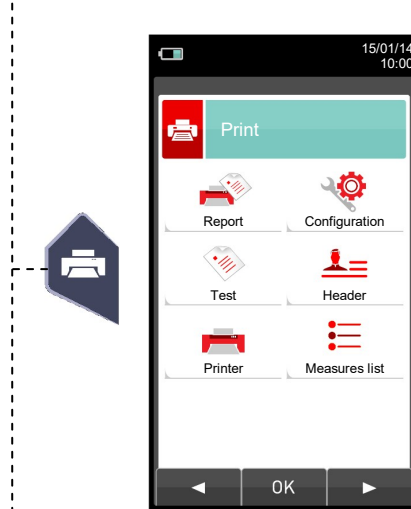

**PARAMETERS TO SET BEFORE PROCEEDING (SEE [SECTION 11.0](#)):**

**Configuration  
Header  
Measures list**

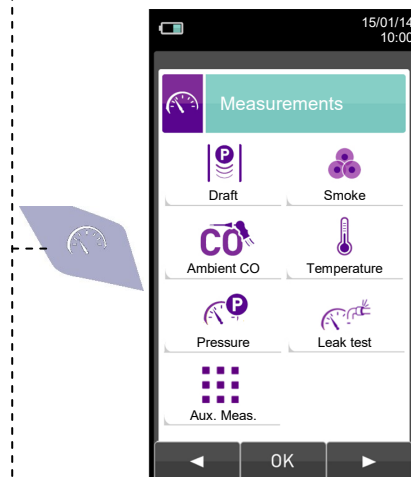

**ACQUIRE THE FOLLOWING MEASUREMENTS BEFORE PROCEEDING WITH THE COMBUSTION ANALYSIS ([Section 12.0](#)):**



**In you don't, the measurements will not be printed with the combustion analysis.**

**Draft  
Smoke  
Ambient CO  
Temperature  
Pressure**

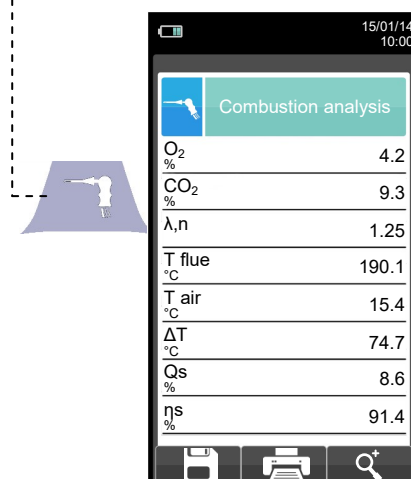

**PRESS THE KEY '  ':**

**It starts saving the current analysis according to the set mode.**

- Manual [See section 13.3](#)
- Data logger [See section 13.4](#)

**PRESS THE KEY '  ':**

**It starts the printing on test ticket of the current analysis; additional measurements are also printed, if they are present in the memory.**

### 13.3 PERFORMING COMBUSTION ANALYSIS - MANUAL MODE



Combustion analysis	
O <sub>2</sub> %	4.2
CO <sub>2</sub> %	9.3
λ,n	1.25
T flue °C	190.1
T air °C	15.4
ΔT °C	74.7
Qs %	8.6
ηs %	91.4



Memory Save	
Mode	manual
Memory	12
Analysis	1

**OK**  
Saves analysis number 1

Combustion analysis	
O <sub>2</sub> %	4.2
CO <sub>2</sub> %	9.3
λ,n	1.25
T flue °C	190.1
T air °C	15.4
ΔT °C	74.7
Qs %	8.6
ηs %	91.4



Memory Save	
Mode	manual
Memory	12
Analysis	2

**OK**  
Saves analysis number 2

Combustion analysis	
O <sub>2</sub> %	4.2
CO <sub>2</sub> %	9.3
λ,n	1.25
T flue °C	190.1
T air °C	15.4
ΔT °C	74.7
Qs %	8.6
ηs %	91.4



Memory Save	
Mode	manual
Memory	12
Analysis	3

**OK**  
Saves analysis number 3

Combustion analysis	
O <sub>2</sub> %	4.2
CO <sub>2</sub> %	9.3
λ,n	1.25
T flue °C	190.1
T air °C	15.4
ΔT °C	74.7
Qs %	8.6
ηs %	91.4



Memory	
Save	Average
Select	Data logger
Delete	Usage %

**Recalls the average analysis.**





15/01/14 10:00

Memory Average analysis

O <sub>2</sub> %	4.2
CO <sub>2</sub> %	9.3
λ,n	1.25
T flue °C	190.1
T air °C	15.4
ΔT °C	74.7
Qs %	8.6
ηs %	91.4

Print icon | Search icon



15/01/14 10:00

Print Report

Memory	12
Analysis	Average
Model	partial

OK



15/01/14 10:00

Print Report

Memory	12
Analysis	Average
Model	partial

WARNING: Printing. Please wait... F1: stop

OK



15/01/14 10:00

Memory Average analysis

O <sub>2</sub> %	4.2
CO <sub>2</sub> %	9.3
λ,n	1.25
T flue °C	190.1

Print icon | Search icon



Date: 15/01/14  
Time: 10.10  
Fuel: Natural gas  
Altitude: 0 m  
R.H. air: 50 %

O <sub>2</sub>	4.2 %
CO <sub>2</sub>	9.3 %
λ,n	1.25
T flue	190.2 °C
T air	15.4 °C
ΔT	174.8 °C
QS	8.6 %
ηs	91.4 %
ET	4.9 %
ηt	91.4 %
CO	148 ppm
NO	40 ppm
NOX/NO:	1.03
NOX	41 ppm
Amb. CO	0 ppm
Draft:	0.05 hPa
T out:	20 °C
Smoke:	3 1 2
Aver. n:	2

15/01/14 10:00

Print Report

Memory	12
Analysis	Average
Model	partial

OK



15/01/14 10:00

Print Report

Memory	12
Analysis	Average
Model	partial

WARNING: Printing. Please wait... F1: stop

OK



### 13.4 PERFORMING THE COMBUSTION ANALYSIS - DATA LOGGER MODE



Combustion analysis	
O <sub>2</sub> %	4.2
CO <sub>2</sub> %	9.3
λ,n	1.25
T flue °C	190.1
T air °C	15.4
ΔT °C	74.7
Qs %	8.6
ηs %	91.4



Memory Save	
Mode	data logger
Memory	1
Samples	10
Interval s	60



Combustion analysis data logger	
O <sub>2</sub> %	4.2
CO <sub>2</sub> %	9.3
λ,n	1.25
T flue °C	190.1
T air °C	15.4
ΔT °C	74.7
Qs %	8.6
ηs %	91.4



Combustion analysis data logger	
O <sub>2</sub> %	4.2
CO <sub>2</sub> %	9.3
λ,n	1.25
T flue °C	190.1
T air °C	15.4
ΔT °C	74.7
Qs %	8.6
ηs %	91.4

**WARNING**  
Data logger active.  
Interrupt?

F1: Interrupt  
F2: continue  
F3: pause

F1    F2    F3



**Automatically saves the first sample when the set time is over.**

Combustion analysis data logger	
O <sub>2</sub> %	4.2
CO <sub>2</sub> %	9.3
λ,n	1.25
T flue °C	190.1
T air °C	15.4
ΔT °C	74.7
Qs %	8.6
ηs %	91.4

**Automatically saves the second sample when the set time is over and so on until the last sample.**





**NOTE:** If, while configuring the tightness test the automatic printing mode has been selected, the tightness test is printed automatically.

Instead, if the manual printing mode has been selected (exemplified case), at the end of the tightness test the results are displayed and they can be saved and/or printed. In this case proceed as follows:

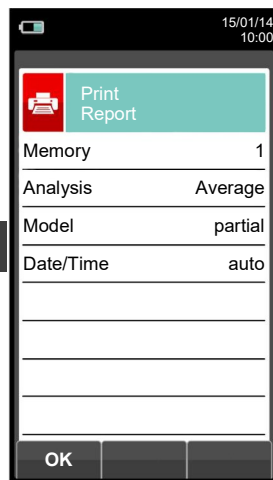
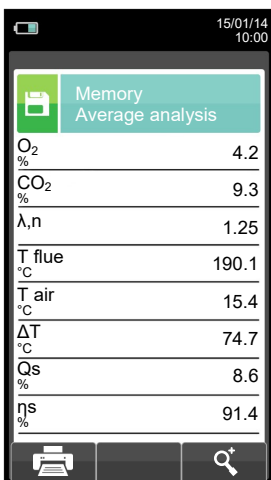

OK



Date:	15/01/14
Time:	10.10
Fuel:	Natural gas
Altitude:	0 m
R.H. air:	50 %
O <sub>2</sub>	4.2 %
CO <sub>2</sub>	9.3 %
λ, n	1.25
T flue	190.2 °C
T air	15.4 °C
ΔT	174.8 °C
Qs	8.6 %
ηs	91.4 %
ET	4.9 %
nt	91.4 %
CO	148 ppm
NO	40 ppm
NOX/NO:	1.03
NOX	41 ppm
Amb. CO	0 ppm
Draft:	0.05 hPa
T out:	20 °C
Smoke:	3 1 2
Aver. n:	2

## 14.1 Sensors arrangement

SENSORS ARRANGEMENT INSIDE THE SENSORS COMPARTMENT

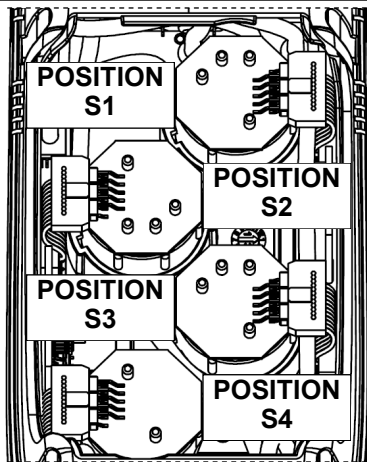

GRAPHICAL DISPLAY OF ARRANGEMENT

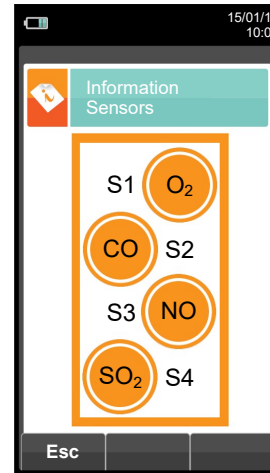

## 14.2 Sensor types and relevant positioning

CODE	POSITION	S1	S2	S3	S4
<b>Flex-Sensor O<sub>2</sub> LL</b> Cod. AACSE44		✓			
<b>Flex-Sensor O<sub>2</sub></b> Cod. AACSE15R		✓			
<b>Flex-Sensor CO+H<sub>2</sub></b> Cod. AACSE12			✓		
<b>Flex-Sensor CO high immunity H<sub>2</sub></b> Cod. AACSE20			✓	✓	✓
<b>Flex-Sensor NO</b> Cod. AACSE10				✓	
<b>Flex-Sensor NO<sub>2</sub></b> Cod. AACSE14			✓	✓	✓
<b>Flex-Sensor SO<sub>2</sub></b> Cod. AACSE13			✓	✓	✓
<b>Flex-Sensor SO<sub>2</sub> 1.000 ppm</b> Cod. AACSE77			✓	✓	✓
<b>Flex-Sensor CO 100.000 ppm</b> Cod. AACSE17			✓	✓	✓
<b>Flex-Sensor CO 20.000 ppm</b> Cod. AACSE18			✓	✓	✓
<b>FLEX-Sensor CxHy 0-5.00% vol. referred to CH<sub>4</sub></b> Cod. AACSE23				✓	✓
<b>Flex-Sensor for gas leaks</b> Cod. AACSE19					✓
<b>Flex-Sensor CO+H<sub>2</sub> low range</b> Cod. AACSE24			✓		
<b>Flex-Sensor NO low range</b> Cod. AACSE25				✓	
<b>Flex-Sensor NO<sub>2</sub> low range</b> Cod. AACSE26			✓	✓	✓
<b>Flex-Sensor SO<sub>2</sub> low range</b> Cod. AACSE28			✓	✓	✓
<b>Flex-Sensor CO<sub>2</sub> 0 .. 20% v/v</b> Cod. AACSE21				✓	✓
<b>Flex-Sensor CO<sub>2</sub> 0 .. 50% v/v</b> Cod. AACSE47				✓	✓

### 14.3 Gas sensors life

The gas sensors used in this instrument are electrochemical: thus, when the relative gas is detected, a chemical reaction takes place inside them that generates an electrical current.

The electrical current acquired by the instrument is then converted into the corresponding gas concentration. Sensor life is strongly related to the consumption of the reagents within.

Sensor characteristics diminish as the reagents are consumed and when these have been used up completely the sensor must be replaced. The sensors must be recalibrated on a regular basis to assure measuring accuracy: recalibration can only be performed by a qualified SEITRON AMERICAS service centre.

Chart 14.4 illustrates the characteristics inherent to each sensor.

### 14.4 Gas sensors life table

CODE	MEASURED GAS	IDENTIFYING COLOR <sup>(1)</sup>	AVERAGE LIFE	RECALIBRATION
<b>Flex-Sensor O<sub>2</sub> LL</b> Cod. AACSE44	O <sub>2</sub> Oxygen		48 months	not necessary
<b>Flex-Sensor O<sub>2</sub></b> Cod. AACSE15R	O <sub>2</sub> Oxygen		>24 months	not necessary
<b>Flex-Sensor CO+H<sub>2</sub></b> Cod. AACSE12	CO Carbon Monoxide	Red	48 months	Yearly <sup>(2)</sup>
<b>Flex-Sensor CO high immunity H<sub>2</sub></b> Cod. AACSE20	CO Carbon Monoxide		>36 months	Yearly <sup>(2)</sup>
<b>Flex-Sensor NO</b> Cod. AACSE10	NO Nitrogen Oxide	Orange	48 months	Yearly <sup>(2)</sup>
<b>Flex-Sensor NO<sub>2</sub></b> Cod. AACSE14	NO <sub>2</sub> Nitrogen Dioxide	White	36 months	Yearly <sup>(2)</sup>
<b>Flex-Sensor SO<sub>2</sub></b> Cod. AACSE13	SO <sub>2</sub> Sulphur Dioxide	Green	36 months	Yearly <sup>(2)</sup>
<b>Flex-Sensor SO<sub>2</sub> 1.000 ppm</b> Cod. AACSE77	SO <sub>2</sub> Sulphur Dioxide		36 months	Yearly <sup>(2)</sup>
<b>Flex-Sensor CO 100000 ppm</b> Cod. AACSE17	CO Carbon Monoxide	Purple	48 months	Yearly <sup>(2)</sup>
<b>Flex-Sensor CO 20.000 ppm</b> Cod. AACSE18	CO Carbon Monoxide	Blue	48 months	Yearly <sup>(2)</sup>
<b>FLEX-Sensor C<sub>x</sub>H<sub>y</sub> 0-5.00% vol. referred to CH<sub>4</sub></b> Cod. AACSE23	C <sub>x</sub> H <sub>y</sub> Unburnt Hydrocarbons		48 months	Yearly <sup>(2)</sup>
<b>Flex-Sensor for gas leaks</b> Cod. AACSE19	Leak detector Methane / LPG		5 years	not necessary
<b>Flex-Sensor CO+H<sub>2</sub> low range</b> Cod. AACSE24	CO Carbon Monoxide	Red	48 months	Yearly <sup>(2)</sup>
<b>Flex-Sensor NO low range</b> Cod. AACSE25	NO Nitrogen Oxide	Orange	48 months	Yearly <sup>(2)</sup>
<b>Flex-Sensor NO<sub>2</sub> low range</b> Cod. AACSE26	NO <sub>2</sub> Nitrogen Dioxide	White	48 months	Yearly <sup>(2)</sup>
<b>Flex-Sensor SO<sub>2</sub> low range</b> Cod. AACSE28	SO <sub>2</sub> Sulphur Dioxide	Green	48 months	Yearly <sup>(2)</sup>
<b>Flex-Sensor CO<sub>2</sub> 0 .. 20% v/v</b> Cod. AACSE21	CO <sub>2</sub> Carbon Dioxide		>48 months	Yearly <sup>(2)</sup>
<b>Flex-Sensor CO<sub>2</sub> 0 .. 50% v/v</b> Cod. AACSE47	CO <sub>2</sub> Carbon Dioxide		>48 months	Yearly <sup>(2)</sup>

#### Notes:

(1) Coloured dot on the sensor electronic board.

(2) The standard requires for the instrument calibration once per year to be performed in a laboratory authorised to issue calibration certificates.



**S1500-XX**

2 sensors, expandable to 3 or 4 sensors.

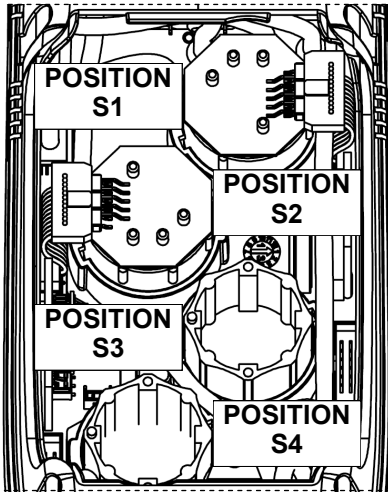

**S4500-XX**

3 sensors, expandable to 4 sensors.

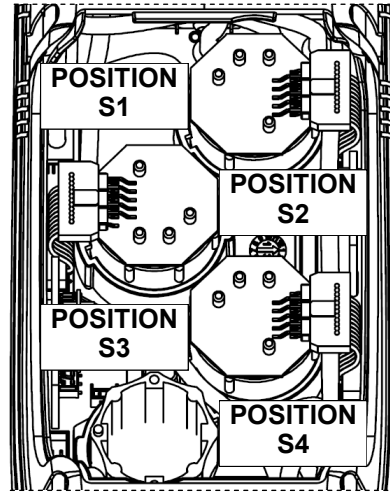

**14.5 Expandability to 4 sensors**

The S4500 instruments can be expanded to 4 sensors.

The upgrading of the number of sensors can be easily done by the user by performing the following directions:

- The expandable instruments are arranged in a way to accept one or two additional sensors in positions S3 and S4.
- Identify, with the help of paragraph 5.2 'Sensor types and relevant positioning' the sensor(s) which must be added to the existing configuration (Seitron Americas delivers all FLEX-series sensors already pre-calibrated and ready to use).
- To install the new sensors follow all the steps described in the paragraph 'MAINTENANCE' under 'gas sensors replacement'.



**THE INSTRUMENT AUTOMATICALLY DETECTS WHEN AN ADDITIONAL SENSOR IS INSTALLED OR HAS BEEN REMOVED. THE SCREEN 'SENSORS CONFIGURATION' ALLOWS TO ACCEPT THE NEW PROPOSED CONFIGURATION OR TO IGNORE THE CHANGE DETECTED.**

**IN THIS SCREEN ARE SHOWN, FOR EACH POSITION, THE FOLLOWING MESSAGES:**

**EXAMPLE OF AN 'NO' SENSOR IN POSITION 3 REPLACED WITH AN 'NO2' SENSOR:**

**NO→NO<sub>2</sub> A SENSOR DIFFERENT FROM THE PREVIOUS ONE HAS BEEN DETECTED.**

**EXAMPLE OF A NEW SENSOR INSTALLED IN POSITION 4 (PREVIOUSLY NOT PRESENT):**

**SO<sub>2</sub>→□ A NEW SENSOR HAS BEEN DETECTED.**

### 14.6 CxHy sensor for measurement of the unburnt hydrocarbons

The unburnt hydrocarbons are chemicals produced by an incomplete combustion of molecules (hydrocarbons) made of Carbon and Hydrogen.

These are usually named as HC or (better) CxHy: when this is filled with the actual values for the number of C and H atoms, the actual type of fuel is exactly defined. In case of Methane, as an example, the correct formula is CH4. In the following table is shown the cross sensitivity of the CxHy sensor when exposed to fuels different from Methane (CH4), assumed as 1.00.

GAS / VAPOR	RELATIVE RESPONSE (with respect to Methane)	GAIN ADJUSTMENT
Ethanol	0.75	1.33
Iso-Butane	0.60	1.67
Methane	1.00	1.00
Methanol	1.00	1.00
n-Butane	0.60	1.67
n-Heptane	0.45	2.22
n-Hexane	0.50	2.00
Propane	0.70	1.43

Calculation example:

Type of gas: iso-butane  
 Relative response: 0.6  
 Gain adjustment: 1.67  
 Reading value (related to methane): 1.34

Value = reading value x gain adjustment

Example: 1.34 x 1.67 = 2.24

**WARNING**

Gas vapors which contain silicon compounds (HMDS) can irreversibly damage the sensor.

#### 14.6.1 Installing the CxHy sensor

When the CxHy (position S3/S4) is mounted in the instrument, it is mandatory to configure the autozero by setting it at 180 seconds, in order to allow for a proper pre-heating of the sensor itself.

The instrument battery life, once the CxHy is installed, lasts 10 hours, provided no printing is made.

Configuration → Analysis → Autozero (SEE [SECTION 9.2.6](#))

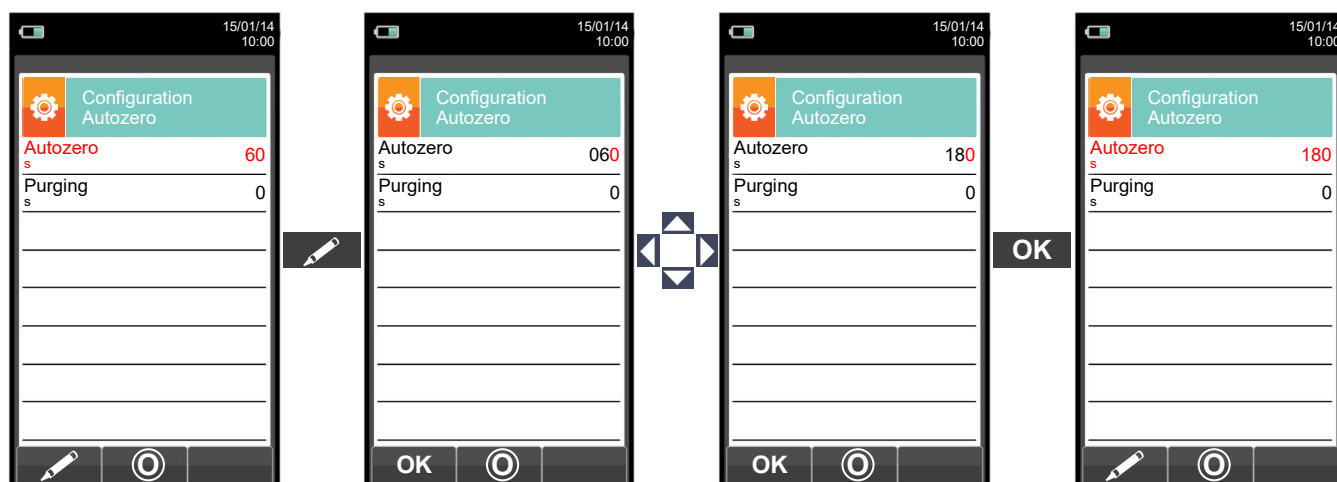

## 14.7 CO<sub>2</sub> sensor for Carbon Dioxide measurement in combustion processes

Carbon Dioxide (CO<sub>2</sub>) is the result of combustion of an organic compound in presence of a quantity of oxygen sufficient to complete its oxidation. In nature, it is also produced by aerobic bacteria during the process of alcoholic fermentation and is the by product of respiration.

Many combustion processes are defined with 'mixed fuel' and is therefore difficult to calculate the amount of CO<sub>2</sub> produced. To avoid this drawback, the only way to know the amount of CO<sub>2</sub> produced in a combustion process with 'mixed fuel' is to measure the CO<sub>2</sub> with special NDIR sensors.

### 14.7.1 Installing the CO<sub>2</sub> sensor

When the CO<sub>2</sub> (position S3/S4) is mounted in the S1500/S4500, it is mandatory to configure the autozero by setting it at 60 seconds, in order to allow for a proper pre-heating of the sensor itself.

Configuration → Analysis → Autozero (SEE [SECTION 9.2.6](#))

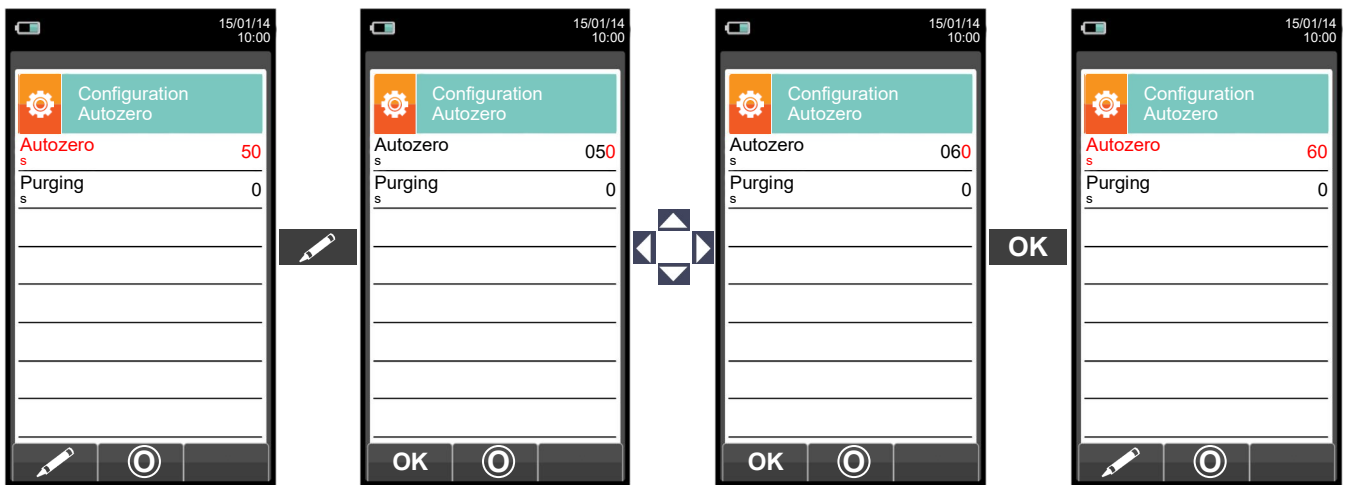
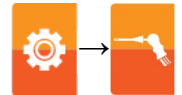

## 14.8 Sensor for combustible gas leaks

In order to detect gas leaks in plant, pipes and appliances the S1500/S4500 requires an internal semiconductor sensor for gas leaks.

This sensor responds to both CH<sub>4</sub> (Methane) and LPG (IsoButane and IsoPropane) as well as several other combustible gases (hydrocarbons).

### Technical Features

Measuring range: 0 .. 50000 ppm

Warm-up time: 60 seconds

Average life of sensor: 5 years

### WARNING

**Gas vapors which contain silicon compounds (HMDS) can irreversibly damage the sensor.**

### 14.8.1 Installation of the sensor for combustible gas leaks

The sensor for combustible gas leaks must be installed in the instrument only in position S4; perform all the steps described in the chapter "SERVICE" in "gas sensors replacement".

### 14.8.2 Performing the test

[SEE SECTION 12.0.](#)

## 15.1 Routine maintenance

This instrument was designed and manufactured using top-quality components. Proper and systematic maintenance will prevent the onset of malfunctions and will increase instrument life altogether.

The following basic requisites are to be respected:

- Do not expose the instrument to substantial thermal shocks before use. If this happens, wait for the temperature to return to normal working values.
- Do not extract flue gas samples directly without using a particulate/water trap.
- Do not exceed sensor overload thresholds.
- When the analysis is over disconnect the sample probe and let S1500/S4500 draw fresh air for a few minutes, or at least until the displayed parameters return to their original values.
- Clean the filter unit when necessary, replacing the particulate filter and applying a jet of air to the sample probe hose to eliminate any condensate that may have formed.

Do not clean the instrument with abrasive cleaners, thinners or other similar detergents.

## 15.2 Preventive maintenance

At least once a year send the instrument to a SERVICE CENTER for a complete overhaul and thorough internal cleaning.

SEITRON AMERICAS highly qualified staff is always at your disposal and will provide you with all the sales, technical, application and maintenance details required.

The service centre will always return the instrument to you as new and in the shortest time possible. Calibration is performed using gases and instruments comparable with National and International Specimens. Annual servicing is accompanied by a specific calibration certificate that is a guarantee of perfect instrument performance.

## 15.3 Cleaning the sample probe

When you finish using the sample probe clean it thoroughly as described below before returning it to its case:

- Disconnect the sample probe from the instrument and from the water trap (Fig. a-b) then blow a jet of clean air into the hose of the probe (refer to Fig. b) to remove any residual condensate that may have formed within.

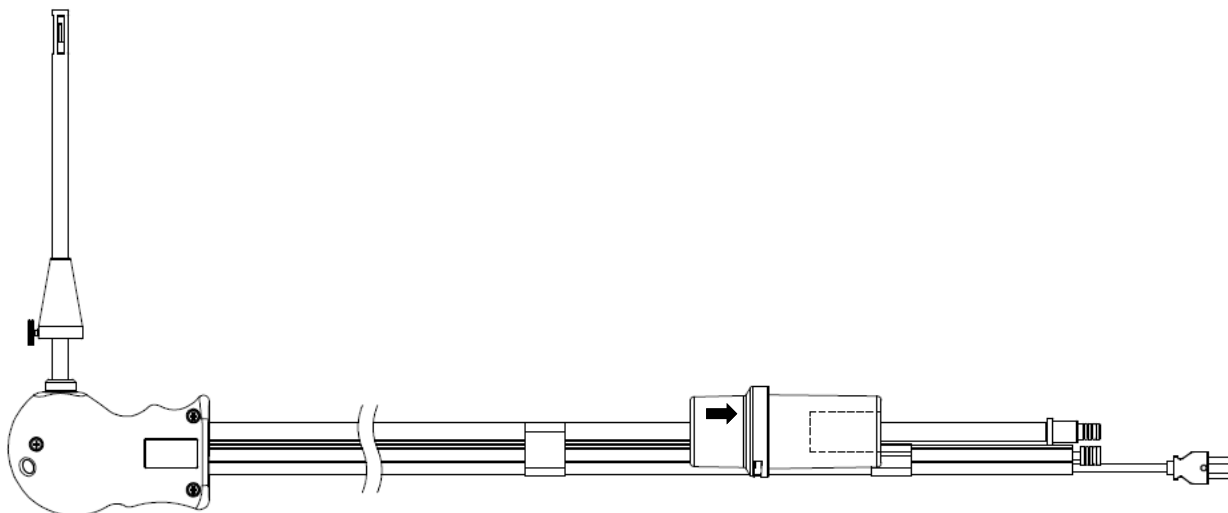

Fig. a

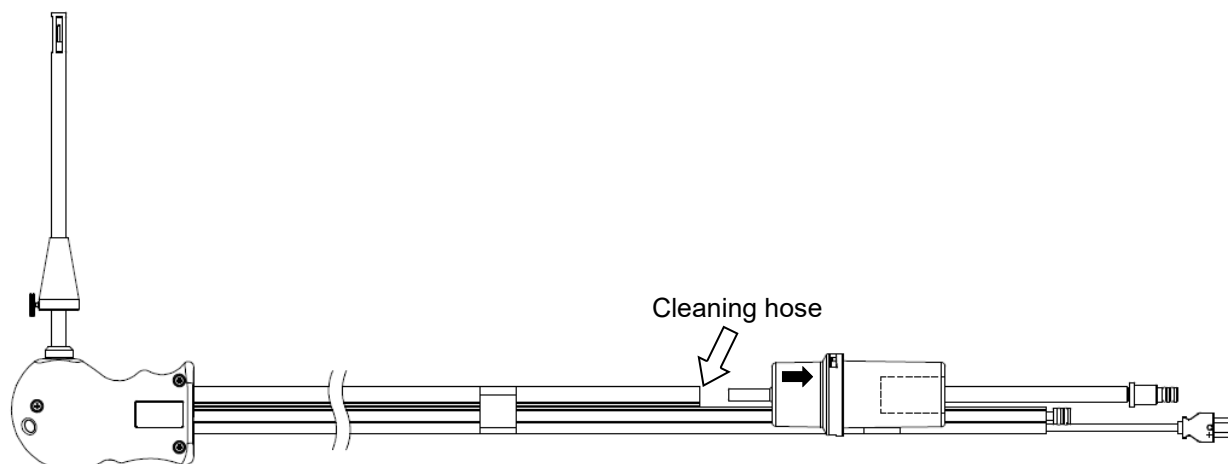
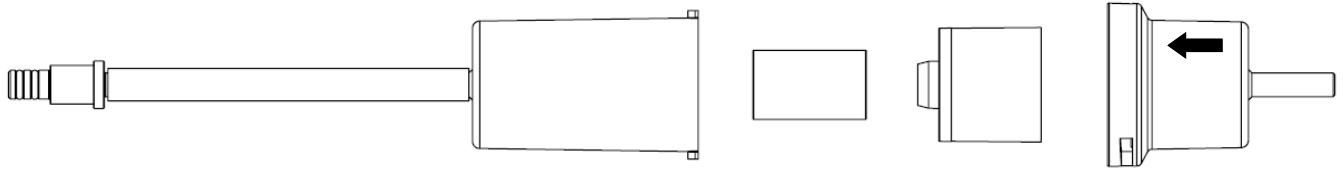

Fig. b

### 15.4 Maintaining the water trap / filter unit

To remove the water trap, just rotate the cover and unhook the filter holder body; remove the internal cup and then replace the filter (see figure on the side).

Clean all the filter parts using water only, dry the components and reassemble the filter.



### 15.5 Replacing the particulate filter

If the particulate filter appears black, especially on the inner surface (see adjacent example), it has to be replaced immediately. In this way gas flow is not obstructed.

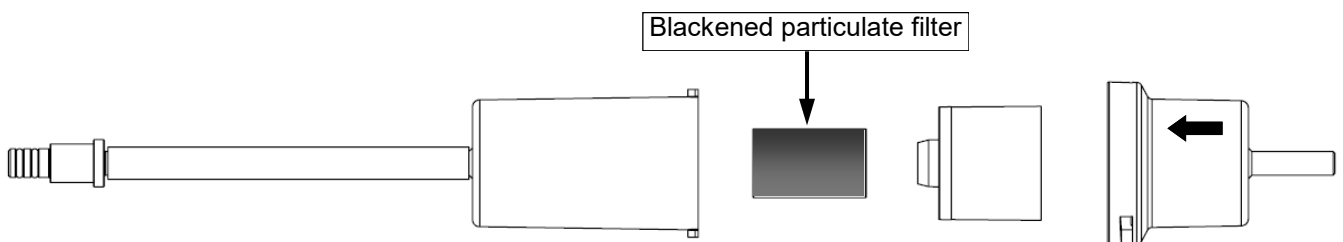

### 15.6 Replacing the gas sensors

The gas sensors of the instrument shall be periodically replaced (see the following table) with new or recalibrated sensors.

The user can easily perform this replacement operation according to the following instructions:

- 1 Undo the two fixing screws on the sensor compartment cover.
- 2 Extract the cover to have access to the sensor compartment.

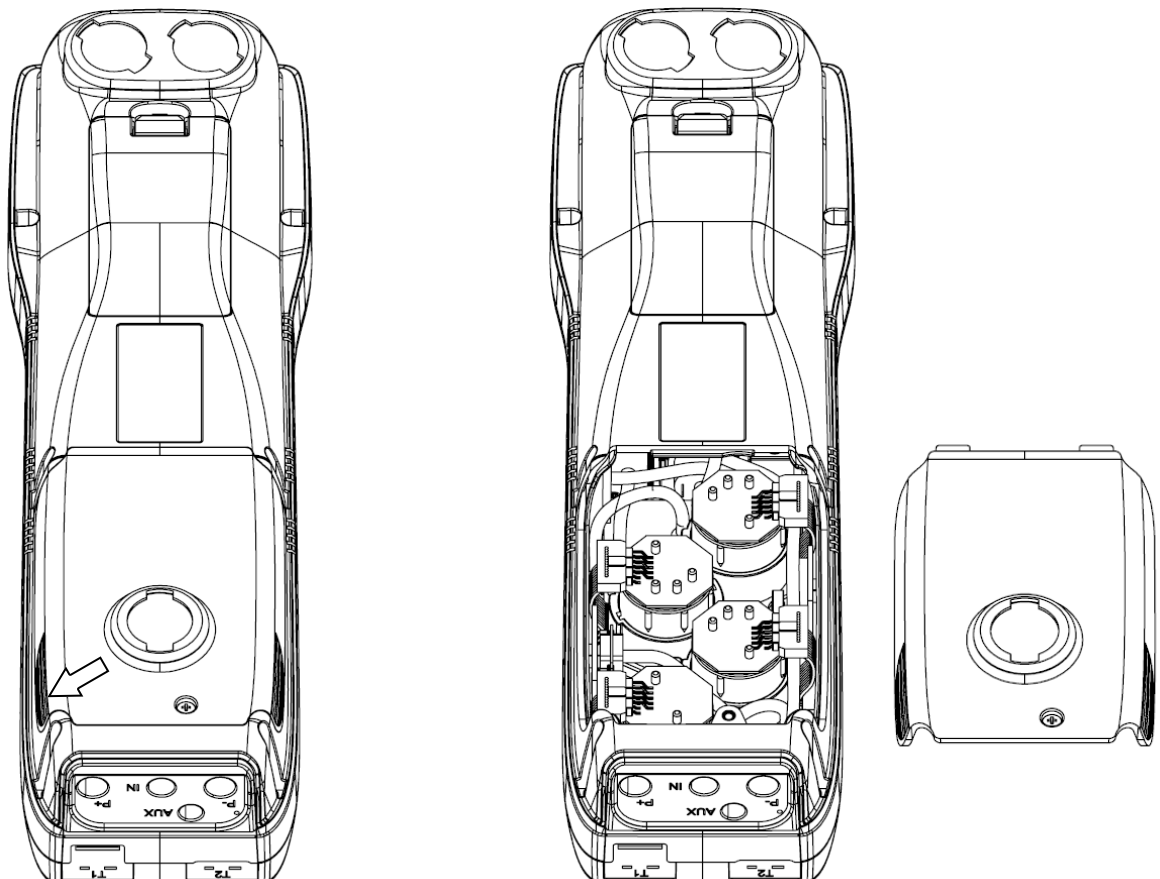

- 3 Locate the sensor to be replaced; here is an example of a connected sensor to be replaced.

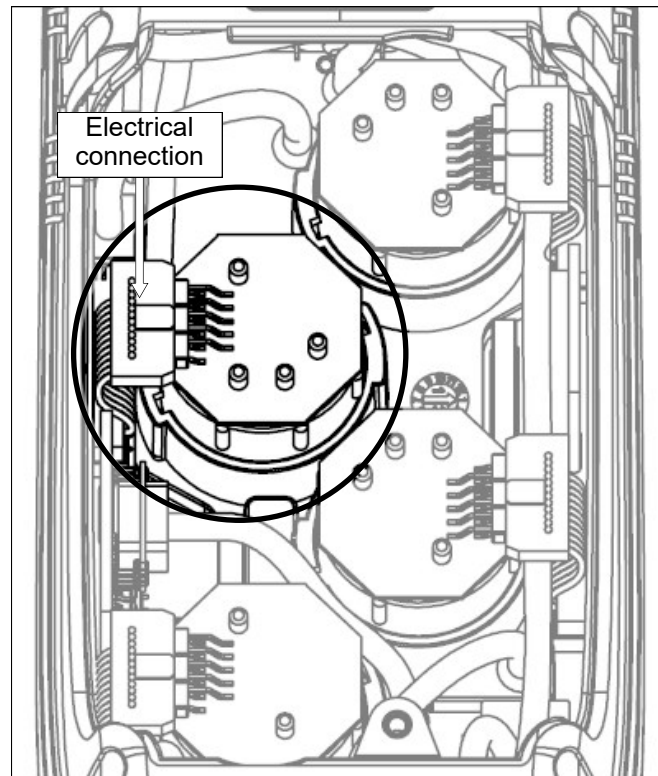

- 4 Disconnect the sensor to be replaced; here is an example of a disconnected sensor to be replaced.

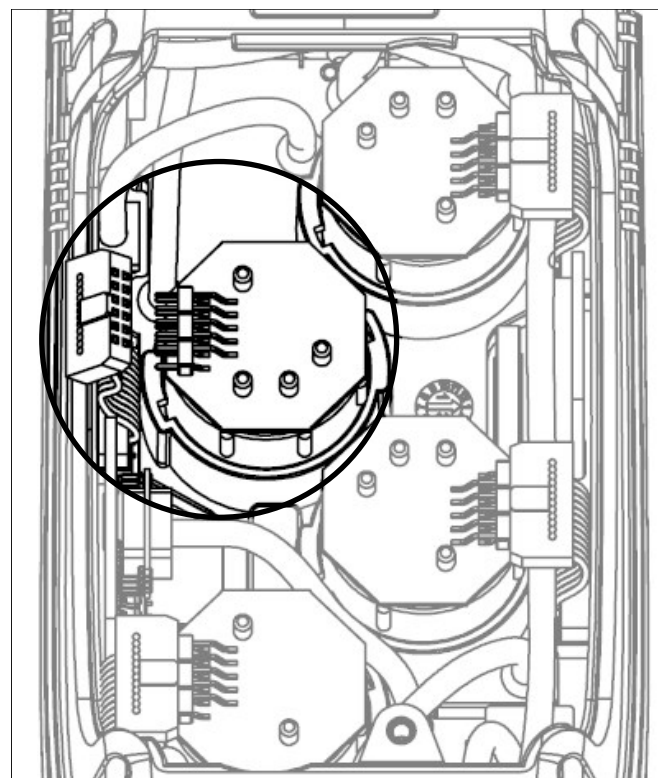

- 5 The sensor is bayonet-connected to its socket; rotate it anticlockwise to remove it. Here is an example of a rotated sensor.



**While rotating the sensor, take care not to exert any pressure onto the printed circuit above: exert pressure only onto the plastic body.**

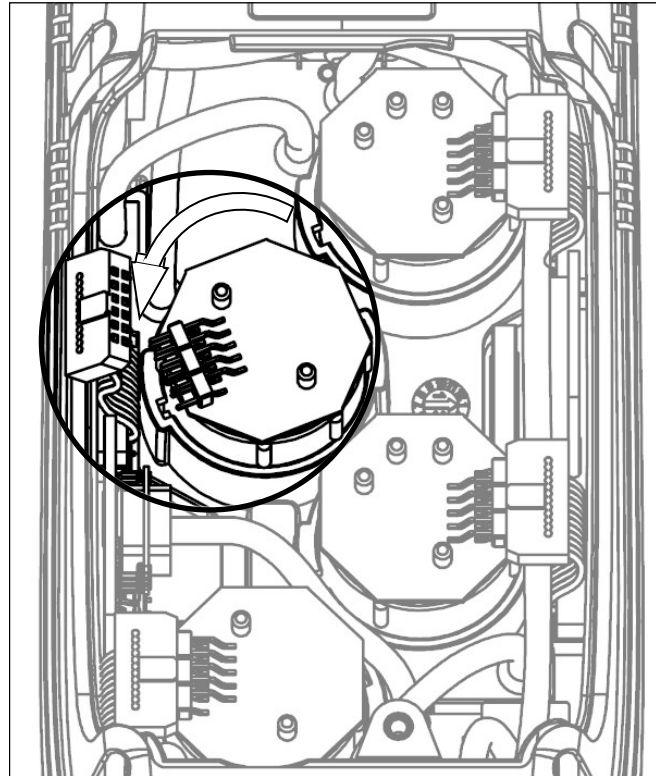

- 6 After rotating the sensor, pull it upward; here is an example of the sensor compartment with a sensor removed.

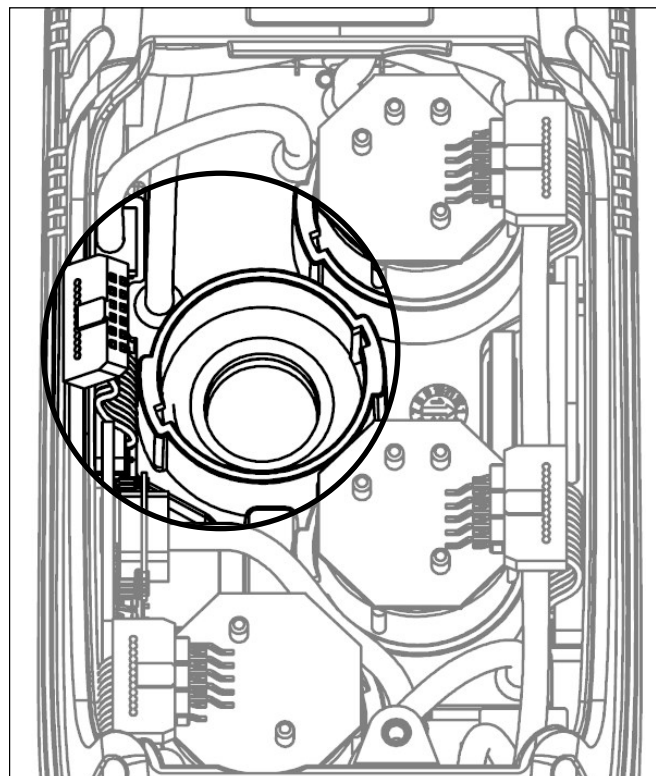

- 7 Fit the sensor again taking care the electric connection is turned outside the instrument, not inside (See point 5).



- 8 Rotate the sensor clockwise until hearing a click (See point 4).



**While rotating the sensor, take care not to exert any pressure onto the printed circuit above: exert pressure onto the plastic body only.**

- 9 Reconnect the sensor (See point 3).
- 10 Close the back door of the sensor compartment again, and tighten screws again (See point 1).

Turn on the instrument to check the new sensor works correctly through the menu "Sensor Troubleshooting".  
It is normal if a newly installed sensor gives a 'current error': it is necessary to wait some time, so that the sensor polarization can settle. The table here below shows the minimum settling time for each sensor.

CODE	DETECTED GAS	POSITION	SETTLING TIME
<b>Flex-Sensor O<sub>2</sub> LL</b> Cod. AACSE44	O <sub>2</sub> Oxygen	S1	24 hours <sup>(1)</sup>
<b>Flex-Sensor O<sub>2</sub></b> Cod. AACSE15R	O <sub>2</sub> Oxygen	S1	2 hours <sup>(1)</sup>
<b>Flex-Sensor CO+H<sub>2</sub></b> Cod. AACSE12	CO Carbon Monoxide	S2	2 hours <sup>(1)</sup>
<b>Flex-Sensor CO high immunity +H<sub>2</sub></b> Cod. AACSE20	CO Carbon Monoxide	S2/S3/S4	2 hours <sup>(1)</sup>
<b>Flex-Sensor NO</b> Cod. AACSE10	NO Nitrogen Oxide	S3	48 hours <sup>(2)</sup>
<b>Flex-Sensor NO<sub>2</sub></b> Cod. AACSE14	NO <sub>2</sub> Nitrogen Dioxide	S2/S3/S4	2 hours <sup>(1)</sup>
<b>Flex-Sensor SO<sub>2</sub></b> Cod. AACSE13	SO <sub>2</sub> Sulphur Dioxide	S2/S3/S4	2 hours <sup>(1)</sup>
<b>Flex-Sensor SO<sub>2</sub> 1.000 ppm</b> Cod. AACSE77	SO <sub>2</sub> Sulphur Dioxide	S2/S3/S4	2 hours <sup>(1)</sup>
<b>Flex-Sensor CO 100.000 ppm</b> Cod. AACSE17	CO Carbon Monoxide	S2/S3/S4	2 hours <sup>(1)</sup>
<b>Flex-Sensor CO 20.000 ppm</b> Cod. AACSE18	CO Carbon Monoxide	S2/S3/S4	2 hours <sup>(1)</sup>
<b>FLEX-Sensor CxHy 0-5.00% vol. referred to CH<sub>4</sub></b> Cod. AACSE23	CxHy unburnt hydrocarbons	S3/S4	1/2 hour <sup>(3)</sup>
<b>Flex-Sensor for gas leaks</b> Cod. AACSE19	Leak detector Methane / LPG	S4	-
<b>Flex-Sensor CO+H<sub>2</sub> low range</b> Cod. AACSE24	CO Carbon Monoxide	S2	2 hours <sup>(1)</sup>
<b>Flex-Sensor NO low range</b> Cod. AACSE25	NO Nitrogen Oxide	S3	48 hours <sup>(2)</sup>
<b>Flex-Sensor NO<sub>2</sub> low range</b> Cod. AACSE26	NO <sub>2</sub> Nitrogen Dioxide	S2/S3/S4	2 hours <sup>(1)</sup>
<b>Flex-Sensor SO<sub>2</sub> low range</b> Cod. AACSE28	SO <sub>2</sub> Sulphur Dioxide	S2/S3/S4	2 hours <sup>(1)</sup>
<b>Flex-Sensor CO<sub>2</sub> 0 .. 20% v/v</b> Cod. AACSE21	CO <sub>2</sub> Carbon Dioxide	S3/S4	2 hours <sup>(1)</sup>
<b>Flex-Sensor CO<sub>2</sub> 0 .. 50% v/v</b> Cod. AACSE47	CO <sub>2</sub> Carbon Dioxide	S3/S4	2 hours <sup>(1)</sup>

Note:

- (1) 2-hours settling time is required.
- (2) 48-hours settling time is required; if the sensor is not equipped with an polarizing external battery the settling time goes down to 2 hours.
- (3) 1/2 an hour is required to settle.

## 15.7 Replacing the battery pack (AAPB01)

Follow these instructions to replace the battery pack:

**1** Remove the battery compartment cover.

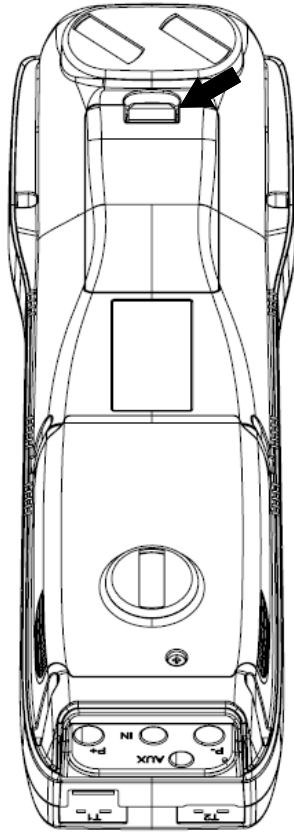

**2** Extract the battery pack.

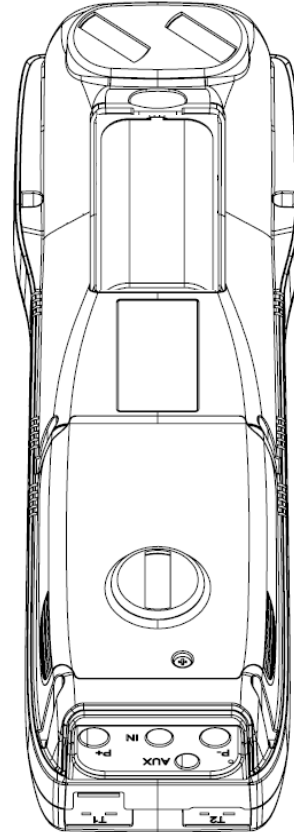

**3** Remove the battery pack connector, and replace the pack with a new one following the reverse procedure described above.

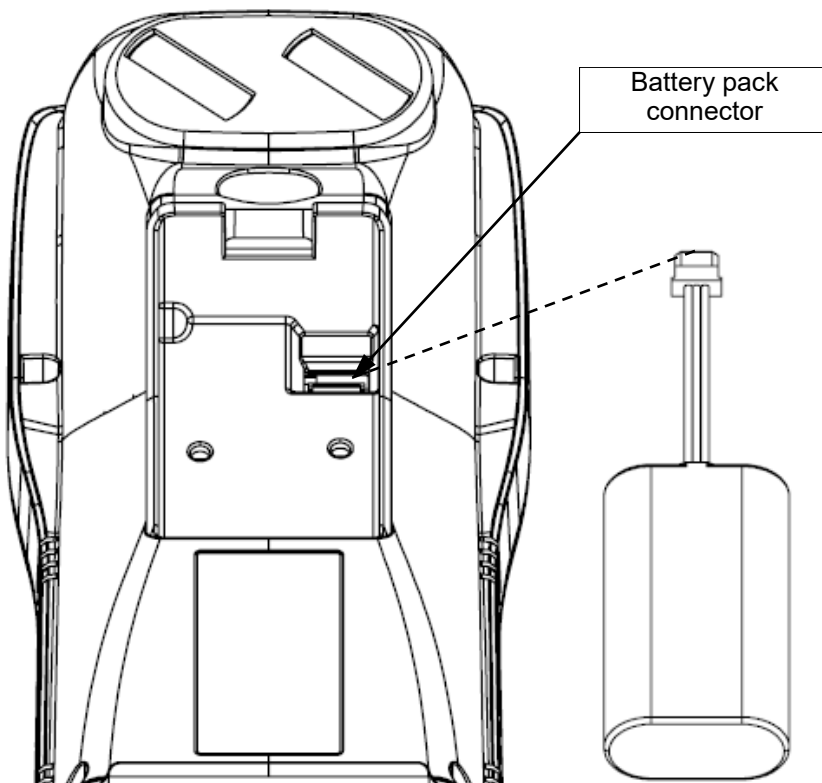

## 15.8 Replacing the printer paper

Follow these instructions to change the paper roll in the printer.

- 1 Lift the shiny tile, indicated by the arrow.

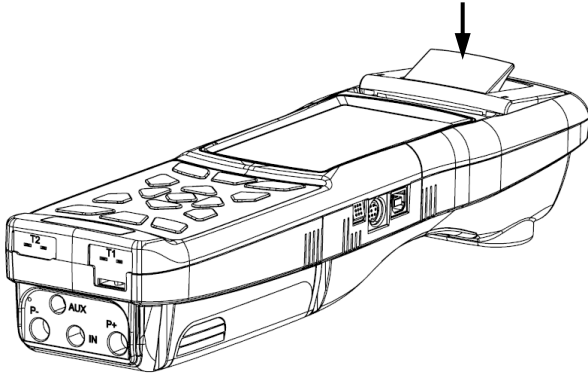

- 2 Lift the whole block of the lid completely.

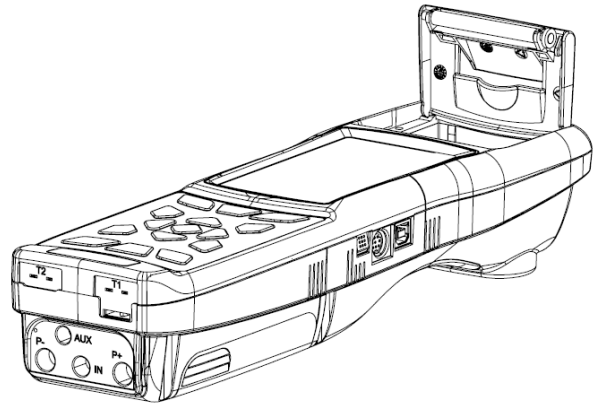

- 3 Insert the roll of printing paper as shown in the following figures.

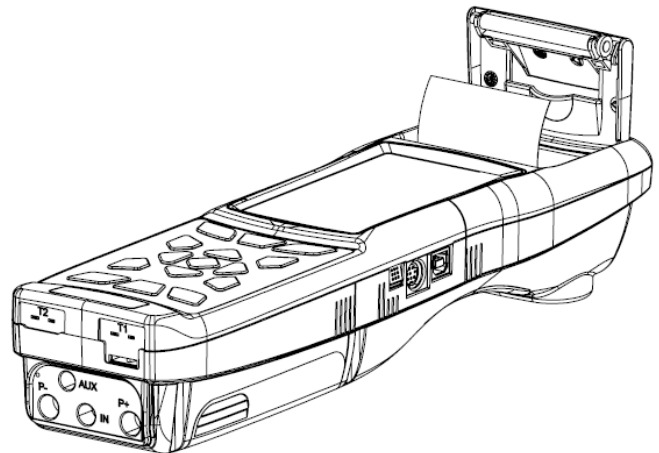
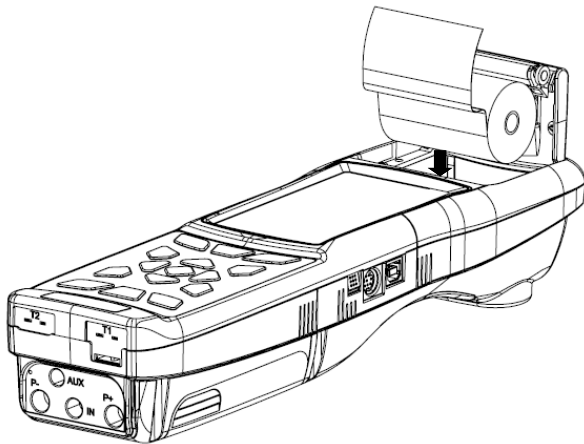

- 4 Close the whole block of the lid of the printer, pressing it lightly so as to hook it on to the device.

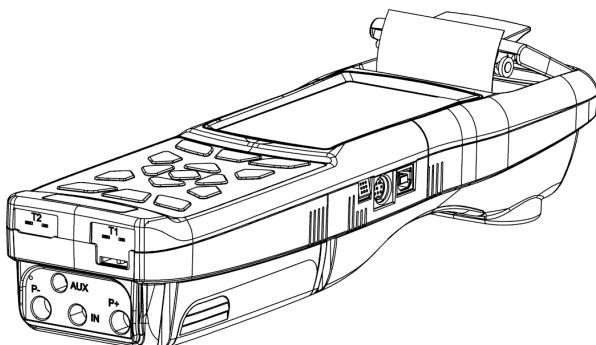

- 5 At this point it is possible to use the printer. See the parameter "Print".

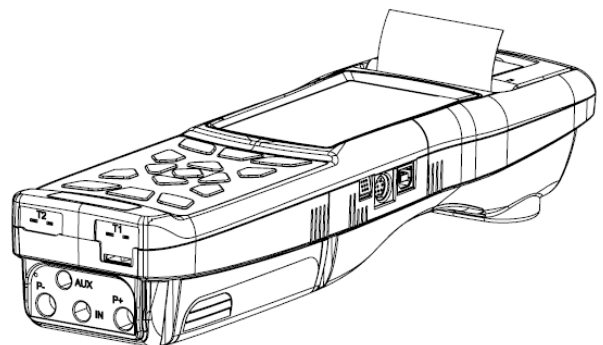

## 15.9 Firmware Update

The manufacturer periodically releases firmware updates of the instrument in order to correct unavoidable mistakes or improve the instrument performance or add new functions.

This update can be performed by the user by following the simple instructions below.

### WARNING:

Since the firmware update could imply a different organization of the data stored in the instrument memory, maintaining the existing analysis data in the instrument is not guaranteed. Therefore it is always mandatory to make the transfer of the analysis from the instrument to the PC prior to the firmware update procedure.

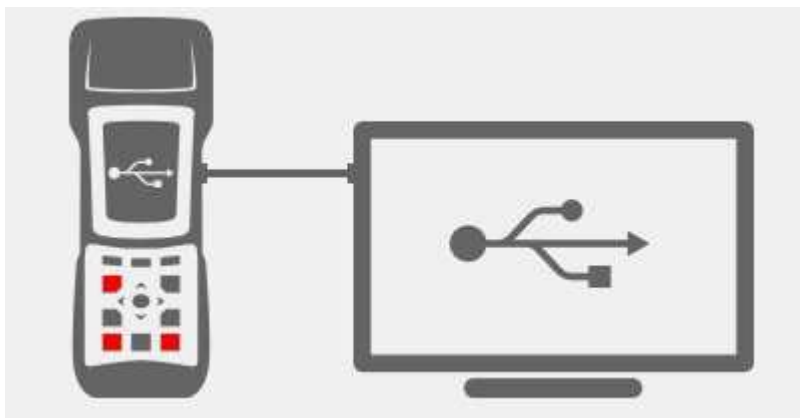

Moreover, for the same reasons, it is absolutely mandatory that the management software tool installed on the PC is updated to a version compatible with the firmware version installed on the instrument.

### Instructions to update the combustion analyzer with a new firmware:



1. Log in to the website [www.seitronamericas.com](http://www.seitronamericas.com) and download the firmware file available in the "combustion analyzers" section. This file is in a compressed version .zip.
2. Unzip the file thus obtaining the contents of the .zip file (extension .srec)
3. Plug in the analyzer to the PC via the USB cable
4. Hold down the three red buttons on the analyzer for at least 10 seconds
5. Release only the power on/off button
6. The analyzer will be recognized by the operating system as a portable device drive
7. Release the remaining two buttons
8. Copy the firmware file (extension .srec) to the directory of the analyzer
9. Wait till the end of the file copy operation
10. The file copy directory will be closed and the analyzer will restart
11. The analyzer is now updated, it can be powered off and it can be unplugged from the PC

## 16.1 Troubleshooting guide

SYMPTOM	PROBABLE CAUSES AND REMEDIES
The instrument does not work at all. When the On/Off pushbutton is pressed the instrument does not come on.	<ul style="list-style-type: none"> <li>a. Keep the On/Off key depressed for at least 2 seconds.</li> <li>b. The battery is low; connect the battery charger to the instrument.</li> <li>c. The battery pack is not connected to the instrument; remove the cover from the battery compartment and connect the connector of the battery pack to the outlet on the printed circuit board.</li> <li>d. The instrument is faulty: send it to a service center.</li> </ul>
The battery symbol  is empty on the inside.	The batteries are low. The instrument will remain on for a couple of minutes after which it will switch off; connect the battery charger.
After auto-calibration is complete the sensor diagnostics screen appears and gives an error for one or more sensors.	<ul style="list-style-type: none"> <li>a. Auto-calibration took place while the flue gas was being sampled.</li> <li>b. The O<sub>2</sub> sensor is faulty, is not connected correctly or is not connected at all. Check the above points, also referring to sections 5.3, 5.4, 6.6.</li> <li>c. The sensor was not allowed the necessary adjustment time or the instrument was left with a low battery for too long.</li> </ul>
A pressure sensor error is shown in the pressure/draft screen.	There is a calibration problem. Send the instrument to a service center.
The analysis screen gives a flue gas temperature (Tf) error.	<ul style="list-style-type: none"> <li>a. The thermocouple is not connected; connect the thermocouple to the analyzer.</li> <li>b. The sensor has been exposed to temperatures greater or lower than its operating temperature range.</li> <li>c. The thermocouple is faulty. Send the complete probe to a service center.</li> </ul>
The following symbol "----" appears on the analysis screen.	The instrument is not able to calculate a numerical value based on the flue gas analysis conducted. The "----" are replaced by numbers when the analyzer detects valid combustion data.
"Max. Lim." or "Min. Lim" appears on the analysis screen.	The relative sensor is detecting a value that is beyond the analyzer measuring range. "Max. Lim" or "Min. Lim." are replaced by numbers when the instrument reveals values that are within the measuring range.
The sample pump sounds as though it is running slowly, tends to stop or does not even start.	<ul style="list-style-type: none"> <li>a. Sample flow is obstructed. Check that the water filter is clean and that it is not completely soaked. Also check that the hose connected to the probe is not crushed.</li> <li>b. Sample intake flow is obstructed. Check that the particulate filter is clean.</li> <li>c. The pump is not connected as it should be. Remove the rear flap and check that the pump's electrical connector is connected to the printed circuit board.</li> <li>d. Pump is faulty. Replace the pump unit.</li> <li>e. Pump is disabled. The key combination   has been pressed. To re-enable the pump, switch off the instrument and then switch it on again.</li> </ul>

## Troubleshooting guide

SYMPTOM	PROBABLE CAUSES AND REMEDIES
The rear lighting of the display is not on.	The backlighting LED's are faulty. Contact the nearest service centre to replace the display.
The batteries last less than 9 hours.	<ul style="list-style-type: none"> <li><b>a.</b> Battery capacity is limited by low temperatures. To achieve a longer battery life it is recommended to store the instrument at higher temperatures.</li> <li><b>b.</b> The battery pack is old. Battery capacity tends to diminish with age. If battery life has become unacceptable, replace the battery pack.</li> </ul>
The values shown in the analysis screen are not reliable.	<ul style="list-style-type: none"> <li><b>a.</b> Sensor/s is/are faulty. Check that the sensors are installed correctly by accessing the sensor diagnostics menu.</li> <li><b>b.</b> The sample probe connection presents a leak. Check all joints and the conditions of the hose.</li> <li><b>c.</b> Pump is faulty. Replace the pump unit.</li> <li><b>d.</b> The instrument is faulty: Send it to a service centre for repair.</li> </ul>
During the tightness test a "sensor error" is reported.	Check for the correct connection of the hose to the positive pressure input.

## 17.1 Spare parts

AAC BF01	Sensor junction block
AAC FA01	Particulate filter
AA PB01	Li-Ion 3,7V 4,8Ah battery pack
AA RC10	Inalterable thermal paper roll, h=57mm Diam.=40mm
AAC ADX 005	Dummy sensor
AAC SE44	FLEX-Sensor O <sub>2</sub> long life, pre-calibrated and interchangeable 4-Year LONG LIFE Sensor
AAC SE15R	FLEX-Sensor O <sub>2</sub> pre-calibrated and interchangeable (Standard 2 year O <sub>2</sub> sensor)
AAC SE12	FLEX-Sensor CO+H <sub>2</sub> , pre-calibrated and interchangeable
AAC SE10	FLEX-Sensor NO/NO <sub>x</sub> , pre-calibrated and interchangeable
AAC SE14	FLEX-Sensor NO <sub>2</sub> , pre-calibrated and interchangeable
AAC SE13	FLEX-Sensor SO <sub>2</sub> , pre-calibrated and interchangeable
AAC SE17	FLEX-Sensor CO 100.000 ppm, pre-calibrated and interchangeable
AAC SE18	FLEX-Sensor CO 20.000 ppm, pre-calibrated and interchangeable
AAC SE20	FLEX-Sensor CO high immunity H <sub>2</sub> , pre-calibrated and interchangeable
AAC SE39	FLEX-Sensor C <sub>x</sub> H <sub>y</sub> related to CH <sub>4</sub> , pre-calibrated and interchangeable
AAC SE19	FLEX-Sensor for leaks detection, pre-calibrated and interchangeable
AAC SE24	FLEX-Sensor CO+H <sub>2</sub> low range, pre-calibrated and interchangeable
AAC SE25	FLEX-Sensor NO low range, pre-calibrated and interchangeable
AAC SE26	FLEX-Sensor NO <sub>2</sub> low range, pre-calibrated and interchangeable
AAC SE28	FLEX-Sensor SO <sub>2</sub> low range, pre-calibrated and interchangeable
AAC SE21	FLEX-Sensor CO <sub>2</sub> 0-20% v/v pre-calibrated and interchangeable
AAC SE47	FLEX-Sensor CO <sub>2</sub> 0-50% v/v, pre-calibrated and interchangeable
AAC SE77	FLEX-Sensor SO <sub>2</sub> compliant with J57-2017, pre-calibrated and interchangeable

## 17.2 Accessories

AA KA01	AC Power Adapter Kit For ALL Analyzers (Power adapter w/ US plug adapter + USB A / USB B cable)
AA CA02	Power supply with car adapter
AA CR10	Rigid plastic case
AA ZN01	Back-pack
AAC CT01	Case with shoulder strap
AAC DP02	Micro manometer for Draft test
AAC KP01	Differential pressure kit
AA PM02	Manual pump kit for smoke measurement
AA SA08	Outdoor Primary Air Temp TcK Probe for Condensing Systems (8") w/ 6.5' (2 m) cable
AA SF61A	7 inches gas probe, maximum working temperature: 752°F, with 6.6 ft. cable
AA SF51A	7 inches gas probe, maximum working temperature: 752°F, with 6.6 ft. cable
AA SF62A	11.8 inches gas probe, maximum working temperature: 1112°F, with 9.8 ft. cable
AA SF52A	11.8 inches gas probe, maximum working temperature: 1112°F, with 6.6 ft. cable
AA SF65A	29.5 inches gas probe, maximum working temperature: 1472°F, with 9.8 ft. cable
AA SF66A	39 inches gas probe, maximum working temperature: 2192°F, with 9.8 ft. cable
AA SX01	Gas sampling probe for average CO, 7 inches with 6.6 ft. cable
AA SX02	Probe for industrial motors, 29.5 inches with 9.8 ft. cable
AA SL05A	7 inches flexible gas probe, 266°F extended temperature range, with 6.6 ft. cable
AA SC01	Probe for ambient CO measurement
AA SG01	Probe for leaks detection
AAC SO01	Probe for measuring the ionization current
AA SP01	Protective screen for gas sampling probe
AACEX01	10ft' (3m) Extension Hose for all gas analyzer probes
AA SM06	Rubber protecting cover
AA SW08	Configuration software kit (USB + PC cable)
AAC TA03	Particulate/water filter assembly
AAC TA03A	Particulate/water filter assembly with steel pipe and connector
AA UA01	Adapter cable USB-A / USB-B
AA TT01	'L' shaped Pitot Tube (without Tc-K thermocouple): length 7 inches - external $\varnothing$ 0.2" Supplied with two silicone tubes with length 6.6 ft.
AA TT02	'L' shaped Pitot Tube (without Tc-K thermocouple): length 31.5" - external $\varnothing$ 0.2" Supplied with two silicone tubes with length 6.6 ft.
AATT03	36" (900mm) S-Type Pitot Tube for Gas Velocity
SP4500	S-Probe attachment for forklifts and small engines



### **17.3 Service Centers**

#### **Seitron Americas Inc.**

4622 Street Rd. Trevoose PA

19053 - USA

Tel.: (215) 660-9777

Fax.: (215) 660-9770

E-mail: [service@seitronamericas.com](mailto:service@seitronamericas.com)

<http://www.seitronamericas.com>

## Data Management with “SEITRON SMART ANALYSIS” APP



**SCAN THE QR CODE USING “SEITRON SMART ANALYSIS” APP IN ORDER TO DOWNLOAD ALL THE ACQUIRED DATA.**

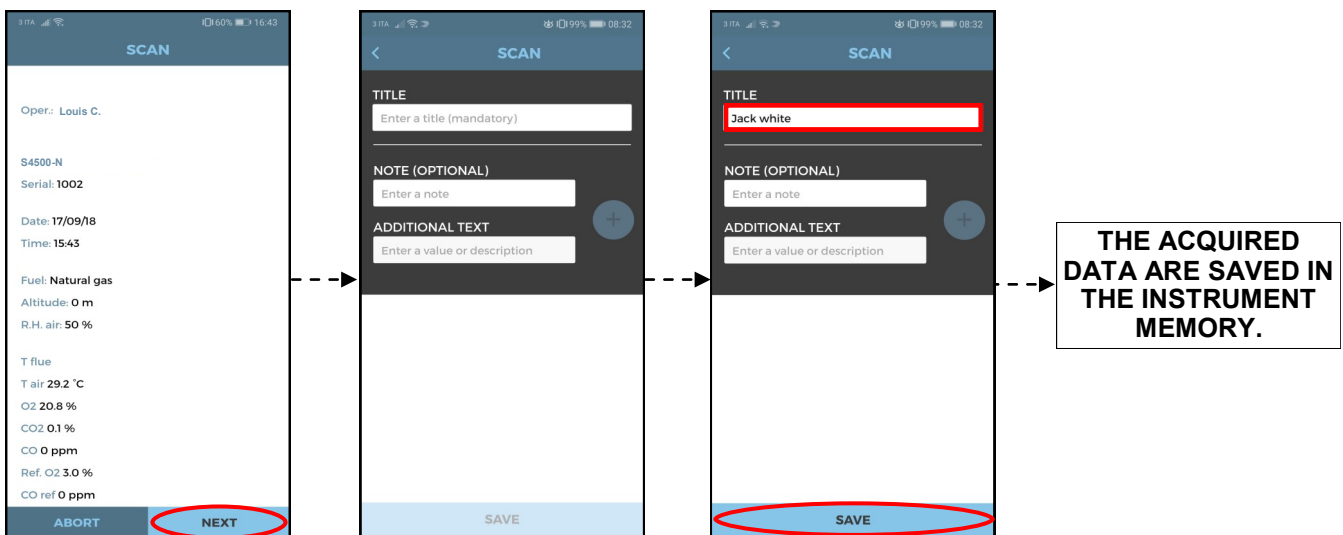

### APP settings.

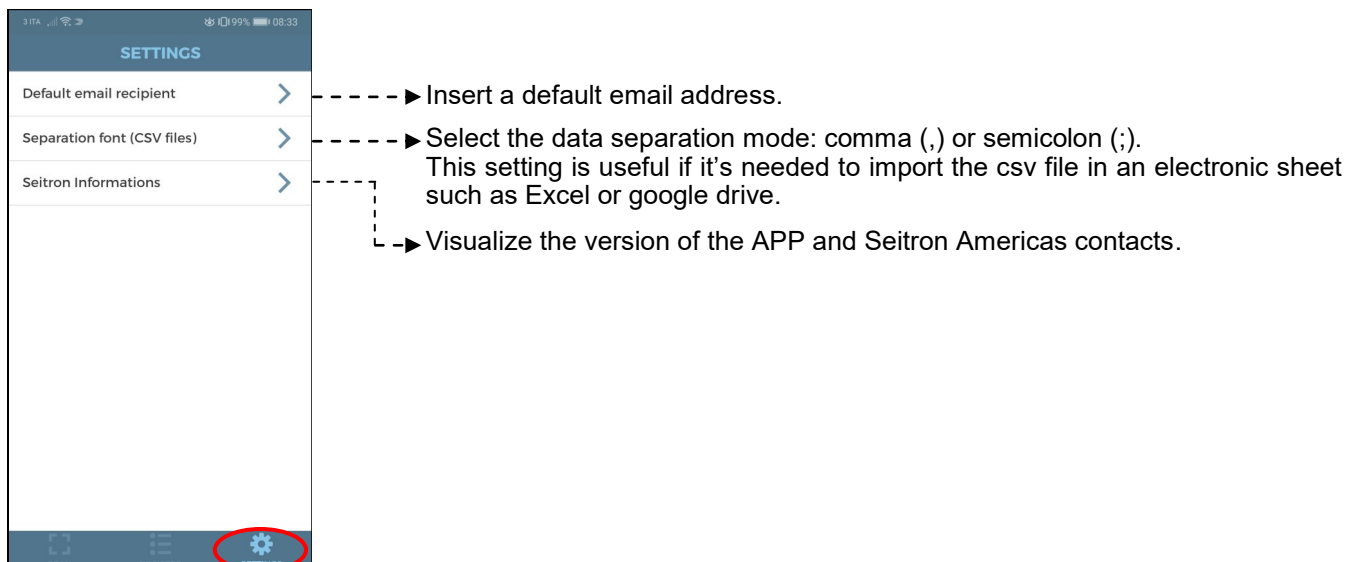

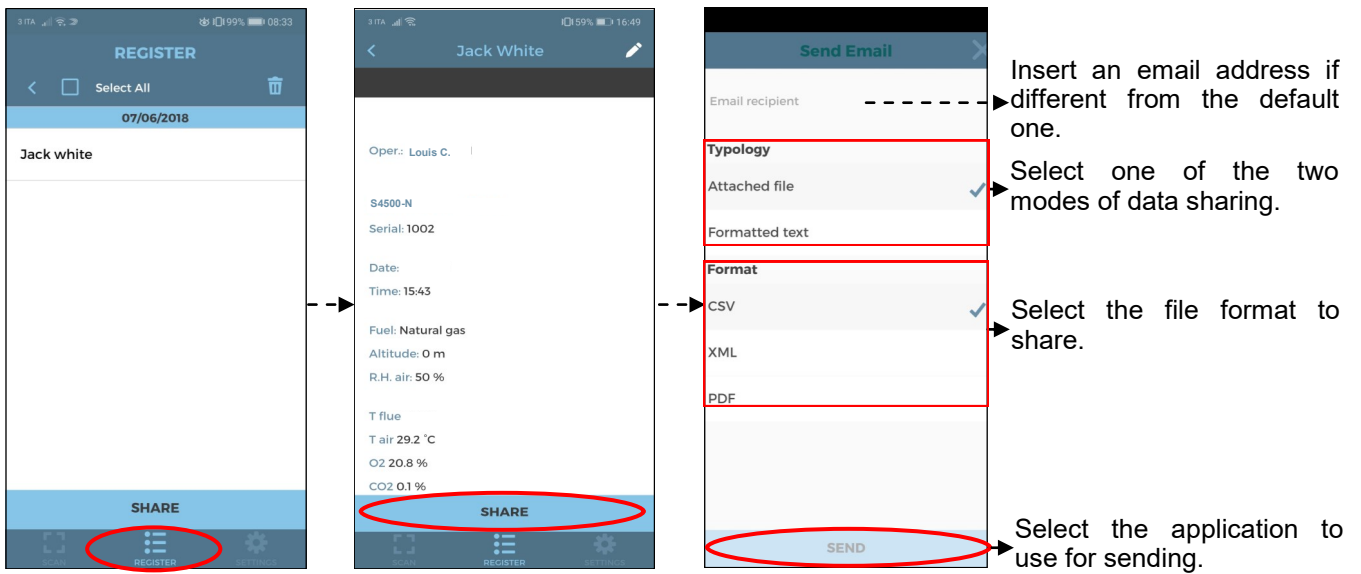

**Example of the exported csv file and imported in an excel file:**

S4500-N		
Serial number	1100	
Date	15/12/2017	
Time	12:00	
Fuel	Natural gas	
Altitud.	0.000000m	
Air humidity	50%	
O2	15.7%	
CO	23ppm	
CO2	2.9%	
T smoke	100.6°C	
T air	27.0°C	
ηs	90.0%	
NO	0.000mV	
CO-SEN	258.270mV	
O2	1.131.867mV	
I sen	0.000uA	
I sen	0.000uA	
I sen	100.346uA	
T az	22.5°C	
ΔT	73.6°C	
Qs	10.0%	
λ,n	4.01	
Air excess	4.01	
ηc	0.0%	
ηt	90.0%	
Qs (PCS)	10.0%	
Qt (PCS)	10.0%	
ηs (PCS)	90.0%	
ηc (PCS)	0.0%	
ηt (PCS)	90.0%	
NO	0ppm	
NOx	0ppm	
CO (0.0%)	0ppm	
NO (0.0%)	0ppm	
NOx (0.0%)	0ppm	
Draft	4.5Pa	

## Example of Total analysis report.

COMPANY Ltd.  
Park Road, 9  
Tel.02/12345678

Oper.: John Smith

Sign.: \_\_\_\_\_

S4500-N  
Serial: 999989

Memory: 01  
Analysis: Average  
Date: 04/04/14  
Time: 10.30

Fuel: Natural gas  
Altitude: 0 m  
R.H. air: 50 %

O <sub>2</sub>	15.7 %
CO <sub>2</sub>	2.9 ppm
λ,n	4.01
T flue	100.6 °C
T air	27.0 °C
ΔT	73.6 %
QS	10.0 %
η <sub>S</sub>	90.0 %
η <sub>C</sub>	0.0 %
η <sub>T</sub>	90.0 %
CO	23 ppm
NO	14 ppm
NO <sub>x</sub>	15 ppm
Ref. O <sub>2</sub> :	0.0 %
CO ref	92 ppm
Ref. O <sub>2</sub> :	0.0 %
NO ref	56 ppm
Ref. O <sub>2</sub> :	0.0 %
NO <sub>x</sub> ref.:	60 ppm
Draft	4.5 Pa
T ext.	10.0 °C

Note: -----  
-----  
-----  
-----  
-----  
-----  
-----

Analysis: 1  
04/03/16 10.00

O <sub>2</sub>	15.7 %
CO <sub>2</sub>	2.9 %
λ,n	4.01
T flue	100.4 °C
T air	27.0 °C
ΔT	73.4 °C
QS	10.0 %
η <sub>S</sub>	90.0 %
η <sub>C</sub>	0.0 %
η <sub>T</sub>	90.0 %
CO	23 ppm
NO	14 ppm
NO <sub>x</sub>	15 ppm
Ref. O <sub>2</sub> :	0.0 %
CO ref	92 ppm
Ref. O <sub>2</sub> :	0.0 %
NO ref	52 ppm
Ref. O <sub>2</sub> :	0.0 %
NO <sub>x</sub> ref.:	56 ppm
Tiraggio	4.5 Pa
T ext.	10.0 °C

Analysis: 2  
04/03/16 10.15

O <sub>2</sub>	15.7 %
CO <sub>2</sub>	2.9 %
λ,n	4.01
T flue	100.6 °C
T air	27.0 °C
ΔT	73.6 °C
QS	10.0 %
η <sub>S</sub>	90.0 %
η <sub>C</sub>	0.0 %
η <sub>T</sub>	90.0 %
CO	23 ppm
NO	14 ppm
NO <sub>x</sub>	15 ppm
Ref. O <sub>2</sub> :	0.0 %
CO ref	92 ppm
Ref. O <sub>2</sub> :	0.0 %
NO ref	56 ppm
Ref. O <sub>2</sub> :	0.0 %
NO <sub>x</sub> ref.:	60 ppm
Draft	4.5 Pa
T ext.	10.0 °C

Analysis: 3  
04/03/16 10.20

O <sub>2</sub>	15.7 %
CO <sub>2</sub>	2.9 %
λ,n	4.01
T flue	100.8 °C
T air	27.0 °C
ΔT	73.8 °C
QS	10.1 %

η <sub>S</sub>	89.9 %
η <sub>C</sub>	0.0 %
η <sub>T</sub>	89.9 %
CO	23 ppm
NO	14 ppm
NO <sub>x</sub>	15 ppm
Ref. O <sub>2</sub> :	0.0 %
CO ref	92 ppm
Ref. O <sub>2</sub> :	0.0 %
NO ref	56 ppm
Ref. O <sub>2</sub> :	0.0 %
NO <sub>x</sub> ref.:	60 ppm
Draft	4.5 Pa
T ext.	10.0 °C

**Example of Full analysis report.**

```

COMPANY Ltd.
Park Road, 9
Tel.02/12345678

Oper.: John Smith

Sign.: _____

S4500-N
Serial: 999989

Memory: 01
Analysis: Average
Date: 04/04/14
Time: 10.30

Fuel: Natural gas
Altitude: 0 m
R.H. air: 50 %

O2                15.9 %
CO2               2.8 ppm
λ,n              4.18
T flue           80.6 °C
T air            26.9 °C
ΔT              53.7 %
Qs              7.6 %
ηs             92.4 %
ηc              0.0 %
ηt             92.4 %
CO               27 ppm
NO               11 ppm
NOx             12 ppm
Ref. O2:        0.0 %
CO ref         113 ppm
Ref. O2:        0.0 %
NO ref         46 ppm
Ref. O2:        0.0 %
NOx ref.:      50 ppm
Draft          4.5 Pa
T ext.         10.0 °C

Note: -----
-----
-----
-----
-----
-----
-----

```

**Example of Partial Paper print-out.**

```

Date: 04/04/14
Time: 10.15

Fuel: Natural gas
Altitude: 0 m
R.H. air: 50 %

O2                15.7 %
CO2               2.9 ppm
λ,n              4.01
T flue           95.4 °C
T air            26.9 °C
ΔT              68.5 %
Qs              9.3 %
ηs             90.7 %
ηc              0.0 %
ηt             90.7 %
CO               23 ppm
NO               13 ppm
NOx             14 ppm
Ref. O2:        0.0 %
CO ref         92 ppm
Ref. O2:        0.0 %
NO ref         52 ppm
Ref. O2:        0.0 %
NOx ref.:      56 ppm
Smoke          4.5 Pa
T ext.         10.0 °C

Smoke:   3 1 2
Aver n°: 2

```

**Example of Draft Paper print-out.**

COMPANY Ltd.  
 Park Road, 9  
 Tel.02/12345678

Oper.: John Smith

Sign.: \_\_\_\_\_

S4500-N  
 Serial: 999989  
 Memory: 01

Date: 04/04/14  
 Time: 10.30

Draft                    4.5 Pa  
 T ext.                 10.0 °C

Note: -----  
 -----  
 -----

**Example of Smoke Paper print-out.**

COMPANY Ltd.  
 Park Road, 9  
 Tel.02/12345678

Oper.: John Smith

Sign.: \_\_\_\_\_

S4500-N  
 Serial: 999989  
 Memory: 01

Date: 04/04/14  
 Time: 10.30

Fuel: Diesel

Smoke:     3   1   2  
 Aver. n°:         2

Note: -----  
 -----  
 -----

**Example of ambient CO Paper print-out.**

COMPANY Ltd.  
 Park Road, 9  
 Tel.02/12345678

Oper.: John Smith

Sign.: \_\_\_\_\_

S4500-N  
 Serial: 999989  
 Memory: 01

Date: 04/04/14  
 Time: 10.30

CO amb                                    0 ppm

Note: -----  
 -----  
 -----

**Example of Velocity Paper print-out.**

COMPANY Ltd.  
 Park Road, 9  
 Tel.02/12345678

Oper.: John Smith

Sign.: \_\_\_\_\_

S4500-N  
 Serial: 999989  
 Memory: 01

Date: 04/04/14  
 Time: 10.30

Gas: Air

V air                    9.11 km/h  
 Density               1.199 kg/m<sup>3</sup>  
 Altitude               0 ft  
 T air                    25.3 °C  
 K Pitot                 0.980

Note: -----  
 -----  
 -----

**Example of Ventilation print-out.**

COMPANY Ltd.  
 Park Road, 9  
 Tel.02/12345678

Oper.: John Smith

Sign.: \_\_\_\_\_

S4500-N  
 Serial: 999989  
 Probe SN: 999979

Date: 28/11/19  
 Time: 10.15

Ventilati.                                0.0 Pa  
 Result:                    non compliant

Notes: -----  
 -----  
 -----

## Coefficients of the fuels and Formulas

The following chart lists the coefficients of the memorised fuels, used for calculating losses and efficiencies.

Coefficients for calculating combustion efficiency								
Fuel	A1 USA	B	CO <sub>2</sub> t (%)	PCI (KJ/Kg)	PCS (KJ/Kg)	M air (Kg/Kg)	M H <sub>2</sub> O (Kg/Kg)	V dry gas (m <sup>3</sup> /Kg)
Natural Gas	0.0280	0.0090	11.70	50050	55550	17.17	2.250	11.94
#2 Oil	0.0305	0.0066	15.70	42900	45700	14.30	1.136	10.34
#4 Oil	0.0306	0.0066	15.80	41100	43500	13.80	0.973	10.06
#6 Oil	0.0346	0.0048	16.00	39800	42197	13.61	0.981	9.97
Diesel	0.0305	0.0066	15.70	42900	45700	14.30	1.136	10.34
Wood/Pellets 8%	0.0354	0.0071	19.01	18150	19750	6.02	0.660	4.58
Bagasse	0.0395	0.0219	20.45	6950	8834	2.50	0.779	1.93
Coal	0.0320	0.0000	18.60	31400	32300	10.70	0.370	8.14
Biogas	0.0353	0.0091	17.33	17800	19800	6.08	0.830	4.55
Bio-Fuel 5%	0.0305	0.0066	15.70	42600	45400	14.22	1.133	10.64
Butane	0.0277	0.0073	14.00	45360	49150	15.38	1.548	10.99
Propane	0.0277	0.0073	13.70	45950	49950	15.61	1.638	11.11
B20	0.0313	0.0052	15.52	41806	44620	14.04	1.152	13.89

Details of the coefficients of the fuels:

- **CO<sub>2</sub> t:** The value of CO<sub>2</sub> generated by combustion in stoichiometric condition, i.e. without excess Oxygen and therefore maximum.
- **A1, B:** Also please have a look at the Siegert formulas (in the following).  
A1 is the parameter in the Siegert Formula when the O<sub>2</sub> measurement is available.  
A2 is used when the CO<sub>2</sub> measurement is available.  
Note: - Please also consider that in the U.S. usually the A1 parameter is the same as the 'european' A1 BUT divided by 2.

Flue gas heat losses are calculated from measured oxygen content according to the relationship:

$$q_A = (t_A - t_L) \times \left( A1 \frac{21}{21 - O_2} + B \right)$$

Flue gas heat losses are calculated from measured carbon dioxide content according to the relationship:

$$q_A = (t_A - t_L) \times \left( A1 \frac{CO_2t}{CO_2} + B \right)$$

Air index is calculated with the formula:

$\lambda = 21 / (21 - O_2)$ , where O<sub>2</sub> is the oxygen residual concentration in the combustion smokes.

Air excess is calculated with the formula:

$$e = (\lambda - 1) * 100$$

- **CO conv:** Conversion coefficient from ppm to mg/KWh. It can be expressed as a function of the gas density (CO in this case) and the volume of the dry smoke.
- **NO conv:** Same as CO conv, but for NO.
- **NOx conv:** Same as CO conv, but for NOx.
- **SO<sub>2</sub> conv:** Same as CO conv, but for SO<sub>2</sub>.
- **PCI:** Potere Calorifico Inferiore. Italian for LHV (Lower Heating Value).
- **PCS:** Potere Calorifico Superiore. Italian for HHV (Higher Heating Value).
- **m H<sub>2</sub>O:** Mass of the air produced (per each Kg of fuel) in the combustion in stoichiometric condition.
- **m Air:** Mass of the air needed for combustion in stoichiometric condition.
- **V g.d.:** Volume of dry smokes produced in the combustion.

---

## Instructions for accurate testing

In order to achieve a certain degree of accuracy when conducting flue gas analysis, the following should be respected:

- the boiler being checked should be running in steady state conditions.
- the flue gas analyzer should be switched on at least 3 minutes before testing (time to auto-calibrate) with the probe located in fresh air.
- the point in which the probe is inserted for analysis has to be at a distance of approximately twice the stack diameter or, alternatively, as directed by the boiler manufacturer.
- the water trap should be completely empty and positioned vertically.
- before switching off the instrument, extract the probe and wait at least 3 minutes (the CO value has to drop below 10 ppm).
- Before returning the instrument to its place, clean the water trap and relative hose; if water is present in the hose clean the latter by blowing inside.



## Optional measures list:

MEASURE	DEFINITION
$\lambda, n (l,n)$	<b>Air index</b> (defined as $\lambda$ , sometimes also indicated as $n$ ).
<b>E (Exc. Air)</b>	<b>Air excess.</b> Expressed as a percentage according to the formula in the appendix C, is the ratio between the volume of air actually entering the combustion chamber and the one theoretically needed.
$\Delta T (dT)$	<b>Differential temperature:</b> It is the difference between the smoke temperature and the air combustion temperature.
<b>Qs (LHV)</b>	<b>Stack losses in relation to the Lower Heating Value (LHV):</b> It is the percentage of dissipated heat through the stack referred to the lower heating value (LHV)
<b>Qs (HHV)</b>	<b>Stack losses in relation to the Higher Heating Value (HHV):</b> It is the percentage of dissipated heat through the stack referred to the higher heating value (HHV)
<b><math>\eta_s (Es) (LHV)</math></b>	<b>Sensible efficiency in relation to the Lower Heating Value (LHV):</b> It is the burner efficiency calculated as the ratio between conventional heating power and the burner heating power. Among the combustion losses, only the sensible heat lost with flue gasses is taken into account, thus neglecting the radiation losses and incomplete combustion losses. This value is referred to the Lower Heating Value (LHV) of the fuel and cannot exceed 100%. The sensible efficiency value is to be compared against minimum efficiency stated for the heating system performances.
<b><math>\eta_s (Es) (HHV)</math></b>	<b>Sensible efficiency in relation to the Higher Heating Value (HHV):</b> It is the burner efficiency calculated as the ratio between conventional heating power and the burner heating power. Among the combustion losses, only the sensible heat lost with flue gasses is taken into account, thus neglecting the radiation losses and incomplete combustion losses. This value is referred to the Higher Heating Value (HHV) of the fuel and cannot exceed 100%. The sensible efficiency value is to be compared against minimum efficiency stated for the heating system performances.
<b><math>\eta_c (Ec)</math></b>	<b>Condensation efficiency in relation to the Lower Heating Value (LHV):</b> Efficiency deriving from the condensation of water vapor contained in flue gases referred to the LHV.
<b><math>\eta_c (Ec)</math></b>	<b>Condensation efficiency in relation to the Higher Heating Value (HHV):</b> Efficiency deriving from the condensation of water vapor contained in flue gases and it is referred to the HHV.
<b><math>\eta_t (Eff)</math></b> <b><math>\eta_t = \eta_s + \eta_c</math></b>	<b>Total efficiency in relation to the Lower Heating Value (LHV):</b> Total efficiency. It is the sum of sensible efficiency and condensation efficiency. It is referred to LHV (Lower Heating Value) and can exceed 100%.

MEASURE	DEFINITION
$\eta_t$ (Eff)	<b>Total efficiency in relation to the Higher Heating Value (HHV):</b> Total efficiency. It is the sum of sensible efficiency and condensation efficiency. It is referred to HHV (Higher Heating Value) and can not exceed 100%.
$Q_t$	<b>Total stack losses (HHV):</b> It is the total heat percentage dissipated through the stack.
NOx	Measure of nitrogen oxides quantity; the measurement unit can be set in the special menu.
NOx ppm *	Measure of nitrogen oxides quantity; the measurement unit can not be set but it is fixed in ppm.
NOx (rif. O2)	Measure of nitrogen oxides quantity referring to O2; the measurement unit can be set in the special menu.
NOx (rif. O2) ppm *	Measure of nitrogen oxides quantity referring to O2; the measurement unit can not be set but it is fixed in ppm.
PI	<b>Poison Index (CO/CO2 ratio):</b> It is defined as the ratio between CO and CO2 useful to determine whether the system needs maintenance.
CO	CO quantity measurement. Measurement units: ppm - mg/m <sup>3</sup> - mg/kWh - g/GJ - g/m <sup>3</sup> - mg/kWh - % - ng/J
CO (RIF)	CO quantity measurement with O2 reference. Measurement units: ppm - mg/m <sup>3</sup> - mg/kWh - g/GJ - g/m <sup>3</sup> - g/kWh - % - ng/J
CO amb. ext.	Measure of the outer CO level when using the external CO probe. Measurement unit: ppm. This is the only measurement unit which is possible to set.
T dew	Flue water condensation temperature (Dew point). This value is calculated.

\* : Valid for Piemonte region only (Italy only).



**OTHER THAN THE MEASUREMENT LIST ABOVE, IT IS POSSIBLE TO VISUALIZE THE MEASURE OF THE DETECTED GAS ALSO IN PPM, DEPENDING ON THE KIND OF MEASUREMENT SENSOR IN THE INSTRUMENT. IF IT IS NECESSARY TO MEASURE THE VALUE OF GAS WITH TWO DIFFERENT MEASUREMENT UNITS, SELECT IN THE MEASUREMENTS LIST THE DESIRED GAS IN PPM AND CHANGE THE MEASUREMENT UNIT FOR THE SAME GAS IN THE "CONFIGURATION->ANALYSIS->MEASUREMENT UNIT" SCREEN. NOW THE INSTRUMENT ACQUIRES THE MEASURE WITH TWO DIFFERENT UNITS (PPM AND THE ONE PREVIOUSLY SET)**

# WARRANTY CERTIFICATE

## WARRANTY

The S1500 and S4500 series flue gas analyzer is guaranteed for **48 months** from purchasing date including the internal electro-chemical sensors which are also guaranteed for **48 months** from purchasing date.

Seitron Americas undertakes to repair or replace, free of charge, those parts that, in its opinion, are found to be faulty during the warranty period. The products which are found defective during the above mentioned periods of time have to be delivered to Seitron Americas Laboratories carriage paid. The following cases are not covered by this warranty: accidental breakage due to transport, inappropriate use or use that does not comply with the indications in the product's instruction leaflet.

Any mistreatment, repairs and modifications to the product not explicitly authorized by Seitron Americas shall invalidate the present warranty.

## IMPORTANT

For the product to be repaired under Warranty, please send a copy of this Certificate along with the instrument to be repaired, together with a brief explanation of the fault observed.

-----

Space reserved for user

Name: \_\_\_\_\_

Company: \_\_\_\_\_

User's notes:  
\_\_\_\_\_  
\_\_\_\_\_  
\_\_\_\_\_  
\_\_\_\_\_  
\_\_\_\_\_

Date: \_\_\_\_\_

S.N.: \_\_\_\_\_







**Seitron Americas Inc.**

4622 Street Rd. Trevose, PA 19053 - USA

Tel: (215) 660-9777 Fax: (215) 660-9770

[service@seitronamericas.com](mailto:service@seitronamericas.com) - [www.seitronamericas.com](http://www.seitronamericas.com)