

187/189 True RMS Multimeter Quick Reference Guide

⚠ See Users Manual for "Safety Information" and complete operating information.

AC/DC Volts

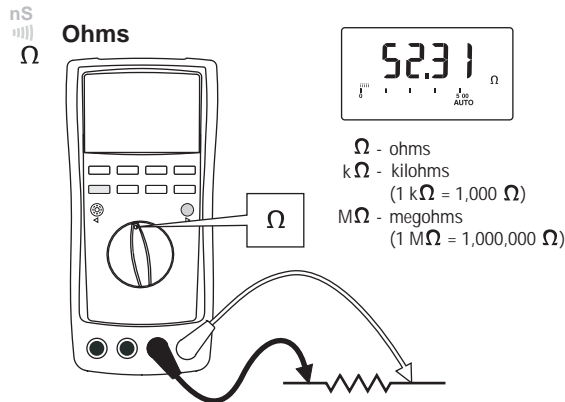
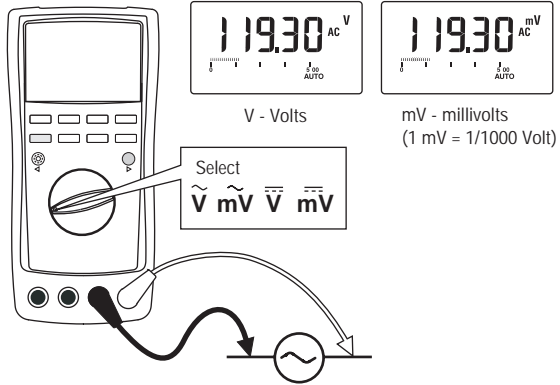

dBm or dBV Decibels

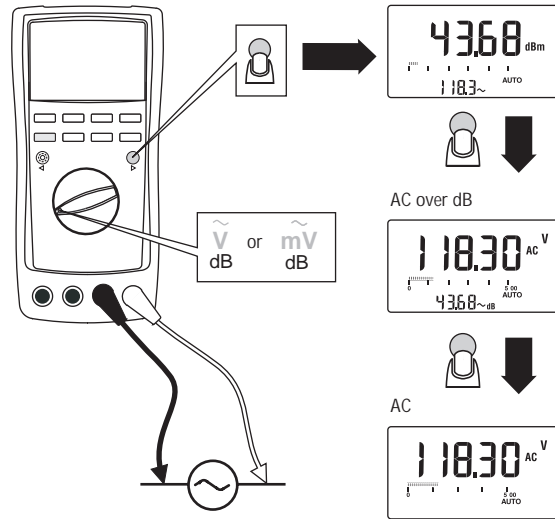

Duty Cycle and Pulse Width

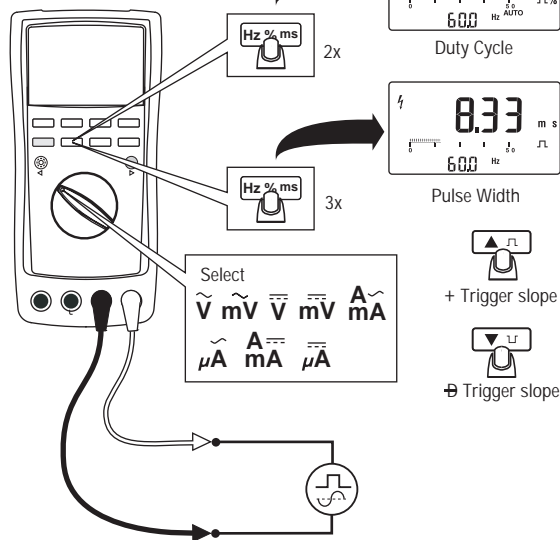

Continuity

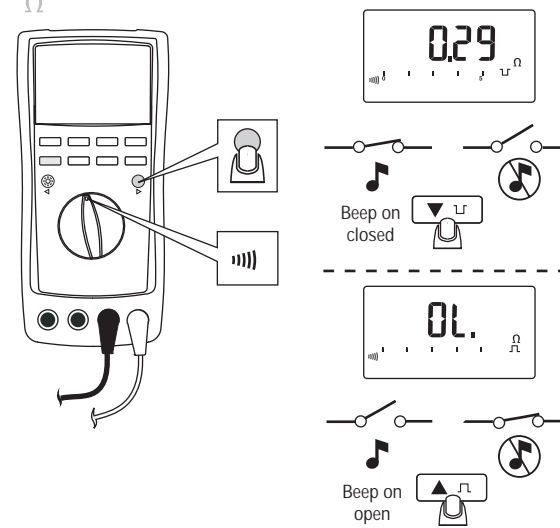

Diode Test

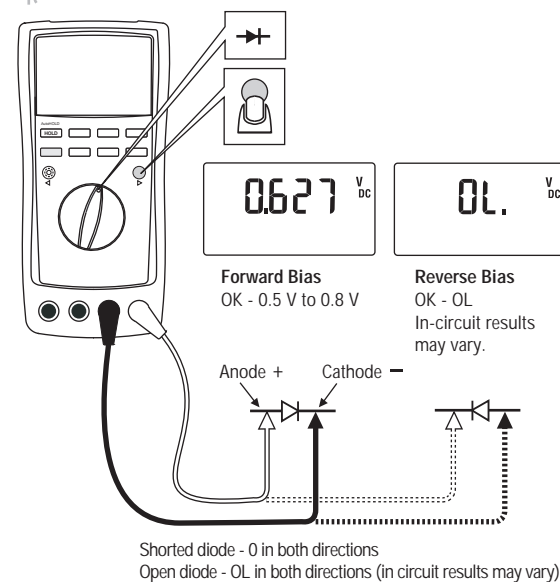

Capacitance

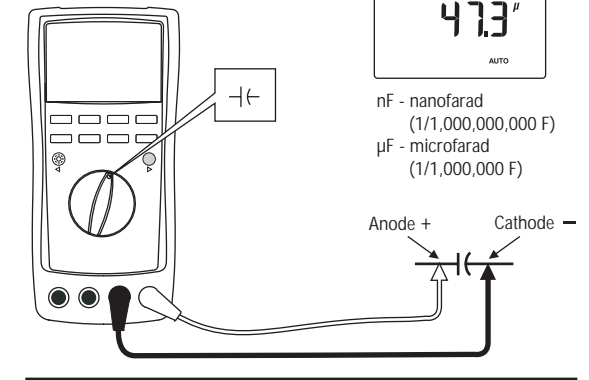

Conductance

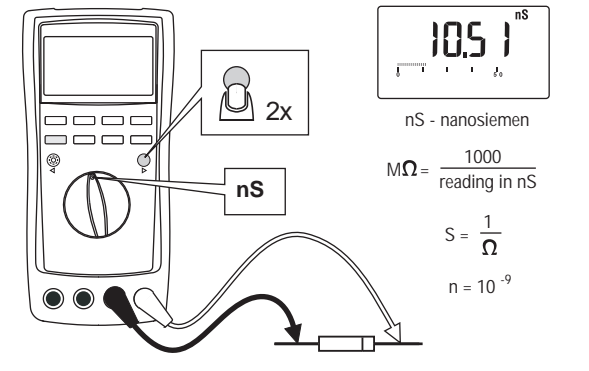

Saving/Logging (Model 89 only)

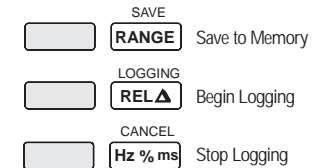

View Memory

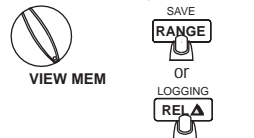

Clear Memory



See Chapter 4 of the Users Manual for complete operating information.

Changing Setup Settings

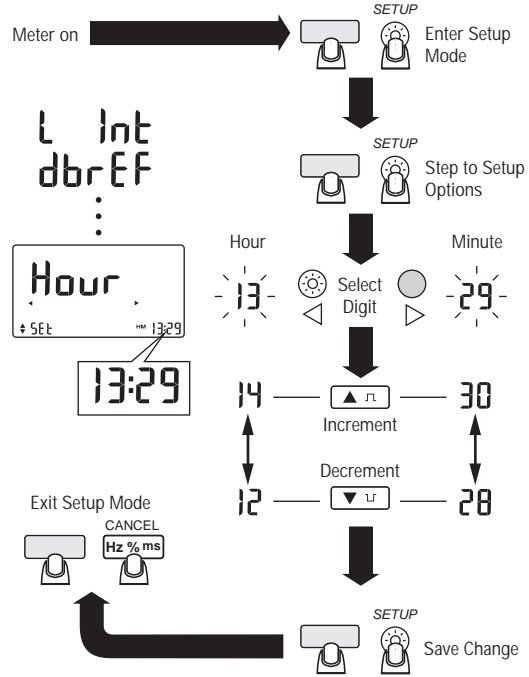

Amps

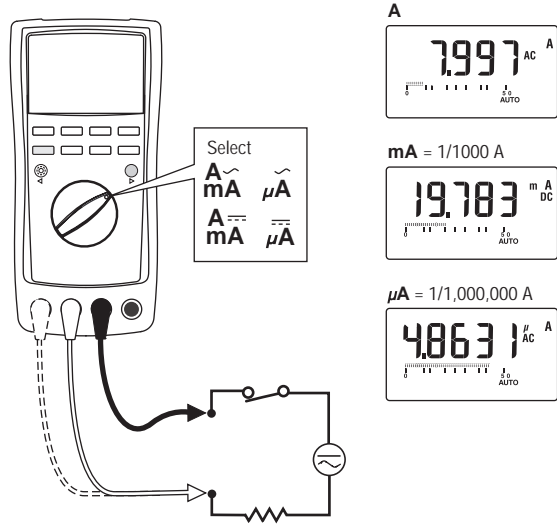

Frequency

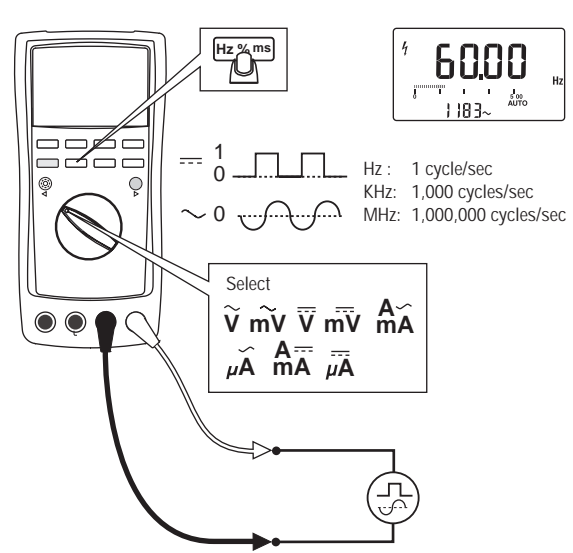

HOLD AutoHOLD

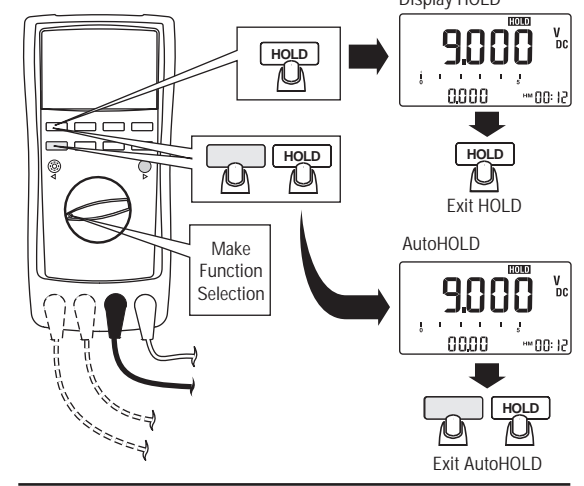

AC + DC

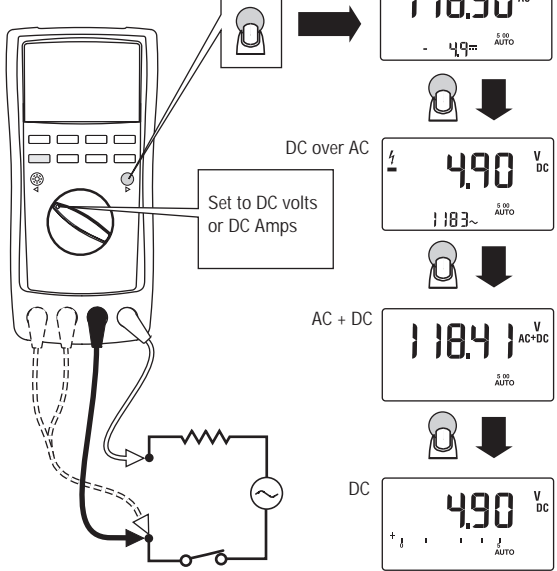

Min, Max, Average

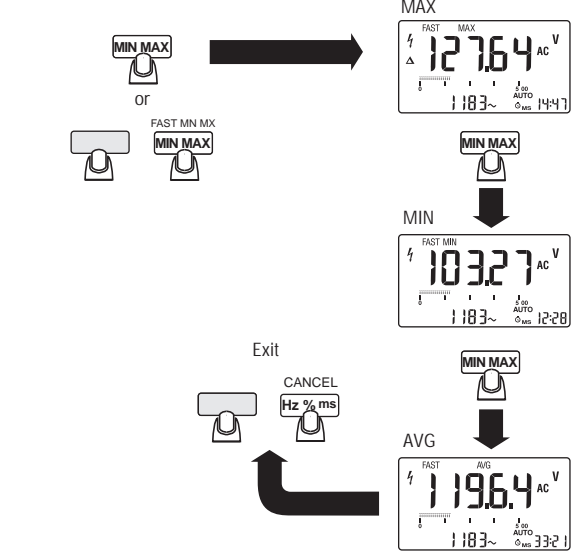

Display Resolution (3-1/2 or 4-1/2 Digits)

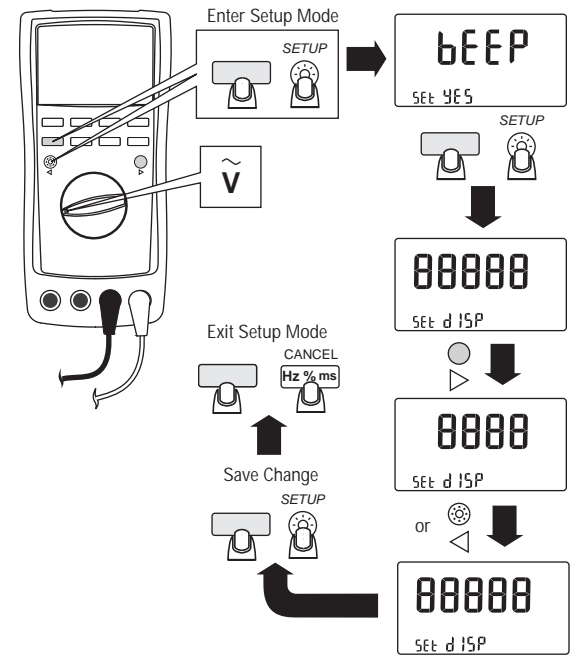

Fuse Test

