

INSTRUCTION MANUAL

BK PRECISION®
MODELS 2120C, 2121C,
2125C and 2160C

DUAL-TRACE OSCILLOSCOPES

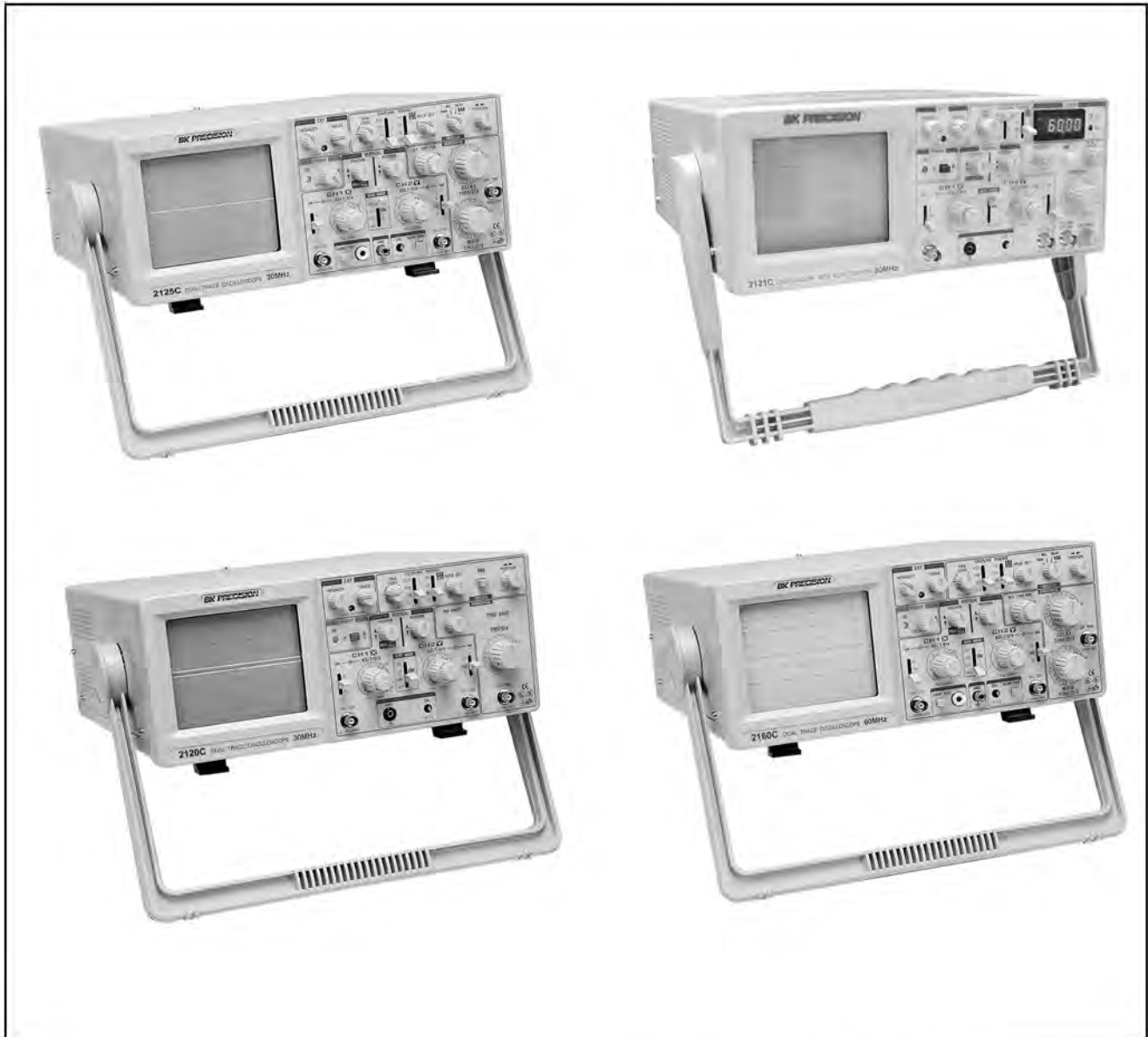

BK PRECISION®

TEST INSTRUMENT SAFETY

WARNING

Normal use of test equipment exposes you to a certain amount of danger from electrical shock because testing must often be performed where exposed high voltage is present. An electrical shock causing 10 milliamps of current to pass through the heart will stop most human heartbeats. Voltage as low as 35 volts dc or ac rms should be considered dangerous and hazardous since it can produce a lethal current under certain conditions. Higher voltage poses an even greater threat because such voltage can more easily produce a lethal current. Your normal work habits should include all accepted practices that will prevent contact with exposed high voltage, and that will steer current away from your heart in case of accidental contact with a high voltage. You will significantly reduce the risk factor if you know and observe the following safety precautions:

1. Don't expose high voltage needlessly in the equipment under test. Remove housings and covers only when necessary. Turn off equipment while making test connections in high-voltage circuits. Discharge high-voltage capacitors after removing power.
2. If possible, familiarize yourself with the equipment being tested and the location of its high voltage points. However, remember that high voltage may appear at unexpected points in defective equipment.
3. Use an insulated floor material or a large, insulated floor mat to stand on, and an insulated work surface on which to place equipment; make certain such surfaces are not damp or wet.
4. Use the time-proven "one hand in the pocket" technique while handling an instrument probe. Be particularly careful to avoid contacting a nearby metal object that could provide a good ground return path.
5. When using a probe, touch only the insulated portion. Never touch the exposed tip portion.
6. When testing ac powered equipment, remember that ac line voltage is usually present on some power input circuits such as the on-off switch, fuses, power transformer, etc. any time the equipment is connected to an ac outlet, even if the equipment is turned off.
7. Some equipment with a two-wire ac power cord, including some with polarized power plugs, is the "hot chassis" type. This includes most recent television receivers and audio equipment. A plastic or wooden cabinet insulates the chassis to protect the customer. When the cabinet is removed for servicing, a serious shock hazard exists if the chassis is touched. Not only does this present a dangerous shock hazard, but damage to test instruments or the equipment under test may result from connecting the ground lead of most test instruments (including this oscilloscope) to a "hot chassis". To make measurements in "hot chassis" equipment, always connect an isolation transformer between the ac outlet and the equipment under test. The **B+K Precision** Model TR-110 or 1604A Isolation Transformer, or Model 1653A or 1655A AC Power Supply is suitable for most applications. To be on the safe side, treat all two wire ac powered equipment as "hot chassis" unless you are sure it has an isolated chassis or an earth ground chassis.
8. Never work alone. Someone should be nearby to render aid if necessary. Training in CPR (cardio-pulmonary resuscitation) first aid is highly recommended.

Instruction Manual

for

BK PRECISION[®]

**Models 2120C, 2121C
2125C and 2160C**

Dual-Trace Oscilloscopes

©2013 B+K Precision Corp.



This symbol on oscilloscope means “refer to instruction manual for further precautionary information”. This symbol appears in the manual where the corresponding information is given.

BK PRECISION[®]

22820 Savi Ranch Parkway, Yorba Linda, CA 92887

TABLE OF CONTENTS

	Page		Page
TEST INSTRUMENT SAFETY	inside front cover	OPERATING INSTRUCTIONS (Continued)	
FEATURES	3	X-Y Operation	15
SPECIFICATIONS	5	Video Signal Observation	15
CONTROLS AND INDICATORS	7	Application Guidebook	15
General Function Controls	7	Delayed Sweep Operation	15
Vertical Controls	7	Component Test Operation	16
Horizontal Controls	9	MAINTENANCE	20
Triggering Controls	9	Fuse Replacement	20
Rear Panel Controls	10	Line Voltage Selection	20
OPERATING INSTRUCTIONS	11	Periodic Adjustments	20
Safety Precautions	11	Calibration Check	21
Equipment Protection Precautions	11	Instrument Repair Service	21
Operating Tips	12	APPENDIX	22
Initial Starting Procedure	12	Important Considerations for Rise Time and	
Single Trace Display	12	Fall Time Measurements	22
Dual Trace Display	12	2121C Specifications & Operating Instruction	23
Triggering	13	Service Information	26
Magnified Sweep Operation	15	“Guidebook To Oscilloscopes”	
		Availability	inside back cover

FEATURES

LOW COST, HIGH PERFORMANCE

B+K Precision's entry level oscilloscope are economically priced to equal the competition, but offer higher performance than the competition. For example, most competitor's entry level oscilloscopes have a 20 MHz bandwidth, while B+K Precision's model 2120C and 2125C offer a 30 MHz bandwidth. These oscilloscopes are built by and backed by B+K Precision, a company that has been selling reliable, durable, value priced test instruments for over 60 years.

CRT FEATURES

Rectangular CRT

Rectangular CRT with large 8 x 10 centimeter viewing area. On Models 2125C & 2160C, graticule is equipped with variable scale illumination.

Convenience

Trace rotation electrically adjustable from front panel. 0%, 10%, 90%, and 100% markers for rise time measurements.

DUAL TRACE FEATURES

Dual Trace

Each model has two vertical input channels for displaying two waveforms simultaneously. Selectable single trace (either CH 1 or CH 2) or dual trace. Alternate or chop sweep selectable at all sweep rates.

Sum and Difference Capability

Permits algebraic addition or subtraction of channel 1 and channel 2 waveforms, displayed as a single trace. Useful for differential voltage and distortion measurements.

HIGH FREQUENCY FEATURES

Wide Bandwidth

Conservatively-rated -3 dB bandwidth is dc to 30 MHz. (60 MHz model 2160C)

Fast Rise Time

Rise time is less than 12 ns.

Fast Sweep

Maximum sweep speed of 10 ns/div (with X10 MAG) assures high frequencies and short-duration pulses are displayed with high resolution.

VERTICAL FEATURES

High Sensitivity

5 mV/div sensitivity for full bandwidth. High-sensitivity 1 mV/div and 2 mV/div using PULL X5 gain control.

Calibrated Voltage Measurements

Accurate voltage measurements ($\pm 3\%$) on 10 calibrated ranges from 5 mV/div to 5 V/div. Vertical gain fully adjustable between calibrated ranges.

SWEEP FEATURES

Calibrated Time Measurements

Accurate ($\pm 3\%$) time measurements. The main sweep has 23 calibrated ranges from 2 S/div to 0.1 μ S/div. The delayed sweep on the Model 2125C has 23 calibrated ranges from 2 S/div to 0.1 μ S/div. Sweep time is fully adjustable between calibrated ranges.

X10 Sweep Magnification

Allows closer examination of waveforms, increases maximum sweep rate to 10 nS/div.

DUAL TIME BASE FEATURES

(Models 2125C & 2160C)

Dual Sweep Generators

Main sweep gives normal waveform display, delayed sweep may be operated at faster sweep speed to expand a portion of the waveform.

Four Sweep Modes

Choice of main sweep only, delayed sweep only, main sweep and delayed sweep sharing the trace (percentage of main/delayed sweep adjustable), or X-Y.

Adjustable Start Of Delayed Sweep

DELAY TIME POSITION control allows adjustment of delayed sweep starting point.

TRIGGERING FEATURES

Two Trigger Modes

Selectable normal (triggered) or automatic sweep modes.

Triggered Sweep

Sweep remains at rest unless adequate trigger signal is applied. Fully adjustable trigger level and (+) or (-) slope.

FEATURES

AUTO Sweep

Selectable AUTO sweep provides sweep without trigger input, automatically reverts to triggered sweep operation when adequate trigger is applied.

Five Trigger Sources

Five trigger source selections, including CH 1, CH 2, alternate, EXT, and LINE.

Video Sync

Frame (TV V) or Line (TV H) triggering selectable for observing composite video waveforms. TV-H position can also be used as low frequency reject and TV-V position can be used as high frequency reject.

Variable Holdoff

Trigger inhibit period after end of sweep adjustable. Permits stable observation of complex pulse trains.

OTHER FEATURES

X-Y Operation

Channel 1 can be applied as horizontal deflection (X-axis) while channel 2 provides vertical deflection (Y-axis).

Built-in Probe Adjust Square Wave

A 2 V p-p, 1 kHz square wave generator permits probe compensation adjustment.

Component Test Function (Model 2125C & 2160C)

Built-in X-Y type component tester applies fixed level ac signal to components for display of signature on CRT.

Channel 2 (Y) Output (Model 2125C & 2160C)

A buffered 50 Ω output of the channel 2 signal is available at the rear panel for driving a frequency counter or other instruments. The output is 50 mV/div (nominal) into 50 Ω .

Z-Axis Input (Model 2125C & 2160C)

Rear panel Z-Axis input allows intensity modulation.

Supplied With Two Probes

SPECIFICATIONS

CRT:

Type: 6-inch rectangular with integral graticule, P31 phosphor.

Display Area: 8 x 10 div (1 div = 1 cm).

Accelerating Voltage: 2 kV, 12 kV (Model 2160C)

Phosphor: P31.

Trace Rotation: Electrical, front panel adjustable.

Scale Illumination: Continuously variable (Models 2125C & 2160C)

Beam Finder (Models 2125C & 2160C)

VERTICAL AMPLIFIERS (CH 1 and CH 2)

Sensitivity: 5 mV/div to 5 V/div, 1 mv/div to 1 V/div at X5 MAG.

Attenuator: 10 calibrated steps in 1-2-5 sequence. Vernier control provides fully adjustable sensitivity between steps; range 1/1 to at least 1/3.

Accuracy: $\pm 3\%$, 5 mV to 5 V/div; 5%, at X5 MAG.

Input Resistance: 1 M Ω $\pm 2\%$.

Input Capacitance: 25 pF ± 10 pF.

Frequency Response:

5 mV/div to 5 V/div:

DC to 30 MHz (-3 dB).

DC to 60 MHz (-3 dB). Model 2160C

X5 MAG:

DC to 10 MHz (-3 dB).

DC to 15 MHz (-3 dB). Model 2160C

Rise Time:

12 nS; 35 nS at X5 MAG.

5.8 nS Model 2160C

Overshoot: Less than 5%.

Operating Modes:

CH 1: CH 1, single trace.

CH 2: CH 2, single trace.

DUAL: CH 1 and CH 2, dual trace.
Alternate or Chop selectable at any sweep rate.

ADD: Algebraic sum of CH 1 + CH 2.

Chop Frequency: Approximately 500 kHz.

Polarity Reversal: CH 2 invert.

Maximum Input Voltage: 400 V (dc + ac peak).

HORIZONTAL AMPLIFIER

(Input through channel 1 input)

X-Y mode:

CH 1 = X axis.

CH 2 = Y axis.

Sensitivity: Same as vertical channel 2.

Input Impedance: Same as vertical channel 2.

Frequency Response:

DC to 1 MHz (-3 dB).

X-Y Phase Difference: 3° or less at 50 kHz.

Maximum Input Voltage: Same as vertical channel 1.

SWEEP SYSTEM

Operating Modes:

Models 2125C & 2160C: Main, Mix (both main and delayed sweep displayed), Delay (only delayed sweep displayed), X-Y

Model 2120C: Main only.

Main Time Base: 0.1 μ S/div to 2.0 S/div in 1-2-5 sequence, 23 steps. Vernier control provides fully adjustable sweep time between steps.

Delayed Time Base (Models 2125C & 2160C only):

0.1 μ S/div to 2.0 S/div in 1-2-5 sequence, 23 steps.

Accuracy: $\pm 3\%$, except $\pm 6\%$ on 0.2 S/div and $\pm 20\%$ on 0.1 μ S/div.

Sweep Magnification: X10 $\pm 10\%$.

Holdoff: Continuously adjustable for main time base from NORM to 5 times normal.

Delay Time Position: Control sets percentage of display that is devoted to main and delayed sweep.

Delay Jitter: 1/10,000 of full scale sweep time.

TRIGGERING

Trigger Modes:

AUTO (free run), NORM, TV-V, TV-H.

Trigger Source:

CH 1, CH 2, Alternate, EXT, LINE.

Slope:

(+) or (-).

SPECIFICATIONS

Trigger Coupling:

AUTO:	Sweep free-runs in absence of suitable trigger signal.
NORM:	Sweep triggered only by adequate trigger signal.
TV-V:	Video vertical sync pulses are selected. Also usable for high frequency reject.
TV-H:	Video horizontal sync pulses are selected. Also usable for low frequency reject.

Trigger Sensitivity:

Auto:	1.5 div (internal) ≥0.5 Vp-p (external) 100 Hz – 40 MHz (2125C) 100 Hz – 30 MHz (2120C)
Norm:	1.5 div (internal) ≥0.5 Vp-p (external) 100 Hz – 40 MHz (2125C) DC – 30 MHz (2120C)
TV-V:	1.0 div (internal) ≥0.5 Vp-p (external) DC – 1 kHz (2125C) 20 Hz – 1 kHz (2120C)
TV-H:	1.0 div (internal) ≥0.5 Vp-p (external) 1 kHz – 100 kHz

Maximum External Trigger Voltage: 300 V (dc + ac peak).

COMPONENT TESTER (Modes 2125C & 2160C)

Components Tested: Resistors, capacitors, inductors, and semiconductors.

Test Voltage: 6 V rms maximum (open).

Test Current: 11 mA maximum (shorted).

Test Frequency: Line frequency (60 Hz in USA).

OTHER SPECIFICATIONS

Cal/Probe Compensation Voltage: 2 V p-p ±3% square wave, 1 kHz nominal.

CH 2 (Y) Output (Models 2125C & 2160C):

Output Voltage: 50 mV/div (nominal into 50 ohm load).

Output Impedance: Approximately 50 ohms.

Frequency Response: 20 Hz to 30 MHz, –3 dB.

Intensity Modulation (Models 2125C & 2160C)

Input Signal: TTL level, intensity increasing with more positive levels, decreased intensity with more negative levels.

Input Impedance: Approximately 50 kΩ.

Usable Frequency Range: DC to 5 MHz.

Maximum Input Voltage: 30 V (dc + ac peak).

Power Requirements: 100–130 VAC or 200–260 VAC, 50/60 Hz, 38 watts.

Dimensions (H × W × D):

5.2" × 12.8" × 15.7"
(132 × 324 × 398 mm).

Weight: 16.8 lbs (7.6 kg).

Environment:

Within Specified Accuracy: +10° to +35° C, 10–80% relative humidity.

Full Operation: 0° to +50° C, 10–80% relative humidity.

Storage: –30° to +70° C, 10–90% relative humidity.

ACCESORIES SUPPLIED:

Two Switchable X1/X10 Probes.
Instruction Manual.
AC Line Cord.

CONTROLS AND INDICATORS

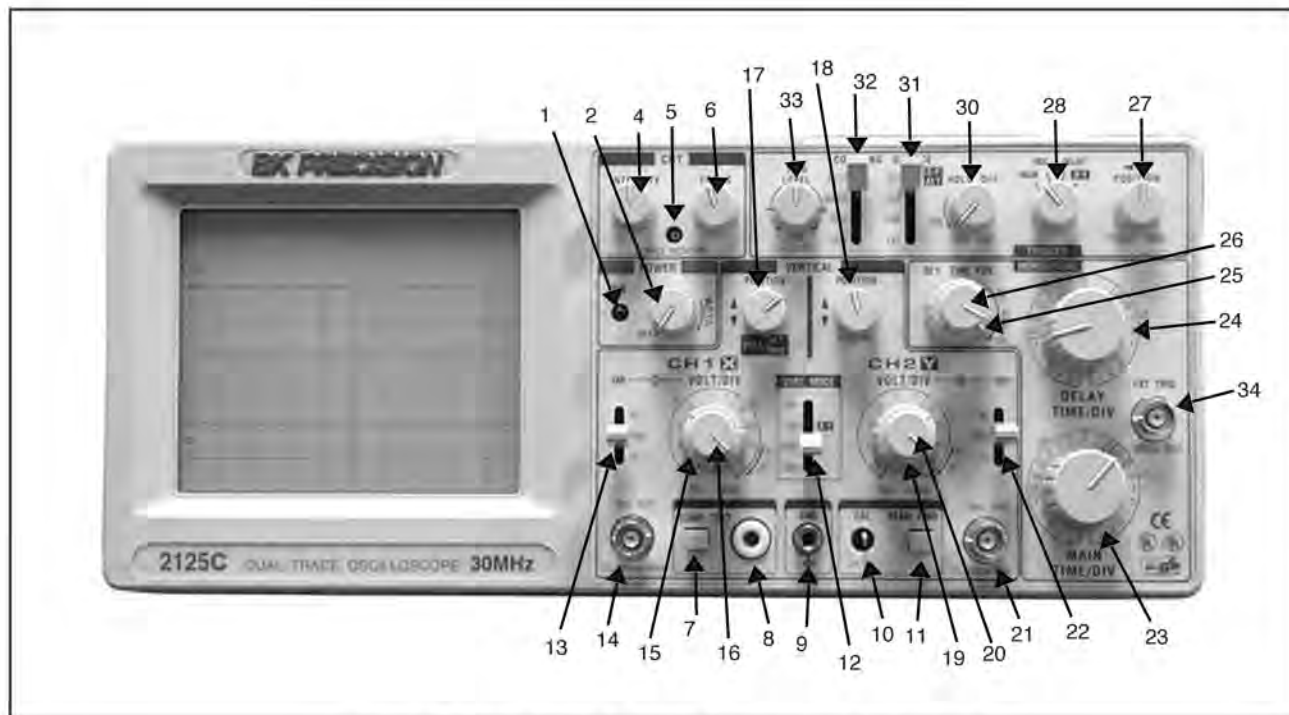

Fig. 1. Models 2125C & 2160C Controls and Indicators.

GENERAL FUNCTION CONTROLS

1. **ON Indicator.** Lights when oscilloscope is “on”.
2. **2125C & 2160C POWER/Scale ILLUMINATION Control.** Clockwise rotation from OFF position turns oscilloscope “on”. Further clockwise rotation increases amount of graticule illumination.
3. **2120C POWER Pushbutton.** Turns oscilloscope “on” and “off”
4. **INTENSITY Control.** Adjusts brightness of trace. Note that it is normal to see some reflective artifacts when increasing the intensity over 50%.
5. **TRACE ROTATION Control.** Adjusts to maintain trace at a horizontal position.
6. **FOCUS Control.** Adjusts trace focus.
7. **2125C & 2160C COMPONENT TEST Pushbutton.** With pushbutton set to “in” position, Component Test mode is enabled. Normal scope operation is enabled with pushbutton in “out” position.
8. **2125C & 2160C COMPONENT TEST Jack.** “Banana”-type HI-side input jack for connection to component in Component Test operating mode.
9. **GND** \perp Terminal. Oscilloscope chassis ground jack, and earth ground via three-wire ac power cord. On Model 2125A, also serves as LO-side Component Test jack.

10. **CAL Terminal.** Terminal provides 2V p-p, 1kHz (nominal) square wave signal. This signal is useful for checking probe compensation adjustment, as well as providing a rough check of vertical calibration.
11. **2125C & 2160C BEAM FIND Pushbutton.** Momentary-contact pushbutton speeds setup of trace positioning by bringing the beam into graticule area; operates independently of other display controls.

VERTICAL CONTROLS

12. **VERTICAL MODE Switch.** Selects vertical display mode. Four-position lever switch with the following positions:

CH1:

Displays the channel 1 signal by itself.

CH2/X-Y:

CH2: displays the channel 2 signal by itself.

X-Y: used in conjunction with the X-Y control and Trigger SOURCE switch to enable X-Y display mode.

DUAL:

Displays the channel1 and channel2 signals simultaneously. Dual-trace mode may be either alternate or chopped sweep; the description under **HOLDOFF/PULL CHOP** control.

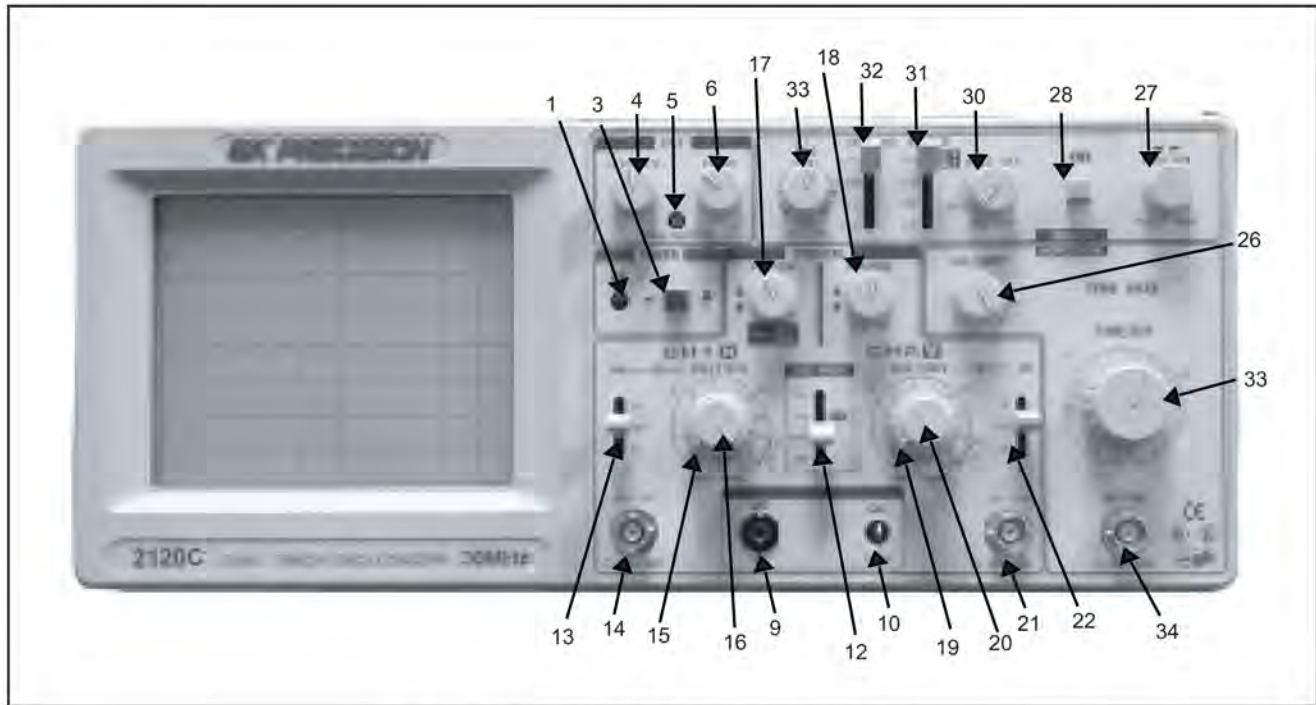

Fig. 2. Model 2120C Controls and Indicators.

ADD:

The inputs from channel 1 and channel 2 are summed and displayed as a single signal. If the Channel 2 **POSITION/PULL INVERT** control is pulled out, the input from channel 2 is subtracted from channel 1 and the difference is displayed as a single signal.

- 13. **CH1 AC-GND-DC Switch.** Three-position lever switch with the following positions:

AC:

Channel 1 input signal is capacitively coupled; dc component is blocked.

GND:

Opens signal path and grounds input to vertical amplifier. This provides a zero-volt base line, the position of which can be used as a reference when performing dc measurements.

DC:

Direct coupling of channel 1 input signal; both ac and dc components of signal produce vertical deflection.

- 14. **CH1 (X) Input Jack.** Vertical input for channel 1. X-axis input for X-Y operation.
- 15. **CH1 (X) VOLTS/DIV Control.** Vertical attenuator for channel 1. Provides step adjustment of vertical sensitivity. When channel 1 **VARIABLE** control is set to **CAL**, vertical sensitivity is calibrated in 10 steps from 5 mV/div to 5 V/div in a 1-2-5 sequence. When

the X-Y mode of operation is selected, this control provides step adjustment of X-axis sensitivity.

- 16. **CH1 VARIABLE/PULL X5 MAG Control:**

VARIABLE:

Rotation provides vernier adjustment of channel 1 vertical sensitivity. In the fully-clockwise (**CAL**) position, the vertical attenuator is calibrated. Counterclockwise rotation decreases gain sensitivity. In X-Y operation, this control becomes the vernier X-axis sensitivity control.

PULL X5 MAG:

When pulled out, increases vertical sensitivity by a factor of five. Effectively provides two extra sensitivity settings: 2 mV/div and 1 mV/div. In X-Y mode, increases X-sensitivity by a factor of five.

- 17. **CH1 POSITION/PULL ALT TRIGGER Control:**

POSITION:

Adjusts vertical position of channel 1 trace.

PULL ALT:

Used in conjunction with the **Trigger SOURCE** switch to activate alternate triggering. See the description under the **Trigger SOURCE** switch.

- 18. **CH2 POSITION/PULL INVERT Control:**

POSITION:

Adjusts vertical position of channel 2 trace. In X-Y operation, rotation adjusts vertical position of X-Y display.

PULL INVert:

When pushed in, the polarity of the channel 2 signal is normal. When pulled out, the polarity of the channel 2 signal is reversed, thus inverting the waveform.

19. **CH2 VOLTS/DIV Control.** Vertical attenuator for channel 2. Provides step adjustment of vertical sensitivity. When channel 2 **VARIABLE** control is set to **CAL**, vertical sensitivity is calibrated in 10 steps from 5 mV/div to 5 V/div in a 1-2-5 sequence. When the X-Y mode of operation is selected, this control provides step adjustment of Y-axis sensitivity.

20. **CH2 VARIABLE/PULL X5 MAG Control:**

VARIABLE:

Rotation provides vernier adjustment of channel 2 vertical sensitivity. In the fully-clockwise (**CAL**) position, the vertical attenuator is calibrated. Counterclockwise rotation decreases gain sensitivity. In X-Y operation, this control becomes the vernier Y-axis sensitivity control.

PULL X5 MAG:

When pulled out, increases vertical sensitivity by a factor of five. Effectively provides two extra sensitivity settings: 2 mV/div and 1 mV/div. In X-Y mode, increases Y-sensitivity by a factor of five.

21. **CH2 (Y) Input Jack.** Vertical input for channel 2. Y-axis input for X-Y operation.

22. **CH2 AC-GND-DC Switch.** Three-position lever switch with the following positions:

AC:

Channel 2 input signal is capacitively coupled; dc component is blocked.

GND:

Opens signal path and grounds input to vertical amplifier. This provides a zero-volt base line, the position of which can be used as a reference when performing dc measurements.

DC:

Direct coupling of channel 2 input signal; both ac and dc components of signal produce vertical deflection.

HORIZONTAL CONTROLS

23. **Main Time Base TIME/DIV Control.** Provides step selection of sweep rate for the main time base. When the **VARIABLE Sweep** control is set to **CAL**, sweep rate is calibrated. This control has 23 steps, from 0.1 μ S/div to 2 S/div, in a 1-2-5 sequence.

24. **2125C & 2160C. DELAY Time Base TIME/DIV Control.** Provides step selection of sweep rate for

delayed sweep time base. This control has 23 steps, from 0.1 μ S/div to 2 S/div, in a 1-2-5 sequence.

25. **2125C & 2160C. DELAY TIME POSItion Control.** Sets starting point of delayed sweep. Clockwise rotation causes delayed sweep to begin earlier.

26. **VARIABLE Sweep Control.** Rotation of control is vernier adjustment for sweep rate. In fully clockwise (**CAL**) position, sweep rate is calibrated. On the Model 2125C, this control is the vernier adjustment for both the main and delayed time bases.

27. **◀▶ POSItion/PULL X10 MAG Control.**

◀▶ POSItion:

Horizontal (X) position control.

PULL X10 MAG:

Selects ten times sweep magnification when pulled out, normal when pushed in. Increases maximum sweep rate to 10 nS/div.

28. **2125C & 2160C. Sweep Mode Switch.** Selects sweep (horizontal) mode. Four-position rotary switch with the following positions:

MAIN:

Only the main sweep operates, with the delayed sweep inactive.

MIX:

The main and delayed sweep share a single trace; main sweep occupies the left portion of the display; delayed sweep occupies the right portion of the display. The **DELAY TIME POSItion** control determines the percentage of display that is main sweep and the percentage of display that is delayed sweep (main sweep is usually brighter than the delayed sweep). Delayed sweep speed cannot be slower than main sweep speed.

DELAY:

Only delayed sweep operates, while main sweep stays inactive. **DELAY TIME POSItion** control determines the starting point of the delayed sweep.

X-Y:

Used with the **VERTICAL MODE** switch and **Trigger SOURCE** switch to select X-Y operating mode. The channel 1 input becomes the X-axis and the channel 2 input becomes the Y-axis. Trigger source and coupling are disabled in this mode.

29. **2120C Only. X-Y Switch.** Used with the **VERTICAL MODE** switch and **Trigger SOURCE** switch to select X-Y operating mode. The channel 1 input becomes the X-axis and the channel 2 input becomes the Y-axis. Trigger source and coupling are disabled in this mode.

TRIGGERING CONTROLS

30. HOLDOFF/PULL CHOP Control.

HOLDOFF:

Rotation adjusts holdoff time (trigger inhibit period beyond sweep duration). When control is rotated fully counterclockwise, the holdoff period is **MIN**-imum (normal). The holdoff period increases progressively with clockwise rotation.

PULL CHOP:

When this switch is pulled out in the dual-trace mode, the channel 1 and channel 2 sweeps are chopped and displayed simultaneously (normally used at slower sweep speeds). When it is pushed in, the two sweeps are alternately displayed, one after the other (normally used at higher sweep speeds).

31. Trigger SOURCE Switch. Selects source of sweep trigger. Four-position lever switch with the following positions:

CH1/X-Y/ALT

CH1:

Causes the channel 1 input signal to become the sweep trigger, regardless of the **VERTical MODE** switch setting.

X-Y:

Used with two other switches to enable the X-Y mode — see the Operating Instructions under “XY Operation”.

ALT:

Used with the channel 1 **POSition/PULL ALTernate TRIGger** control to enable alternate triggering. Alternate triggering, used in dual-trace mode, permits each waveform viewed to become its own trigger source.

CH2:

The channel 2 signal becomes the sweep trigger, regardless of the **VERTical MODE** switch setting.

LINE:

Signal derived from input line voltage (50/60 Hz) becomes trigger.

EXT:

Signal from **EXTernal TRIGger** jack becomes sweep trigger.

32. Trigger COUPLING Switch. Selects trigger coupling. Four-position lever switch with the following positions:

AUTO:

Selects automatic triggering mode. In this mode, the oscilloscope generates sweep (free runs) in absence of an adequate trigger; it automatically reverts to triggered sweep operation when an adequate trigger signal is present. On the Model 2125C & 2160C automatic triggering is applicable to both the main sweep and delayed sweep.

NORM:

Selects normal triggered sweep operation. A sweep is generated only when an adequate trigger signal is present.

TV-V:

Used for triggering from television vertical sync pulses. Also serves as lo-pass/dc (high frequency reject) trigger coupling.

TV-H:

Used for triggering from television horizontal sync pulses. Also serves as hi-pass (low frequency reject) trigger coupling.

33. TRIGGER LEVEL/PULL (-) SLOPE Control.

TRIGGER LEVEL:

Trigger level adjustment; determines the point on the triggering waveform where the sweep is triggered. Rotation in the (-) direction (counterclockwise) selects more negative triggering point; rotation in the (+) direction (clockwise) selects more positive triggering point.

PULL (—) SLOPE:

Two-position push-pull switch. The “in” position selects a positive-going slope and the “out” position selects a negative-going slope as triggering point for main sweep.

34. EXTERNAL TRIGGER Jack. External trigger input for single- and dual-trace operation.

REAR PANEL CONTROLS (not shown)

35. Fuse Holder/Line Voltage Selector. Contains fuse and selects line voltage.

36. Power Cord Receptacle.

37. 2125E/'4382E CH 2 (Y) SIGNAL OUTPUT Jack.

Output terminal where sample of channel 2 signal is available. Amplitude of output is nominally 50 mV per division of vertical deflection seen on CRT when terminated into 50 Ω. Output impedance is 50 Ω.

38. 2125E/'4382E'Z-Axis Input Jack. Input jack for intensity modulation of CRT electron beam. TTL compatible (5 V p-p sensitivity). Positive levels increase intensity.

39. Handle/Tilt Stand.

40. Feet/Cord Wrap.

OPERATING INSTRUCTIONS

NOTE

All operating instructions in this chapter apply equally to all Models except for the sections on “Delayed Sweep Operation” and “Component Test”, which apply only to the Models 2125C & 2160C. Other differences are noted when necessary.

SAFETY PRECAUTIONS

WARNING

The following precautions must be observed to help prevent electric shock.

1. When the oscilloscope is used to make measurements in equipment that contains high voltage, there is always a certain amount of danger from electrical shock. The person using the oscilloscope in such conditions should be a qualified electronics technician or otherwise trained and qualified to work in such circumstances. Observe the TEST INSTRUMENT SAFETY recommendations listed on the inside front cover of this manual.
2. Do not operate this oscilloscope with the case removed unless you are a qualified service technician. High voltage up to 2100 volts is present when the unit is operating with the case removed.
3. The ground wire of the 3-wire ac power plug places the chassis and housing of the oscilloscope at earth ground. Use only a 3-wire outlet, and do not attempt to defeat the ground wire connection or float the oscilloscope; to do so may pose a great safety hazard.
4. Special precautions are required to measure or observe line voltage waveforms with any oscilloscope. Use the following procedure:
 - a. Do not connect the ground clip of the probe to either side of the line. The clip is already at earth ground and touching it to the hot side of the line may “weld” or “disintegrate” the probe tip and cause possible injury, plus possible damage to the scope or probe.
 - b. Insert the probe tip into one side of the line voltage receptacle, then the other. One side of the receptacle should be “hot” and produce the waveform. The other side of the receptacle is the ac return and no waveform should result.

EQUIPMENT PROTECTION PRECAUTIONS

CAUTION

The following precautions will help avoid damage to the oscilloscope.

1. Never allow a small spot of high brilliance to remain stationary on the screen for more than a few seconds. The screen may become permanently burned. A spot will occur when the scope is set up for X-Y operation and no signal is applied. Either reduce the intensity so the spot is barely visible, apply signal, or switch back to normal sweep operation. It is also advisable to use low intensity with **AUTO** triggering and no signal applied for long periods. A high intensity trace at the same position could cause a line to become permanently burned onto the screen.
2. Do not obstruct the ventilating holes in the case, as this will increase the scope’s internal temperature.
3. Excessive voltage applied to the input jacks may damage the oscilloscope. The maximum ratings of the inputs are as follows:
 - CH 1 and CH 2:
400 V dc + ac peak.
 - EXT TRIG:
300 V dc + ac peak.
 - Z-AXIS INPUT (Model 2125C & 2160C):
30 V (dc and ac peak).
4. Always connect a cable from the ground terminal of the oscilloscope to the chassis of the equipment under test. Without this precaution, the entire current for the equipment under test may be drawn through the probe clip leads under certain circumstances. Such conditions could also pose a safety hazard, which the ground cable will prevent.
5. The probe ground clips are at oscilloscope and earth ground and should be connected only to the earth ground or isolated common of the equipment under test. To measure with respect to any point other than the common, use CH 2 – CH 1 subtract operation (**ADD** mode and **INV 1**), with the channel 2 probe to the point of measurement and the channel 1 probe to the point of reference. Use this method even if the reference point is a dc voltage with no signal.



OPERATING INSTRUCTIONS

OPERATING TIPS

The following recommendations will help obtain the best performance from the oscilloscope.

1. Always use the probe ground clips for best results, attached to a circuit ground point near the point of measurement. Do not rely solely on an external ground wire in lieu of the probe ground clips as undesired signals may be introduced.
2. Avoid the following operating conditions:
 - a. Direct sunlight.
 - b. High temperature and humidity.
 - c. Mechanical vibration.
 - d. Electrical noise and strong magnetic fields, such as near large motors, power supplies, transformers, etc.
3. Occasionally check trace rotation, probe compensation, and calibration accuracy of the oscilloscope using the procedures found in the MAINTENANCE section of this manual.
4. Terminate the output of a signal generator into its characteristic impedance to minimize ringing, especially if the signal has fast edges such as square waves or pulses. For example, the typical 50 Ω output of a square wave generator should be terminated into an external 50 Ω terminating load and connected to the oscilloscope with 50 Ω coaxial cable.
5. Probe compensation adjustment matches the probe to the input of the scope. For best results, compensation should be adjusted initially, then the same probe always used with the same channel. Probe compensation should be readjusted when a probe from a different oscilloscope is used.

INITIAL STARTING PROCEDURE

Until you familiarize yourself with the use of all controls, the settings given here can be used as a reference point to obtain a trace on the CRT in preparation for waveform observation.

1. Set these controls as follows:

On both models:

VERTical MODE to **CH1**.

CH1 AC/GND/DC to **GND**.

Trigger COUPLING to **AUTO**.

Trigger SOURCE to **CH1**.

All **POSition** controls and **INTENSITY** control centered (pointers facing up).

Main Time Base control to **1 ms/div**.

On the Model 2125C & 2160C:

Sweep Mode switch to **MAIN**.

2. Press the red **POWER** pushbutton (Model 2120C & 2160C), or rotate the **POWER** control clockwise "away from "OFF" (Model 2125C & 2160C).
3. A trace should appear on the CRT. Adjust the trace brightness with the **INTENSITY** control, and the trace sharpness with the **FOCUS** control.

NOTE

On the Model 2125C & 2160C you can use the **BEAM FINDER** pushbutton to locate a trace that has been moved off the screen by the **POSition** controls. When the button is pushed, a compressed version of the trace is brought into view which indicates the location of the trace.

SINGLE TRACE DISPLAY

Either channel 1 or channel 2 may be used for single-trace operation. To observe a waveform on channel 1:

1. Perform the steps of the "Initial Starting Procedure".
2. Connect the probe to the **CH 1 (X)** input jack.
3. Connect the probe ground clip to the chassis or common of the equipment under test. Connect the probe tip to the point of measurement.
4. Move the **CH1 AC/GND/DC** switch out of the **GND** position to either **DC** or **AC**.
5. If no waveforms appear, increase the sensitivity by turning the **CH 1 VOLTS/DIV** control clockwise to a position that gives 2 to 6 divisions vertical deflection.
6. Position the waveform vertically as desired using the **CH1 POSition** control.
7. The display on the CRT may be unsynchronized. Refer to the "Triggering" paragraphs in this section for procedures on setting triggering and sweep time controls to obtain a stable display showing the desired number of waveforms.

DUAL TRACE DISPLAY

In observing simultaneous waveforms on channel 1 and 2, the waveforms are usually related in frequency, or one of the waveforms is synchronized to the other, although the basic frequencies are different. To observe two such related waveforms simultaneously, perform the following:

1. Connect probes to both the **CH 1 (X)** and **CH 2 (Y)** input jacks.
2. Connect the ground clips of the probes to the chassis or common of the equipment under test. Connect the tips of the probes to the two points in the circuit where waveforms are to be measured.

3. To view both waveforms simultaneously, set the **VERTICAL MODE** switch to **DUAL** and select either **ALT** (alternate) or **CHOP** with the **PULL CHOP** switch.
4. In the **ALT** sweep mode (**PULL CHOP** switch pushed in), one sweep displays the channel 1 signal and the next sweep displays the channel 2 signal in an alternating sequence. Alternate sweep is normally used for viewing high-frequency or high-speed waveforms at sweep times of 1 ms/div and faster, but may be selected at any sweep time.
5. In the **CHOP** sweep mode (**PULL CHOP** switch pulled out), the sweep is chopped (switched) between channel 1 and channel 2. Using **CHOP**, one channel does not have to “wait” for a complete swept display of the other channel. Therefore, portions of both channel’s waveforms are displayed with the phase relationship between the two waveforms unaltered. Chop sweep is normally used for low-frequency or low-speed waveforms at sweep times of 1 ms/div and slower; or where the phase relationship between channel 1 and channel 2 requires measurement.

If chop sweep is used at sweep times of 0.2 ms/div and faster, the chop rate becomes a significant portion of the sweep and may become visible in the displayed waveform. However, you may select chop sweep at any sweep time for special applications.

6. Adjust the channel 1 and 2 **POSITION** controls to place the channel 1 trace above the channel 2 trace.
7. Set the **CH 1** and **CH 2 VOLTS/DIV** controls to a position that gives 2 to 3 divisions of vertical deflection for each trace. If the display on the screen is unsynchronized, refer to the “Triggering” paragraphs in this section of the manual for procedures for setting triggering and sweep time controls to obtain a stable display showing the desired number of waveforms.
8. When the **VERTICAL MODE** switch is set to **ADD**, the algebraic sum of CH 1 + CH 2 is displayed as a single trace. When the **PULL INV** switch is pulled out, the algebraic difference of CH 1 – CH 2 is displayed.
9. If two waveforms have no phase or frequency relationship, there is seldom reason to observe both waveforms simultaneously. However, these oscilloscopes do permit the simultaneous viewing of two such unrelated waveforms, using alternate triggering. Refer to the paragraphs on “Triggering - Trigger SOURCE Switch”, for details on alternate triggering.

TRIGGERING

These Oscilloscopes provide versatility in sync triggering for ability to obtain a stable, jitter-free display in single-trace, or dual-trace operation. The proper settings depend upon the type of waveforms being observed and the type of measurement desired. An explanation of the various controls which affect synchronization is given to help you select the proper setting over a wide range of conditions.

Trigger COUPLING Switch

1. In the **AUTO** position, automatic sweep operation is selected. In automatic sweep operation, the sweep generator free-runs to generate a sweep without a trigger signal. However, it automatically switches to triggered sweep operation if an acceptable trigger source signal is present. The **AUTO** position is handy when first setting up the scope to observe a waveform; it provides sweep for waveform observation until other controls can be properly set. Once the controls are set, operation is often switched back to the normal triggering mode, since it is more sensitive. Automatic sweep must be used for dc measurements and signals of such low amplitude that they will not trigger the sweep.
2. The **NORM** position provides normal triggered sweep operation. The sweep remains at rest until the selected trigger source signal crosses the threshold level set by the **TRIG LEVEL** control. The trigger causes one sweep to be generated, after which the sweep again remains at rest until triggered. In the normal triggering mode, there will be no trace unless an adequate trigger signal is present. In the **ALT VERTICAL MODE** of dual trace operation with the **SOURCE** switch also set to **ALT**, there will be no trace unless both channel 1 and channel 2 signals are adequate for triggering. Typically, signals that produce even one division of vertical deflection are adequate for normal triggered sweep operation.
3. The **TV H** and **TV V** positions are primarily for viewing composite video waveforms. Horizontal sync pulses are selected as trigger when the trigger **COUPLING** switch is set to the **TV H** position, and vertical sync pulses are selected as trigger when the trigger **COUPLING** switch is set to the **TV V** position. The **TV H** and **TV V** positions may also be used as low frequency reject and high frequency reject coupling, respectively. Additional procedures for observing video waveforms are given later in this section of the manual.

Trigger SOURCE Switch

The trigger **SOURCE** switch (**CH 1**, **CH 2**, etc.) selects the signal to be used as the sync trigger.

1. If the **SOURCE** switch is set to **CH 1** (or **CH 2**) the channel 1 (or channel 2) signal becomes the trigger source regardless of the **VERTICAL MODE** selection. **CH 1**, or **CH 2** are often used as the trigger source for phase or timing comparison measurements.
2. By setting the **SOURCE** switch to **ALT** (same as **CH1**) and **PULL ALT TRIG** pulled, alternating triggering mode is activated. In this mode, the trigger source alternates between **CH 1** and **CH 2** with each sweep. This is convenient for checking amplitudes, waveshape, or waveform period measurements, and even permits simultaneous observation of two waveforms which are not related in frequency or period. However, this setting is not suitable for phase or timing comparison measurements. For such measurements, both traces must be triggered by the same sync signal. Alternate triggering can only be used in dual-trace mode (**VERT MODE** set to **DUAL**), and with alternate sweep only (**PULL CHOP** not engaged).
3. In the **LINE** position, triggering is derived from the input line voltage (50/60 Hz) and the trigger **SOURCE** switch is disabled. This is useful for measurements that are related to line frequency.
4. In the **EXT** position, the signal applied to the **EXT TRIG** jack becomes the trigger source. This signal must have a timing relationship to the displayed waveforms for a synchronized display.

TRIG LEVEL/PULL (-) SLOPE Control

(Refer to Fig. 3)

A sweep trigger is developed when the trigger source signal crosses a preset threshold level. Rotation of the **TRIG LEVEL** control varies the threshold level. In the + direction (clockwise), the triggering threshold shifts to a more positive value, and in the - direction (counterclockwise), the triggering threshold shifts to a more negative value. When

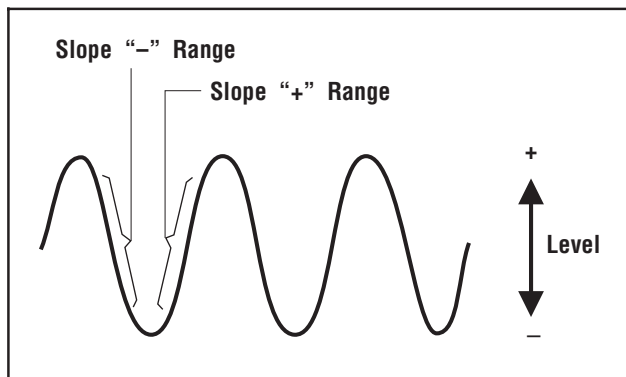

Fig. 3. Function of Slope and Level Controls.

the control is centered, the threshold level is set at the approximate average of the signal used as the triggering source. Proper adjustment of this control usually synchronizes the display.

The **TRIG LEVEL** control adjusts the start of the sweep to almost any desired point on a waveform. On sine wave signals, the phase at which sweep begins is variable. Note that if the **TRIG LEVEL** control is rotated toward its extreme + or - setting, no sweep will be developed in the normal trigger mode because the triggering threshold exceeds the peak amplitude of the sync signal.

When the **PULL (-) SLOPE** control is set to the + ("in") position, the sweep is developed from the trigger source waveform as it crosses a threshold level in a positive-going direction. When the **PULL (-) SLOPE** control is set to the - ("out") position, a sweep trigger is developed from the trigger source waveform as it crosses the threshold level in a negative-going direction.

MAIN TIME BASE Control

Set the **Main Time Base TIME/DIV** control to display the desired number of cycles of the waveform. If there are too many cycles displayed for good resolution, switch to a faster sweep time. If only a line is displayed, try a slower sweep time. When the sweep time is faster than the waveform being observed, only part of it will be displayed, which may appear as a straight line for a square wave or pulse waveform.

HOLDOFF Control

(Refer to Fig. 4)

A "holdoff" period occurs immediately after the completion of each sweep, and is a period during which triggering of the next sweep is inhibited. The normal holdoff period varies with sweep rate, but is adequate to assure complete retrace and stabilization before the next sweep trigger is permitted. The **HOLDOFF** control allows this period to be extended by a variable amount if desired.

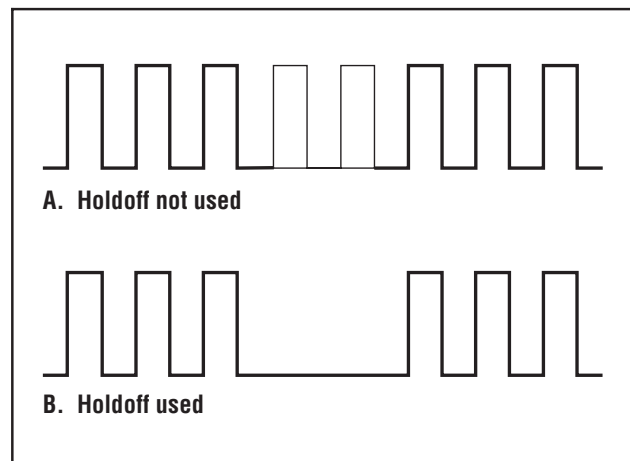

Fig. 4. Use of HOLDOFF Control.

This control is usually set to the **MIN** position (fully counterclockwise) because no additional holdoff period is necessary. The **HOLDOFF** control is useful when a complex series of pulses appear periodically such as in Fig. 4B. Improper sync may produce a double image as in Fig. 4A. Such a display could be synchronized with the **VAR SWEEP** control, but this is impractical because time measurements are then uncalibrated. An alternate method of synchronizing the display is with the **HOLDOFF** control. The sweep speed remains the same, but the triggering of the next sweep is “held off” for the duration selected by the **HOLDOFF** control. Turn the **HOLDOFF** control clockwise from the **MIN** position until the sweep starts at the same point of the waveform each time.

MAGNIFIED SWEEP OPERATION

Since merely shortening the sweep time to magnify a portion of an observed waveform can result in the desired portion disappearing off the screen, magnified display should be performed using magnified sweep.

Using the **POSITION** control, move the desired portion of waveform to the center of the CRT. Pull out the **PULL X10** knob to magnify the display ten times. For this type of display the sweep time is the **Main Time Base TIME/DIV** control setting divided by 10. Rotation of the **POSITION** control can then be used to select the desired portion of the waveforms.

X–Y OPERATION

X–Y operation permits the oscilloscope to perform many measurements not possible with conventional sweep operation. The CRT display becomes an electronic graph of two instantaneous voltages. The display may be a direct comparison of the two voltages such as stereoscope display of stereo signal outputs. However, the **X–Y** mode can be used to graph almost any dynamic characteristic if a transducer is used to change the characteristic (frequency, temperature, velocity, etc.) into a voltage. One common application is frequency response measurements, where the Y axis corresponds to signal amplitude and the X axis corresponds to frequency.

1. On Models 2125C & 2160C, set the **SWEEP MODE** switch to the **X–Y** position. On the Model 2120C, depress the **X–Y** switch. On both models, set the **Trigger Source** and **VERTICAL MODE** switches to **X–Y**.
2. In this mode, channel 1 becomes the X axis input and channel 2 becomes the Y axis input. The X and Y positions are now adjusted using the **POSITION** and the **channel 2 POSITION** controls respectively.
3. Adjust the amount of vertical (Y axis) deflection with the **CH 2 VOLTS/DIV** and **VARIABLE** controls.
4. Adjust the amount of horizontal (X axis) deflection with the **CH 1 VOLTS/DIV** and **VARIABLE** controls.

VIDEO SIGNAL OBSERVATION

Setting the **COUPLING** switch to the **TV-H** or **TV-V** position permits selection of horizontal or vertical sync pulses for sweep triggering when viewing composite video waveforms.

When the **TV-H** mode is selected, horizontal sync pulses are selected as triggers to permit viewing of horizontal lines of video. A sweep time of about 10 $\mu\text{s}/\text{div}$ is appropriate for displaying lines of video. The **VAR SWEEP** control can be set to display the exact number of waveforms desired.

When the **TV-V** mode is selected, vertical sync pulses are selected as triggers to permit viewing of vertical fields and frames of video. A sweep time of 2 ms/div is appropriate for viewing fields of video and 5 ms/div for complete frames (two interlaced fields) of video.

At most points of measurement, a composite video signal is of the (–) polarity, that is, the sync pulses are negative and the video is positive. In this case, use (–) **SLOPE**. If the waveform is taken at a circuit point where the video waveform is inverted, the sync pulses are positive and the video is negative. In this case, use (+) **SLOPE**.

APPLICATIONS GUIDEBOOK

B+K Precision offers a “Guidebook to Oscilloscopes” which describes numerous applications for this instrument and important considerations about probes. It includes a glossary of oscilloscope terminology and an understanding of how oscilloscopes operate. It may be downloaded free of charge from our Web site, www.bkprecision.com.

DELAYED SWEEP OPERATION (Models 2125C & 2160C) (Refer to Fig. 5)

Delayed sweep operation is achieved by use of both the main sweep and the delayed sweep and allows any portion of a waveform to be magnified for observation. Unlike **X10** magnification, delayed sweep allows selectable steps of magnification.

1. Set the **Sweep Mode** switch to the **MAIN** position and adjust the oscilloscope for a normal display.
2. Set the **Sweep Mode** switch to the **MIX** position. The display will show the main sweep on the left portion (representing the **MAIN Time Base** control setting) and the delayed sweep on the right portion (representing the **DELAY Time Base** control setting). The **MAIN Time Base** portion of the trace usually will be brighter than the delayed time base portion. Fig. 5 shows a typical display for the **MIX** display mode.
3. Shift the percentage of the display that is occupied by the main sweep by adjusting the **DELAY TIME POSITION** control. Counterclockwise rotation causes more of the display to be occupied by the main sweep

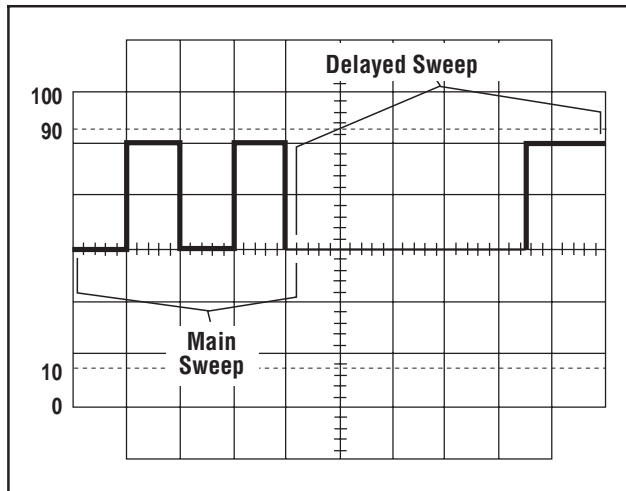

Fig. 5. MIX SWEEP MODE Display.

and clockwise rotation causes more of the display to be occupied by the delayed sweep.

4. Set the **Sweep Mode** switch to the **DELAY** position to display only the magnified delayed sweep portion of the display.

NOTE

In order to obtain meaningful results with delayed sweep, the **DELAY Time Base** control must be set to a faster sweep speed than the **MAIN Time Base** control. Because of this, the oscilloscope automatically prevents (electrically) the **DELAY Time Base** from being set to a slower sweep speed than the **MAIN Time Base**. For example, if the **MAIN Time Base** is set to **0.1 ms/div**, the slowest possible **DELAY Time Base** sweep speed is also **0.1 ms/div**, even if the control is set slower.

COMPONENT TEST OPERATION

(Model 2125)

CAUTION

*Do not apply an external voltage to the **COMP TEST** jacks. Only non-powered circuits should be tested with this unit. Testing powered circuits could damage the instrument and increase the risk of electrical shock.*

The component test function produces a component “signature” on the CRT by applying an ac signal across the device and measuring the resulting ac current. The display represents a graph of voltage (X) versus current (Y). The

component test function can be used to view the signatures of resistors, capacitors, inductors, diodes, and other semiconductor devices. Devices may be analyzed in-circuit or out-of-circuit and combinations of two or more devices may be displayed simultaneously. Each component produces a different signature and the components can be analyzed as outlined below.

Component Test mode is activated by depressing the **COMPONENT TEST** switch. The **SWEEP MODE** switch must not be in the **DELAY** position.

Resistors

A purely resistive impedance produces a signature that is a straight line. A short circuit produces a vertical line and an open circuit causes a horizontal line. Therefore, the higher the resistance, the closer to horizontal the trace will be. Values from 10 Ω to about 5 kΩ are within measurement range. Values below 10 Ω will appear to be a dead short while values above 5 kΩ will appear to be an open circuit. Fig. 6 shows some typical resistance signatures.

To test a resistor, insert one of the resistor’s leads into the white **COMP TEST** jack, and the other into the **GND** jack (make sure that the leads touch the metal walls inside the jacks). To test in-circuit, a pair of test leads can be used to connect the **COMP TEST** and **GND** jacks to the component(s).

Capacitors

CAUTION

*Be sure to discharge capacitors (by shorting the leads together) before connecting to the **COMP TEST** jack. Some capacitors can retain a voltage high enough to damage the instrument.*

A purely capacitive impedance produces a signature that is an ellipse or circle. Value is determined by the size and shape of the ellipse. A very low capacitance causes the ellipse to flatten out horizontally and become closer to a straight horizontal line and a very high capacitance causes the ellipse to flatten out vertically and become closer to a straight vertical line. Values from about 0.33 μF to about 330 μF are within measurable range. Values below 0.33 μF will be hard to distinguish from an open circuit and values above 330 μF will be hard to distinguish from a short circuit. Fig. 7 shows several typical capacitance signatures.

To test a capacitor, insert the capacitor’s positive lead into the white **COMP TEST** jack, and the negative lead into the **GND** jack (make sure that the leads touch the metal walls inside the jacks). To test in-circuit or to test a capacitor with leads that are too short to fit into the **COMP TEST** and **GND** jacks, a pair of test leads can be used to connect the **COMP TEST** and **GND** jacks to the component(s).

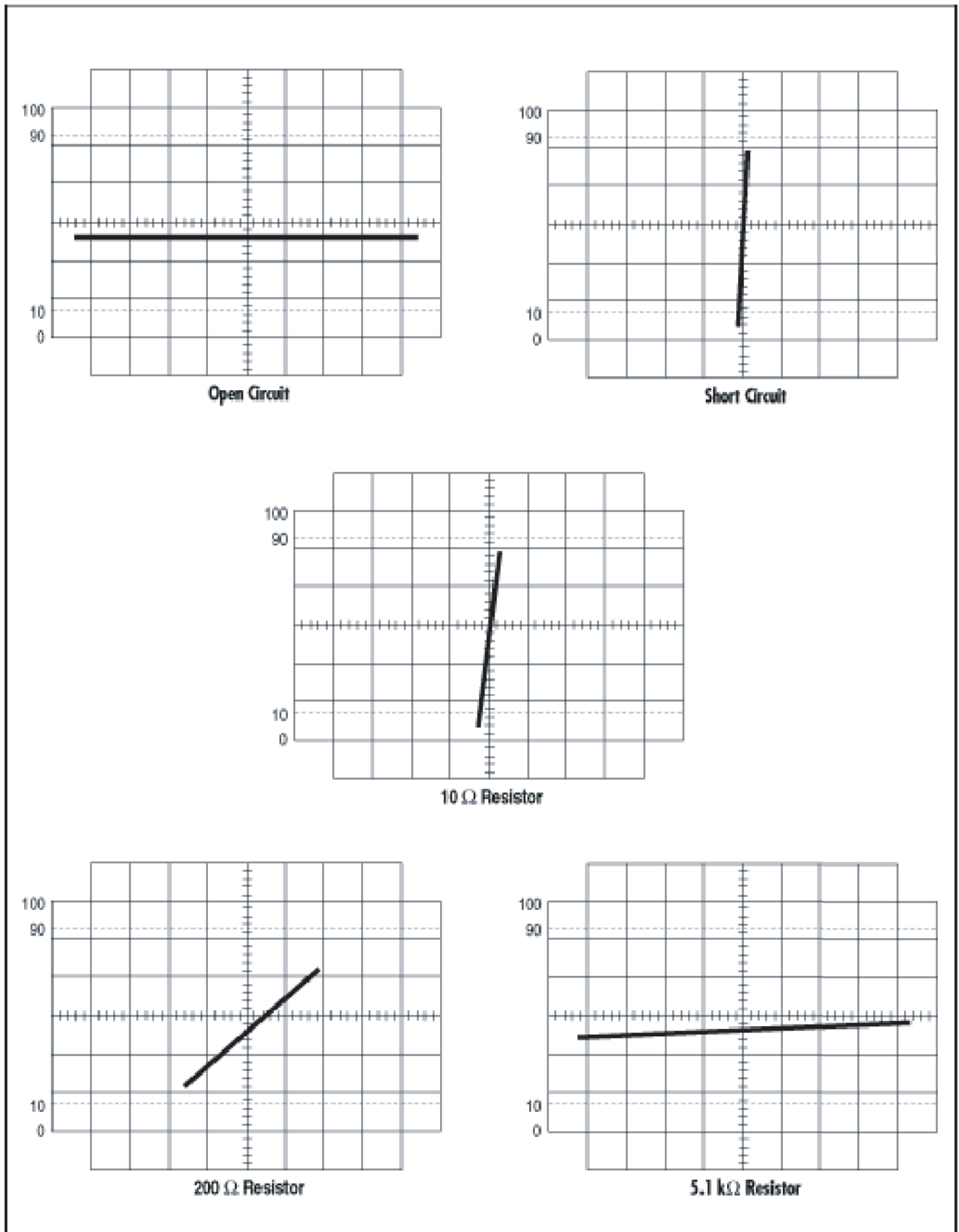

Fig. 6. Typical Resistive Signatures.

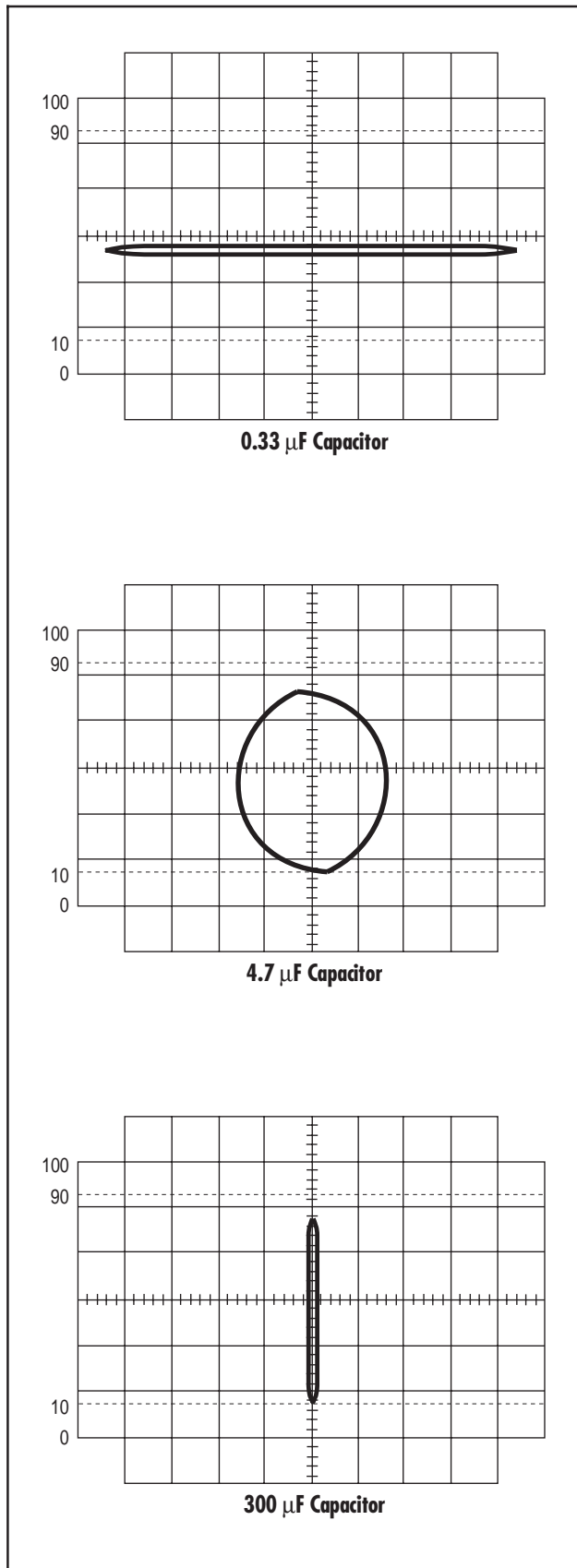

Fig. 7. Typical Capacitive Signatures.

Inductors

Like capacitance, a purely inductive impedance produces a signature that is an ellipse or circle and value is determined by the size and shape of the ellipse. A very high inductance causes the ellipse to flatten out horizontally and a very low inductance causes the ellipse to flatten out vertically. Values from about 0.05 H to about 5 H are within measurement range. Values below 0.05 H will be hard to distinguish from a short circuit and values above 5 H will be hard to distinguish from an open. Fig. 8 shows several typical inductance signatures.

To test an inductor, insert one of the inductor's leads into the white **COMP TEST** jack, and the other into the **GND** jack (make sure that the leads touch the metal walls inside the jacks). To test in-circuit or to test an inductor with leads that are too short to be inserted into the **COMP TEST** and **GND** jacks, a pair of test leads can be used to connect the **COMP TEST** and **GND** jacks to the component(s).

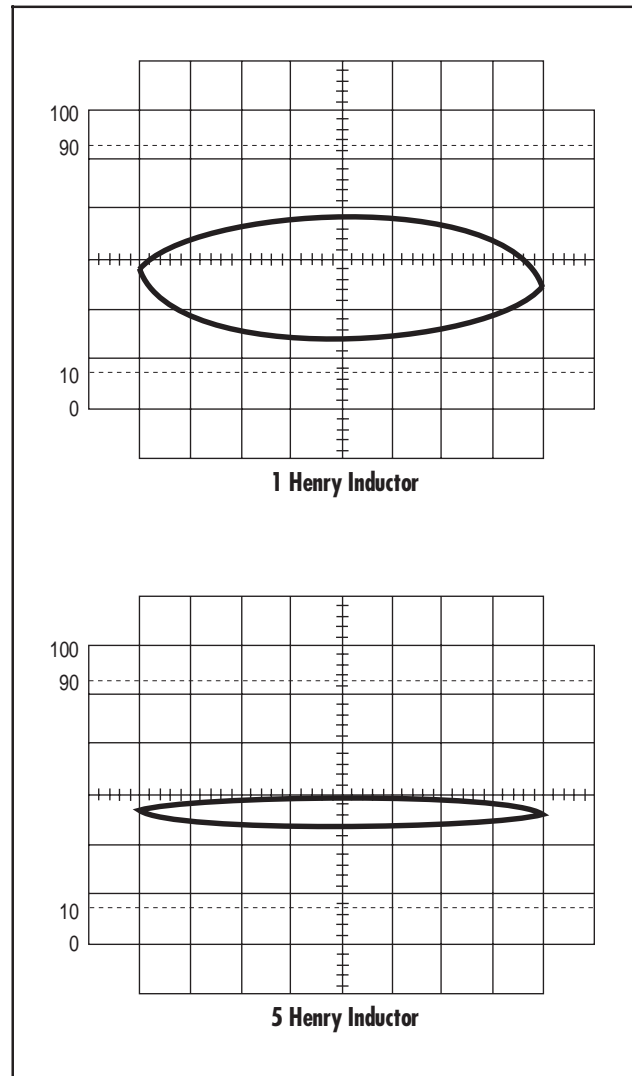

Fig. 8. Typical Inductive Signatures.

Semiconductors

Purely semiconductor devices (such as diodes and transistors) will produce signatures with straight lines and bends. Typical diode junctions produce a single bend with a horizontal and vertical line as shown in Fig. 9. Zener diodes produce a double bend with two vertical and one horizontal line as shown in Fig. 10 (value is determined by the distance of the leftmost vertical component from the center graduation on the CRT). The maximum Zener voltage observable on this feature is about 15 V. It is also possible to test transistors and IC's by testing one pair of pins at a time.

NOTE

When testing diodes it is important to connect the diode's cathode to the white **COMP TEST** jack and the anode to the **GND** jack. Reversing the polarity will not damage the device but the horizontal and vertical components of the signature will appear in different quadrants of the display.

To test semiconductors, insert the diode's or transistor's leads (only two at a time) into the **COMP TEST** and **GND** jacks (make sure that the leads touch the metal walls inside the jacks). To test in-circuit or to test IC's or devices with leads too short to insert into the **COMP TEST** and **GND** jacks, a pair of test leads can be used to connect the **COMP TEST** and **GND** jacks to the component(s).

Combinations of Components

Using the component test feature it is also possible to observe the signatures of combinations of components. Combinations cause signatures that are a combination of the individual signatures for each component. For example, a signature for a resistor and capacitor in parallel will produce a signature with the ellipse of the capacitor but the resistor would cause the ellipse to be at an angle (determined by the value of the resistor). When testing combinations of components it is important to make sure that all the components being connected are within measurement range.

In-Circuit Testing

The component test feature can be very effective in locating defective components in-circuit, especially if a "known good" piece of equipment is available for reference. Compare the signatures from the equipment under test with signatures from identical points in the reference unit. When

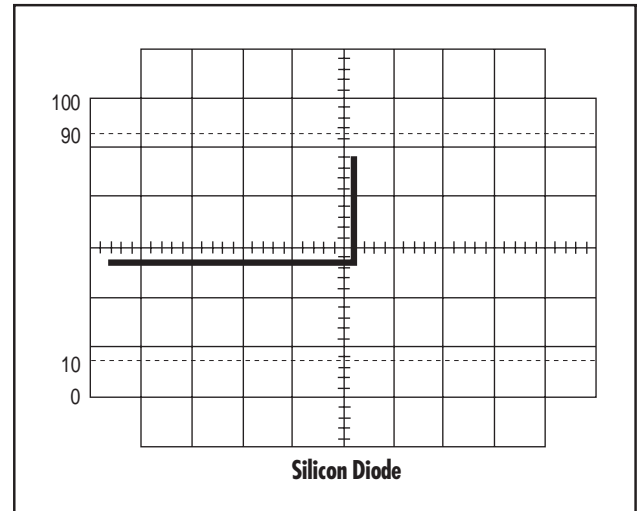

Fig. 9. Typical P-N Junction Signature.

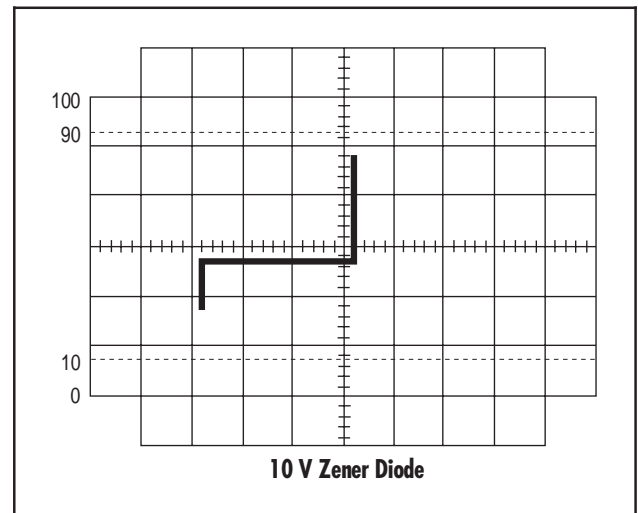

Fig. 10. Typical Zener Signature.

signatures are identical or very similar, the tested component is good. When signatures are distinctively different, the tested component is probably defective.

MAINTENANCE

WARNING

The following instructions are for use by qualified service personnel only. To avoid electrical shock, do not perform any servicing other than contained in the operating instructions unless you are qualified to do so.

High voltage up to 2000 V is present when covers are removed and the unit is operating. Remember that high voltage may be retained indefinitely on high voltage capacitors. Also remember that ac line voltage is present on line voltage input circuits any time the instrument is plugged into an ac outlet, even if turned off. Unplug the oscilloscope and discharge high voltage capacitors before performing service procedures.

FUSE REPLACEMENT

If the fuse blows, the “ON” indicator will not light and the oscilloscope will not operate. The fuse should not normally open unless a problem has developed in the unit. Try to determine and correct the cause of the blown fuse, then replace only with the correct value fuse. For 110/125 V line voltage operation, use an 800 mA, 250 V fuse. For 220/240 V line voltage operation, use a 600 mA, 250 V fuse. The fuse is located on the rear panel adjacent to the power cord receptacle.

Remove the fuseholder assembly as follows:

1. Unplug the power cord from rear of scope.
2. Insert a small screwdriver in fuseholder slot (located between fuseholder and receptacle). Pry fuseholder away from receptacle.
3. When reinstalling fuseholder, be sure that the fuse is installed so that the correct line voltage is selected (see LINE VOLTAGE SELECTION).

LINE VOLTAGE SELECTION

To select the desired line voltage, simply insert the fuse and fuse holder so that the appropriate voltage is pointed to by the arrow. Be sure to use the proper value fuse (see label on rear panel).

PERIODIC ADJUSTMENTS

Probe compensation and trace rotation adjustments should be checked periodically and adjusted if required. These procedures are given below.

Probe Compensation

1. Connect probes to **CH 1** and **CH 2** input jacks. Perform procedure for each probe, one probe at a time.
2. Set the probe to X10 (compensation adjustment is not possible in the X1 position).
3. Touch tip of probe to **CAL** terminal.
4. Adjust oscilloscope controls to display 3 or 4 cycles of **CAL** square wave at 5 or 6 divisions amplitude.
5. Adjust compensation trimmer on probe for optimum square wave (minimum overshoot, rounding off, and tilt). Refer to Fig. 11.

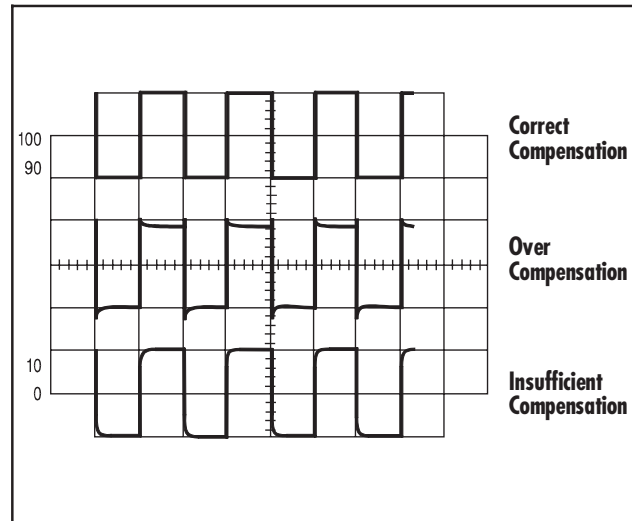

Fig. 11. Probe Compensation Adjustment.

Trace Rotation Adjustment

1. Set oscilloscope controls for a single trace display in **CH 1** mode, and with the channel 1 **AC-GND-DC** switch set to **GND**.
2. Use the channel 1 **POS**ition control to position the trace over the center horizontal line on the graticule scale. The trace should be exactly parallel with the horizontal line.
3. Use the **TRACE ROTATION** adjustment on the front panel to eliminate any trace tilt.

CALIBRATION CHECK

A general check of calibration accuracy may be made by displaying the output of the **CAL** terminal on the screen. This terminal provides a square wave of 2 V p-p. This signal should produce a displayed waveform amplitude of four divisions at .5 V/div sensitivity for both channel 1 and 2 (with probes set for direct). With probes set for X10, there should be four divisions amplitude at 50 mV/div sensitivity. The **VARIABLE** controls must be set to **CAL** during this check.

NOTE

The **CAL** signal should be used only as a general check of calibration accuracy, not as a signal source for performing recalibration adjustments; a voltage standard calibrated at several steps and of 0.3% or better accuracy is required for calibration adjustments.

The **CAL** signal should not be used as a time base standard.

INSTRUMENT REPAIR SERVICE

Because of the specialized skills and test equipment required for instrument repair and calibration, many customers prefer to rely upon **B+K Precision** for this service. To use this service, even if the oscilloscope is no longer under warranty, follow the instructions given in the **SERVICE INFORMATION** portion of this manual. There is a flat rate charge for instruments out of warranty.

APPENDIX

IMPORTANT CONSIDERATIONS FOR RISE TIME AND FALL TIME MEASUREMENTS

Error in Observed Measurement

The observed rise time (or fall time) as seen on the CRT is actually the cascaded rise time of the pulse being measured and the oscilloscope's own risetime. The two rise times are combined in square law addition as follows:

$$T_{\text{observed}} = \sqrt{(T_{\text{pulse}})^2 + (T_{\text{scope}})^2}$$

The effect of the oscilloscope's rise time is almost negligible when its rise time is at least 3 times as fast as that of the pulse being measured. Thus, slower rise times may be measured directly from the CRT. However, for faster rise time pulses, an error is introduced that increases progressively as the pulse rise time approaches that of the oscilloscope. Accurate measurements can still be obtained by calculation as described below.

Direct Measurements

The Models 2125C and 2120C oscilloscopes have a rated rise time of 12 ns. Thus, pulse rise times of about 36ns or greater can be measured directly. Most fast rise times are measured at the fastest sweep speed and using X10 magnification. For the Models 2125C and 2120C, this sweep rate is 10 ns/div. A rise time of less than about four divisions at this sweep speed should be calculated.

Calculated Measurements

For observed rise times of less than 36 ns, the pulse rise time should be calculated to eliminate the error introduced by the cascaded oscilloscope rise time. Calculate pulse rise time as follows:

$$T_{\text{pulse}} = \sqrt{(T_{\text{observed}})^2 + (T_{\text{scope}})^2}$$

Limits of Measurement

Measurements of pulse rise times that are faster than the scope's rated rise time are not recommended because a very small reading error introduces significant error into the calculation. This limit is reached when the "observed" rise time is about 1.3 times greater than the scope's rated rise time, about 16 ns minimum for the Models 2125C and 2120C.

Probe Considerations

For fast rise time measurements which approach the limits of measurement, direct connection via 50 Ω coaxial cable and 50 Ω termination is recommended where possible. When a probe is used, its rise time is also cascaded in square law addition. Thus the probe rating should be considerably faster than the oscilloscope if it is to be disregarded in the measurement.

2121C Specification and operating instruction

2121C model Oscilloscope is identical to the model 2120C except for the built in Frequency Counter module. This portion contains specific information regarding the built in Frequency Counter.

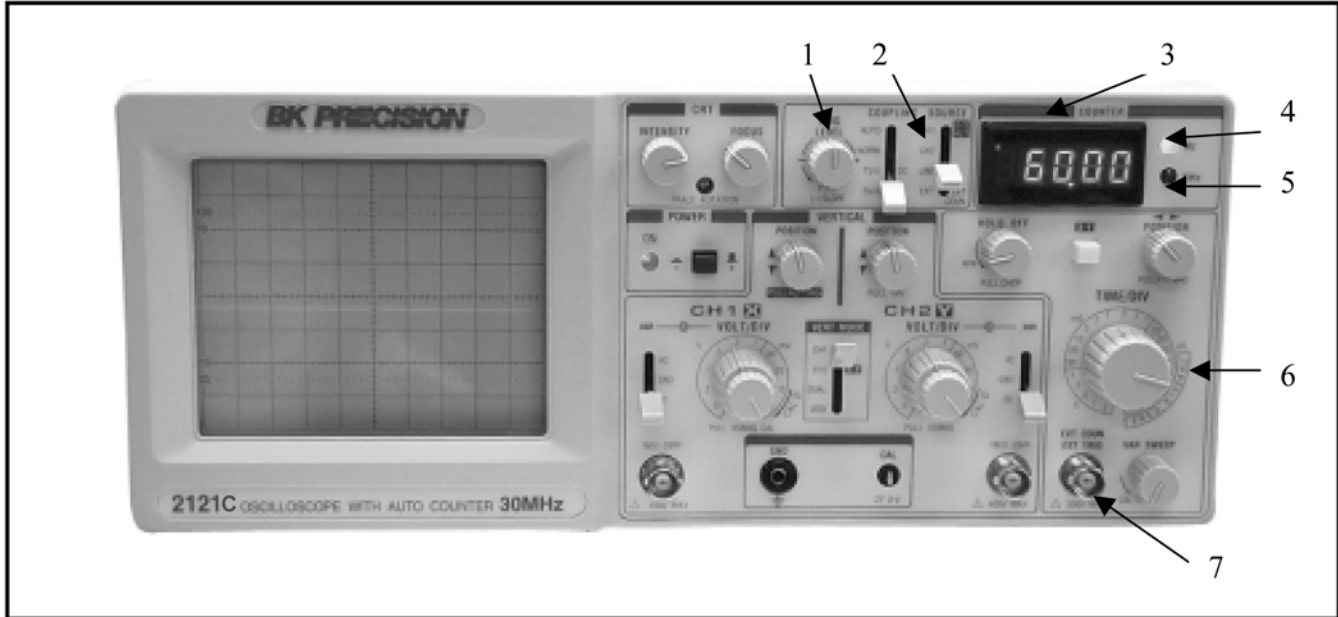

Model 2121C Controls and Indicators

Counter Controls

1. TRIGGER LEVEL control.
Trigger level adjustment selects the point of triggering on measured signal.
PULL (-) SLOPE
Two position push/pull switch. The “in” position selects a positive-going slope and “out” selects a negative going slope triggering point for Counter.
2. Trigger SOURCE Switch. Selects the Counter input. Could be set to CH1, CH2, LINE or External.
3. 5 digits Counter display.
4. Hz. LED. Is indicates when the display in Hz mode
5. KHz. LED. Is indicates when the display in KHz mode.
6. Time/div frequency selector.

7. Universal Counter input Jack.

2121 Universal Counter Specifications.

DISPLAY:

5 Digits, 0.36” Red LED, Display at “Hz” or “KHz” auto range.

AUTO SELECT:

Gate time is auto select from 10 to 0.25 seconds.

AUTO DETECT:

The Gate time LED will “FLASH” when input signal is detected and synchronized and will be “OFF” without input signal or if trigger level was incorrectly set.

AUTO RESET:

After input signal was disconnected the Counter Display will hold frequency reading for 10 sec. only before performing auto reset.

DISPLASY RESOLUTION:

Auto select from 0.001Hz to 1KHz depending on the frequency.

MAX COUNTER RANGE:

0.1Hz to 50MHZ

MAXIMUM EXTERNAL VOLTAGE

300V dc + ac peak

ACCURACY:

+0.01% + 1 digit or 1/99999 +1 digit

Time Base:

18,432MHz + 10ppm (23°C±5°C)

SENSITIVITY:

NOTE:

1. The Counter must be set at "DC COUPLING" operation then the input signal is less than 10Hz.
2. The counter is operated by the "Trigger Source" CH1, CH2, or EXT.

NOTE: *If input signal is not synchronized correctly on CRT display Frequency counter may have incorrect measurements.*

To check power line frequency with the 2121C set Trigger SOURCE switch to LINE position. There is no manual synchronization necessary in this mode, Counter will show Line frequency automatically.

To activate the dedicated frequency counter input, separate from Oscilloscope cannels, set Time /Div switch to any range under red $FREQ. \geq 100KHz$ label. Set SOURCE switch to EXT position. Now 2121C is set to Universal counter mode. Use the Trigger Level knob to select correct Counter trigger level. Flashing red LED on the top left corner of counter display is indicating the correct trigger level is set.

NOTE: *If trigger level is not set correctly on and red Led is not ON or flash Frequency counter may have incorrect measurements.*

MODE	RANGE	SENSITIVITY
INT	2Hz~40MHz	$\geq 1Div$
	1Hz~45MHz	$\geq 2Div$
	0.2Hz~50MHz	$\geq 3Div$
EXT	10Hz~50MHz	$\geq 200mVrms$
	1Hz~50MHz	$\geq 400mVrms$

2121 Internal Frequency Counter operating instructions.

The signal from both Oscilloscope channels (CH1 and CH2.) could be used for frequency measurements input.

Set VERT and SOURCE switches to selected channel and synchronize measured signal on CRT display. Counter will auto sense and register signal frequency on the counter red digital display. Flashing red dote in top left corner of the first digit is Gate indicator. It is light up every time during frequency counter is update.

SERVICE INFORMATION

Warranty Service: Please go to the support and service section on our website www.bkprecision.com to obtain an RMA #. Return the product in the original packaging with proof of purchase to the address below. Clearly state on the RMA the performance problem and return any leads, probes, connectors and accessories that you are using with the device.

Non-Warranty Service: Please go to the support and service section on our website www.bkprecision.com to obtain an RMA #. Return the product in the original packaging to the address below. Clearly state on the RMA the performance problem and return any leads, probes, connectors and accessories that you are using with the device. Customers not on an open account must include payment in the form of a money order or credit card. For the most current repair charges please refer to the service and support section on our website.

Return all merchandise to B&K Precision Corp. with pre-paid shipping. The flat-rate repair charge for Non-Warranty Service does not include return shipping. Return shipping to locations in North America is included for Warranty Service. For overnight shipments and non-North American shipping fees please contact B&K Precision Corp.

B&K Precision Corp.
22820 Savi Ranch Parkway
Yorba Linda, CA 92887
www.bkprecision.com
714-921-9095

Include with the returned instrument your complete return shipping address, contact name, phone number and description of problem.

LIMITED ONE-YEAR WARRANTY

B&K Precision Corp. warrants to the original purchaser that its products and the component parts thereof, will be free from defects in workmanship and materials for a period of **one year** from date of purchase.

B&K Precision Corp. will, without charge, repair or replace, at its option, defective product or component parts. Returned product must be accompanied by proof of the purchase date in the form of a sales receipt.

To help us better serve you, please complete the warranty registration for your new instrument via our website www.bkprecision.com

Exclusions: This warranty does not apply in the event of misuse or abuse of the product or as a result of unauthorized alterations or repairs. The warranty is void if the serial number is altered, defaced or removed.

B&K Precision Corp. shall not be liable for any consequential damages, including without limitation damages resulting from loss of use. Some states do not allow limitations of incidental or consequential damages. So the above limitation or exclusion may not apply to you.

This warranty gives you specific rights and you may have other rights, which vary from state-to-state.

B&K Precision Corp.
22820 Savi Ranch Parkway
Yorba Linda, CA 92887
www.bkprecision.com
714-921-9095

FREE

OSCILLOSCOPE APPLICATIONS INFORMATION

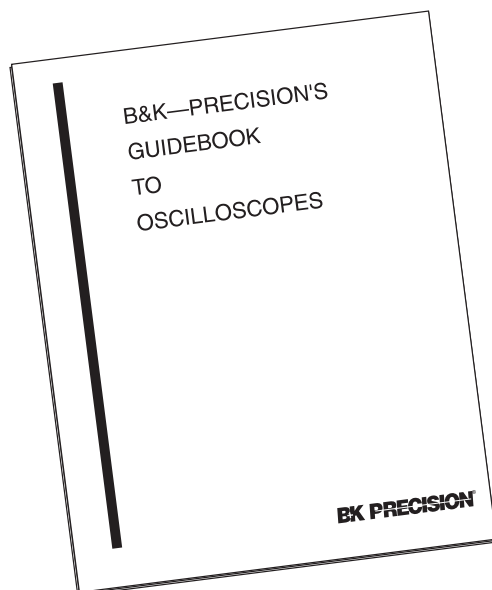

One of the best tutorials on oscilloscopes in the industry. Valuable to those with little knowledge of oscilloscopes as well as the experienced technician or engineer who wishes to refresh their memory or explore new uses for oscilloscopes.

CONTAINS:

- Numerous Application Examples Showing How To Gain The Most From Your Scope's Features And Capabilities.
- Proper Probe Selection And Use.
- Oscilloscope Terminology.
- Typical Scope Controls And Their Usage.
- Scope Theory Of Operation.

Download your FREE copy
from our Web site
www.bkprecision.com

BK PRECISION[®]

22820 Savi Ranch Parkway, Yorba Linda, CA 92887

©2013 B+K Precision Corp.

481-312-9-002C

Printed in Taiwan