

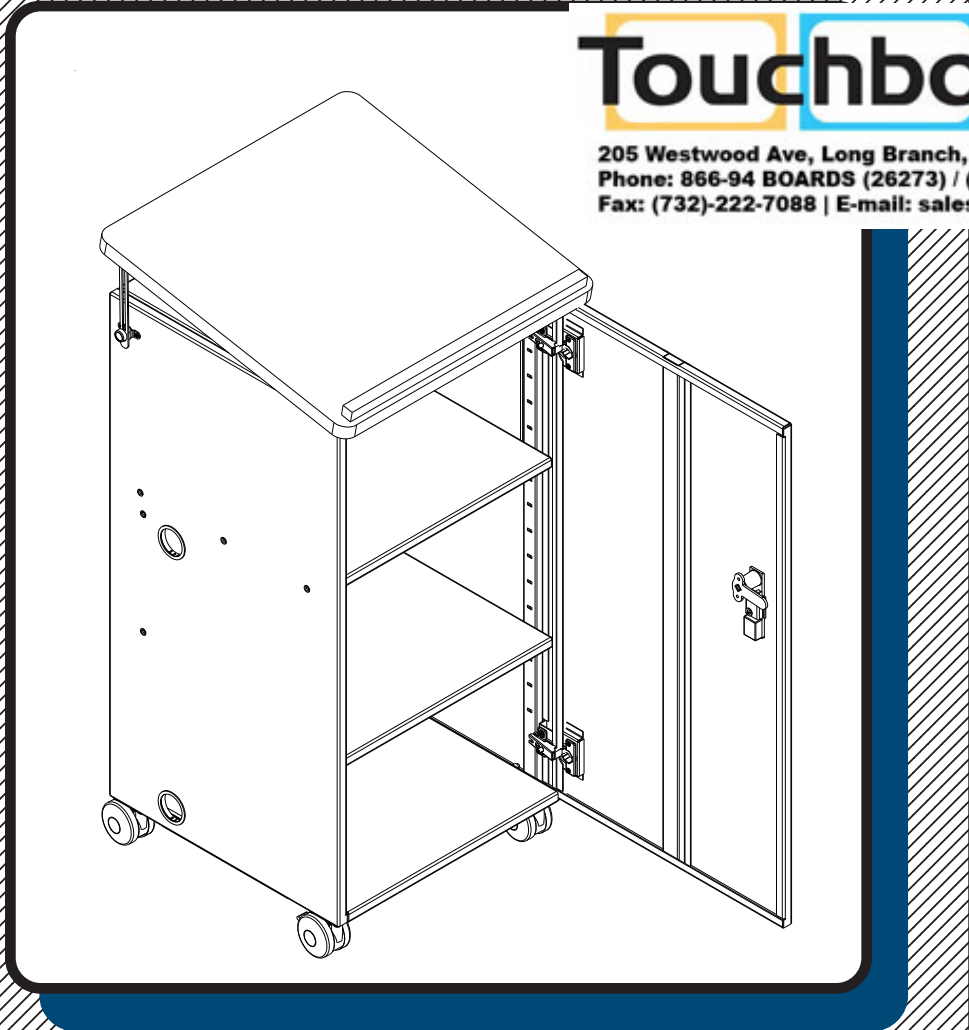

#27537

# Lecture Station with Locking Cabinet











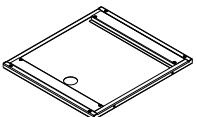

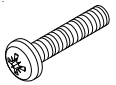

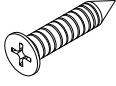
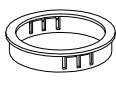

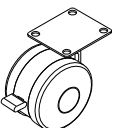
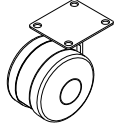



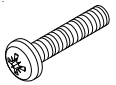

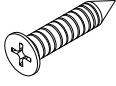
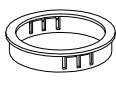

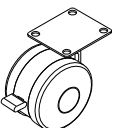
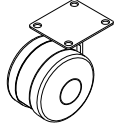



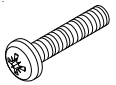

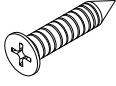
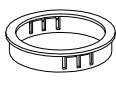
**Touchboards**

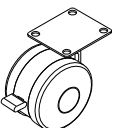
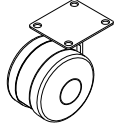
205 Westwood Ave, Long Branch, NJ 07740  
Phone: 866-94 BOARDS (26273) / (732)-222-1511  
Fax: (732)-222-7088 | E-mail: [sales@touchboards.com](mailto:sales@touchboards.com)

## Assembly Instructions

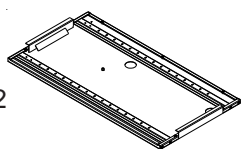
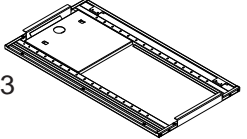
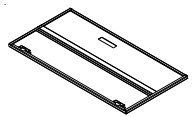
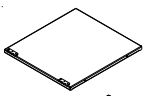
# #27537 Lecture Station

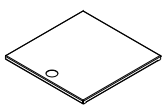
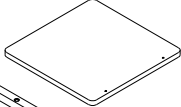
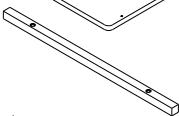
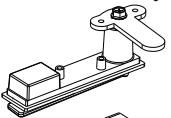
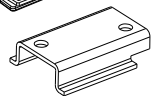
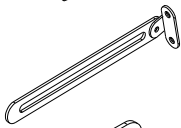
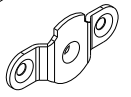
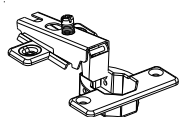
Part	Drawing	Description	Qty	Part	Drawing	Description	Qty																																																
P-1		Bottom Panel	1 EA	<h3 style="text-align: center;">Hardware List</h3> <table style="width: 100%; border-collapse: collapse;"> <tr> <td style="width: 5%;">A1</td> <td style="width: 10%;"></td> <td style="width: 75%;">Phil Pan Screw M6x12mm</td> <td style="width: 10%;">30 EA</td> </tr> <tr> <td>A2</td> <td></td> <td>Phil Pan Screw M6x38mm</td> <td>2 EA</td> </tr> <tr> <td>A3</td> <td></td> <td>Phil Brass Screw M5X19mm</td> <td>2 EA</td> </tr> <tr> <td>A4</td> <td></td> <td>CS Phil Pan Screw M5x12mm</td> <td>12 EA</td> </tr> <tr> <td>A5</td> <td></td> <td>CS Screw M4X25mm</td> <td>8 EA</td> </tr> <tr> <td>B</td> <td></td> <td>Plastic Grommet Sleeve</td> <td>5 EA</td> </tr> <tr> <td>C</td> <td></td> <td>Shelf bracket</td> <td>8 EA</td> </tr> <tr> <td>D</td> <td></td> <td>3" Locking Caster</td> <td>2 EA</td> </tr> <tr> <td>E</td> <td></td> <td>3" Caster</td> <td>2 EA</td> </tr> <tr> <td>F</td> <td></td> <td>Knob</td> <td>2 EA</td> </tr> <tr> <td>G</td> <td></td> <td>Lock Washer</td> <td>2 EA</td> </tr> <tr> <td>H</td> <td></td> <td>Caster Wrench</td> <td>1 EA</td> </tr> </table>				A1		Phil Pan Screw M6x12mm	30 EA	A2		Phil Pan Screw M6x38mm	2 EA	A3		Phil Brass Screw M5X19mm	2 EA	A4		CS Phil Pan Screw M5x12mm	12 EA	A5		CS Screw M4X25mm	8 EA	B		Plastic Grommet Sleeve	5 EA	C		Shelf bracket	8 EA	D		3" Locking Caster	2 EA	E		3" Caster	2 EA	F		Knob	2 EA	G		Lock Washer	2 EA	H		Caster Wrench	1 EA
A1		Phil Pan Screw M6x12mm	30 EA																																																				
A2		Phil Pan Screw M6x38mm	2 EA																																																				
A3		Phil Brass Screw M5X19mm	2 EA																																																				
A4		CS Phil Pan Screw M5x12mm	12 EA																																																				
A5		CS Screw M4X25mm	8 EA																																																				
B		Plastic Grommet Sleeve	5 EA																																																				
C		Shelf bracket	8 EA																																																				
D		3" Locking Caster	2 EA																																																				
E		3" Caster	2 EA																																																				
F		Knob	2 EA																																																				
G		Lock Washer	2 EA																																																				
H		Caster Wrench	1 EA																																																				
P-2		Left Side	1 EA																																																				
P-3		Right Side	1 EA																																																				
P-4		Door	1 EA																																																				
P-5		Metal Top w/Hinges	1 EA																																																				
P-6		Back Panel	1 EA																																																				
P-7		Removeable Shelf	2 EA																																																				
P-8		Wood Top	1 EA																																																				
P-9		Book Stop	1 EA																																																				
P-10		Door Lock	1 EA																																																				
P-11		Lock Bracket	1 EA																																																				
P-12		Lid Support	2 EA																																																				
P-13		Lid Support Bracket	2 EA																																																				
P-14		Hinge	2 EA																																																				

# #27537 Lecture Station Assembly Diagram



**READ THROUGH INSTRUCTIONS FROM BEGINNING TO END BEFORE STARTING TO ASSEMBLE UNIT.**

1.) Identify and Separate all the Parts and Hardware.

**Illustration # 1**

2.) Attach Metal Top w/Hinges (P-5) to the Wood Top (P-8) using 4 screws (A5) as shown in illustration #1.

3.) Attach 2 Lid Supports (P-12) to the Wood Top (P-8) using 4 screws (A5).

4.) Attach Book Stop (P-9) to the Wood Top (P-8) using 2 screws (A2).

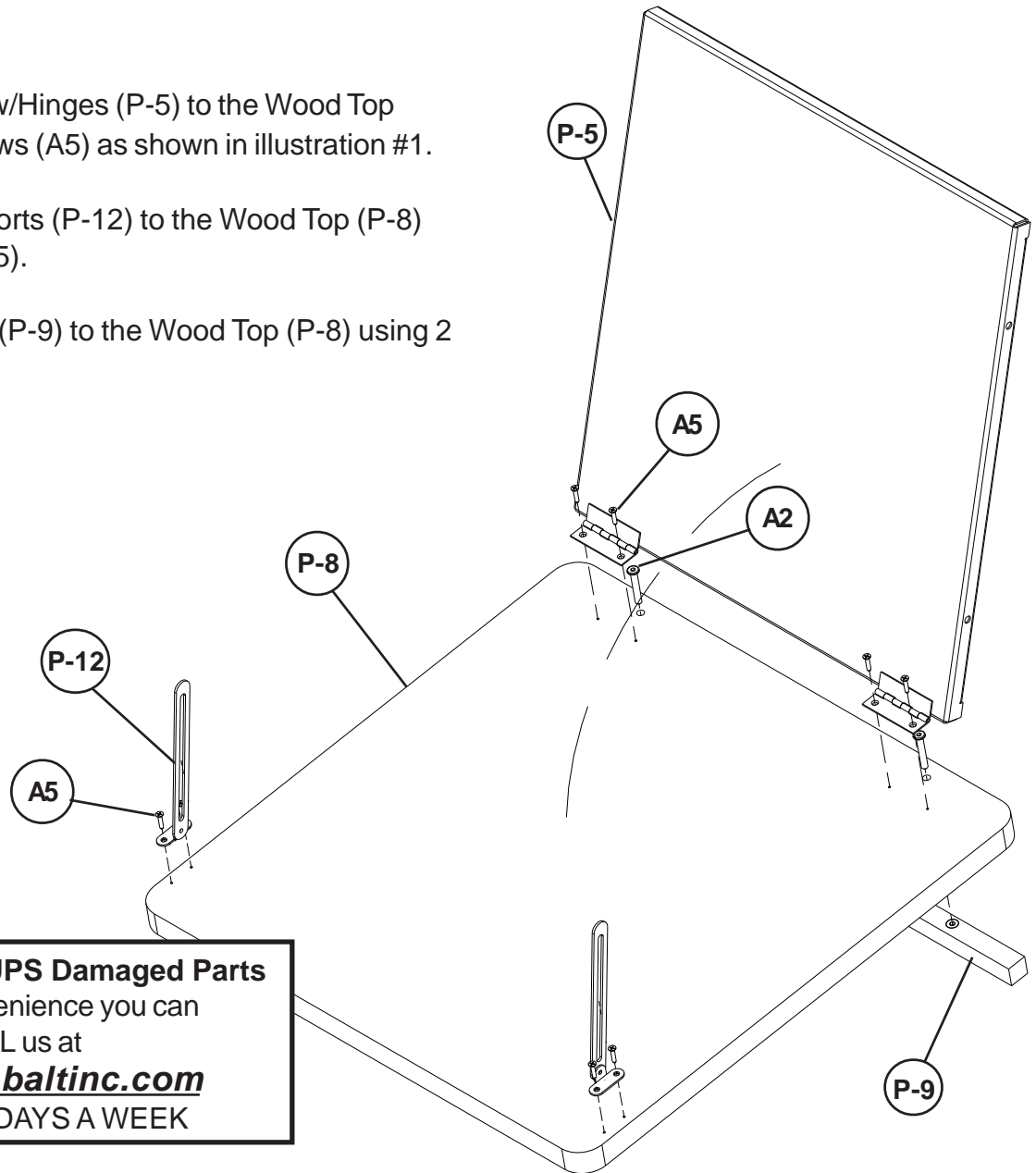

### **Missing Parts or UPS Damaged Parts**

For Your Convenience you can  
EMAIL us at

**[furniture@baltinc.com](mailto:furniture@baltinc.com)**

**24HOURS 7 DAYS A WEEK**

Do not use unless all screws are tight. At least every six months, check all screws to be sure they are tight. If parts are missing, broken, damaged, or worn, stop use of the product until repairs are made by your dealer using factory authorized parts.

5.) Attach Left Side (P-2) and Right Side (P-3) to the bottom panel (P1) and the Metal Top Panel (P5) using 8 screws (A1) as shown in illustration # 2.

Illustration # 2

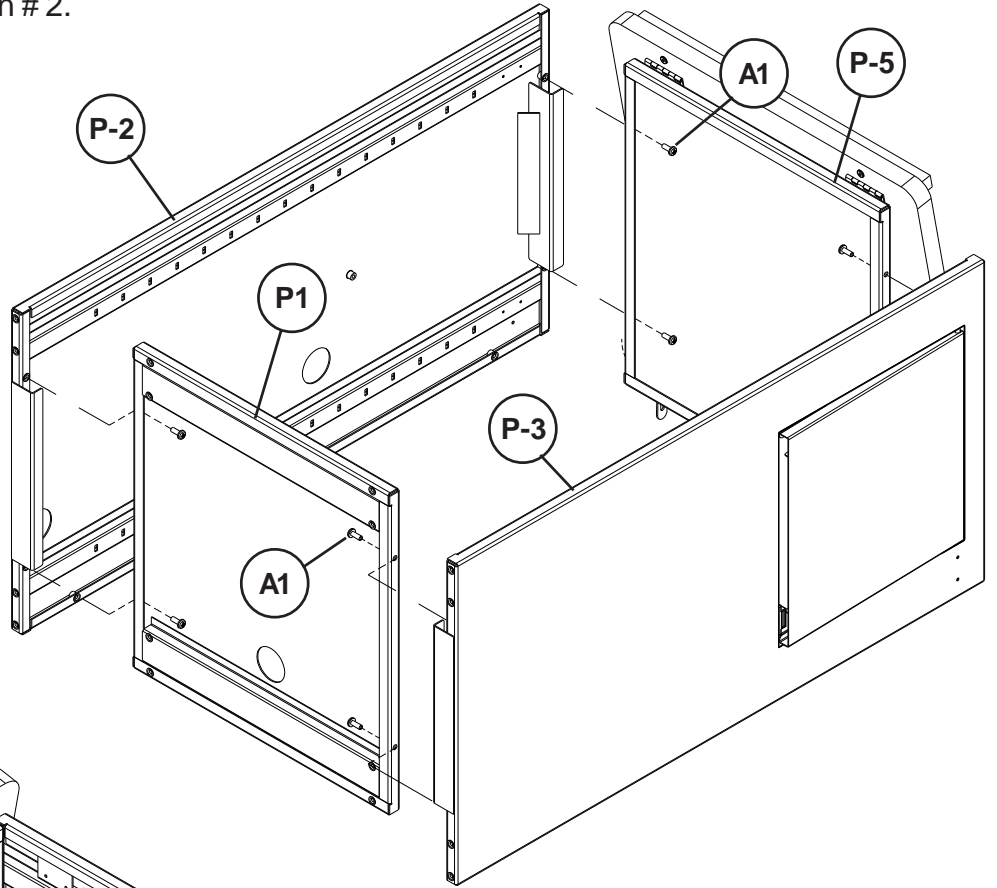

6.) Attach back Panel (P-6) to Left Side (P-2) and Right Side (P-3) using 6 screws (A1) as shown in illustration # 3.

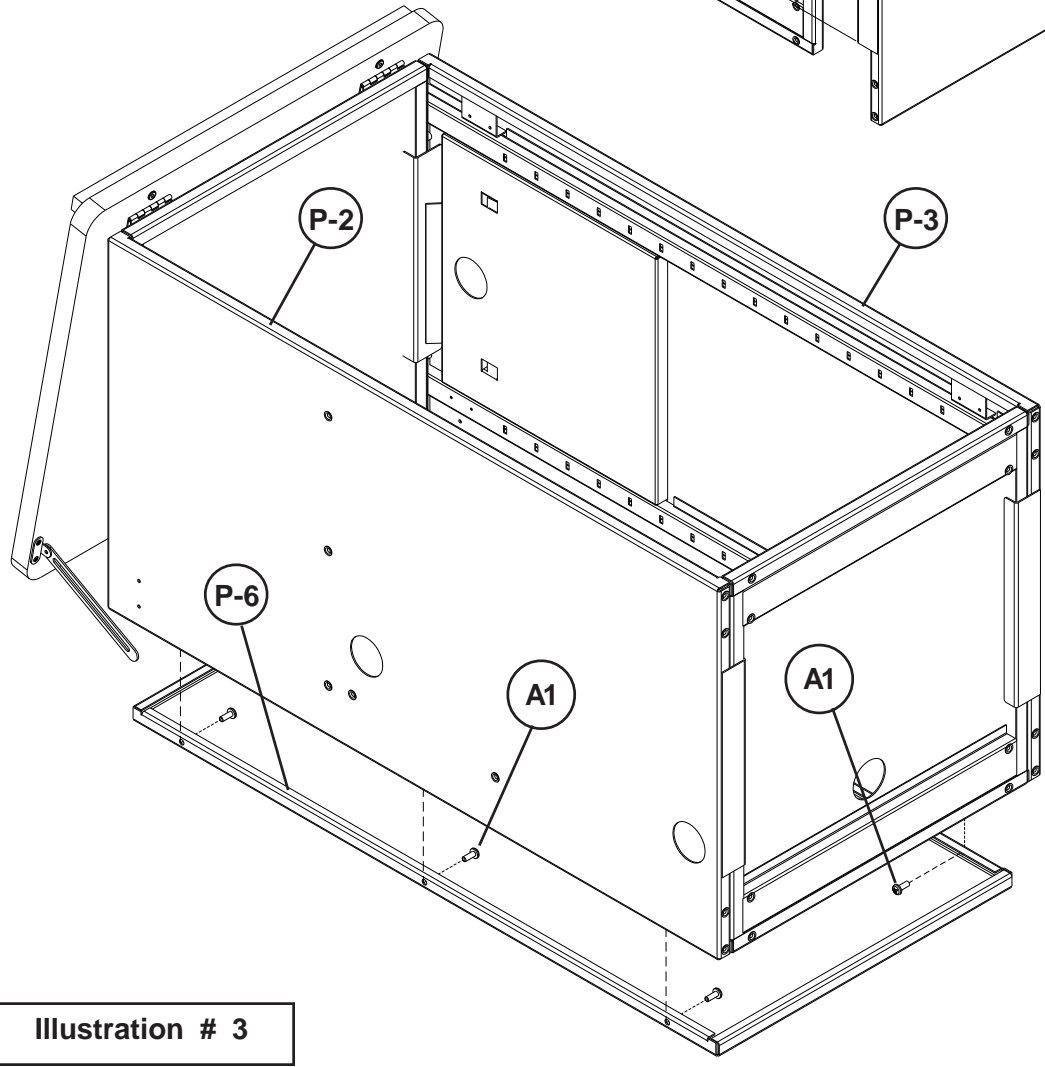
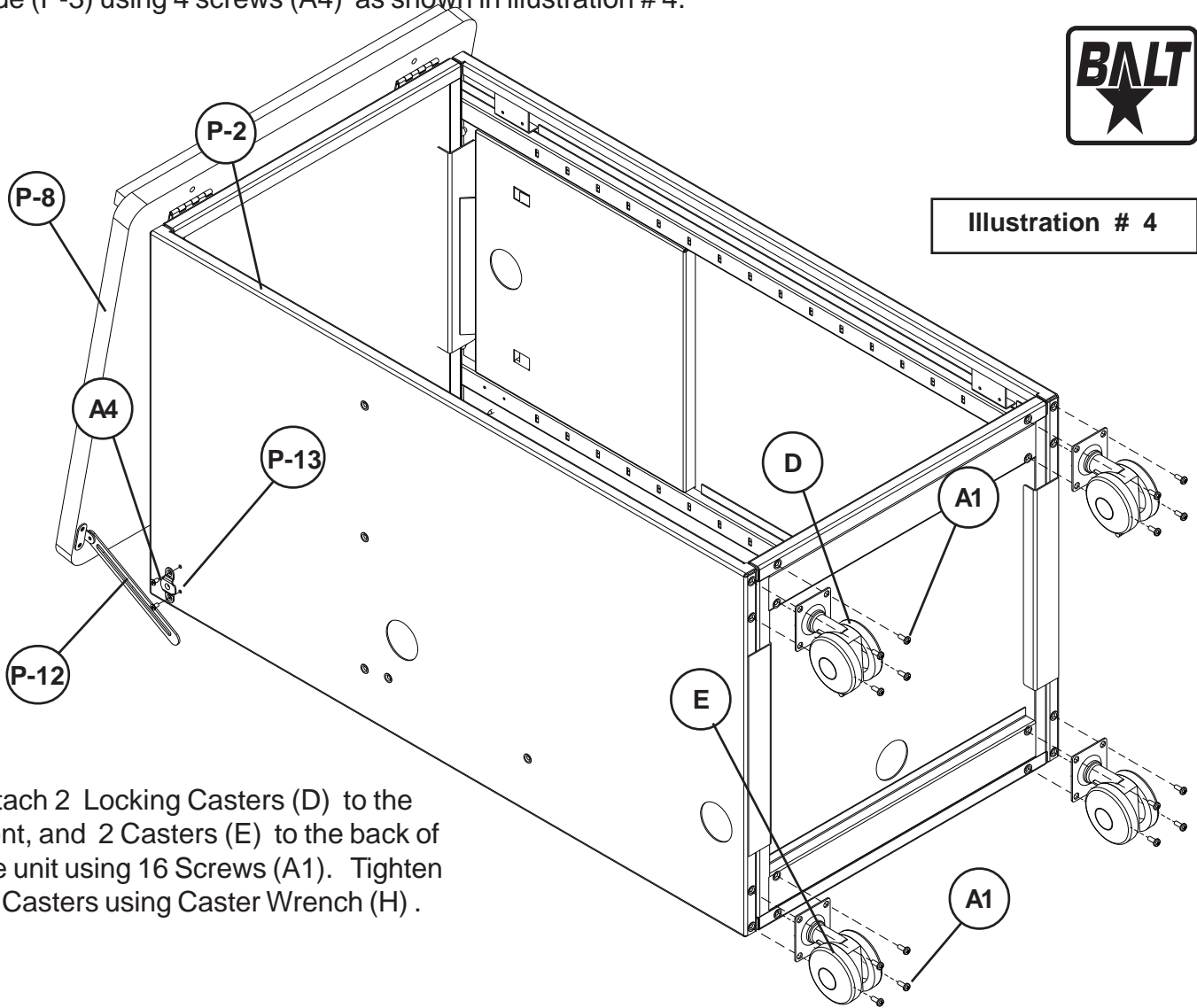

Illustration # 3

- 7.) Attach 1 Lid Support Bracket (P-13) to Left Side (P-2) and 1 Lid Support Bracket (P-13) to Right Side (P-3) using 4 screws (A4) as shown in illustration # 4.



Illustration # 4



- 8.) Attach 2 Locking Casters (D) to the front, and 2 Casters (E) to the back of the unit using 16 Screws (A1). Tighten all Casters using Caster Wrench (H) .

- 9.) Attach 2 Hinges (P-14) to the Door (P-4) using 4 screws (A4) as shown in illustration # 5.

- 10.) Attach Door Lock (P-10) to the Door (P-4) using 1 Lock Bracket (P-11) and 2 screws (A3) as shown in illustration # 5.

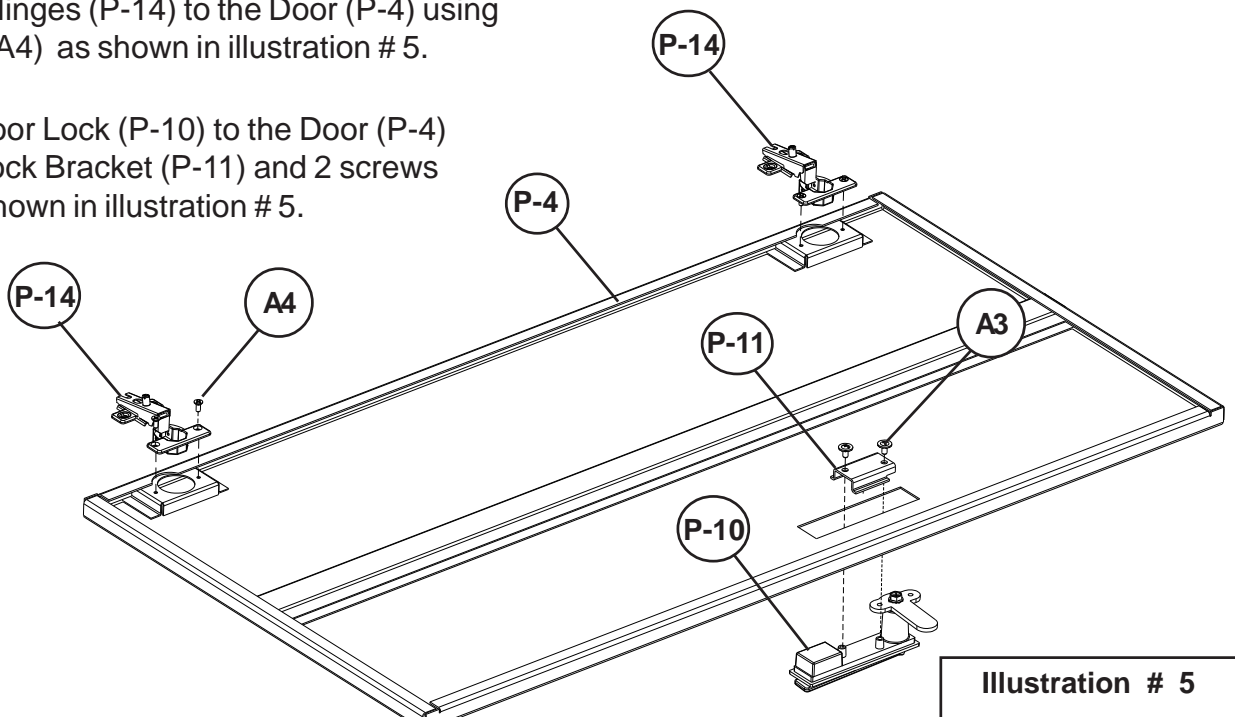

Illustration # 5

11.) Secure 2 Lid Supports (P-12) to the Left and Right Sides (P-2 & P-3) using 2 Lock Washers (G), and 2 Knobs (F) as shown in illustration # 6.

Illustration # 6

12.) Attach 2 Hinges (P-14) to the Right Side (P-1) using 4 screws (A4) as shown in illustration # 6.

13.) Insert the 8 Shelf Brackets (C) into the holes in the Left and Right Sides (P-2 & P-3) as shown in illustration #6.

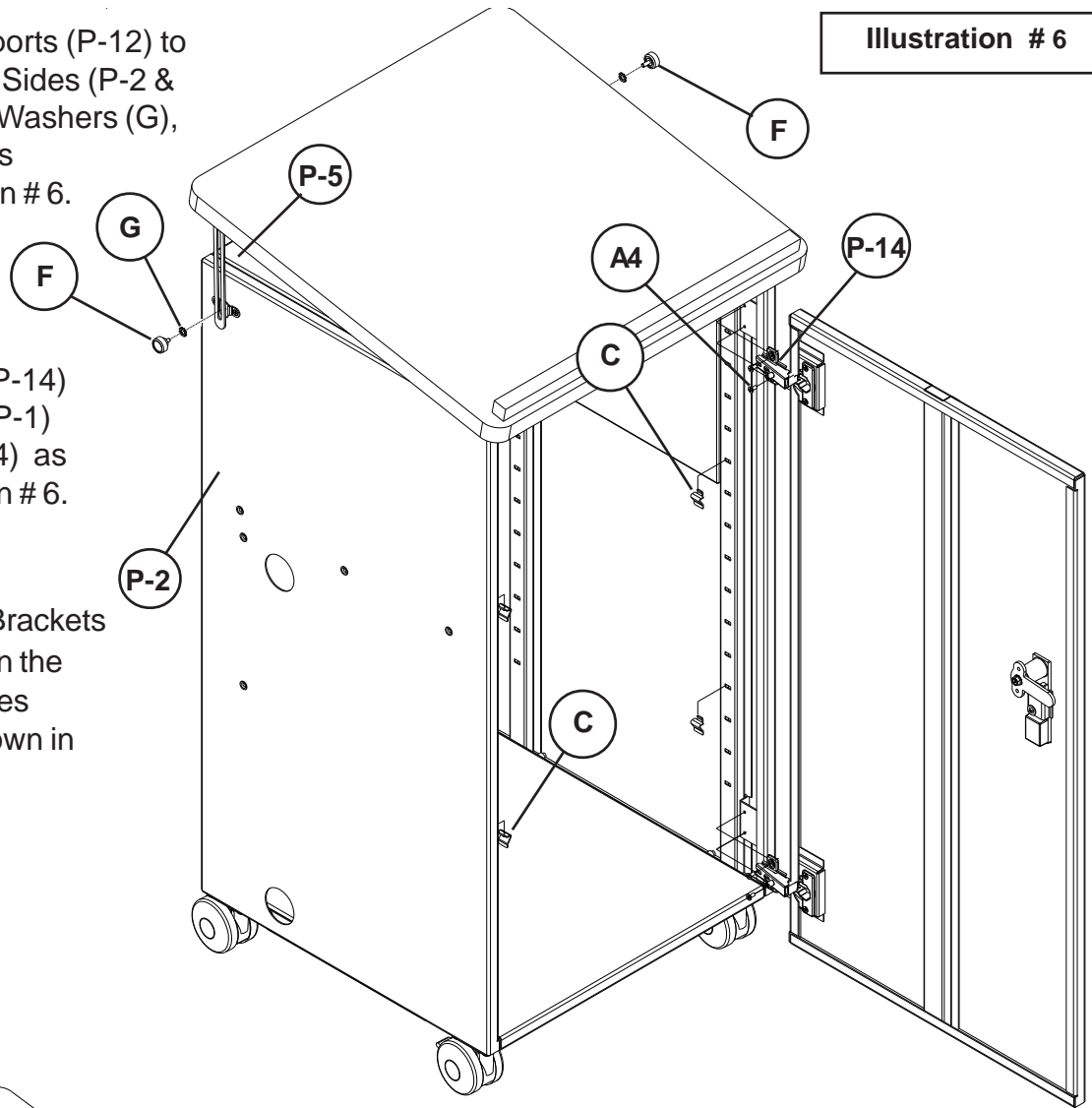
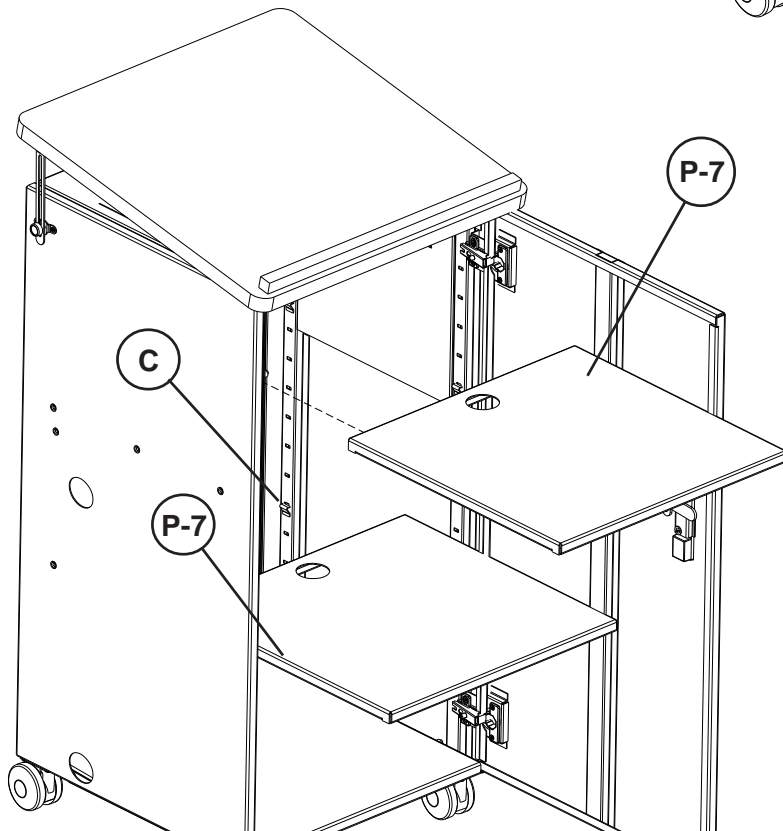

Illustration # 7

14.) Place 2 Removeable Shelves (P-7) onto the 8 Shelf Brackets (C) as shown in illustration #7.



*Should you require assistance during assembly,  
please call our Customer Service  
Department Monday - Friday  
8 a.m. - 5 p.m.  
Central Standard Time  
1-800-749-2258*

15.) Press Grommet Sleeves (B) in Round openings in Removeable Shelves (P-7), Bottom Panel (P-1), Left Side (P-2), and Right Side (P-3) as shown in illustration #8.

Illustration # 8



205 Westwood Ave, Long Branch, NJ 07740  
Phone: 866-94 BOARDS (26273) / (732)-222-1511  
Fax: (732)-222-7088 | E-mail: sales@touchboards.com

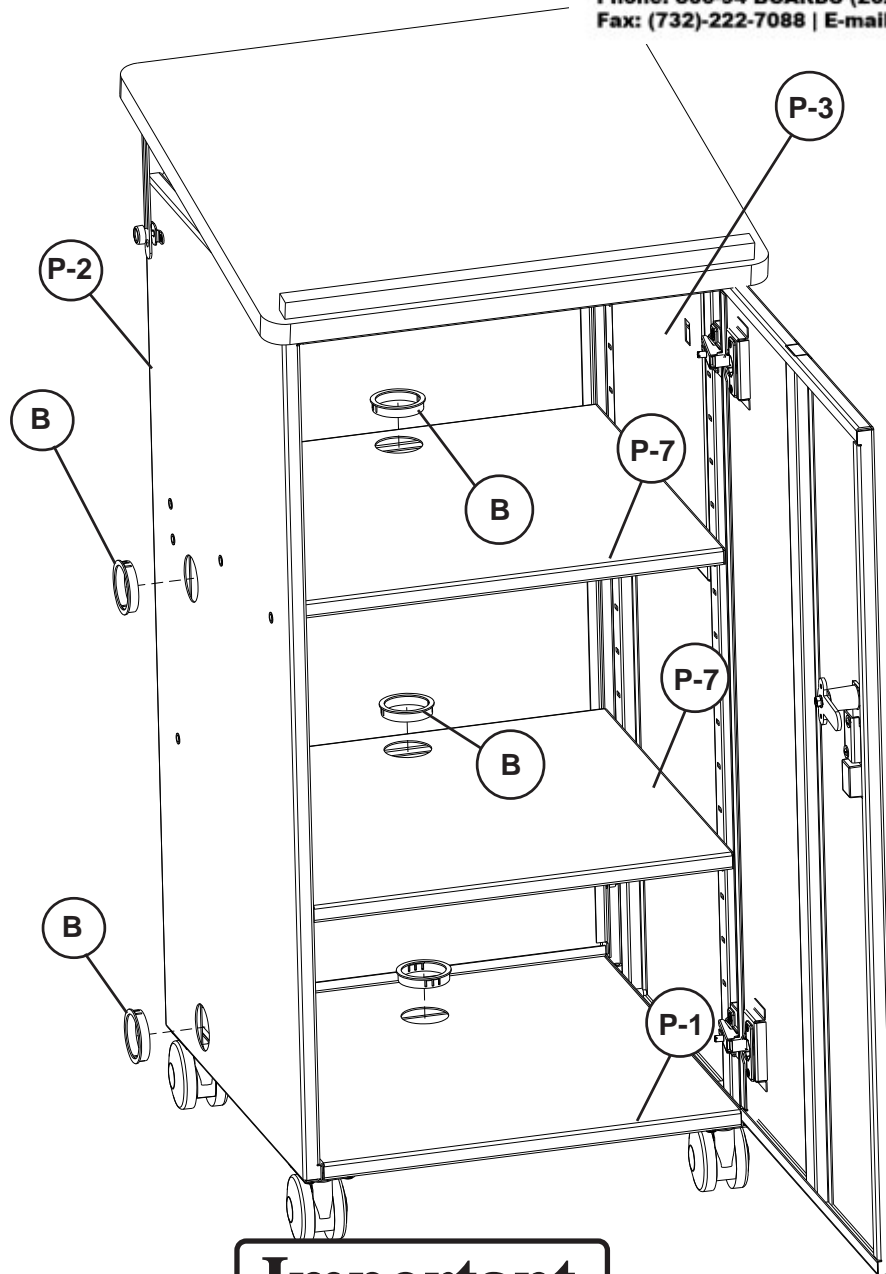

## Important

The Balt product you have purchased is guaranteed against material and workmanship defects. This guarantee extends 1 year from date of purchase. Should this product fail to function satisfactorily under normal use due to defect or imperfection, the defective part or product will be replaced. Damage caused by common carriers during shipment is not included in this guarantee.

**This guarantee sets forth all applicable guarantees and remedies. No other warranty, expressed or implied shall apply. Failure to follow instructions found in Important Information Section of Owner Sheet shall void the guarantee. Consequential or incidental damages and or costs are not refundable.**