

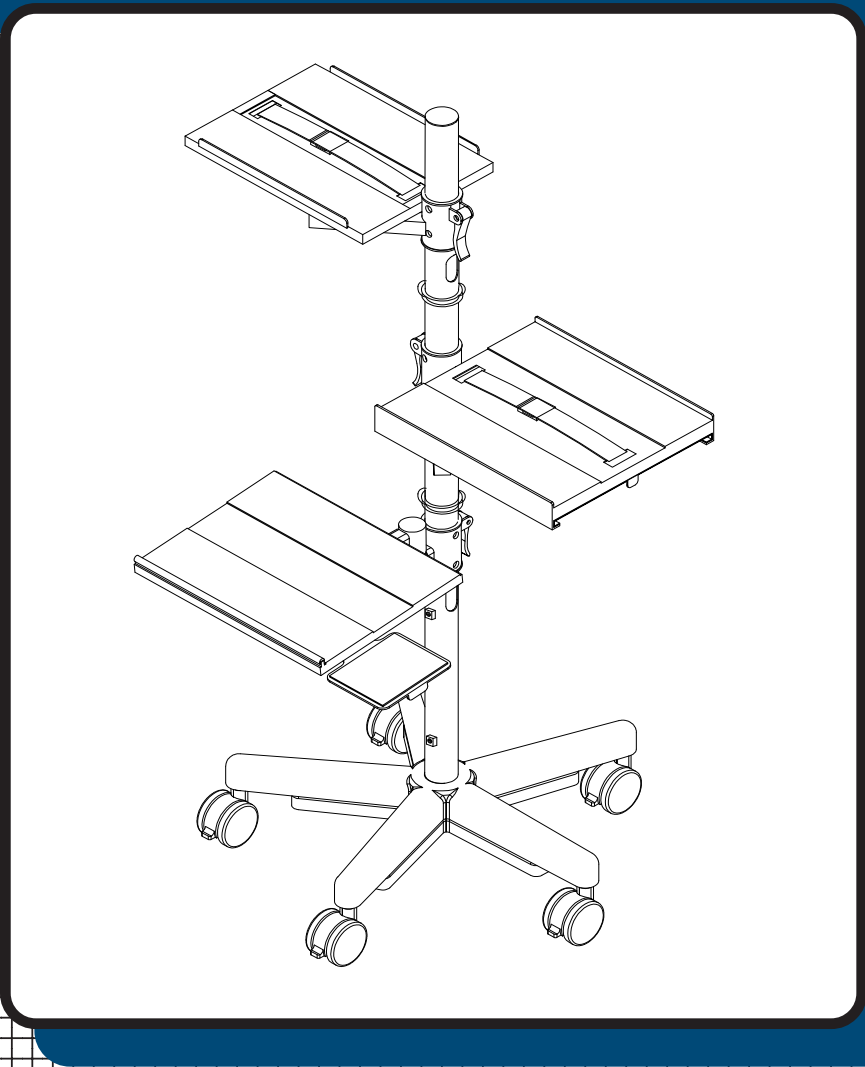









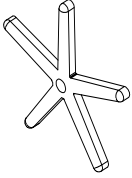



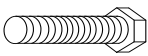







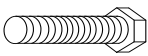





#27588 Alpha Cart

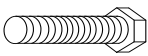

Assembly Instructions

#27588 Alpha Cart

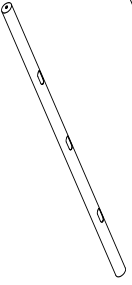
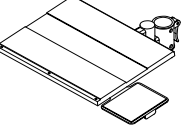
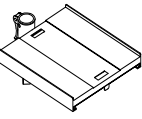
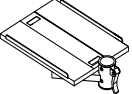
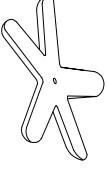
Part	Drawing	Description	Qty	Part	Drawing	Description	Qty																																				
P1		Base	1 EA	<div style="border: 1px solid black; padding: 10px;"> <h3 style="text-align: center;">Hardware List</h3> <table border="0"> <tr> <td>A</td> <td></td> <td>3" Locking Caster</td> <td>5 EA</td> </tr> <tr> <td>B</td> <td></td> <td>Wrench</td> <td>1 EA</td> </tr> <tr> <td>C</td> <td></td> <td>Allen Wrench</td> <td>1 EA</td> </tr> <tr> <td>D</td> <td></td> <td>Hex Bolt</td> <td>1 EA</td> </tr> <tr> <td>E</td> <td></td> <td>Straps</td> <td>2 EA</td> </tr> <tr> <td>F</td> <td></td> <td>Cable Ties</td> <td>3 EA</td> </tr> <tr> <td>G</td> <td></td> <td>Book Stop Phillips Screw</td> <td>3 EA</td> </tr> <tr> <td>H</td> <td></td> <td>Book Stop</td> <td>1 EA</td> </tr> <tr> <td>I</td> <td></td> <td>Electric Strip Screws (Optional)</td> <td>2 EA</td> </tr> </table> </div>				A		3" Locking Caster	5 EA	B		Wrench	1 EA	C		Allen Wrench	1 EA	D		Hex Bolt	1 EA	E		Straps	2 EA	F		Cable Ties	3 EA	G		Book Stop Phillips Screw	3 EA	H		Book Stop	1 EA	I		Electric Strip Screws (Optional)	2 EA
A		3" Locking Caster	5 EA																																								
B		Wrench	1 EA																																								
C		Allen Wrench	1 EA																																								
D		Hex Bolt	1 EA																																								
E		Straps	2 EA																																								
F		Cable Ties	3 EA																																								
G		Book Stop Phillips Screw	3 EA																																								
H		Book Stop	1 EA																																								
I		Electric Strip Screws (Optional)	2 EA																																								
P2		Pole	1 EA																																								
P3		Main Platform	1 EA																																								
P4		Side Platform & Pull Out Shelf	1 EA																																								
P5		Side Platform	1 EA																																								
P6		Base Weight	1 EA																																								

Missing Parts or UPS Damaged Parts
 For Your Convenience you can
 EMAIL us at
support@moorecoinc.com
 24HOURS 7 DAYS A WEEK

**Should you require assistance during assembly,
 please call our Customer Service Department
 Monday - Friday 8 a.m. - 5 p.m.
 Central Standard Time 1-800-749-2258**

#27588

Assembly Diagram

READ THROUGH INSTRUCTIONS FROM BEGINNING TO END BEFORE STARTING TO ASSEMBLE UNIT.

- 1.) Identify and Separate all the Parts and Hardware.
- 2.) Push in five Casters (A) into the bottom of the Base (P1) as shown in Illustration # 1.

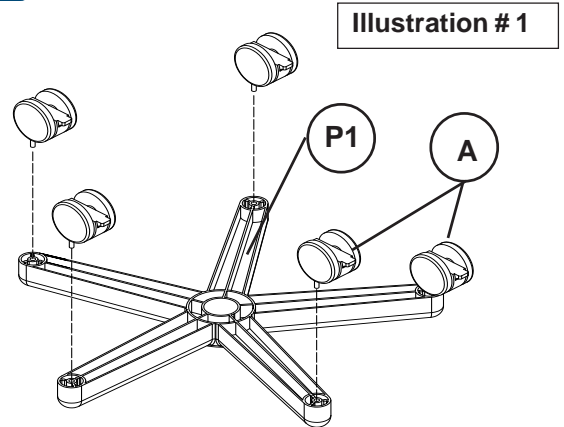

- 3.) Insert the Pole (P2) into the Base (P1). Make sure you place the end of the Pole that has the threaded insert into the Base. Place the Base Weight (P6) under the Base (P1) and attach to the Pole (P2) using one Hex Head Bolt (D). (See Illustration #2) Tighten the Hex Head Bolt using the Wrench (B).

Illustration # 2

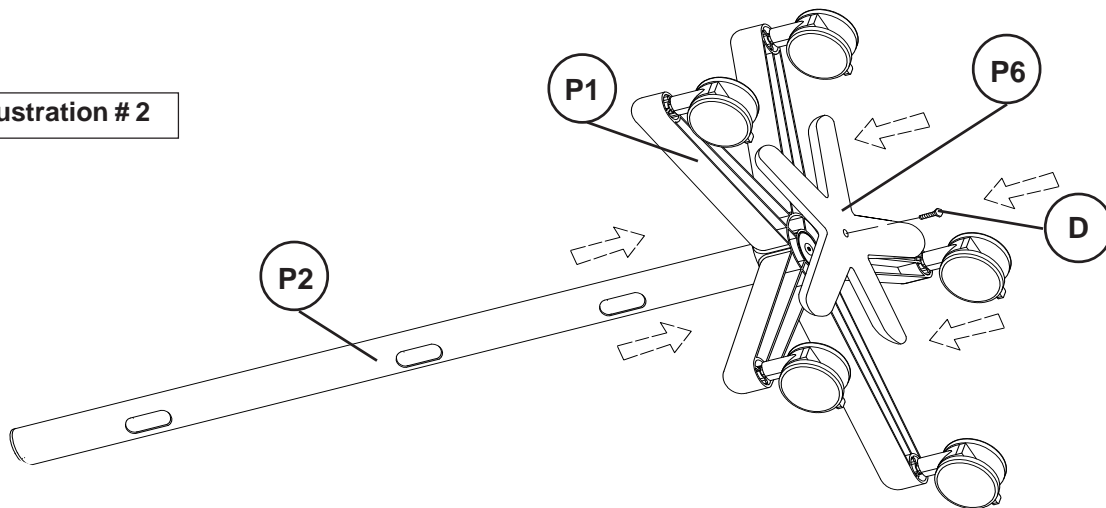

Do not use unless all screws are tight. At least every six months, check all screws to be sure they are tight. If parts are missing, broken, damaged, or worn, stop use of the product until repairs are made by your dealer using factory authorized parts.

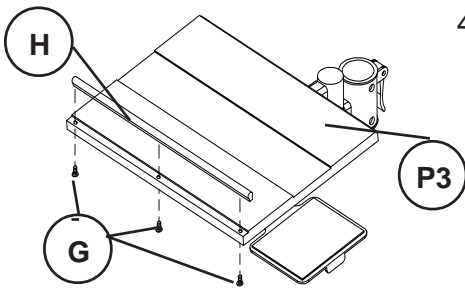

4.) Attach the Book Stop (H) to the top front edge of the Main Platform (P3) using three Book Stop Screws (G) from underneath as shown in illustration #3.

Illustration # 3

5.) Insert the Main Platform (P3) onto the Pole (P2) and slide it down to the desired position. Tighten in place by clamping down the lock lever as shown in Illustration #4.

6.) Insert the Side Platform & Pull Out Shelf (P4) onto the Pole (P2) and slide down to the desired position. Tighten in place by clamping down the lock lever. See illustration #4.

7.) Insert the Side Platform (P5) onto the Pole (P2) and slide down to the desired position. Tighten in place by clamping down the lock lever. See illustration #4.

8.) Use the Straps (E) through the slots in the Side Platform (P5) and the Side Platform & Pull Out Shelf (P4) to secure your equipment in place. (See Illustration #5)

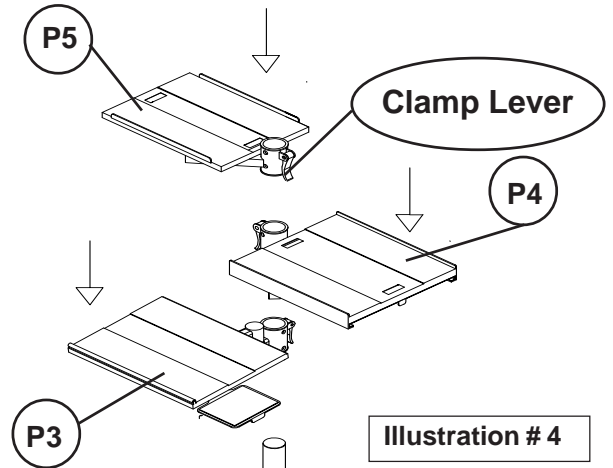

Illustration # 4

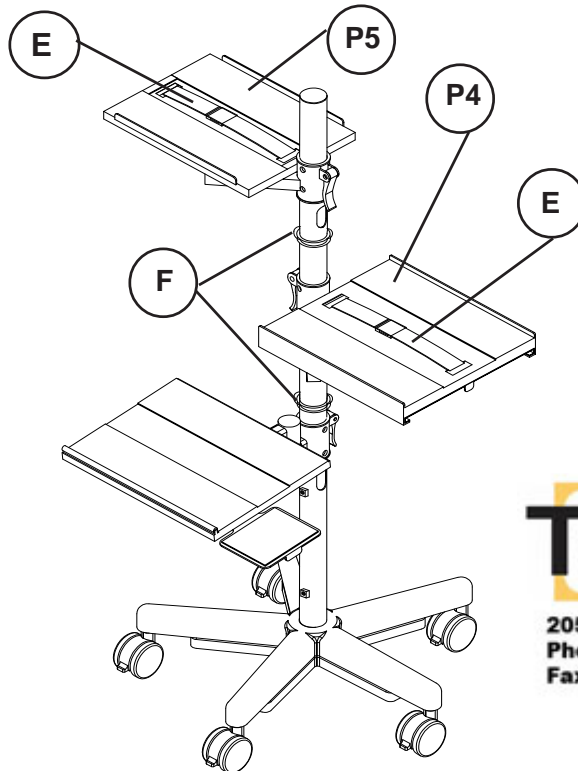

Illustration # 5

9.) Snap-on three Cable Ties (F) onto the Pole (P2) to help with wire management as shown in illustration #5.



205 Westwood Ave, Long Branch, NJ 07740
 Phone: 866-94 BOARDS (26273) / (732)-222-1511
 Fax: (732)-222-7088 | E-mail: sales@touchboards.com