

Manufacturers Warranty

Our lectern undergoes the most rigid and exacting tests for superior quality and performance before leaving the factory. Our lectern is made in America by American craftsmen. Oklahoma Sound Corporation warrants this product to be free from defective material and workmanship for two years from the date of resale by an authorized Oklahoma Sound distributor. Oklahoma Sound will replace defective parts and repair malfunctioning products under this warranty when the defect occurs under normal installation and use, provided the unit is returned to our factory via prepaid transportation after direct authorization and approval by Oklahoma Sound. This warranty provides that examination of the returned product must disclose in our judgement, a manufacturing defect. This warranty does not extend to any product which has been subject to misuse, neglect, accident, improper installation, or where the serial number has been removed or defected and is given in lieu of any other warranty implied or expressed and will not cover any consequential damages.

**ARISTOCRAT
Full Floor Lectern**

ASSEMBLY MANUAL



205 Westwood Ave, Long Branch, NJ 07740
Phone: 866-94 BOARDS (26273) / (732)-222-1511
Fax: (732)-222-7088 | E-mail: sales@touchboards.com

OKLAHOMA SOUND CORP.

149 Entin Road, Clifton, NJ 07014

Tel 973-594-9000 • Fax 973-594-9339

www.oklahomasound.com • email: info@oklahomasound.com

MODEL #600

INTRODUCTION

Aristocrat Contour Floor lectern - Model 600

A perfect lectern for the most demanding, upscale look. Contoured style with radius curves. Available in four woodgrain thermofused melamine laminate on ¾" flake-board. Two built in shelves and side mounted slide-out shelf for A/V presentation equipment. Accented by attractive T-Mold edging. Moves effortlessly on four easy roll castors, two locking. Ready to assemble.

Colors: Walnut, Light Oak, Med. Oak, Mahogany/Black Edge

Dimensions: 25¼" W x 46" H x 20¼" D.

ASSEMBLY TIPS

- Read the instructions carefully and follow diagrams to ensure an easy and correct assembly
- Do not use a sharp instrument such as a knife or a screwdriver to open the packaging, as this may scratch or possibly damage the unit.
- All assembly should be done on a clean protected surface such as carpet or the like.
- Make sure that you have all the required parts. A list of all the parts is included.

OPTIONAL / ADDITIONAL EQUIPMENT

BRASS READING LAMP / #BRL

Attach an elegant brushed brass reading lamp to the reading table of your new Speaker Stand. Not only will you shed light on the subject, but you will add pizzazz to your new stand.



13" GOOSENECK ASSEMBLY / #GSN

Choose from Black or Chrome colored 13" flexible gooseneck arm. includes mount with three screws.

ARISTOCRAT SOUND FLOOR LECTERN / #6010

Perfect for the smallest to largest venues. Executive style podium include 50 Watt Multimedia amplifier with two built in 8" speakers surrounded by gold appointments. Includes Microphones, Holders, Digital Timepiece and rolls on four casters. For audiences up to 2,500 people. Assembly required.

Dimensions: 25¼" W x 46" H x 20¼" D

Walnut, Lt. Oak, Med. Oak, Mahogany

ARISTOCRAT CONTOUR TABLE TOP LECTERN / #60

Move this attractive, affordable lectern from room to room and keep your notes in order and your audiences wowed. Made of thermofused laminate in four color selections with T-mold Edging. Protective non marring glides included Assembly required.

Dimensions: 25" W x 15" H x 20" D

Walnut, Lt. Oak, Med. Oak, Mahogany



5) Now apply Panel C to the semi assembled unit. Be sure to align the cam bolts to the holes on both Panel B and Panel E. Be sure that Panel F is securely in groove. Tighten cams. (Diagram D)

6) Screw the corner braces into Panel A and Panel B. There are pre-drilled holes to help guide you.

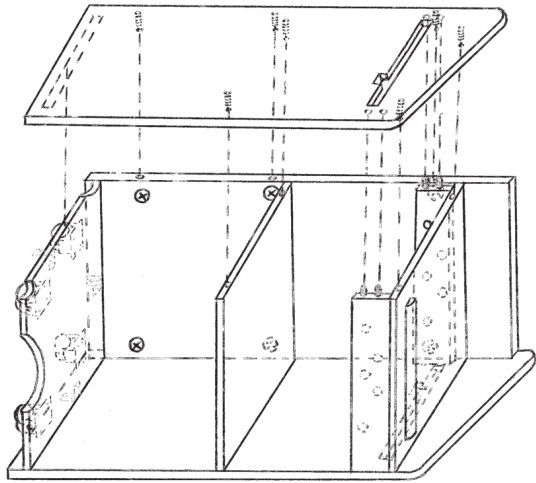

Diagram "D"

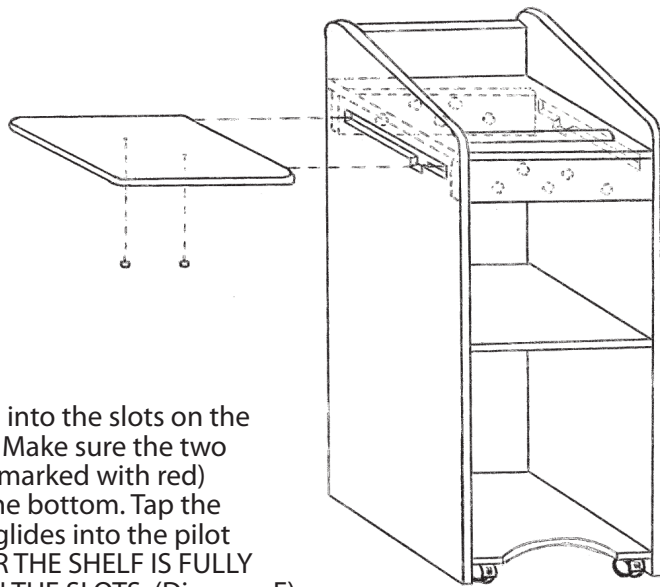

Diagram "E"

7) Slide Panel I into the slots on the side of unit. Make sure the two pilot holes (marked with red) are facing the bottom. Tap the two plastic glides into the pilot holes, AFTER THE SHELF IS FULLY INSERTED IN THE SLOTS. (Diagram E)

8) Once again go over all the cams and check to make sure the lectern is sturdy.

Congratulations! You have successfully assembled your lectern, which if cared for correctly should give you long and satisfactory usage.

ASSEMBLY PARTS

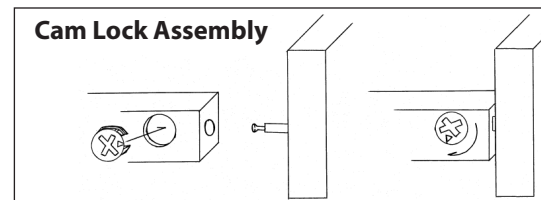
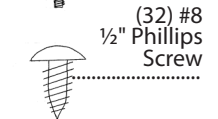
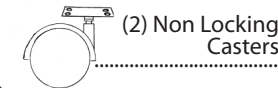
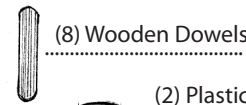
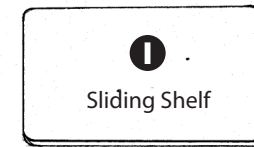
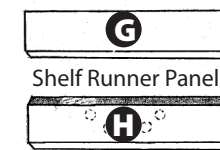
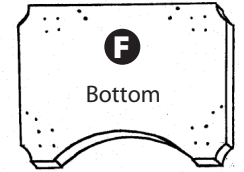
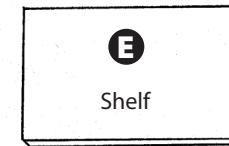
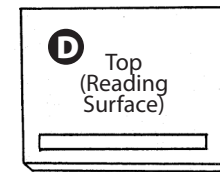
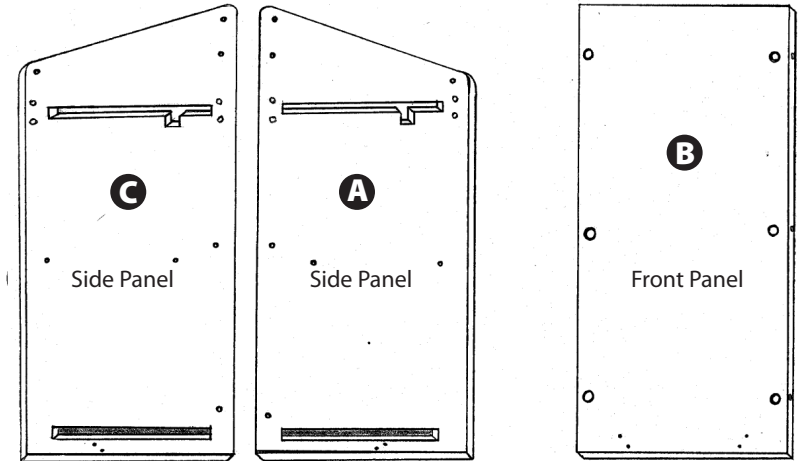

Tools Required
 #2 Phillips Head Screwdriver
 Hammer

INSTALLATION OF HARDWARE

- 1) Lay out the wood panels as shown in Diagram A (make sure the factory drilled holes are facing upwards). You can determine the top of the front panel by identifying the T molding edge.
- 2) Identify the holes numbered "1" in Diagram A. Screw the bolts into the predrilled holes with the #2 Phillips head screwdriver. Be sure to tighten the screws all the way. Be careful not to over-tighten the bolts as this will strip the wood!
- 3) Insert the cams in the larger holes as shown on diagram. **MAKE SURE THE ARROW ON THE CAM IS POINTING TO THE CLOSEST EDGE AND ALIGNED WITH THE HOLE ON THE EDGE.**
- 4) Insert the 8 wooden dowls into the holes of the edges on the 2 "SHELF RUNNER PANELS".
- 5) On the "BOTTOM" Panel F screw in the four casters. The locking casters should be screwed into the bottom closest to the shaped finished edge. The second pair of non-locking casters should be attached closest to the unfinished edge.
- 6) Screw in the corner brace to the side, there are pre-drilled holes to guide you. (Diagram B)

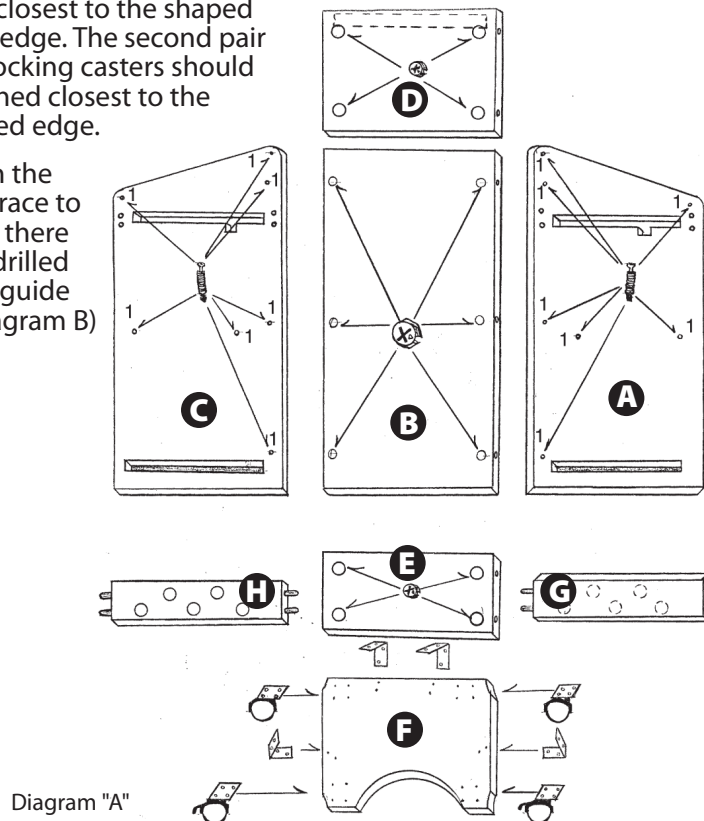

ASSEMBLY OF LECTERN

It is important that the instructions on the assembly are followed carefully

- 1) The first step of assembly will be to align the holes on the edge of panel edges with the three cam bolts on the side Panel A. Tighten the cams by turning clock-wise until locked.
- 2) Take Panel D and Panel E and tighten cams. Make sure the cams on Panel D and Panel F face the bottom of the lectern. The two bolts just above the slots align with the two holes on the edge of Panel D (these holes reach into the cams). The two bolts in the center of the right side panel will align with the two holes on the edge of Panel E. Gently push the panel down on to the cam bolts until the panel is completely on the right side panel.
- 3) Taking the Panel F, with the casters facing the bottom of the unit, insert panel into the groove, make sure that the panel is all the way in the groove.

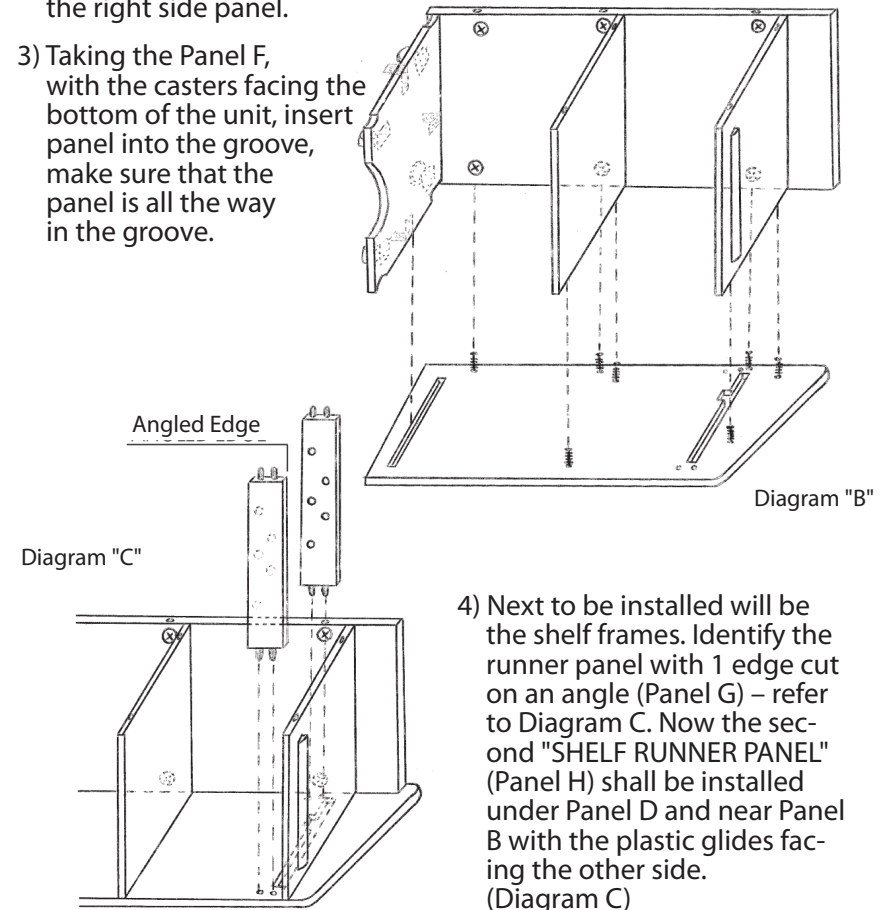

- 4) Next to be installed will be the shelf frames. Identify the runner panel with 1 edge cut on an angle (Panel G) – refer to Diagram C. Now the second "SHELF RUNNER PANEL" (Panel H) shall be installed under Panel D and near Panel B with the plastic glides facing the other side. (Diagram C)