

ValveMate 7100 Controller

Operating Manual



Electronic pdf files of Nordson EFD manuals are also available at www.nordsonefd.com



You have selected a reliable, high-quality dispensing system from Nordson EFD, the world leader in fluid dispensing. The ValveMate™ 7100 controller was designed specifically for industrial dispensing and will provide you with years of trouble-free, productive service.

This manual will help you maximize the usefulness of your ValveMate 7100 controller.

Please spend a few minutes to become familiar with the controls and features. Follow our recommended testing procedures. Review the helpful information we have included, which is based on more than 50 years of industrial dispensing experience.

Most questions you will have are answered in this manual. However, if you need assistance, please do not hesitate to contact EFD or your authorized EFD distributor. Detailed contact information is provided on the last page of this document.

The Nordson EFD Pledge

Thank You!

You have just purchased the world's finest precision dispensing equipment.

I want you to know that all of us at Nordson EFD value your business and will do everything in our power to make you a satisfied customer.

If at any time you are not fully satisfied with our equipment or the support provided by your Nordson EFD Product Application Specialist, please contact me personally at 800.556.3484 (US), 401.431.7000 (outside US), or Tara.Tereso@nordsonefd.com.

I guarantee that we will resolve any problems to your satisfaction.

Thanks again for choosing Nordson EFD.



Tara Tereso, Vice President

Contents

Contents.....	3
Introduction	4
Nordson EFD Product Safety Statement	5
Halogenated Hydrocarbon Solvent Hazards	6
High Pressure Fluids	6
Qualified Personnel	6
Intended Use.....	7
Regulations and Approvals	7
Personal Safety	7
Fire Safety	8
Preventive Maintenance.....	8
Important Disposable Component Safety Information	9
Action in the Event of a Malfunction	9
Disposal	9
Specifications.....	10
Operating Features.....	12
Front Panel Buttons / Modes of Operation	12
Indicator Lamps	13
Back Panel Markings	13
Typical Setup.....	14
Mounting the ValveMate 7100	15
External Power Adapter	16
Input / Output Connections.....	17
Initiate Connections	18
Alarm OUT Connection	18
Alarm IN Connection.....	18
End-of-Cycle Connection (EOC).....	18
24 VDC Output.....	18
I/O Connection Schematics	19
Air Connections.....	20
Air Output Connection	20
Air Input Connection	20
Final Setup Checklist.....	21
Testing the Dispense Valve	22
How To	23
How to Make On-the-Fly (OTF) Time Adjustments in RUN Mode	23
How to Set Controller to STEADY Mode	23
How to Use the TEACH Mode	23
How to Use PURGE Mode.....	23
How to Enable / Disable Low Air Pressure Alarm	24
How to Select PSI or BAR Pressure Readout.....	24
How to Enable / Disable CC INIT I/O as an External Alarm Input.....	24
Part Number	25
Replacement Parts	25
Troubleshooting	26

Introduction

IMPORTANT: The primary control of deposit size is the valve open time. The ValveMate 7100 provides easy access and “on the fly” adjustment of valve open time.

The ValveMate 7100 is an EFD dispense valve controller, incorporating programmable dispense time, digital time readout, keypad programming for easy user interface and input / output communication with host machine PLCs.

Other features include:

- Push-button time setting or one touch time programming
- Floating decimal, providing dispense time ranges of 0.001 to 99.9 seconds
- Bright red LED display
- Push-button purge feature
- Low air-pressure, optional tank low level detection, or other alarm detection devices
- End-of-Cycle feedback signal

The ValveMate 7100 has been designed with the machine builder and operator in mind. The objectives are to bring dispensing control close to the point of application and to provide the features necessary to make setup and operation as easy and precise as possible.

The ValveMate is easy to operate. Once you have reviewed the features, you will understand the benefits and the ease of control the ValveMate provides.

As with all EFD products, the ValveMate has been produced to exacting specifications and thoroughly tested prior to shipment.

To obtain maximum performance from this equipment, please read the instructions carefully.

Nordson EFD Product Safety Statement

WARNING

The safety message that follows has a WARNING level hazard.
Failure to comply could result in death or serious injury.



ELECTRIC SHOCK

Risk of electric shock. Disconnect power before removing covers and / or disconnect, lock out, and tag switches before servicing electrical equipment. If you receive even a slight electrical shock, shut down all equipment immediately. Do not restart the equipment until the problem has been identified and corrected.

CAUTION

The safety messages that follow have a CAUTION level hazard.
Failure to comply may result in minor or moderate injury.



READ MANUAL

Read manual for proper use of this equipment. Follow all safety instructions. Task- and equipment-specific warnings, cautions, and instructions are included in equipment documentation where appropriate. Make sure these instructions and all other equipment documents are accessible to persons operating or servicing equipment.



MAXIMUM AIR PRESSURE

Unless otherwise noted in the product manual, the maximum air input pressure is 7.0 bar (100 psi). Excessive air input pressure may damage the equipment. Air input pressure is intended to be applied through an external air pressure regulator rated for 0 to 7.0 bar (0 to 100 psi).



RELEASE PRESSURE

Release hydraulic and pneumatic pressure before opening, adjusting, or servicing pressurized systems or components.



BURNS

Hot surfaces! Avoid contact with the hot metal surfaces of heated components. If contact can not be avoided, wear heat-protective gloves and clothing when working around heated equipment. Failure to avoid contact with hot metal surfaces can result in personal injury.

Nordson EFD Product Safety Statement (continued)

Halogenated Hydrocarbon Solvent Hazards

Do not use halogenated hydrocarbon solvents in a pressurized system that contains aluminum components. Under pressure, these solvents can react with aluminum and explode, causing injury, death, or property damage. Halogenated hydrocarbon solvents contain one or more of the following elements.

Element	Symbol	Prefix
Fluorine	F	“Fluoro-”
Chlorine	Cl	“Chloro-”
Bromine	Br	“Bromo-”
Iodine	I	“Iodo-”

Check the Safety Data Sheet (SDS) or contact your material supplier for more information. If you must use halogenated hydrocarbon solvents, contact your EFD representative for compatible EFD components.

High Pressure Fluids

High pressure fluids, unless they are safely contained, are extremely hazardous. Always release fluid pressure before adjusting or servicing high pressure equipment. A jet of high pressure fluid can cut like a knife and cause serious bodily injury, amputation, or death. Fluids penetrating the skin can also cause toxic poisoning.

WARNING

Any injury caused by high pressure liquid can be serious. If you are injured or even suspect an injury:

- Go to an emergency room immediately.
- Tell the doctor that you suspect an injection injury.
- Show the doctor the following note.
- Tell the doctor what kind of material you were dispensing.

Medical Alert – Airless Spray Wounds: Note to Physician

Injection in the skin is a serious traumatic injury. It is important to treat the injury surgically as soon as possible. Do not delay treatment to research toxicity. Toxicity is a concern with some exotic coatings injected directly into the bloodstream.

Qualified Personnel

Equipment owners are responsible for making sure that EFD equipment is installed, operated, and serviced by qualified personnel. Qualified personnel are those employees or contractors who are trained to safely perform their assigned tasks. They are familiar with all relevant safety rules and regulations and are physically capable of performing their assigned tasks.

Nordson EFD Product Safety Statement (continued)

Intended Use

Use of EFD equipment in ways other than those described in the documentation supplied with the equipment may result in injury to persons or damage to property. Some examples of unintended use of equipment include:

- Using incompatible materials.
- Making unauthorized modifications.
- Removing or bypassing safety guards or interlocks.
- Using incompatible or damaged parts.
- Using unapproved auxiliary equipment.
- Operating equipment in excess of maximum ratings.
- Operating equipment in an explosive atmosphere.

Regulations and Approvals

Make sure all equipment is rated and approved for the environment in which it is used. Any approvals obtained for Nordson EFD equipment will be voided if instructions for installation, operation, and service are not followed. If the equipment is used in a manner not specified by Nordson EFD, the protection provided by the equipment may be impaired.

Personal Safety

To prevent injury, follow these instructions:

- Do not operate or service equipment unless you are qualified.
- Do not operate equipment unless safety guards, doors, and covers are intact and automatic interlocks are operating properly. Do not bypass or disarm any safety devices.
- Keep clear of moving equipment. Before adjusting or servicing moving equipment, shut off the power supply and wait until the equipment comes to a complete stop. Lock out power and secure the equipment to prevent unexpected movement.
- Make sure spray areas and other work areas are adequately ventilated.
- When using a syringe barrel, always keep the dispensing end of the tip pointing towards the work and away from the body or face. Store syringe barrels with the tip pointing down when they are not in use.
- Obtain and read the Safety Data Sheet (SDS) for all materials used. Follow the manufacturer's instructions for safe handling and use of materials and use recommended personal protection devices.
- Be aware of less-obvious dangers in the workplace that often cannot be completely eliminated, such as hot surfaces, sharp edges, energized electrical circuits, and moving parts that cannot be enclosed or otherwise guarded for practical reasons.
- Know where emergency stop buttons, shutoff valves, and fire extinguishers are located.
- Wear hearing protection to protect against hearing loss that can be caused by exposure to vacuum exhaust port noise over long periods of time.

Nordson EFD Product Safety Statement (continued)

Fire Safety

To prevent a fire or explosion, follow these instructions:

- Shut down all equipment immediately if you notice static sparking or arcing. Do not restart the equipment until the cause has been identified and corrected.
- Do not smoke, weld, grind, or use open flames where flammable materials are being used or stored.
- Do not heat materials to temperatures above those recommended by the manufacturer. Make sure heat monitoring and limiting devices are working properly.
- Provide adequate ventilation to prevent dangerous concentrations of volatile particles or vapors. Refer to local codes or the SDS for guidance.
- Do not disconnect live electrical circuits when working with flammable materials. Shut off power at a disconnect switch first to prevent sparking.
- Know where emergency stop buttons, shutoff valves, and fire extinguishers are located.

Preventive Maintenance

As part of maintaining continuous trouble-free use of this product, Nordson EFD recommends the following simple preventive maintenance checks:

- Periodically inspect tube-to-fitting connections for proper fit. Secure as necessary.
- Check tubing for cracks and contamination. Replace tubing as necessary.
- Check all wiring connections for looseness. Tighten as necessary.
- Clean: If a front panel requires cleaning, use a clean, soft, damp rag with a mild detergent cleaner. DO NOT USE strong solvents (MEK, acetone, THF, etc.) as they will damage the front panel material.
- Maintain: Use only a clean, dry air supply to the unit. The equipment does not require any other regular maintenance.
- Test: Verify the operation of features and the performance of equipment using the appropriate sections of this manual. Return faulty or defective units to Nordson EFD for replacement.
- Use only replacement parts that are designed for use with the original equipment. Contact your Nordson EFD representative for information and advice.

Nordson EFD Product Safety Statement (continued)

Important Disposable Component Safety Information

All Nordson EFD disposable components, including syringe barrels, cartridges, pistons, tip caps, end caps, and dispense tips, are precision engineered for one-time use. Attempting to clean and re-use components will compromise dispensing accuracy and may increase the risk of personal injury.

Always wear appropriate protective equipment and clothing suitable for your dispensing application and adhere to the following guidelines:

- Do not heat syringe barrels or cartridges to a temperature greater than 38° C (100° F).
- Dispose of components according to local regulations after one-time use.
- Do not clean components with strong solvents (MEK, acetone, THF, etc.).
- Clean cartridge retainer systems and barrel loaders with mild detergents only.
- To prevent fluid waste, use Nordson EFD SmoothFlow™ pistons.

Action in the Event of a Malfunction

If a system or any equipment in a system malfunctions, shut off the system immediately and perform the following steps:

1. Disconnect and lock out system electrical power. If using hydraulic and pneumatic shutoff valves, close and relieve pressure.
2. For Nordson EFD air-powered dispensers, remove the syringe barrel from the adapter assembly. For Nordson EFD electro-mechanical dispensers, slowly unscrew the barrel retainer and remove the barrel from the actuator.
3. Identify the reason for the malfunction and correct it before restarting the system.

Disposal

Dispose of equipment and materials used in operation and servicing according to local codes.

Specifications

NOTE: Specifications and technical details are subject to change without prior notification.

Item	Specification
Cabinet size	14.0 _w x 6.8 _H x 14.2 _D cm (5.51 _w x 2.68 _H x 5.59 _D ")
Weight	1.2 kg (2.9 lb)
Cycle rate	Exceeds 600 per minute
Time range	0.001–99.9 s
Electrical power input	24 VDC (±5%), 0.63 Amp maximum
Electrical input connector	Switchcraft L722RA or equivalent, locking type
External power adapter	100–240 VAC (+/-10%), ~50/60Hz input, 24 VDC (+/-5%), 0.63 Amp output, Switchcraft S761K locking DC plug or equivalent, wall mount, changeable AC plugs
Feedback circuits	5–24 VDC NC solid-state switch, 100 mA maximum
Cycle initiate	5–24 VDC signal, foot pedal, or contact closure initiate
Input air pressure	4.8–6.9 bar (70–100 psi)
Ambient operating conditions	Temperature: 5–45° C (41–113° F) Humidity: 85% RH at 30° C, 40% at 45° C non-condensing Height above sea level: 2,000 m (6,562 ft) maximum
Product classification	Installation Category II Pollution Degree 2
Approvals	CE, TÜV, RoHS, WEEE, China RoHS

Specifications (continued)

RoHS标准相关声明 (China RoHS Hazardous Material Declaration)

产品名称 Part Name	有害物质及元素 Toxic or Hazardous Substances and Elements					
	铅 Lead (Pb)	汞 Mercury (Hg)	镉 Cadmium (Cd)	六价铬 Hexavalent Chromium (Cr6)	多溴联苯 Polybrominated Biphenyls (PBB)	多溴联苯醚 Polybrominated Diphenyl Ethers (PBDE)
外部接口 External Electrical Connectors	X	0	0	0	0	0
<p>0: 表示该产品所含有的危险成分或有害物质含量依照EIP-A, EIP-B, EIP-C的标准低于SJ/T11363-2006 限定要求。 Indicates that this toxic or hazardous substance contained in all the homogeneous materials for this part, according to EIP-A, EIP-B, EIP-C is below the limit requirement in SJ/T11363-2006.</p> <p>X: 表示该产品所含有的危险成分或有害物质含量依照EIP-A, EIP-B, EIP-C的标准高于SJ/T11363-2006 限定要求。 Indicates that this toxic or hazardous substance contained in all the homogeneous materials for this part, according to EIP-A, EIP-B, EIP-C is above the limit requirement in SJ/T11363-2006.</p>						









WEEE Directive



This equipment is regulated by the European Union under WEEE Directive (2012/19/EU). Refer to www.nordsonefd.com/WEEE for information about how to properly dispose of this equipment.

Operating Features

Front Panel Buttons / Modes of Operation

POWER	Press the Power  button to turn power ON or OFF. NOTE: The ValveMate 7100 will always power up into the RUN mode.
RUN	Enables external initiate inputs. The cycle button is disabled.
SETUP	Setup, testing, and modification of dispense time.
STEADY	Timer override. Press UP / DOWN   to toggle between TIME and STEADY  operation.
TEACH	For easy setting and teaching of time mode in filling or other longer-cycle applications.
PURGE	Enables purging of the dispense valve.
CYCLE	Pressing the  button will provide different results according to the selected MODE.
TIME SET	Pressing the   buttons will decrement or increment the valve on-time. In SETUP or TEACH mode, pressing both buttons simultaneously will zero out the time. The up and down time adjustment buttons are available in the SETUP, TEACH, and RUN modes.
ALARMS	<ol style="list-style-type: none"> 1. Low Air Pressure Alarm: Ensures sufficient pressure is present for valve operation. Can be disabled. 2. CC INIT (Contact Closure Initiate): Optional usage of the CC INIT for external alarm applications. Examples of uses: low tank level switch, operator safety interlock, etc. <p>Alarm conditions are assessed (air pressure less than 60 psi and CC INIT open) just prior to the start of a dispense operation.</p>
MODE	Press the MODE  button to cycle through the SETUP modes.

Extended User Setup Functions

- Low Air Pressure Alarm: ON  / OFF 
- Pressure Units: psi  / bar 
- CC INIT : Enable for Alarm IN 

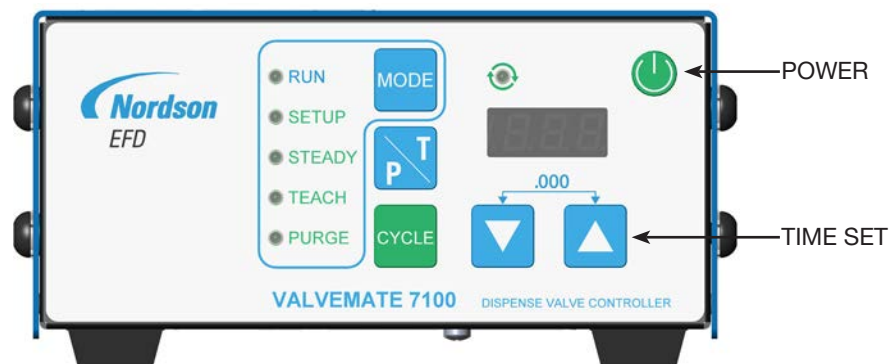

Operating Features (continued)

Indicator Lamps

The indicator lamp  at the upper left corner above the LED display will illuminate whenever the dispense valve is actuated.

The center front panel has five indicator lamps used to indicate the operational mode.

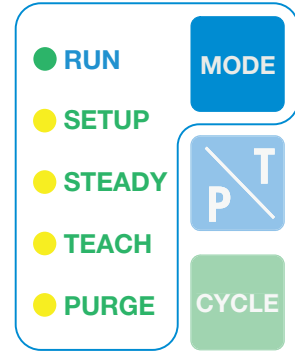

Back Panel Markings



Maximum Air Pressure Caution
Caution symbol informing that the maximum air input pressure is 7.0 bar (100 psi). Excessive air input pressure may damage the equipment.



Foot Pedal / Finger Switch Connector
Switch symbol identifies the connector for a momentary contact closure switch for dispense initiates. An optional foot pedal, P/N 7014865 may be ordered.



Power Input Current
Input current symbol specifying that DC current is utilized on the power supply connector. The current is derived from an external 24 VDC source.



Chassis Connection
This symbol identifies the chassis connection terminal. Used for grounding the chassis to shunt leakage current and / or to enhance system ESD protection.



Typical Setup

All EFD valves are supplied with an installation manual. The manual will explain the operation of the valve and also how to set up the valve with the fluid reservoir.

NOTE: Use only oil-free, clean, dry filtered air.

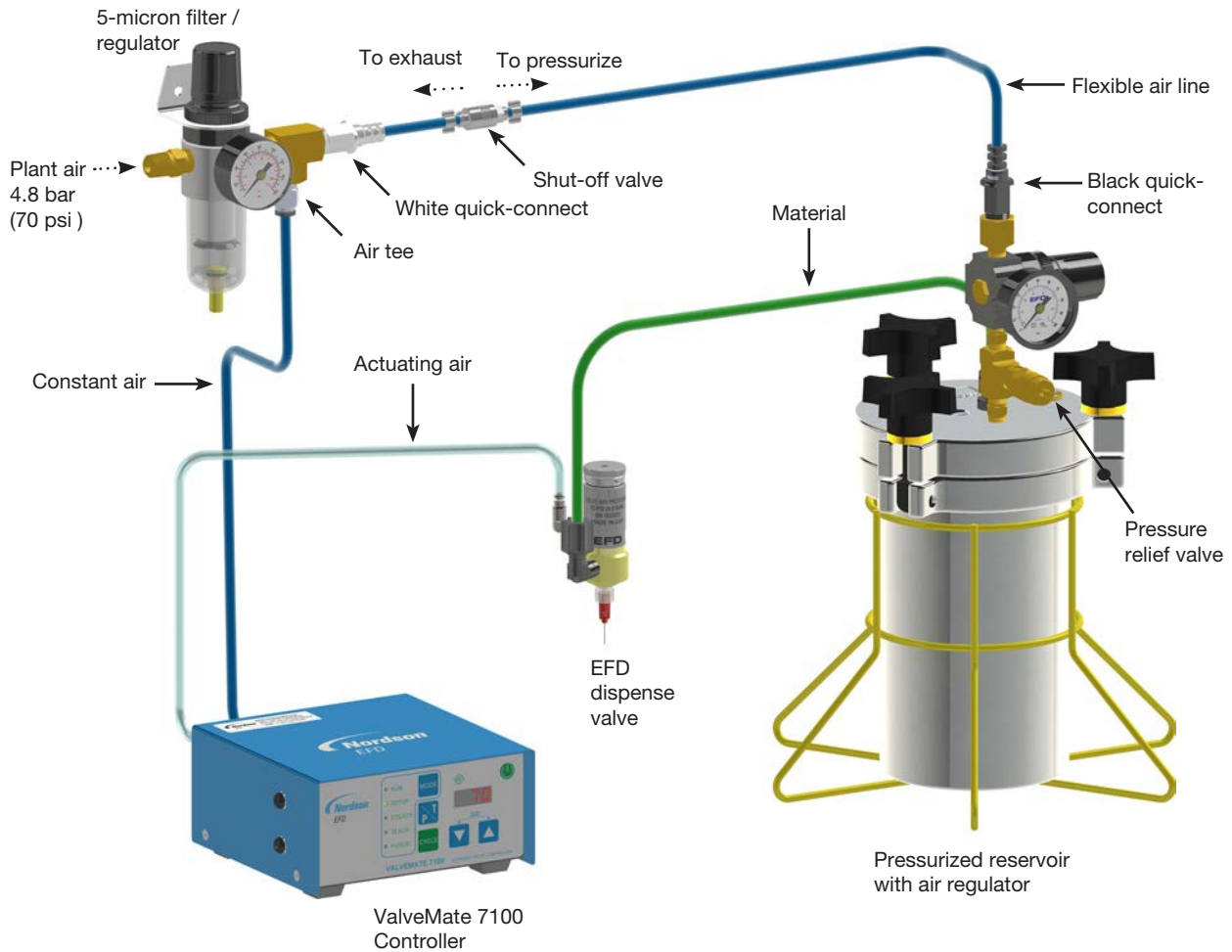

⚠ CAUTION

Always depressurize the reservoir before opening. To do this, slide the shutoff valve on the air line away from the reservoir. If using an EFD tank, open the pressure relief valve as well. Before opening the reservoir, check the pressure gauge to verify that the pressure is zero (0).

On all EFD cartridge reservoirs, the unique threaded design provides fail-safe air pressure release during cap removal.

Mounting the ValveMate 7100

The ValveMate 7100 can be mounted either over or under a surface using screws to secure the bracket.



Use the universal mounting bracket (included) to mount the controller either over or under the cabinet. The bracket allows the controller to pivot 30° from a horizontal position. When mounted under a workbench, secure with screws or nuts and bolts to support 6.35 kg (14 lb).

Optional Panel Mount Kit

For panel mounting, an optional panel mount bracket kit is available.
(Order P/N 7026544)

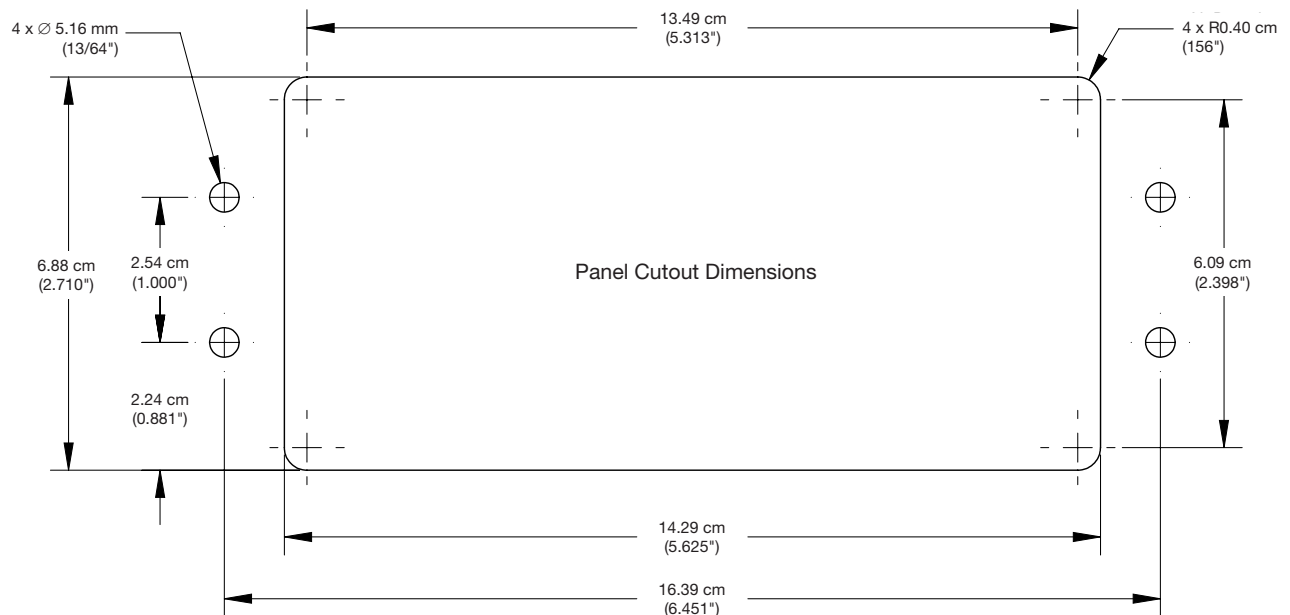

External Power Adapter

A universal 24 VDC remote power supply with a locking ring DC connector is included with each ValveMate 7100. Select a convenient location and connect to the appropriate input voltage.

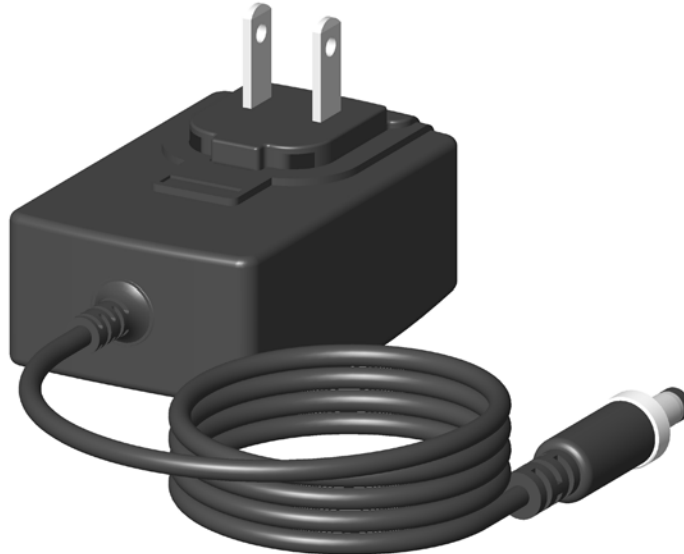

Input / Output Connections

The 10 pin terminal strip includes 5–24 VDC and contact closure CC initiate inputs. Outputs include an Alarm Out, End-of-Cycle (EOC), and a 24 VDC courtesy power.

- 5–24 VDC INIT: Dispense initiate input activated with a 5–24 VDC input voltage.
- EOC OUT: End-of-Cycle feedback.
- ALARM OUT: Circuit that closes when an alarm condition is present.
- CC INIT: Dispense initiate input activated with a contact closure switch.
- 24 VDC OUT: Courtesy output, 24 VDC, 200 mA.

NOTE: ALARM OUT and EOC (End-of-Cycle) only function in the RUN mode.

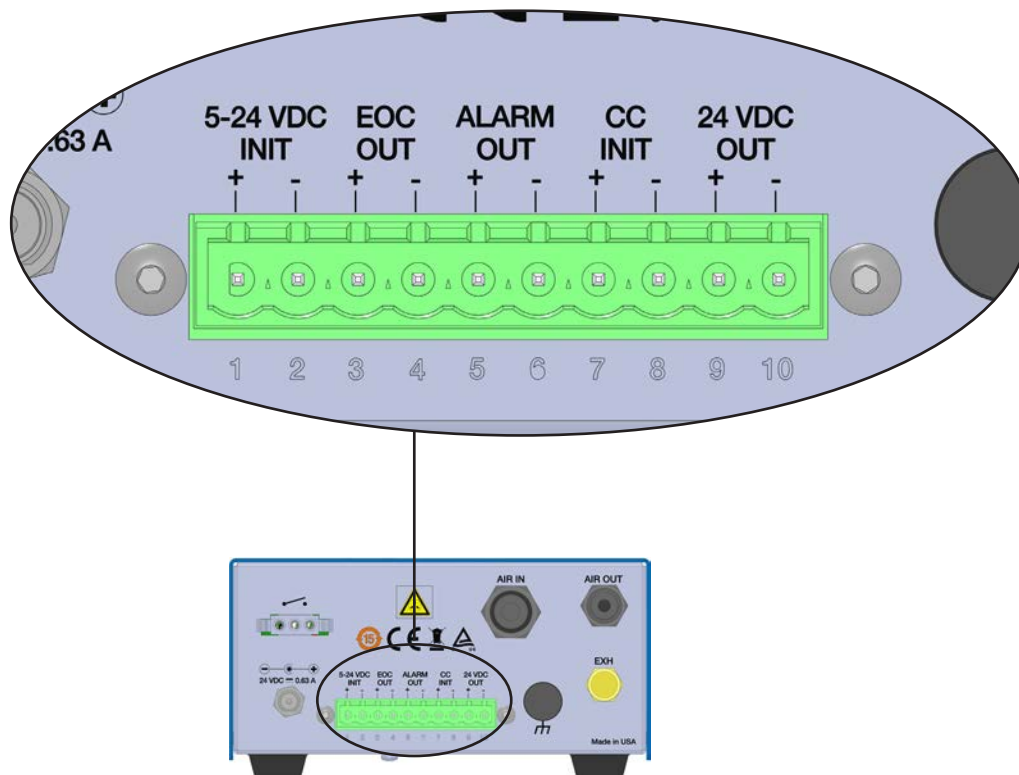

Input / Output Connections (continued)

Initiate Connections

The 7100 can be initiated by three inputs:

- 5–24 VDC INIT: Application of 5–24 VDC to the 5–24 VDC INIT terminals, pins 1+2.
- CC INIT: Application of mechanical contacts on the CC INIT terminals, pins 7+8.
- Foot Pedal: Use of the optional EFD foot pedal (P/N 7014865) plugged into the foot pedal receptacle.

A connection schematic is detailed on page 19.

Alarm OUT Connection

The ValveMate 7100 features an alarm output circuit. The Alarm OUT circuit closes when an alarm condition is present. The Alarm OUT circuit is a normally open electronic switch that can switch an external 5–24 VDC circuit to an external signaling device or PLC input. Maximum load is 100 mA, 5–24 VDC.

Alarm IN Connection

The ValveMate 7100 offers an alternate use of the CC INIT initiate input for an external alarm signal. Refer to the “How to” instructions on page 23 to enable. When enabled as an alarm input, the CC INIT on pins 7 and 8 is connected to a normally closed switch, such as a low level reservoir float switch. Pins 7 and 8 must be closed to initiate a dispense valve cycle.

End-of-Cycle Connection (EOC)

The ValveMate 7100 features an End-of-Cycle (EOC) circuit to acknowledge an active dispense valve initiate. The EOC circuit is a normally closed electronic switch that can switch an external 5–24 VDC circuit to an external signaling device or PLC input. Maximum load is 100 mA, 5–24 VDC.

End-of-Cycle (EOC) signaling only functions when the ValveMate 7100 is in the RUN mode. The End-of-Cycle (EOC) is normally closed in the RUN mode while the dispense cycle is inactive. The EOC switch opens when the dispense cycle is initiated and closes when the dispense cycle is completed.

24 VDC Output

The courtesy 24 volt DC 200 mA can be used to provide power to the EOC and Alarm out circuits for signalling purposes. Also, it can be used as a power source for an indicator device or initiate signal through a contact closure switch to the 5–24 VDC INIT circuit.

I/O Connection Schematics

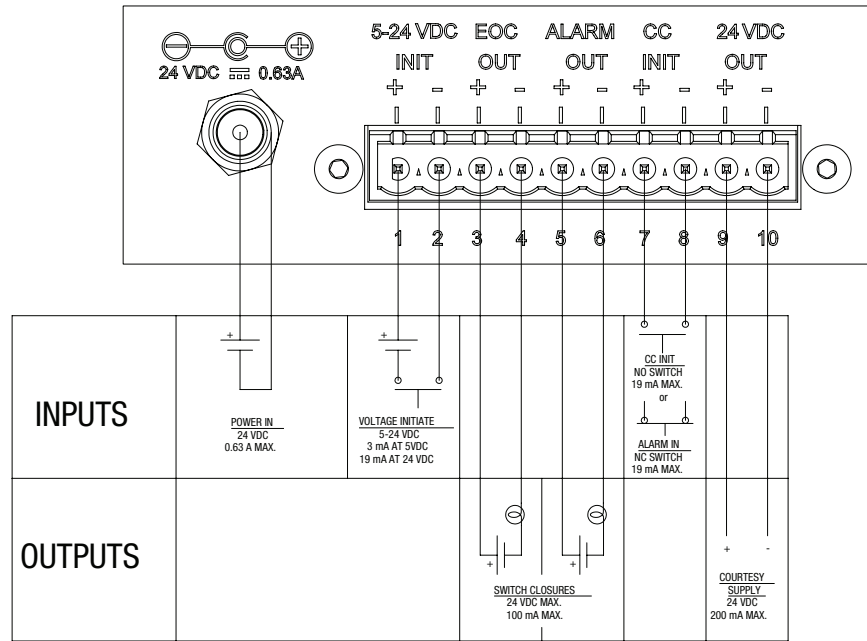

I/O External Wiring Diagram

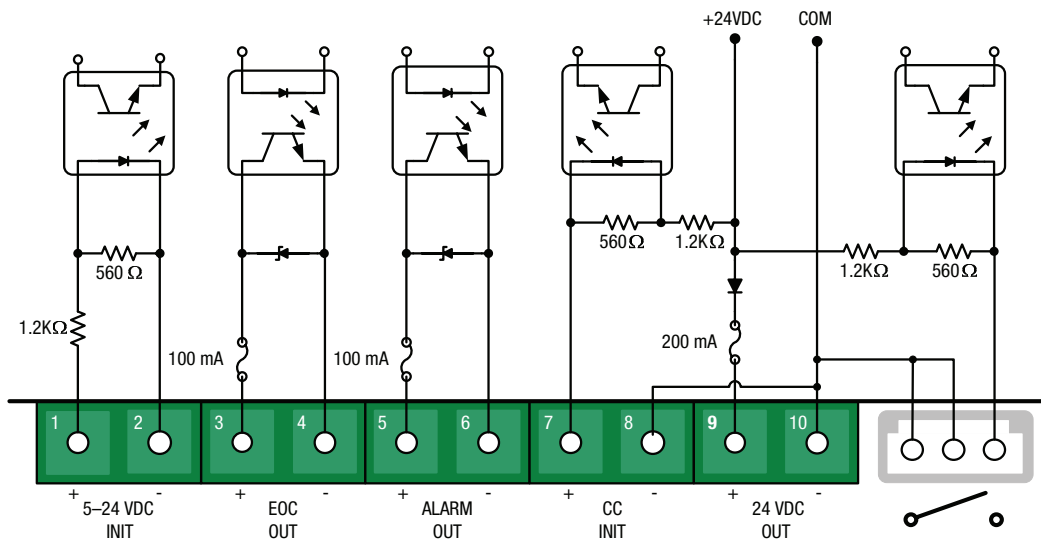

I/O Electrical Schematic

Air Connections

Air Output Connection

Connect the valve actuating air hose to the AIR OUT **1** at the back of the ValveMate 7100 controller.

Air Input Connection

Connect the ValveMate 7100 to plant air by first installing the included EFD five-micron filter regulator (P/N 7002002) on your air supply.

Install the air tee with push-in fitting (P/N 7016230) in the output of the filter regulator. (Included with EFD tank/cartridge reservoirs.)

3 m (9 ft) of 6 mm OD air line is supplied. Using the 6 mm push-in fitting supplied, connect one end to the P/N 7016230 air tee. Connect the other end of the air line by pushing it firmly into the AIR IN **2** connector on the ValveMate 7100 until it bottoms out. Be sure that the line is inserted all the way into the fitting.

Set the pressure at the P/N 7002002 filter regulator to 4.8 bar (70 psi).

The quick-connect on the air tee is used to provide air pressure to the air pressure regulator on EFD fluid reservoirs. This connection will be made at a later step in the setup.

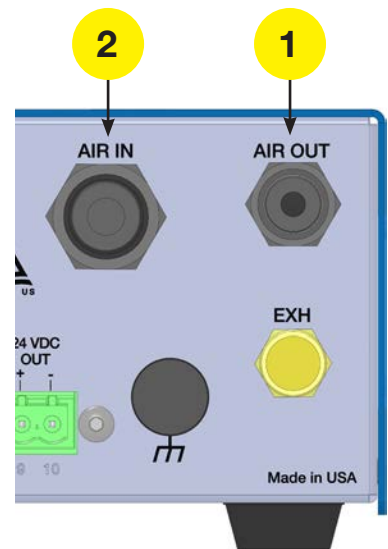





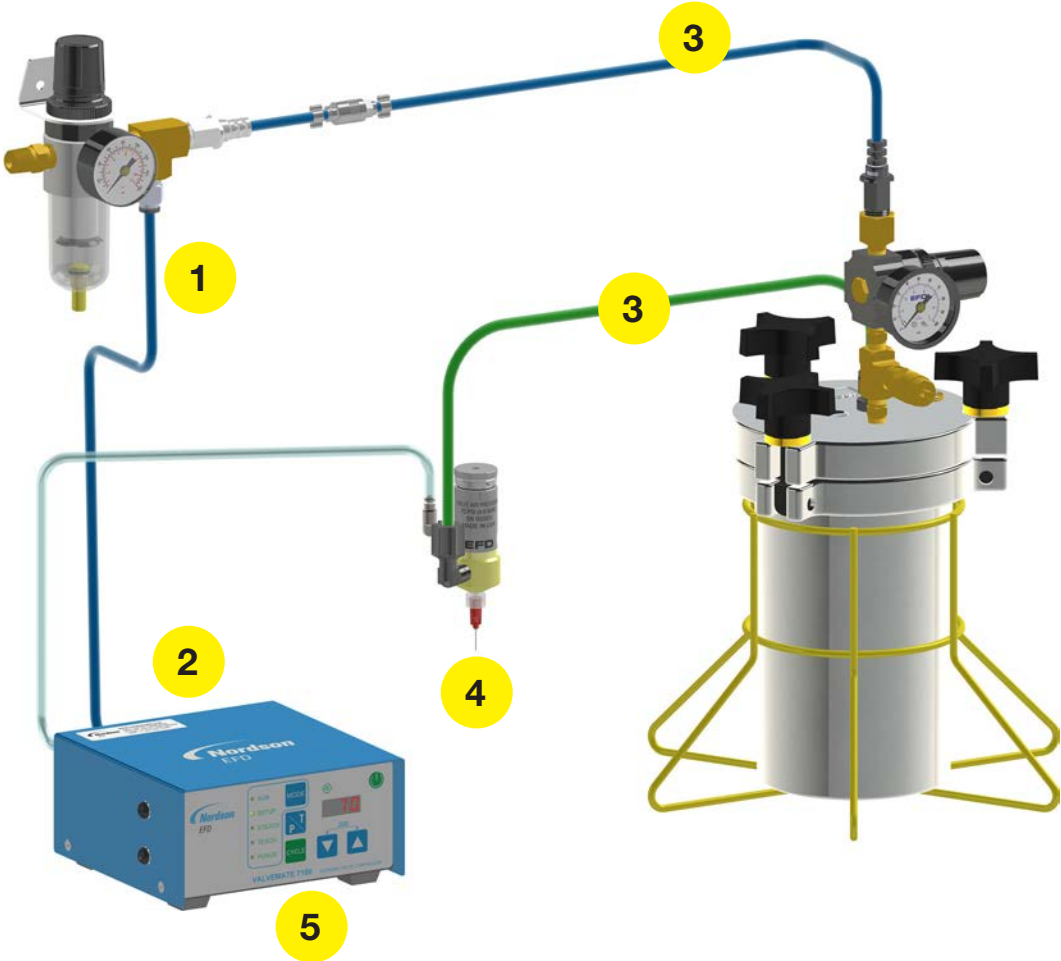

Important: The air output push-in fitting has an internal safety stop valve. Make certain the valve air hose is fully inserted into the fitting to allow proper air flow.

Final Setup Checklist

- 1. Air pressure to ValveMate 7100 is set to 4.8 bar (70 psi). **1**
- 2. Initiate connection and I/O are wired correctly. **2**
- 3. Valve and fluid reservoir are properly connected. **3**
- 4. Valve is set up and dispensing tip installed in accordance with the dispense valve installation guide. **4**
- 5. Turn power  on. Confirm indicator lamps and LED display are lit. **5**





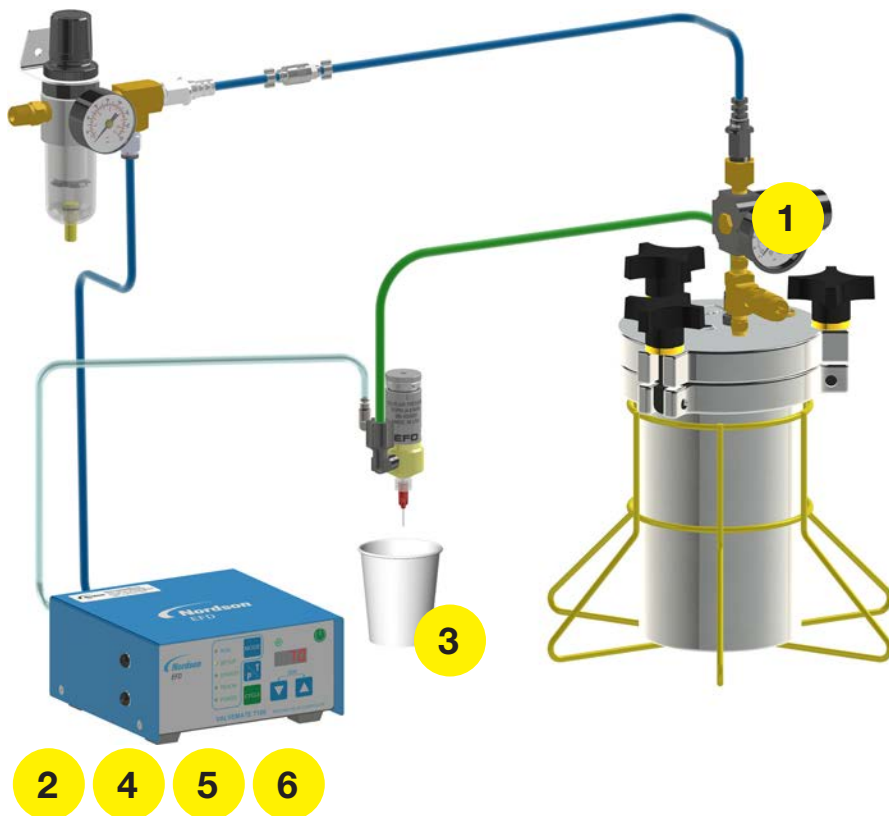

Testing the Dispense Valve

1. Set the tank pressure. For low viscosity, low pressure; for high viscosity, higher pressure.
2. Using the Mode  button on the ValveMate controller, place the controller in the purge  mode.
3. Place a container under the valve and press the CYCLE  button to open the valve and flow material until all air is purged from the system. Adjust the tank pressure or valve stroke knob to set a flow rate that is not too low or too high. A high flow rate will make setting up a small dot difficult or could cause splashing.
4. Using the Mode  button again, place the controller in the Setup mode. Using the up / down   buttons below the LED, set a dispense time of 0.050 seconds.
5. Press the CYCLE  button to initiate a dispense cycle. Increase or decrease the time or tank pressure to arrive at the desired deposit size. The primary control of deposit size is the valve open time.
6. The system is now ready to be initiated by the machine controls when the machine is started. The ValveMate 7100 must be in RUN mode.







How To







How to Make On-the-Fly (OTF) Time Adjustments in RUN Mode

- Step 1 Press CYCLE  button to enable OTF; display will blink.
- Step 2 Press  or  buttons to adjust valve on time.
- Step 3 Press CYCLE  button to disable OTF; display no longer blinks.



How to Set Controller to STEADY Mode

- Step 1 Press MODE  button and scroll to STEADY.
- Step 2 Press  or  to toggle between TIME and STEADY  operation.
- Step 3 When  appears on LED display, press Mode button to return to RUN.

How to Use the TEACH Mode





- Step 1 Press MODE  button and scroll to TEACH.
- Step 2 Press and hold CYCLE  button or depress the foot pedal in the TEACH mode. LED display will begin “flashing” before TEACH function begins.
- Step 3 Add incremental time by continued press and hold of CYCLE  button or depress and hold the foot pedal.
- Step 4 To fine-tune programmed pulse time, press  or  to decrease / increase time.
- Step 5 Press both   to 0.000 out time and restart the TEACH process.

How to Use PURGE Mode







- Step 1 Press MODE  button and scroll to PURGE.
- Step 2 Press CYCLE  button or depress foot pedal to purge dispense valve.

How To (continued)







How to Enable / Disable Low Air Pressure Alarm

- Step 1 Press MODE  button and scroll to STEADY.
- Step 2 Press and hold  until Aon **RoN** or Aof **RoF** is visible.
- Step 3 Press  or  button to toggle between Alarm On **RoN** or Alarm OFF **RoF**.
- Step 4 Press MODE  button to exit.

How to Select PSI or BAR Pressure Readout

- Step 1 Press MODE  button and scroll to STEADY.
- Step 2 Press and hold  until Aon **RoN** or Aof **RoF** is visible.
- Step 3 Press  button one time.
- Step 4 Press  or  button to toggle between **17** for BAR, and **53** for PSI.
PSI Format: 0.0 to 101.0
BAR Format: 0.0 to 7.0
- Step 5 Press MODE  button to exit.

How to Enable / Disable CC INIT I/O as an External Alarm Input

- Step 1 Press MODE  button and scroll to STEADY.
- Step 2 Press and hold  until Aon **RoN** or Aof **RoF** is visible.
- Step 3 Press  two times.
- Step 4 Press  or  button to toggle between CCI **CCI** or ALI **ALI**
CC INIT function is:
CCI: **CCI** Contact Closure initiate input
ALI: **ALI** External alarm input
- Step 5 Press MODE  button to exit.

Part Number

Part #	Description
7015340	7100 Single Valve Controller

Replacement Parts

Part #	Description
7026520	KIT VALVE SOLENOID 24VDC 1.8W WITH CONN
7026519	KIT POWER SUPPLY DC EXTERNAL 7100 / 7140 (not shown)
7026543	KIT DC CABLE ASSEMBLY-2M-LOCKING CONN (not shown)
7026544	KIT PANEL MOUNT 7100 / 7140 (not shown)

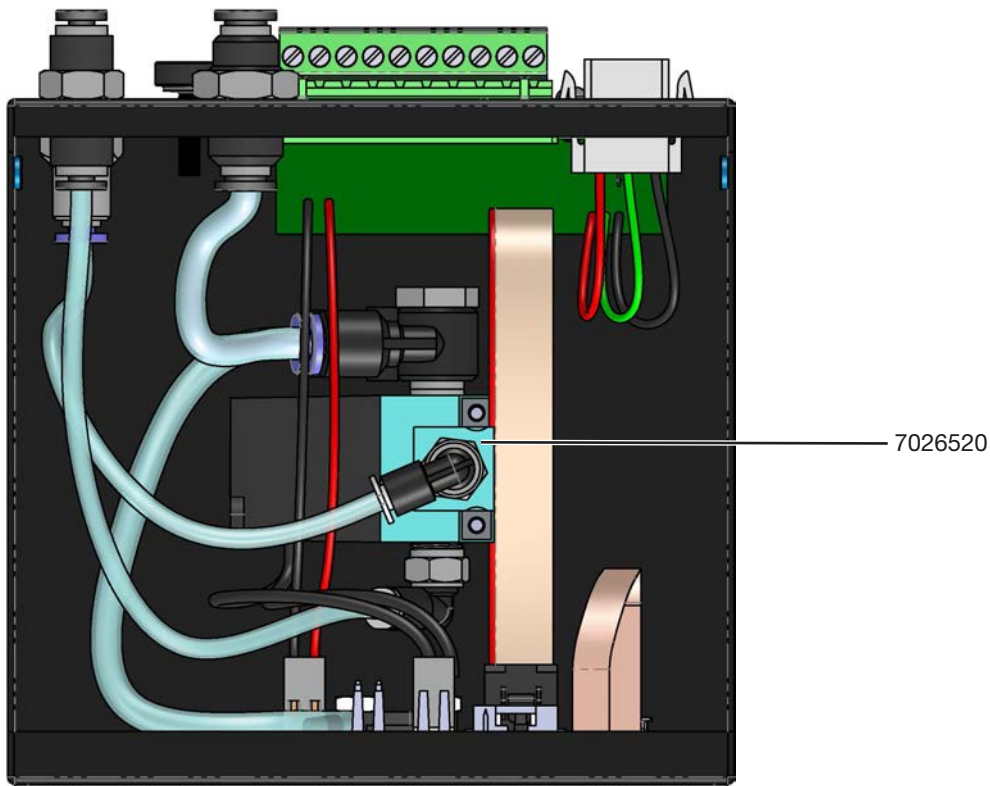

Troubleshooting

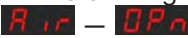
Problem	Possible Cause and Correction
LED toggles between air and pressure value and will not accept initiate signal.	Air pressure to the ValveMate 7100 has dropped below 4.1 bar (60 psi). Raise the input pressure to 4.8 bar (70 psi). Press the Mode button to reset. If problem persists, make sure devices such as air cylinders are not causing a pressure drop in the ValveMate 7100 input air line.
Unit is not responding to the initiate signal.	Check to make sure the unit is not in a mode other than RUN. The response delay in the pneumatic circuit does not allow the valve to open when the dispense time is set at or below 0.010 seconds. Increase dispense time. The signal must break cleanly before the next signal is initiated.
Timer is inoperative.	Check to make sure the unit is not in the steady mode.
LED is blinking 	The external alarm is enabled and the circuit is open. Check cause for fault or disable. Refer to “How to Enable / Disable CC INIT I/O as an External Alarm Input” on page 24.

NORDSON EFD ONE YEAR LIMITED WARRANTY

This Nordson EFD product is warranted for one year from the date of purchase to be free from defects in material and workmanship (but not against damage caused by misuse, abrasion, corrosion, negligence, accident, faulty installation, or by dispensing material incompatible with equipment) when the equipment is installed and operated in accordance with factory recommendations and instructions.

Nordson EFD will repair or replace free of charge any defective part upon authorized return of the part prepaid to our factory during the warranty period. The only exceptions are those parts which normally wear and must be replaced routinely, such as, but not limited to, valve diaphragms, seals, valve heads, needles, and nozzles.

In no event shall any liability or obligation of Nordson EFD arising from this warranty exceed the purchase price of the equipment.

Before operation, the user shall determine the suitability of this product for its intended use, and the user assumes all risk and liability whatsoever in connection therewith. Nordson EFD makes no warranty of merchantability or fitness for a particular purpose. In no event shall Nordson EFD be liable for incidental or consequential damages.

This warranty is valid only when oil-free, clean, dry, filtered air is used, where applicable.



For Nordson EFD sales and service in over 40 countries, contact Nordson EFD or go to www.nordsonefd.com.

Global

800-556-3484; +1-401-431-7000
info@nordsonefd.com

Europe

00800 7001 7001
infoefd.europe@nordsonefd.com

Asia

China: +86 (21) 3866 9006; china@nordsonefd.com
India: +91 80 4021 3600; india@nordsonefd.com
Japan: +81 03 5762 2760; japan@nordsonefd.com
Korea: +82-31-736-8321; korea@nordsonefd.com
SEAsia: +65 6796 9522; sin-mal@nordsonefd.com

The Wave Design is a trademark of Nordson Corporation.
©2021 Nordson Corporation 7026881 v012321