

FLUKE®

772/773

Milliamp Process Clamp Meter

Instruction Sheet

Introduction

The hand-held, battery-operated Fluke 772 and 773 Milliamp Process Clamp Meters (the Meter) can be used in troubleshooting transmitters, valves, PLC and DCS I/O. Unlike conventional clamp meters, the Meter features a remote jaw that is connected to the main body via extension cable.

Features

- In-circuit measurement of 0-24 mA dc and up to 99.9 mA dc using a remotely connected clamp via extension cable
- 0-24 mA dc sourcing and simulating
- 0-10 V dc sourcing (773)
- Loop power supply 24 V dc output
- 0-30 V dc measurement (773)
- Scaled mA output (773)
- Simultaneous mA measurement via detachable clamp and mA sourcing (773)
- 250 Ω HART resistor for mA source
- Electronic zero
- Percentage span (0-100 %)
- Hold
- Auto power off (battery saver)
- Display backlight
- Measurement spotlight LED

PN 3351049

February 2009

© 2009 Fluke Corporation. All rights reserved.

All product names are trademarks of their respective companies. Specifications are subject to change without notice. Printed in China.

The Meter comes with:

- Four AA alkaline batteries (installed)
- Soft carrying case
- TL75 test leads
- AC 72 detachable clip
- TL 940 mini hook test leads
- Instruction sheet

Contacting Fluke

To contact Fluke, call one of the following telephone numbers:

- Technical Support USA: 1-800-44-FLUKE (1-800-443-5853)
- Calibration/Repair USA: 1-888-99-FLUKE (1-888-993-5853)
- Canada: 1-800-36-FLUKE (1-800-363-5853)
- Europe: +31 402-675-200
- Japan: +81-3-3434-0181
- Singapore: +65-738-5655
- Anywhere in the world: +1-425-446-5500

Or, visit Fluke's website at www.fluke.com.

To register your product, visit <http://register.fluke.com>.

To view, print, or download the latest manual supplement, visit <http://us.fluke.com/usen/support/manuals>.

Safety Information and Symbols

A **Warning** statement identifies hazardous conditions and actions that could cause bodily harm or death.

A **Caution** statement identifies conditions and actions that could damage the Meter or the equipment under test.

Read First: Safety Information

To ensure safe operation and service of the Meter, follow these instructions:

- **Read the Instruction Sheet before use and follow all safety instructions.**
- **Use the Meter only as specified in the Instruction Sheet; otherwise, the Meter's safety features may be impaired.**
- **Before each use, inspect the Meter and cable for damage. Look for cracks and missing portions of the clamp and cable. Do not use if clamp is damaged.**
- **Use caution when working with voltages above 33 V rms 47 V peak or 70 V dc these voltages pose a shock hazard.**
- **Do not use to measure ac current.**
- **Do not use to measure ac voltage.**
- **Avoid working alone so assistance can be rendered in an emergency.**













- Use extreme caution when working around bare conductors or bus bars. Contact with the conductor could result in electric shock.
- To avoid false readings that can lead to electrical shock and injury, replace the batteries as soon as the low battery indicator  appears.
- Adhere to local and national safety codes. Individual protective equipment must be used to prevent shock and arc blast injury where hazardous live conductors are exposed.
- When measuring, keep fingers behind the Tactile Barrier. See Figure 1.
- Do not use on non-insulated conductors.
- Do not use near strong magnetic fields.
- Remove test leads before opening case.

Table 1 explains the symbols that are used on the Meter or in this Instruction Sheet.

Table 1. Symbols

Symbol	Explanation
	Do not apply around, or remove from HAZARDOUS LIVE conductors.
	Risk of danger. Important information. See Users Manual.
	Risk of Electrical Shock.
	Equipment protected by double or reinforced insulation.
	Battery
	Conforms to relevant European Union directives.
	DC (Direct Current)
	Earth Ground
	Do not dispose of this product as unsorted municipal waste. Go to Fluke's website for recycling information.
	Conforms to relevant Australian standards.
	Conforms to relevant Canadian and US standards.

Getting Acquainted with the Meter

Figures 1-4 explain the Meter's features, buttons, input/output jacks, and display.

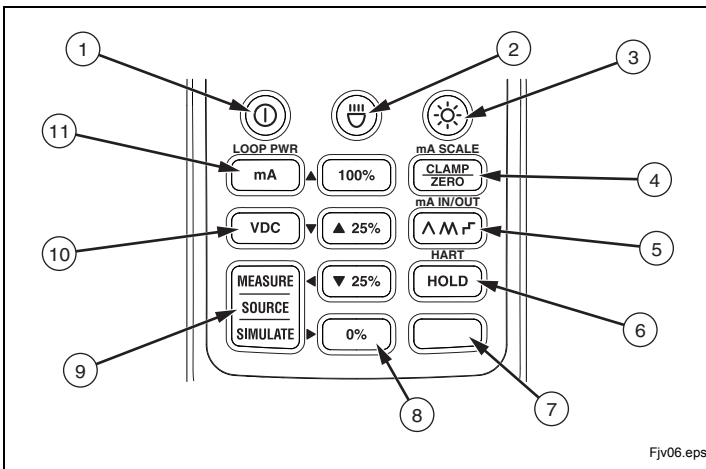

Fjv06.eps

Number	Description
①	Turns the Meter on and off
②	Measurement spotlight LED button
③	Turns the display backlight on and off
④	Switches the Meter to Clamp Measure mode. Zeros the clamp reading in Clamp mode. The Clamp modes includes clamp measure, mA scale output, and mA IN/OUT. Press <input type="button" value=""/> first to change to mA scale (773).
⑤	Cycles through source output ramping and 25 % stepping: (Λ) Slow repeating 0 % - 100 % - 0 % ramp (M) Fast repeating 0 % - 100 % - 0 % ramp (r) Repeating 0 % - 100 % - 0 % ramp in 25 % steps Press <input type="button" value=""/> first to activate mA IN/OUT (773).
⑥	Captures and holds the current reading. Pressing <input type="button" value=""/> first activates the 250 Ω HART resistor.
⑦	<input type="button" value=""/> activates features listed above some buttons
⑧	0 %-100 %- sets voltage or mA sourcing output. Press <input type="button" value=""/> first to activate ▲, ▼, ◀, and ▶ to adjust the source output. Long press <input type="button" value="0%"/> or <input type="button" value="100%"/> to set span range point.
⑨	Measure, Source, Simulate button
⑩	DC Volts selection (773)
⑪	mA selection. Press <input type="button" value=""/> first to activate Loop Power function.

Figure 1. Buttons

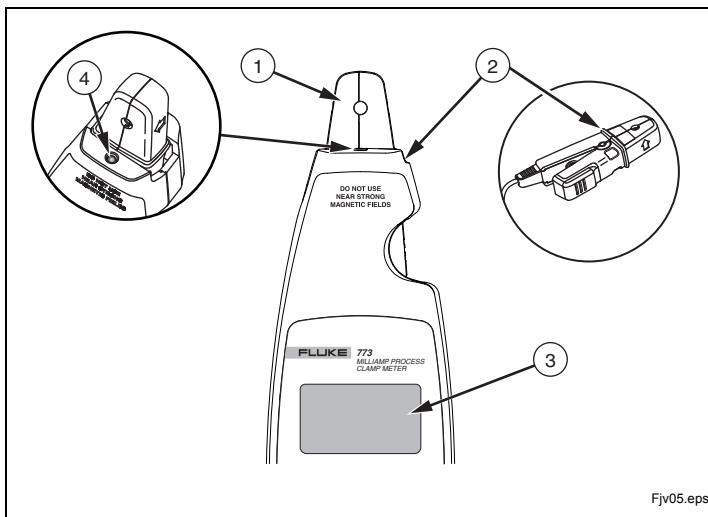

Fjv05.eps

Number	Description
①	Detachable clamp
②	Tactile Barrier docked and un-docked. Refer to "Safety Information and Symbols".
③	Display
④	Measurement spotlight LED

Figure 2. The Milliamp Process Clamp Meter

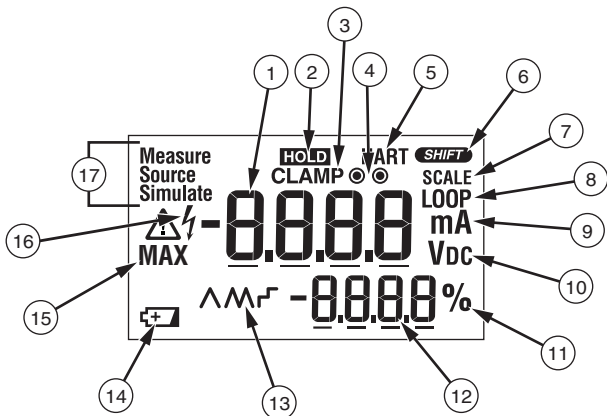

Fjv07.eps

Number	Description
①	Main display values
②	HOLD is activated
③	Clamp is active
④	Test lead jack indicator. Test lead connection is required.
⑤	HART 250 Ω resistor is engaged
⑥	Shift is active
⑦	Reading is scaled
⑧	Loop Power is active
⑨	Milliamps
⑩	Volts dc
⑪	Percentage
⑫	Secondary display
⑬	Ramping is engaged
⑭	Low battery symbol
⑮	Maximum voltage warning
⑯	High voltage is present
⑰	Measure, Source, or Simulate is active

Figure 3. Display (773 shown)

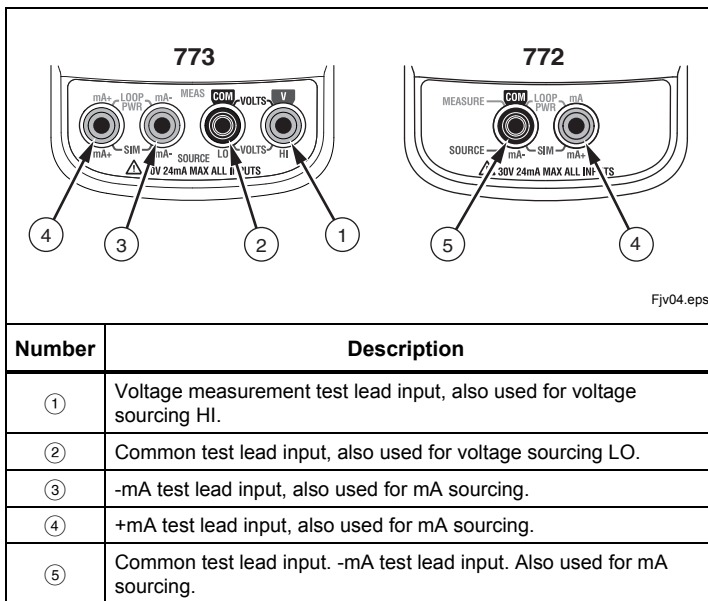

Figure 4. Input/Output Jacks

Features

The following sections give more detail about the Meter's features.

Percentage Span

The Source and Simulate Percentage Span feature displays the span for 4 to 20 mA loops. Use , , , and to adjust the source or simulated current (772) or dc voltage and current (773).

20 mA	100 %	8 mA	25 %
16 mA	75 %	4 mA	0 %
12 mA	50 %	0 mA	-25 %



Zero Adjust



Before taking measurements with the clamp, push to zero the display by removing the offset. Make sure the clamp jaws are closed and no current is flowing through them before zeroing.

Backlight

Press to turn the backlight on and off. The backlight automatically turns off after 2 minutes.

User Options

Several user options can be activated at Meter power up. Hold  when powering on the Meter. While holding down , toggle on/off each option by repeatedly pressing the following keys:

-  toggle on/off backlight auto off. Display shows **bLit on** or **oFF**.
-  toggle on/off spotlight auto off. Display shows **SLit on** or **oFF**.
-  toggle on/off auto power off. Display shows **PoFF on** or **oFF**.

When all key are released, the software version appears and the Meter enters Clamp Measure mode.





Measurement Spotlight LED

The Measurement Spotlight LED helps to quickly find mA signal wires. Press  to activate it. To extend battery life, the light automatically turns off after 2 minutes.

Display HOLD



Warning

To avoid electric shock, be aware of the measurement being taken when using Display HOLD. When Display HOLD is activated, the display will not change when different currents are applied.

Press  to activate Display Hold mode. The display shows  and the display freezes. To exit and return to normal operation, press  a second time. When in Auto Ramping mode,  stops ramping.

Auto Ramping the Output

Auto ramping can continuously apply a varying output from the mA source to a device while your hands remain free to test the response. When  is pressed, the Meter produces a repeating 0 % - 100 % - 0 % ramp in a choice of three ramp waveforms:

-  0 % - 100 % - 0 % 40-second smooth ramp
-  0 % - 100 % - 0 % 30-second smooth ramp
-  0 % - 100 % - 0 % 25 % step ramp, 10 seconds each step.

To exit ramping, press any button.

Probe Holder

The Meter is equipped with a probe holder that can either hold a test probe or can be used to attach the Fluke ToolPak. See Figure 5.

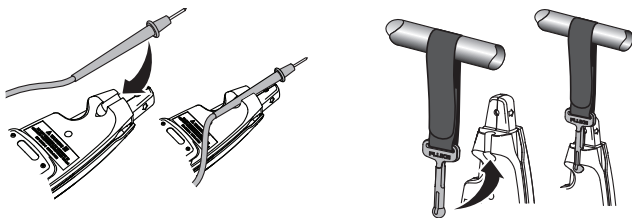

Figure 5. The Probe Holder

Taking Measurements

⚠ ⚠ Warning

To avoid electric shock, do not use the clamp on non-insulated conductors.

Measurements can be taken with the clamp in the docked position, remotely using the 1 m cable, or via test leads. For accurate measurements:

- Always zero the Meter prior to taking measurements with the clamp.
- To reduce magnetic influences, zero the Meter as close to the measurement in the same position or jaw direction that is used for the measurements as possible.
- Make sure the clamp is free of contamination.

To use the clamp for measurements:

1. Press **CLAMP ZERO** to enter Clamp Measure mode and to zero the Meter. Clamp mode includes clamp measure, mA scale output, and mA IN/OUT. If necessary, press **□** to change to mA scale.
2. Clamp the jaw around the conductor under test. The Meter displays the measured conductor current. See Figure 6.
 - A positive reading indicates current flowing in the direction of the arrow on the clamp.
 - A negative reading indicates current flowing in the opposite direction of the arrow.
 - Do not clamp more than one wire.

The small secondary display shows the reading in mA percentage of span.

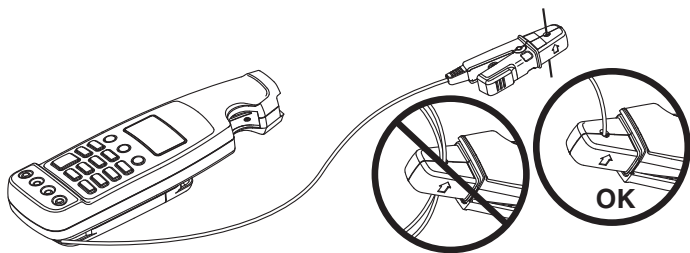

fjv03.eps

Figure 6. Taking Measurements with the Clamp

To use the test leads for measurements:

1. Insert the test leads into the proper input jacks. See Figure 7.
2. Press the correct button for the measurement.
3. Apply the test leads.
4. Observe the reading on the main display. In mA mode, the secondary display shows the reading in percentage of span.

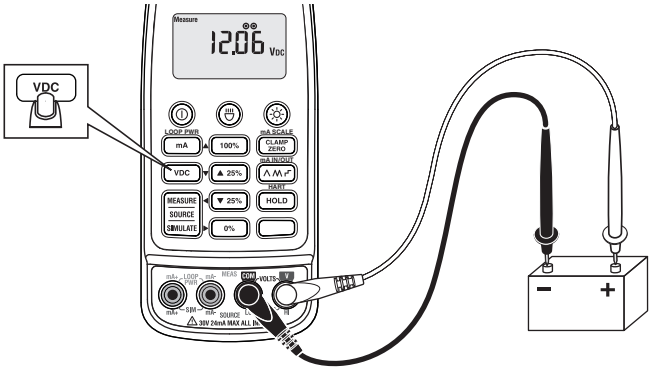

fjv09.eps

Figure 7. Taking Measurements with the Test Leads

Current and Voltage Output Functions



Both Meters provide steady, stepped, and ramped current output for testing 0-24 mA current loops. Additionally, the 773 provides voltage output to 10 V. To access these functions, press  as necessary.

- Choose Source mode to supply current or voltage.
- Choose Simulate mode to regulate current in an externally powered current loop.
- Choose Loop Supply mode to power an external device and measure mA loop current.

Sourcing mA

Use mA Source mode whenever it is necessary to source current into a passive circuit such as a current loop with no loop supply. Source mode depletes the battery faster than Simulate mode.

To enter Source mode for the 772, see Figure 4:

1. Insert the test leads into the -mA and +mA jacks.
2. Press .
3. Press  until **Source** appears on the display.

To enter mA Source mode for the 773, see Figure 8:

1. Insert the test leads into the desired input jacks.
2. Press **mA**.
3. Press **MEASURE SOURCE SIMULATE** until **Source** appears on the display.

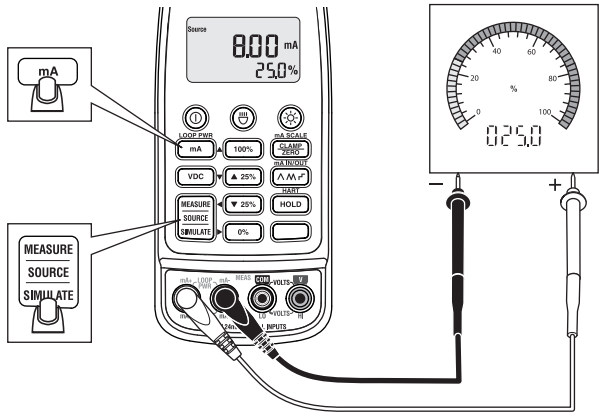

Fjv10.eps

Figure 8. Sourcing mA Output

Simulating mA Output

In Simulate mode, the Meter simulates a current loop transmitter. To enter Simulate mode, see Figure 9:

1. Insert the test leads into the mA+ and mA- input jacks.
2. Press **mA**.
3. Press **MEASURE SOURCE SIMULATE** until **Simulate** appears on the display.

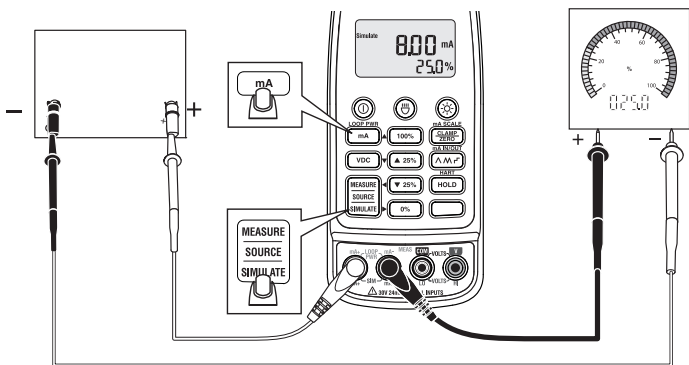

Fjv11.eps

Figure 9. Simulating mA Output

Loop Supply

In Loop Supply mode, the Meter powers a transmitter while measuring the mA signal. To enter Loop Supply mode, see Figure 10:

1. Insert the test leads into the **LOOP PWR** jacks. See Figure 10.
2. Press
3. Press

The Meter is now in Loop Supply mode.

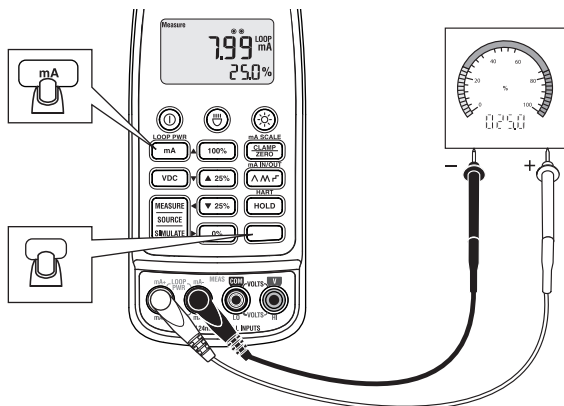

Fjv13.eps

Figure 10. Using Loop Supply Mode

Maintenance

⚠ ⚠ Warning

To avoid possible electric shock or personal injury, repairs or servicing not covered in this manual should be performed only by qualified personnel.

Cleaning the Meter

⚠ ⚠ Warning

To avoid electrical shock, remove any input signals before cleaning.

⚠ Caution

To avoid damaging the Meter, do not use aromatic hydrocarbons or chlorinated solvents for cleaning. These solutions will react with the plastics used in the Meter.

Clean the instrument case with a damp cloth and mild detergent.

Battery Replacement

⚠ ⚠ Warning

To avoid false readings, that could lead to possible electric shock or personal injury, replace the batteries as soon as the low battery indicator (🔋) appears.

To replace the batteries, see Figure 10:

1. Turn the Meter off.
2. Use a flat head screwdriver to loosen the battery compartment door screw, and remove the door from the case bottom.
3. Remove the batteries.
4. Replace the batteries with four new AA batteries.
5. Reattach the battery compartment door to the case bottom and tighten the screw.

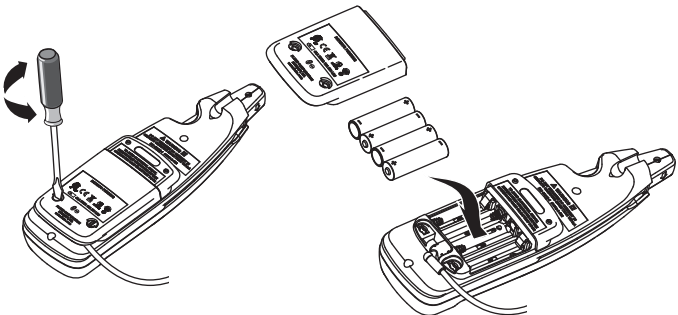

Figure 11. Changing the Batteries

Specifications

Electrical Specifications

Current Measurement

With Jaw

Ranges	0-20.99 mA; 21-100 mA
Resolution.....	0.01 mA; 0.1 mA
Accuracy.....	0.2 % + 5 counts; 1 % + 5 counts

In Circuit

Range	0-24 mA
Resolution.....	0.01 mA
Accuracy.....	0.2 % + 2 counts

Current Source

Range	0-24 mA
Resolution.....	0.01 mA
Accuracy.....	0.2 % + 2 counts
mA Drive.....	24 mA into 1000 Ω

Current Simulate

Range	0-24 mA
Resolution.....	0.01 mA
Accuracy.....	0.2 % + 2 counts
Maximum Voltage	50 V

DC Voltage Measurement (773)

Range	0-30 V
Resolution.....	0.01 V
Accuracy.....	0.2 % + 2 counts

DC voltage source (773)

Range	0-10 V
Resolution.....	0.01 V
Accuracy.....	0.2 % + 2 counts
mA Drive.....	2 mA max all conditions

mA IN/OUT (773)

Sourcing range	0-24 mA
Sourcing resolution	0.01 mA
Sourcing accuracy	0.2 % + 2 counts
Measurement range.....	0-24 mA
Measurement resolution	0.01 mA
Measurement accuracy	1 % FS

Scaled mA current output to mA current input from the Jaw (773)

Range	0-24 mA
Resolution.....	0.01 mA
Accuracy.....	1 % FS

Response speed

2 times per second

DC Loop Power.....

24 V

Influence of Earth's Field.....

<0.20 mA

Batteries.....

4 1.5 V, Alkaline , IEC LR6

Working hours.....

12 hours @ 12 mA sourced into 500 Ω

Mechanical Specifications

Size (H X W X L)

43.7 mm x 70 mm x 246.2 mm



Weight.....

410 g

Environmental Specifications

Operating Temperature	-10 ~50 °C
Storage Temperature.....	-25 ~60 °C
Operating Humidity	<90 % RH @ <30 °C ; <75 % RH @ 30 ~50 °C
Operating Altitude	0 ~ 2000 m
IP Rating	IP 40
Vibration Requirements	Random 2 g, 5 to 500 Hz
Drop Test Requirements	1 meter drop test (except the jaw)
EMI, RFI, EMC	Meets all applicable requirements in EN61326-1
	Note: For current measurement w/jaw, add 1 mA to specification for EMC field strengths of 1 V/m up to 3 V/m.
Temperature Coefficients	0.1/(°C X Specified accuracy for Temperature <18 °C or > 28 °C)

Standards and Agency Approval Specifications

All products certified to the following:
EN / IEC 61010-1, EN / IEC 61010-2-032
Agency Approvals   

Miscellaneous Specifications

Power Requirements.....	Four AA batteries, Alkaline , IEC LR6
Automatic Time-out (Power).....	After 15 minutes ±1 minutes
Automatic Time-out (Backlight) ..	After 2 minutes ±10 seconds
Automatic Time-out (Measurement Spotlight).....	After 2 minutes ±10 seconds

User Replaceable Parts

Table 2 lists all user replaceable parts.

Table 2. Replaceable Parts

Part or Model Number	Description	Quantity
376756	AA Batteries, 1.5 V	4
3369914	Absorber	1
3350978	Battery door	1
948609	Fastener	2
3351060	Soft Carrying Case	1
3351049	Instruction Sheet	1
3362376	Service Information Sheet	1
1616705	TL940 Mini Hook with Test Lead	1 Set
855742	TL75- Test Leads	1 Set
1670095	AC72 Detachable Clip	2
3031302	Velcro Strip	1
669967	TPAK, Strap 17 inches	1
337574	Hanger	1
Replacement clamp and cable assembly are available but require re-calibration. See the 772/773 <i>Service Information Sheet</i> for part numbers and procedures.		

LIMITED WARRANTY & LIMITATION OF LIABILITY

This Fluke product will be free from defects in material and workmanship for 3 years (one year for cable and clamp) from the date of purchase. This warranty does not cover fuses, disposable batteries or damage from accident, neglect, misuse or abnormal conditions of operation or handling. Resellers are not authorized to extend any other warranty on Fluke's behalf. To obtain service during the warranty period, send your defective product to the nearest Fluke Authorized Service Center with a description of the problem.

THIS WARRANTY IS YOUR ONLY REMEDY. NO OTHER WARRANTIES, SUCH AS FITNESS FOR A PARTICULAR PURPOSE, ARE EXPRESSED OR IMPLIED. FLUKE IS NOT LIABLE FOR ANY SPECIAL, INDIRECT, INCIDENTAL OR CONSEQUENTIAL DAMAGES OR LOSSES, ARISING FROM ANY CAUSE OR THEORY. Since some states or countries do not allow the exclusion or limitation of an implied warranty or of incidental or consequential damages, this limitation of liability may not apply to you.