

REVISION HISTORY					
ECO	ZONE	REV.	DESCRIPTION	DATE	APPR'D

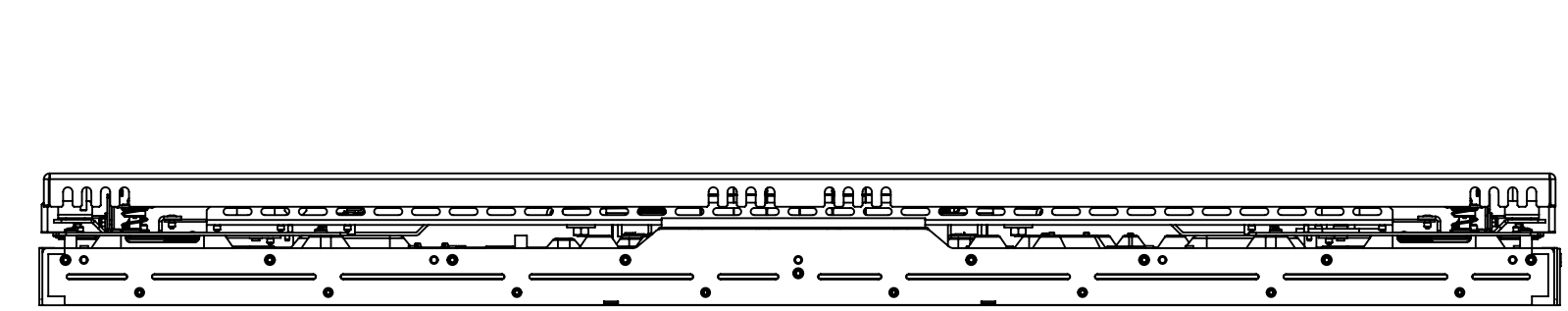

WITH MOUNT

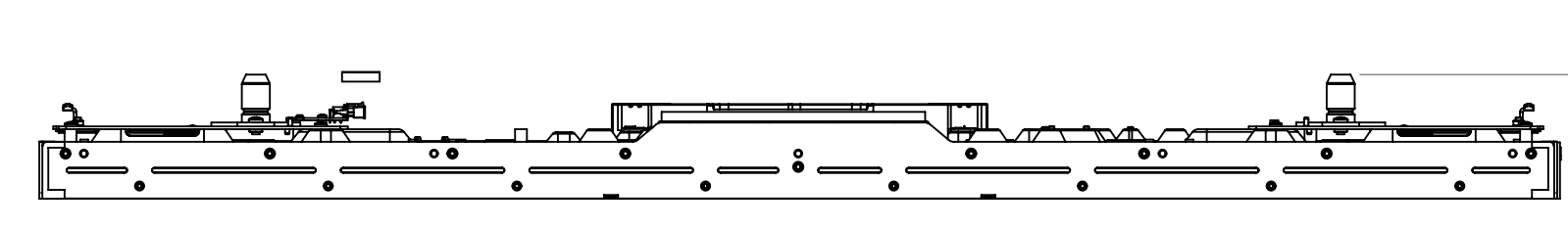

TOP VIEW

[3.30]  
83.9

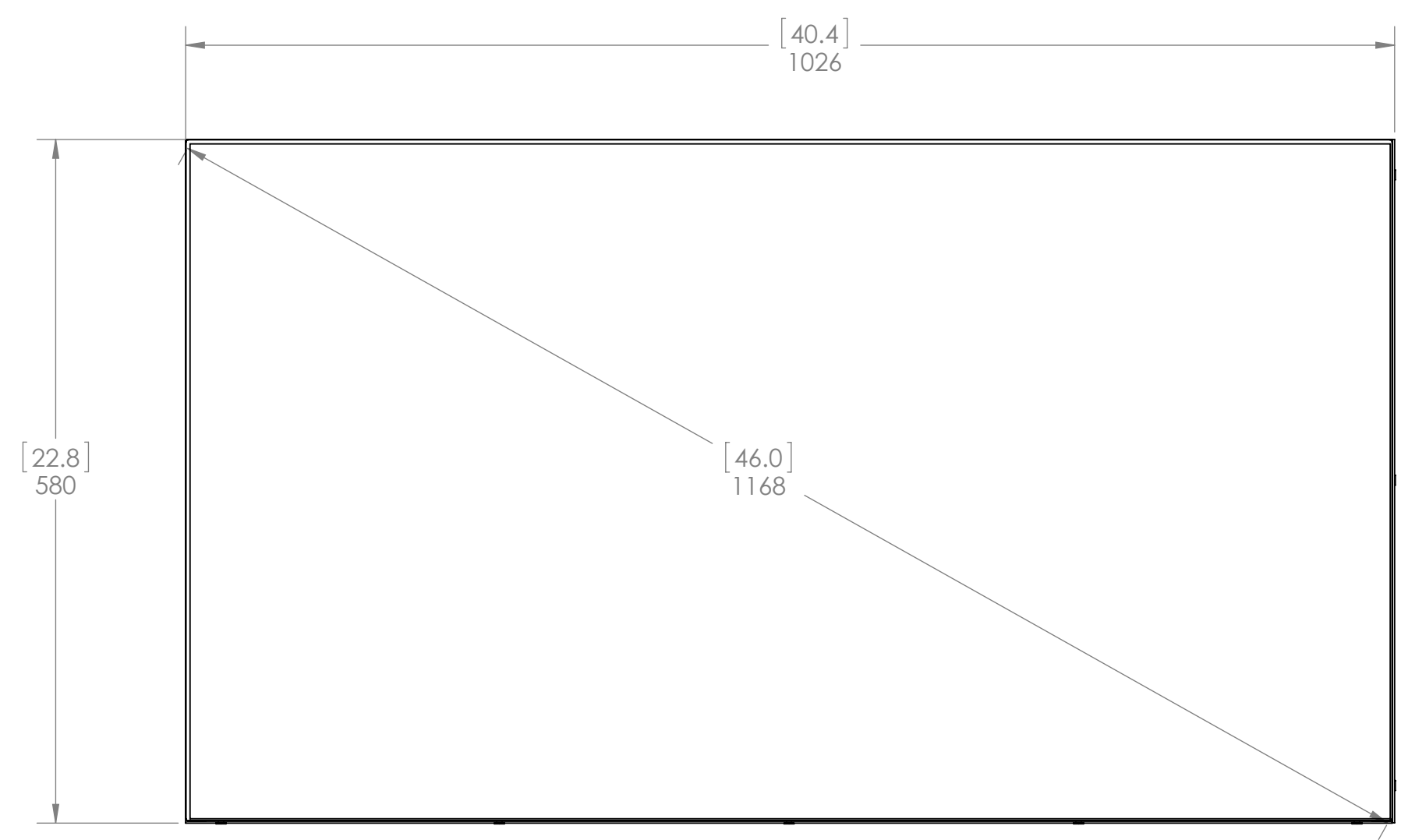

FRONT VIEW

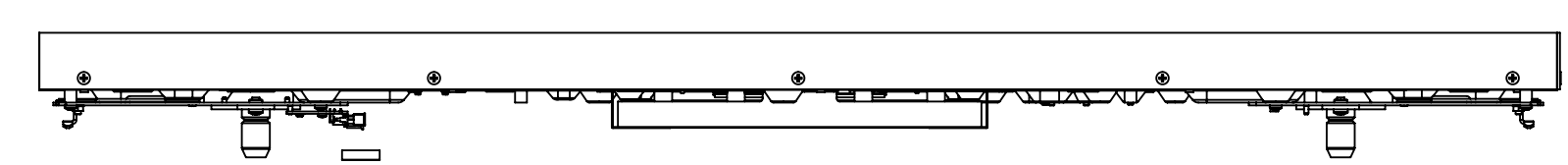

BOTTOM VIEW

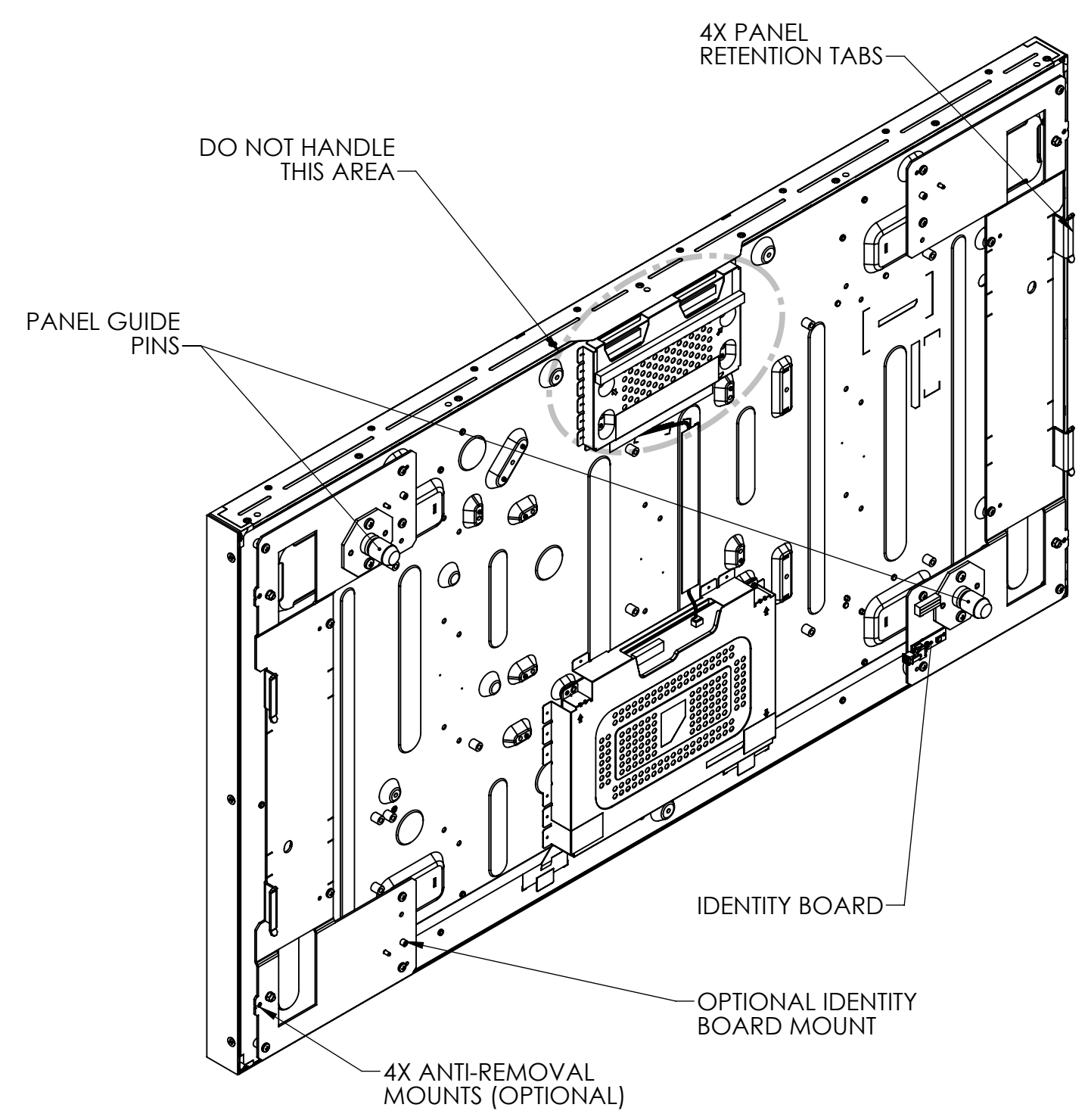

DO NOT HANDLE THIS AREA

PANEL GUIDE PINS

4X PANEL RETENTION TABS

IDENTITY BOARD

OPTIONAL IDENTITY BOARD MOUNT

4X ANTI-REMOVAL MOUNTS (OPTIONAL)

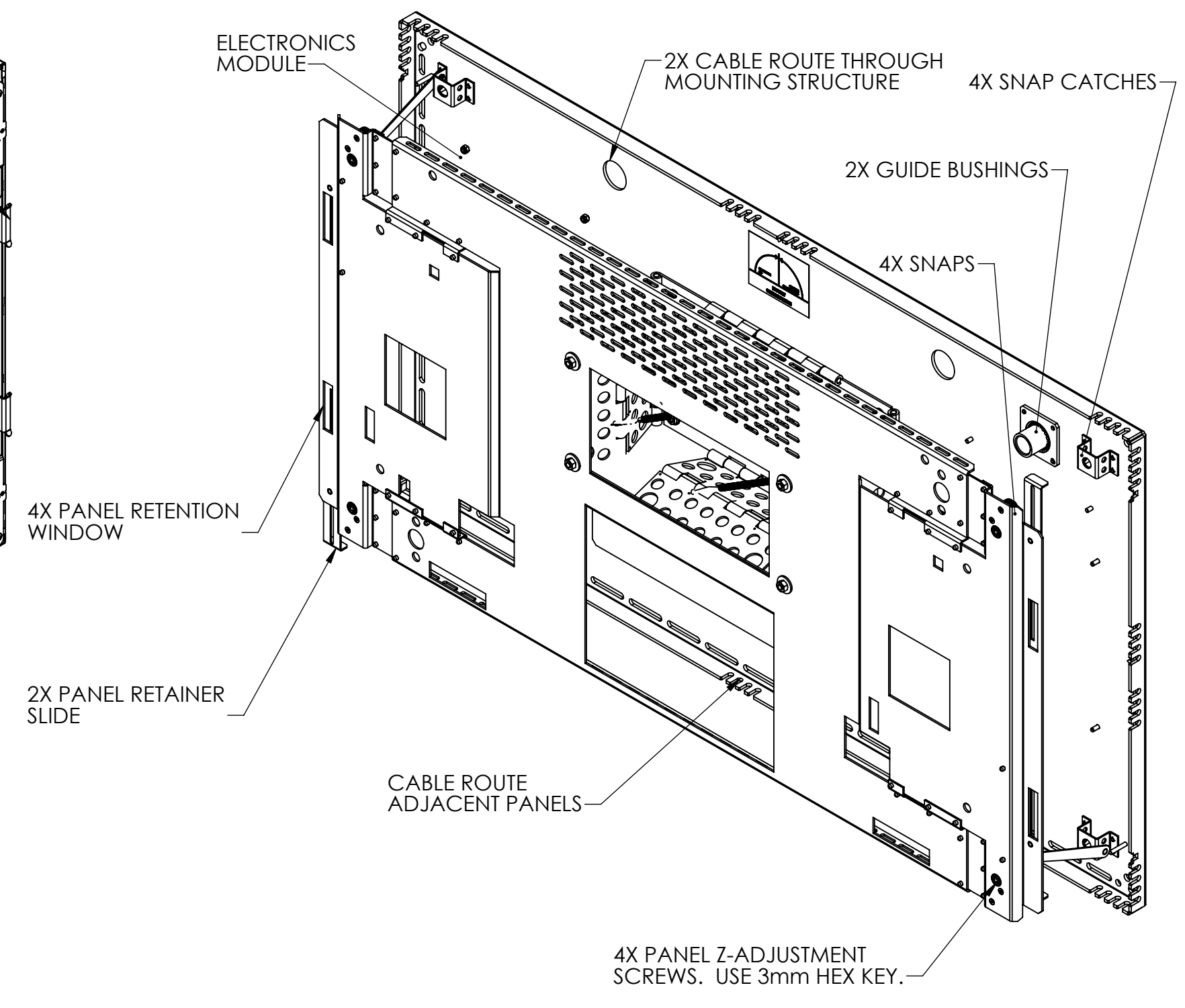

ELECTRONICS MODULE

2X CABLE ROUTE THROUGH MOUNTING STRUCTURE

4X SNAP CATCHES

2X GUIDE BUSHINGS

4X SNAPS

4X PANEL RETENTION WINDOW

2X PANEL RETAINER SLIDE

CABLE ROUTE ADJACENT PANELS

4X PANEL Z-ADJUSTMENT SCREWS. USE 3mm HEX KEY.

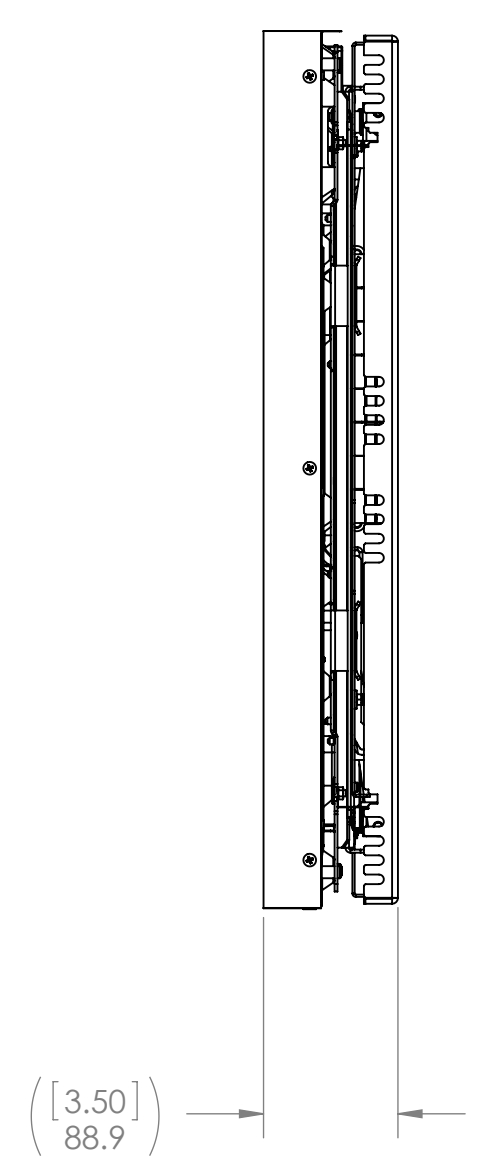

[3.50]  
88.9

SIDE VIEW WITH MOUNT

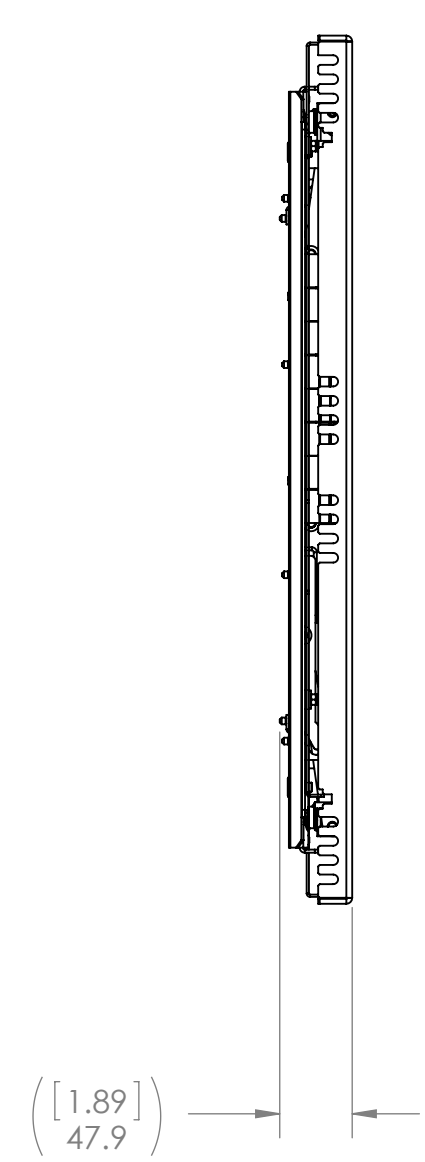

[1.89]  
47.9

SIDE VIEW MOUNT

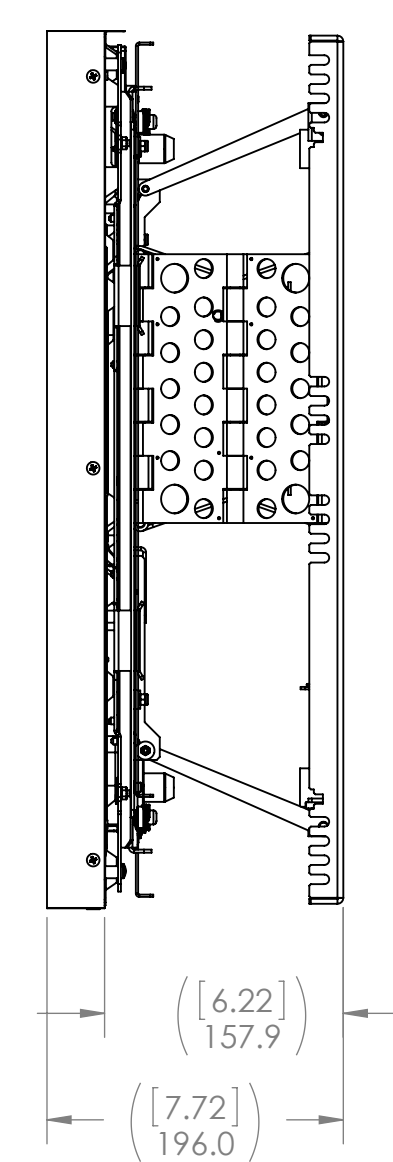

[6.22]  
157.9

[7.72]  
196.0

SIDE VIEW EXTENDED

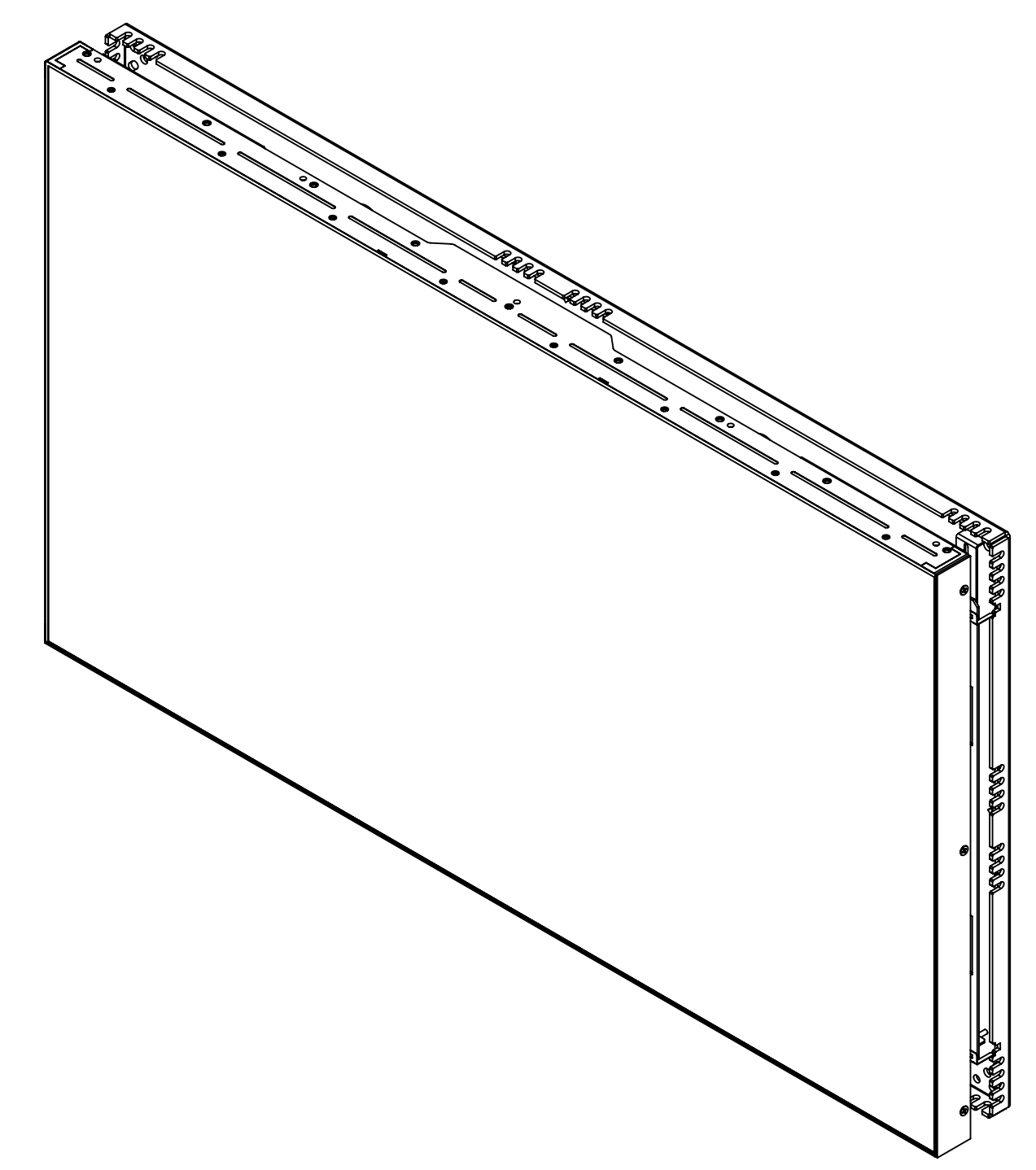

- ATTACH PANEL CABLES TO ELECTRONICS BEFORE FULLY INSTALLING PANEL.
  - SPECIFICATIONS SUBJECT TO CHANGE WITHOUT NOTICE.
- NOTES: UNLESS OTHERWISE SPECIFIED.



205 Westwood Ave, Long Branch, NJ 07740  
 Phone: 866-94 BOARDS (26273) / (732)-222-1511  
 Fax: (732)-222-7088 | E-mail: sales@touchboards.com

UNLESS OTHERWISE SPECIFIED: DIMENSIONS ARE IN MILLIMETERS (INCHES)		ENGR BY EJS	02MAY12		PLANAR SYSTEMS, INC. 1195 NW COMPTON DRIVE BEAVERTON, OR 97006 USA
TOLERANCES:		DRAWN BY EJS	02MAY12		
X= ±1	XX= ±.25	CHECKED BY		TITLE AD46 PRODUCT OUTLINE	
X= ±.5	∠= ±1°	USED ON		SIZE D	REV 04
DIMENSIONING AND TOLERANCING PER ASME Y14.5M-1994		MATERIAL		SCALE 1:5	SHEET 1 OF 2
THIRD ANGLE PROJECTION		FINISH		DO NOT SCALE	

THIS DRAWING CONTAINS INFORMATION PROPRIETARY TO PLANAR SYSTEMS, INC. ANY REPRODUCTION IN PART OR WHOLE WITHOUT THE WRITTEN PERMISSION OF PLANAR SYSTEMS IS PROHIBITED. THIS DRAWING IS SUPPLIED FOR INFORMATION, IDENTIFICATION, ENGINEERING, EVALUATION, AND/OR INSPECTION PURPOSES ONLY AND MAY NOT BE USED AS BASIS FOR THE MANUFACTURING OF PRODUCTS OR THE FURNISHING OF SERVICES TO PLANAR SYSTEMS OR TO ANY THIRD PARTY UNLESS AUTHORIZED IN WRITING BY PLANAR SYSTEMS.



205 Westwood Ave, Long Branch, NJ 07740  
 Phone: 866-94 BOARDS (26273) / (732)-222-1511  
 Fax: (732)-222-7088 | E-mail: sales@touchboards.com

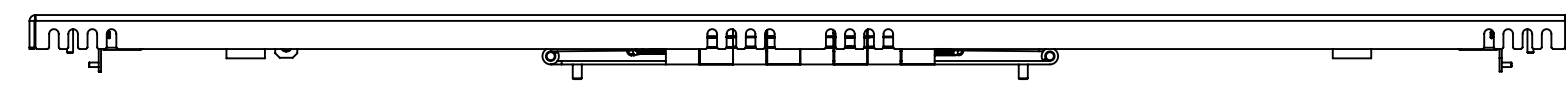

2X M3X0.5 STUDS FOR  
 RETAINING BAR ATTACHMENT  
 TO INTERFACE PLATE

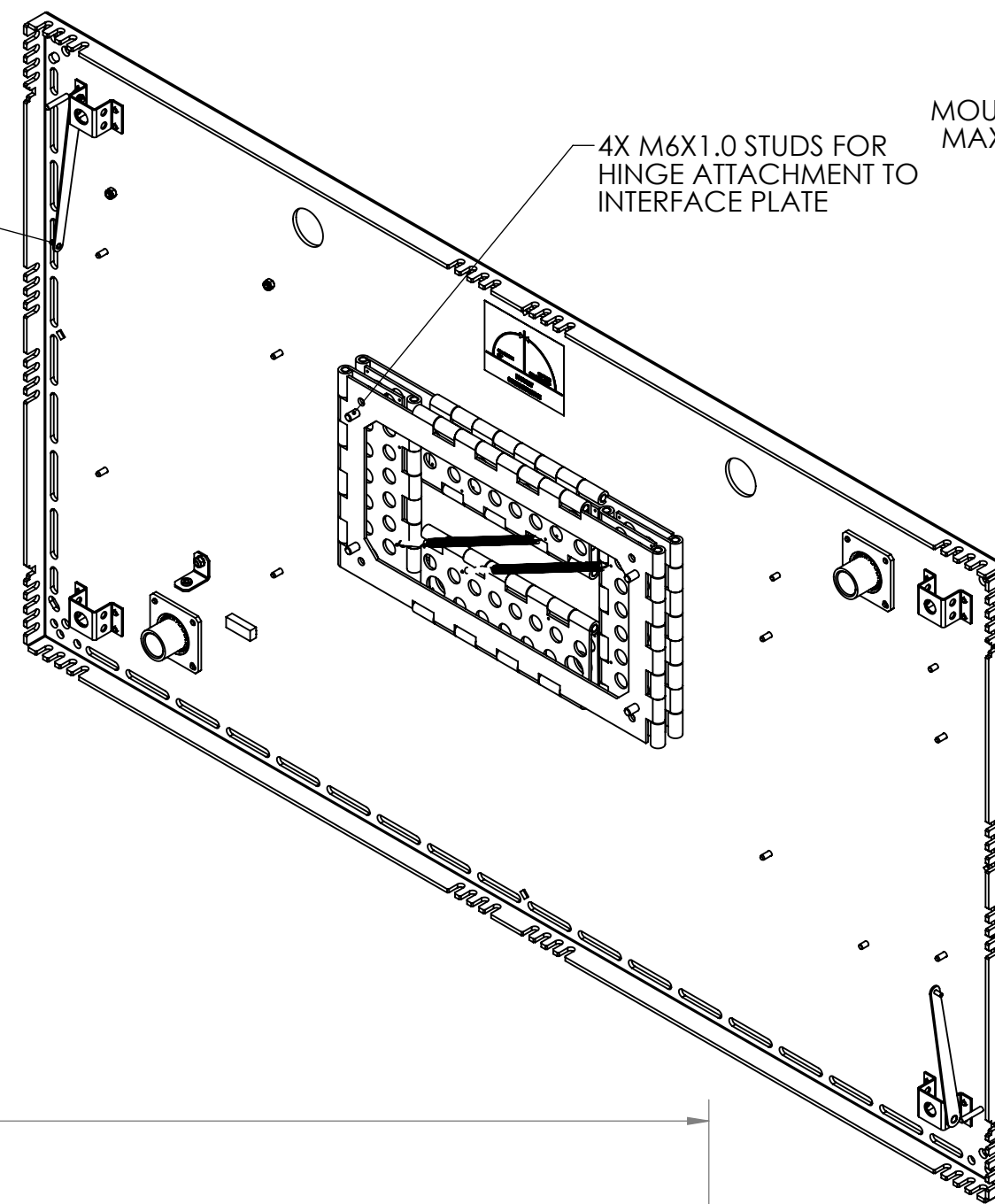

4X M6X1.0 STUDS FOR  
 HINGE ATTACHMENT TO  
 INTERFACE PLATE

MOUNT ORIENTATION IS AS SHOWN TO  
 MAX 90° ROTATED EITHER CLOCKWISE  
 OR COUNTER-CLOCKWISE

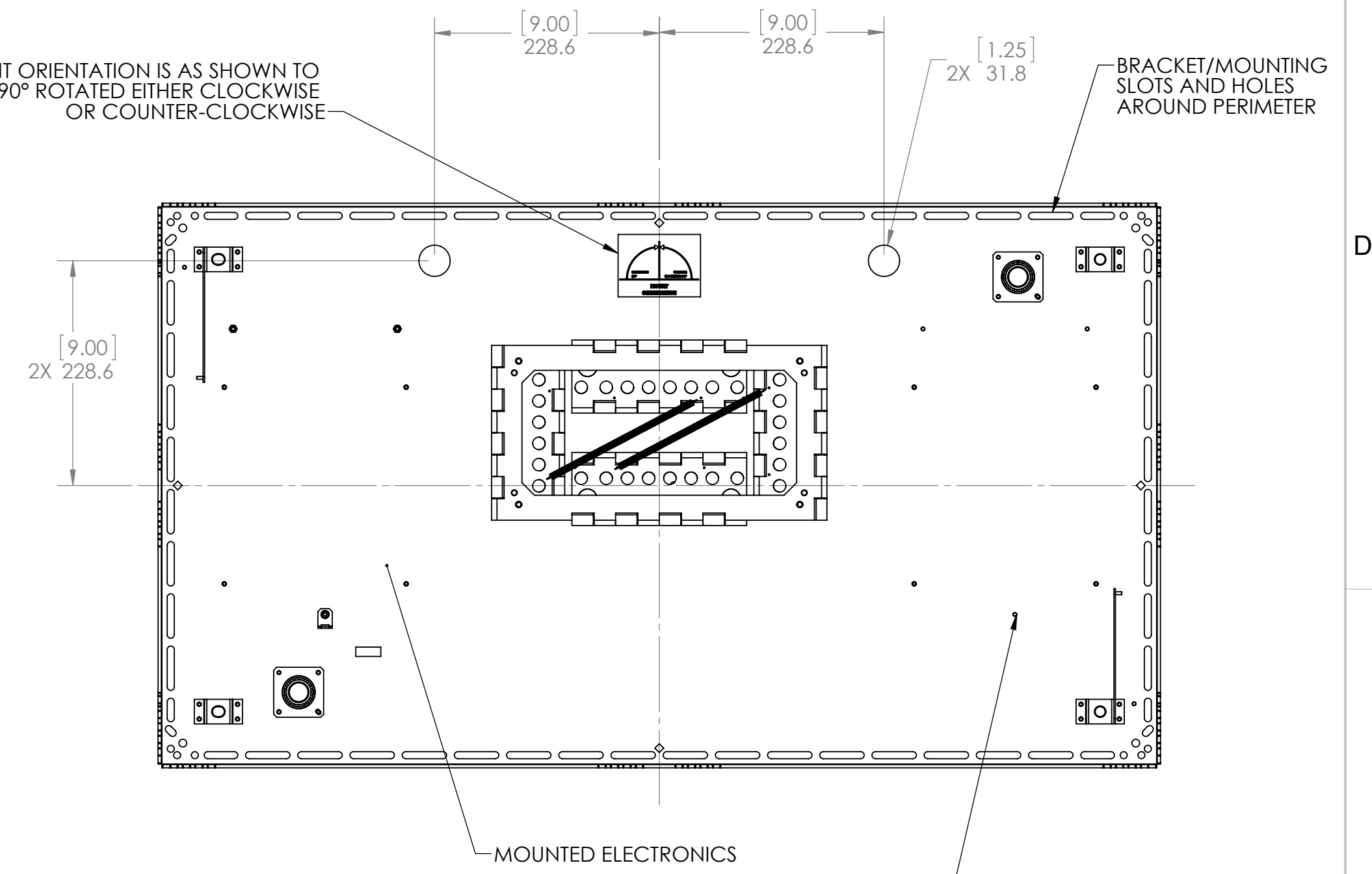

MOUNTED ELECTRONICS

OPTIONAL LOCATION  
 FOR ELECTRONICS

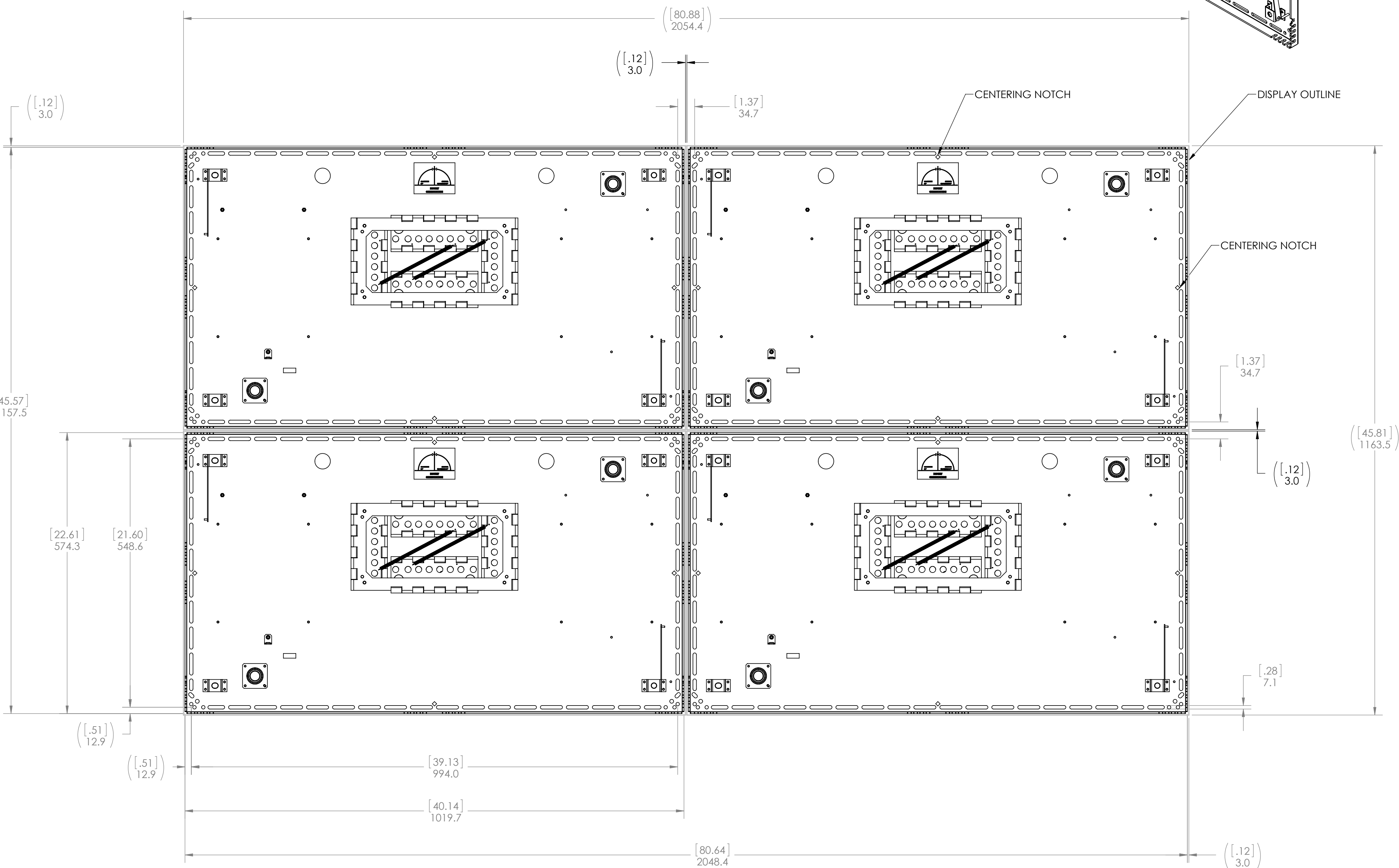

8. AT A MINIMUM MOUNT TO STRUCTURE NEAR CORNERS.
  7. DISPLAY PORT IN COMES FROM THE SOURCE OR OUTPUT OF PREVIOUS PANEL IN ARRAY. 48V IN COMES FROM THE POWER SUPPLY OR OUTPUT OF PREVIOUS PANEL IN ARRAY.
  6. ROUTE WALL CABLES (POWER AND DISPLAY PORT) AFTER ALL MOUNTS ARE INSTALLED.
  5. PANEL MOUNTS CAN BE ROTATED CLOCKWISE 90° AND COUNTERCLOCKWISE 90°.
  4. USE SPACER BRACKETS TO SPACE OFF UNEVEN WALLS (PROVIDED).
  3. ALIGNMENT BRACKETS ARE AVAILABLE FOR THE SPACING SHOWN (OPTIONAL).
  2. FOR BEST RESULTS, BE SURE PANEL MOUNTS ARE MOUNTED FLAT TO SURFACE.
  1. SPECIFICATIONS SUBJECT TO CHANGE WITHOUT NOTICE.
- NOTES: UNLESS OTHERWISE SPECIFIED.

UNLESS OTHERWISE SPECIFIED DIMENSIONS ARE IN MILLIMETERS (INCHES)		ENGR BY EJS	02MAY12		PLANAR SYSTEMS, INC. 1195 NW COMPTON DRIVE BEAVERTON, OR 97006 USA
TOLERANCES:		DRAWN BY EJS	02MAY12		
X= ±1	XX= ±.25	CHECKED BY		TITLE MOSAIC AD46 MOUNT BRACKET LAYOUT STANDARD 2mm SPACING	
X= ±.5	∠= ±1°	USED ON		SIZE D	REV 04
DIMENSIONING AND TOLERANCING PER ASME Y14.5M-1994		MATERIAL		SCALE 1:5	SHEET 2 OF 2
THIRD ANGLE PROJECTION		FINISH		DO NOT SCALE	

THIS DRAWING CONTAINS INFORMATION PROPRIETARY TO PLANAR SYSTEMS, INC. ANY REPRODUCTION IN PART OR WHOLE WITHOUT THE WRITTEN PERMISSION OF PLANAR SYSTEMS IS PROHIBITED. THIS DRAWING IS SUPPLIED FOR INFORMATION, IDENTIFICATION, ENGINEERING, EVALUATION, AND/OR INSPECTION PURPOSES ONLY AND MAY NOT BE USED AS BASIS FOR THE MANUFACTURING OF PRODUCTS OR THE FURNISHING OF SERVICES TO PLANAR SYSTEMS OR TO ANY THIRD PARTY UNLESS AUTHORIZED IN WRITING BY PLANAR SYSTEMS.