

■ DIGITAL ANALOG
MEGOHMMETERS

1035

1039

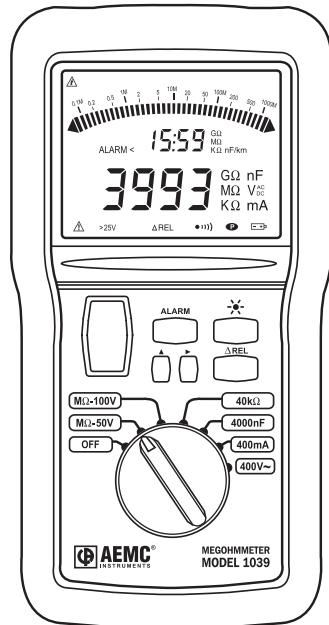
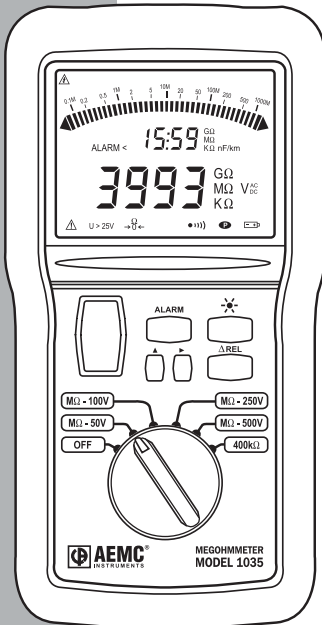

Owner's Record

The serial number for the Model 1035 and 1039 is located outside on the front of the instrument. Please record this number and purchase date for your records.

MEGOHMMETER MODEL 1035

CATALOG #: 2116.90

SERIAL #: _____

PURCHASE DATE: _____

DISTRIBUTOR: _____

MEGOHMMETER MODEL 1039

CATALOG #: 2116.91

SERIAL #: _____

PURCHASE DATE: _____

DISTRIBUTOR: _____

Table of Contents

1. INTRODUCTION	3
1.1 International Electrical Symbols	4
1.2 Definition of Measurement Categories	4
1.3 Receiving Your Shipment	4
1.4 Ordering Information	5
1.4.1 Accessories and Replacement Parts	5
2. PRODUCT FEATURES	6
2.1 Description	6
2.2 Model 1035 Control Features	7
2.3 Model 1039 Control Features	8
2.4 LCD Display Symbols	9
2.4.1 Digital Display Symbols	9
2.4.2 Analog Bargraph	9
2.5 Button Functions	10
2.5.1 Yellow Push Button	10
2.5.2 ALARM Button	10
2.5.3 Cursor Button	10
2.5.4 Scroll Cursor Button	11
2.5.5 Backlight Button 	11
2.5.6 ΔREL Button	11
2.6 Measurement Functions	12
2.6.1 AC/DC Voltage Measurement - Safety Check	12
2.6.2 Insulation Resistance Testing	12
2.6.3 Resistance	13
2.6.4 Capacitance (1039)	13
2.6.5 AC/DC Current (1039)	14
2.6.6 AC Voltage (1039)	14
2.7 Special Functions	15
2.7.1 Battery Life Indication	15
2.7.2 Auto-Off	15
2.7.3 Battery Auto Test	15
2.7.4 Fuse (1039)	16
2.7.5 Buzzer	16
2.7.6 Alarm Setpoints	17

2.7.7	Relative Measurements (Δ REL)	19
2.7.8	Programming the Capacitance per Unit Length (1039)	19
3.	SPECIFICATIONS	20
3.1	Electrical Specifications	20
3.1.1	Voltage	20
3.1.2	Insulation	20
3.1.3	Resistance	21
3.1.4	Capacitance (1039)	21
3.1.5	Distance (1039)	22
3.1.6	AC/DC Current (1039)	22
3.1.7	AC Voltage (1039)	22
3.1.8	Power Supply	22
3.2	Mechanical Specifications	23
3.3	Environmental Conditions	23
3.4	Safety Specifications	24
4.	OPERATION	25
4.1	Operation	25
4.2	AC/DC Voltage and Insulation Measurement	25
4.3	Resistance Measurement	26
4.4	Capacitance Measurement (1039)	26
4.5	AC/DC Current Measurement (1039)	26
4.6	AC Voltage Measurement (1039)	27
4.7	Application Examples	28
4.7.1	Insulation Measurements on Installations	28
4.7.2	Insulation Measurements on Cables	28
4.7.3	Insulation Measurements on Motors	29
5.	MAINTENANCE	30
5.1	Battery Replacement	30
5.2	Fuse Replacement (1039)	30
5.3	Cleaning	30
5.4	Storage	30
	Repair and Calibration	31
	Technical and Sales Assistance	31
	Limited Warranty	32
	Warranty Repairs	32





INTRODUCTION

Warning

These safety warnings are provided to ensure the safety of personnel and proper operation of the instrument.

- Read the instruction manual completely and follow all safety information before operating this instrument.
- Safety is the responsibility of the operator!
- Tests are to be carried out only on non-energized circuits! Check for live circuits before making resistance measurements (safety check).
- The Megohmmeter Models 1035 and 1039 are sources of high voltage, as is the sample connected to them. All persons performing or assisting in the tests must employ all safety precautions to prevent electrical shock to themselves and to others.
- AEMC® considers the use of rubber gloves to be an excellent safety practice even if the equipment is properly operated and correctly grounded.
- When testing capacitance samples, make sure that they have been properly discharged and that they are safe to touch. Dielectric insulation samples should be short-circuited for at least five times the amount of time they were energized.
- Megohmmeters should never be used in an explosive environment.
- Use the leads supplied with the megohmmeters. If they are defective or worn, replace before testing.
- NEVER use the megohmmeters on electrical conductors rated above 600V in overvoltage category III (CAT III).

1.1 International Electrical Symbols

	This symbol signifies that the instrument is protected by double or reinforced insulation.
	This symbol on the instrument indicates a WARNING and that the operator must refer to the user manual for instructions before operating the instrument. In this manual, the symbol preceding instructions indicates that if the instructions are not followed, bodily injury, installation/sample and product damage may result.
	Risk of electric shock. The voltage at the parts marked with this symbol may be dangerous.
	In conformity with WEEE 2002/96/EC

1.2 Definition of Measurement Categories

- Cat. I:** For measurements on circuits not directly connected to the AC supply wall outlet such as protected secondaries, signal level, and limited energy circuits.
- Cat. II:** For measurements performed on circuits directly connected to the electrical distribution system. Examples are measurements on household appliances or portable tools.
- Cat. III:** For measurements performed in the building installation at the distribution level such as on hardwired equipment in fixed installation and circuit breakers.
- Cat. IV:** For measurements performed at the primary electrical supply (<1000V) such as on primary overcurrent protection devices, ripple control units, or meters.

1.3 Receiving Your Shipment

Upon receiving your shipment, make sure that the contents are consistent with the packing list. Notify your distributor of any missing items. If the equipment appears to be damaged, file a claim immediately with the carrier and notify your distributor at once, giving a detailed description of any damage. Save the damaged packing container to substantiate your claim. Do not use an instrument that appears to be damaged.

1.4 Ordering Information

Model 1035 **Cat. #2116.90**

Includes soft carrying case, 3 color-coded leads, 1 black test probe, 3 alligator clips, 2 grip probes, batteries and user manual.

Model 1039 **Cat. #2116.91**

Includes soft carrying case, 2 color-coded leads, 1 black test probe, 2 alligator clips, 2 grip probes, batteries and user manual.

Model 1035 Field Kit **Cat. #2115.42**

Includes meter, field case, 3 color-coded leads, black test probe, 3 alligator clips, 2 grip probes, remote test probe, batteries and user manual.

Model 1039 Field Kit **Cat. #2115.43**

Includes meter, field case, 2 color-coded leads, black test probe, 2 alligator clips, 2 grip probes, remote test probe, AC current probe, batteries and user manual.

1.4.1 Accessories and Replacement Parts

Remote Test Probe **Cat. #2118.97**

Soft Carrying Pouch **Cat. #2119.02**

Set of 5 Fuses, 600V, 0.63A, ¼ x 1¼" (6x32mm)..... **Cat. #2970.78**

Field Case (Waterproof) **Cat. #2118.98**

Hands Free Carrying Case **Cat. #2118.99**

AC Current Probe MN211 (Lead - 1mA/A - 240A max) **Cat. #2115.73**

Model 1035 Replacement Lead Set **Cat. #2119.41**

Includes 3 color-coded leads, black test probe, 3 alligator clips, 2 grip probes.

Model 1039 Replacement Lead Set **Cat. #2119.40**

Includes 2 leads, 1 black test probe, 2 alligator clips and 2 grip probes.

Order Accessories and Replacement Parts Directly Online

Check our Storefront at www.aemc.com/store for availability

PRODUCT FEATURES

2.1 Description

These portable instruments function with batteries. They can be used to check insulation and voltages, and to measure resistances. The 1039 can also be used for:

- measurement of the capacitance of a telephone line
- current measurement
- measurement of the pure alternating component of a DC voltage

These megohmmeters help to ensure the safety of electrical and telephone installations. The acquisition, processing and display of the measurements are managed by a microprocessor. They offer a wide range of advantages such as:

- automatic detection of the presence of a dangerous voltage on the terminals in $M\Omega$ ranges (all insulation measurement blocked if $V > 25V$)
- protection of the instrument against external voltage surges
- operator safety by means of automatic discharge of the high voltage on the equipment tested
- display of the difference compared to a measurement value in memory
- measurement of the length of a telephone line according to its capacitance per km unit length (1039)
- automatic shutdown of the instrument to save the batteries and indication of the battery charge
- fuse testing by periodic checks during current measurement (1039)
- a large backlit LCD screen with a wide range of indicators making it very easy for the user to read

2.2 Model 1035 Control Features

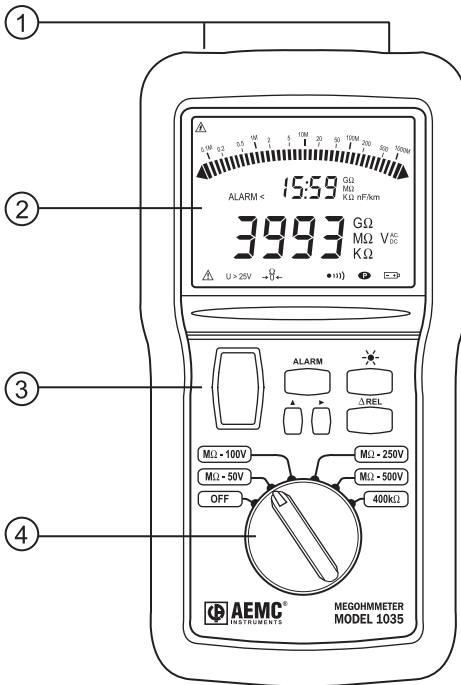

Figure 1

1. Safety terminals - \varnothing 4mm (marked “+” and “G”) and a 3-Point socket for connecting the remote control
2. Backlight liquid crystal display
3. Buttons: Yellow (to activate insulation measurement) ALARM, ▲, ►, ✨ and Δ REL (see § 2.7)
4. 6-position switch:
OFF, M Ω - 50V, M Ω - 100V, M Ω - 250V, M Ω - 500V, 400k Ω
5. Battery compartment and stand (not shown in drawing)

2.3 Model 1039 Control Features

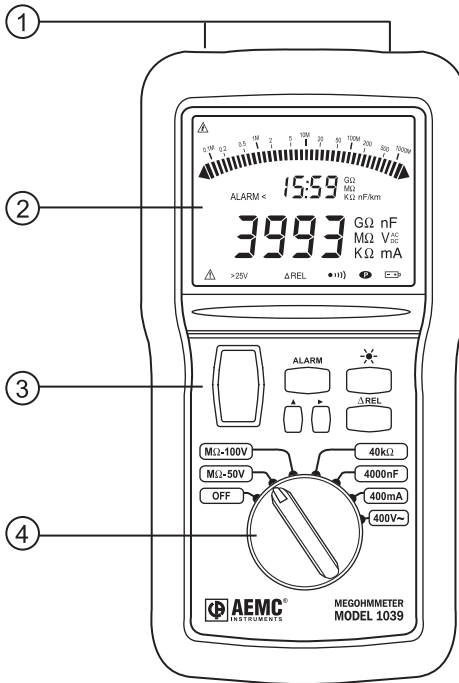

Figure 2

1. Safety terminals - \varnothing 4mm (marked “mA”, “+” and “-”). Next to the “-” terminal, there are two additional contacts for connecting the remote control probe (3-Point connector).
2. Backlight liquid crystal display
3. Buttons: Yellow (to activate insulation measurement) ALARM, \blacktriangle , \blacktriangleright , \star and Δ REL (see § 2.7)
4. 7-position switch:
OFF, $M\Omega$ - 50V, $M\Omega$ - 100V, 40k Ω , 4000nF, 400mA, 400V~
5. Battery compartment and stand (not shown in the drawing)

2.4 LCD Display Symbols

2.4.1 Digital Display Symbols



Timer On

ALARM Alarm On

> High Limit Trigger

< Low Limit Trigger



Test Voltage On

- Negative Value



Refer to User Manual

FUS Fuse Open

>25V Measured Voltage >25V



Lead, Resistance Zeroing

•)) Active Buzzer



Permanent Run –
Auto-Off Disabled



Low Battery

nF nanoFarad

Km Kilometers

ΔREL Relative Position

BAT Batteries low – must be replaced

OL Over Range - Over Load

--- Insulation < 10kΩ at 50V, < 20kΩ at 100V,
< 50kΩ at 250V, < 100kΩ at 500V

2.4.2 Analog Bargraph



Insulation > 1.1GΩ



Insulation < 70kΩ

2.5 Button Functions

2.5.1 Yellow Push Button

The yellow button is used to initiate the test voltage when measuring insulation resistance. In any function setting (except OFF), the megohmmeter is in the voltage mode and works as a voltmeter to detect if any voltage is present on the tested sample. If a voltage greater than 25V is detected, the yellow test button is disabled and insulation testing is not possible.

2.5.2 ALARM Button

The ALARM button can be used to activate/deactivate the alarm thresholds during insulation and resistance measurements.

It is also used with the ► and ▲ selection cursor buttons to adjust the alarm set points.

2.5.3 Cursor Button

When programming the alarm setpoints, the ► cursor button makes the following symbols flash as follows:

- the measurement unit (if applicable),
- the thousands digit,
- the hundreds digit,
- the tens digit,
- the units digit,
- the decimal point,
- the alarm trigger (above or below the setting)
- and it then returns to the measurement units.

The capacitance per unit length in nF/km (with the ✱ button on the 1039). By pressing the ► button, you can make the following elements flash successively:

- the tens digit,
- the units digit,
- and it then returns to the tens digit.

2.5.4 Scroll Cursor Button

When programming the alarm setpoints, the ▲ button is used to scroll through the possible values for each parameter, which flashes:

- MΩ or GΩ for insulation, kΩ or Ω for resistance, for the measurement units,
- 1,2, 3 or _ for the thousands digit,
- 0, 1, 2, 3, 4, 5, 6, 7, 8 and 9 for the hundreds, tens and units,
- “-. - -” or “-.-.-” or “-.-.-” or “-.-.-” for the decimal separator,
- > or < for above or below threshold trigger.
- When programming the capacitance per unit length in nF/km, the ▲ button can be used to change the values of the flashing digits to 0, 1, 2, 3, 4, 5, 6, 7, 8 or 9.

2.5.5 Backlight Button

1035 and 1039: When this button is pressed, the backlighting of the display comes on. It will be turned off automatically one minute later. When it is lit, you can turn the backlighting off by pressing this button again.

1039: When the switch is on 4000nF, a long press on this button enables you to program the unit length value (see § 2.7.8).

2.5.6 ΔREL Button



A long press on this button enables you to memorize a value. The measurements that follow will be the positive or negative deviation compared with the value memorized (does not function for voltage on the MΩ positions).

2.6 Measurement Functions

2.6.1 AC/DC Voltage Measurement - Safety Check

As soon as the switch is set to one of the $M\Omega$ positions, the instrument measures the voltage between its + and - terminals. The value of this voltage is displayed (0 to 600VAC/DC max).

If the voltage present is less than 25V, the insulation can be tested, but the lower the test voltage the greater the possibility of error.

If the voltage is greater than 25V,  and >25V are displayed. Pressing the yellow button will only cause the buzzer to turn on and the  symbol to flash until the button is released.

These warnings only end if the voltage falls below 25V (disconnection of the leads or removal of the voltage) or if the yellow button is released or, naturally, if you turn off the instrument by returning the switch to the OFF position.



WARNING: If the voltage detected is above 600V (outside measurement range), OL will appear on the digital display.

2.6.2 Insulation Resistance Testing

If there is not a dangerous voltage (see above), the user can then measure the insulation by pressing the yellow button. The high voltage is then generated between the terminals (marked + and -). The value of the measurement is shown on the logarithmic scale of the bargraph and on the digital display, with the corresponding $M\Omega$ or $G\Omega$ symbol. As soon as the yellow button is released, the instrument returns to voltage measurement mode.



WARNING: If the voltage generated may be dangerous,  is displayed.

The instrument indicates if the value measured is outside its measurement range. If the measured insulation resistance is greater than $400M\Omega$ (1039), 2 or $20G\Omega$ (1035), the OL symbol is displayed on the digital display instead of a value. When the measurement is greater than $1.1G\Omega$, the ► symbol lights up on the right-hand side of the bargraph. Similarly the digital measurement display indicates “- - -” if the insulation resistance is less than:

Model 1039: 10k Ω at 50V; 20k Ω at 100V

Model 1035: 10k Ω at 50V; 20k Ω at 100V; 50k Ω at 250V; 100k Ω at 500V

When the measurement is less than 70k Ω , only the ◀ symbol lights up on the left-hand side of the bargraph.

To measure high insulation values, you are advised to use the “G” guard terminal to remove the influence of superficial leak currents and “hand capacitance”.

2.6.3 Resistance

Resistance measurement corresponds to the 40k Ω position of the switch on the 1039 and the 400k Ω position on the 1035. The measurement is indicated on the digital measurement display, accompanied by the Ω or k Ω symbol if necessary. The instrument indicates if the value measured is outside its measurement range. If the resistance is greater than 40k Ω or 400k Ω , depending on the instrument, the OL symbol is displayed on the digital measurement display. **A programmed threshold may trigger an alarm** (see pg 18).

2.6.4 Capacitance (1039)

Capacitance measurement corresponds to the 4000nF position of the switch. The measurement is shown on the display accompanied by the nF symbol. The length of the telephone line measured is indicated in km on the digital threshold display, according to the programmed capacitance per unit length.

If the leads are set up in a short circuit, the instrument indicates OL on the digital measurement display and the distance is - - - km.

If the capacitance measurement is greater than 4000nF, the OL symbol is displayed on the digital measurement display.

If the distance measurement is greater than 80km, the OL symbol is displayed on the digital measurement display.

If the leads are not connected, the digital measurement display indicates 0.00.

2.6.5 AC/DC Current (1039)

Current measurement corresponds to the 400mA position of the switch. The measurement is shown on the display accompanied by the mA symbol. The fuse is checked periodically.

If the current measurement is greater than 400mA_{AC/DC}, the OL symbol is displayed on the display. The MN211 Current Probe may be used to extend the measurement range to 200A_{AC}.

2.6.6 AC Voltage (1039)

AC voltage measurement corresponds to the V~ position of the switch. The measurement is shown on the display accompanied by the V_{AC} symbol. In this function, the DC component is not measured.

If the voltage measurement is greater than 400V_{AC}, the OL symbol is displayed on the digital measurement display.

2.7 Special Functions

2.7.1 Battery Life Indication

When you move the switch from the OFF position to one of the function positions, the battery voltage is applied to the circuit. All the display segments light up at the same time for 1 second. Then all the segments go out (for 2 seconds) except the  and the ◀ and ▶ symbols which delimit the size of the bargraph.



The bargraph indicates the battery charge life and the digital measurement display indicates the charge life available (0.00 to 1.00 = 0 to 100%).

The instrument can be turned off at any time by turning the rotary switch to OFF.

2.7.2 Auto-Off



After 5 minutes without any activity, the instrument automatically shuts off. To start up the instrument again, press any one of the buttons, turn the switch, or press the yellow test button on the remote control test probe.

DISABLING/ENABLING THE AUTO-OFF

- To disable the Auto-Off, keep the  button pressed down when turning ON the instrument. The  symbol is then displayed, indicating that the Auto-Off function has been disabled.
- To enable the Auto-off function, turn the instrument OFF and then turn it back ON again. Auto-Off is the default mode.

2.7.3 Battery Auto Test

The battery supply voltage is measured automatically every second. The battery voltage range for correct operation is 7V to 10V. There are four possible cases:

- The voltage is correct: Nothing is displayed.
- The voltage is < 7.1V: the  symbol flashes. Remaining battery life is limited.
- The voltage is < 6.9V: the  symbol remains lit. Measurement accuracy is no longer assured. Replace the batteries.
- The voltage is close to 6.7V: the digital display indicates BAT and then, after 5 seconds, the shutdown buzzer sounds, and the Auto OFF function is activated. The instrument shuts down.

2.7.4 Fuse (1039)

The fuse is tested automatically when the instrument is started up and then checked periodically during current measurement.

2.7.5 Buzzer

DISABLING/ENABLING THE BUZZER

Keep the ALARM button pressed down when you start up the instrument by turning the switch. The •))) symbol is no longer displayed.

To reactivate the buzzer, switch the instrument OFF and then back ON again.

THE DIFFERENT SOUNDS

When the •))) symbol is displayed, the buzzer is active. It gives out different sounds, depending on the operation or warning.

- **Short buzz** (65 ms at 2kHz):
 - push on a button
 - auto OFF
- **Continuous buzz** (at 2kHz):
 - measurement is lower than the minimum setpoint
 - measurement is higher than the maximum setpoint
- **Short, higher buzz** (65ms at 4kHz):
 - when a disabled (inactive) button is pressed (except the yellow test button)
- **Repeated high buzzes** (at 4kHz):
 - the detected voltage (safety check) at the sample is greater than 25V and the yellow button is pushed

2.7.6 Alarm Setpoints

Alarm setpoints can only be programmed for insulation and resistance measurement. The setpoints can be upper or lower thresholds. They can be active or inactive **and will be stored in the memory even after the instrument has been turned off.**

PROGRAMMING OF THE ALARM SETPOINTS

To program the setpoint press the ALARM button until the ALARM symbol is displayed and beeps a second time (the setpoint unit will blink, e.g. M Ω). The value of the setpoint corresponding to the selected range is indicated on the small digital display.

If no value was previously programmed, the display indicates a default setpoints:

- **On the 1039:** > 0.050M Ω for the M Ω - 50V position
> 0.100M Ω for the M Ω - 100V position
< 20.00k Ω for the 40k Ω position
- **On the 1035:** > 0.05M Ω for the M Ω - 50V position
> 0.10M Ω for the M Ω - 100V position
> 0.25M Ω for the M Ω - 250V position
> 0.50M Ω for the M Ω - 500V position
< 20.00k Ω for the 400k Ω position

At this moment, it is possible to program the threshold using the ► and ▲ buttons.

During this programming, if you change the switch position, you lose what you have just done.

You can quit the programming mode and record the threshold by another long press on the ALARM button.

If the programmed setpoint is too high, it is corrected when it is stored in the memory: the maximum value is entered. For example, a 2G Ω insulation threshold will be stored in the memory as 399.9M Ω on the 1039, while for resistance measurement 700k Ω will become 399.9k Ω on the 1035.

If the setpoint has been improperly input, it is corrected when it is stored in the memory: For example, 002M Ω will become 2.00M Ω .

TURNING THE ALARM ON AND OFF

The Alarm can be turned ON by a short press on the ALARM button. The buzzer beeps and the ALARM symbol, the < or > symbol and the programmed setpoint value is then displayed on the digital setpoint display.

The Alarm can be turned OFF by a second short press (and one beep) on the ALARM button. The ALARM symbol, the < or > symbol and the alarm setpoint will disappear.

Note: If you are in insulation measurement mode, the setpoint is indicated in negative on the bargraph. This means that if the measurement is lower than the setpoint, the segment corresponding to the setpoint is lit, if the measurement is higher than the setpoint, the segment is not lit and if the measurement is equal to the setpoint, the segment flashes.

If the Δ REL function is on and you activate a setpoint, it will apply to the absolute value of the value displayed.

TRIGGERING OF THE ALARM

Examples in insulation measurement:

- **If an upper setpoint of $100\text{M}\Omega$ is active**, the display indicates “ALARM > $100.0\text{M}\Omega$ ”.
- If the measurement exceeds this value, a continuous beep will be triggered and the whole digital threshold display will flash.
- **If a lower setpoint of $100\text{M}\Omega$ is active**, the display indicates “ALARM < $100.0\text{M}\Omega$ ”.
- If the measurement falls below this value, a continuous beep will be triggered and the whole digital threshold display will flash.

2.7.7 Relative Measurements (Δ REL)

Pressing the Δ REL button enables you to store the value measured in the memory. The measurements that follow are differences compared with the value in memory. These differences may be positive or negative. The Δ REL symbol is displayed.

Another press clears the value from the memory and returns the instrument to normal mode.



NOTE: This button can be used at any time except in voltage mode on the $M\Omega$ positions.

2.7.8 Programming the Capacitance per Unit Length (1039)

When the switch is set to nF, a long press on the  button activates the programming mode for the capacitance per unit length of the line to be measured. The value in memory is displayed on the digital threshold display along with the nF/km symbol.

If no value was programmed previously, the display indicates 50nF/km by default. It is then possible to modify the value present.



WARNING: During programming, if you change the switch position, you lose what you have just done. You can quit the programming mode and record the value by another long press on the  button.

SPECIFICATIONS

3.1 Electrical Specifications

These megohmmeters display the measurement every 400ms, which corresponds to 2.5 measurements per second for the digital display. The bargraph is refreshed every 100ms. The digital measurement is smoothed, while the bargraph always indicates the instantaneous measurement.

Reference Conditions

Parameters	Reference Conditions
Temperature	23°C ± 3K
Relative humidity	45 to 55% RH
Supply voltage	8V ± 0.2V
Frequency of measured voltage	DC, or 45 to 65Hz
Frequency of measured current	DC, or 45 to 65Hz
Capacity in parallel on resistance	nil
Electrical field	nil
Magnetic field	< 40A/m

3.1.1 Voltage

Measurement Range: 0 to 600V_{AC/DC}

Frequency: DC at 400Hz

Auto Ranging	0.0 to 399.9V _{AC/DC}	400 to 600V _{AC/DC}
Resolution	0.1V	1V
Accuracy	±3% R ± 1ct	
Input Impedance	6MΩ (1039) - 300kΩ (1035)	

3.1.2 Insulation

Measurement Range:

Model 1039: 50V 10kΩ to 400MΩ
 100V 20kΩ to 400MΩ

Model 1035: 50V 10kΩ to 2GΩ
 100V 20kΩ to 2GΩ
 250V 50kΩ to 20GΩ
 500V 100kΩ to 20GΩ

Analog Bargraph	80kΩ to 1.1GΩ
Resolution	10 segments per 10-unit interval
Accuracy	5% R \pm 1 segment

Model	1039 and 1035		1035	
Display	0.01 to 39.99M Ω	40.0 to 399.9M Ω	400 to 3999M Ω	4.00 to 20G Ω
Resolution	10k Ω	100k Ω	1M Ω	10M Ω
Accuracy	3% R \pm 5cts	3% R \pm 2cts	3% R \pm 2cts	

Model	1039 and 1035		1035	
Test Voltage	50V	100V	250V	500V
Open Circuit Voltage	<75V	<150V	<375V	<750V
Test Current	$\geq 1\text{mA}$ for R $\leq 50\text{k}\Omega$	$\geq 1\text{mA}$ for R \leq 100k Ω	$\geq 1\text{mA}$ for R $\leq 250\text{k}\Omega$	$\geq 1\text{mA}$ for R \leq 500k Ω
Short-Circuit Current	$\leq 3\text{mA}$			

The residual voltage present on the terminals when the yellow button is released is automatically discharged through the instrument at a rate of 20s/ μF (1039) and 1.5s/ μF (1035).

3.1.3 Resistance

Measurement Range: 0 to 40k Ω (1039)
0 to 400k Ω (1035)

Model	1039 and 1035			1035
Ranges Automatic	0.0 to 399.9 Ω	400 to 3999 Ω	4.00 to 39.99k Ω	40.0 to 399.9k Ω
Resolution	0.1 Ω	1 Ω	10 Ω	100 Ω
Accuracy	$\pm 3\%$ R \pm 2cts	$\pm 3\%$ R \pm 1ct		
Test Current	600 μA		6 μA	
Open Circuit Voltage	$7\text{V} \leq V_{\text{open}} \leq 9\text{V}$			

3.1.4 Capacitance (1039)

Measurement Range: 0 to 4000nF

Range	0.00 to 399.9nF	400 to 3999nF
Resolution	0.1nF	1nF
Accuracy	$\pm 3\% \pm 2\text{cts}$	$\pm 3\% \pm 1\text{ct}$
Measurement Current	1mA	100 μA

3.1.5 Distance (1039)

Measurement Range: 0 to 80km

Range	0.000 to 3.999km	4.00 to 39.99km	40.0 to 80.0km
Resolution	1m	10m	100m
Accuracy	$\pm 3\% \pm 2\text{cts}$		

3.1.6 AC/DC Current (1039)

Measurement Range: 0 to 399.9mAAC/DC

Frequency: DC to 400Hz

Resolution: 0.1mA

Accuracy: $\pm 3\% \pm 1\text{ct}$

Internal Impedance: 1Ω

3.1.7 AC Voltage (1039)

Measurement Range: 0 to 399.9VAC

Frequency: 10Hz to 1MHz

Resolution: 0.1VAC

Accuracy: $\pm 3\% \pm 1\text{ct}$

Internal Impedance: $5M\Omega$

3.1.8 Power Supply

The instrument is powered by 6 x 1.5V AA alkaline batteries, type NEDA 15A, or LR6.

Measurement	Consumption*	Average Battery Life
Voltmeter (1039/1035) Ammeter (1039) Capacitance Meter (1039)	25mA	57,600 5-second measurements
Resistance (1039/1035)	50mA	28,800 5-second measurements
Insulation (1039/1035) $M\Omega$ 50V (R = $50k\Omega$)	70mA	20,000 5-second measurements
Insulation (1039/1035) $M\Omega$ 100V (R = $100k\Omega$)	95mA	14,000 5-second measurements
Insulation (1035) $M\Omega$ 250V (R = $250k\Omega$)	160mA	7,200 5-second measurements
Insulation (1035) $M\Omega$ 500V (R = $500k\Omega$)	200mA	3,800 5-second measurements

* Add approximately 45mA for the backlighting.

3.2 Mechanical Specifications

LCD Display: 2.87 x 2.14" (73 x 54.3mm)

Dimensions: 8.30 x 4.25 x 2.36" (211 x 108 x 60mm)

Weight: 1.8 lbs (830g) approx

Materials: Polycarbonate casing
 Crystal polycarbonate screen
 Elastomer external mouldings
 Silicon buttonboard

Stand: Enables the instrument to be tilted at 30°. It clips away into the bottom of the case when not in use.

3.3 Environmental Conditions

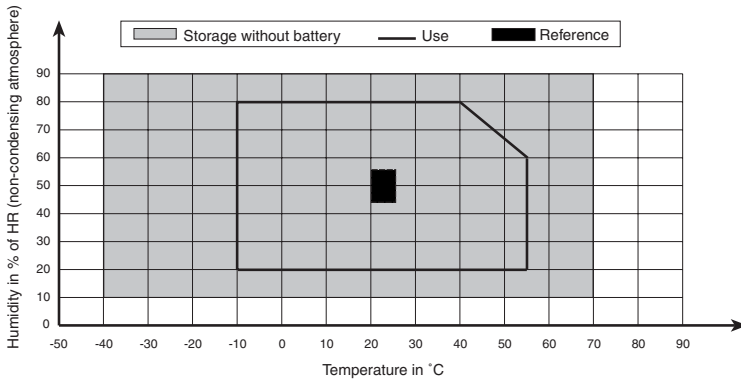

Influencing Parameters

Influence Parameter	Range	Measurement Variations	
		Typical	Maximum
Temperature	-10 to +55°C	1% R ±1ct / 10°C	2% R ±2cts / 10°C
Relative Humidity	20 to 80% RH	1% R ± 2cts	3% R ± 2cts
Supply Voltage	7 to 10V	1% ± 1ct/V	2% ± 2cts/V
Frequency (voltmeter >10V)	DC and 15 to 400Hz	2%	5%
Capacity in parallel to the resistance	0 to 5µF at nominal current	5% ± 1ct	10% ± 2cts

Limitation

The megohmmeters are protected on all ranges against a voltage of 600VAC/DC, applied permanently between any two terminals.

The current input of the 1039 accepts 0.63A and is protected by the fuse above this value.

3.4 Safety Specifications



Electrical Safety (according to IEC 1010-1 +A2 (Nov. '95), IEC 61557 (Feb. '97), VDE 413)

Double Insulation

600Vrms, Cat. III, Pollution Degree 2

Electromagnetic Compatibility:

Emissivity: NF EN 55 081-1 (June '92)

Immunity: NF EN 55 082-1 (Jan. '98)

IP44 according to NF EN 60529 (Oct. '92)

IK04 according to NF EN 50102 (June '95)

OPERATION

4.1 Operation

Turn the rotary switch to the measurement to be performed. Connect the instrument to the sample to be tested. The units and the range are automatically selected for the best reading.

The megohmmeter may be shut down manually by turning the switch to OFF. Otherwise, the instrument will shut down automatically after 5 minutes of no action by the user.



NOTE: The user can control the backlighting as required by pressing the  button.

4.2 AC/DC Voltage and Insulation Measurement

- Turn the megohmmeter ON by setting the range switch to the appropriate $M\Omega$ - Voltage range.
- Connect the lead from the “+” terminal to the ground/earth point and the lead of the “-” terminal lead (or remote control probe) to the other test point.
- Before the yellow test button is pressed, the instrument operates as a voltmeter (safety check) to ensure that there is no dangerous voltage at the sample.
- Press the yellow test button. Keep it pressed down until the measurement is displayed, or as long as needed. If released, the insulation test will stop. The yellow button on the remote control probe works the same way as the yellow test button on the megohmmeter.
- **To measure high insulation values ($> 1G\Omega$),** you are advised to use the “G” guard terminal to remove the influence of superficial leak currents and a hands free carrying case. In this case, it is preferable to

use alligator clips or wire grips rather than touch prods held in the hand.

- Record the insulation resistance value before releasing the test button.
- To end the measurement, release the yellow test button. The megohmmeter then enters the voltmeter mode and displays the voltage at the terminals. If the tested sample was capacitive, a voltage may appear and drop off slowly. Wait for the sample tested to discharge fully (voltage < 25V) before disconnecting the leads.

A programmed alarm threshold may be activated with the ALARM button.

4.3 Resistance Measurement

- Turn the megohmmeter ON by setting the switch to 40k Ω (1039) or 400k Ω (1035).
- Connect the + and - leads to the measurement points.
- Record the resistance value.
- The megohmmeter will continue generating a test current until it is switched out of the resistance range. Turn the megohmmeter OFF when done.

A programmed alarm threshold may be activated with the ALARM button.

4.4 Capacitance Measurement (1039)

- Turn the megohmmeter ON by setting the switch to 4000nF.
- Connect the + and - leads to the measurement points.
- Note the capacitance value displayed and the length of the line after programming its capacitance per unit length.

4.5 AC/DC Current Measurement (1039)

- Turn the megohmmeter ON by setting the switch to 400mA.
- Connect the leads from the mA and - terminals to the measurement points.

- Record the current value displayed.

Connecting the MN211 current probe accessory to the mA Amp terminals will extend the measurement range to 200AAC.

4.6 AC Voltage Measurement (1039)

- Turn the megohmmeter ON by setting the switch to V~.
- Connect the + and - leads to the measurement points.
- Note the voltage value displayed.

4.7 Application Examples

4.7.1 Insulation Measurements on Installations

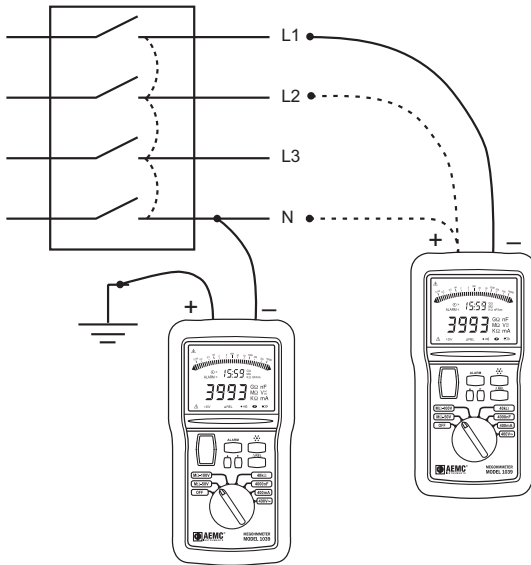

Figure 3

4.7.2 Insulation Measurements on Cables

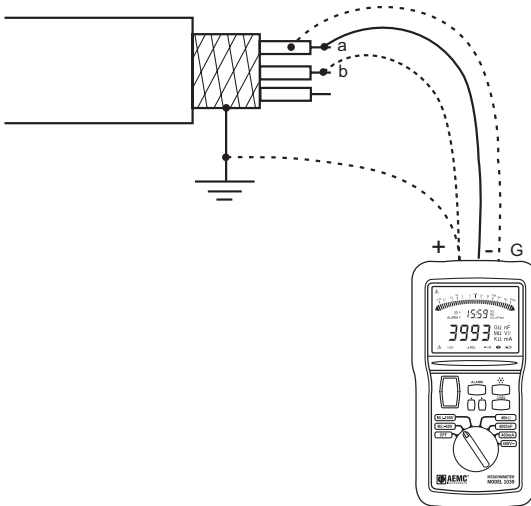

Figure 4

4.7.3 Insulation Measurements on Motors

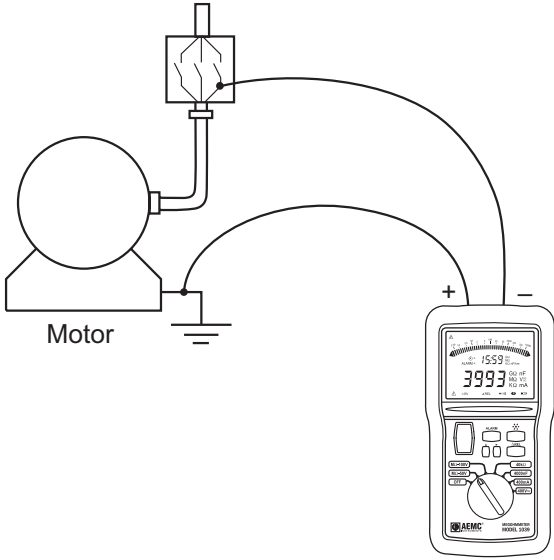

Figure 5

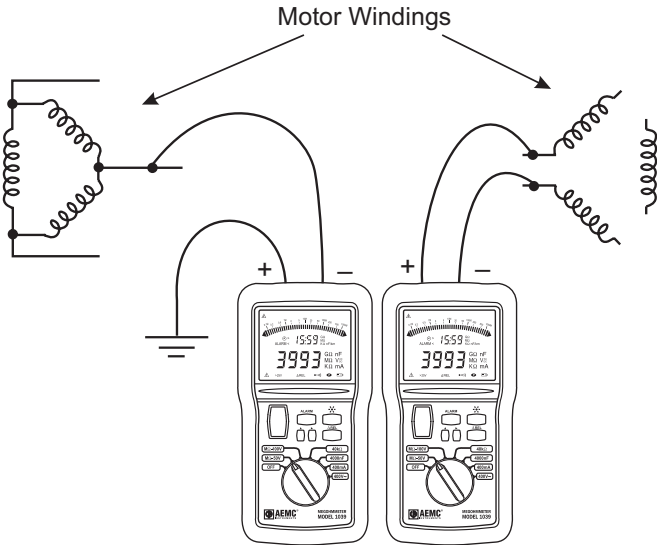





Figure 6

MAINTENANCE

Use only factory specified spare parts. The manufacturer will not be held responsible for any accident, incident, or malfunction following a repair done other than by its Service Center or by an approved repair center.

5.1 Battery Replacement

Before any measurements, make sure that the  symbol is not displayed when a measurement function is selected. If it is displayed, change all the batteries. **Make sure that none of the terminals are connected and that the switch is set to OFF before opening the battery compartment.** The battery cover is located on the back of the unit. It can be opened and closed using a coin or a large screwdriver (1/4-turn captive screw). To avoid errors, the    symbol on the power-supply board shows the direction in which the 6 x1.5V AA batteries should be inserted. Make sure that you put the cover back properly.

5.2 Fuse Replacement (1039)

Change the fuse if “FUS” appears on the digital display at power up or when measuring continuity. Take all necessary precautions when opening the instrument. It can be opened and closed using a coin or a large screwdriver (1/4-turn captive screw). **Make sure that none of the terminals are connected and that the switch is set to OFF before opening the back cover.** To avoid any errors, the text “F-0.63A” is written next to the fuse holder. Make sure that you replace the faulty fuse with fuse of the same rating and type. Replace and close the cover.

Type of fuse: Fast Acting 0.63A - 600V - 1/4 x 1 1/4” (6.3 x 32mm)

5.3 Cleaning

Disconnect the instrument from any power source. Use a soft cloth slightly moistened with soapy water. Rinse with a damp cloth and quickly dry with a dry cloth or forced dry air. Do not use alcohol, solvents or any hydrocarbon material.

5.4 Storage

If the instrument is to be unused for an extended period (more than 2 months), remove the batteries and store them separately.

Repair and Calibration

To ensure that your instrument meets factory specifications, we recommend that it be scheduled back to our factory Service Center at one-year intervals for recalibration, or as required by other standards or internal procedures.

For instrument repair and calibration:

You must contact our Service Center for a Customer Service Authorization Number (CSA#). This will ensure that when your instrument arrives, it will be tracked and processed promptly. Please write the CSA# on the outside of the shipping container. If the instrument is returned for calibration, we need to know if you want a standard calibration, or a calibration traceable to N.I.S.T. (Includes calibration certificate plus recorded calibration data).

Ship To: Chauvin Arnoux®, Inc. d.b.a. AEMC® Instruments
15 Faraday Drive
Dover, NH 03820 USA
Phone: (800) 945-2362 (Ext. 360)
(603) 749-6434 (Ext. 360)
Fax: (603) 742-2346 or (603) 749-6309
E-mail: repair@aemc.com

(Or contact your authorized distributor)

Costs for repair, standard calibration, and calibration traceable to N.I.S.T. are available.

NOTE: You must obtain a CSA# before returning any instrument.

Technical and Sales Assistance

If you are experiencing any technical problems, or require any assistance with the proper operation or application of your instrument, please call, mail, fax or e-mail our technical support team:

Chauvin Arnoux®, Inc. d.b.a. AEMC® Instruments
200 Foxborough Boulevard
Foxborough, MA 02035 USA
Phone: (800) 343-1391
(508) 698-2115
Fax: (508) 698-2118
E-mail: techsupport@aemc.com
www.aemc.com

NOTE: Do not ship Instruments to our Foxborough, MA address.

Limited Warranty

The Models 1035 and 1039 are warranted to the owner for a period of one year from the date of original purchase against defects in manufacture. This limited warranty is given by AEMC® Instruments, not by the distributor from whom it was purchased. This warranty is void if the unit has been tampered with, abused or if the defect is related to service not performed by AEMC® Instruments.

For full and detailed warranty coverage, please read the Warranty Coverage Information, which is attached to the Warranty Registration Card (if enclosed) or is available at www.aemc.com. Please keep the Warranty Coverage Information with your records.

What AEMC® Instruments will do:

If a malfunction occurs within the one-year period, you may return the instrument to us for repair, provided we have your warranty registration information on file or a proof of purchase. AEMC® Instruments will, at its option, repair or replace the faulty material.

**REGISTER ONLINE AT:
www.aemc.com**

Warranty Repairs

What you must do to return an Instrument for Warranty Repair:

First, request a Customer Service Authorization Number (CSA#) by phone or by fax from our Service Department (see address below), then return the instrument along with the signed CSA Form. Please write the CSA# on the outside of the shipping container. Return the instrument, postage or shipment pre-paid to:

Ship To: Chauvin Arnoux®, Inc. d.b.a. AEMC® Instruments
15 Faraday Drive • Dover, NH 03820 USA
Phone: (800) 945-2362 (Ext. 360)
(603) 749-6434 (Ext. 360)
Fax: (603) 742-2346 or (603) 749-6309
E-mail: repair@aemc.com

Caution: To protect yourself against in-transit loss, we recommend you insure your returned material.

NOTE: You must obtain a CSA# before returning any instrument.



05/07

99-MAN 100222 v12