

- COMPATIBLE CURRENT PROBES & SENSORS FOR POWER QUALITY METERS

**193-24-BK**  
**193-36-BK**  
**A196-24-BK**  
**MA193-10-BK**  
**MA193-14-BK**  
**J93**  
**MN93-BK**  
**MN193-BK**  
**MR193-BK**  
**SL261-BK**  
**SR193-BK**



Copyright © Chauvin Arnoux®, Inc. d.b.a. AEMC® Instruments. All rights reserved.











No part of this documentation may be reproduced in any form or by any means (including electronic storage and retrieval or translation into any other language) without prior agreement and written consent from Chauvin Arnoux®, Inc., as governed by United States and International copyright laws.

Chauvin Arnoux®, Inc. d.b.a. AEMC® Instruments  
15 Faraday Drive • Dover, NH 03820 USA  
Tel: (800) 945-2362 or (603) 749-6434 • Fax: (603) 742-2346

This documentation is provided "as is," without warranty of any kind, express, implied, or otherwise. Chauvin Arnoux®, Inc. has made every reasonable effort to ensure that this documentation is accurate; but does not warrant the accuracy or completeness of the text, graphics, or other information contained in this documentation. Chauvin Arnoux®, Inc. shall not be liable for any damages, special, indirect, incidental, or inconsequential; including (but not limited to) physical, emotional or monetary damages due to lost revenues or lost profits that may result from the use of this documentation, whether or not the user of the documentation has been advised of the possibility of such damages.

Thank you for purchasing an AEMC current probe.

For best results from your instrument and for your safety, read the enclosed operating instructions carefully and comply with the precautions for use. These products must be only used by qualified and trained users.

	WARNING, risk of DANGER! The operator must refer to these instructions whenever this danger symbol appears.
	CAUTION! Risk of electric shock. The voltage at the parts marked with this symbol may be dangerous.
	Application or withdrawal authorized on conductors carrying dangerous voltages. Type A current sensor as per IEC 61010-2-032.
	Must not be applied to or removed from conductors at dangerous voltages. Type B current sensor as per IEC 61010-2-032.
	Equipment is protected by double insulation.
	Battery
	Important instructions to read and to fully understand.
	Useful information or tip to read.
	The CE marking guarantees conformity with European directives and with regulations covering EMC.
	The trash can with a line through it means that in the European Union, the product must undergo selective disposal for the recycling of electric and electronic material, in compliance with Directive WEEE 2002/96/EC.

### Definition of Measurement Categories (CAT)

**CAT IV** Measurement category IV corresponds to measurements taken at the source of low-voltage installations.

Example: power feeders, counters and protection devices.

**CAT III** Measurement category III corresponds to measurements on building installations.

Example: distribution panel, circuit-breakers, machines or fixed industrial devices.

**CAT II** Measurement category II corresponds to measurements taken on circuits directly connected to low-voltage installations.

Example: power supply to domestic electrical appliances and portable tools.



## **PRECAUTIONS BEFORE USE**

---



The protection assured by the current probe can be compromised if it is used in a way that is not recommended by the manufacturer.

- Comply with the rated maximum voltage and current, and the measurement category. Do not use the current probe on networks where the voltage or category exceeds those specified.
- Comply with the conditions of use (e.g. temperature, humidity, altitude, degree of pollution, location).
- Do not use the current probe if its housing is open, deteriorated, or incorrectly reassembled. Before each use, check the integrity of the insulation of the unit, jaws, clamps, housing, and leads.
- Do not subject the current probe to water or other liquids.
- Keep the jaw contacts of the clamp absolutely clean.
- Use suitable personal protective equipment when hazardous voltages may be accessible in the installation where the measurement is made.
- Any repairs must be carried out by accredited skilled personnel.

# Table of Contents

---

---

<b>1. INTRODUCTION .....</b>	<b>4</b>
1.1 Receiving Your Shipment.....	4
1.2 Ordering Information.....	4
<b>2. PRODUCT FEATURES .....</b>	<b>5</b>
2.1 Control Features .....	5
2.1.1 AmpFlex® Models 193-24-BK, 193-36-BK & 196-24-BK .....	5
2.1.2 MiniFlex® Model MA193-BK .....	6
2.1.3 AC/DC Current Probe Model J93 .....	7
2.1.4 AC Current Probe Models MN93-BK & MN193-BK.....	8
2.1.5 AC Current Probe Model MR193-BK.....	9
2.1.6 AC Current Probe Model SL261 .....	10
2.1.7 AC Current Probe Model SR193-BK .....	11
<b>3. OPERATION.....</b>	<b>12</b>
<b>4. SPECIFICATIONS .....</b>	<b>14</b>
4.1 Electrical .....	14
4.2 Environmental.....	15
4.3 Mechanical.....	15
4.4 Safety.....	16
<b>5. MAINTENANCE .....</b>	<b>17</b>
5.1 Cleaning.....	17
5.2 Battery Replacement .....	17
5.2.1 Model MR193 .....	17
5.2.2 Model SL261 .....	17
5.2.3 Model J93.....	18
5.3 Repair and Calibration.....	19
5.4 Technical and Sales Assistance.....	19
5.5 Limited Warranty.....	20
5.6 Warranty Repairs .....	20

---

# 1. INTRODUCTION

---

## 1.1 Receiving Your Shipment

Upon receiving your shipment, make sure that the contents are consistent with the packing list. Notify your distributor of any missing items. If the equipment appears to be damaged, file a claim immediately with the carrier and notify your distributor at once, giving a detailed description of any damage. Save the damaged packing container to substantiate your claim.

## 1.2 Ordering Information

**NOTE:** The current probes in this manual are compatible only with AEMC® Power Analyzers (see § 4 for meter compatibility).

AmpFlex® Sensor 24" Model 193-24-BK .....	<b>Cat. #2140.34</b>
AmpFlex® Sensor 36" Model 193-36-BK .....	<b>Cat. #2140.35</b>
AmpFlex® Sensor 24" Model A196-24-BK .....	<b>Cat. #2140.75</b>
MiniFlex® Sensor 10" Model MA193-10-BK.....	<b>Cat. #2140.48</b>
MiniFlex® Sensor 14" Model MA193-14-BK.....	<b>Cat. #2140.50</b>
AC/DC Current Probe Model J93 .....	<b>Cat. #2140.49</b>
AC Current Probe Model MN93-BK.....	<b>Cat. #2140.32</b>
AC Current Probe Model MN193-BK.....	<b>Cat. #2140.36</b>
AC Current Probe Model MR193-BK.....	<b>Cat. #2140.28</b>
AC Current Probe Model SR193-BK .....	<b>Cat. #2140.33</b>
AC/DC Current Probe Model SL261* .....	<b>Cat. #1201.51</b>
* Adapter for SL261 - BNC Adapter .....	<b>Cat. #2140.40</b>

---

## 2. PRODUCT FEATURES

---

### 2.1 Control Features

#### 2.1.1 AmpFlex® Models 193-24-BK, 193-36-BK & 196-24-BK

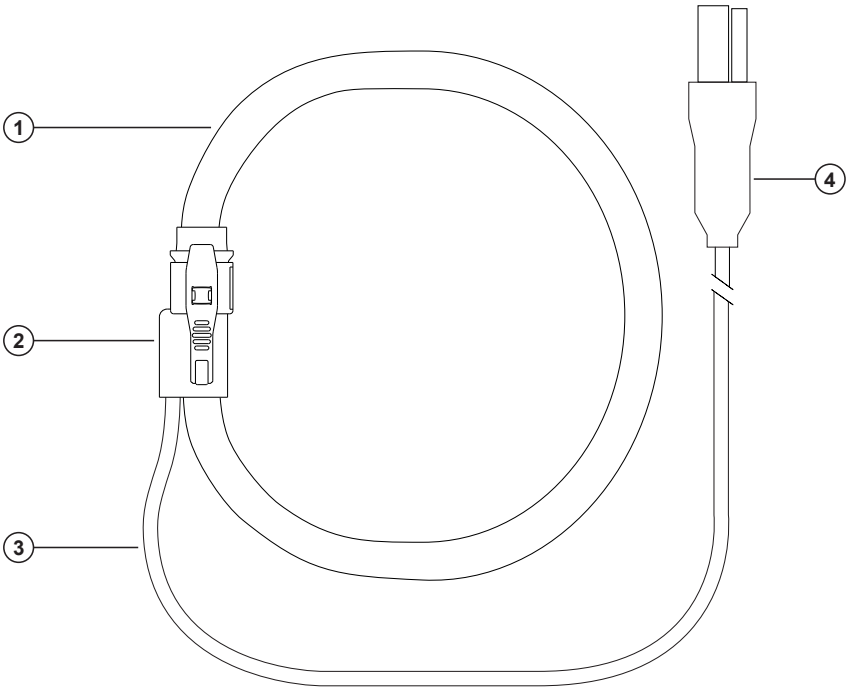

1. Flexible sensor
2. Sensor opening connector
3. Shielded lead
4. Custom 4-pin input connector

## 2.1.2 MiniFlex® Model MA193-BK

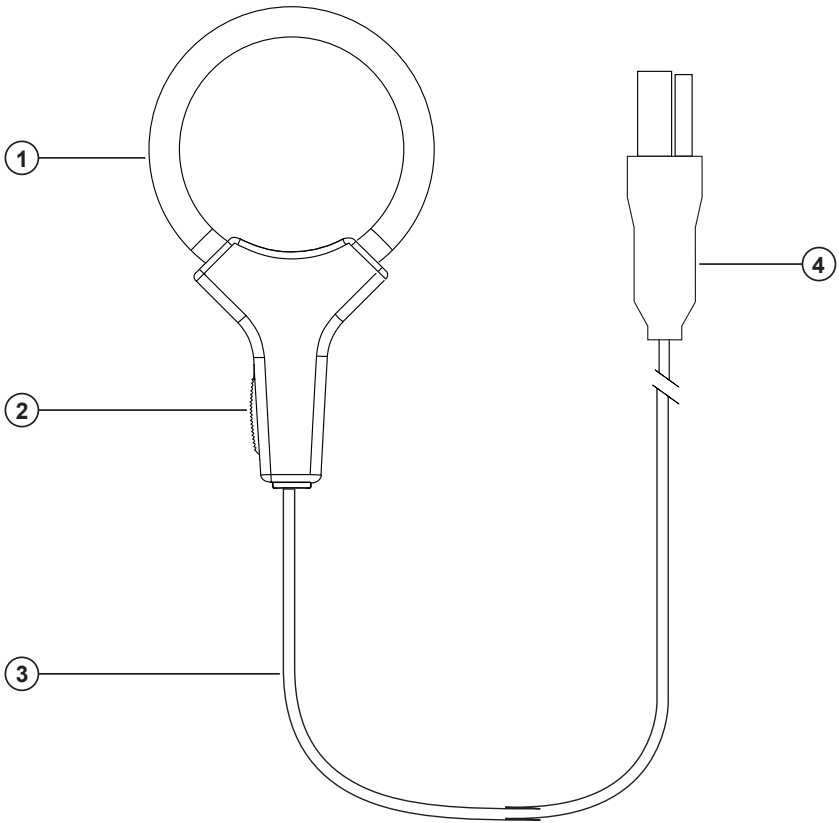

1. Flexible sensor
2. Sensor opening device
3. Shielded lead
4. Custom 4-pin input connector



## 2.1.3 AC/DC Current Probe Model J93

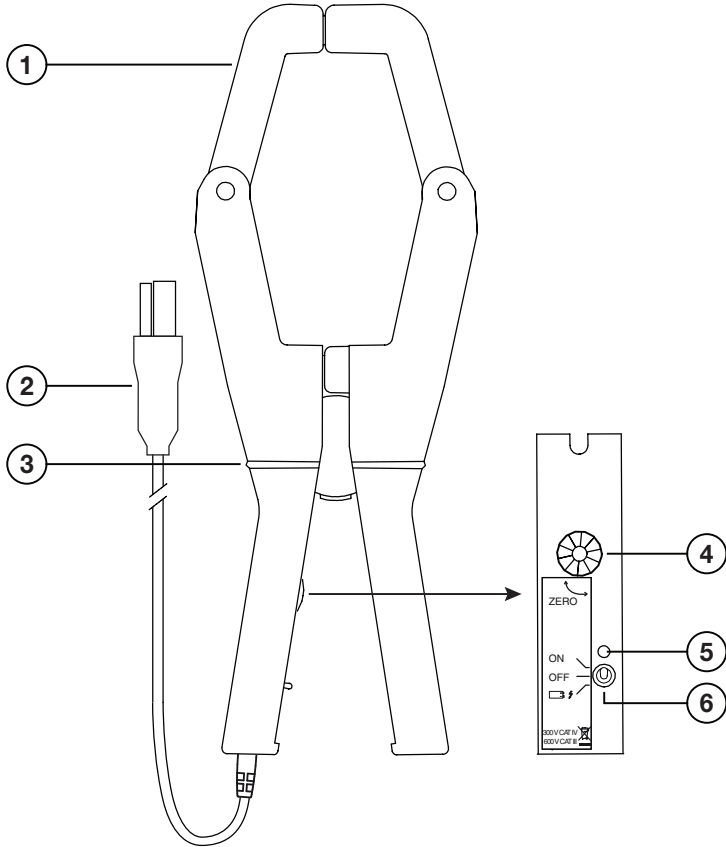

1. Jaws
2. 4-point CA connector
3. Safety guard
4. Zero adjustment knob
5. Power ON/Low battery indicator
6. Three-position switch: ON, OFF, battery test

## 2.1.4 AC Current Probe Models MN93-BK & MN193-BK

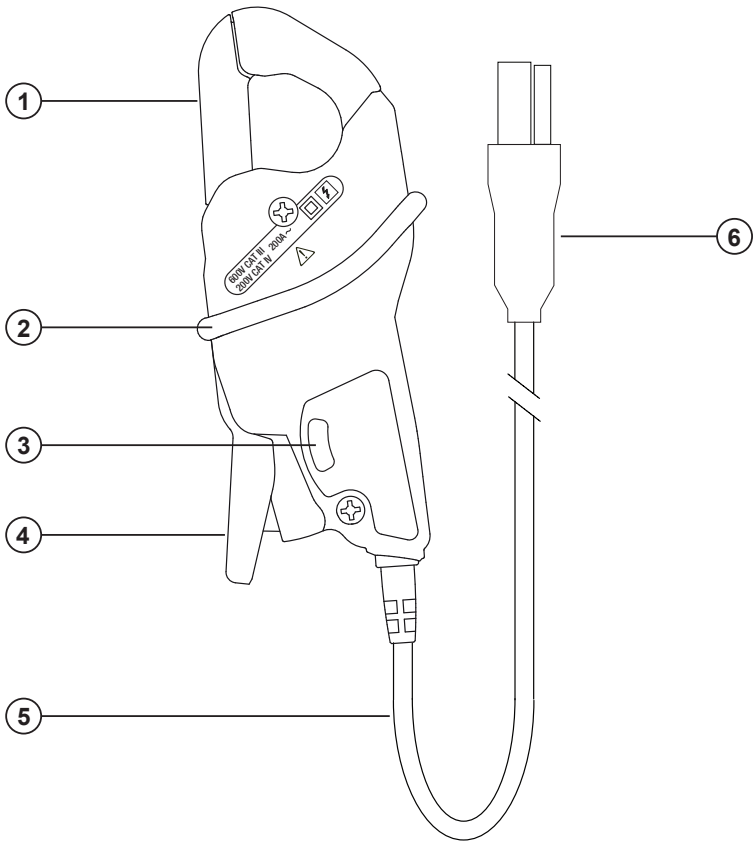

1. Jaws
2. Protective guard
3. Two-position range switch (MN193 only)
4. Jaw opening lever
5. Shielded lead
6. Custom 4-pin input connector

## 2.1.5 AC Current Probe Model MR193-BK

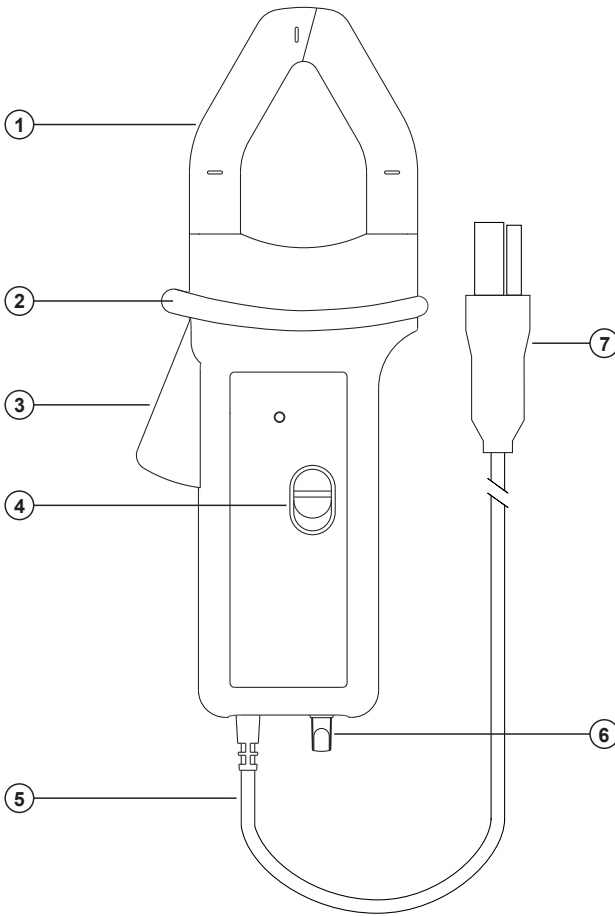

1. Jaws
2. Protective guard
3. Jaw opening lever
4. Two-position range switch
5. Shielded lead
6. Zero adjustment
7. Custom 4-pin input connector

## 2.1.6 AC Current Probe Model SL261

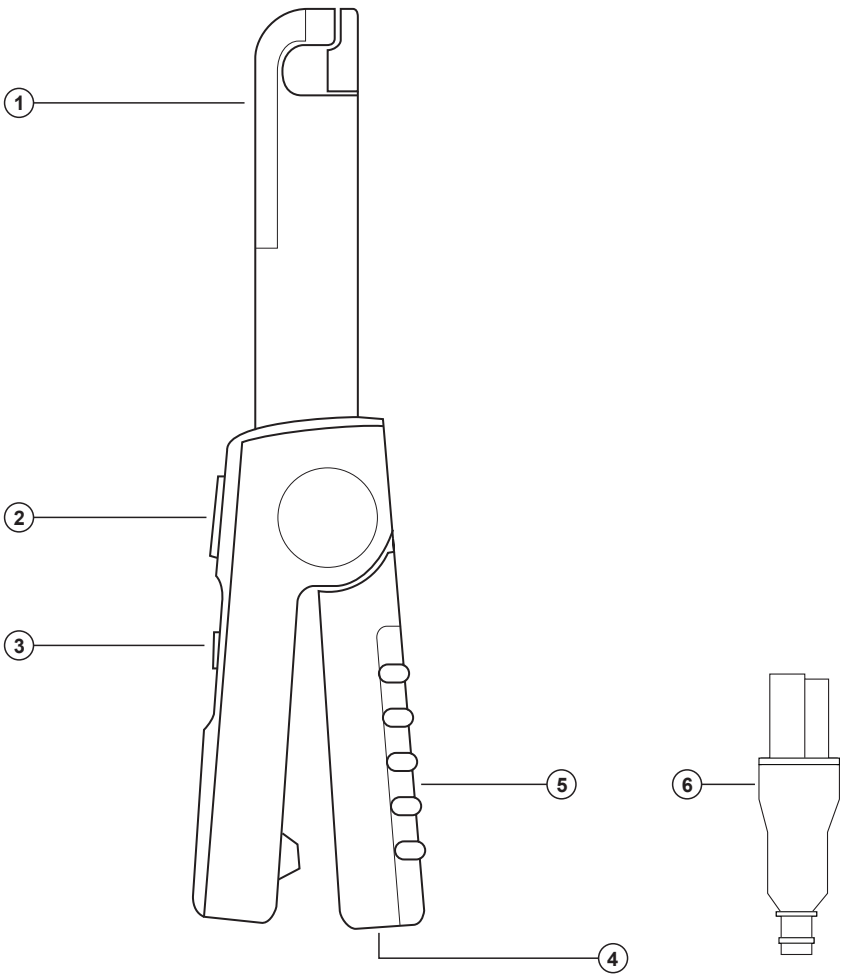

1. Jaws
2. Zero adjust knob
3. Range selection switch
4. Battery compartment screw
5. Battery compartment cover
6. BNC Adapter (sold separately - Cat. #2140.40)

## 2.1.7 AC Current Probe Model SR193-BK

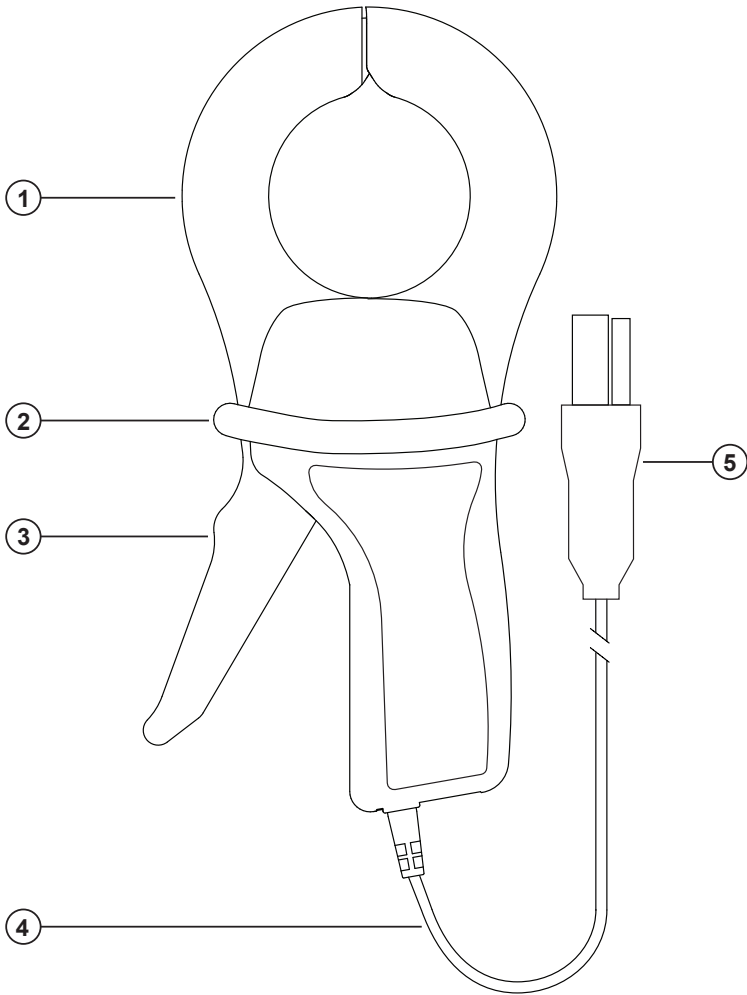

1. Jaws
2. Protective guard
3. Jaw opening lever
4. Shielded lead
5. Custom 4-pin input connector

---

## 3. OPERATION

---

The current probes and flexible sensors are used to measure the current flowing in a conductor or bus bar without opening the circuit. They also insulate the user from dangerous voltages in the circuit.

The choice of current probe or sensor to be used depends on the amperage to be measured and the diameter of the cables or size of the bus bar.

- For three-phase measurements, use the color-coded ID markers to associate a color for each current input to match the phase identifiers on the measured system.



**IMPORTANT NOTE:** Always connect the probes or sensors with the indicating arrows pointing toward the load.

---

**For Example Only (instrument's will vary):**

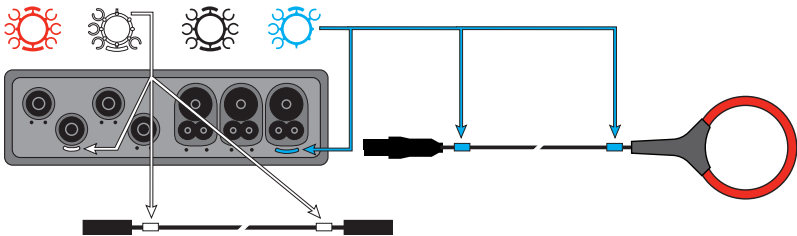

- Connect the current probe or sensor to the current terminals of the instrument.

**For MR193 and SL261 Probes:**

- **MR193:** Set the switch to 1mV/A; the ON indicator will light up.  
**SL261:** Set the switch to 10mA or 100mA/A; the ON indicator will light up.
- Connect the probe to the instrument.
- Adjust the zero by turning the potentiometer with no conductor in the jaws of the clamp.
- When the measurement is finished, turn the probe switch to OFF.

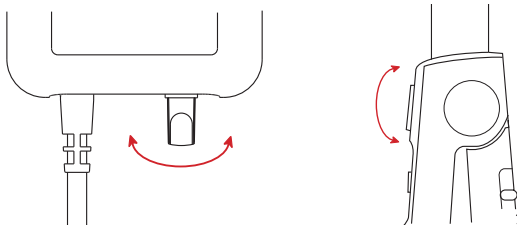

### For Probes:

- Press the jaw opening lever on the probe to open the jaws.
- Clamp the probe around the conductor to be tested. For best results, center the conductor in the jaws of the clamp.

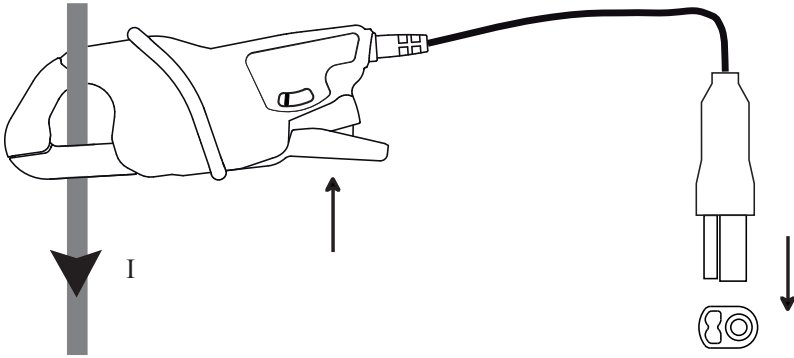

### For AmpFlex® and MiniFlex® Sensors:

- AmpFlex®: Press simultaneously on both sides of the opening connector.
- MiniFlex®: Press the opening device to open the flexible sensor.
- Clamp the sensor around the conductor to be tested. For best results, center the conductor in the jaws of the clamp.

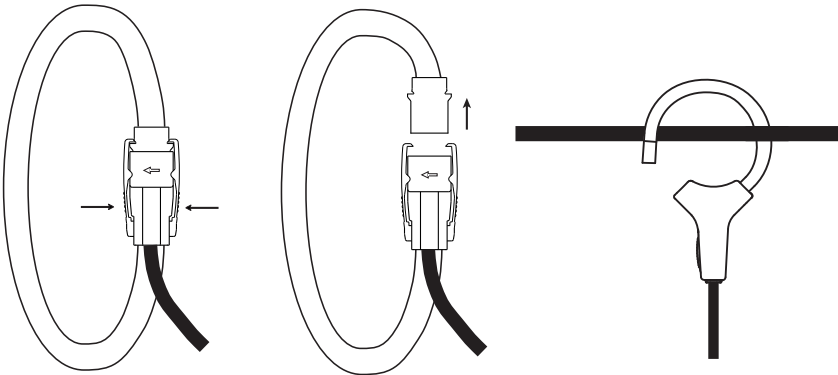

- Close the sensor by pushing the moving part into the connector until it clicks.



**NOTE:** For details of the measurement configuration and technical specifications, refer to the user manual of the instrument the current probe is being used with.

---

## 4. SPECIFICATIONS

---

### 4.1 Electrical

**NOTE:** The measurement ranges specified are for the probes and sensors. In some cases, they may differ from the ranges that can be measured by the instrument with which they are used with.



**For complete specifications:** Refer to the product user manual that is supplied with each compatible instrument.

Model	Measurement Range	Compatibility
<b>AmpFlex® 193-24-BK</b> <sup>(1)</sup> 24" (610mm)	200mA to 10kA <sub>AC</sub> <sup>(2)</sup> (12,000A) <sup>(3)</sup>	8333, 8336 & PEL Series
<b>AmpFlex® 193-36-BK</b> <sup>(1)</sup> 36" (910mm)	200mA to 10kA <sub>AC</sub> <sup>(2)</sup> (12,000A) <sup>(3)</sup>	8333, 8336 & PEL Series
<b>AmpFlex® A196-24-BK</b> <sup>(1)</sup> 24" (610mm)	200mA to 10kA <sub>AC</sub> <sup>(2)</sup> (12,000A) <sup>(3)</sup>	8435
<b>MiniFlex® MA193</b> <sup>(1)</sup> 10" (250 mm)	200mA to 3000A (10,000A peak)	8333, 8336 & PEL Series
<b>MiniFlex® MA193</b> <sup>(1)</sup> 14" (355 mm)	200mA to 3000A (10,000A peak)	8333, 8336 & PEL Series
<b>J93</b>	50 to 3500; 50 to 5000 (DC only)	8333, 8336, 8435 and PEL
<b>MN93</b>	2 to 240A <sub>AC</sub> (I > 200A not permanent)	All PowerPads and PEL
<b>MN193</b>	5A: 0.005 to 6A <sub>AC</sub> 100A: 0.1 to 120A <sub>AC</sub>	All PowerPads and PEL
<b>MR193</b>	10 to 1000A <sub>AC</sub> ; 10 to 1300A <sub>PEAK AC+DC</sub>	All PowerPads and PEL
<b>SL261</b>	100mV/A: 100mA to 10A peak 10mV/A: 1 to 100A peak	8333, 8336, 8435 and PEL
<b>SR193</b>	1 to 1200A <sub>AC</sub> (I > 1000A not continuously)	All PowerPads and PEL

(1) 10 to 6500A<sub>AC</sub> for Model 8435

(2) 200mA to 10,000A measurement range for the PEL 100 Series.

(3) 12,000A is specified for the PEL 100 Series only.

Battery: 9V Alkaline NEDA 1604A, 6LR61

Battery Life: MR193 - 100H typical

SL261 - 55H typical

J93 - 70H typical

**NOTE:** Battery life is twice the typical value when using Lithium batteries



## 4.2 Environmental

Indoor use.

Operating Temperature: 14° to 131°F (-10° to 55°C); 10% to 85% RH

Storage Temperature: -40° to 158°F (-40° to 70°C); 10% to 90% RH

Degree of pollution: 2

Altitude: < 2000 m

## 4.3 Mechanical

Model	Lead Length (nominal)	Clamping Diameter	Dimensions	Weight
<b>AmpFlex® 193-24-BK</b> 24" (610mm)	10 ft (3m)	7.64" (190mm)	6.6 x 6.2 x .98" (170 x 158 x 25mm)	7.7 oz (270g)
<b>AmpFlex® 193-36-BK</b> 36" (910mm)	10 ft (3m)	11.46" (290mm)	11 x 10.4 x .98" (280 x 265 x 25mm)	9.5 oz (220g)
<b>AmpFlex® A196-24-BK</b> 24" (610mm)	10 ft (3m)	7.64" (190mm)	6.6 x 6.2 x .98" (170 x 158 x 25mm)	7.7 oz (270g)
<b>MiniFlex® MA193 -10-BK</b> 10" (250mm)	10 ft (3m)	2.75" (70mm)	4.0 x 2.5 x 1.1" (103 x 64 x 28mm)	1.94 oz (55g)
<b>MiniFlex® MA193-14-BK</b> 14" (350mm)	10 ft (3m)	3.94" (100mm)	4.0 x 2.5 x 1.1" (103 x 64 x 28mm)	2.11 oz (60g)
<b>J93</b>	10 ft (3m)	2.84" (72mm)	13.23 x 5.00 x 1.65" (336 x 127 x 42mm)	3.75 lbs (1.7kg)
<b>MN93</b>	10 ft (3m)	0.8" (20mm)	5.47 x 2.00 x 1.18" (135 x 51 x 30mm)	24 oz (690g)
<b>MN193</b>	10 ft (3m)	0.8" (20mm)	5.47 x 2.00 x 1.18" (135 x 51 x 30mm)	24 oz (690g)
<b>MR193</b>	10 ft (3m)	One 1.6" (42mm) or two 0.98" (25mm) or two bus bars 1.96 x 0.19" (50 x 5mm)	8.8 x 3.82 x 1.73" (224 x 97 x 44mm)	19 oz (540g)
<b>SL261</b>	6.5 ft (1.9m)	0.46" (11.8mm)	9.09 x 1.42 x 2.64" (231 x 36 x 67mm)	11.6 oz (330g)
<b>SR193</b>	10 ft (3m)	2" (52mm)	8.5 x 4.4 x 1.8" (216 x 111 x 45mm)	24 oz (690g)

## 4.4 Safety

Protection index IP 40 for the probes and IP 30 jaws open, according to IEC 60 529

- IP 65 for the AmpFlex® according to IEC 60 529
- IK 04 according to IEC 50102

Drop test: According to IEC 61010-1

Electrical safety according to IEC 61010-2-032.

Maximum applicable voltage:

AmpFlex®: 1000V CAT III; 600V CAT IV

MiniFlex®: 1000V CAT III; 600V CAT IV

J93: 600V CAT III; 300V CAT IV

MN93 /MN193: 600V CAT III; 300V CAT IV

MR193: 600V CAT III; 300V CAT IV

SL261: 600V CAT III

SR193: 1000V CAT III; 600V CAT IV

*Specifications are subject to change without notice.*

---

## 5. MAINTENANCE

---

Use only factory specified replacement parts. AEMC® will not be held responsible for any accident, incident, or malfunction following a repair done other than by its service center or by an approved repair center.



**CAUTION:** Risk of electric shock. Disconnect the instrument from any source of electricity.

---

### 5.1 Cleaning

- Use a soft cloth, dampened with soapy water. Rinse with a damp cloth and dry rapidly with a dry cloth.
- Do not use alcohol, solvents, or hydrocarbons.
- Do not splash water directly on the instrument.

### 5.2 Battery Replacement

#### 5.2.1 Model MR193

- Disconnect the MR193 completely and turn the rotary switch to OFF.
- Use a screwdriver to unscrew the screws and remove the battery compartment cover on the backside of the unit.
- Withdraw the battery from its compartment.
- Disconnect the old battery without pulling on the wires and replace with a new one, observing the polarity.
- Put the battery into its compartment.
- Put the cover back in place and screw the screws back in.

#### 5.2.2 Model SL261

- Disconnect the SL261 completely and turn the rotary switch to OFF.
- Unscrew the battery compartment screw and pull off the battery compartment cover.
- Replace the battery with a new one, observing the polarity.
- Put the cover back in place and screw the screw back in.

### 5.2.3 Model J93

- Insert a tool, not more than 3mm in diameter, in the hole in the battery compartment cover.
- Push to unlock the battery compartment cover, then slide it off.
- Remove it completely by hand.
- Remove the battery and the shim from the compartment.
- Place the new battery in the compartment with the polarity as indicated on the label. Then replace the shim.
- Put the battery compartment cover back in the slide and push it in until you hear a click.



Used batteries must not be treated as ordinary household waste. Recycle them appropriately.

## 5.3 Repair and Calibration

To ensure that your instrument meets factory specifications, we recommend that it be scheduled back to our factory Service Center at one-year intervals for recalibration, or as required by other standards or internal procedures.

### **For instrument repair and calibration:**

You must contact our Service Center for a Customer Service Authorization Number (CSA#). This will ensure that when your instrument arrives, it will be tracked and processed promptly. Please write the CSA# on the outside of the shipping container. If the instrument is returned for calibration, we need to know if you want a standard calibration, or a calibration traceable to N.I.S.T. (Includes calibration certificate plus recorded calibration data).

**Ship To:** Chauvin Arnoux®, Inc. d.b.a. AEMC® Instruments  
15 Faraday Drive  
Dover, NH 03820 USA  
Phone: (800) 945-2362 (Ext. 360)  
(603) 749-6434 (Ext. 360)  
Fax: (603) 742-2346 or (603) 749-6309  
E-mail: [repair@aemc.com](mailto:repair@aemc.com)

(Or contact your authorized distributor)

Costs for repair, standard calibration, and calibration traceable to N.I.S.T. are available.

**NOTE: You must obtain a CSA# before returning any instrument.**

## 5.4 Technical and Sales Assistance

If you are experiencing any technical problems, or require any assistance with the proper operation or application of your instrument, please call, mail, fax or e-mail our technical support team:

Chauvin Arnoux®, Inc. d.b.a. AEMC® Instruments  
200 Foxborough Boulevard  
Foxborough, MA 02035 USA  
Phone: (800) 343-1391  
(508) 698-2115  
Fax: (508) 698-2118  
E-mail: [techsupport@aemc.com](mailto:techsupport@aemc.com)  
[www.aemc.com](http://www.aemc.com)

**NOTE: Do not ship Instruments to our Foxborough, MA address.**

## 5.5 Limited Warranty

The current probes and sensors are warranted to the owner for a period of one year from the date of original purchase against defects in manufacture. This limited warranty is given by AEMC® Instruments, not by the distributor from whom it was purchased. This warranty is void if the unit has been tampered with, abused or if the defect is related to service not performed by AEMC® Instruments.

Full warranty coverage and product registration is available on our website at [www.aemc.com/warranty.html](http://www.aemc.com/warranty.html).

Please print the online Warranty Coverage Information for your records.

### What AEMC® Instruments will do:

If a malfunction occurs within the one-year period, you may return the instrument to us for repair, provided we have your warranty registration information on file or a proof of purchase. AEMC® Instruments will, at its option, repair or replace the faulty material.

## 5.6 Warranty Repairs

What you must do to return an Instrument for Warranty Repair:

First, request a Customer Service Authorization Number (CSA#) by phone or by fax from our Service Department (see address below), then return the instrument along with the signed CSA Form. Please write the CSA# on the outside of the shipping container. Return the instrument, postage or shipment pre-paid to:

**Ship To:** Chauvin Arnoux®, Inc. d.b.a. AEMC® Instruments  
15 Faraday Drive  
Dover, NH 03820 USA  
Phone: (800) 945-2362 (Ext. 360)  
(603) 749-6434 (Ext. 360)  
Fax: (603) 742-2346 or (603) 749-6309  
E-mail: [repair@aemc.com](mailto:repair@aemc.com)

**Caution:** To protect yourself against in-transit loss, we recommend you insure your returned material.

**NOTE:** You must obtain a CSA# before returning any instrument.





12/15

99-MAN 100391 v4