

■ TRMS LEAKAGE CURRENT  
CLAMP-ON METER

# 566



## **Statement of Compliance**

---

Chauvin Arnoux®, Inc. d.b.a. AEMC® Instruments certifies that this instrument has been calibrated using standards and instruments traceable to international standards.

We guarantee that at the time of shipping your instrument has met its published specifications.

**An NIST traceable certificate may be requested at the time of purchase, or obtained by returning the instrument to our repair and calibration facility, for a nominal charge.**

The recommended calibration interval for this instrument is 12 months and begins on the date of receipt by the customer. For recalibration, please use our calibration services. Refer to our repair and calibration section at [www.aemc.com](http://www.aemc.com).

**Serial #:** \_\_\_\_\_

**Catalog #:** 2139.83

**Model #:** 566

Please fill in the appropriate date as indicated:

Date Received: \_\_\_\_\_

Date Calibration Due: \_\_\_\_\_



Chauvin Arnoux®, Inc. d.b.a AEMC® Instruments  
[www.aemc.com](http://www.aemc.com)

# Table of Contents

---

---

<b>1. INTRODUCTION .....</b>	<b>1</b>
1.1 International Electrical Symbols .....	2
1.2 Receiving Your Shipment .....	2
1.3 Ordering Information .....	2
<b>2. PRODUCT FEATURES .....</b>	<b>3</b>
2.1 Description .....	3
2.2 Model 566 Control Features .....	4
2.3 LCD Display .....	5
2.4 Button Functions .....	6
2.4.1 HOLD / LPF Button .....	6
2.4.2 PEAK /  Ω Button .....	6
2.4.3 ZERO (Relative) Button .....	7
2.4.4 Backlight Button .....	7
2.4.5 Auto-OFF .....	7
<b>3. SPECIFICATIONS .....</b>	<b>8</b>
3.1 Electrical Specifications .....	8
3.2 Mechanical Specifications .....	10
3.3 Environmental Specifications .....	10
3.4 Safety Specifications .....	10
<b>4. OPERATION .....</b>	<b>11</b>
4.1 Precautions Before Use .....	11
4.2 AC Current Measurement .....	12
4.3 AC Voltage Measurement .....	14
4.4 DC Voltage Measurement .....	15
4.5 Resistance Measurement .....	16
4.6 Continuity Measurement .....	17

<b>5. MAINTENANCE .....</b>	<b>20</b>
5.1 Warning.....	20
5.2 Cleaning .....	20
5.3 Battery Replacement.....	21
Repair and Calibration.....	22
Technical and Sales Assistance .....	22
Limited Warranty .....	23
Warranty Repairs.....	23

### INTRODUCTION

 **Warning** 

- Read the user manual before operating and follow all safety information.
- Only use the meter as specified in this user manual.
- Never use this meter on a circuit with voltages greater than 600Vrms @ 50/60Hz.
- Never measure current while the test leads are connected to the input jacks.
- Do not operate the meter if the case or test leads look damaged.
- Only use factory supplied leads.
- Check the rotary range switch and make sure it is at the correct position before each measurement.
- Do not perform resistance and continuity test on a live circuit.
- Use extreme caution when measuring live systems with voltages greater than 60VDC or 30VAC.
- Use extreme care when working around bus bars and bare conductors.
- Do not use the meter in over range/overload conditions (OL).
- For accurate readings, change the battery when the  symbol appears.

## 1.1 International Electrical Symbols



This symbol signifies that the instrument is protected by double or reinforced insulation.



**WARNING** - refer to this manual for instructions before operating the instrument. This symbol indicates that if the instructions are not followed, bodily injury, installation/sample and product damage may result.



Risk of electric shock. The voltage at the parts marked with this symbol may be dangerous.



Do not operate within external low frequency magnetic fields  $>30\text{A/m}$ .

## 1.2 Receiving Your Shipment

Upon receiving your shipment, make sure that the contents are consistent with the packing list. Notify your distributor of any missing items. If the equipment appears to be damaged, file a claim immediately with the carrier and notify your distributor at once, giving a detailed description of any damage. Save the damaged packing container to substantiate your claim.

## 1.3 Ordering Information

### TRMS Clamp-on Leakage Current

**Meter Model 566**..... **Cat. #2139.83**

*Includes meter, test leads, two 1.5V AAA (LR03) batteries, soft carrying case and user manual.*

### 1.3.1 Accessories and Replacement Parts

Replacement Pouch ..... **Cat. #2118.94**

AC Line Splitter Model ALS-1 ..... **Cat. #2121.05**

Leads, set of 2 w/4mm right angle plugs... **Cat. #2154.74**

# PRODUCT FEATURES

## 2.1 Description

The TRMS Clamp-on Meter Model 566 is designed to measure low AC currents, which are typically leakage currents in ground conductors. Low currents are measured in the 60mA and 600mA ranges. Note the high sensitivity of the probe: 1 $\mu$ A, 10 $\mu$ A, and 100 $\mu$ A resolution when measuring mA. This is possible through special jaw construction and in particular critical shielding of the jaws. At low measurement levels, shielding out noise is critical for low sensitivity, accuracy and stability.

Leakage current may be measured on a ground conductor and through the vector sum on multi-conductors. On a grounded system, clamp around the two or three conducting legs (not the ground conductor). The vector sum of the load currents will cancel out, leaving the leakage current measured.

You can also use the Model 566 as a standard clamp-on meter to 60A<sub>rms</sub>, plus standard V<sub>AC</sub>, V<sub>DC</sub> ranges, resistance and continuity with a buzzer. In mA<sub>AC</sub> and A<sub>AC</sub>, the user can activate a low-pass filter (LPF) to ignore all currents other than 50/60Hz. In this mode, only the fundamental signal is measured.

The Model 566 is ergonomic in design and fits well in the hand. Also, one hand operation is possible. The jaw size is compact yet designed to accommodate most known ground conductors up to 0.91" (23mm) in diameter.

## 2.2 Model 566 Control Features

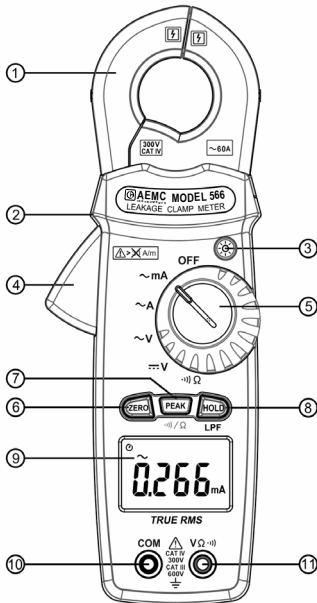





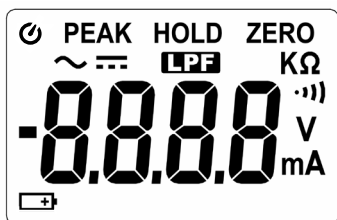

1. Jaw assembly ( $\varnothing$  0.91", 23mm)
2. Safety barrier anti-slip guard
3. Backlight button
4. Jaw trigger for jaw opening/closing
5. Function select rotary dial
6. **ZERO** button
7. **PEAK /  $\Omega$**  button
8. **HOLD / LPF** button
9. LCD display
10. **COM** (Black) input terminal jack
11. Positive (Red) input terminal jack



## 2.3 LCD Display



	Auto-off indicator
	Polarity indicator
	Low battery indicator
	AC measurement indicator
	DC measurement indicator
<b>A</b>	Current measurement indicator
<b>V</b>	Voltage measurement indicator
<b>ZERO</b>	Zero indicator
<b>HOLD</b>	Data hold indicator
<b>PEAK</b>	Peak hold indicator
<b>LPF</b>	Low pass filter indicator
	Continuity test indicator
<b>K</b>	Measurement unit
<b>Ω</b>	Resistance measurement indicator
<b>m</b>	Measurement unit

## 2.4 Button Functions

### 2.4.1 HOLD / LPF Button

This button has two functions, HOLD and LPF (Low Pass Filter).

#### HOLD

This function locks (holds) the measurement currently displayed on the LCD.

1. To activate, press the **HOLD** button during the measurement. The **HOLD** symbol appears and the measurement is locked.
2. To deactivate, press the **HOLD** button again.

#### LPF (Low Pass Filter)

The cut-off frequency of the low pass filter is approximately 60Hz with an attenuation characteristic of approximately -24dB/octave.

1. To activate the LPF feature, press and hold down the **HOLD** button for approximately 2 seconds until the **LPF** symbol appears on the LCD.
2. To deactivate, press and hold down the button again for approximately 2 seconds. The meter will return to normal operation mode.

**Note:** This feature is active when the rotary switch is set to AAC or mAAC.

### 2.4.2 PEAK / $\Omega$ Button

1. Press the **PEAK** button to enter PEAK mode. In this mode the instrument records the peak maximum value. Press **PEAK** again to return to normal mode.
2. With the rotary switch set to  $\Omega$ , press **PEAK** to enter resistance measurement mode. Press **PEAK** a second time to enter continuity test mode.

### 2.4.3 ZERO (Relative) Button

This function can be used to compare two voltage measurements (e.g. to determine a voltage drop) or to compensate for the resistance of the leads when making low resistance measurements.

1. Press the **ZERO** button to enter Zero mode. The **ZERO** symbol appears on the display. The reading is stored as a reference value for subsequent measurements.
2. To exit Zero mode, press the **ZERO** button again.

### 2.4.4 Backlight Button

Press the  button to turn the backlight on. Press it again to turn it off. When the backlight is on, the meter will automatically turn it off after about 30 seconds.

### 2.4.5 Auto-OFF

The Model 566 will automatically shut down if there is no activity for approximately 30 minutes.

1. To disable the Auto-OFF function, turn the rotary switch to **OFF**.
2. Press and hold down the **HOLD** button and set the rotary switch to any position other than **OFF**.
3. The  symbol disappears and the Auto-OFF feature is deactivated.

## SPECIFICATIONS

*Reference Conditions: Accuracy given at 73°F ± 9°F (23°C ± 5°F), ≤ 80% RH, Conductor Centered in A, Sine wave 48-65Hz, No AC Magnetic Field, External Magnetic Field <40A/m, True RMS (no DC component) for V, A and mA accuracy are specified from 5% to 100% of range. Accuracy add ±1% of Reading on Crest Factor 1.4<CF<3 at full-scale & CF<6 at mid-scale.*

### 3.1 Electrical Specifications

#### ACmA Current (TRMS, Auto-ranging)

Range	Res	Accuracy	Max
6mA	0.001mA	1.0% Rdg ± 8cts (50 to 60Hz) 2.0% Rdg ± 8cts (60 to 500Hz)	660mArms
60mA	0.01mA	1.0% Rdg ± 5cts (50 to 60Hz) 2.0% Rdg ± 5cts (60 to 500Hz)	
600mA	0.1mA		

**Max Voltage to Ground:** 600V

**Zero correction:** Currents smaller than approximately 0.006mA display as zero.

#### Low Pass Filter

Range	Res	Accuracy
6mA	0.001mA	2.0% Rdg ± 8cts
60mA	0.01mA	2.0% Rdg ± 5cts
600mA	0.1mA	

#### AC Current (TRMS, Auto-ranging)

Range	Res	Accuracy	Max
6A	1mA	1.0% Rdg ± 5cts (50 to 60Hz) 2.0% Rdg ± 5cts (60 to 500Hz)	66Arms
60A	10mA		

**Max Voltage to Ground:** 600V

### Low Pass Filter

Range	Res	Accuracy
6A	0.001A	2.0% Rdg ± 5cts
60A	0.01A	

### AC Voltage (TRMS)

Range	Res	Accuracy	Max
60V	0.01V	1.0% Rdg ± 3cts	660Vrms
600V	0.1V		

**Max Voltage to Ground:** 600V

**Input Impedance:** 2MΩ

### DC Voltage

Range	Res	Accuracy	Max
60V	0.01V	1% Rdg ± 2cts	660Vrms
600V	0.1V		

**Input Impedance:** 2MΩ

### Continuity (•••))

Range	Buzzer
•••))	Ohm < 45Ω

### Resistance (Ω)

Range	Res	Accuracy
600Ω	0.1Ω	1% Rdg ± 2cts
6kΩ	0.001kΩ	
60kΩ	0.01kΩ	
600kΩ	0.1kΩ	

**Overload:**  is displayed

**Nominal Sample Rate:** ~2 measurements/sec

**Power Supply:** Two 1.5V AAA batteries

**Low Battery Indication:**  is displayed when batteries fall below the voltage required for proper operation

**Polarity:** ■ indicates negative signal is being applied

**Battery Life (without buzzer or backlight):**

- 40 hours running AC current and voltage functions
- 60 hours running DC voltage and resistance functions

**Auto Power Off:** ~30 minutes with over-ride

### 3.2 Mechanical Specifications#

**Digital Display:** 4-digit LCD display (6000 max)

**Display Backlight:** LED with backlight; 30s Auto-OFF

**Jaw Opening Size:**  $\varnothing$  0.91" (23mm)

**Dimensions:** 8.27 x 3 x 1.32" (210 x 76 x 33.5mm)

**Weight:** 10.4 oz (296g) with batteries (meter only)

### 3.3 Environmental Specifications

**Altitude:** 2000m (6000ft)

**Operating Temperature:** 32° to 104°F (0° to 40°C),  
<80% RH, non-condensing

**Storage Temperature:** 14° to 140°F (-10° to 60°C),  
<80% RH, batteries removed

### 3.4 Safety Specifications

IEC61557-13: Class 2,  $\leq$  30A/m

600V CAT III

Double Insulation; Pollution Degree 2



### OPERATION

#### 4.1 Precautions Before Use



#### **IMPORTANT WARNING**



- **DO NOT** touch the voltage input jacks when measuring current.
- **DO NOT** measure current while the test leads are connected to the input jacks.
- **DO NOT** touch the jaw's magnetic core when measuring voltage.

## 4.2 AC Current Measurement



Remove test leads before measuring current.

1. Turn the rotary switch to the  $\sim$  **A** or  $\sim$  **mA** setting. The current to be measured should fall within the selected range.
2. To make a normal current measurement, press the jaw trigger to open the clamp meter jaws and close them over one conductor only. The measured current value appears on the LCD. Earth leakage current or any small AC current that flows through a ground wire can also be measured by this method.

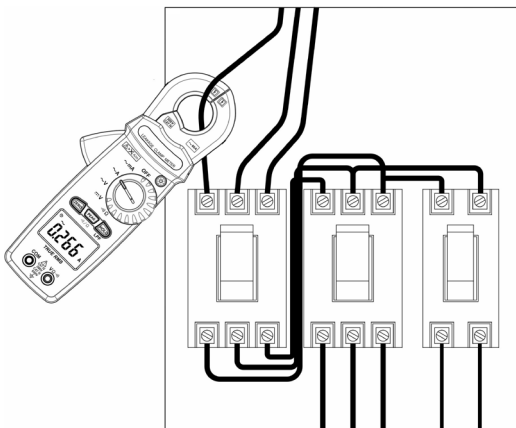

3. To freeze the reading, push the **HOLD** button. Push the button again to release.



Immediately unclamp the meter from the conductor if "OL" is displayed.



4. To measure out of balance leakage current, clamp onto all conductors except the ground wire. The imbalance current appears on the LCD.

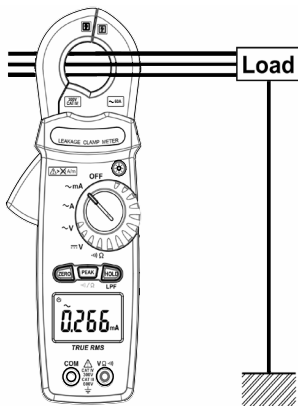

*3-phase 3-wire*

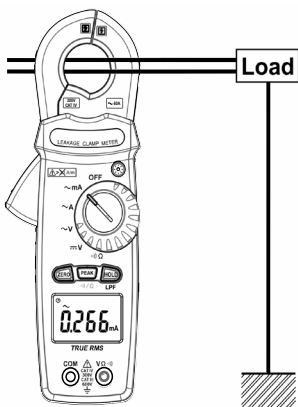

*Single-phase 2-wire*

## 4.3 AC Voltage Measurement



**WARNING:** Maximum Input Voltage is 600VAC. Do not exceed this voltage to avoid electrical shock and/or damage to the instrument.

1. Turn the rotary range switch to the  $\sim V$  setting.
2. Insert the red test lead to the red input jack and the black lead to the black "COM" input jack.
3. Bring the test probe tips into contact with the test points.



**WARNING:** Immediately remove the leads from the conductor if "OL" is displayed.

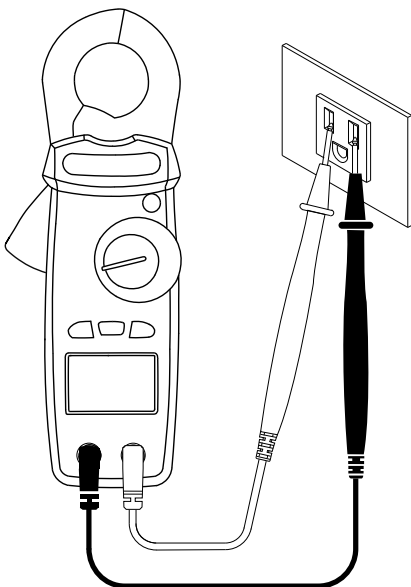

## 4.4 DC Voltage Measurement



**WARNING:** Maximum Input Voltage is 600V<sub>DC</sub>. Do not exceed this voltage to avoid electrical shock and/or damage to the instrument

1. Turn the rotary switch to the  $\overline{\text{V}}$  setting.
2. Insert the red test lead to the red input jack and the black lead to the black "COM" input jack.
3. Bring the test probe tips into contact with the test points.



**WARNING:** Immediately remove the leads from the conductor if "OL" is displayed.

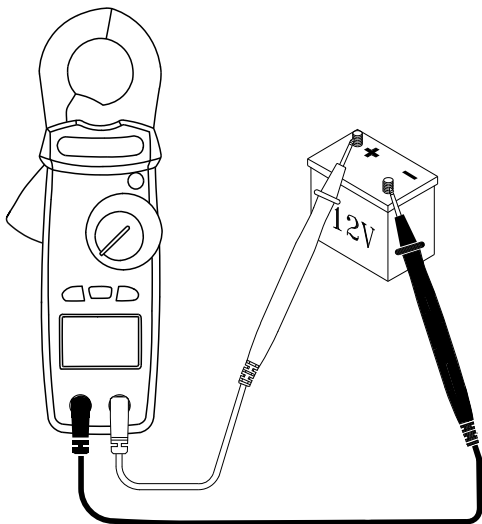

## 4.5 Resistance Measurement

1. Turn the rotary switch to the  $\Omega$  setting.
2. Insert the red test lead to the red input jack and the black lead to the black "COM" input jack.
3. Bring the test probe tips into contact with the sample under test.



**WARNING:** When testing resistance, make sure that there is no power in the tested sample or circuit (dead circuit). Also make sure the current is fully discharged. This may be checked by using the voltage functions.

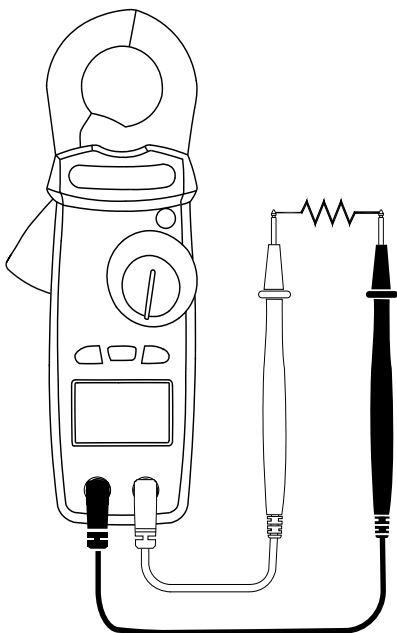

## 4.6 Continuity Measurement

1. Turn the rotary switch to the  $\bullet\text{---})\Omega$  setting.
2. Insert red test lead to the red input jack and the black lead to the black "COM" input jack.
3. Bring the test probe tips into contact with the sample under test.
4. If the resistance is less than  $45\Omega$ , the beeper emits a continuous sound.



**WARNING:** When testing continuity, make sure that there is no power in the tested sample or circuit (dead circuit). Also make sure the current is fully discharged. This may be checked by using the voltage functions.

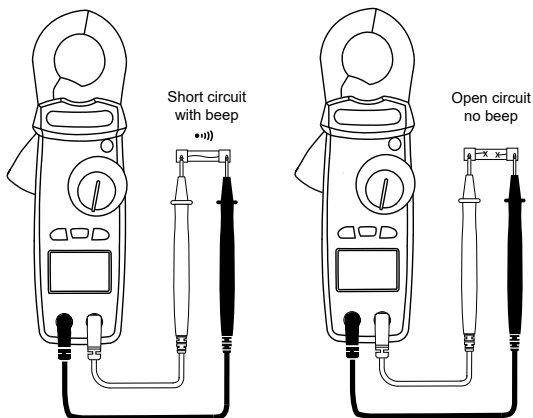

# MAINTENANCE

### 5.1 Warning!

- Remove the test leads from any input and sample before opening the case.
- Remove the clamp from any circuit.
- Do not operate the clamp-on probe without a battery case cover.
- To avoid electrical shock, do not attempt to perform any servicing unless you are qualified to do so.
- To avoid electrical shock and/or damage to the instrument, do not get water or other foreign agents into the probe.

### 5.2 Cleaning

- To clean the probe, wipe the case with a damp cloth and mild detergent.
- Do not use abrasives or solvents.
- Do not get water inside the case. This may lead to electrical shock or damage to the instrument.
- Thoroughly dry all parts before using again.

## 5.3 Battery Replacement

The  symbol will appear on the LCD display when the voltage drops below proper operating range. This indicates that the batteries need to be changed.

It is recommended to replace both batteries at the same time.

1. The meter must be in the OFF position and disconnected from any circuit or input.
2. Place the meter face down and loosen the battery cover screw with a flat head screwdriver.
3. Replace the batteries with two fresh 1.5V AAA (LR03) batteries.
4. Replace the battery compartment cover and tighten down the screw.

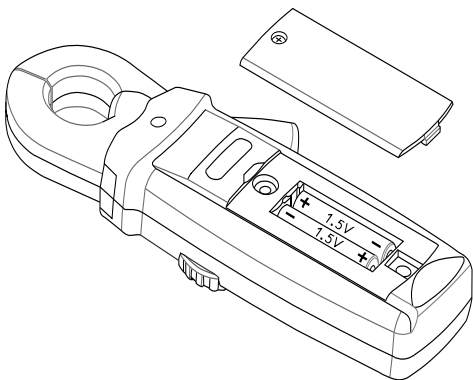

## Repair and Calibration

To ensure that your instrument meets factory specifications, we recommend that it be submitted to our factory Service Center at one-year intervals for recalibration, or as required by other standards or internal procedures.

### For instrument repair and calibration:

You must contact our Service Center for a Customer Service Authorization Number (CSA#). This will ensure that when your instrument arrives, it will be tracked and processed promptly. Please write the CSA# on the outside of the shipping container. If the instrument is returned for calibration, we need to know if you want a standard calibration, or a calibration traceable to N.I.S.T. (Includes calibration certificate plus recorded calibration data).

Chauvin Arnoux<sup>®</sup>, Inc. d.b.a. AEMC<sup>®</sup> Instruments  
15 Faraday Drive • Dover, NH 03820 USA  
Tel: (800) 945-2362 or (603) 749-6434 (Ext. 360)  
Fax: (603) 742-2346 or (603) 749-6309  
E-mail: [repair@aemc.com](mailto:repair@aemc.com)

(Or contact your authorized distributor)

Costs for repair, standard calibration, and calibration traceable to N.I.S.T. are available.

**NOTE: A CSA# must be obtained before returning any instrument.**

## Technical Assistance

If you are experiencing any technical problems, or require any assistance with the proper operation or application of your instrument, please call, mail, fax or e-mail our technical support hotline:

Chauvin Arnoux<sup>®</sup>, Inc. d.b.a. AEMC<sup>®</sup> Instruments  
15 Faraday Drive • Dover, NH 03820 USA  
Tel: (800) 945-2362 or (603) 749-6434 (Ext. 351)  
Fax: (603) 742-2346 or (603) 749-6309  
E-mail: [techsupport@aemc.com](mailto:techsupport@aemc.com)  
[www.aemc.com](http://www.aemc.com)



## Limited Warranty

The Model 566 is warranted to the owner for a period of two years from the date of original purchase against defects in manufacture. This limited warranty is given by AEMC® Instruments, not by the distributor from whom it was purchased. This warranty is void if the unit has been tampered with, abused or if the defect is related to service not performed by AEMC® Instruments.

**For full warranty coverage detail and registration, go to [www.aemc.com](http://www.aemc.com)**

**What AEMC® Instruments will do:** If a malfunction occurs within the warranty period, you may return the instrument to us for repair, provided we have your warranty registration information on file or a proof of purchase. AEMC® Instruments will, at its option, repair or replace the faulty material.

**REGISTER ONLINE AT: [www.aemc.com](http://www.aemc.com)**

## Warranty Repairs

**What you must do to return an Instrument for Warranty Repair:**

First, request a Customer Service Authorization Number (CSA#) by phone or by fax from our Service Department (see address below), then return the instrument along with the signed CSA Form. Please write the CSA# on the outside of the shipping container. Return the instrument, postage or shipment pre-paid to:

Chauvin Arnoux®, Inc. d.b.a. AEMC® Instruments  
Service Department  
15 Faraday Drive • Dover, NH 03820 USA  
Tel: (800) 945-2362 (Ext. 360)  
(603) 749-6434 (Ext. 360)  
Fax: (603) 742-2346 or (603) 749-6309  
E-mail: [repair@aemc.com](mailto:repair@aemc.com)

**Caution:** To protect yourself against in-transit loss, we recommend you insure your returned material.

**NOTE: All customers must obtain a CSA# before returning any instrument.**







05/21

99-MAN 100553 v2

**Chauvin Arnoux®**, Inc. d.b.a. **AEMC®** Instruments  
15 Faraday Drive • Dover, NH 03820 USA  
[www.aemc.com](http://www.aemc.com)