

- CLAMP-ON GROUND RESISTANCE TESTER

6417



Statement of Compliance

Chauvin Arnoux®, Inc. d.b.a. AEMC® Instruments certifies that this instrument has been calibrated using standards and instruments traceable to international standards.

We guarantee that at the time of shipping your instrument has met its published specifications.

An NIST traceable certificate may be requested at the time of purchase, or obtained by returning the instrument to our repair and calibration facility, for a nominal charge.

The recommended calibration interval for this instrument is 12 months and begins on the date of receipt by the customer. For recalibration, please use our calibration services. Refer to our repair and calibration section at www.aemc.com.

Serial #: _____

Catalog #: 2141.02

Model #: 6417

Please fill in the appropriate date as indicated:

Date Received: _____

Date Calibration Due: _____



AEMC®
INSTRUMENTS

Chauvin Arnoux®, Inc.
d.b.a AEMC® Instruments
www.aemc.com

PRODUCT PACKAGING

Shipping Contents:



(1) Clamp-on Ground Tester
Model 6417
Cat. #2141.02



Hard Accessory Case
Cat. #2141.50



5Ω Calibration Loop
Cat. #2141.51



USB Stick with
DataView® Software & User Manual



Bluetooth Adapter
Cat. #2126.45











Quick Start Guide

Also Included:

- (4) 1.5V AA Batteries
- (1) Wrist Strap
- (1) Safety Sheet (20 languages)

Thank you for purchasing an AEMC Clamp-on Ground Resistance Tester.

For best results from your instrument and for your safety, read the enclosed operating instructions carefully and comply with the precautions for use. These products must be only used by qualified and trained users.

	WARNING, risk of DANGER! The operator must refer to these instructions whenever this danger symbol appears.
	CAUTION! Risk of electric shock. The voltage at the parts marked with this symbol may be dangerous.
	Application or withdrawal authorized on conductors carrying dangerous voltages. Type A current sensor as per IEC 61010-2-032.
	Equipment is protected by double insulation.
	The product has been declared recyclable after analysis of its life cycle in accordance with the ISO14040 standard.
	Important instructions to read and to fully understand.
	Useful information or tip to read.
	The CE marking guarantees conformity with European directives and with regulations covering EMC.
	The trash can with a line through it means that in the European Union, the product must undergo selective disposal for the recycling of electric and electronic material, in compliance with Directive WEEE 2002/96/EC.

Definition of Measurement Categories (CAT)

CAT IV Measurement Category IV corresponds to measurements taken at the source of low-voltage installations.
Example: power feeders, counters and protection devices.

CAT III Measurement Category III corresponds to measurements on building installations.
Example: distribution panel, circuit-breakers, machines or fixed industrial devices.

CAT II Measurement Category II corresponds to measurements taken on circuits directly connected to low-voltage installations.
Example: power supply to domestic electrical appliances and portable tools.



PRECAUTIONS FOR USE



This instrument and its accessories comply with safety standards EN 61010-1, EN 61010-030, and EN 61010-2-032 for voltages of 600V in Category IV at an altitude of less than 2000m with a pollution degree of not more than 2.

Failure to observe the safety instructions may result in electric shock, fire, explosion, and destruction of the instrument and of the installations.

- The operator and/or the responsible personnel must carefully read and clearly understand the various precautions to be taken in use. Sound knowledge and a keen awareness of electrical hazards are essential when using this instrument.
- If you use this instrument other than as specified, the protection it provides may be compromised, thereby endangering you.
- Do not use the instrument on networks of which the voltage or category exceeds those mentioned.
- Do not use the instrument if it seems to be damaged, incomplete, or poorly closed.
- Before each use, check the condition of the insulation on housing. Any item of which the insulation is deteriorated (even partially) must be set aside for repair or scrapping.
- Use personal protection equipment systematically.
- When handling the instrument, keep your fingers behind the physical guard.
- All troubleshooting and metrological checks must be performed by competent and accredited personnel.
- Avoid impacts on the measurement head, in particular the air gap.
- Keep the surfaces of the air gap clean; even a little dirt can cause the clamp to malfunction.
- All metal objects or wires connected to the electrical system should be assumed to be lethal until tested. Grounding systems are no exception.
- Use extreme caution when using the instrument around energized electrical equipment.
- Never attempt to use the instrument to twist or pry the ground electrode or ground wire away from the equipment being grounded.

Table of Contents

1. INTRODUCTION	7
1.1 Receiving Your Shipment.....	7
1.2 Ordering Information.....	7
1.2.1 Replacement Parts.....	7
2. PRODUCT FEATURES.....	8
2.1 Description.....	8
2.2 Features.....	9
2.3 Applications.....	9
2.4 Display.....	10
2.5 Control Features.....	12
2.6 Audible Signals.....	13
2.7 Rotary Switch Functions.....	13
2.8 Button Functions.....	14
3. PRINCIPLE OF OPERATION	15
4. SET-UP	17
4.1 Menu Items.....	17
4.2 SET-UP Menu Displays.....	17
4.3 Selecting a Specific Menu	18
4.4 SET-UP Menus.....	18
5. OPERATION.....	22
5.1 Inserting the Batteries.....	22
5.2 Setting the Date and Time.....	22
5.3 Display Example.....	23
5.4 Turning the Instrument ON.....	23
5.5 Turning Bluetooth ON.....	24
5.6 Turning the Instrument OFF.....	24
5.7 Standard and Advanced Modes.....	24
5.8 Memory.....	25
5.8.1 Memory Capacity.....	25
5.8.2 Storing Measurements into Memory.....	25

5.8.3	Reading Stored Data	25
5.8.4	Erasing the Memory	25
5.8.5	Using the ▲ and ▼ Buttons	26
5.8.6	Exporting Data to a PC	26
5.9	Alarm Management.....	26
5.9.1	Voltage Alarm	26
5.9.2	Current Alarm	27
5.9.3	Impedance Alarm.....	27
5.9.4	No Alarm Detection.....	27
5.9.5	Priority of the Alarms	28
6.	MEASUREMENT MODES.....	29
6.1	Rotary Position Ω +A.....	29
6.1.1	Standard Mode.....	29
6.1.2	Advanced Mode.....	30
6.1.3	General Information.....	31
6.2	Rotary Position (A).....	32
6.2.1	Making a Measurement	33
6.3	Rotary Position - (MR)	33
6.3.1	Displaying Stored Measurements.....	33
7.	DATAVIEW® SOFTWARE.....	36
7.1	Installing DataView®.....	36
7.2	Connecting the Instrument to a Computer.....	40
7.2.1	Bluetooth Connection	40
7.2.2	Pairing using Windows Vista / Windows 7/8/8.1/10.....	40
7.3	The Control Panel.....	42
7.3.1	Establishing Instrument Communication	43
7.4	Configuring the Instrument	44
8.	ANDROID APPLICATION	46
9.	SPECIFICATIONS	50
9.1	Reference Conditions	50
9.2	Electrical	50
9.2.1	Loop Resistance Measurement.....	50
9.2.2	Loop Inductance Measurement.....	51
9.2.3	Contact Voltage (Touch Voltage)	51

9.2.4	Current Measurement.....	51
9.2.5	Power Supply	52
9.3	Environmental.....	52
9.4	Mechanical.....	52
9.5	Safety.....	53
10.	MAINTENANCE.....	54
10.1	Cleaning.....	54
10.2	Battery Replacement	54
10.3	Repair and Calibration	55
10.4	Technical and Sales Assistance.....	55
10.5	Limited Warranty.....	56
10.6	Warranty Repairs	56

1. INTRODUCTION

1.1 Receiving Your Shipment

Upon receiving your shipment, make sure that the contents are consistent with the packing list. Notify your distributor of any missing items. If the equipment appears to be damaged, file a claim immediately with the carrier and notify your distributor at once, giving a detailed description of any damage. Save the damaged packing container to substantiate your claim.

1.2 Ordering Information

Clamp-on Ground Resistance Tester Model 6417 **Cat. #2141.02**
Includes a hard carrying case, Bluetooth USB adapter, calibration loop, four 1.5V AA batteries, quick start guide, and USB stick with DataView® software and user manual.

1.2.1 Replacement Parts

Bluetooth USB Adapter Class 2..... **Cat. #2126.45**
Wrist Strap..... **Cat. #2135.47**
Hard Carrying Case..... **Cat. #2141.50**
5Ω Calibration Loop..... **Cat. #2141.51**

Order Accessories and Replacement Parts Directly Online
Check our Storefront at www.aemc.com for availability

2. PRODUCT FEATURES

2.1 Description

The Clamp-on Ground Resistance Tester Model 6417 measures grounding electrodes and grid resistance without the use of auxiliary rods. Clamp-on ground resistance testers can be used in multi-grounded systems without disconnecting the ground system under test. The Model 6417 simply clamps around the ground conductor or rod and measures the resistance to ground. By performing measurements on intact ground systems, the user also verifies the quality of the grounding connections and bonds. Resistance and continuity of grounding loops around pads and buildings can also be measured.

The Model 6417 includes a current measurement function. The ground tester's high sensitivity enables measurement of leakage current flowing to ground or circulating in ground loops from 0.2mA to 40A and resistances from 0.01 to 1500 Ω .

Battery life information is displayed at power-up and the Auto Power OFF feature can be enabled for power management. Additional features include the large OLED (Organic Light Emitting Diode) display that ensures high readability of data. The Buzzer and Auto Power OFF features can be disabled at any time.

The Model 6417 is equipped with an alarm function and a data storage function. In the Alarm mode, the probe will audibly and visually indicate when the reading is beyond an input set point. You can also have the alarm activate above or below the set point. This alarm feature permits quick field checks where only "pass" or "fail" readings are required.

The data storage function logs up to 2000 measurements (Ω and/or A). This enables you to conduct field surveys, and to retrieve and analyze the readings at a later time. The alarm settings and stored data are saved on the ground tester and remain stored even when the instrument is turned OFF. You can retrieve and analyze the results at a later time with DataView[®] software or with an Android app through the Bluetooth communication port.

Two new features unique to AEMC[®] are test frequency selection and touch voltage indication.

The ability to select the test frequency provides more accurate measurements in inductive environments.

Displaying voltage derived from current and resistance measurements provides an extra level of safety for the user, indicating a potentially dangerous touch condition.

2.2 Features

- Simple and fast clamp-on operation - no leads, no auxiliary rods or spacing requirements
 - **Ammeter:** Current measurements from 0.2mA to 40A.
 - **Loop ohmmeter:** Measurement of loop impedances from 0.01 to 1500Ω. The ohmmeter function makes allowance for the presence of inductances in the loop, making impedance measurements more accurate at low values.
 - **Contact voltage:** The contact voltage is determined by calculating the product of the loop impedance and leakage current. The value found is an upper bound on the voltage between the measurement point and earth, since the impedance taken into account is that of the whole loop.
- Touch voltage display
- Large multi-function, bright yellow organic light emitting diode display (OLED)
- Display in Standard mode (one screen) or Advanced mode (three screens)
- Clamping diameter of 1.38" (35mm) accommodating cables up to 1000kcmil
- Stores up to 2000 measurements (Ω and/or A, with time-stamping)
- Displays stored measurements on the display or via Bluetooth® to a PC
- Measurement hold by the HOLD and AUTO-HOLD functions
- Clamp opening made easy by a trigger with a force compensation system
- Auto Power OFF function
- Alarm function with adjustable set point and buzzer for quick field checks
- Rugged Lexan® head and body construction resists breakage
- Alarm settings and stored memory information saved during shutdown
- NOISE icon and buzzer notify the user to presence of dangerous voltage and current levels
- Designed to EN 61010-1, 600V CAT IV safety standards

2.3 Applications

- Ground electrode system resistance
- Bonding/continuity checks
- Cell tower grounding verification
- Ground measurements on Railroad signaling systems

2.4 Display

The Model 6417 is equipped with a 152-segment OLED (organic light-emitting diode) display. This OLED technology results in a thinner, lighter, sharper, higher contrast display compared to LCD displays.

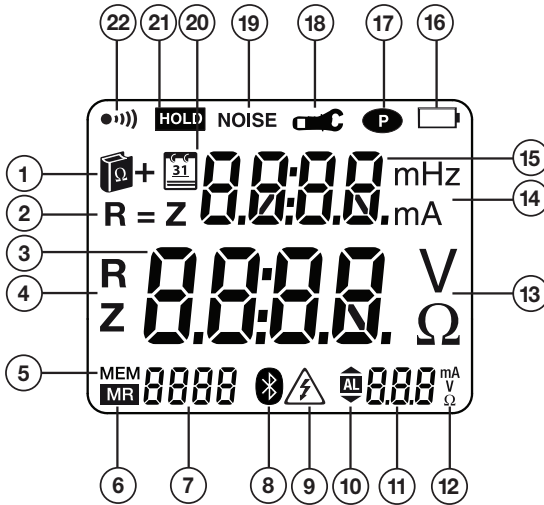

Figure 2-1

Item	Description
1	Indicates selection of Advanced mode.
2	In Advanced mode, this indicates when the inductive component is negligible with respect to the resistive component.
3	Main Display: <ul style="list-style-type: none"> - Measurement of the impedance or current. - Display of the date and time (month-day and hour-minute) in configured and stored values display mode.
4	In Advanced mode, these symbols identify the value displayed (resistance or impedance).
5	Data storage mode.
6	Memory recall mode.
7	Memory index four-digit digital display (0 to 9999-counts): <ul style="list-style-type: none"> - Measurement sequence number of the current memory in normal operation associated with the Recall (MR) or Storage (MEM) indications. - Date stamp (year) when the device is configured.
8	<ul style="list-style-type: none"> - Blinks while the Bluetooth connection is being established. - On steady for the duration of Bluetooth communication.
9	Signal indicating potentially hazardous voltage. Blinks when the contact voltage exceeds 50V.

10	Alarm threshold high/low indicator (operational use or configuration): ▲ Alarm threshold high indicator. AL Alarm threshold adjustment mode or Alarm function. ▼ Alarm threshold low indicator.
11	Alarm threshold display: - Display of one of the alarms (1000-count display) with units. - These three digits are also used when configuring the time display mode. (A for A.M., P for P.M. or 24H) in SET-UP (see § 4.4, menu #8).
12	Unit of the alarm displayed. The alarm can be defined on a resistance impedance, voltage, or current, depending on the measurement chosen (Ω +A or A). - A : Current measurement alarm. - Ω : Resistance measurement alarm. - V : Voltage measurement alarm.
13	Unit of the central measurement display: - V : Contact voltage measurement unit. - Ω : Impedance measurement unit. Symbol used for impedances at the measurement frequency, for impedances referred to the network frequency, or for the resistive component.
14	Unit of the top measurement display: - mH : Loop inductance measurement unit. - mA or A : Current measurement unit.
15	Upper display: 4000-count current measurement and 500-count loop inductance measurement (Advanced mode).
16	Battery charge indicator: - Not displayed : Batteries charged. - Blinking : Batteries low. The device remains functional, but the batteries will have to be replaced soon. - Steady : Batteries discharged. The display indicates <i>Lo bat</i> . It is not possible to make measurements, read records, or configure parameters.
17	Continuous operation of the clamp (Auto Power OFF disabled). Selection of Auto Power OFF mode is made in SET-UP (see § 4.4, menu #3).
18	Symbol indicating incorrect closing of the clamp; measurements cannot be made in this case. If the AUTO-HOLD mode is activated, the HOLD icon blinks and the measurement is frozen. Selection of AUTO-HOLD mode is made in SET-UP (see § 4.4, menu #11).
19	Symbol indicating the presence of disturbance (current) in the loop, which compromises the accuracy of the impedance measurement.
20	Indicates that the main display shows the date (when the rotary switch is set to MR or SET-UP).
21	Indicator of freezing the measurement display when the HOLD button is pressed or while in the AUTO-HOLD mode.
22	Display of the buzzer's active state; the icon is not shown when the buzzer is inactive. Selection of the buzzer operating mode is made in SET-UP (see § 4.4, menu #2).

2.5 Control Features

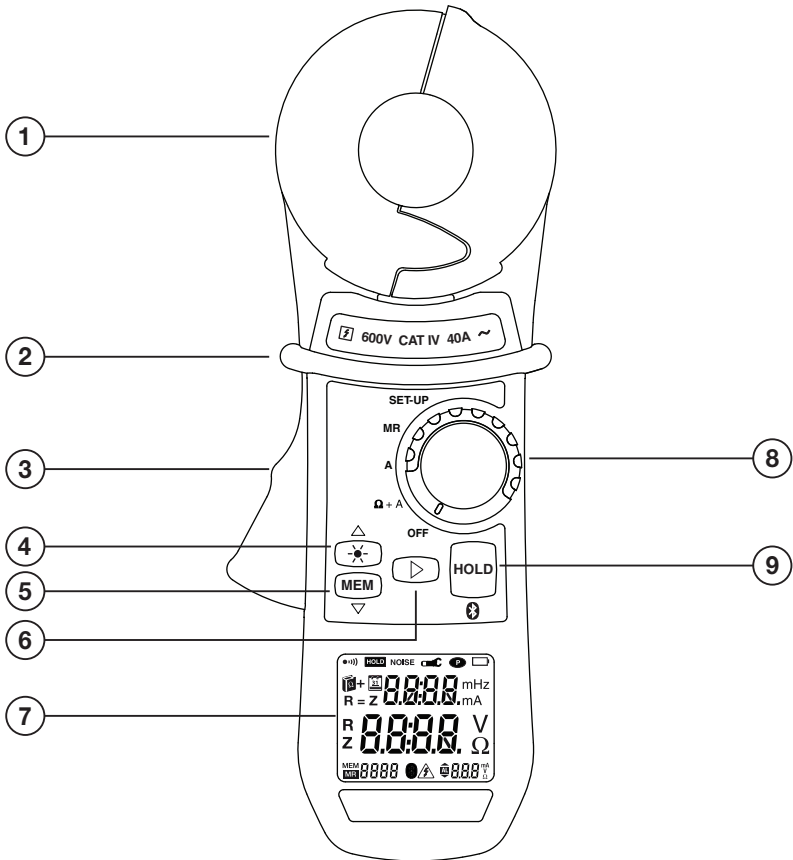

Figure 2-2

1. **Head Assembly:** Consists of two individually shielded magnetic cores
2. **Guard:** Safety guard; do not place hands above this guard
3. **Lever:** Opens or closes the jaws
4. : Toggles display backlight ON/OFF
5. **MEM:** Stores measurements into memory
6. : Navigates and validates measurement displays
7. **OLED Display:** Crisp, clean and bright display
8. **Rotary Switch:** Selects measurement functions and instrument **SET-UP**
9. **HOLD:** Freezes last measured value on the display
Turns Bluetooth ON/OFF (when switch is set to **MR** or **SET-UP**)

2.6 Audible Signals

There are four audible signals:

Type	Duration	Description
Low-pitched	Short	Normal use (button pressed).
	Permanent	High/Low alarm threshold (Ω , A) triggered.
High-pitched	Short	Abnormal use (for example, memory full).
	Permanent	Alarm threshold (V) exceeded.

Audible signals can be enabled or disabled in **SET-UP** (see § 4.4, menu #2).

The **••)** symbol indicates:

••)	Description
Visible	Buzzer enabled; an alarm or a button press causes an audible signal to be emitted.
Not Visible	No audible signal is emitted.

This programming is backed-up and retrieved at each reset.

During a measurement, a long press on the ► button toggles between activation and deactivation of the buzzer.









NOTE: Since the measurement frequency is audible, the operator hears a beeping signal. This is neither an operating fault nor an alarm, and it cannot be eliminated. This audible signal is amplified by the presence of current in the loop.

2.7 Rotary Switch Functions

Range	Description
OFF	Instrument is powered OFF.
Ω+A	Simultaneous selection of the loop impedance measurement and the leakage current measurement.
A	Current measurement selection
MR	Displays stored measurements.
SET-UP	Access to the instrument configuration and deletion of stored measurements.

2.8 Button Functions

Button	Description
	<ul style="list-style-type: none"> • When the rotary switch is set to Ω+A or A: Increases the brightness of the display, making it easier to read the display in an environment with strong background illumination. Highlighting activated for 30 seconds. • When the rotary switch is set to SET-UP or MR: Serves as the  arrow when browsing in the menus and values. The brightness of the display does not change when device is set to SET-UP or MR.
<p>MEM</p> 	<ul style="list-style-type: none"> • When the rotary switch is set to Ω+A or A: Records the measured value. All of the data is recorded in the Standard or Advanced mode. • When the rotary switch is set to SET-UP or MR: Serves as the  arrow when browsing in the menus and values.
	<ul style="list-style-type: none"> • When the rotary switch is set to Ω+A (Advanced Mode): <i>Short Press:</i> Switches the display through the following three modes: <ul style="list-style-type: none"> - Display of the impedance recalculated at the selected frequency. - Display of the contact voltage (product Z^*l). - Display of R and L. <i>Long Press:</i> Enables or disables the audible alarms. • When the rotary switch is set to SET-UP: <ul style="list-style-type: none"> - Validation when browsing in the menus and values. • When the rotary switch is set to MR (Advanced Mode): <ul style="list-style-type: none"> - Switches the display through the measurement screens and the measurement date/time.
<p>HOLD & AUTO-HOLD</p>	<ul style="list-style-type: none"> • When the rotary switch is set to Ω+A: <ul style="list-style-type: none"> - Freezes the displayed measurement for as long as the HOLD button is pressed. The NOISE, clamp open () and alarm exceedence () icons are visible, if they were active. • When the rotary switch is set to MR or SET-UP: <ul style="list-style-type: none"> - Enables or disables the Bluetooth® connection. • AUTO-HOLD Function: If the AUTO-HOLD mode was enabled during instrument SET-UP (see § 4.4, menu #11), opening the clamp acts as the identical state to the HOLD mode for as long as the clamp is open. The benefit of this function is that it makes it easy to freeze the measurement with one hand, when access to the HOLD button is difficult. If the HOLD button is not pressed during this time, closing the clamp automatically exits the AUTO-HOLD mode.

3. PRINCIPLE OF OPERATION

Typically, a grounded distribution system can be simulated by the basic circuit shown in Figure 3-1 or an equivalent to the diagram shown in Figure 3-2. If voltage (V) is applied to any measured grounding electrode Rx through a special transformer; current (I) flows through the circuit, thereby establishing the following equation:

$$\frac{V}{I} = R_x + \frac{1}{\sum_{i=1}^n \frac{1}{R_i}} \quad \text{where, usually} \quad R_x \gg \frac{1}{\sum_{i=1}^n \frac{1}{R_i}}$$

Therefore, $V/I = R_x$ is established. If I is detected and measured with V kept constant, the measured grounding electrode resistance Rx can be obtained. A signal is fed to a special transformer via a power amplifier from a 2403Hz constant voltage oscillator. The resulting current is then sensed by a detection CT (current transformer). An active filter is used to dampen earth current at commercial frequency (50/60Hz) and high-frequency noise.

Example: If clamped around any grounding electrode in a multi-grounded system, the measured value of the electrode under test will be the resistance of that particular rod in series with the equivalent parallel resistance value that the rest of the multi-grounded system represents. If an electrical system had 101 grounding electrodes and each had a resistance value of 25Ω, and it were clamped around any electrode in the system, the measured value would be 25Ω in series with the equivalent parallel resistance of the other 100 electrodes or 0.25Ω. The displayed value would be 25.2Ω (instrument resolution to 0.1Ω).

$$V/I = 25\Omega + 0.25\Omega$$

$$R_x = 25.2\Omega$$

In most field applications, the number of electrodes that make up a multi-grounded system would be higher; therefore the equivalent parallel resistance is negligible with respect to the rod under test.

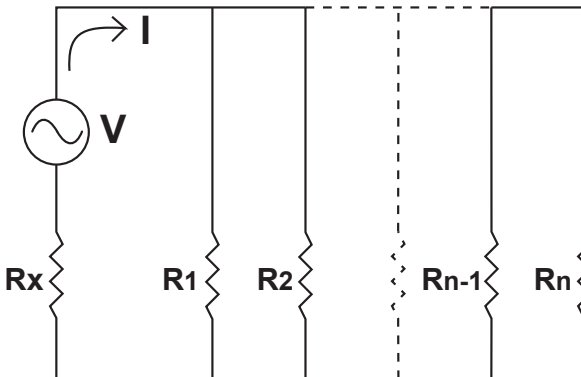

Figure 3-1

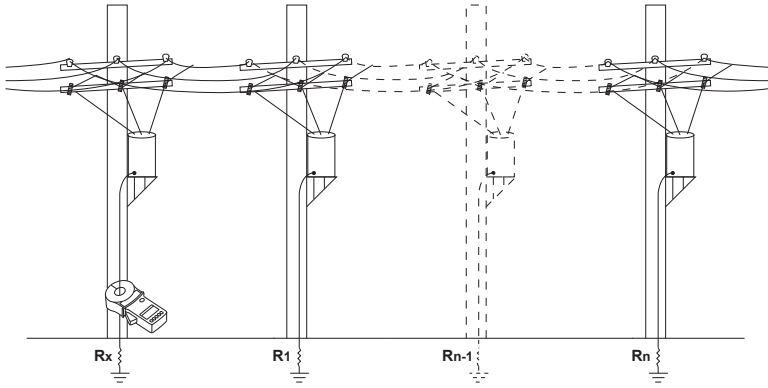

Figure 3-2

4. SET-UP

Turn the rotary switch to the **SET-UP** position.

4.1 Menu Items

The **SET-UP** position gives access to the following options to set user defined parameters for instrument configuration:

No.	Function
1	Erases stored measurements.
2	Enables/disables the buzzer.
3	Enables/disables Auto Power OFF
4	Sets the impedance alarm threshold (Ω).
5	Sets the voltage alarm threshold (V).
6	Sets the current alarm threshold (I).
7	Sets the date.
8	Sets the time.
9	Selects the Standard or Advanced operating mode.
10	Selects the test frequency for the impedance.
11	Enables/disables the AUTO-HOLD mode.
12	Displays the version number.
13	Not used.

4.2 SET-UP Menu Displays

The 12 accessible menus (listed above) are clearly identified by their title and number, as shown in the example in Figure 4-1 (menu #5) which displays the voltage alarm threshold adjustment (AL. V).

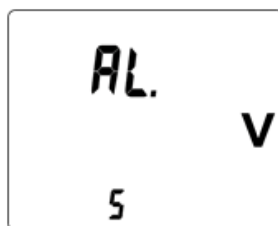

Figure 4-1

4.3 Selecting a Specific Menu

Use the buttons as follows to select a specific menu item:

Button	Action
▲	Move up in the menu tree.
▼	Move down in the menu tree.
▶	Select the menu displayed or return to the previous menu.



NOTE: When changes have been made in one of the **SET-UP** menus, the changes can be cancelled by turning the rotary switch to a position other than **SET-UP**, provided that there has not been a return to the main menu (by pressing ▶).

4.4 SET-UP Menus

Menu #	Indication	Function
1	<i>CLr</i>	<p>Erasing the Memory:</p> <ul style="list-style-type: none"> ■ Enter the menu by ▶. <i>CLr</i> blinks. ■ Press ▲ and ▼ simultaneously for 6 seconds. All recorded data is erased. The meter indicates <i>MEM 0</i>. ■ Return to the previous menu by ▶.
2	<i>Snd</i>	<p>Enabling/Disabling the Buzzer:</p> <ul style="list-style-type: none"> ■ Enter the menu by ▶. <i>Snd</i> blinks. ■ Press ▲ or ▼. ■ The Buzzer is enabled when the ●))) icon is visible and disabled when it is masked. ■ Return to the previous menu by ▶. <p>NOTE: In the Ω+A and A measurement modes, a long press on ▶ activates or deactivates the audible alarms.</p>
3	<i>StOP</i>	<p>Enabling/Disabling Auto Power OFF:</p> <ul style="list-style-type: none"> ■ Enter the menu by ▶. <i>StOP</i> blinks. ■ Press ▲ or ▼. ■ Auto Power OFF is deactivated when the P icon is visible and activated when it is hidden. ■ Return to the previous menu by ▶.

Menu #	Indication	Function
4	AL. Ω	<p>Setting the Impedance Alarm Threshold (Ω):</p> <ul style="list-style-type: none"> ■ Enter the menu by ►. AL. Ω blinks. ■ Press ▲ or ▼ to select the state of the alarm: <ul style="list-style-type: none"> - AL: Disabled. - AL: Enabled for a measurement exceeding the threshold. - AL: Enabled for a measurement below the threshold. ■ Validate by ►. <p>Setting the Alarm Value:</p> <ul style="list-style-type: none"> ■ Press ▲ or ▼ to select the impedance alarm threshold (Figure 2-1, item #11). ■ Validate and return to the previous menu by ►.
5	AL. V	<p>Setting the Voltage Alarm Threshold (V):</p> <ul style="list-style-type: none"> ■ Enter the menu by ►. AL. V blinks. ■ Press ▲ or ▼ to select the state of the alarm (Figure 2-1, item #10): <ul style="list-style-type: none"> - AL: Disabled. - AL: Enabled for a measurement exceeding the threshold. ■ Validate by ►. <p>Setting the Alarm Value.</p> <ul style="list-style-type: none"> ■ Press ▲ or ▼ to select the alarm threshold value (Figure 2-1, item #11). ■ Validate and return to the previous menu by ►.
6	AL. A	<p>Setting the Current Alarm Threshold (I):</p> <ul style="list-style-type: none"> ■ Enter the menu by ►. AL. A blinks. ■ Press ▲ or ▼ to select the state of the alarm (Figure 2-1, item #10): <ul style="list-style-type: none"> - AL: Disabled. - AL: Enabled for a measurement exceeding the threshold. ■ Validate by ►. <p>Setting the Alarm Value.</p> <ul style="list-style-type: none"> ■ Press ▲ or ▼ to select the current alarm threshold (Figure 2-1, item #11). ■ Validate and return to the previous menu by ►.

Menu #	Indication	Function
7	<i>dAtE</i>	<p>Setting the Date:</p> <ul style="list-style-type: none"> ■ Enter the menu by ►. <i>dAtE</i> blinks. ■ Press ▲ or ▼ to select the year. Validate by ►. ■ Press ▲ or ▼ to select the month. Validate by ►. ■ Press ▲ or ▼ to select the date. ■ Validate and return to the previous menu by ►. <p>NOTE: In some locations the order of the date values is displayed as Year, Date, Month.</p>
8	<i>HOuR</i>	<p>Setting the Time:</p> <ul style="list-style-type: none"> ■ Enter the menu by ►. <i>HOuR</i> blinks. ■ Press ▲ or ▼ to select the AM/PM (A. or P.) or 24H display mode (24H), which blinks. Validate by ►. ■ Press ▲ or ▼ to select the hour, which blinks. Validate by ►. ■ Press ▲ or ▼ to select the minutes value, which blinks. ■ Validate and return to the previous menu by ►.
9	<i>USE</i>	<p>Selecting Standard or Advanced Operating Mode:</p> <ul style="list-style-type: none"> ■ Enter the menu by ►. <i>USE</i> blinks. ■ Press ▲ or ▼ to select the Standard or Advanced mode. <ul style="list-style-type: none"> - Advanced Mode: The  icon is displayed. - Standard Mode: <i>Std</i> is displayed. ■ Validate and return to the previous menu by ►.
10	<i>FrEQ</i>	<p>Choosing the Test Frequency for the Impedance in Advanced Mode:</p> <ul style="list-style-type: none"> ■ Enter the menu by ►. <i>FrEQ</i> blinks. ■ Press ▲ or ▼ to select the transposition frequency of the measured impedance from among the four possible values: 50, 60, 128, and 2083 Hz. ■ Validate and return to the previous menu by ►.

Menu #	Indication	Function
11	<i>HOLd</i>	<p>Enabling/Disabling the AUTO-HOLD Mode:</p> <ul style="list-style-type: none"> ■ Enter the menu by ►. <i>HOLd</i> blinks. ■ Press ▲ or ▼ to switch the AUTO-HOLD mode to active or inactive. <ul style="list-style-type: none"> - AUTO-HOLD Mode Disabled: Only the HOLD icon is displayed. - AUTO-HOLD Mode Enabled: The HOLD and ⏻ icons are displayed. ■ Validate and return to the previous menu by ►.
12	<i>VER</i>	<p>Displaying the version number</p> <ul style="list-style-type: none"> ■ Enter the menu by ►. ■ The version number is displayed. ■ Return to the previous menu by ►.
13	<i>CAL</i>	<p>Reserved for factory use - not used for normal operation</p>

5. OPERATION

5.1 Inserting the Batteries

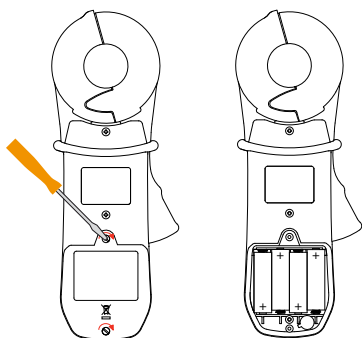

Figure 5-1

- Unclamp and remove the instrument from any connections and turn the rotary switch to the OFF position.
- Use a Philips head screwdriver to unscrew the two attachment screws and remove the battery compartment cover.
- Remove the old batteries and replace them with four new batteries (LR6, AA, 1.5V), observing the polarities.
- Close the battery compartment cover and tighten the two screws.
- Check for the proper operation of the device.



NOTE: The alkaline batteries can be replaced by NiCd or NiMH rechargeable batteries (AA, 1.2V) having similar characteristics. However, the time between the low battery message and the Auto Power OFF will be shorter with the rechargeable batteries.



Used batteries must not be treated as ordinary household waste. Recycle them appropriately.

5.2 Setting the Date and Time

Setting the clock, which is used for time-stamping measurements, is done only the first time the clamp is used or after it has been without battery power for more than two minutes.

Set the function switch to **Ω +A**. All icons on the display light for approximately two seconds. Enter the date and time using the **▲**, **▼**, and **▶** buttons.

The date and time can also be configured before a measurement in **SET-UP** (see § 4.4, menu #7 & #8).



NOTE: If time-stamping is not needed, this operation can be skipped by pressing the **▶** button until the measurement screen corresponding to the switch setting (**Ω +A**, **A**, **MR** or **SET-UP**) is displayed.

5.3 Display Example

Figure 5-2 shows a typical display upon first use, with the device set to $\Omega+A$. In this example the measured current is 30.0mA and the impedance is 7.9 Ω .

The buzzer is active and the memory is empty.

NOTE: This display corresponds to the device in Standard mode. In Advanced mode, two additional screens are available (see § 6.1.2.2).

Figure 5-3 shows a display, upon first use, with the device set to **A**. In this example, the current measured is 30.0mA.

The buzzer is active and the memory is empty.



Figure 5-2



Figure 5-3

5.4 Turning the Instrument ON



With the clamp closed and not clamped around any conductor, set the rotary switch to a position other than OFF. All icons on the display light for approximately two seconds, before possible entry of the date and time (see § 5.2).

During the first few seconds of operation, the clamp automatically adjusts correction factors to optimize the impedance measurement. This correction makes it possible to allow for the variations of the measurement head air gap that may occur in some temperature and humidity conditions.

During this adjustment, the screen displays **CAL GAP**. If the clamp detects a problem, it indicates **Err CAL** when the switch is set to $\Omega+A$. Turn the instrument OFF, disconnect it from any conductor and make sure the sensor heads are clean with no obstructions, then turn it back ON.

When this adjustment is done, the clamp displays the screen corresponding to the switch setting.

5.5 Turning Bluetooth ON

1. Rotate the rotary switch to the MR or Setup position.
 2. Press and release the **HOLD** /  button.
- When Bluetooth (BT) is ON you will see a flashing Bluetooth icon () at the bottom of the display.
 - To turn Bluetooth OFF, repeat the steps given above.
 - Once Bluetooth is ON you can rotate the rotary switch to any position (except OFF) and the Bluetooth will remain ON.

5.6 Turning the Instrument OFF

The instrument can be turned OFF in two ways:

- **Manually:** Turn the rotary switch to **OFF**.
- **Auto Power OFF:** This function activates after 5 minutes of no activity (no button press, no change of switch setting, and no opening of the jaws).
 - Fifteen seconds before Auto Power OFF, a short audible signal is emitted and the display blinks once a second.

Auto Power OFF can be disabled in **SET-UP** (see § 4.4, menu #3). The  symbol is then displayed.

5.7 Standard and Advanced Modes

The instrument has two modes.

- **Standard Mode:** Makes the standard loop resistance and leakage current measurements.
- **Advanced Mode:** Used to refine and complete the measurements:
 - Impedance at the selected frequency.
 - Contact voltage.
 - Resistive and inductive components of the loop impedance.

The choice of Standard or Advanced mode and the alarm thresholds are configured in **SET-UP** (see § 4.4, menu #9).

5.8 Memory

5.8.1 Memory Capacity

The Model 6417 has a recording capacity of 2000 measurements. The PC interface can be used to activate a circular (first in/first out) recording mode in which the 2000 most recent values are kept, with a maximum sequence number of 9999. If the circular recording mode is activated; as soon as the threshold of 2000 values is exceeded, the sequence number is displayed alternately with *FULL* in order to report the overwriting of the oldest records. When the threshold of 9999 records is reached, the sequence number is replaced by *FULL*. The next time the **MEM** button is pressed, a beep is emitted and the *FULL* indication blinks.

5.8.2 Storing Measurements into Memory

The values displayed during the measurements can be stored in memory and read later.

Storage of the data is available in both the **Ω+A** and **A** measurement modes, provided that memory locations are free.

Data is stored as soon as the **MEM** button is pressed. A long audible signal confirms the storage.

All calculated impedance and/or current values, together with the values accessible in the secondary screens in Advanced mode, are stored as soon as the **MEM** button is pressed, such as:

- Current measurement (**A**)
- Measurement of the resistance, inductance, and impedance (**Z**)
- Contact voltage measurement (**V**)
- Present configuration of the clamp
- Sequence number of the record
- Time and date of the record

The display indicates the sequence number of the last measurement recorded, or 0 if the memory is empty. The data is preserved when the device is OFF or without a battery.

5.8.3 Reading Stored Data

The data can be read using the **MR** function (see § 6.3).

5.8.4 Erasing the Memory

Refer to § 4.4, menu #1.

5.8.5 Using the ▲ and ▼ Buttons

The ▲ and ▼ buttons are used to view the various stored measurements. If these buttons are held down, the sequence number is scrolled at a rate of 3 counts per second; after 5 seconds, the rate is increased to 10 counts per second. Each time the sequence number changes, the value of the corresponding measurement is displayed. The *MR* symbol remains displayed as a reminder that the memory recall function is active.

It is possible to scroll past the oldest recorded value to the most recent, or past the most recent recorded value to the oldest.

When circular recording is activated, the sequence number of the oldest record is not necessarily 1: the remaining records may be numbered from 44 to 2043, for example.

5.8.6 Exporting Data to a PC

The Model 6417 has a communication capability and can transfer the recorded measurements to a PC using the supplied DataView software (see § 7).

5.9 Alarm Management

The device has three distinct alarms that can be configured.



NOTE: The (Ω , V, A) alarm thresholds can be configured in **SET-UP** (see §4.4).

5.9.1 Voltage Alarm

- If the voltage (product $Z \times I$) exceeds the threshold set, the alarm symbol and the alarm threshold blink.
- If the buzzer is active, a high-pitched audible warning signal is emitted.

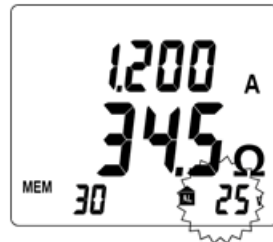

Figure 5-4

5.9.2 Current Alarm

- If the current exceeds the threshold set, the alarm symbol and the alarm threshold blink.
- If the buzzer is active, a low-pitched audible signal is emitted.

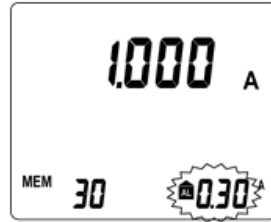

Figure 5-5

5.9.3 Impedance Alarm

If there is no voltage alarm, no detection of noise, and no current alarm, an alarm on the impedance may be triggered. If the buzzer is enabled, the corresponding audible signal is emitted.

- **Low Threshold Configuration:**
An audible signal is emitted when the impedance is below the threshold set (continuity type measurement).
- **High Threshold Configuration:**
An audible signal is emitted at values exceeding the threshold (detection of a grounding impedance that is too high).

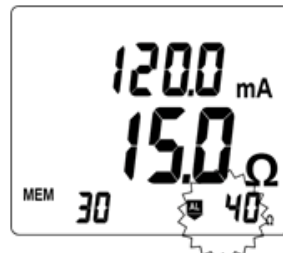

Figure 5-6

If the impedance crosses the selected threshold, a low-pitched audible signal is emitted.

5.9.4 No Alarm Detection

If no alarm is activated, the alarm icons are not displayed.

- When no alarm is triggered, the alarm threshold is displayed, along with the direction of triggering (\overleftarrow{AL} , \overrightarrow{AL}) of the impedance, voltage, or current alarm.



Figure 5-7

5.9.5 Priority of the Alarms

If several alarms are triggered simultaneously, a priority rule determines the display and the corresponding sound:

- The voltage alarm has priority because it concerns the user's safety.
- The current alarm is second in priority.
- The impedance alarm is displayed when no other alarm is triggered.

6. MEASUREMENT MODES

6.1 Rotary Position Ω +A

6.1.1 Standard Mode

Selection of Standard mode is performed in the **SET-UP** (see § 4.4, menu #9).

In Standard mode, only one measurement screen is available. The clamp measures the loop impedance (Ω) (at the fixed frequency of 2083Hz) and the leakage current.



NOTE: Since the measurement frequency is audible, the operator hears a beeping signal. This is neither an operating fault nor an alarm, and it cannot be eliminated. This audible signal is amplified by the presence of current in the loop.

The alarm thresholds can be configured as desired (see § 4.4, menus #4, #5 & #6).

6.1.1.1 Making a Measurement

- Turn the rotary switch to the **Ω +A** position, and wait several seconds while the instrument performs internal calibration.
- Clamp around the conductor to be measured. If the clamp is incorrectly closed, the  icon is displayed.
- If necessary, use the **HOLD** button to freeze the measurement.
- If necessary, use the **MEM** button to store the measurement.



NOTE: If the measured impedance is less than 1Ω , the measurement display alternates between the value measured and the word *LOOP*, in order to call the user's attention to the risk of measuring a local loop at the test point that does not include the earth/ground measurement.

6.1.1.2 Measurement Results

Once the measurement has stabilized, the display indicates:

- The leakage current.
- The impedance of the loop at the frequency of 2083Hz.

The impedance is measured only if the leakage current is less than 10A. In the 10 to 40A range, only the current is displayed; the NOISE symbol blinks and the impedance is replaced by dashes.



Figure 6-1

To store the measurement into memory, press the **MEM** button (see § 5.8.2).

If the contact voltage exceeds 50V, the display indicates the current/impedance measurements and the contact voltage alternately.

6.1.2 Advanced Mode

Selection of Advanced mode is performed in the **SET-UP** (see § 4.4, menu #9).

In this mode, three measurement screens are provided, impedance referred to the chosen frequency and leakage current, contact voltage, display of R (resistance) and L (inductance). The clamp measures the loop impedance (Ω) at the frequency of 2083Hz. However, in addition to what is measured in Standard mode, the impedance is recalculated at the frequency defined by the configuration.

The frequency and alarm thresholds can be configured as desired (see § 4.4, menus #4, #5 & #6).

6.1.2.1 Making a Measurement

- Turn the rotary switch to the **Ω +A** position, and wait several seconds while the instrument performs internal calibration.
- Clamp around the conductor to be measured. If the clamp is incorrectly closed, the **CCC** icon is displayed.
- If necessary, use the **HOLD** button to freeze the measurement.
- If necessary, use the **MEM** button to store the measurement.

6.1.2.2 Measurement Results

First Screen:

Once the measurement has stabilized, the display shows the first screen, which indicates:

- The leakage current.
- The loop impedance referenced to the chosen frequency.

The impedance is measured only if the leakage current is less than 10A. In the 10 to 40A range, only the current is displayed; the NOISE symbol blinks and the impedance is replaced by dashes.



Figure 6-2

Second Screen:

Press ► to display the second screen, which indicates the contact voltage (product ZxI).

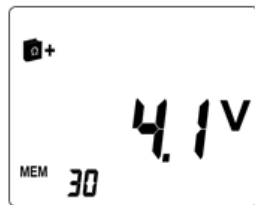

Figure 6-3

Third Screen:

Press ► to display the third screen, which indicates the values of R and L. The loop inductance and loop resistance are displayed.

When the inductive component is negligible* with respect to the resistive component, the symbol R=Z is displayed, and only the impedance is displayed; the inductance is replaced by dashes.

* $R > 25\Omega$ or $R[\Omega] / L[H] > 10^5$



Figure 6-4

6.1.3 General Information

This information is displayed in both Standard and Advanced modes.

PRODUCT ZxI GREATER THAN 50V

- The blinking NOISE symbol is displayed.
- The impedance blinks.
- The hazardous voltage symbol blinks.



Figure 6-5

IMPEDANCE GREATER THAN 1500Ω

In this case:

- The impedance display indicates *O.R* (Over Range).



Figure 6-6

LEAKAGE CURRENT DISTURBANCE

If the current is greater than 5A, or if it is significantly disturbed:

- The blinking NOISE symbol is displayed.
- The impedance blinks.

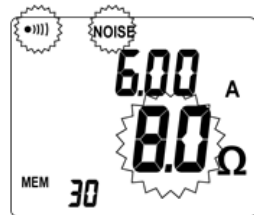

Figure 6-7

CURRENT GREATER THAN 10A

If the current is greater than 10A:

- The blinking NOISE symbol is displayed.
- The impedance is replaced by - - - -

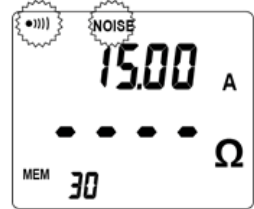

Figure 6-8

CURRENT GREATER THAN 40A

If the current is greater than 40A:

- The current display indicates *O.R* (Over Range).

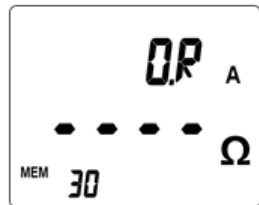



Figure 6-9

6.2 Rotary Position (A)

In the **A** position, the clamp measures the electrical current, independently of any ground/earth measurement.

If desired, configure the current alarm threshold as desired (see §4.4, menu #6).

6.2.1 Making a Measurement

- Turn the rotary switch to the **A** position, and wait several seconds while the instrument performs internal calibration.
- Clamp around the conductor to be measured. If the clamp is incorrectly closed, the  icon is displayed.
- If necessary, use the **HOLD** button to freeze the measurement.
- If necessary, use the **MEM** button to store the measurement.

Once the measurement has stabilized, the display will indicate the value of the current flowing in the conductor.

NOTE: If the preset alarm threshold is exceeded, the threshold set value and the value of the current measured blink.

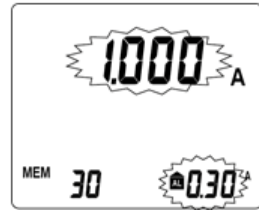

Figure 6-10

6.3 Rotary Position - (MR)

The **MR** position (Memory Recall) is used to display measurements previously stored when the **MEM** button was pressed.

6.3.1 Displaying Stored Measurements

- Set the function switch to the **MR** position.
- The type of data that is displayed is dependent on whether Standard or Advanced mode was selected during **SET-UP** (see § 4.4, menu #9).

6.3.1.1 Data Displayed in Standard Mode

The last measurement is displayed. The MR symbol and the sequence number of the record being recalled are also displayed.

Figure 6-11 illustrates an impedance plus a current measurement ($\Omega+A$ setting).



Figure 6-11

The stored values are displayed as they were when recorded: same display range, alarm states, NOISE signal, battery condition, etc.

However, the audible alarms are not reproduced; only the *AL* symbol and the alarm threshold blink.

Figure 6-12 illustrates a current measurement (**A** setting).

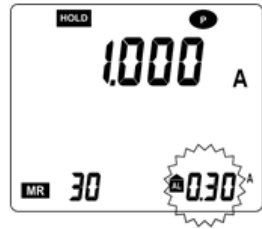

Figure 6-12

Press ► to display the measurement storage date/time screen.

To exit from the **MR** mode, set the rotary switch to the desired mode.



Figure 6-13

6.3.1.2 Data Displayed in Advanced Mode

First Screen:

- The last measurement is displayed, namely the impedance referenced to the chosen frequency.
- The MR symbol and the sequence number of the record being recalled are also displayed.
- Figure 6-14 illustrates an impedance and current measurement.
- Press ► to display the next screen.



Figure 6-14

Second Screen:

- Figure 6-15 illustrates a contact voltage measurement (product $Z \times I$).
- Press ► to display the next screen.



Figure 6-15

Third Screen:

- Figure 6-16 illustrates a resistance and impedance measurement (switch set to $\Omega+A$).
- Press ► to display the next screen.



Figure 6-16

Fourth Screen:

- Figure 6-17 illustrates the date and time of the measurement (switch set to $\Omega+A$), namely:
 - 12:30: December 30
 - 15:39: 1539 hours
- Press ► to return to the first screen.
- To exit from the **MR** mode, set the rotary switch to the desired mode.



Figure 6-17

7. DATAVIEW® SOFTWARE

7.1 Installing DataView®



DO NOT CONNECT THE INSTRUMENT TO THE PC BEFORE INSTALLING THE SOFTWARE AND DRIVERS.

NOTE: When installing, the user must have Administrative access rights during the installation. The users access rights can be changed after the installation is complete. DataView® must be reinstalled for each user in a multi-user system.

USB Flash Drive Install

1. Insert the USB stick into an available USB port on the computer.
2. If Autorun is enabled then an AutoPlay window should appear as shown.

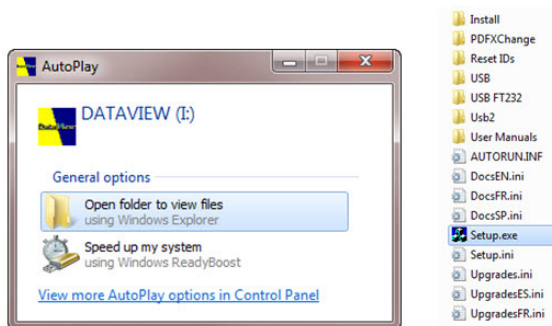

Figure 7-1



NOTE: If Autorun is disabled, it will be necessary to open Windows Explorer, then locate and open the USB drive labeled "DataView" to view the files.

3. In the AutoPlay window, select **Open Folder to view Files**.
4. Double-click on **Setup.exe** from the opened folder view to launch the DataView setup program.



NOTE: Depending on your operating system, the **User Account Control** dialog box may be displayed. Provide a positive response when prompted to proceed.

5. A **Set-up** window, similar to the one below, will appear.

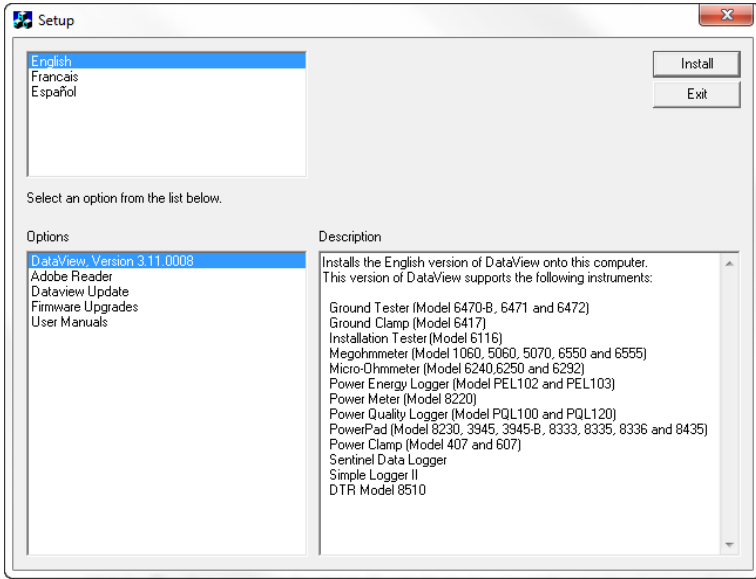

Figure 7-2

There are several options to choose from. Some options (indicated by an asterisk below) require an internet connection.

DataView, Version x.xx.xxxx - Installs DataView® onto the PC.

- ***Adobe Reader** - Links to the Adobe® website to download the most recent version of Adobe® Reader to the computer. *Adobe® Reader is required for viewing PDF documents supplied with DataView®.*
- ***DataView Updates** - Links to the online DataView® software updates to check for new software version releases.
- ***Firmware Upgrades** - Links to the online firmware updates to check for new firmware version releases.
- **Documents** - Shows a list of instrument related documents that you can view. Adobe® Reader is required for viewing PDF documents supplied with DataView®.

6. **DataView, Version x.xx.xxxx** option should be selected by default. Select the desired language and then click on **Install**.
7. The **Installation Wizard** window will appear. Click **Next**.
8. To proceed, accept the terms of the license agreement and click **Next**.
9. In the **Customer Information** window, enter a Name and Company, then click **Next**.

10. In the **Setup Type** window that appears, select the **Complete** radio button option, then click **Next**.
11. In the **Select Features** window that appears, ensure that **Ground Tester** is checked (which it is by default), then click **Next**. (Note that you can also deselect any instruments you don't need at this time.)



NOTE: The **PDF-XChange** option must be selected to be able to generate PDF reports from within DataView®.

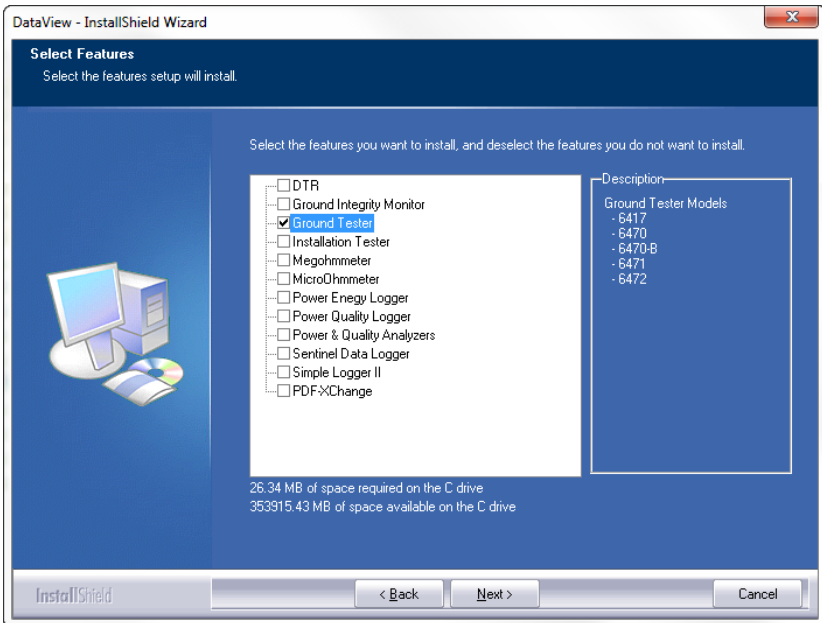

Figure 7-3

12. In the **Ready to Install the Program** window, click on **Install**.
13. If the instrument selected for installation requires the use of a USB port, a warning box will appear, similar to Figure 7-4. Click **OK**.

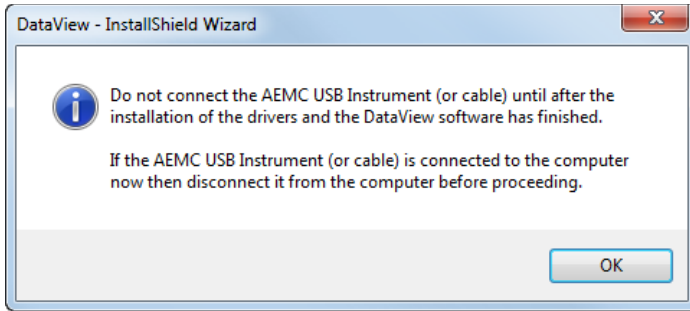

Figure 7-4



NOTE: The installation of the drivers may take a few moments. Windows may even indicate that it is not responding, however it is running. Please wait for it to finish.

14. When the drivers are finished installing, the **Installation Successful** dialog box will appear. Click on **OK**.
15. Next, the **Installation Wizard Complete** window will appear. Click on **Finish**.
16. A **Question** dialog box appears next. Click **Yes** to read the procedure for connecting the Bluetooth USB adapter to the USB port on the computer.



NOTE: The Set-up window remains open. You may now select another option to download (e.g. Adobe® Reader), or close the window.

17. **Restart** your computer, then insert the AEMC Bluetooth USB adapter into the USB port on the computer.
18. Once connected, the **Found New Hardware** dialog box will appear. Windows will complete the driver installation process automatically.

Shortcuts for DataView® and each instrument Control Panel selected during the installation process have been added to your desktop.



NOTE: If you connected your instrument to the computer before installing the software and drivers, you may need to use the **Add/Remove Hardware** utility to remove the instrument driver before repeating the process.

7.2 Connecting the Instrument to a Computer

- Turn the Bluetooth communication function ON (see §5.5).

7.2.1 Bluetooth Connection

The Model 6417 is designed to connect to a computer wirelessly via Bluetooth technology.

The pairing procedure varies depending on your operating system, Bluetooth equipment and driver software.



NOTE: The information in the following sections are only necessary the first time an instrument is connected, or when the Bluetooth USB adapter has been removed then reconnected.

7.2.2 Pairing using Windows Vista / Windows 7/8/8.1/10

1. Begin by connecting the included Bluetooth USB Adapter into an available USB port on the computer. Windows will install any necessary drivers automatically.
2. A Bluetooth symbol (📶) will appear in the system tray once the driver is installed.
3. Right click on the icon and select **Add a Device**.
4. In the **Add a Device** window, select the Model 6417, then select **Next**.

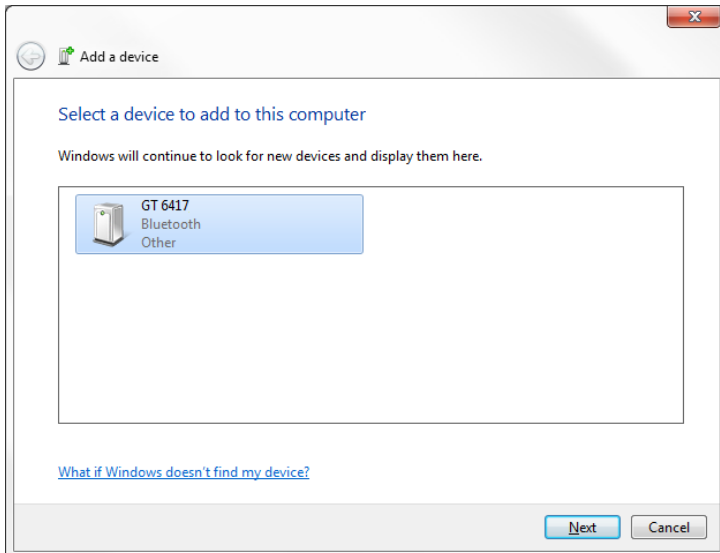

Figure 7-5



NOTE: Depending on the Bluetooth setup and operating system, it may be necessary to enter a passkey to finalize the instrument connection. If so, the default passkey is **1234**.

- Once the instrument has been successfully added to the computer, a window such as the one below will be displayed. Select **Close**.

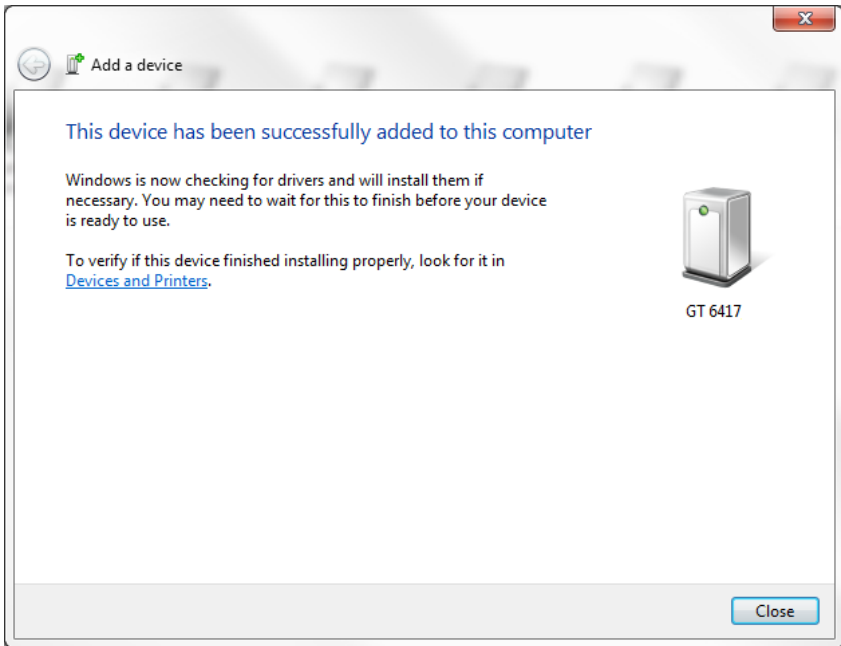

Figure 7-6

- Launch the Control Panel by double-clicking the **Ground Clamp icon** that was placed on the desktop during the DataView® installation. The instrument should automatically connect if only one instrument is paired. If more than one instrument is paired, select the instrument you wish to connect to from the drop-down list in the connection window.
- Selecting OK will establish the connection between the instrument and the Control Panel. It is now possible to configure the instrument, view real-time measurements, and generate reports.

7.3 The Control Panel

To open the Control Panel, double-click the **Ground Clamp** icon that was created during installation, located on the desktop.

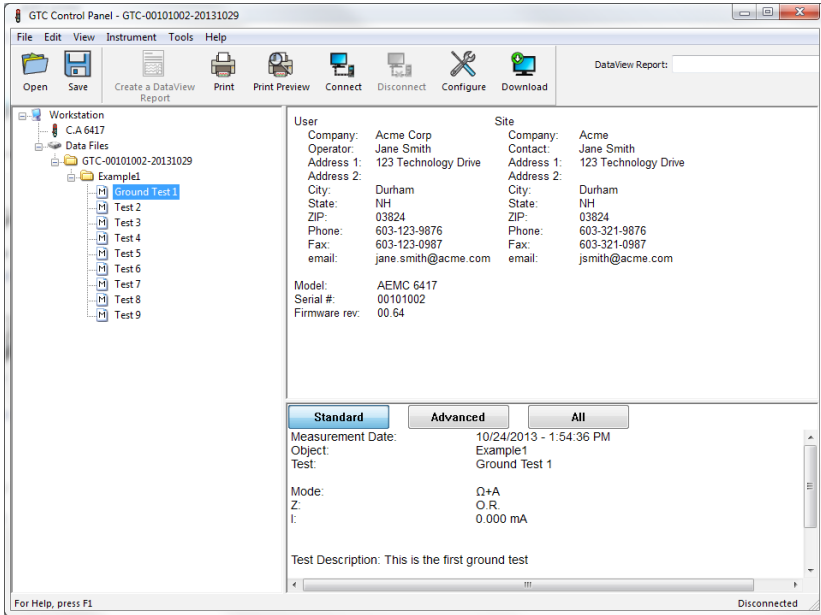

Figure 7-7

The Control Panel opens and displays the following:

- **Menu Bar:** List of main menu options just under the title bar.
- **Navigation tree frame.** This list, on the left side of the Control Panel window, contains a selection tree from which you select what is to be displayed in the data frame.
- **Data frame:** This frame, to the right of the navigation tree frame, contains a textual report of the test data previously downloaded from an instrument, as well as user definable parameters.
- **Toolbar Buttons:** This is a list of buttons that are used to initiate various operations. The following is a list of the available buttons.
 - **Open:** Opens the Open file dialog box allowing you to select the test data file to be opened.
 - **Save:** Saves the current set of test records to a data file.
 - **Create a DataView Report:** Generates a DataView report using the template selected in the DataView Report drop down list.

- **Print:** Prints the selected test report (as seen in the data frame) using the default printer.
- **Print Preview:** Previews the selected test report (as seen in the data frame).
- **Connect:** Opens a connection with an attached instrument.
- **Disconnect:** Closes a connection with the attached instrument.
- **Configure:** Displays the Instrument Configuration dialog box. This dialog box allows you to change various settings stored in the instrument.
- **Download:** Initiates the transfer of test measurements stored in the attached instrument

7.3.1 Establishing Instrument Communication



NOTE: Before proceeding, pair the instrument with the PC first (see § 7.2.2).

Make sure the instrument is turned ON with Bluetooth enabled as explained in §5.5. Then in the Control Panel, click **Instrument** in the menu bar and select **Connect**. The Connection dialog box will appear:

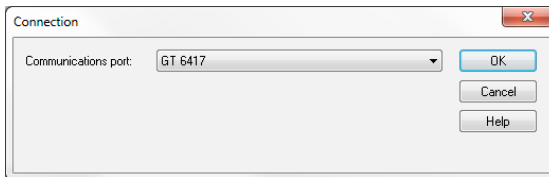

Figure 7-8

- This dialog box allows you to select the desired instrument, or associated serial port used to access the instrument. Specify the desired instrument by selecting it from the **Communications port** drop-down list. In order to have the desired instrument in this list, you should have previously paired the instrument with the PC (see § 7.2.2 - **Note:** During this operation, you may need the Bluetooth pass code, which is 1234).
- **NOTE:** The instrument selection is made either with the serial port number or with the Bluetooth name of the ground tester (starting with “GTC 6417”), depending on the Bluetooth software stack installed on the PC. When the Bluetooth name is personalized in the configuration window, Windows may need some time to propose the updated name.
- Once the proper communication parameters have been specified, click **OK**. This closes the Connection dialog box. When the connection is established, the word **Connected** appears in the lower right corner of the status bar at the bottom of the Control Panel window.

7.4 Configuring the Instrument

To configure the instrument, perform the following steps.

1. In the Control Panel, select **Instrument** in the menu bar and click the **Configure** option.

NOTE: If a connection has not been previously established, the Communication dialog box will appear (see Figure 7-8).

2. Once identification is complete, the Configuration dialog box will appear (if not already open).

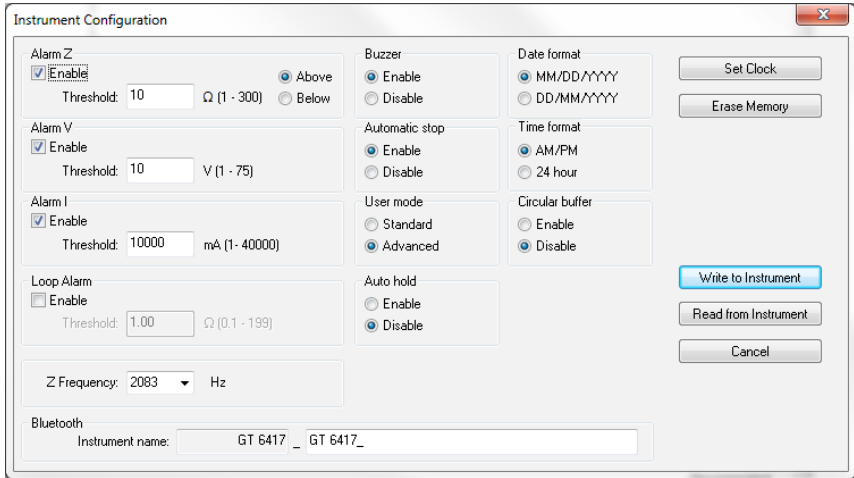

The Instrument Configuration dialog box is titled "Instrument Configuration" and features a close button (X) in the top right corner. It is organized into several sections:

- Alarm Z:** Includes an "Enable" checkbox (checked), a "Threshold" field set to "10", a range selector "Ω (1 - 300)", and radio buttons for "Above" (selected) and "Below".
- Alarm V:** Includes an "Enable" checkbox (checked), a "Threshold" field set to "10", and a range selector "V (1 - 75)".
- Alarm I:** Includes an "Enable" checkbox (checked), a "Threshold" field set to "10000", and a range selector "mA (1- 40000)".
- Loop Alarm:** Includes an "Enable" checkbox (unchecked) and a "Threshold" field set to "1.00" with a range selector "Ω (0.1 - 199)".
- Buzzer:** Includes radio buttons for "Enable" (selected) and "Disable".
- Automatic stop:** Includes radio buttons for "Enable" (selected) and "Disable".
- User mode:** Includes radio buttons for "Standard" and "Advanced" (selected).
- Auto hold:** Includes radio buttons for "Enable" and "Disable" (selected).
- Date format:** Includes radio buttons for "MM/DD/YYYY" (selected) and "DD/MM/YYYY".
- Time format:** Includes radio buttons for "AM/PM" (selected) and "24 hour".
- Circular buffer:** Includes radio buttons for "Enable" and "Disable" (selected).

At the bottom left, there is a "Z Frequency" dropdown menu set to "2083" and a unit selector "Hz". Below that is a "Bluetooth" section with an "Instrument name" field containing "GT 6417 _ GT 6417_".

On the right side, there are several buttons: "Set Clock", "Erase Memory", "Write to Instrument" (highlighted in blue), "Read from Instrument", and "Cancel".

Figure 7-9

This dialog box allows you to configure options for each of the following settings:

- **Alarm Z:** Enables/disables the alarm, specifies the impedance alarm threshold and whether or not the alarm should be triggered when the measured value is above or below the specified threshold.
- **Alarm V:** Enables/disables the alarm and specifies the voltage threshold for the alarm.
- **Alarm I:** Enables/disables the alarm and specifies the current threshold for the alarm.
- **Loop Alarm:** Enables/disables the alarm and specifies the threshold for the loop alarm.
- **Z Frequency:** Selects the desired test frequency.
- **Buzzer:** Enables/disables the feedback buzzer of the instrument.
- **Automatic stop:** Enables/disables automatic stop of the instrument.

- **User mode:** Selects if the instruments operating mode should be standard or advanced.
- **Auto-hold:** Enables/disables the AUTO-HOLD function.
- **Date format:** Specifies the format of dates to be used by the instrument.
- **Time format:** Specifies the format of time to be used by the instrument.
- **Circular buffer:** Enables/disables the instrument's circular buffer function.
- **Bluetooth Instrument name:** Allows you to customize the device name of the instrument when connecting via Bluetooth.
- **Set Clock:** Sets the time within the instrument.
- **Erase Memory:** Deletes all of the test results stored in the instrument.
- **Write to Instrument:** Writes the configuration options as they are set in this dialog box to the instrument.
- **Read from Instrument:** Resets the options in this dialog box to reflect the settings as they are in the attached instrument.
- **Cancel:** Closes this dialog box discarding any changes specified without writing them to the attached instrument.



NOTE: For more information on using DataView®, refer to the online Help within the software.

8. ANDROID APPLICATION

Users of the AEMC® Clamp-on Ground Tester Model 6417 can work with their instruments from an Android device. The Ground Tester 6417 app, distributed through the Google Play Store, provides a quick, convenient, and mobile option for working with a Model 6417. Through a simple, easy-to-learn interface, the app provides a substantial subset of the features and functionality offered in AEMC's DataView® data analysis software, without requiring a PC.

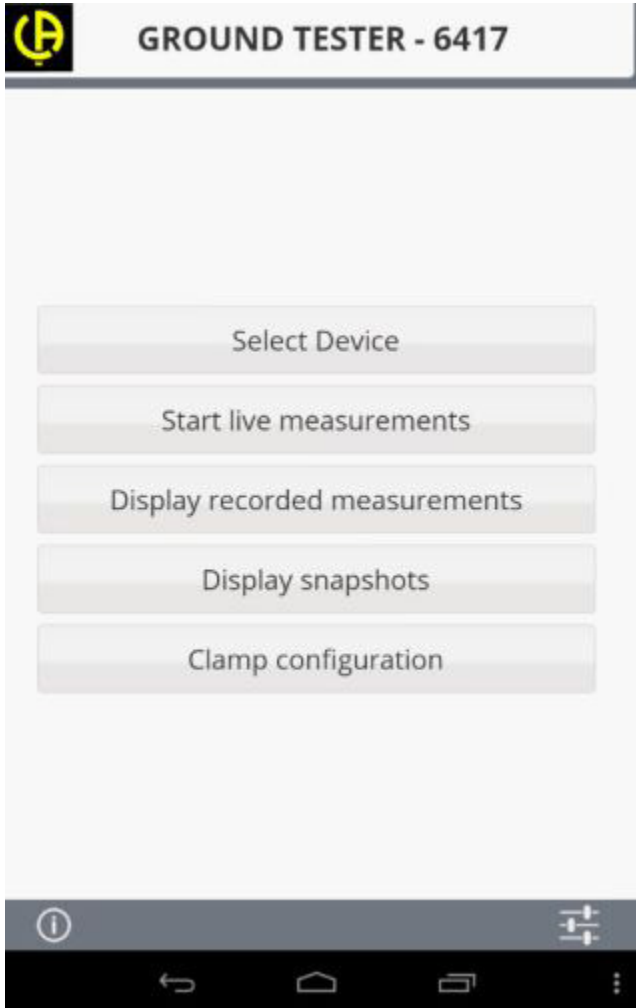

Figure 8-1

Android is a platform for “touch screen” mobile devices such as tablets and smartphones. Introduced in 2007, Android has grown to become the most popular mobile operating system in the world, with an estimated one billion devices (and counting) sold globally.

The Ground Tester 6417 app enables users to connect to the Model 6417 via Bluetooth. Once connected, you can view data currently being measured by the instrument in real-time. Real-time measurements can be displayed as both numerical data and as graphical trends.

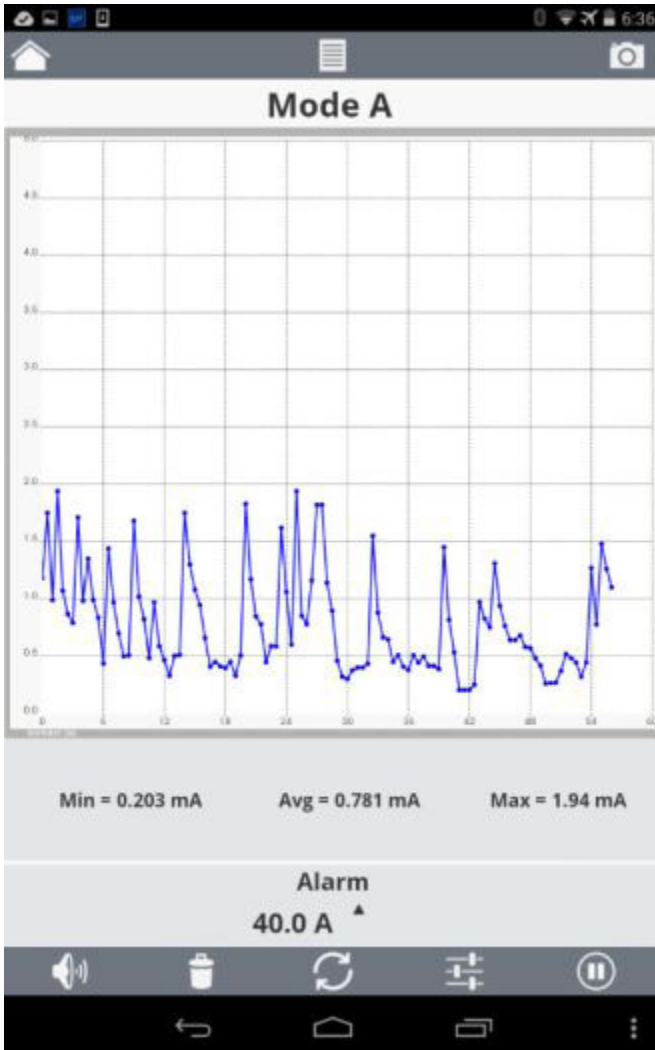

Figure 8-2

Displayed real-time measurements can be saved in the Android device's memory as data records. The app allows you to "localize" each saved record by adding descriptive text, GPS positioning data, and a photograph.



Figure 8-3

These records can later be viewed on the device. They can also be emailed to others for further distribution and analysis. In addition, records can be used to generate reports in text, Excel-compatible, or .icp (DataView) format.

You can also use the app to modify a variety of configuration settings on the Model 6417.

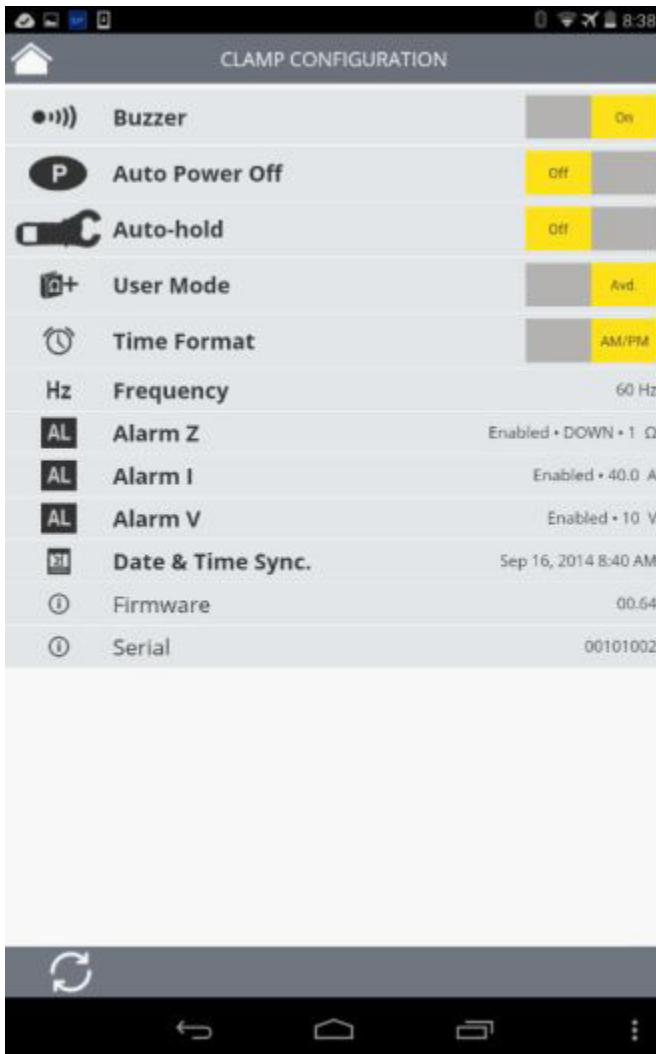

Figure 8-4

The Ground Tester 6417 app can be downloaded free from the Google Play Store (see <https://play.google.com/store/apps/details?id=com.projectCA6417&hl=en>) and is available in multiple languages.

9. SPECIFICATIONS

9.1 Reference Conditions

Influencing Parameters	Reference Values
Ambient temperature	73°F ± 5°F (23°C ± 3°C)
Relative humidity	50% RH ±10%
Battery voltage	6V ±0.2V
Magnetic field	< 40A/m DC (no AC field)
Electric field	< 1V/m
Operating position	Clamp horizontal
Position of the conductor in the clamp	Centered
Measurement environment	No adjacent conductors carrying current within 10cm
Proximity to magnetic mass	> 10cm
Loop resistance	Non-inductive resistance (20Ω for the voltage measurement)
Measured current, sinusoidal frequency	Frequency 50/60Hz Level of distortion < 0.5%
Inferior current in loop resistance measurement	Zero for the resistance and inductance measurements < 3.75A for the voltage measurement

9.2 Electrical

9.2.1 Loop Resistance Measurement

Measurement Range	Resolution	Accuracy
0.010 to 0.099Ω	0.001Ω	±1.5% ±0.01Ω
0.10 to 0.99Ω	0.01Ω	±1.5% ±0.02Ω
1.0 to 49.9Ω	0.1Ω	±1.5% ±0.1Ω
50.0 to 99.5Ω	0.5Ω	±2% ±0.5Ω
100 to 199Ω	1Ω	±3% ±1Ω
200 to 395Ω	5Ω	±5% ±5Ω
400 to 590Ω	10Ω	±10% ±10Ω
600 to 1150Ω	50Ω	20% approx
1200 to 1500Ω	50Ω	25% approx

Alarm: range of threshold from 1 to 199Ω.

Measurement Frequency: 2083Hz

Frequency Selection: Choice of 50, 60, 128, or 2083Hz for the impedance calculation

Maximum overloads: - permanent current 100A maximum (50/60Hz)
- transient current (<5s) 200A (50/60Hz)

9.2.2 Loop Inductance Measurement

Measurement Range	Resolution	Accuracy
10 to 100 μ H	1 μ H	$\pm 5\% \pm 1\mu\text{H}$
100 to 500 μ H	1 μ H	$\pm 3\% \pm 1\mu\text{H}$

9.2.3 Contact Voltage (Touch Voltage)

Contact Voltage Function: Value calculated as the product of the loop impedance by the leakage current.

Measurement Range	Resolution	Accuracy
0.1 to 4.9V	0.1V	$\pm 5\% \pm 0.1\text{V}$
5.0 to 49.5V	0.5V	$\pm 5\% \pm 0.5\text{V}$
50.0 to 75.0V	1V	$\pm 10\% \pm 1\text{V}$

Alarm: Range of thresholds from 1V to 75V.

9.2.4 Current Measurement

Ammeter Function: 0.2 to 40A. 4000-count display.

Measurement Range	Resolution	Accuracy
0.200 to 0.999mA	1 μ A	$\pm 2\% \pm 50\mu\text{A}$
1.000 to 2.990mA 3.00 to 9.99mA	10 μ A	$\pm 2\% \pm 50\mu\text{A}$
10.00 to 29.90mA 30.0 to 99.9mA	100 μ A	$\pm 2\% \pm 100\mu\text{A}$
100.0 to 299.0mA 0.300 to 0.990A	1mA	$\pm 2\% \pm 1\text{mA}$
1.000 to 2.990A 3.00 to 39.99A	10mA	$\pm 2\% \pm 10\text{mA}$

Alarm: Range of thresholds from 1mA to 40A.

9.2.5 Power Supply

- 4x1.5V LR6 (AA) alkaline batteries or 4 NiMH batteries
- Battery Consumption: 140mA approx
- Battery Life: 12 hours, or 1440 30-second measurements approx



NOTE: Extreme environmental conditions may interfere with the internal microprocessor. Simply disconnecting the battery may be enough to eliminate this malfunction.

9.3 Environmental

Quantity of Influence	Limit of the Domain	Quantities Influenced	Typical ⁽³⁾	Max ⁽³⁾
Temperature	-4° to 131°F (-20° to 55°C)	A, $\Omega^{(1)}$, Uc	1 P/10°C +r	2 P/10°C +r
Relative humidity	10% to 90% RH	A, $\Omega^{(1)}$, Uc	P+r	3 P+r
Battery voltage	4 to 6.5V	A, $\Omega^{(1)}$, Uc	0.1 P+r	0.25 P+r
Position of conductor	From the edge to the center	A, Uc, $\Omega^{(1)}$	0.1 P+r 0.05 P+r	0.2 P+r 0.1 P+r
Position of clamp	±90°, 180°	A, Uc, $\Omega^{(1)}$	0.2 P+r 0.1 P+r	0.4 P+r 0.25 P+r
Proximity to magnetic mass	Steel sheet 1mm thick against air gap	A, $\Omega^{(1)}$, Uc	0.1 P+r	0.5 P+r
Magnetic field at 50/60Hz	30A/m	A, Uc	2mA ⁽²⁾ 0.1 P+r	4.5mA ⁽²⁾ 0.5 P+r
Frequency of the current	47 to 800Hz	A, Uc	P+r	2 P+r
Leakage current at 50/60Hz	I<10A R x I<50V	$\Omega^{(1)}$	2 P+r	8 P+r

(1): Ω designates the quantities R, L, and Z.

(2): Offset on the current measurement.

(3): "P" = Accuracy at reference condition; "r" = 1ct on display resolution.

9.4 Mechanical

Jaw Opening: 1.38" (35mm) max

Dimensions: 2.16 x 3.74 x 10.31" (55 x 95 x 262mm)

Weight: 2.06 lbs (935g) approx. with batteries

Environmental: IP40, group III equipment

Drop Test: According to IEC-61010-1

9.5 Safety



Electromagnetic Compatibility

This instrument is compliant with standard IEC-61326-1.

- Electrical safety according to EN 61010-1 (Ed. 2 of 2001)
- Measurement according to EN 61557 (Ed. 2 of 2007) parts 1, 4, and 5.
- NF-EN-61010-2-032 Ed 2012
- 600V CAT IV
- Double Insulated

**Specifications are subject to change without notice*

10. MAINTENANCE

Use only factory specified replacement parts. AEMC® will not be held responsible for any accident, incident, or malfunction following a repair done other than by its service center or by an approved repair center.

10.1 Cleaning



Disconnect anything connected to the device and set the switch to OFF

- Use a soft cloth lightly moistened with soapy water, taking care not to touch the contacts inside the clamp. Wipe with a moist cloth and then completely dry with a dry cloth.
- Never use alcohol, solvents or hydrocarbons.

10.2 Battery Replacement

The Model 6417 is powered by four 1.5V batteries. The battery replacement indicator will blink when battery voltage is low and will display continuously when battery replacement is required.

- The instrument must be OFF and disconnected from any conductor.
- Place the meter face down and remove the two Phillips screws on the back of the instrument.
- Remove back cover from the instrument.
- Remove the used batteries and replace with four new batteries (LR6, AA, 1.5V), observing the polarities.
- Replace the back cover and secure into position by tightening the screws.



Used batteries must not be treated as ordinary household waste. Recycle them appropriately.

10.3 Repair and Calibration

To ensure that your instrument meets factory specifications, we recommend that it be sent to our factory Service Center at one-year intervals for recalibration, or as required by other standards or internal procedures.

For instrument repair and calibration:

You must contact our Service Center for a Customer Service Authorization Number (CSA#). This will ensure that when your instrument arrives, it will be tracked and processed promptly. Please write the CSA# on the outside of the shipping container. If the instrument is returned for calibration, we need to know if you want a standard calibration, or a calibration traceable to N.I.S.T. (Includes calibration certificate plus recorded calibration data).

Ship To: Chauvin Arnoux®, Inc. d.b.a. AEMC® Instruments
15 Faraday Drive
Dover, NH 03820 USA
Phone: (800) 945-2362 (Ext. 360)
(603) 749-6434 (Ext. 360)
Fax: (603) 742-2346 or (603) 749-6309
E-mail: repair@aemc.com

Or contact your authorized distributor.

Costs for repair, standard calibration, and calibration traceable to N.I.S.T. are available.

NOTE: You must obtain a CSA# before returning any instrument.

10.4 Technical and Sales Assistance

If you are experiencing any technical problems, or require any assistance with the proper operation or application of your instrument, please call, mail, fax or e-mail our technical support team:

Chauvin Arnoux®, Inc. d.b.a. AEMC® Instruments
200 Foxborough Boulevard
Foxborough, MA 02035 USA
Phone: (800) 343-1391
(508) 698-2115
Fax: (508) 698-2118
E-mail: techsupport@aemc.com
www.aemc.com

NOTE: Do not ship Instruments to our Foxborough, MA address.

10.5 Limited Warranty

The Clamp-on Ground Tester Model 6417 is warranted to the owner for a period of one year from the date of original purchase against defects in manufacture. This limited warranty is given by AEMC® Instruments, not by the distributor from whom it was purchased. This warranty is void if the unit has been tampered with or abused, or if the defect is related to service not performed by AEMC® Instruments.

Full warranty coverage and product registration is available on our website at www.aemc.com/warranty.html.

Please print the online Warranty Coverage Information for your records.

What AEMC® Instruments will do:

If a malfunction occurs within the one-year period, you may return the instrument to us for repair, provided we have your warranty registration information on file or a proof of purchase. AEMC® Instruments will, at its option, repair or replace the faulty material.

REGISTER ONLINE AT: www.aemc.com

10.6 Warranty Repairs

What you must do to return an Instrument for Warranty Repair:

First, request a Customer Service Authorization Number (CSA#) by phone or by fax from our Service Department (see address below), then return the instrument along with the signed CSA Form. Please write the CSA# on the outside of the shipping container. Return the instrument, postage or shipment pre-paid to:

Ship To: Chauvin Arnoux®, Inc. d.b.a. AEMC® Instruments
15 Faraday Drive
Dover, NH 03820 USA
Phone: (800) 945-2362 (Ext. 360)
(603) 749-6434 (Ext. 360)
Fax: (603) 742-2346 or (603) 749-6309
E-mail: repair@aemc.com

Caution: To protect yourself against in-transit loss, we recommend you insure your returned material.

NOTE: You must obtain a CSA# before returning any instrument.



10/15

99-MAN 100395 v4