

Clamp-On Ground Tester Model 6418

Quick Start Guide ENGLISH











Measure up

www.aemc.com

 **AEMC**[®]
INSTRUMENTS
CHAUVIN ARNOUX GROUP

Thank you for purchasing the AEMC Clamp-On Ground Tester Model 6418.

For best results from your instrument and for your safety, read the enclosed operating instructions carefully and comply with the precautions for use. These products must be only used by qualified and trained users.

	WARNING, risk of DANGER! The operator must refer to these instructions whenever this danger symbol appears.
	Equipment is protected by double insulation.
	Battery.
	Application or withdrawal authorized on conductors carrying dangerous voltages. Type A current sensor per IEC 61010-2-032.
	Useful information or hint to read.
	The product has been declared recyclable after analysis of its life cycle in accordance with the ISO14040 standard.
	Guarantees conformity with European directives and with regulations covering EMC.
	In the European Union, the product must undergo selective disposal for the recycling of electric and electronic material, in compliance with Directive WEEE 2002/96/EC.

Precautions

This instrument is compliant with safety standard IEC 61010-2-032, for voltages up to 100V in category IV or 150V in category III.

Failure to observe the safety instructions may result in electric shock, fire, explosion, and destruction of the instrument and of the installations.

- The operator and/or the responsible authority must carefully read and clearly understand the various precautions to be taken in use. The operator and/or the responsible authority must carefully read and clearly understand the various precautions to be taken in use. Sound knowledge and a keen awareness of electrical hazards are essential when using this instrument.
- If you use this instrument other than as specified, the protection it provides may be compromised, thereby endangering you.
- The safety of any system in which this instrument might be incorporated is the responsibility of the integrator of the system.
- Do not use the clamp above its rated frequency, since this might cause it to overheat dangerously.
- Do not use the instrument on networks of which the voltage or category exceeds those mentioned.
- Observe the environmental conditions of use.
- Do not use the instrument if it seems to be damaged, incomplete, or poorly closed.
- Before each use, check the condition of the insulation on the housing. Any item of which the insulation is deteriorated (even partially) must be set aside for repair or scrapping.
- Before using your instrument, check that it is perfectly dry. If it is wet, it must be thoroughly dried before it can be connected or used.
- When handling the instrument, keep your fingers behind the physical guard.
- Avoid impacts on the measurement head, in particular the air gap.
- Keep the surfaces of the air gap clean; even a little dirt can cause the clamp to malfunction.
- Use personal protection equipment systematically.
- All troubleshooting and metrological checks must be done by competent accredited personnel.

INITIAL SETUP

Installing Batteries

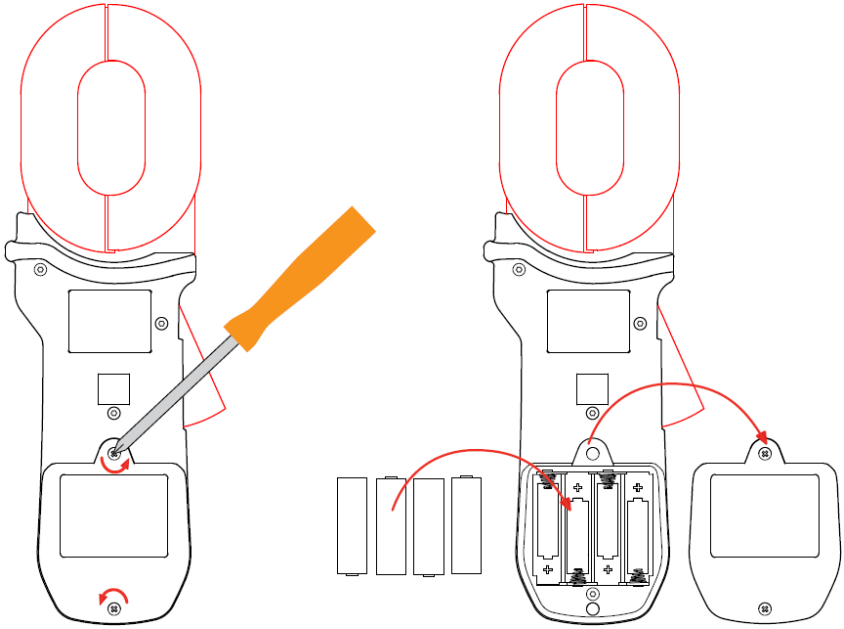

Date/Time Setup

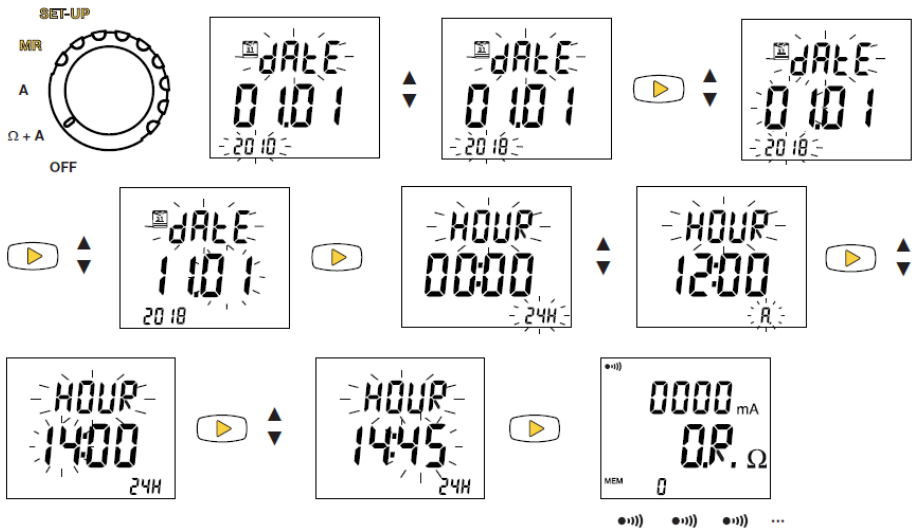

SELF-CALIBRATION

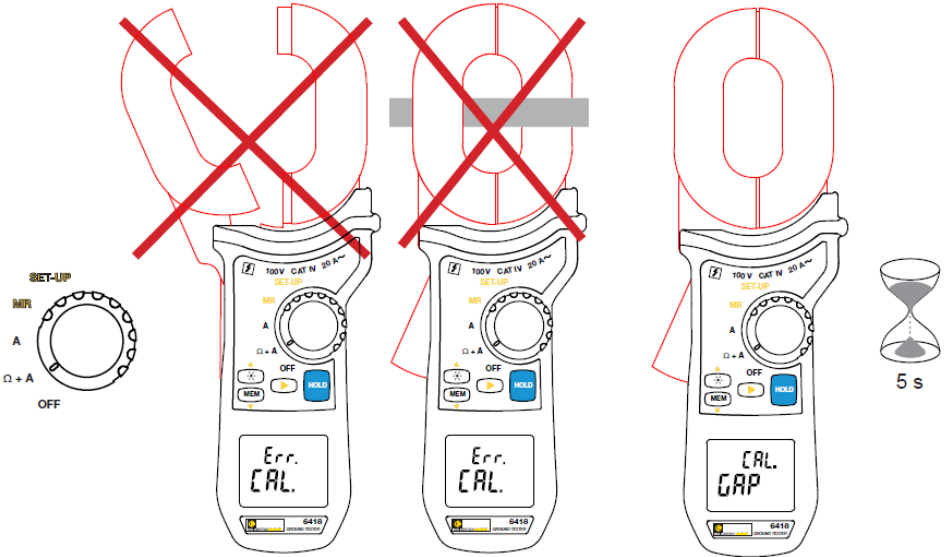

GROUND MEASUREMENT

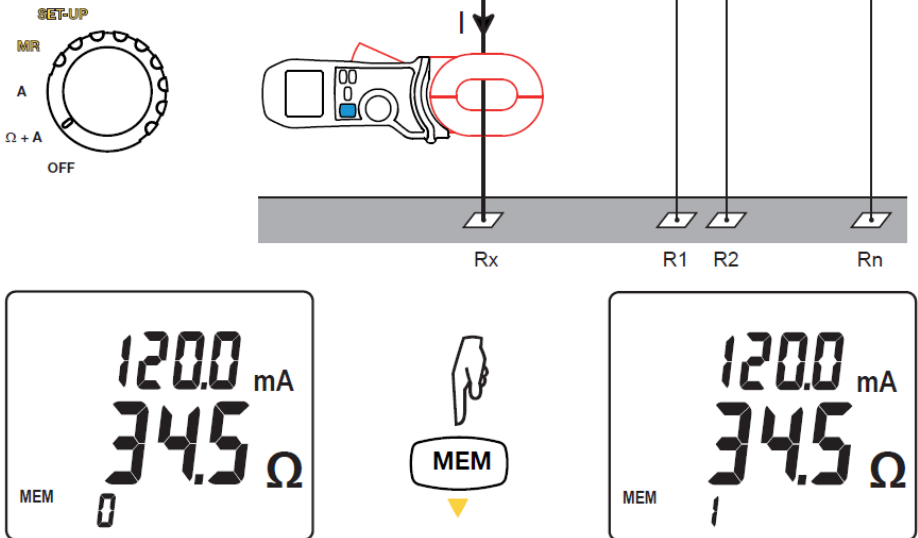

CURRENT MEASUREMENT

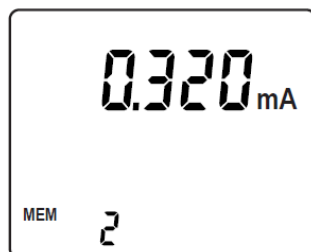
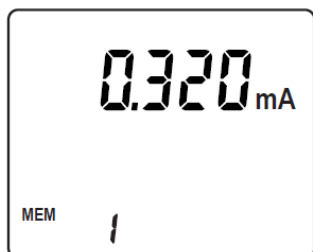
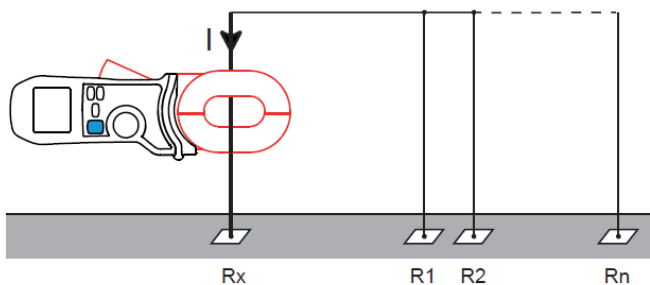
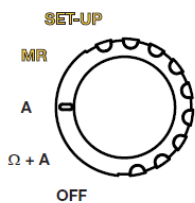

Repair and Calibration

To ensure that your instrument meets factory specifications, we recommend that it be scheduled to be sent back to our factory Service Center at one-year intervals for recalibration, or as required by other standards or internal procedures.

For instrument repair and calibration:

You must contact our Service Center for a Customer Service Authorization Number (CSA#). This will ensure that when your instrument arrives, it will be tracked and processed promptly. Please write the CSA# on the outside of the shipping container. If the instrument is returned for calibration, we need to know if you want a standard calibration or a calibration traceable to N.I.S.T. (Includes calibration certificate plus recorded calibration data).

For North / Central / South America, Australia and New Zealand

Ship To: Chauvin Arnoux[®], Inc. d.b.a. AEMC[®] Instruments
15 Faraday Drive • Dover, NH 03820 USA

Phone: (800) 945-2362 (Ext. 360)
(603) 749-6434 (Ext. 360)

Fax: (603) 742-2346 • (603) 749-6309

E-mail: repair@aemc.com

(Or contact your authorized distributor.)

Costs for repair, standard calibration, and calibration traceable to N.I.S.T. are available.

NOTE: You must obtain a CSA# before returning any instrument.

Technical and Sales Assistance

If you are experiencing any technical problems, or require any assistance with the proper operation or application of your instrument, please call, fax, or e-mail our technical support team:

Contact: Chauvin Arnoux[®], Inc. d.b.a. AEMC[®] Instruments
Phone: (800) 945-2362 (Ext. 351) • (603) 749-6434 (Ext. 351)
Fax: (603) 742-2346
E-mail: techsupport@aemc.com



04/19

99-MAN 100493 v2

Chauvin Arnoux®, Inc. d.b.a. AEMC® Instruments
15 Faraday Drive • Dover, NH 03820 USA
Phone: (603) 749-6434 • Fax: (603) 742-2346
www.aemc.com