

■ GROUND TESTER

6418



ENGLISH

User Manual

 **AEMC**[®]
INSTRUMENTS
CHAUVIN ARNOUX GROUP

Statement of Compliance

Chauvin Arnoux®, Inc. d.b.a. AEMC® Instruments certifies that this instrument has been calibrated using standards and instruments traceable to international standards.

We guarantee that at the time of shipping your instrument has met its published specifications.

An N.I.S.T. traceable certificate may be requested at the time of purchase, or obtained by returning the instrument to our repair and calibration facility, for a nominal charge.

The recommended calibration interval for this instrument is 12 months and begins on the date of receipt by the customer. For recalibration, please use our calibration services. Refer to our repair and calibration section at **www.aemc.com**.

Serial #: _____

Catalog #: 2141.03

Model #: 6418

Please fill in the appropriate date as indicated:

Date Received: _____

Date Calibration Due: _____



AEMC®
INSTRUMENTS

CHAUVIN ARNOUX GROUP









Chauvin Arnoux®, Inc.
d.b.a AEMC® Instruments
www.aemc.com

Table of Contents

PRECAUTIONS FOR USE	5
1. INTRODUCTION	7
1.1. Function Keys	8
1.2. Display	8
1.3. Inserting Batteries	9
1.4. Date and Time Setup	9
2. OPERATION	10
2.1. General	10
2.2. Impedance and Current Measurement	10
2.3. Current Measurement	12
2.4. Configuring (Set-up)	13
2.5. Errors	15
2.6. Automatic Stop	15
2.7. Storage	16
3. TECHNICAL CHARACTERISTICS	18
3.1. General Reference Conditions	18
3.2. Electrical Characteristics	18
3.3. Influences	19
3.4. Power Supply	22
3.5. Environmental Conditions	22
3.6. Mechanical Characteristics	22
3.7. Compliance with International Standards	23
3.8. Electromagnetic Compatibility (EMC)	23
4. MAINTENANCE	24
4.1. Cleaning	24
4.2. Battery Replacement	24
LIMITED WARRANTY	26

Thank you for purchasing the AEMC Clamp-On Ground Tester Model 6418.

For best results from your instrument and for your safety, read the enclosed operating instructions carefully and comply with the precautions for use. These products must be only used by qualified and trained users.

	WARNING, risk of DANGER! The operator must refer to these instructions whenever this danger symbol appears.
	Equipment is protected by double insulation.
	Battery.
	Application or withdrawal authorized on conductors carrying dangerous voltages. Type A current sensor per IEC 61010-2-032.
	Useful information or tip to read.
	The product has been declared recyclable after analysis of its life cycle in accordance with the ISO14040 standard.
	Guarantees conformity with European directives and with regulations covering EMC.
	In the European Union, the product must undergo selective disposal for the recycling of electric and electronic material, in compliance with Directive WEEE 2002/96/EC.

Definition of Measurement Categories (CAT)

CAT IV Measurement category IV corresponds to measurements taken at the source of low-voltage installations.

Example: power feeders, counters and protection devices.

CAT III Measurement category III corresponds to measurements on building installations.

Example: distribution panel, circuit-breakers, machines or fixed industrial devices.

CAT II Measurement category II corresponds to measurements taken on circuits directly connected to low-voltage installations.

Example: power supply to domestic electrical appliances and portable tools.



PRECAUTIONS FOR USE



This instrument is compliant with safety standard IEC 61010-2-032, for voltages up to 100V in category IV or 150V in category III. Failure to observe the safety instructions may result in electric shock, fire, explosion, and destruction of the instrument and of the installations.

- The operator and/or the responsible authority must carefully read and clearly understand the various precautions to be taken in use. The operator and/or the responsible authority must carefully read and clearly understand the various precautions to be taken in use. Sound knowledge and a keen awareness of electrical hazards are essential when using this instrument.
- If you use this instrument other than as specified, the protection it provides may be compromised, thereby endangering you.
- The safety of any system in which this instrument might be incorporated is the responsibility of the integrator of the system.
- Do not use the clamp above its rated frequency, since this might cause it to overheat dangerously.
- Do not use the instrument on networks of which the voltage or category exceeds those mentioned.
- Observe the environmental conditions of use.
- Do not use the instrument if it seems to be damaged, incomplete, or poorly closed.
- Before each use, check the condition of the insulation on the housing. Any item of which the insulation is deteriorated (even partially) must be set aside for repair or scrapping.
- Before using your instrument, check that it is perfectly dry. If it is wet, it must be thoroughly dried before it can be connected or used.
- When handling the instrument, keep your fingers behind the physical guard.
- Avoid impacts on the measurement head, in particular the air gap.
- Keep the surfaces of the air gap clean; even a little dirt can cause the clamp to malfunction.
- Use personal protection equipment systematically.
- All troubleshooting and metrological checks must be done by competent accredited personnel.

Receiving Your Shipment

Upon receiving your shipment, make sure that the contents are consistent with the packing list. Notify your distributor of any missing items. If the equipment appears to be damaged, file a claim immediately with the carrier and notify your distributor at once, giving a detailed description of any damage. Save the damaged packing container to substantiate your claim.

Ordering Information

Clamp-On Ground Tester Model 6418..... **Cat. #2141.03**
Includes hard carrying case, 5 Ω calibration loop, four 1.5V AA batteries, wrist strap, Bluetooth adapter, multilingual safety sheet, Quick Start Guide, and USB drive containing User Manual.

Replacement Parts

Hard Carrying Case **Cat. #2141.52**
5 Ω Calibration Loop **Cat. #2141.51**

For the accessories and replacement parts, visit our web site:
www.aemc.com

1. INTRODUCTION

The simple-to-use Clamp-On Ground Tester Model 6418 makes ground impedance measurements in a parallel earth network, such as power distribution poles and overhead ground conductors. These measurements are simpler to perform than traditional measurements with two auxiliary rods.

The Model 6418 can make accurate low value ground impedances measurements and AC current measurements. Its large oblong measurement head can clamp around bars up to 1.18 x 1.57" (30 x 40mm). Its memory function records measurements for later viewing. The instrument's OLED (Organic Light Emitting Diode) display screen is easy to read, even in direct sunlight.

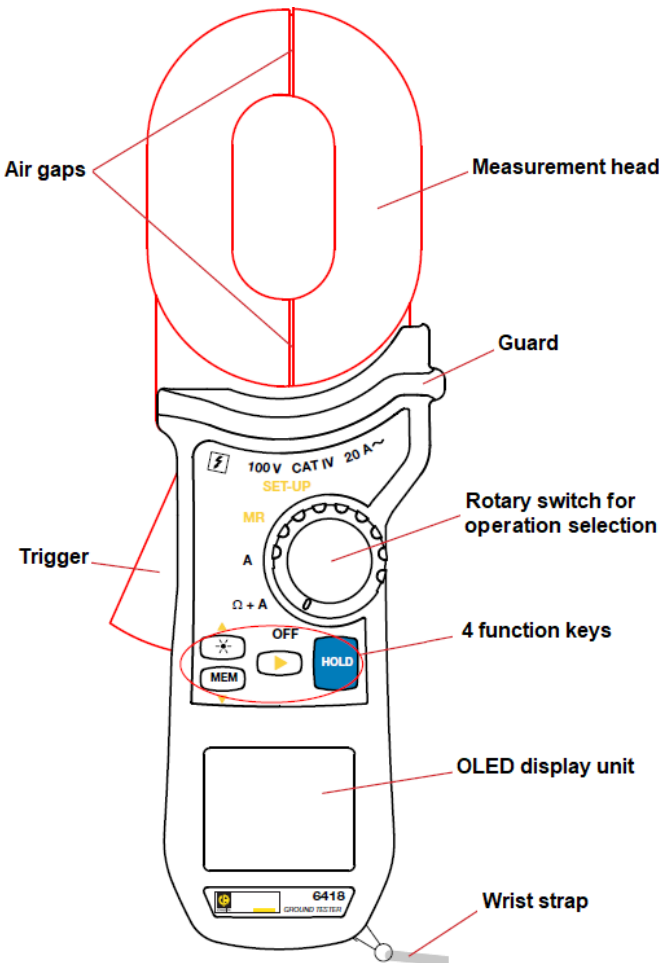

1.1. FUNCTION KEYS

As a general rule, functions shown in white on the keys are available when the switch is set to **Ω+A** or **A**. The yellow arrow keys (**▲**, **▼** and **▶**) are available when the switch is set to **MR** or **SET-UP**.

Key	Function
	Switch the display unit backlighting ON and OFF.
MEM	Record the measurement displayed.
HOLD	Freeze/unfreeze the display of the measurement.
▲ ▼	Browse in: <ul style="list-style-type: none"> ▪ SET-UP menu and change the value of the parameter selected. ▪ Memory read (MR).
▶	When switch is set to: <ul style="list-style-type: none"> ▪ Ω+A or A: a long press on ▶ activates/deactivates the audible signal. ▪ SET-UP: ▶ browses in the menu and confirms the changes made. ▪ MR: ▶ toggles the display between the measurement and the date/time.

1.2. DISPLAY

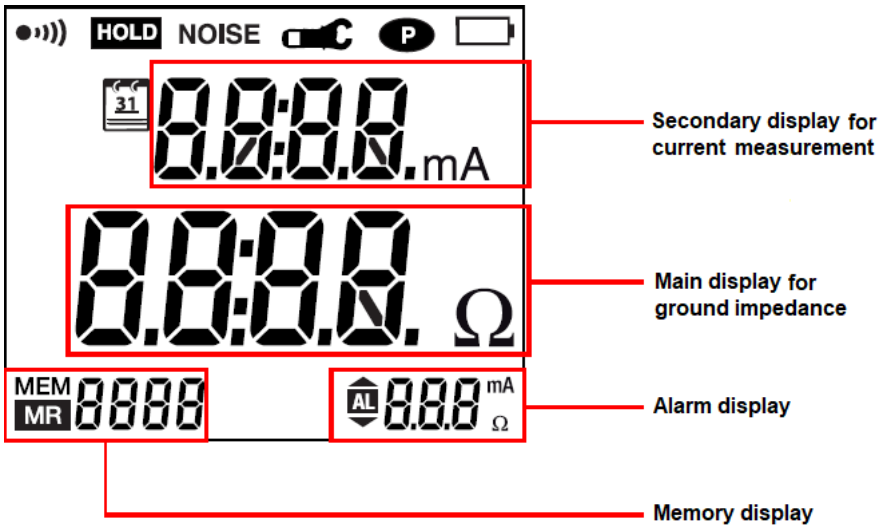

When the measurement exceeds the limits of the measurement range, the instrument displays **OR**.

1.3. INSERTING BATTERIES

Refer to §4.2.

1.4. DATE AND TIME SETUP

The first time you turn ON the instrument by turning the switch to **Ω+A**, the instrument prompts you to set the date.

The year blinks, indicating it can be edited. Set it using the **▲** and **▼** keys.

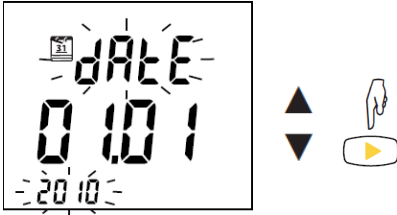

Then press the **▶** key; the month blinks. Set it using **▲** and **▼**.

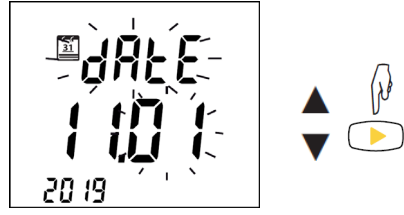

Press **▶**. The date blinks; set it using **▲** and **▼** and confirm by pressing **▶**.

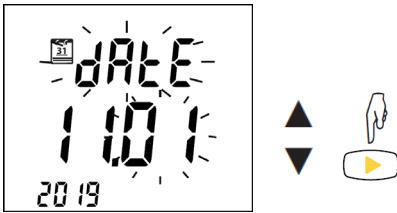

The instrument then displays the time format. Choose 24h or 12h (A or P) using **▲** and **▼**.

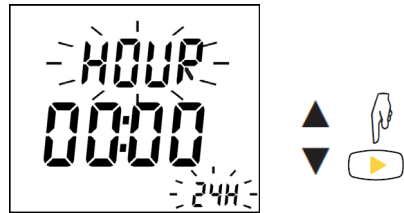

Confirm by pressing **▶**. The hours reading blinks. Set it using **▲** and **▼** and confirm by pressing **▶**.

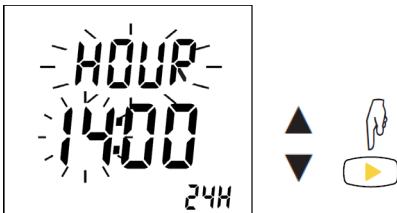

The minutes reading blinks. Set it using **▲** and **▼** and confirm with **▶**.

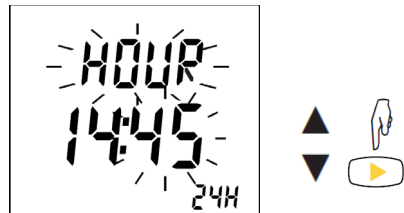

2. OPERATION

2.1. GENERAL

When turned ON, the instrument performs self-calibration. The jaws of the clamp must therefore be closed and not clamped around any conductor.

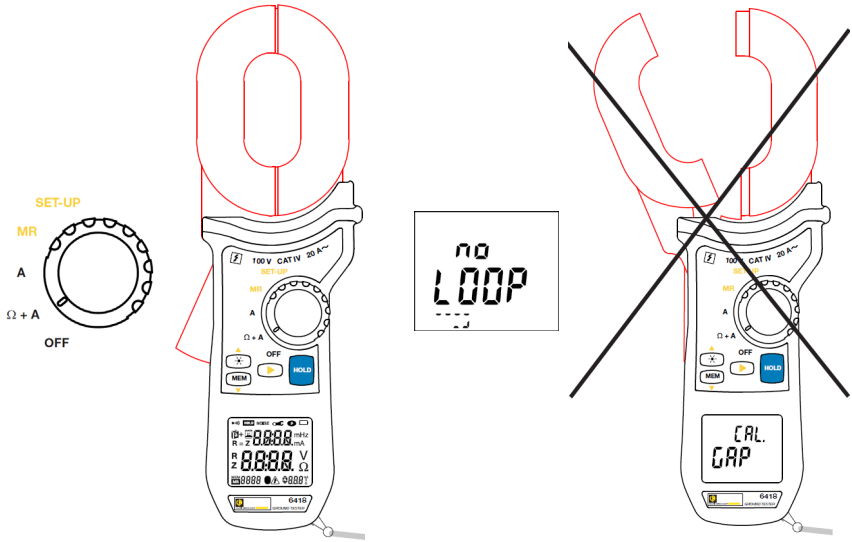

If the instrument fails to complete self-calibration, the error message **Err. CAL** is displayed. If this happens, turn the instrument OFF and ensure the air gaps are clean. Then turn the instrument ON.

2.2. IMPEDANCE AND CURRENT MEASUREMENT

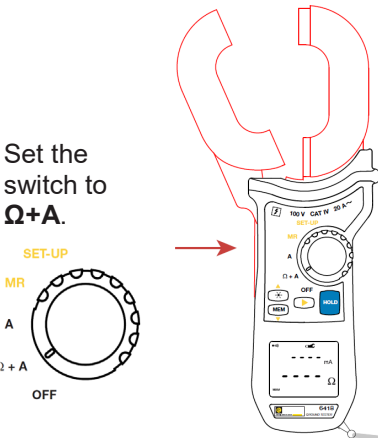

Set the switch to **Ω+A**.

Press the trigger to open the jaws, and clamp around the conductor that is part of the ground system to be measured.

When the jaws are open, the symbol  is displayed and the instrument cannot make a measurement.

2.2.1. CONNECTION

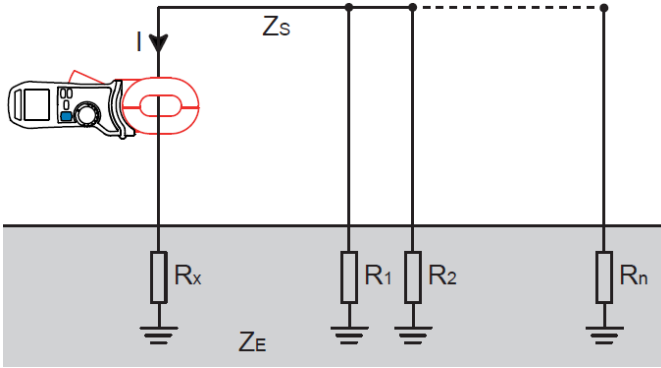

The ground electrode to be measured (R_x) is in a series/parallel arrangement with other ground electrodes via the earth impedance (Z_E) and physical connection to other resistance paths (Z_s). The measured impedance will be slightly greater than R_x assuming the downstream impedance is very low. For example: If R_x is 21Ω and Z_s/R_1-R_n is effectively 0.6Ω , the Model 6418 will read 21.6Ω .



During the impedance measurement, the instrument emits an intermittent audible “beeping” signal. This is caused by the measurement frequency that flows in the measurement head. The sound can vary as a function of the frequency and amplitude of the current measured. This sound is normal and cannot be eliminated.

2.2.2. FREEZING AND/OR STORING A MEASUREMENT

When the measurement has stabilized, you can press the **HOLD** key to freeze it and/or **MEM** to record it.

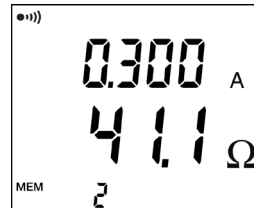
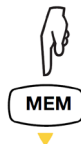
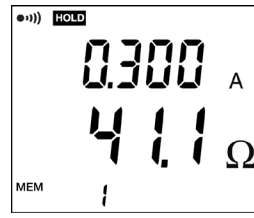
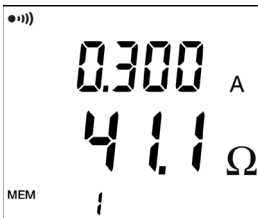

2.2.3. AUTO-HOLD FUNCTION

The AUTO-HOLD function (see §2.4), freezes the measurement automatically when the jaws of the clamp are opened. This can be useful when you have only one hand free to make a measurement.

2.2.4 ALARMS

To facilitate making measurements, you can program an alarm on the impedance measurement (see §2.4) and/or the current measurement (see §2.4). You can then be aware whether the measurement is acceptable without looking at the display.

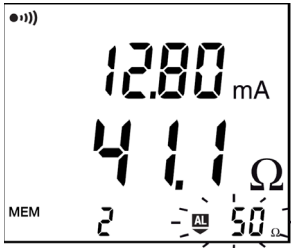

The alarm indicator on the display blinks and the instrument emits a continuous audible signal.

To eliminate the audible signal, press and hold the ► key.

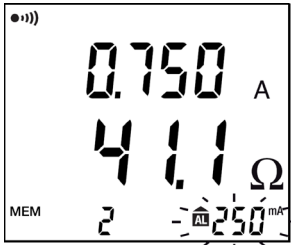

If you set alarms on both the impedance and the current, and both alarm thresholds are exceeded, the alarm on the current has priority.

2.3. CURRENT MEASUREMENT

The current measurement alone is identical to the current measurement with the impedance measurement.

Set the switch to **A**.

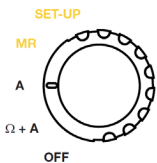

Press the trigger to open the jaws of the clamp and clamp the conductor in which the current to be measured flows.

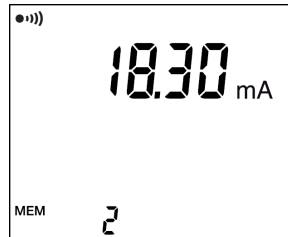
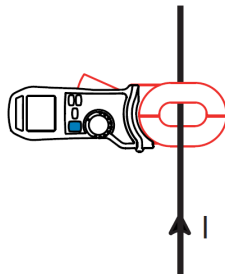

When the measurement has stabilized, you can press the **HOLD** key to freeze it and/or **MEM** to record it in memory. You can also use the AUTO-HOLD function (see §2.4) to freeze the measurement automatically when the clamp jaws are opened. This can be useful when you have only one hand free to make a measurement. To facilitate making measurements, you can configure an alarm on the current measurement value (see §2.4).

2.4. CONFIGURATION (SET-UP)

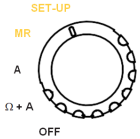

Set the switch to **SET-UP**.

Use the ▼ and ▲ keys to scroll through the screens of the SET-UP menu.

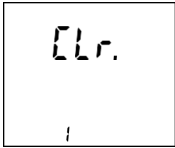

CLR (erase memory) menu.

Press the ► key to enter the CLR menu.

To cancel, press ►.

To erase all records, press and hold the ▲ and ▼ keys simultaneously. The instrument emits 5 audible beeps before erasing the memory.

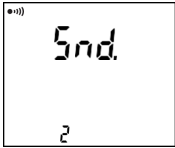

SND menu (activation of the sound).

Press ► to enter the SND menu. Use ▲ and ▼ to display or hide the ●))) symbol.

When ●))) is displayed, the instrument emits an audible signal when keys are pressed and when alarm thresholds are crossed.

Confirm by pressing ►.

During the measurements (when the switch is set to Ω+A or A), a long press on ► activates/deactivates the audible signal.

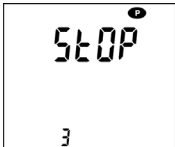

STOP menu (automatic standby).

Press ► to enter the STOP menu. Use ▲ and ▼ to display or hide the P symbol (permanent operation).

When P is displayed, automatic switching of the instrument to standby at the end of 5 minutes is disabled. Confirm by pressing ►.

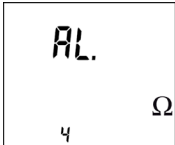

ALΩ menu (impedance alarm).

Press ► to enter the ALΩ menu. Use ▲ and ▼ to scroll through the display:

Ω: no impedance alarm.

Ω: impedance alarm activates when impedance >10Ω.

Ω: impedance alarm activates when impedance <10Ω.

Press ►; the alarm threshold blinks. Set it using ▲ and ▼. Acceptable values are between 1 and 199Ω. A long press scrolls the values faster.

Confirm by pressing ►.

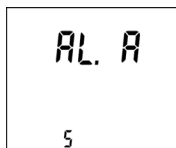

AL A menu (current alarm).

Press ► to enter the AL A menu. Use ▲ and ▼ to scroll through the display:

 30^{mA}: no current measurement alarm.

 30^{mA}: current alarm activates when current >30mA.

Press ►; the alarm threshold blink. Set it using ▲ and ▼.

Acceptable values are between 1mA and 20.0A. A long press scrolls the values faster.

Press ► to confirm.

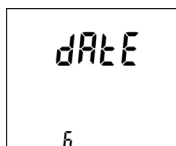

DATE menu (setting of the date)

Press ► to enter the DATE menu. Use ▲ and ▼ to set the year. Press ►; the month setting blinks. Set it using ▲ and ▼.

Do the same for the day setting and confirm with the ► key.

For a more detailed procedure, see §1.4.

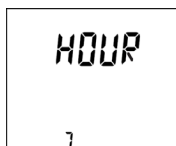

HOUR menu (setting of the time)

Press ► to enter the HOUR menu. Use ▲ and ▼ to choose

24h or 12h (A or P) form. Press ►; the hours setting blinks.

Set this using ▲ and ▼. Press ►; the minutes setting blinks.

Set this using ▲ and ▼; confirm by pressing ►.

For a more detailed procedure, see §1.4.



HOLD menu (activation of the AUTO-HOLD function)

Press ► to enter the AUTO-HOLD menu. Use ▲ and ▼ to display

or hide the  symbol. When this symbol is displayed, the

AUTO-HOLD function is activated. In this mode, when the

measurement is stable, it is frozen when the clamp is opened.

Confirm by pressing ►.

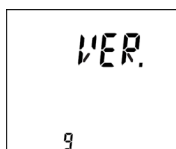

VER menu (display of the software version)

Press ► to display the software version number.

Press ▼ to display the instrument serial number.

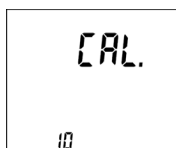

CAL menu (not used)

2.5. ERRORS

During the measurement, the instrument reports any errors.

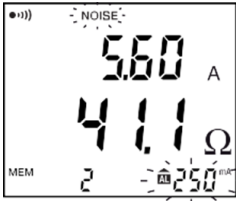

Display of the **NOISE** symbol during the impedance measurement indicates that the current (>5A) or voltage ($Z \times I > 25V$) is too high, making the accuracy of the displayed measurement uncertain.

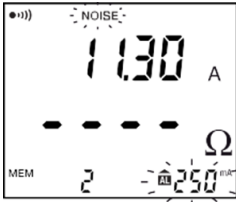

When the current exceeds 10A, the impedance measurement is not displayed (dashes appear in the measurement field).



When the impedance measurement is >1200Ω, the instrument displays **OR**.

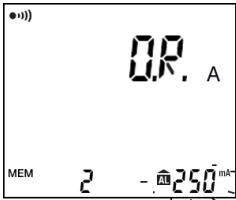

When the current measurement is >20A, the instrument so indicates.



When the impedance measurement is <1Ω, the display alternately indicates the measured value and **LOOP**, indicating the value is very low for a valid ground impedance measurement and most likely indicates the measurement is through a wire loop rather than through the earth.

2.6. AUTOMATIC STOP

After 5 minutes of inactivity, the instrument enters to standby mode. Press any key or turn the switch to any setting to exit standby. The instrument restarts without repeating the calibration procedure if it has not been on standby for more than 15 minutes. It is possible to disable automatic standby; refer to §2.4 (STOP menu). The **P** symbol is then displayed.

2.7. STORAGE

2.7.1. RECORDING A MEASUREMENT



To record a measurement, press the **MEM** key.
You can first press the **HOLD** key to freeze the measurement.



To record a measurement, the batteries must not be discharged (the  symbol must not be displayed).

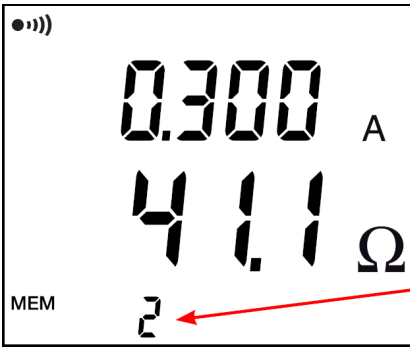

The measurement is recorded in the memory slot of which the number is displayed (in this example, slot number 2).

It is recorded with all accompanying information:

- date and time
- any alarms and their status (triggered or not)
- any errors (**NOISE, OR, LOOP**)
- ancillary displays (**HOLD, P**)

2.7.2. VIEWING RECORDINGS

Set the switch to **MR**.

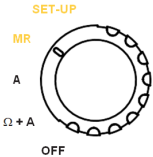

The instrument displays the last measurement recorded. Press  to display the date and time.



Use  and  to scroll through all of the recorded measurements.

2.7.3. ERASING ALL RECORDINGS

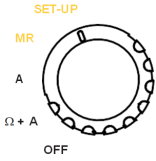

Set the switch to **SET-UP**, then follow the procedure described in §2.4 in the CLR menu.

When you return to the **MR** setting, the instrument indicates that the memory is empty.

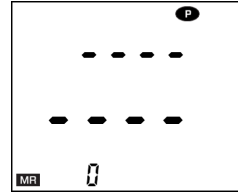

2.7.4. MEMORY FULL

You can record up to 300 measurements (numbered from 0 to 299).

If you continue recording, measurement number 300 overwrites measurement number 0, measurement 301 overwrites measurement 1, and so on.

The instrument reports this by alternately displaying FULL and the memory slot number.

You can continue in this way up to number 9999, at which point recording becomes disabled and you must erase the memory to be able to resume recording.

3. TECHNICAL CHARACTERISTICS

3.1. GENERAL REFERENCE CONDITIONS

Quantities of influence	Reference values
Temperature	73 ±5°F (23 ±3°C)
Relative humidity	50 ±10%RH
Supply voltage	6 ±0.2V
Electric field	<1V/m
Magnetic field	<40A/m
Operating position	clamp horizontal
Position of the conductor in the jaws	centered
Adjacent conductors carrying current in impedance measurement	At least 3.9" (10cm)
Magnetic mass	At least 3.9" (10cm)
Frequency	50Hz, sinusoidal
Level of distortion	<0.5%
Current present in impedance measurement	0mA

The intrinsic uncertainty is the error defined under the conditions of reference.

The operational uncertainty is the intrinsic uncertainty plus the variation of the quantities of influence (position, supply voltage, temperature) as defined in standard IEC 61557. The uncertainties are expressed as a percentage of the reading (R) and as a number of display counts (ct): $\pm(a\%R + \# \text{ ct})$.

3.2. ELECTRICAL CHARACTERISTICS

3.2.1. IMPEDANCE MEASUREMENTS

Particular conditions of reference

Inductance in series with the resistance: zero.

Specified measurement range	0.010 to 0.099Ω	0.10 to 0.99Ω	1.0 to 49.9Ω	50 to 149Ω
Resolution (ct)	1 mΩ	10 mΩ	100 mΩ	1 Ω
Intrinsic uncertainty (δ)	$\pm (1.5\%R + 0.01\Omega)$	$\pm (1.5\%R + 2 \text{ ct})$	$\pm (1.5\%R + 2 \text{ ct})$	$\pm (2.5\%R + 2 \text{ ct})$
No-load voltage	$\leq 45 \text{ mV to } 2083 \text{ Hz}$			

Specified measurement range	150 to 245Ω	250 to 440Ω	450 to 640Ω	650 to 1200Ω
Resolution (ct)	5 Ω	10 Ω	10 Ω	50 Ω
Intrinsic uncertainty (δ)	± (5%R + 2 ct)	± (10%R + 2 ct)	± (15%R + 2 ct)	± (20%R + 2 ct)
No-load voltage	≤ 45 mV to 2083 Hz			

3.2.2 CURRENT MEASUREMENTS

Particular conditions of reference

Frequency of the signal 47 to 800Hz

Specified measurement range	0.500 to 9.950mA	10.00 to 99.90mA	100.0 to 299.0mA	0.300 to 2.990A
Resolution (ct)	50 μA	100 μA	1 mA	10 mA
Intrinsic uncertainty (δ)	± (2%R + 200 μA)	± (2%R + 1 ct)	± (2%R + 1 ct)	± (2%R + 1 ct)

Specified measurement range	3.00 to 20.00 A
Resolution (ct)	100 mA
Intrinsic uncertainty (δ)	± (2%R + 1 ct)



Beyond 20A and 800Hz, the clamp may overheat dangerously.

3.2.3. STORAGE

Number of records: 300.

3.3. INFLUENCES

Z = impedance

I = current

δ = intrinsic uncertainty given in §3.2.

ct = resolution given in §3.2.

Impedance measurement:

Quantities of influence	Range of influence	Influence			
		Typical		Maximum	
Temperature	-4 to 131°F (-20 to + 55 °C)	0.5 δ / 10°C \pm ct		1.5 δ / 10°C + ct	
Relative humidity	10 to 90% RH	1 δ \pm ct		2 δ \pm ct	
Supply voltage	4 to 6.5 V	0.05 δ \pm ct		0.1 δ \pm ct	
Position of conductor	from the edge to the center	Z < 450 Ω 0.2 δ \pm ct	Z \geq 450 Ω 0.5 δ \pm ct	Z < 450 Ω 0.4 δ \pm ct	Z \geq 450 Ω 1 δ \pm ct
Position of clamp	+/- 180°	Z < 450 Ω 0.25 δ \pm ct	Z \geq 450 Ω 0.5 δ \pm ct	Z < 450 Ω 0.5 δ \pm ct	Z \geq 450 Ω 1 δ \pm ct
Proximity to magnetic mass	Sheet steel 1mm thick against air gap	0.1 δ \pm ct		0.5 δ \pm ct	
Magnetic field 50/60Hz	30 A/m	0.05 δ \pm ct		0.1 δ \pm ct	
Adjacent conductor	I < 40A	Z < 250 Ω 0.25 δ \pm ct	Z \geq 250 Ω 0.4 δ \pm ct	Z < 250 Ω 0.5 δ \pm ct	Z \geq 250 Ω 0.8 δ \pm ct
Leakage current in the grounding system from 50 to 60Hz I < 10 A. ZxI < 75 V	Z < 100 Ω	Z x I < 20 V	0.5 δ \pm ct		1 δ \pm ct
		20 V \leq Z x I < 40 V	1 δ \pm ct		3 δ \pm ct
		40 V \leq Z x I	2 δ \pm ct		4 δ \pm ct
	Z \geq 100 Ω	0.5 δ \pm ct		1 δ \pm ct	
Ground inductance	0 to 500 μ H	Instrument displays Z at measurement frequency (2083Hz)			

Current measurement:

Quantities of influence	Range of influence	Influence	
		Typical	Maximum
Temperature	-4 to 131 °F (-20 to + 55 °C)	0.5 δ / 10°C ± ct	1.5 δ / 10°C + ct
Relative humidity	10 to 90% RH	0.5 δ ± ct	1 δ ± ct
Supply voltage	4 to 6.5 V	0.05 δ ± ct	0.1 δ ± ct
Position of conductor	from the edge to the center	0.05 δ ± ct	0.2 δ ± ct
Position of clamp	+/- 180°	0.1 δ ± ct	0.25 δ ± ct
Proximity to magnetic mass	Steel sheet 1mm thick against air gap	0.1 δ ± ct	0.2 δ ± ct
Magnetic field 50/60Hz	10 A/m	0.75 mA	1.5 mA
	30 A/m	2 mA	4.5 mA
	100 A/m	8 mA	15 mA
Deformation of the leakage current	IEC 61557-13 5% to 150 Hz at 0° 6% to 250 Hz at 180° 5% to 350 Hz at 0°	0.05 δ ± ct	0.1 δ ± ct
Adjacent conductor	I < 40A	> 70 dB	> 66 dB
Frequency of the leakage current	47 to 800 Hz ¹	0.5 δ ± ct	1 δ ± ct

1: For the whole current measurement range

3.4. POWER SUPPLY

The instrument is powered by four 1.5V AA batteries (LR6 alkaline; NiMH rechargeable can also be used). The voltage range ensuring proper operation is 4 to 6.5V. The battery life of the instrument is 12 hours (approximately 1440 30-second measurements).

3.5. ENVIRONMENTAL CONDITIONS

The conditions of ambient temperature and relative humidity are illustrated in the following graph:

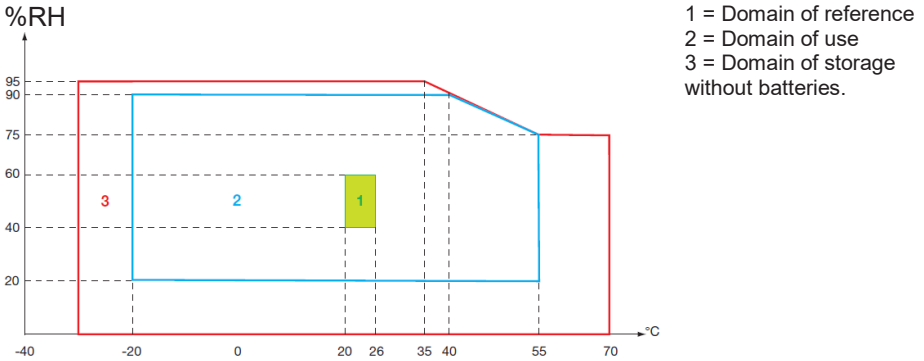

Indoor use

Altitude <6500' (<2000m)

Pollution degree 2

3.6. MECHANICAL CHARACTERISTICS

Dimensions (L x W x H): 11.8 x 4.2 x 2.2" (300 x 106 x 56mm)

Weight: approximately 2.6lb (1.2kg)

Clamping diameter: 1.26" (32mm) or a 1.18 x 1.57" (30 x 40mm) or 0.79 x 2.17" (20 x 55mm) bar

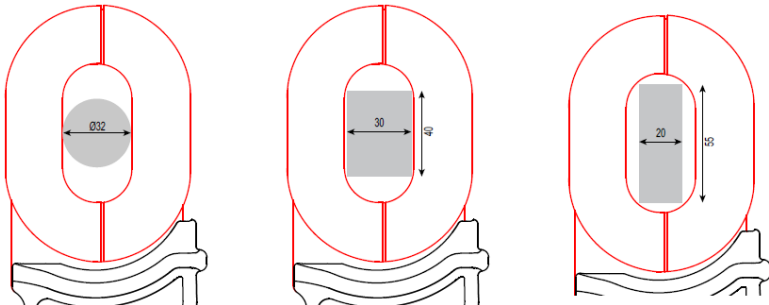

Ingress protection: IP40 per IEC 60529

3.7. COMPLIANCE WITH INTERNATIONAL STANDARDS

The instrument is compliant with standard IEC 61010-1 and IEC 61010-2-032, 100V category IV or 150V category III.

3.8. ELECTROMAGNETIC COMPATIBILITY (EMC)

The instrument is compliant with standard IEC 61326-1.

4. MAINTENANCE



Except for batteries, the instrument contains no parts replaceable by personnel who are not specially trained and accredited. Any unauthorized repair or replacement of a part by an “equivalent” may gravely impair safety.

4.1. CLEANING

Disconnect everything connected to the instrument and set the switch to OFF. Use a soft cloth, dampened with soapy water. Rinse with a damp cloth and dry rapidly with a dry cloth or forced air. Do not use alcohol, solvents, or hydrocarbons. Do not use the instrument again until it has completely dried. Keep the air gap of the clamp perfectly clean.

4.2. BATTERY REPLACEMENT

The  symbol on the display screen blinks when batteries are low. This symbol is displayed steadily when the batteries require replacement.

1. Disconnect everything connected to the instrument and set the switch to OFF.
2. Turn the instrument over and unscrew the 2 captive screws securing the battery compartment cover.

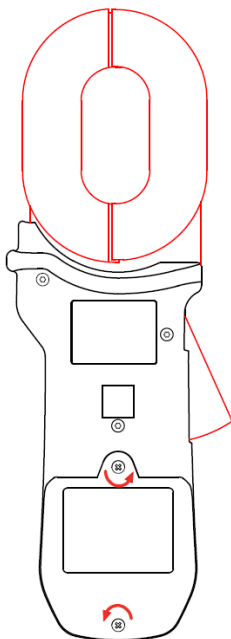

3. Remove the battery compartment cover.
4. Remove the batteries from the compartment.

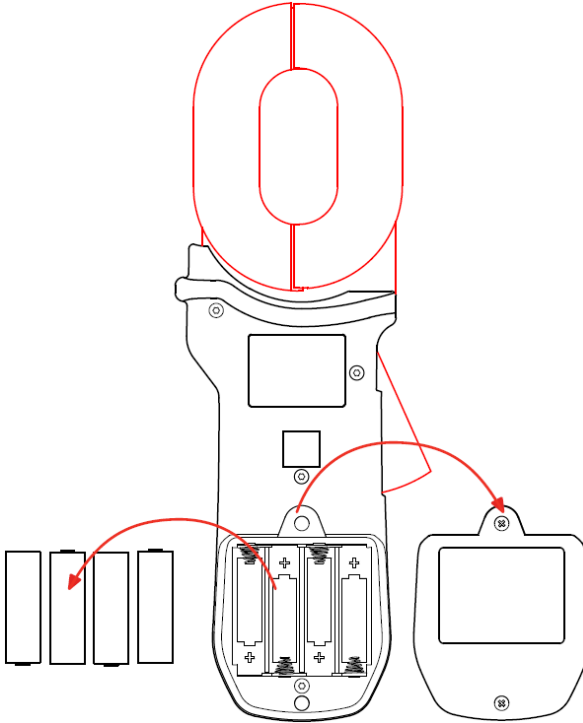

Spent batteries must not be treated as ordinary household waste. Take them to the appropriate recycling collection point.

5. Insert new batteries in the compartment, observing polarities.
6. Replace the battery compartment cover and ensure it is completely and correctly closed.
7. Screw the two captive screws back in.



Instrument date and time settings are saved for several minutes, long enough for you to change the batteries. If, however, the date and time are lost, the instrument will prompt you to reset them when it is turned ON (see §1.4).

LIMITED WARRANTY

Your AEMC instrument is warranted to the owner for a period of two years from the date of original purchase against defects in manufacture. This limited warranty is given by AEMC® Instruments, not by the distributor from whom it was purchased. This warranty is void if the unit has been tampered with, abused, or if the defect is related to service not performed by AEMC® Instruments.

Full warranty coverage and product registration is available on our website at:

www.aemc.com/warranty.html.

Please print the online Warranty Coverage Information for your records.

What AEMC® Instruments will do:

If a malfunction occurs within the two-year period, you may return the instrument to us for repair, provided we have your warranty registration information on file or a proof of purchase. AEMC® Instruments will, at its option, repair or replace the faulty material.

WARRANTY REPAIRS

What you must do to return an Instrument for Warranty Repair:

First, request a Customer Service Authorization Number (CSA#) by phone or by fax from our Service Department (see address below), then return the instrument along with the signed CSA Form. Please write the CSA# on the outside of the shipping container. Return the instrument, postage or shipment pre-paid to:

Ship To: Chauvin Arnoux®, Inc. d.b.a. AEMC® Instruments

15 Faraday Drive • Dover, NH 03820 USA

Phone: (800) 945-2362 (Ext. 360)

(603) 749-6434 (Ext. 360)

Fax: (603) 742-2346 • (603) 749-6309

E-mail: repair@aemc.com

Caution: To protect yourself against in-transit loss, we recommend you insure your returned material.

NOTE: You must obtain a CSA# before returning any instrument.

NOTES:



04/19

99-MAN 100482 V2

Chauvin Arnoux[®], Inc. d.b.a. AEMC[®] Instruments

15 Faraday Drive • Dover, NH 03820 USA

Phone: (603) 749-6434 • Fax: (603) 742-2346

www.aemc.com
