

INSTALLATION TESTER

C.A 6116





WARNING, risk of DANGER! The operator agrees to refer to these instructions whenever this danger symbol appears.



Equipment protected by double insulation.



Polarity of the supply connector with direct voltage.



The CE marking guarantees conformity with European directives.



The rubbish bin with a line through it means that in the European Union, the product must undergo selective disposal for the recycling of electric and electronic material, in compliance with Directive WEEE 2002/96/EC.

Definition of measurement categories:

- Measurement category IV corresponds to measurements taken at the source of low-voltage installations.
Example: power feeders, counters and protection devices.
- Measurement category III corresponds to measurements on building installations.
Example: distribution panel, circuit-breakers, machines or fixed industrial devices.
- Measurement category II corresponds to measurements taken on circuits directly connected to low-voltage installations.
Example: power supply to electro-domestic devices and portable tools.
- Measurement category I corresponds to measurements taken on circuits not directly connected to the network.
Example: protected electronic circuits.

Thank you for purchasing a **C.A 6116 installation tester**. To obtain the best service from your unit:

- **read** these operating instructions carefully,
- **comply** with the precautions for use.



PRECAUTIONS FOR USE



This device is protected against accidental voltages of not more than 600V with respect to earth in measurement category III or 300V with respect to earth in measurement category IV. The protection provided by the device may be compromised if it is used other than as specified by the manufacturer.

- Do not exceed the maximum rated voltage and current and the measurement category.
- Never exceed the protection limits indicated in the specifications.
- Comply with the conditions of use, namely the temperature, the humidity, the altitude, the degree of pollution, and the place of use.
- Do not use the device or its accessories if they seem damaged.
- To recharge the battery, use only the mains adapter unit provided with the device.
- Use connection accessories of which the overvoltage category and service voltage are greater than or equal to those of the measuring device (600V CAT III).
- Troubleshooting and metrological checks must be done only by accredited skilled personnel.
- Wear the appropriate protective gear.

CONTENTS

1. FIRST START-UP	4
1.1. Unpacking	4
1.2. Charging the battery.....	5
1.3. Carrying the device	5
1.4. Choice of language	6
2. PRESENTATION OF THE DEVICE	7
2.1. Functions of the device	8
2.2. Keypad	8
2.3. Display unit.....	9
2.4. USB port.....	9
3. PROCEDURE	10
3.1. Voltage measurement.....	10
3.2. Resistance and continuity measurement	11
3.3. Insulation resistance measurement.....	15
3.4. 3P earth resistance measurement.....	18
3.5. Loop impedance measurement (Z_s)	21
3.6. Measurement of the line impedance (Z_l).....	24
3.7. Earth measurement on live circuit (Z_a, R_a)	27
3.8. Selective earth measurement on live circuit.....	32
3.9. Test of residual current device.....	35
3.10. Current measurement.....	42
3.11. Direction of phase rotation	44
3.12. Power measurement	46
3.13. Harmonics	49
3.14. Compensation for the resistance of the measurement leads.....	52
3.15. Adjustment of the alarm threshold	53
4. ERROR REPORTING	55
4.1. No connection	56
4.2. Out of measurement range.....	56
4.3. Presence of dangerous voltage.....	56
4.4. Invalid measurement	56
4.5. Device too hot	56
4.6. Check of internal protection devices.....	57
5. SET-UP	58
6. MEMORY FUNCTION	60
6.1. Organization of the memory and navigation	60
6.2. Entering the storage function	60
6.3. Create a tree.....	61
6.4. Record the measurement.....	62
6.5. Read the records	63
6.6. Erasure	65
6.7. Errors.....	65
7. DATA EXPORT SOFTWARE	66
8. TECHNICAL CHARACTERISTICS	67
8.1. General reference conditions	67
8.2. Electrical characteristics.....	67
8.3. Variations in the range of use	77
8.4. Intrinsic uncertainty and operating uncertainty	80
8.5. Power supply.....	80
8.6. Environmental conditions	81
8.7. Mechanical characteristics	81
8.8. Conformity to international standards.....	81
8.9. Electromagnetic compatibility (EMC)	81
9. DEFINITIONS OF SYMBOLS	82
10. MAINTENANCE	84
10.1. Cleaning	84
10.2. Replacing the battery	84
10.3. Resetting the device.....	85
10.4. Metrological check	85
10.5. Repair	85
11. WARRANTY	86
12. TO ORDER	87
12.1. Accessories	87
12.2. Replacement parts	87

1. FIRST START-UP

1.1. UNPACKING

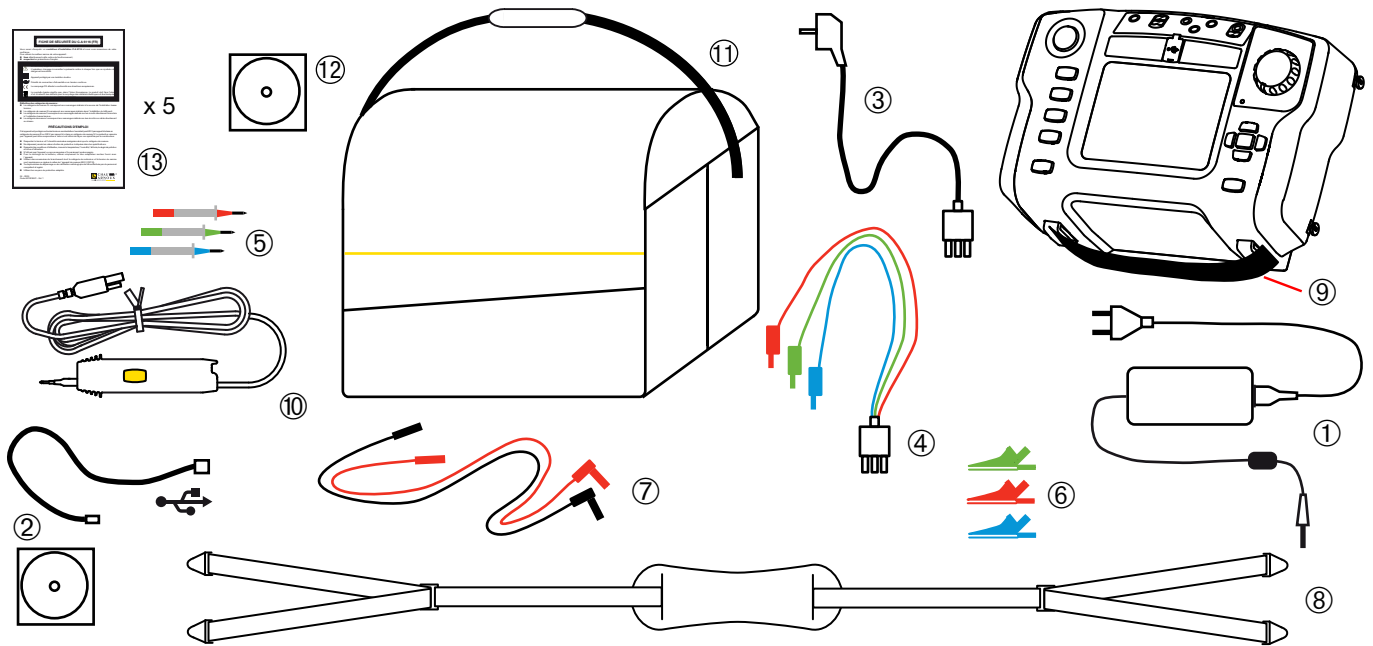

- ① One mains charger for the battery.
- ② Data export software and a USB cord.
- ③ One mains measuring cable.
- ④ One measuring cable, 3 safety leads.
- ⑤ Three probe tips (red, blue, and green).
- ⑥ Three alligator clips (red, blue, and green).
- ⑦ Two elbowed-straight safety leads (red and black).
- ⑧ One 4-point hands-free strap.
- ⑨ One hand strap.
- ⑩ One remote probe.
- ⑪ One carrying bag.
- ⑫ Five user's manuals (1 per language) on CD-ROM.
- ⑬ Five safety sheets (1 per language).

1.2. CHARGING THE BATTERY

Before the first use, start by fully charging the battery. The charging must be done between 10 and 35°C.

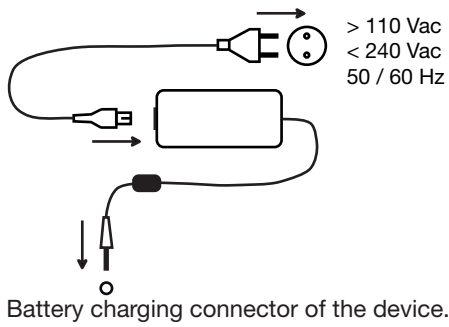

Battery loading...



The indicator of the device lights.



Charging time: approximately 5h



Loading completed.



The indicator goes off.

After prolonged storage, the battery may be fully discharged. In this case, the first charge may take longer and the indicator on the device flashes for the first few minutes.

Set the switch to OFF, but charging is possible when the device is not off,

1.3. CARRYING THE DEVICE

The 4-point hands-free strap will let you use the device while leaving your hands free. Snap the four fasteners of the strap onto the four lugs on the device.

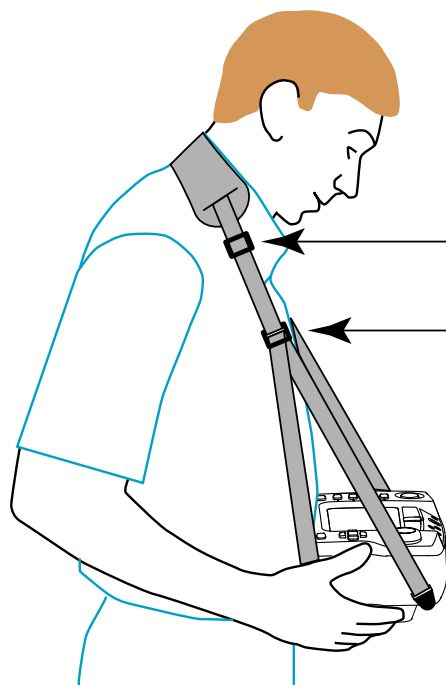

Pass the strap around your neck.

Adjust the length of the strap, then the tilt of the device.

1.4. CHOICE OF LANGUAGE

Before using the device, first choose the language in which you want the device to display messages.

Set the switch to SET-UP.

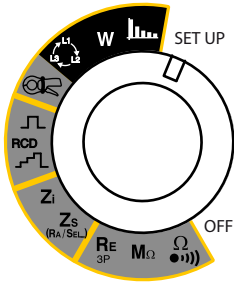

Use the directional keypad to select the languages icon:

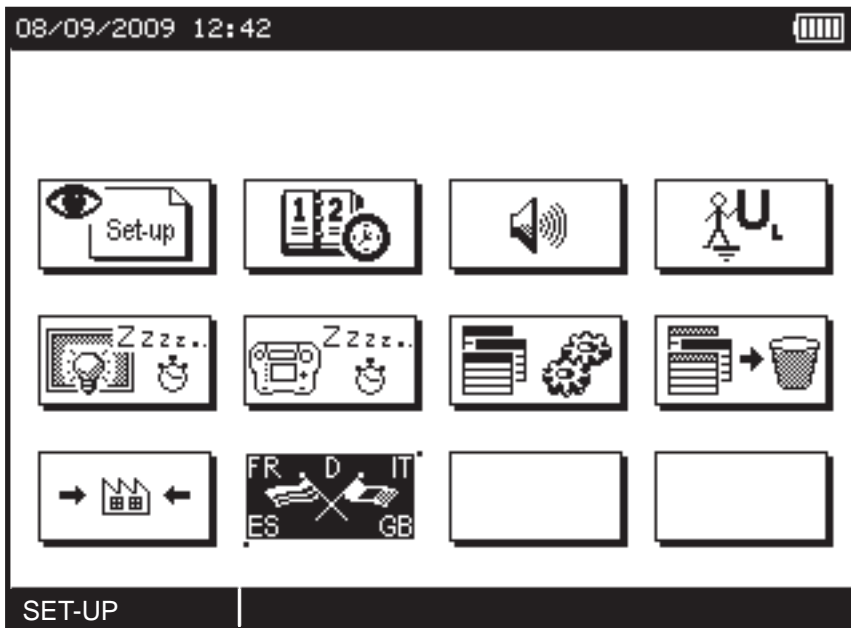

Press the OK key to validate your choice.

Select your language, from among those proposed, using the ▲▼ keys and validate by pressing the OK key again.

2. PRESENTATION OF THE DEVICE

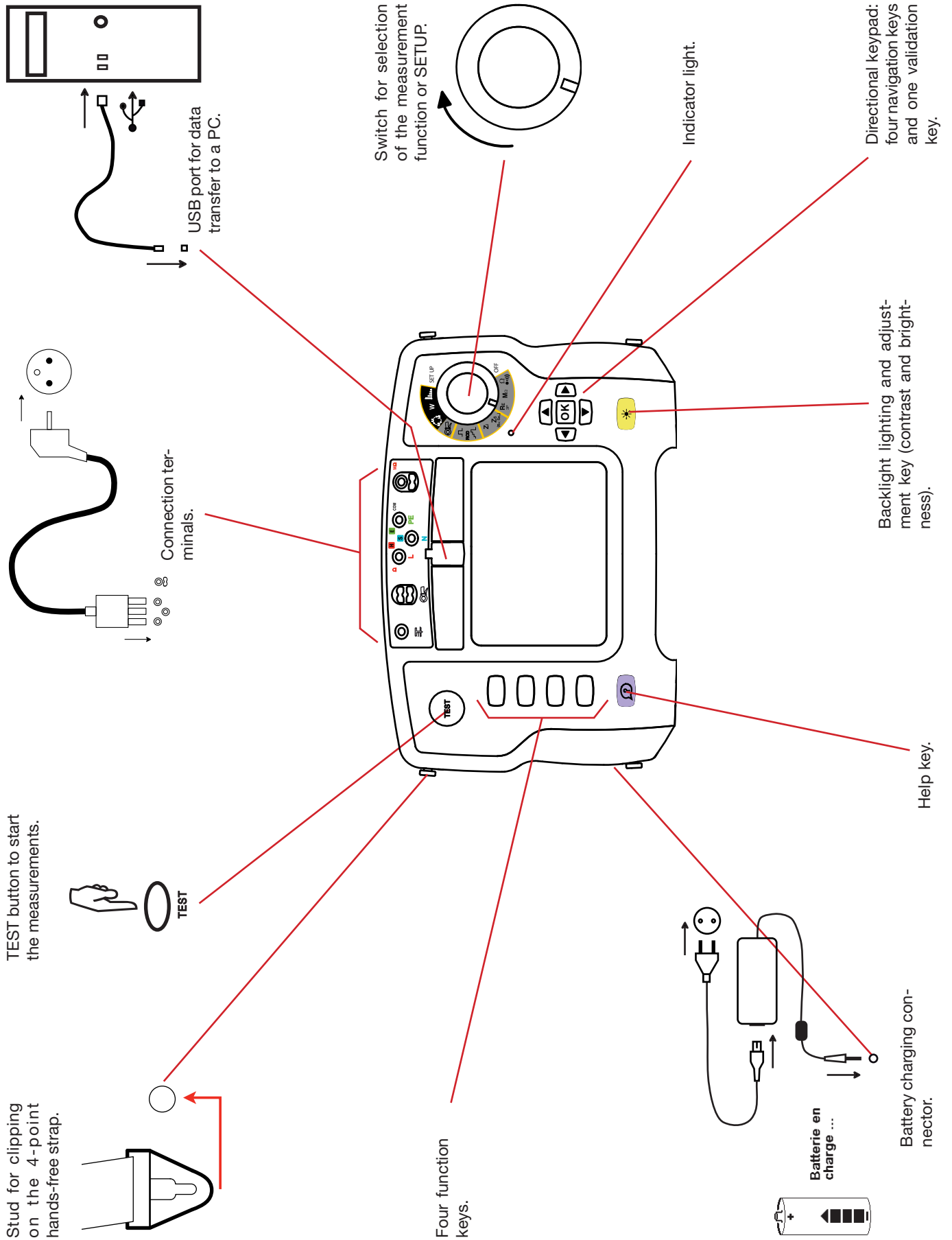

2.1. FUNCTIONS OF THE DEVICE

The C.A. 6116 installation tester is a portable measuring device with a monochrome graphic display. It is powered by a rechargeable battery with a built-in charger and external power supply unit.

This device is intended to check the safety of electrical installations. It can be used to test a new installation before it is powered up, to check an existing installation, whether in operation or not, or to diagnose a malfunction in an installation.

Measurement functions	<ul style="list-style-type: none"> ■ voltage ■ continuity and resistance ■ insulation resistance ■ earth resistance (with 3 rods) ■ loop impedance (Zs) ■ earth resistance on live circuit (with an auxiliary probe) ■ selective earth resistance (with a auxiliary probe and an optional current clamp) ■ line impedance (Zi) ■ test of residual current devices in ramp mode ■ test of residual current devices in pulse mode ■ current (with an optional current clamp) ■ detection of direction of phase rotation ■ power (single-phase or balanced three-phase) with display of the voltage and/or current curves ■ harmonics in voltage and current (with an optional clamp)
Controls	one thirteen-position switch, one five-key navigator, one keypad with four function keys, one context-sensitive help key, one backlight key, and one TEST button.
Display	5.7» (115 x 86mm) monochrome graphic LCD display unit, 1/4 VGA (320 x 240 points), with possibility of backlighting.

2.2. KEYPAD

The actions of the 4 function keys are indicated on the display unit by adjacent icons. They depend on the context.

The help key can be used in all functions. The help function is context-sensitive: it depends on the function.

The directional keypad comprises four navigation keys and one validation key.

In addition to lighting the backlighting, the key is used to adjust:

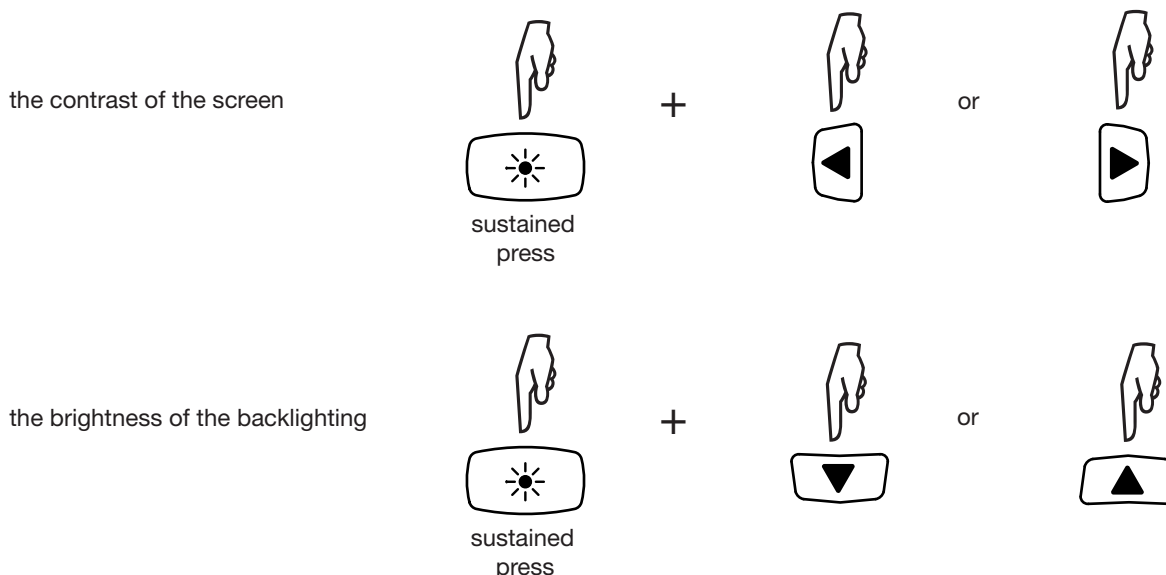

2.3. DISPLAY UNIT

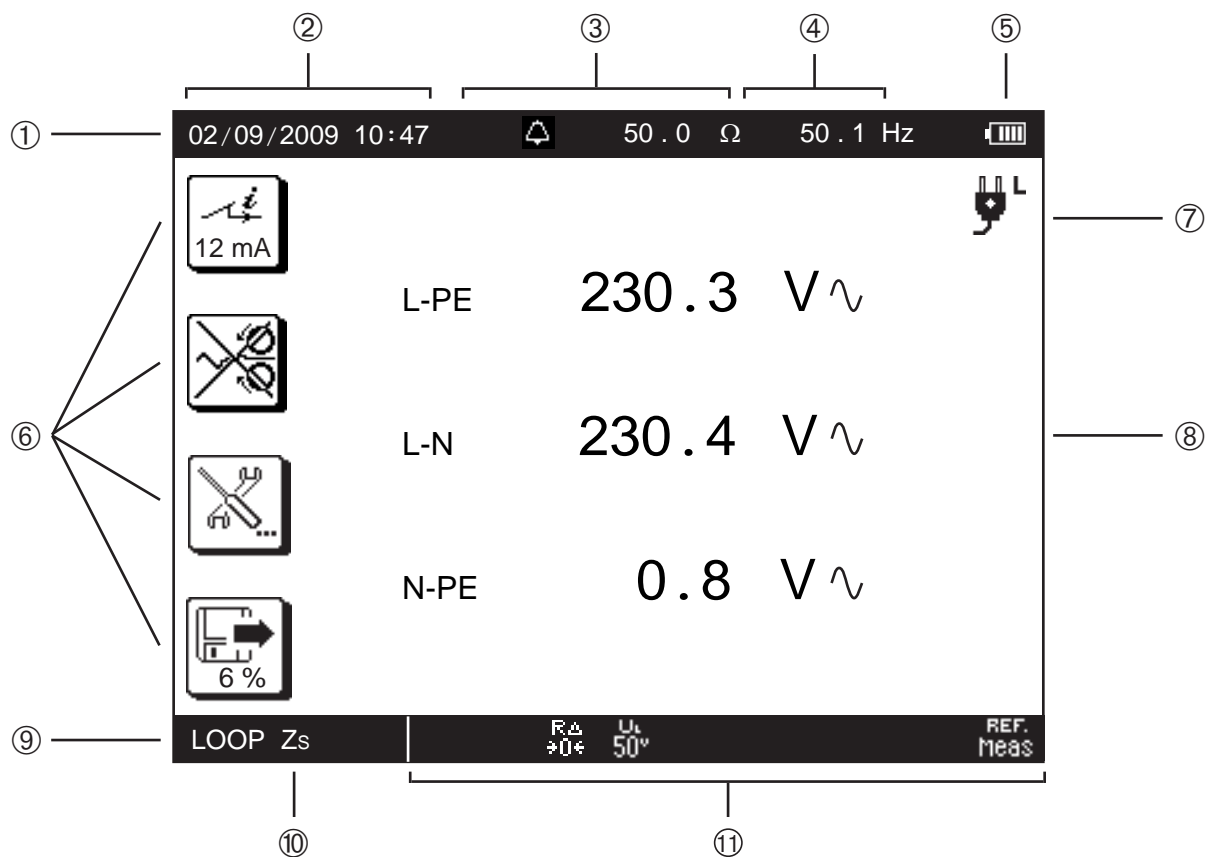

- | | |
|--|---|
| ① Top strip | ⑦ Position of the phase on the socket outlet |
| ② Date and time | ⑧ Display of measurement results |
| ③ Alarm threshold | ⑨ Bottom strip |
| ④ Frequency measured | ⑩ Name of function |
| ⑤ Condition of the battery | ⑪ Information about the measurement in progress |
| ⑥ Icons representing the functions of the keys | |

2.4. USB PORT

The USB port of the device is used to transfer the stored data to a PC. This operation requires the prior installation of a specific peripheral driver and other software.

The USB cord and the associated software are supplied with the device.

3. PROCEDURE

The device is configured so that it can be used without changing the parameters. For most measurements, simply select the measurement function by turning the switch and press the TEST key.

However, you can also parameterize the measurements, using the function keys, or the device itself, using SET-UP.

In addition to an intuitive interface, the C.A. 6116 provides complete help in use and analyses and appraisals. Three types of help function are available:

- On-line help before the measurement can be accessed using the  key. It indicates the connections to be made for each function and important recommendations.
- Error messages appear, as soon as the TEST key is pressed, to report connection errors, measurement parameterizing errors, out-of-range values, defective installations tested, etc.
- On-line help associated with the error messages. Messages containing the  icon invite you to look up the on-line help for ways to eliminate the error found.



The user is assumed to be at the reference earth potential. He/she must therefore not be insulated from earth: must not wear insulating shoes or insulating gloves and must not use a plastic object to press the TEST key.

3.1. VOLTAGE MEASUREMENT

3.1.1. DESCRIPTION OF THE MEASUREMENT PRINCIPLE

Whichever function is chosen, the device always starts by measuring the voltage present on its terminals.

It separates the alternating voltage from the direct voltage and compares the amplitudes to decide whether the signal is AC or DC. In the case of an AC signal, the frequency is measured and the device calculates the RMS value of the AC part and displays it. In the case of a DC signal, the device does not measure its frequency, but calculates its mean value and displays it.



For measurements made at the network voltage, the device checks that the connection is correct and displays the position of the phase on the socket outlet. It also checks the presence of a protective conductor on the PE terminal by means of the contact the user makes with his/her finger by touching the TEST key.

3.1.2. MAKING A MEASUREMENT

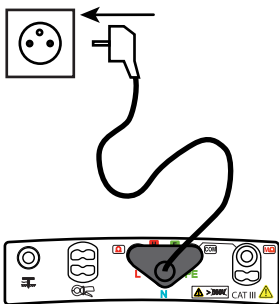
Connect the leads to the device to be tested. As soon as the device is powered up, it measures the voltages present on its terminals and displays them, whatever the setting of the switch.



The mains socket outlet of the measuring cable is marked with a white reference spot.

-  L : the phase is on the right-hand contact of the mains plug when the white spot is up.
-  L : the phase is on the left-hand contact of the mains plug when the white spot is up.
-  L L : the device cannot determine where the phase is, probably because the PE is not connected or the L and PE conductors are interchanged.

Remark : the terminal identified as L is the one that has the highest voltage with respect to PE; this does not mean that the other terminal is not at a dangerous voltage.

3.1.3. ERROR REPORTING

The only errors reported in voltage measurement are values outside the voltage and/or frequency measurement range. These errors are reported in clear language on screen.

3.2. RESISTANCE AND CONTINUITY MEASUREMENT

3.2.1. DESCRIPTION OF THE MEASUREMENT PRINCIPLE

For continuity measurements, the device generates a DC current of 200 or 12 mA, at the user's discretion, between the Ω and COM terminals. It then measures the voltage present between these two terminals and from it deduces the value of $R = V/I$. For resistance measurements (current chosen = $k\Omega$), the device generates a DC voltage between the Ω and COM terminals. It then measures the current between these two terminals and from it deduces the value of $R = V/I$.

In the case of a measurement at high current (200 mA), at the end of one second, the device reverses the direction of the current and makes another measurement for one second. The result displayed is the mean of these two measurements. It is possible to make measurements with either the positive or the negative polarity of the current disabled.

For measurements at low current (12 mA or $k\Omega$), the polarity is positive only.

3.2.2. MAKING A MEASUREMENT

To comply with standard IEC-61557, the measurements must be made at 200 mA. The reversal of the current serves to compensate for any residual electromotive forces and, more important, to check that the continuity is in fact duplex.

When you make continuity measurements that are not contractual, prefer a current of 12 mA. Even though the results cannot be regarded as those of a normative test, this significantly increases the life of the device between charges and forestalls untimely tripping of the installations if there is a connection error.

The permanent mode is used to chain measurements without having to press the TEST button each time. If the object to be measured is permanent, it is better to switch to pulse mode and make a measurement at positive polarity, then a measurement at negative polarity, manually, in order to leave time for the measurement to settle.

The alarm, if activated, serves to report, by an audible signal, that the measurement is below threshold, making it unnecessary to look at the display unit to check this point.

Set the switch to Ω (●●●).

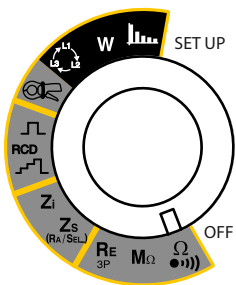

Use the leads to connect the device to be tested between the W and COM terminals of the device. The object to be tested must not be live.

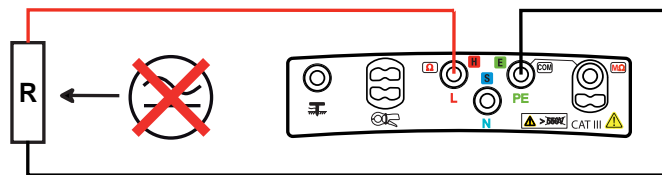

Before starting the measurement, you can configure it by modifying the parameters displayed:



Choice of measurement current: kW, 12 mA or 200 mA (default).

- The high current (200 mA) is used to measure only low resistance values, up to 40 Ω .
- The low current (12 mA) is used to make measurements up to 400 Ω .
- The choice kW is used to make resistance measurements up to 400 $k\Omega$.



To correct for the resistance of the measurement leads (leads and probe tips or alligator clips), for measurements at 12 and 200 mA (see §3.14).

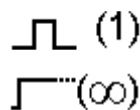

(1) Pressing the TEST key starts only one measurement (pulse mode).

(∞) Pressing the TEST key starts the continuous measurement (permanent mode). To stop it, you must press the TEST key again. The permanent mode is the default operating mode.



R± Automatic reversal of polarity for a measurement at 200 mA (default).

R+ Measurement at positive polarity only.

R- Measurement at negative polarity only (for a measurement at 200 mA).

If you want only a single polarity, you must program it again each time you enter the continuity function.



To activate the alarm.



To deactivate the alarm.



Ω

002.00

To set the alarm threshold; 2Ω is default (see §3.15).



k Ω



Before the measurement: to display the measurements already recorded.

During or after the measurement: to record it.

The direction of the arrow indicates whether you can make a reading (arrow pointing out) or a recording (arrow pointing in).

Once the parameters have been defined, you can start the measurement.



If you selected the pulse mode, press the TEST button once and the measurement stops automatically when it is over.

If you selected the permanent mode, press the TEST button once to start the measurement and a second time to stop it, or else press the record key  directly.

3.2.3. READING OF THE RESULT

■ In the case of a 200 mA current:

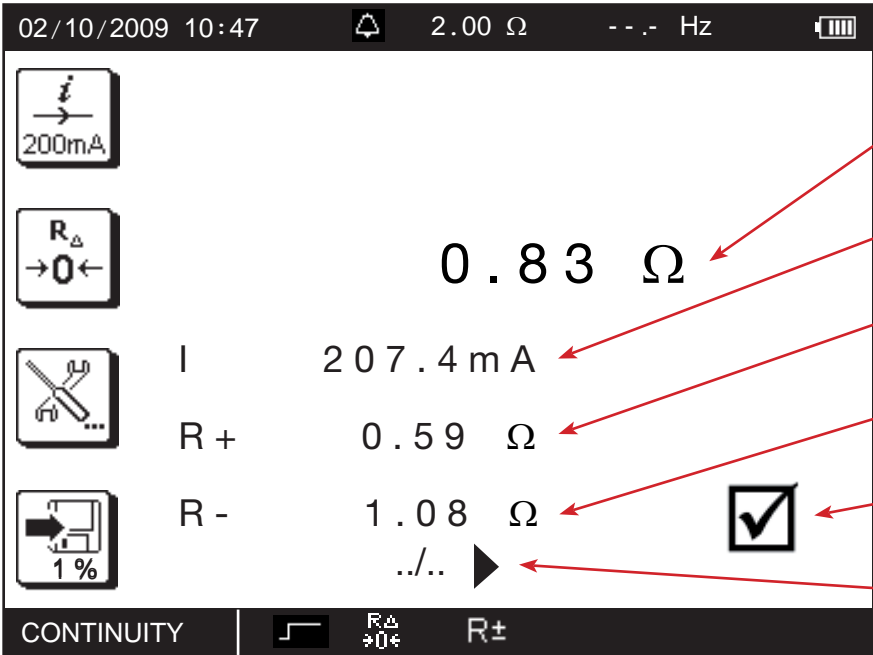

Value of the alarm threshold.

Measurement result:

$$R = \frac{(R+) + (R-)}{2}$$

Measurement current.

Measurement with a positive current (R+).

Measurement with a negative current (R-).

Case where the measurement is below the alarm threshold.

Use the ► key to see the rest of the measurement display.

Bipolar measurement.

Compensation for the resistance of the measurement leads is activated.

Permanent mode.



To see the next display page.

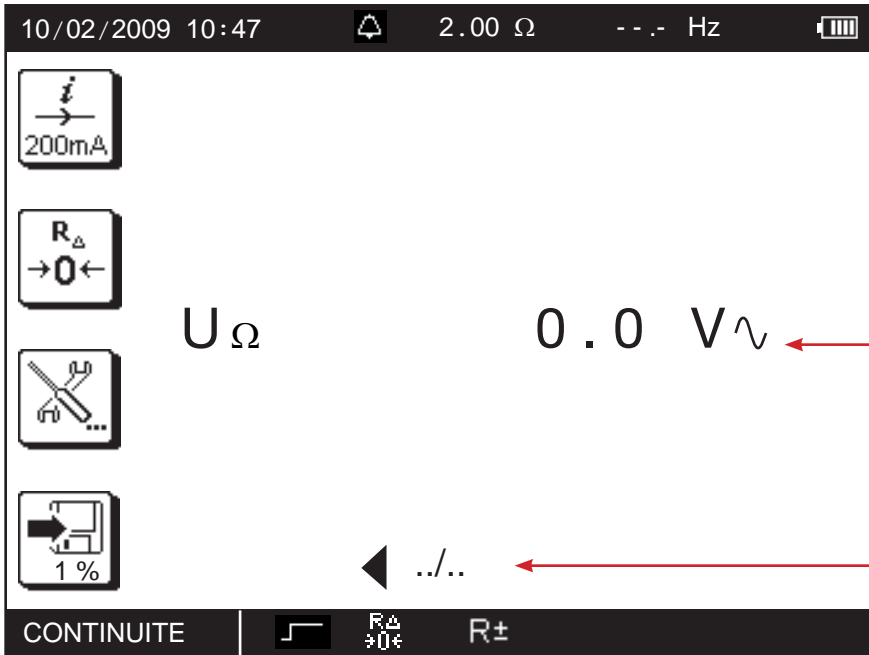

External voltage present on the terminals just before the start of the measurement.

Use the ◀ key to return to the previous display page.

- In the case of a 12 mA current, there is no current reversal and only the main measurement is displayed.

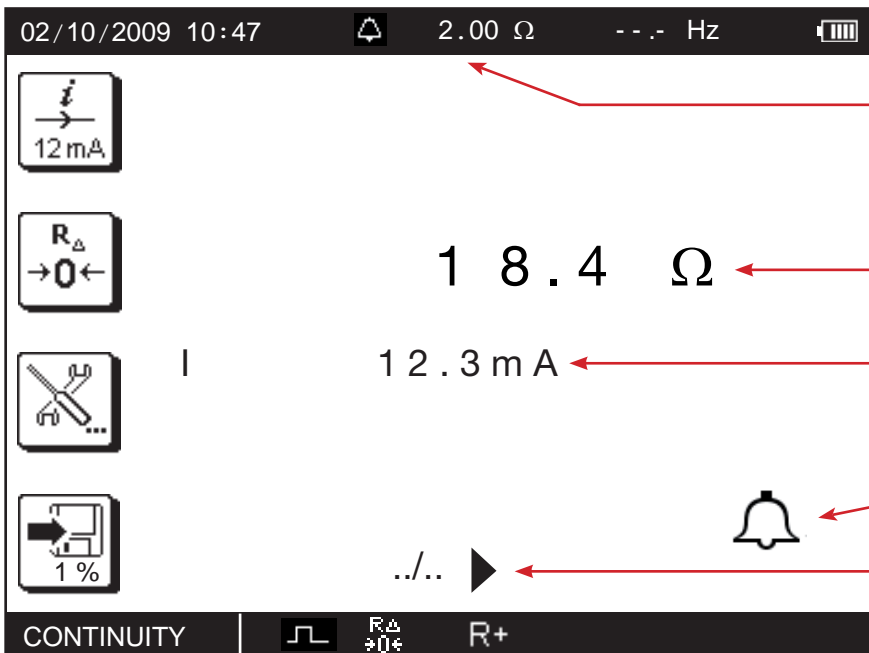

Value of the alarm threshold.

Measurement result.

Current measurement.

Case where the measurement is above the alarm threshold.

Use the ▶ key to see the rest of the measurement display.

The polarity of the current is positive.

Compensation for the resistance of the measurement leads is activated.

Pulse mode.

- In the case of a resistance measurement ($k\Omega$), there is no current reversal and no compensation for the measurement leads.

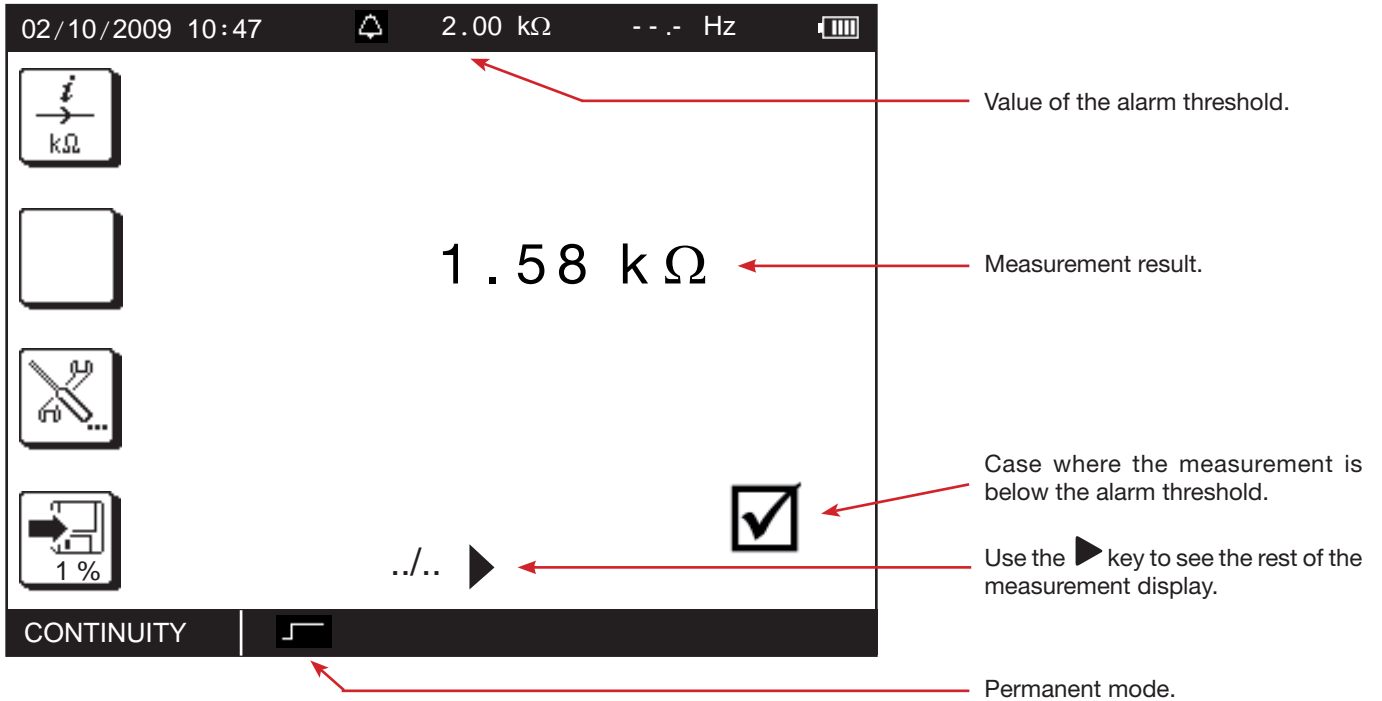

3.2.4. ERROR REPORTING

The commonest error in the case of a continuity measurement is the presence of a voltage on the terminals. An error message is displayed if a voltage greater than 0.5 VRMS is detected and you press the TEST button.

In this case, the continuity measurement is not enabled. Eliminate the cause of the interference voltage and start the measurement over.

Another possible error is measurement of an overly inductive load that prevents the measurement current from stabilizing. In this case, start the measurement in permanent mode with only one polarity and wait for the measurement to stabilize.

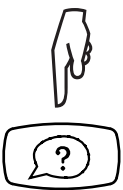

For help with connections or any other information, use the on-line help.

3.3. INSULATION RESISTANCE MEASUREMENT

3.3.1. DESCRIPTION OF THE MEASUREMENT PRINCIPLE

The device generates a DC test voltage greater than the nominal voltage chosen U_N between the COM and $M\Omega$ terminals. The value of this voltage depends on the resistance to be measured: it is greater than or equal to U_N when R is greater than or equal to $R_N = U_N / 1 \text{ mA}$, and less otherwise. The device measures the voltage and current present between the two terminals and from them deduces the value of $R = V / I$.

3.3.2. MAKING A MEASUREMENT

The alarm, if activated, serves to report, by an audible signal, that the measurement is below threshold, making it unnecessary to look at the display unit to check this point.

Set the switch to $M\Omega$.

Use the leads to connect the device to be tested between the COM and $M\Omega$ terminals of the device. The object to be tested must not be live.

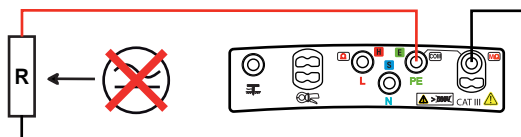
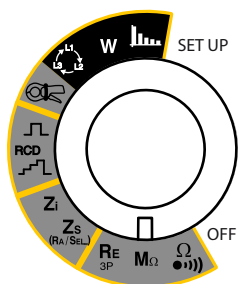

Remark : To avoid leakage during the insulation measurement, which would throw off the measurement, it is best not to use the measuring cable when you make this type of measurement, but two simple leads.

Generally, an insulation measurement on an installation is made between the interconnected phase(s) and neutral, on the one hand, and earth, on the other.

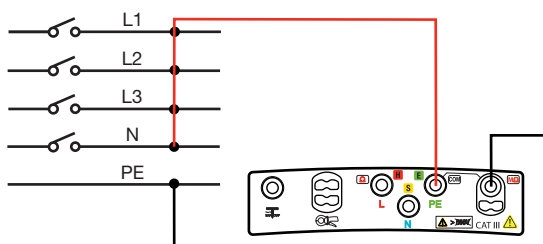

If the insulation is not sufficient, you must then make the measurement between each of the pairs to locate the fault. It is for this reason possible to index the recorded value with one of the following values: L-N/PE, L-N, L-PE, N-PE, L1-PE, L2-PE, L3-PE, L1-N, L2-N, L3-N, L1-L2, L2-L3 or L3-L1

To use the remote control probe, refer to its operating data sheet.

Before starting the measurement, you can configure it by modifying the parameters displayed:



To choose the nominal test voltage U_N : 50, 100, 250, 500 (default) or 1000 V.



To activate the alarm.



To deactivate the alarm.

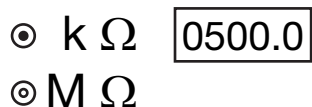

To set the alarm threshold (see §3.15). As default, the threshold is set to $R (k\Omega) = U_N / 1 \text{ mA}$.



Before the measurement: to display the measurements already recorded.
 During or after the measurement: to record it.
 The direction of the arrow indicates whether you can make a reading (arrow pointing out) or a recording (arrow pointing in).



Once the parameters have been defined, you can start the measurement.

Keep the TEST button pressed until the measurement is stable. The measurement stops when the TEST button is released.



Before disconnecting the leads or starting another measurement, wait a few seconds for the device tested to be discharged (when the ⚡ symbol disappears from the display unit).

3.3.3. READING OF THE RESULT

The screenshot shows the following elements on the display:

- Top status bar: 02/11/2009 10:47, 500 k Ω , --.- Hz, and a battery level icon.
- Left sidebar: U_N 500V, a warning icon, a bell icon, and a 2% battery icon.
- Top scale: A bargraph with labels 10k, 100k, 1M, 10M, 100M, 1000M and sub-labels 20, 50, 200, 500, 2, 5, 20, 50, 200, 500.
- Center: A measurement result of 31.06 M Ω .
- Below result: A lightning bolt icon and the text "7 s".
- Bottom: A box with the text "Press TEST until the measurement is stable", a checkmark icon, and a right-pointing arrow icon.
- Bottom bar: The word "INSULATION".

Annotations with red arrows point to the following features:

- Value of the alarm threshold. (points to the 500 k Ω value in the top bar)
- The bargraph provides a rapid quantitative indication of the quality of the insulation. (points to the bargraph)
- Measurement result. (points to 31.06 M Ω)
- The test voltage U_N is present and dangerous. (points to the lightning bolt icon)
- Duration of the measurement. (points to 7 s)
- Case where the measurement is above the alarm threshold. (points to the checkmark icon)
- Use the ► key to see the rest of the measurement display. (points to the right-pointing arrow icon)



To see the next display page.

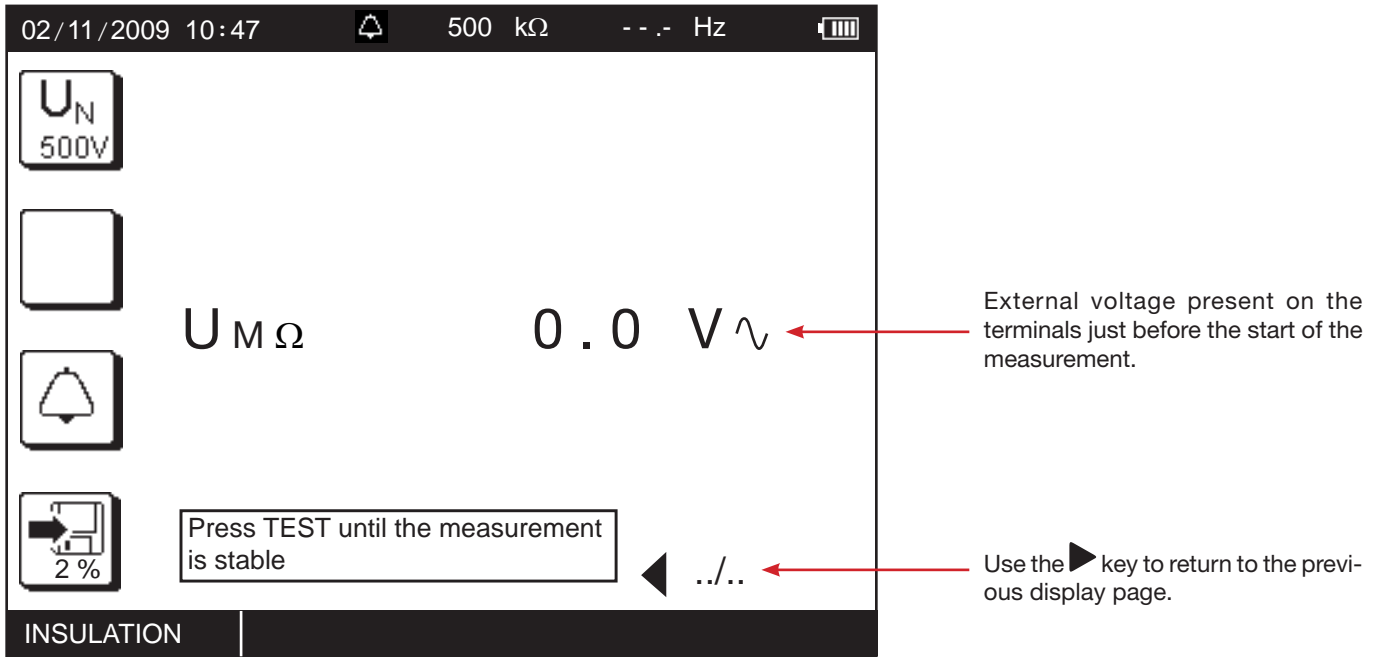

3.3.4. ERROR REPORTING

The commonest error in the case of an insulation measurement is the presence of a voltage on the terminals. If it is greater than 50 V, the insulation measurement is not enabled. Eliminate the voltage and start the measurement over.

The measurement may be unstable, probably because of an overly capacitive load or an insulation fault. In this case, read the measurement on the bargraph.

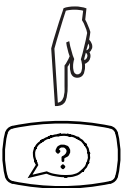

For help with connections or any other information, use the on-line help.

3.4. 3P EARTH RESISTANCE MEASUREMENT

This function is used to measure an earth resistance with two additional rods, the third rod being constituted by the earth electrode to be tested.

It is possible to make a rapid measurement and measure only R_E or else to make a more detailed measurement by also measuring the resistances of the rods.

3.4.1. DESCRIPTION OF THE MEASUREMENT PRINCIPLE

The device generates between the H and E terminals a square wave at a frequency of 128 Hz and an amplitude of 35 V. It measures the resulting current, I_{HE} , along with the voltage present between the S and E terminals, U_{SE} . It then calculates the value of $R_E = U_{SE} / I_{HE}$.

To measure the resistances of the R_S and R_H rods, the device internally reverses the E and S terminals and makes a measurement. It then does likewise with the E and H terminals.

3.4.2. MAKING A MEASUREMENT

There are several measurement methods. We recommend the «62%» method.

Set the switch to RE 3P.

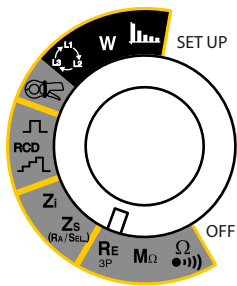

Plant the H and S rods in line with the earth electrode. The distance between the S rod and the earth electrode must be approximately 62% of the distance between the H rod and the earth electrode.

In order to avoid electromagnetic interference, we recommend paying out the full length of the cables, placing them as far apart as possible, and not making loops.

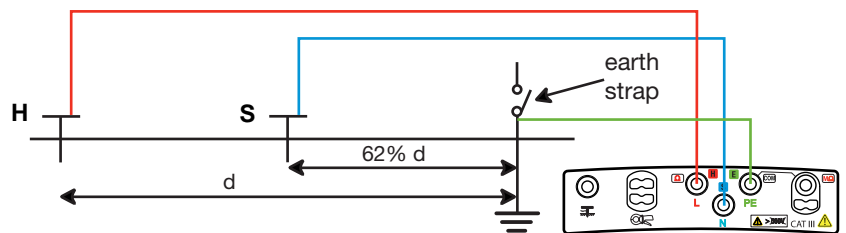

Connect the cables to the H and S terminals. Power down the installation and disconnect the earth strap. Then connect the E terminal to the earth electrode to be checked.

The alarm, if activated, serves to report, by an audible signal, that the measurement is above threshold, making it unnecessary to look at the display unit to check this point.

Before starting the measurement, you can configure it by modifying the parameters displayed:



Choice of type of measurement: rapid, to measure R_E only (icon crossed out), or detailed, to measure also rod resistances R_S and R_H .



To compensate for the resistance of the lead connected to the E terminal, for measurements of low values (see §3.14).



To activate the alarm.



To deactivate the alarm.

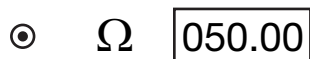

To set the alarm threshold (see §3.15). As default, the threshold is set to 50Ω.



Before the measurement: to display the measurements already recorded.

During or after the measurement: to record it.

The direction of the arrow indicates whether you can make a reading (arrow pointing out) or a recording (arrow pointing in).

If the measurement must be made in a damp environment, remember to change the value of maximum contact voltage U_L in Setup (see §5) and set it to 25 V.



Press the TEST button to start the measurement. The measurement stops automatically.



This symbol invites you to wait while the measurement is in progress.



Do not forget to **reconnect the earth strap** at the end of the measurement before powering the installation back up.

3.4.3. READING OF THE RESULT

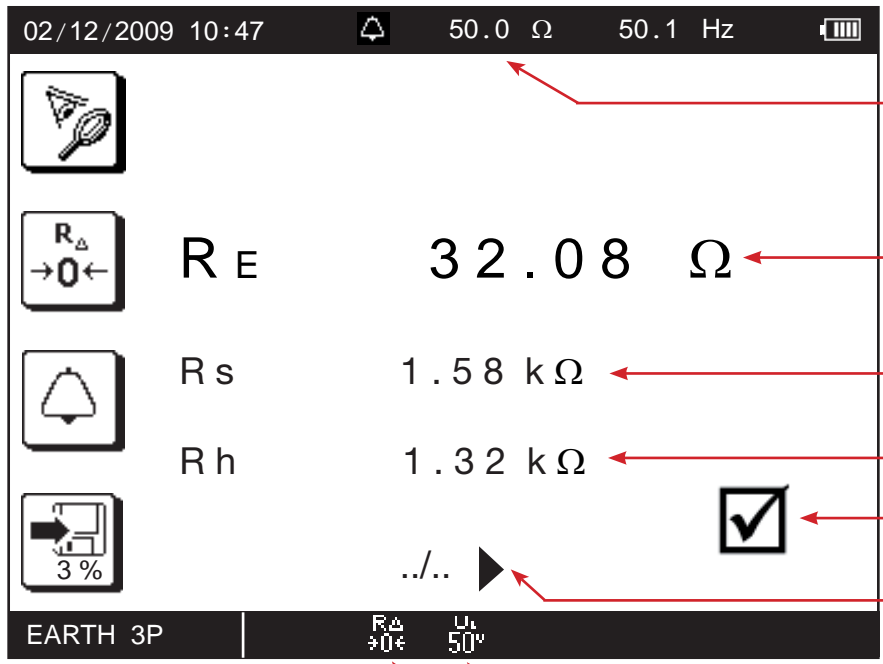

- Value of the alarm threshold.
- Measurement result.
- Resistance of the S rod.
- Resistance of the H rod.
- Case where the measurement is below the alarm threshold.
- The ► key is used to see the voltages before the beginning of the test.
- Programmed maximum contact voltage.
- Compensation for the resistance of the measurement leads is activated.

3.4.4. VALIDATION OF THE MEASUREMENT

To validate your measurement, move the S rod towards the H rod by 10% of d and make another measurement. Then move the S rod, again by 10% of d, but towards the earth electrode.

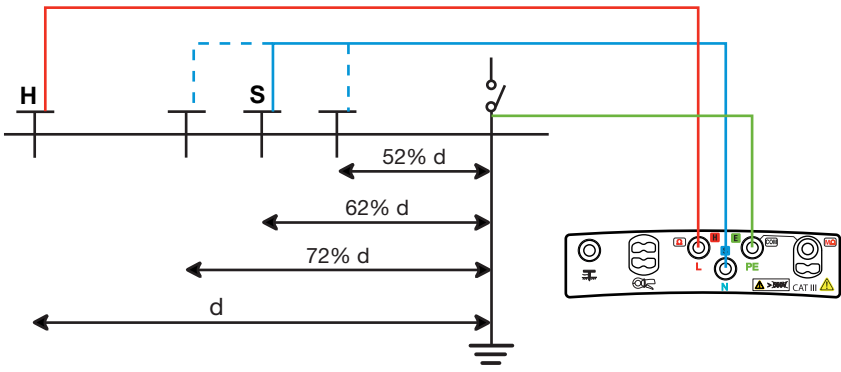

The 3 measurement results must be the same to within a few percent. If this is the case, the measurement is valid. If not, it is because the S rod is in the zone of influence of the earth electrode.

If the resistivity of the ground is homogeneous, it is necessary to increase distance d and repeat the measurements. If the resistivity of the ground is inhomogeneous, the measurement point must be moved either towards the H rod or towards the earth terminal until the measurement is valid.

3.4.5. POSITIONING OF THE AUXILIARY RODS

To make sure that your earth measurements are not distorted by interference, we recommend repeating the measurement with the auxiliary rods placed at a different distance and in another direction (for example rotated 90° from the first alignment).

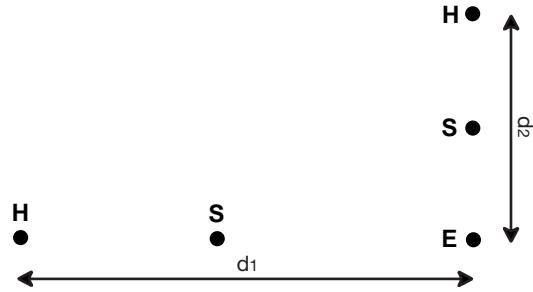

If you find the same values, your measurement is reliable. If the measured values are substantially different, it is probable that they were influenced by earth currents or a groundwater artery. It may be useful to drive the rods deeper.

If the in-line configuration is not possible, you can plant the rods in a triangle. To validate the measurement, move the S rod on either side of the line HE.

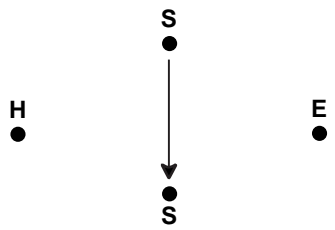

Avoid routing the connecting cables of the earth rods near or parallel to other cables (transmission or power supply), metal pipes, rails, or fences, this in order to avoid the risk of cross-talk with the measurement current.

3.4.6. ERROR REPORTING

The commonest errors in the case of an earth measurement are the presence of an interference voltage or rod resistances that are too high.

If the device detects:

- a rod resistance greater than $15k\Omega$,
- a voltage greater than 25 V on H or on S when the TEST button is pressed.

In these two cases, the earth measurement is not enabled. Move the rods and start the measurement over.

To reduce the resistance of the rods R_H (R_S), you can add one or more rods, two metres apart, in the H (S) branch of the circuit. You can also drive them deeper and pack the earth around them, or wet it with a little water.



For help with connections or any other information, use the on-line help.

3.5. LOOP IMPEDANCE MEASUREMENT (Z_s)

In a TT type installation, the loop impedance measurement is an easy way to make an earth measurement without planting any rods. The result obtained, Z_s , is the loop impedance of the installation between the L and PE conductors. It is only very slightly greater than the earth resistance, to which it adds the earthing resistance of the transformer and the resistance of the cables, which are both negligible.

In a TN or TT type installation, the loop impedance measurement also makes it possible to calculate the short-circuit current and size the protections of the installation (fuse or circuit-breaker).

This measurement cannot be made in an IT type installation because of the high earthing impedance of the supply transformer, which may even be completely isolated from earth.

3.5.1. DESCRIPTION OF THE MEASUREMENT PRINCIPLE

The device starts by generating pulses having a duration of 300 μ s and an amplitude of at most 5 A between the L and N terminals. This first measurement is used to determine Z_L .

It then applies a low current, 6, 9 or 12 mA at the user's discretion, between the L and PE terminals. This low current serves to avoid tripping residual current devices of which the nominal current is greater than or equal to 30 mA. This second measurement is used to determine Z_{PE} .

The device then calculates loop resistance $Z_s = Z_{L-PE} = Z_L + Z_{PE}$, and short-circuit current $I_k = U_{LPE} / Z_s$.

The value of I_k serves to check the proper sizing of the circuit-breaker.

For greater accuracy, it is possible to measure Z_s with a high current (TRIP mode), but this measurement may trip out the installation.

3.5.2. MAKING A MEASUREMENT

Set the switch to Z_s (R_A/SEL).

Connect the measuring cable to the device, then to the socket outlet of the installation to be tested.

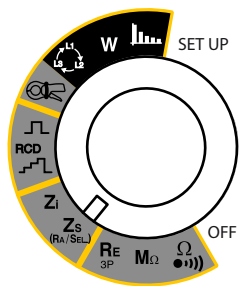

At the time of connection, the device first checks that the voltages present on its terminals are correct, then determines the position of the phase (L) and of the neutral (N) with respect to the protective conductor (PE) and displays it. If necessary, it then automatically switches the L and N terminals so that the loop measurement can be made without modifying the connections of the terminals of the device.



If possible, first disconnect all loads from the network on which you make the loop measurement.

It is possible to eliminate this step if you use a measurement current of 6 mA, which allows a leakage current of up to 9 mA for an installation protected by a 30 mA residual current device.

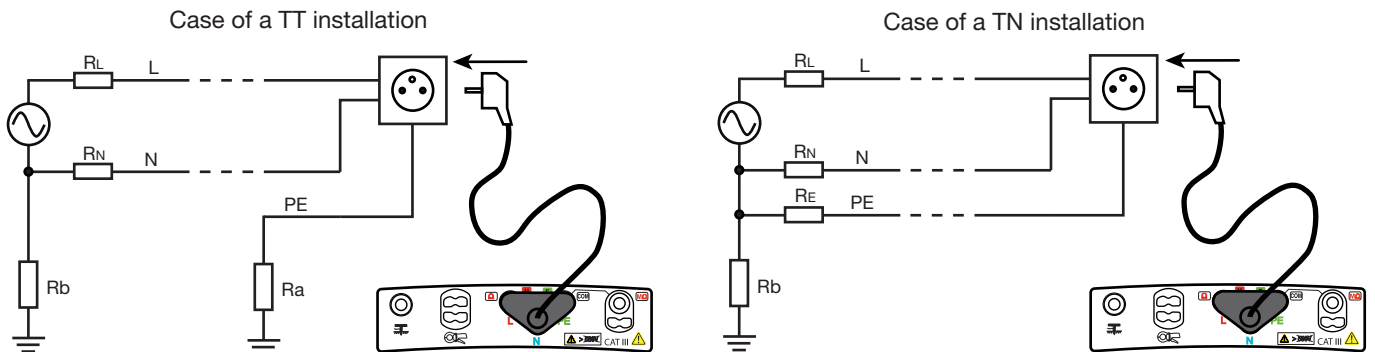

Note: in trip mode, it is not necessary to connect the N terminal.

For a more accurate measurement, you can choose a high current (TRIP mode), but the circuit-breaker that protects the installation may trip out. To prevent this, you can short-circuit the circuit-breaker during the measurement, as follows:

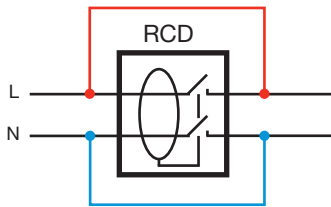

For the safety of the installation and of the users, you must not forget **to put the residual current device back in service** after the measurement.

The alarm, if activated, serves to report, by an audible signal, that the measurement is above threshold, making it unnecessary to look at the display unit to check this point.

Smoothing the signal, rather than making several measurements and calculating a mean, yields a stable measurement directly. But the measurement then takes longer.

Before starting the measurement, you can configure it by modifying the parameters displayed:



Choice of measurement current in non-tripping mode: 6, 9, 12 mA (default)

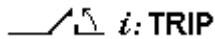

or TRIP mode to use a high current that will give a more stable measurement.



To activate or deactivate the smoothing of the signal.



To compensate for the resistance of the measurement leads, for measurements of low values (see §3.14).



The device proposes choosing the voltage for the I_k calculation from among the following values:

- MEAS (the measured voltage value),
- the voltage of the old standard (for example 220),
- the voltage of the current standard (for example 230).

Depending on the voltage U_{LN} measured, the device proposes the following choices:

- if $170 < U_{LN} < 270$ V: MEAS (default), 220 V, or 230 V.
- if $90 < U_{LN} < 150$ V: MEAS (default), 110 V or 127 V.
- if $300 < U_{LN} < 550$ V: MEAS (default), 380 V or 400 V.



To deactivate the alarm.

Z-R

To activate the alarm on Z_{LPE} (in TRIP mode) or on R_{LPE} (in non-tripping mode).

Ω

To set the alarm threshold (see §3.15). As default, the threshold is set to 50 Ω .

k Ω

Ik

To activate the alarm on I_k .

A

To set the alarm threshold (see §3.15). As default, the threshold is set to 10 kA.

k A



Before the measurement: to display the measurements already recorded.

During or after the measurement: to record it.

The direction of the arrow indicates whether you can make a reading (arrow pointing out) or a recording (arrow pointing in).



Press the TEST button to start the measurement. The measurement stops automatically.

When the TEST key is pressed, the device checks that the contact voltage is less than U_L . If not, it does not make the loop impedance measurement.



This symbol invites you to wait while the measurement is in progress.

3.5.3. READING OF THE RESULT

■ In the case of a non-tripping measurement, with smoothing:

02/16/2009 10:47

50.0 Ω 50.1 Hz

12 mA

I_k 206.6 A

Z_s 1.24 Ω

R_s 1.04 Ω

L_s 0.2 mH

4 %

LOOP Z_s REF. Meas

50V

Value of the alarm threshold.

Position of the phase on the socket outlet.

Value of the short-circuit current.

Value of the impedance.

Value of the resistance.

Value of the inductance.

Case in which the measurement is below the alarm threshold.

The ► key is used to access the next page to see the voltages before the beginning of the test.

Value of the reference voltage for the calculation of I_k .

Programmed maximum contact voltage.

Compensation for the resistance of the measurement leads is activated.

■ In the case of a measurement with tripping (TRIP) and without smoothing:

02/17/2009 10:47

10.0 Ω 50.1 Hz

3.1 A

Z_s 34.61 Ω

R_s 34.48 Ω

L_s 9.4 mH

4 %

LOOP Z_s REF. Meas

25V

Value of the alarm threshold.

Position of the phase on the socket outlet.

Value of the short-circuit current.

Value of the impedance.

Value of the resistance.

Value of the inductance.

Case where the measurement is above the alarm threshold.

The ► key is used to access the next page to see the voltages before the beginning of the test.

Value of the reference voltage for the calculation of I_k .

Programmed maximum contact voltage.

Compensation for the resistance of the measurement leads is activated.

3.6. MEASUREMENT OF THE LINE IMPEDANCE (Z_i)

The loop impedance measurement Z_i (L-N, L1-L2, or L2-L3 or L1-L3) is used to calculate the short-circuit current and size the protections of the installation (fuse or circuit-breaker), whatever type of neutral the installation uses.

3.6.1. DESCRIPTION OF THE MEASUREMENT PRINCIPLE

The device generates pulses having a duration of 300 μ s and an amplitude of at most 5 A between the L and N terminals. It then measures the voltages U_L and U_N and from them deduces Z_i .

The device then calculates the short-circuit current $I_k = U_{LN}/Z_i$ the value of which serves to check the proper sizing of the protections of the installation.

3.6.2. MAKING A MEASUREMENT

Set the switch to Z_i .

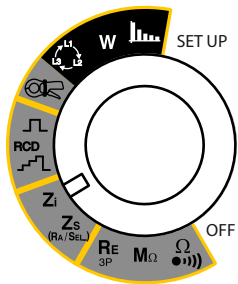

Connect the measuring cable to the device, then to the socket outlet of the installation to be tested.

At the time of connection, the device first checks that the voltages present on its terminals are correct, then determines the position of the phase (L) and of the neutral (N) with respect to the protective conductor (PE) and displays it. If necessary, it then automatically switches the L and N terminals so that the line impedance measurement can be made without modifying the connections of the terminals of the device.



If you use the measuring cable that is terminated by three leads, connect the PE lead (green) to the N lead (blue). Otherwise, the device cannot display the position of the phase. But this does not prevent making the measurement.

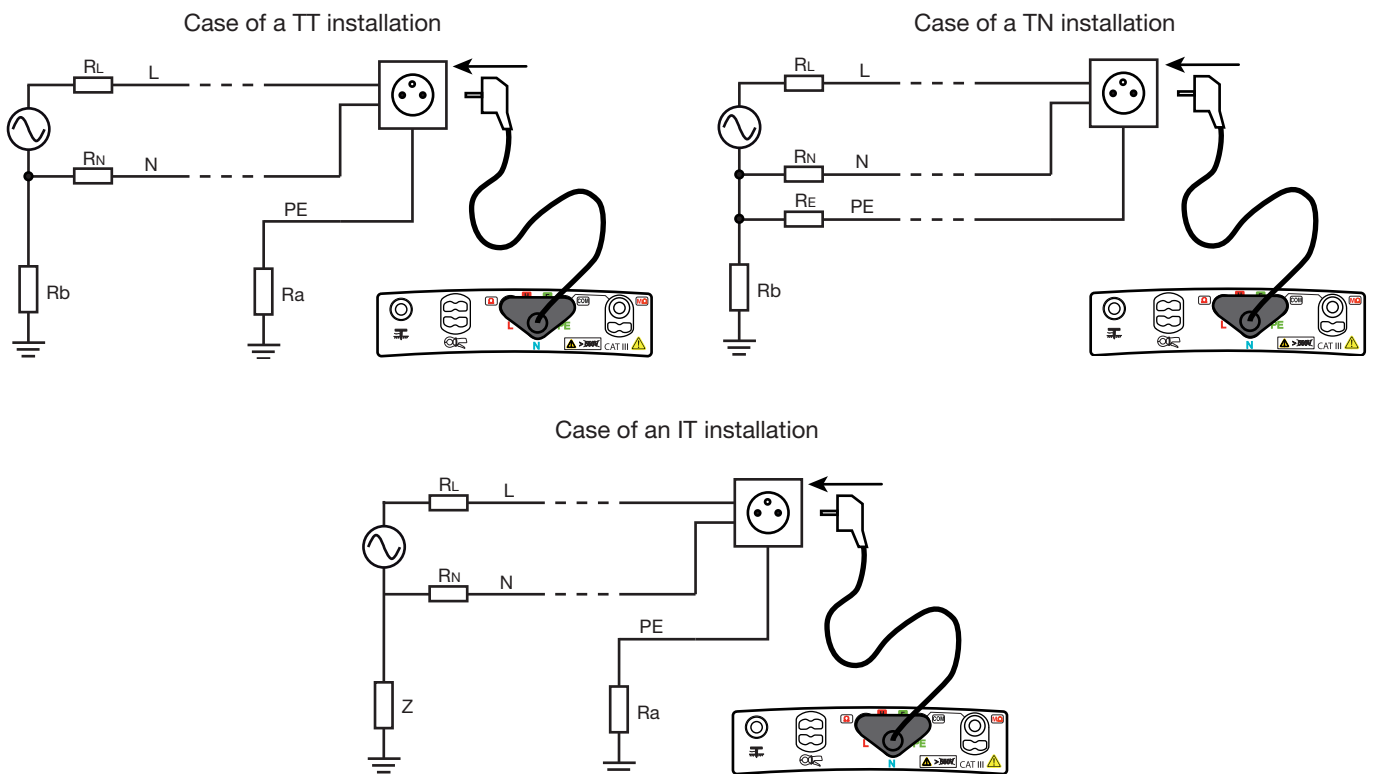

The alarm, if activated, serves to report, by an audible signal, that the measurement is above threshold, making it unnecessary to look at the display unit to check this point.

Smoothing the signal, rather than making several measurements and calculating a mean, yields a stable measurement directly. But the measurement then takes longer.

Before starting the measurement, you can configure it by modifying the parameters displayed:



To activate or deactivate the smoothing of the signal.



To compensate for the resistance of the measurement leads, for measurements of low values (see §3.14).



The device proposes choosing the voltage for the Ik calculation from among the following values:

- MEAS (the measured voltage value),
- the voltage of the old standard (for example 220 V),
- the voltage of the current standard (for example 230 V).

Depending on the voltage U_{LN} measured, the device proposes the following choices:

- if 170 < U_{LN} < 270 V: MEAS (default), 220 V, or 230 V.
- if 90 < U_{LN} < 150 V: MEAS (default), 110 V or 127 V.
- if 300 < U_{LN} < 550 V: MEAS (default), 380 V or 400 V.



To deactivate the alarm.

Z-R

To activate the alarm on Zi.

Ω 050.00

To set the alarm threshold (see §3.15). As default, the threshold is set to 50 Ω.

k Ω

Ik

To activate the alarm on Ik.

A 010.00

To set the alarm threshold (see §3.15). As default, the threshold is set to 10 kA.

k A



Before the measurement: to display the measurements already recorded.

During or after the measurement: to record it.

The direction of the arrow indicates whether you can make a reading (arrow pointing out) or a recording (arrow pointing in).



Press the TEST button to start the measurement. The measurement stops automatically.

When the TEST key is pressed, the device checks that the contact voltage is less than UL. If not, it does not make the loop impedance measurement.



This symbol invites you to wait while the measurement is in progress.

3.6.3. READING OF THE RESULT

The screenshot shows a measurement results screen with the following data and features:

- Top Bar:** Date and time (02/18/2009 10:47), alarm threshold (50.0 Ω), frequency (50.1 Hz), and battery level.
- Left Panel:** Four icons representing different measurement modes: a crossed-out circle, a resistor with a zero, a crossed-out circle with a plus, and a plug with a percentage.
- Main Display:**
 - I_k : 1316 A
 - Z_i : 0.29 Ω
 - R_i : 0.15 Ω
 - L_i : 0.8 mH
 - Reference voltage:/..
 - Checkmark icon:
- Bottom Bar:**
 - Mode: LOOP Zi
 - Resistor compensation: $R_{\Delta} \rightarrow 0 \%$
 - Voltage: U_c 50V
 - Reference voltage: REF. Meas

Red arrows point from the text on the right to the corresponding elements on the screen:

- Value of the alarm threshold. (points to 50.0 Ω)
- Position of the phase on the socket outlet. (points to the plug icon)
- Value of the short-circuit current. (points to 1316 A)
- Value of the impedance. (points to 0.29 Ω)
- Value of the resistance. (points to 0.15 Ω)
- Value of the inductance. (points to 0.8 mH)
- Case where the measurement is below the alarm threshold. (points to the checkmark icon)
- The ► key is used to access the next page to see the voltages before the beginning of the test. (points to the right arrow icon)
- Value of the reference voltage for the calculation of I_k . (points to/..)
- Programmed maximum contact voltage. (points to 50V)
- Compensation for the resistance of the measurement leads is activated. (points to $R_{\Delta} \rightarrow 0 \%$)

3.7. EARTH MEASUREMENT ON LIVE CIRCUIT (Z_A , R_A)

This function is used to make an earth resistance measurement in a place where it is impossible to make a 3P earth measurement or to disconnect the earth connection strap, often the case in an urban environment.

This measurement is made without disconnecting the earth, with only one additional rod, saving time with respect to a conventional earth measurement with two auxiliary rods.

In the case of a TT type installation, this measurement is a very simple way to measure the earth of frame grounds.

In the case of an IT type installation, too, this measurement is a very simple way to measure the earth of frame grounds provided that:

- the supply transformer is not isolated from earth but connected to it via an impedance,
- and the installation is not in a first fault state. Check the indication given by the PIT.

In the case of a TN type installation, to determine the value of each of the earths put in parallel, it is necessary to perform a selective earth measurement on live circuit using a current clamp (see §3.8). Without this clamp, what you find is the value of the global earth connected to the network, which is rather meaningless.

It is then more useful to measure the loop impedance to size the fuses and circuit-breakers, and to measure the fault voltage to check the protection of persons.

3.7.1. DESCRIPTION OF THE MEASUREMENT PRINCIPLE

The device starts by making a loop measurement Z_s (see §3.5) with a low current or a high current, at the user's discretion. It then measures the potential between the PE conductor and the auxiliary rod and from it deduces $R_A = U_{PI-PE}/I$, I being the current chosen by the user.

For greater accuracy, it is possible to make the measurement with a high current (TRIP mode), but this measurement may trip out the installation.

3.7.2. MAKING A MEASUREMENT

Set the switch to Z_s ($R_A/SEL.$).

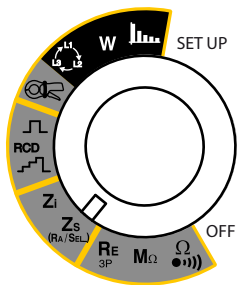

Connect the measuring cable to the device, then to the socket outlet of the installation to be tested.

At the time of connection, the device detects the positions of the phase (L) and of neutral (N) with respect to the protective conductor (PE) and displays them. If necessary, it then automatically switches the L and N terminals so that the loop measurement can be made without modifying the connections of the terminals of the device.



If possible, first disconnect all loads from the network on which you make the earth measurement on line circuit.

It is possible to eliminate this step if you use a measurement current of 6 mA, which allows a leakage current of up to 9 mA for an installation protected by a 30 mA residual current device.

Plant the auxiliary rod at a distance of more than 25 metres from the earth electrode and connect it to the R_A (S_{EL}) terminal of the device. The R_A symbol is then displayed.

Case of a TT installation

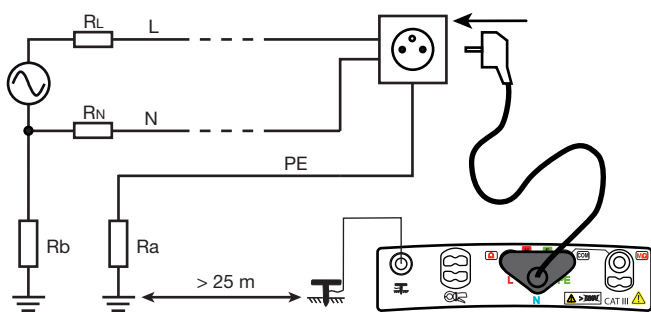

Case of an IT installation

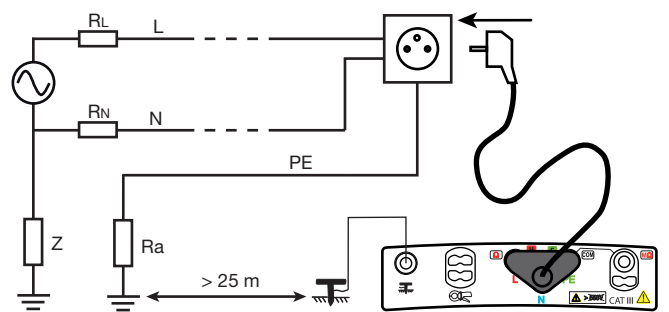

Case of a TN installation

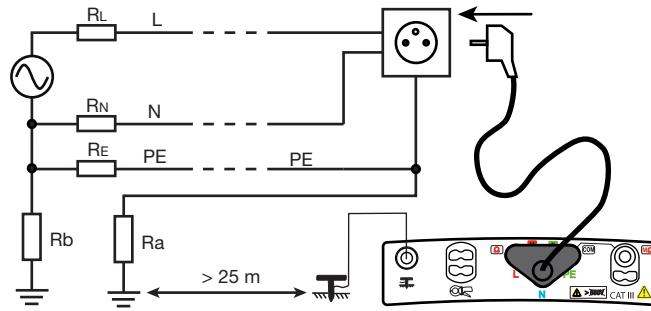

To make this measurement, you can choose:

- either a low current which avoids any untimely tripping out of the installation but gives only the earth resistance (RA).
- or a high current (TRIP mode), which yields a more accurate earth impedance (ZA) with good measurement stability. To avoid tripping out the installation, you can short-circuit the circuit-breaker during the measurement, as follows:

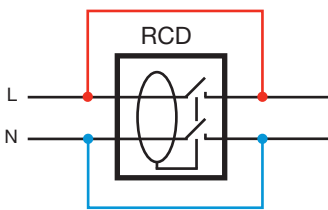

For the safety of the installation and of the users, you must not forget **to put the residual current device back in service** after the measurement.

The alarm, if activated, serves to report, by an audible signal, that the measurement is above threshold, making it unnecessary to look at the display unit to check this point.

Smoothing the signal, rather than making several measurements and calculating a mean, yields a stable measurement directly. But the measurement then takes longer.

Before starting the measurement, you can configure it by modifying the parameters displayed:



Choice of measurement current: 6, 9, 12 mA (default),

i: TRIP or TRIP to use a high current that will yield a more stable measurement.



To activate or deactivate the smoothing of the signal.



To compensate for the resistance of the measurement leads, for measurements of low values (see §3.14).



The device proposes choosing the voltage for the Ik calculation from among the following values:

- MEAS (the measured voltage value),
- the voltage of the old standard (for example 220 V),
- the voltage of the current standard (for example 230 V).

Depending on the voltage U_{LN} measured, the device proposes the following choices:

- if $170 < U_{LN} < 270$ V: MEAS (default), 220 V or 230 V.
- if $90 < U_{LN} < 150$ V: MEAS (default), 110 V or 127 V.
- if $300 < U_{LN} < 550$ V: MEAS (default), 380 V or 400 V.



To deactivate the alarm.

Z-R

To activate the alarm on Z_A (in TRIP mode) or on R_A (in non-tripping mode).

⊙ Ω 050.00

To set the alarm threshold (see §3.15). As default, the threshold is set to 50 Ω .

⊙ k Ω

Ik

To activate the alarm on I_k (in TRIP mode only).

⊙ A 010.00

To set the alarm threshold (see §3.15). As default, the threshold is set to 10 kA.

⊙ k A



Before the measurement: to display the measurements already recorded.

During or after the measurement: to record it.

The direction of the arrow indicates whether you can make a reading (arrow pointing out) or a recording (arrow pointing in).



Press the TEST button to start the measurement. The measurement stops automatically.



This symbol invites you to wait while the measurement is in progress.

3.7.3. READING OF THE RESULT

- In the case of a measurement with a high current (TRIP mode), without smoothing:

The screenshot shows a digital display with the following elements and labels:

- Top bar:** Date and time (02/20/2009 10:47), alarm bell icon, alarm threshold (50.0 Ω), frequency (50.1 Hz), and battery level icon.
- Left sidebar:**
 - UFk icon: Value of the alarm threshold.
 - Alarm bell with slash icon: Position of the phase on the socket outlet.
 - Wrench and screwdriver icon: Value of the short-circuit current.
 - 6% icon: Earth electrode fault voltage in the event of a short-circuit.
- Main display:**
 - I_k 468 A: Case where the measurement is above the alarm threshold.
 - U_{FK} 0.6 V: Use the \blacktriangleright key to see the rest of the display of the measurement.
 - \dots/\dots \blacktriangleright : Value of the reference voltage for the calculation of I_k .
 - \checkmark icon: The rod is connected.
- Bottom bar:**
 - EARTH 1P (Ra): Programmed maximum contact voltage.
 - $R_A \pm 0\%$: Compensation for the resistance of the measurement leads is activated.
 - $U_c 50V$: REF. Meas.

U_{FK} is calculated only in earth measurement on live circuit with a high current (TRIP mode). $U_{FK} = I_k \times Z_A$.



To see the next display page.



The screenshot shows a handheld device display with the following elements:

- Top status bar: 02/20/2009 10:47, 50.0 Ω, 50.1 Hz, and a battery icon.
- Left sidebar with icons: Ufk, a crossed-out symbol, a crossed-out symbol, and 6%.
- Main display area:
 - Z_A 25.10 Ω
 - R_a 24.8 Ω
 - L_a 5.6 mH
 - Navigation symbols: left arrow, $././$, right arrow, and a checkmark in a box.
- Bottom status bar: EARTH 1P (Ra), $R_{\Delta} \rightarrow 0 \leftarrow$, $U_{\Delta} 50^{\circ}$, a crossed-out symbol, and REF. Meas.

Value of the impedance.

Value of the resistance.

Value of the inductance.

Use the ► key to see the rest of the display of the measurement and the ► key to return to the previous page.

The third page is used to see the voltages U_{LN} , U_{LPE} , U_{NPE} and on the rod () before the measurement.

■ In the case of a measurement with a low current and smoothing, the first display screen is the following:

Value of the alarm threshold.

Position of the phase on the socket outlet.

Measurement result.

Case where the measurement is below the alarm threshold.

The ► key is used to access the next page to see the voltages before the beginning of the test.

Value of the reference voltage for the calculation of I_k .

The rod is connected.

Programmed maximum contact voltage.

Compensation for the resistance of the measurement leads is activated.

3.7.4. VALIDATION OF THE MEASUREMENT

Move the rod $\pm 10\%$ of the distance from the earth electrode and make two more measurements. The 3 measurement results must be the same to within a few percent. In this case the measurement is valid.

If this is not the case, it is because the rod is in the zone of influence of the earth electrode. You must then move the rod away from the earth electrode and redo the measurements.

3.8. SELECTIVE EARTH MEASUREMENT ON LIVE CIRCUIT

This function is used to make an earth measurement and to select one earth from among others, in parallel, and measure it. It requires the use of an optional current clamp.

3.8.1. DESCRIPTION OF THE MEASUREMENT PRINCIPLE

The device starts by making a loop measurement Z_S between L and PE (see §3.5) with a high current, and therefore with a risk of tripping out the installation. This high current must be used to ensure that the current flowing in the clamp is large enough to be measured. The device then measures the current flowing in the circuit surrounded by the clamp. Finally, it measures the potential of the PE conductor with respect to the auxiliary rod and from it deduces $R_{ASEL} = U_{PI-PE} / I_{SEL} \cdot I_{SEL}$ being the current measured by the clamp.

3.8.2. MAKING A MEASUREMENT

Set the switch to Z_S (R_A/SEL).

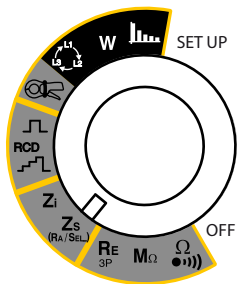

Connect the measuring cable to the device, then to the socket outlet of the installation to be tested.

At the time of connection, the device detects the positions of the phase (L) and of neutral (N) with respect to the protective conductor (PE) and displays them. If necessary, it then automatically switches the L and N terminals so that the measurement can be made without modifying the connections of the terminals of the device.



Plant the auxiliary rod at a distance of more than 25 metres from the earth electrode and connect it to the ⚡ ($R_A SEL$) terminal of the device. The ⚡ symbol is then displayed.

Connect the clamp to the device; the Ⓢ symbol is displayed. Then place it on the earth circuit to be measured.

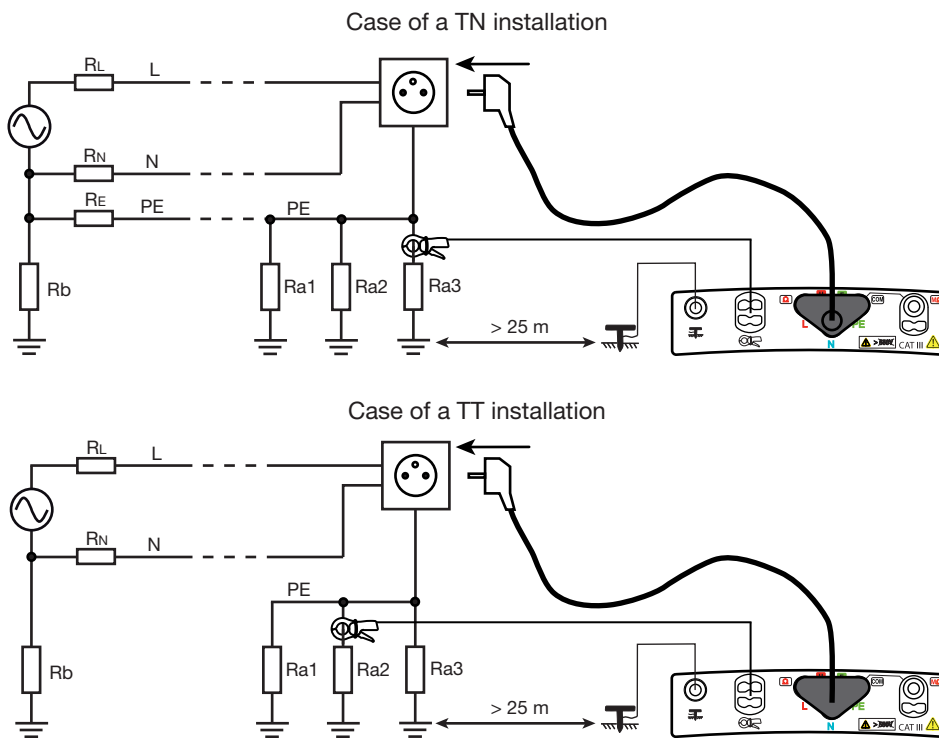

For greater accuracy, the measurement is made with a high current (TRIP mode). To avoid tripping out the circuit-breaker that protects the installation, you can short-circuit the circuit-breaker during the measurement, as follows:

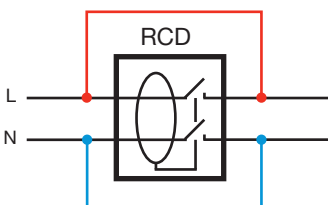

For the safety of the installation and of the users, you must not forget **to put the residual current device back in service** after the measurement.

The alarm, if activated, serves to report, by an audible signal, that the measurement is above threshold, making it unnecessary to look at the display unit to check this point.

Smoothing the signal, rather than making several measurements and calculating a mean, yields a right measurement directly. But the measurement then takes longer.

Before starting the measurement, you can configure it by modifying the parameters displayed:



The measurement current must be a high current (TRIP mode).
 U_{Fk} is calculated only in an earth measurement on live circuit with a high current (TRIP mode). $U_{Fk} = I_k \times Z_A$.



To activate or deactivate the smoothing of the signal.



To compensate for the resistance of the measurement leads, for measurements of low values (see §3.14). But the compensation is not useful for this measurement.



The device proposes choosing the voltage for the I_k calculation from among the following values:

- MEAS (the measured voltage value),
- the voltage of the old standard (for example 220 V),
- the voltage of the current standard (for example 230 V).

Depending on the voltage U_{LN} measured, the device proposes the following choices:

- if $170 < U_{LN} < 270$ V: MEAS (default), 220 V or 230 V.
- if $90 < U_{LN} < 150$ V: MEAS (default), 110 V or 127 V.
- if $300 < U_{LN} < 550$ V: MEAS (default), 380 V or 400 V.



To deactivate the alarm.

Z-R

To activate the alarm on R_{ASEL} .

Ω 050.00

To set the alarm threshold (see §3.15). As default, the threshold is set to 50 Ω .

k Ω

Ik

To activate the alarm on I_k (in TRIP mode only).

A 010.00

To set the alarm threshold (see §3.15). As default, the threshold is set to 10 kA.

k A



Before the measurement: to display the measurements already recorded.

During or after the measurement: to record it.

The direction of the arrow indicates whether you can make a reading (arrow pointing out) or a recording (arrow pointing in).



Press the TEST button to start the measurement. The measurement stops automatically.



This symbol invites you to wait while the measurement is in progress.

3.8.3. READING OF THE RESULT

Value of the alarm threshold.

Measurement result.

Value of the impedance.

Value of the resistance.

Value of the inductance.

Value of the short-circuit current.

Case where the measurement is above the alarm threshold.

The ► key is used to access the next page to see the voltages before the beginning of the test.

Value of the reference voltage for the calculation of I_k .

The rod is connected.

Programmed maximum contact voltage.

Compensation for the resistance of the measurement leads is activated.

The clamp is connected.

The second page is used to see the value of the voltages U_{LN} , U_{LPE} , U_{NPE} and on the rod () before the measurement.

3.8.4. ERROR REPORTING ((LOOP, EARTH ON LIVE CIRCUIT, AND SELECTIVE EARTH ON LIVE CIRCUIT))

The commonest errors in the case of a loop impedance measurement or earth measurement on live circuit are:

- A connection error.
- An earth rod resistance that is too high (>15 kΩ): reduce it by packing the earth around the rod and moistening it.
- A voltage on the protective conductor that is too high.
- A voltage on the rod that is high: move the rod out of the influence of the earth electrode.
- Tripping in the non-tripping mode: reduce the test current.
- A current measured by the clamp in selective earth on live circuit that is too low: the measurement is not possible.

ATTENTION : the user may be charged with static electricity, for example by walking on a carpet. In this case, when he/she presses the TEST button, the device displays the error message «earth potential too high». The user must then be discharged by touching an earth before making the measurement.



For help with connections or any other information, use the on-line help.

3.9. TEST OF RESIDUAL CURRENT DEVICE

The device can be used to perform three types of test on residual current devices (or switches):

- a tripping test in ramp mode,
- a tripping test in pulse mode,
- a non-tripping test.

The test in ramp mode serves to determine the exact RCD tripping current.

The test in pulse mode serves to determine the differential trip time.

The non-tripping test serves to check that the RCD does not trip out at a current of $0.5 I_{\Delta N}$. For the test to be valid, the leakage current must be negligible with respect to $0.5 I_{\Delta N}$ and, to ensure this, all loads connected to the installation protected by the RCD that is being tested must be disconnected.

3.9.1. DESCRIPTION OF THE MEASUREMENT PRINCIPLE

For each of the three types of test, the device starts by checking that the RCD can be tested without compromising the user's safety, i.e. without causing the fault voltage, U_F , to exceed 50 V (or 25 V or 65 V according to what is defined in the set-up for U_L). It therefore starts by generating a low current ($<0.4 I_{\Delta N}$) in order to measure Z_S , as it would for a loop impedance measurement.

It then calculates $U_F = Z_S \times I_{\Delta N}$ (or $U_F = Z_S \times 2 I_{\Delta N}$ depending on the type of test requested), which will be the voltage produced during the test. If this voltage is greater than U_L , the device does not perform the test. The user can then reduce the measurement current (to 0.2 or $0.3 I_{\Delta N}$) so that the test current + the leakage current present in the installation will not lead to a voltage greater than U_L .

For a more accurate measurement of the fault voltage, we recommend planting an auxiliary rod, as for earth measurements on live circuits. The device then measures R_A and calculates $U_F = R_A \times I_{\Delta N}$ (or $U_F = R_A \times 2 I_{\Delta N}$ depending on the type of test requested).

Once this first part of the measurement has been made, the device goes on to the second part, which depends on the type of test.

- For the ramp mode test, the device generates a sinusoidal current of which the amplitude increases gradually from 0.3 to $1.06 I_{\Delta N}$ between the L and PE terminals. When the RCD opens the circuit, the device displays the exact value of the tripping current and the trip time. This time is an indication and may differ from the trip time in pulse mode, which is closer to the operational reality.
- For the pulse mode test, the device generates a sinusoidal current at the mains frequency, having an amplitude of $I_{\Delta N}$, $2 I_{\Delta N}$ or $5 I_{\Delta N}$ between the L and PE terminals, lasting at most 500 ms. And it measures the time the circuit-breaker takes to open the circuit. This time must be less than 500 ms.
- For the non-tripping test, the device generates a current of $0.5 I_{\Delta N}$ for one or two seconds, depending on what the user has programmed. Normally, the circuit-breaker must not open the circuit.

In all cases, if the circuit-breaker does not trip out, the device then sends a current pulse between the L and N terminals. If the circuit opens, it means that the circuit-breaker was incorrectly installed (N and PE reversed).

3.9.2. PERFORMING A TEST IN RAMP MODE

Set the switch to RCD .

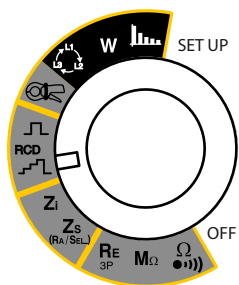

Connect the measuring cable to the device, then to a socket outlet included in the circuit protected by the circuit-breaker to be tested.

At the time of connection, the device detects the positions of the phase (L) and of neutral (N) with respect to the protective conductor (PE) and displays them. If necessary, it then automatically switches the L and N terminals so that the test can be done without modifying the connections of the terminals.

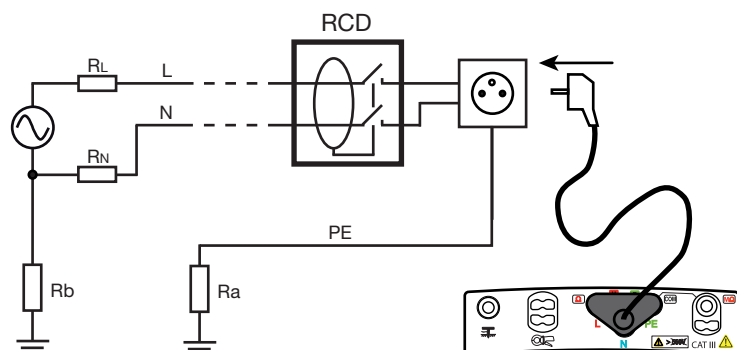

If possible, first disconnect all loads from the network on which you test the RCD. This prevents interference with the test by any leakage currents due to these loads.

If you have a current clamp, you can measure the leakage current (see §3.10) at the RCD and so make allowance for it during the test.

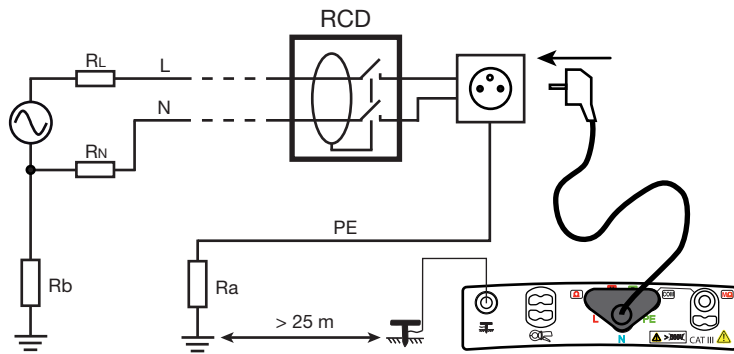

To make a more accurate measurement of the fault voltage, plant the auxiliary rod at a distance of more than 25 metres from the earth electrode and connect it to the $\overline{\text{RA SEL}}$ terminal of the device. The $\overline{\text{RA SEL}}$ symbol is then displayed.

Particular case:

To test a residual current device located downstream of another residual current device having a smaller nominal current, you must use the measuring cable terminated by 3 leads and make the connections shown opposite (upstream-downstream method).

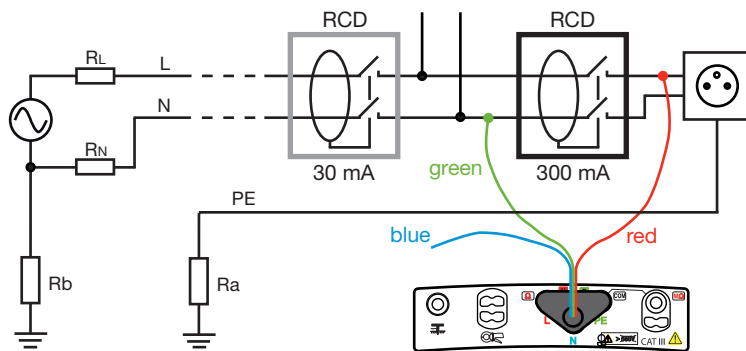

Before starting the measurement, you can configure it by modifying the parameters displayed:



- Choice of the nominal current of the residual current device I_{AN} : VAR. (variable: the user programs a value between 6 and 999 mA), 10 mA, 30 mA (default), 100 mA, 300 mA, 500 mA, 650 mA, or 1000 mA.



- Choice of type of residual current device: STD (standard), $\overline{\text{S}}$ or $\overline{\text{G}}$ (the S type is tested with a current of $2 I_{AN}$ as default).
- Choice of the form of the test signal:



signal that starts with a positive alternation,



signal that starts with a negative alternation,



signal containing only positive alternations,



signal containing only negative alternations.



To restore the factory adjustment parameters: $I_{AN} = 30 \text{ mA}$, STD and $\overline{\text{S}}$ types.



To choose a test current for the check of U_F : 0.0, 0.2, 0.3 (default), 0.4, or $0.5 I_{AN}$. For users who wish to test the circuit-breakers separately, the value - x -- is used in order not to measure Z_{L-PE} or calculate U_F .



To activate or deactivate the audible voltage alarm (the threshold being 50V). This function makes it possible to locate, on the distribution panel, using the audible signal, the circuit-breaker protecting a remote current socket outlet (typical case of a panel at a distance from the socket outlet) without being in the immediate vicinity of the device.



Before the measurement: to display the measurements already recorded.
During or after the measurement: to record it.

The direction of the arrow indicates whether you can make a reading (arrow pointing out) or a recording (arrow pointing in).



Press the TEST button to start the measurement. The measurement stops automatically.

In the case of type S or G circuit-breakers, the device counts 30 seconds between the prior test of UF and the test of the RCD itself, in order to allow its demagnetization. This wait can be cut short by pressing the TEST key again.



This symbol invites you to wait while the measurement is in progress.

3.9.3. READING OF THE RESULT

The screenshot shows the following data and features:

- Top status bar: 02/24/2009 10:47, 50.1 Hz, battery level icon.
- Left sidebar icons:
 - $I_{\Delta N}$ 30 mA
 - Measurement screen icon
 - Wrench and screwdriver icon
 - Measurement screen icon with 8%
- Main display area:
 - U_F 1.073 V
 - I_a 22.3 mA
 - T_a 13.8 ms
 - Checkmark icon
 - Navigation arrow icon
- Bottom status bar:
 - RCD: Ia
 - U_c 50V
 - STD button
 - Waveform icon

Annotations with red arrows:

- Position of the phase on the socket outlet. (points to a plug icon)
- $U_F = Z_S \times I_A$ or $R_A \times I_A$.
- Tripping current.
- Trip time.
- The measurement results are correct.
- The \blacktriangleright key is used to see the voltages before the beginning of the test.
- Type of signal.
- Type of circuit-breaker.
- Programmed maximum contact voltage.

3.9.4. MAKING A TEST IN PULSE MODE

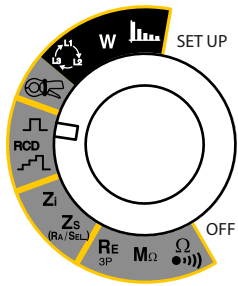

Set the switch to RCD .

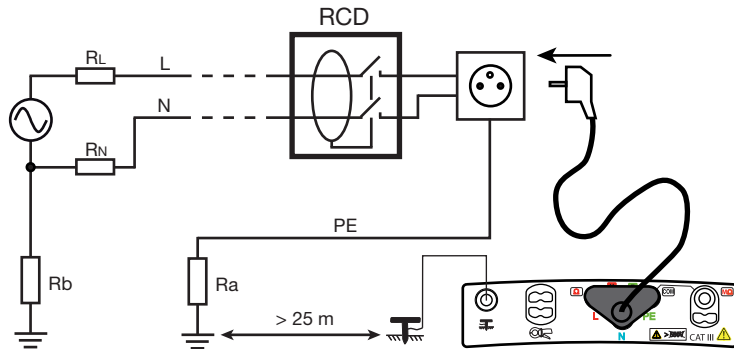
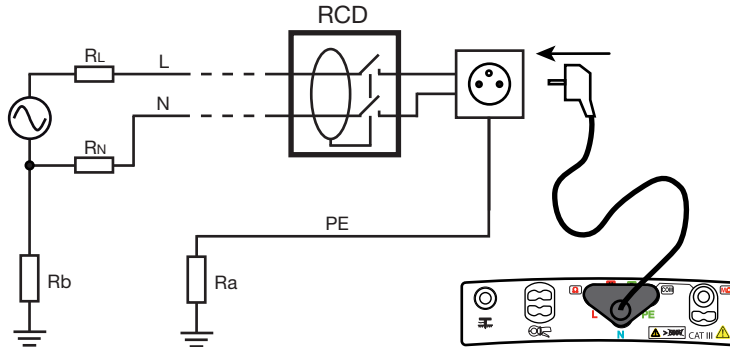

Connect the measuring cable to the device, then to a socket outlet included in the circuit protected by the circuit-breaker to be tested.

At the time of connection, the device detects the positions of the phase (L) and of neutral (N) with respect to the protective conductor (PE) and displays them. If necessary, it then automatically switches the L and N terminals so that the test can be made without modifying the connections of the terminals of the device.



For a more accurate measurement of the fault voltage, plant the auxiliary rod at a distance of more than 25 metres from the earth electrode and connect it to the  (RA SEL) terminal of the device. The  symbol is then displayed.

Particular case:

To test a residual current device located downstream of another residual current device having a smaller nominal current, you must use the measuring cable terminated by 3 leads and make the connections shown opposite (upstream-downstream method).

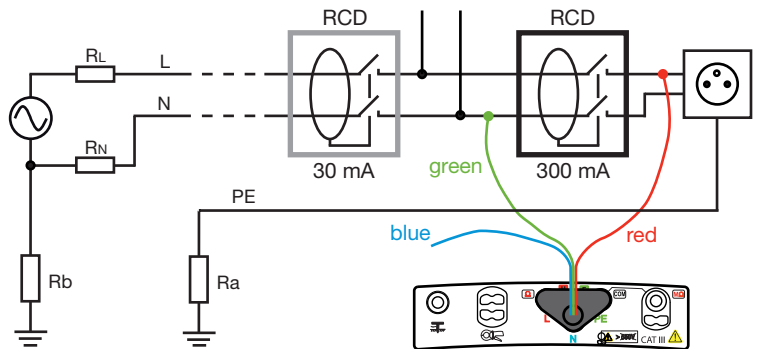

If it is active, the trip time alarm can be reported by an audible signal, so the user does not have to look at the display unit to know when a measurement is invalid.

A type S circuit-breaker is normally tested at $2 I_{\Delta N}$.

The tests at $0.5 I_{\Delta N}$ are made with the  waveform.

Before starting the measurement, you can configure it by modifying the parameters displayed:



Choice of the nominal current of the residual current device $I_{\Delta N}$: VAR. (variable: the user programs a value between 6 and 999 mA), 10 mA, 30 mA (default), 100 mA, 300 mA, 500 mA, 650 mA or 1,000 mA.



- Choice of type of residual current device: STD (standard), S or G (the S type is tested with a current of $2 I_{\Delta N}$ as default)
- Choice of pulse current: $I_{\Delta N} \times 1$, $I_{\Delta N} \times 2$, $I_{\Delta N} \times 5$, $0,5 I_{\Delta N} / 1s$ or $0,5 I_{\Delta N} / 2s$. The 2 values at $0,5 I_{\Delta N}$ are used to perform a non-tripping test.
- Choice of the form of the test signal:



signal that starts with a positive alternation,



signal that starts with a negative alternation,



signal containing only positive alternations,



signal containing only negative alternations.



To restore the factory adjustment parameters: $I_{\Delta N} = 30\text{mA}$, STD type circuit-breaker, pulse current =

$I_{\Delta N} \times 1$ and 



To choose a test current for the check of U_F : 0.0, 0.2, 0.3 (default), 0.4, or $0.5 I_{\Delta N}$.

For users who wish to test the circuit-breakers separately, the value - x -- is used in order not to measure Z_S or calculate U_F . This mode allows a faster test of the RCD.



To deactivate the alarm.

$T_A \text{ min}$

To program an alarm on the minimum trip time.

$T_A \text{ max}$

To program an alarm on the maximum trip time.

$T_A \text{ min}/T_A \text{ max}$

To program an alarm on the minimum trip time and on the maximum trip time (see §3.15).

The following tables indicate the default threshold values. They depend on the type of residual current device and on the test current.

Type of DDR	$T_A \text{ min (ms)}$		
Standard	0	0	0
S	150	60	50
G	10	10	10
I Test	$I_{\Delta N} \times 1$	$I_{\Delta N} \times 2$	$I_{\Delta N} \times 5$

Type of DDR	$T_A \text{ max (ms)}$		
Standard	300	150	40
S	500	200	150
G	300	150	40
I Test	$I_{\Delta N} \times 1$	$I_{\Delta N} \times 2$	$I_{\Delta N} \times 5$



Before the measurement: to display the measurements already recorded.

During or after the measurement: to record it.

The direction of the arrow indicates whether you can make a reading (arrow pointing out) or a recording (arrow pointing in).



Press the TEST button to start the measurement. The measurement stops automatically. In the case of type S or G circuit-breakers, the device counts 30 seconds between the prior test of U_F and the test of the RCD itself, in order to allow its demagnetization. This wait can be cut short by pressing the TEST key again.



This symbol invites you to wait while the measurement is in progress.

3.9.5. READING OF THE RESULT

- In the case of a test with tripping:

02/25/2009 10:47 200 ms 50.1 Hz

$I_{\Delta N}$ 30 mA

U_F 1.146 V

T_a 171.6 ms

8 %

RCD: T_a TRIP x2 50V

Value of the alarm threshold.

Position of the phase on the socket outlet.

$U_F = Z_S \times I_A$ or $R_A \times I_A$.

Trip time.

Case where: $T_{Amin} < T_A < T_{Amax}$.

The \blacktriangleright key is used to see the voltages before the beginning of the test.

Type of signal.

Type of circuit-breaker.

Programmed maximum contact voltage.

Pulse current as a multiple of $I_{\Delta N}$.

- In the case of a non-tripping test:

02/25/2009 10:47 50.1 Hz

$I_{\Delta N}$ 30 mA

U_F 0.146 V

T_a > 1.00 s

8 %

RCD: T_a NO TRIP | x0,5/1 | 50V | STD |

Position of the phase on the socket outlet.

$U_F = Z_S \times I_A$ or $R_A \times I_A$.

The circuit-breaker did not trip out during the duration of application of the current of $0.5 I_{\Delta N}$.

Case where: $T_{Amin} < T_A < T_{Amax}$.

The key is used to see the voltages before the beginning of the test.

Type of signal.

Type of circuit-breaker.

Programmed maximum contact voltage.

Non-tripping test lasting one second.

3.9.6. ERROR REPORTING

The commonest errors in the case of a test of a residual current device are:

- The circuit-breaker did not trip out during the test. Now, to ensure the safety of users, a circuit-breaker must trip out within 300 ms, or 200 ms for a type S. Check the wiring of the circuit-breaker. If it is OK, the circuit-breaker itself must be declared defective and replaced.
- The circuit-breaker trips out when it should not. The leakage currents are probably too high. First disconnect all loads from the network on which you are performing the test. Then perform a second test with the current reduced (in U_F check) as far as possible. If the problem persists, the circuit-breaker must be declared defective.



For help with connections or any other information, use the on-line help.

3.10. CURRENT MEASUREMENT

This measurement requires the use of an optional current clamp.

It can measure very low currents (of the order of a few mA) like fault currents or leakage currents, and high currents (of the order of a few hundred Amperes).



3.10.1. DESCRIPTION OF THE MEASUREMENT PRINCIPLE

Two of the four points of connection of the clamp serve to identify the type of clamp (x 1,000 or x 10,000) and the other two to measure the current. Knowing the ratio of the clamp, the device displays a direct reading of the current.

3.10.2. MAKING A MEASUREMENT

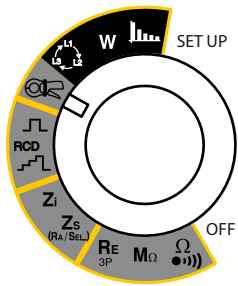
Set the switch to .



Connect the clamp to the  terminal on the device. The  symbol is then displayed. Actuate the trigger to open the clamp and encircle the conductor to be measured. Release the trigger.

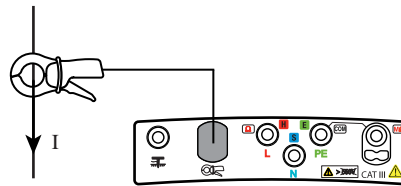

The current measurement can be made on different conductors of an installation. This is why it has been made possible to index the value recorded with one of the following values:

1, 2, 3, N, PE, or 3L (sum of the phase currents or phase and neutral currents, to measure the leakage current).

Before starting the measurement, you can program an alarm:



To deactivate the alarm.



To activate the alarm.

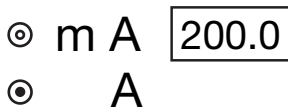

To set the alarm threshold (see §3.15). As default, the threshold is set to 200 A.



Before the measurement: to display the measurements already recorded.

During or after the measurement: to record it.

The direction of the arrow indicates whether you can make a reading (arrow pointing out) or a recording (arrow pointing in).



Press the TEST button once to start the measurement and a second time to stop it.

3.10.3. READING OF THE RESULT

02/26/2009 10:47 010.0 A 50.1 Hz

197.3 mA

Value of the alarm threshold.

Measurement result.

Case where the measurement is below the alarm threshold.

CURRENT The clamp is connected.

3.10.4. ERROR REPORTING

The commonest errors in the case of a current measurement are:

- The clamp is not connected.
- The current measured by the clamp is too low. Use a clamp having a lower ratio or pass the conductor through the clamp several times to increase the measured current.

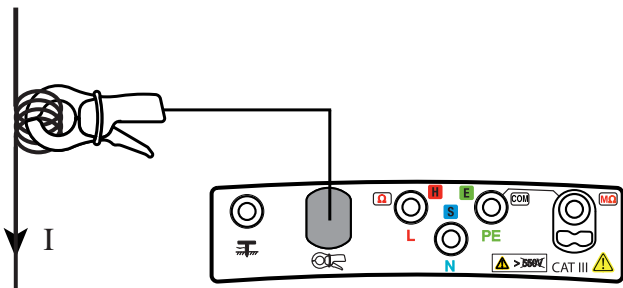

Here, the conductor passes through the clamp 4 times. You will have to divide the measured current by 4 to know the true value of I.

- The frequency is too unstable for the measurement. In this case connect a voltage between L and PE (for example the mains voltage). The device will then synchronize to the frequency of the voltage and will be able to measure the current at this same frequency.

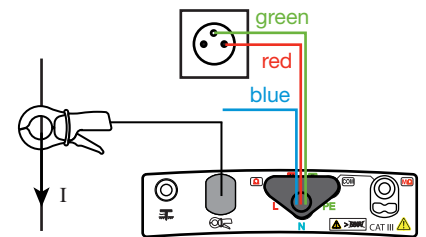

- The current measured by the clamp is too high. Use a clamp having a higher ratio.



For help with connections or any other information, use the on-line help.

3.11. DIRECTION OF PHASE ROTATION

This measurement is made on a three-phase network. It is used to check the phase order of the network.

3.11.1. DESCRIPTION OF THE MEASUREMENT PRINCIPLE

The device checks that the three signals are at the same frequency, then compares the phases to determine their order (direct or reverse direction).

3.11.2. MAKING A MEASUREMENT

Set the switch to .

Connect the measuring cable terminated by 3 leads to the device and to each of the phases: the red to L1, the blue to L2, and the green to L3.

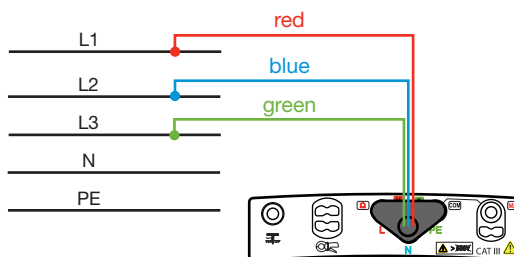
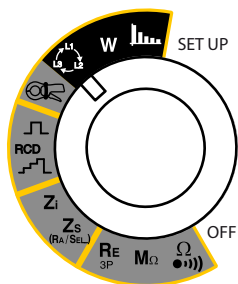

There are no parameters to program before starting the measurement.



Press the TEST button once to start the measurement and a second time to stop it.

3.11.3. READING OF THE RESULT

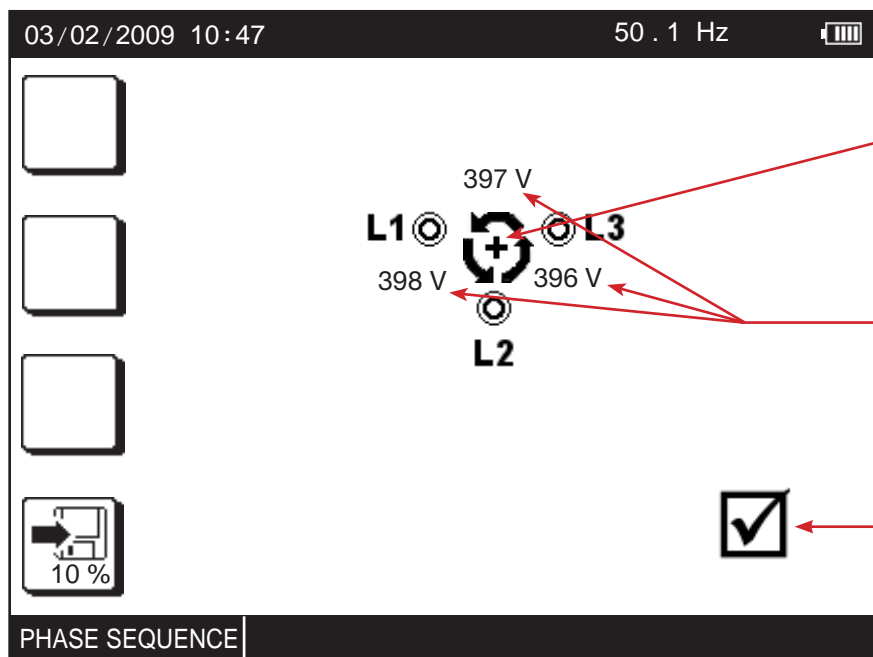

The + sign indicates a forward direction and the - sign a reverse direction.

Voltages between the phases.

The symbol indicates a forward direction and the symbol a reverse direction.



Before the measurement: to display the measurements already recorded.

After the measurement: to record it.

The direction of the arrow indicates whether you can make a reading (arrow pointing out) or a recording (arrow pointing in).

3.11.4. ERROR REPORTING

The commonest errors in the case of a test of direction of phase rotation are:

- One of the three voltages is outside the measurement range (connection error).
- The frequency is outside the measurement range.



For help with connections or any other information, use the on-line help.

3.12. POWER MEASUREMENT

This measurement requires the use of an optional current clamp. It can be made on a single-phase network or on a three-phase network that is balanced in voltage and in current. It requires the use of the C177A clamp (optional).

3.12.1. DESCRIPTION OF THE MEASUREMENT PRINCIPLE

For a single-phase network, the device measures the voltage between the L and PE terminals, then multiplies it by the current measured by the clamp.

For a three-phase network balanced in voltage and in current, the device measures one of the three phase-to-phase voltages, multiplies it by the opposite phase current, then multiplies the result by $\sqrt{3}$. Example: $P_{3\phi} = U_{12} \times I_3 \times \sqrt{3}$

3.12.2. MAKING A MEASUREMENT

Set the switch to **W**.

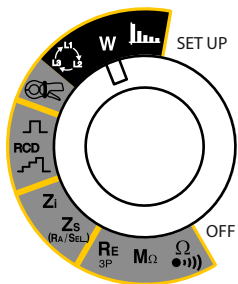

In the case of a single-phase network, connect the measuring cable terminated by 3 leads to the device and to a socket outlet of the installation to be tested, using the red and green leads. Clamp either the phase, to obtain the total power, or one of the loads, to obtain the partial power.

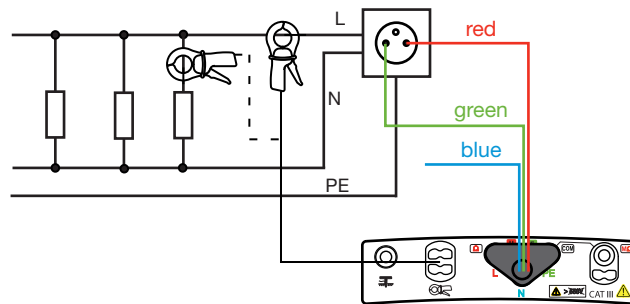

In the case of a three-phase network balanced in voltage and in current, connect the measuring cable terminated by 3 leads to the device and to two of the three voltages U_{12} , U_{23} or U_{31} using the red and green leads. Then connect the clamp to measure the current on the opposite phase I_3 (for U_{12}), I_1 (for U_{23}) or I_2 (for U_{31}).

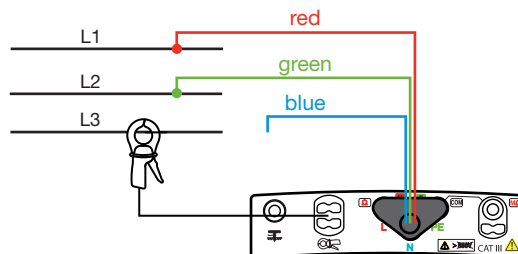

The power measurement can be made on different phases of an installation. This is why it has been made possible to index the recorded power value with one of the following values: 1, 2, or 3 (single-phase measurements on a three-phase network).

Before starting the measurement, you can configure it by modifying the parameters displayed:



Choice of type of network: single-phase or balanced three-phase.



Before the measurement: to display the measurements already recorded.
During or after the measurement: to record it.
The direction of the arrow indicates whether you can make a reading (arrow pointing out) or a recording (arrow pointing in).



Press the TEST button once to start the measurement and a second time to stop it.

3.12.3. READING OF THE RESULT

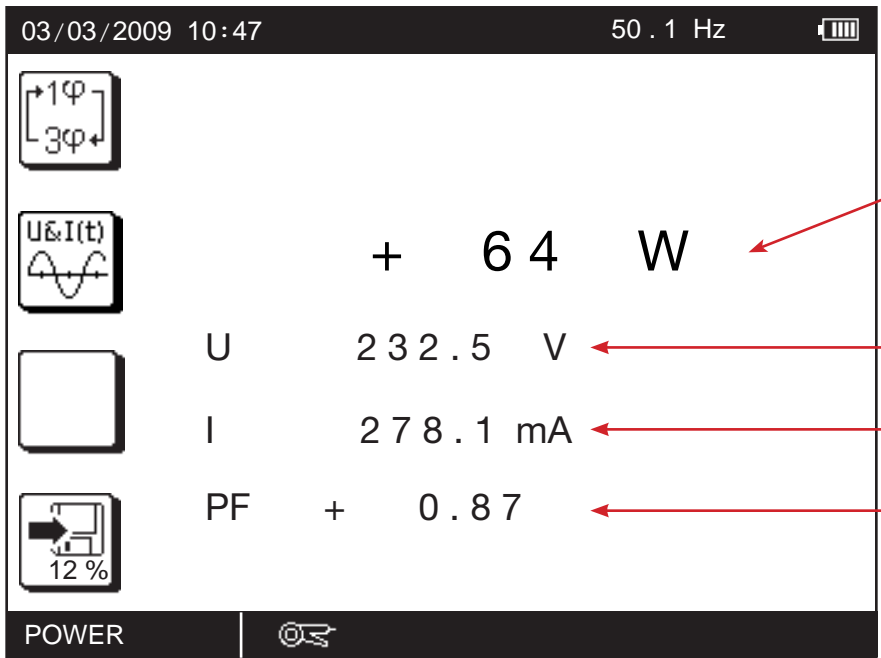

Measurement result.
The + sign indicates power consumed. The - sign indicates power returned.

Voltage between the L and PE terminals.

Current measured by the clamp.

Power factor.
The + sign indicates that the load is resistive or inductive. The - sign indicates that the load is capacitive.

The clamp is connected.

If the phase of the current with respect to the voltage is not correct, turn the clamp around, with the help of the arrow marked on the jaws, in order to reverse the phase by 180°.



Press this function key to display the voltage and current curves, as on an oscilloscope. If the clamp is not connected, only the voltage curve is displayed. The current curve cannot be displayed alone.

The representation of the curves is normalized:

- in amplitude, the curves are automatically adjusted to fill the screen.
- on the time scale, approximately one period is shown.

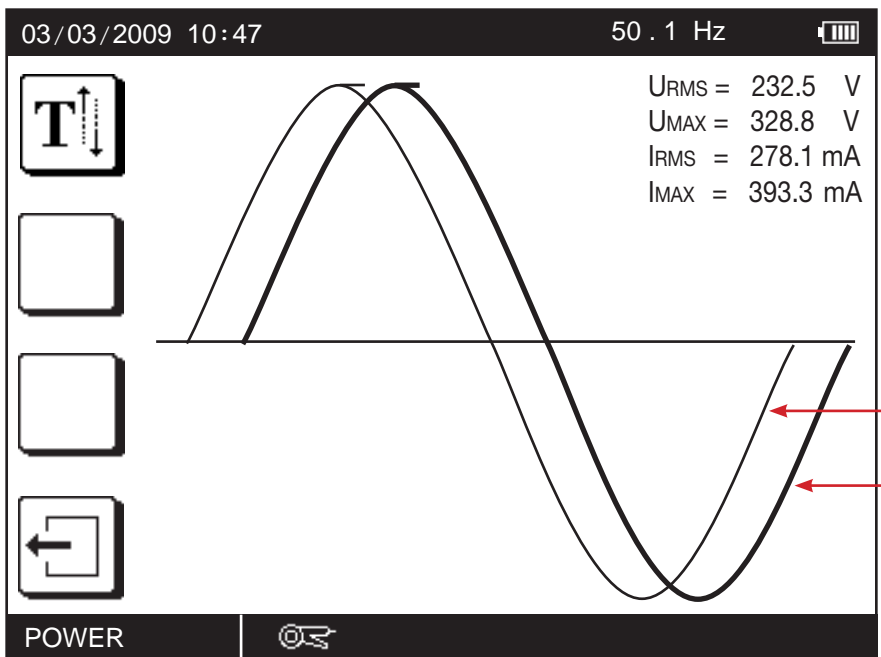

Numerical values.

Voltage curve.

Current curve (thicker line).



To move the text if it masks part of the curves.

3.12.4. ERROR REPORTING

The commonest errors in the case of a power measurement are:

- The voltage is outside the measurement range.
- The frequency is outside the measurement range.
- The current is too low to be measured.
- The power measured is negative. Check that the clamp is correctly placed on the cable (look at the direction of the arrow). If it is, what you are measuring is power returned (from receiver to generator).



For help with connections or any other information, use the on-line help.

3.13. HARMONICS

This function is used to display the harmonic analysis of a voltage or current of which the signal is steady-state or quasi-steady-state. It is used to establish a first diagnostic of the harmonic pollution of an installation.

The current analysis requires the use of the C177A current clamp (optional).

3.13.1. DESCRIPTION OF THE MEASUREMENT PRINCIPLE

The device measures the voltage and, if the clamp is connected, the current. Then, depending on what the user has chosen (FFT U or FFT I), it performs an FFT limited to the first 50 harmonics either of the voltage or of the current. Harmonic 0 (the DC component) is not displayed.

3.13.2. MAKING A MEASUREMENT

Set the switch to .

Connect the measuring cable terminated by 3 leads to the device and to a socket outlet of the installation to be tested, using the red and green leads.
Or connect the C177A clamp to the device and encircle the phase.

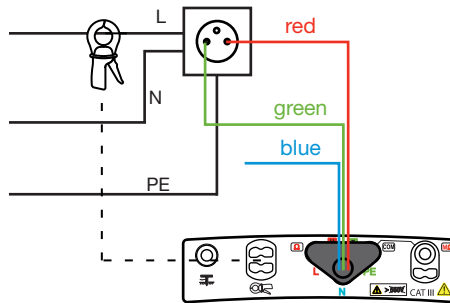
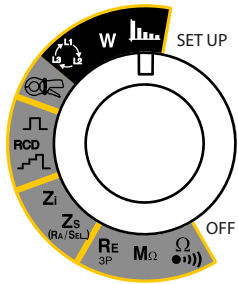

Before starting the measurement, you can configure it by modifying the parameters displayed:



To choose to perform an FFT on the voltage (U) or on the current (I).



To choose the display format for the FFT:



linear scale,



logarithmic scale,



result in the form of an alphanumeric list.



Choice of calculation of the level of distortion with respect to the fundamental (THD-F) or of the distortion factor with respect to the RMS amplitude (THD-R or DF).



Before the measurement: to display the measurements already recorded.

During or after the measurement: to record it.

The direction of the arrow indicates whether you can make a reading (arrow pointing out) or a recording (arrow pointing in).



Press the TEST button once to start the measurement and a second time to stop it.

3.13.3. READING OF THE RESULT

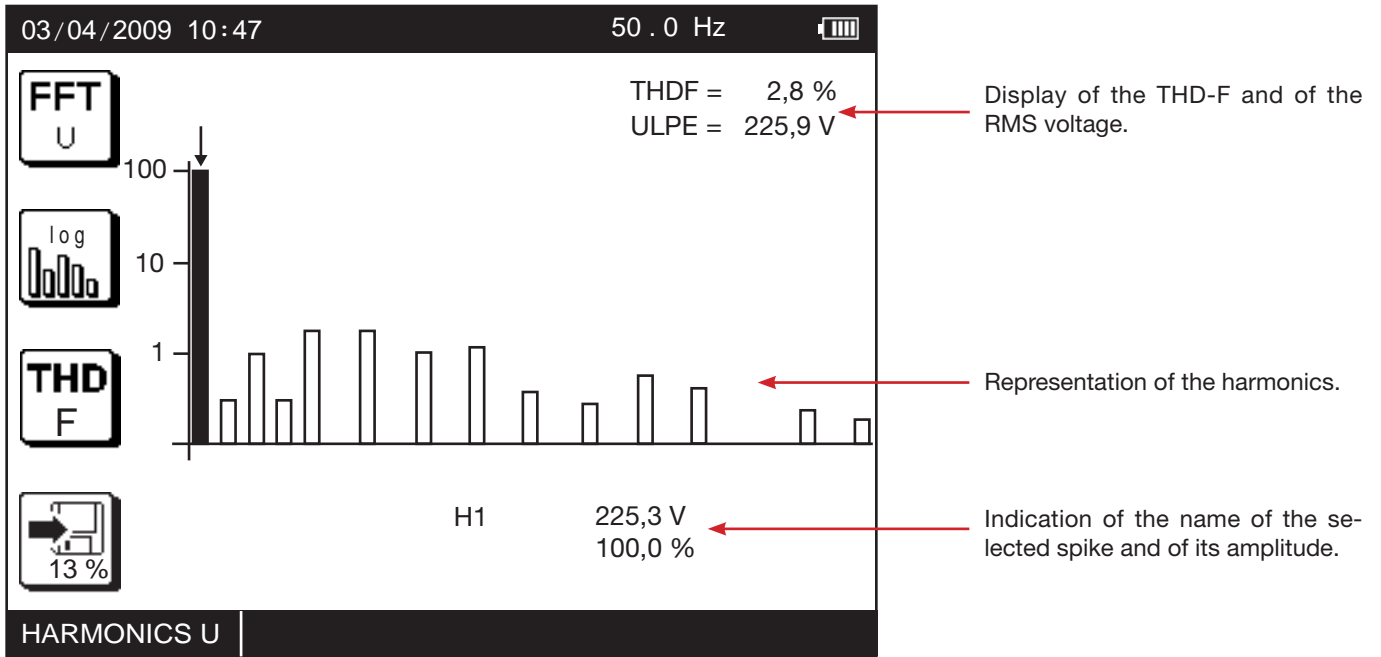

The frequency and amplitude of the selected harmonic (in black) are indicated at the bottom of the graph. To select another harmonic, use the ◀▶ keys. The device then shifts from the fundamental (H1) to harmonic H2, then to harmonics (H3, H4, ..., H25). And on the next page it sweeps the harmonics from H26 to H50.

Frequency F1 is displayed on the top strip of the display unit.
 The frequency of harmonic Hn is n x F1.

The display in list form gives the following screen:

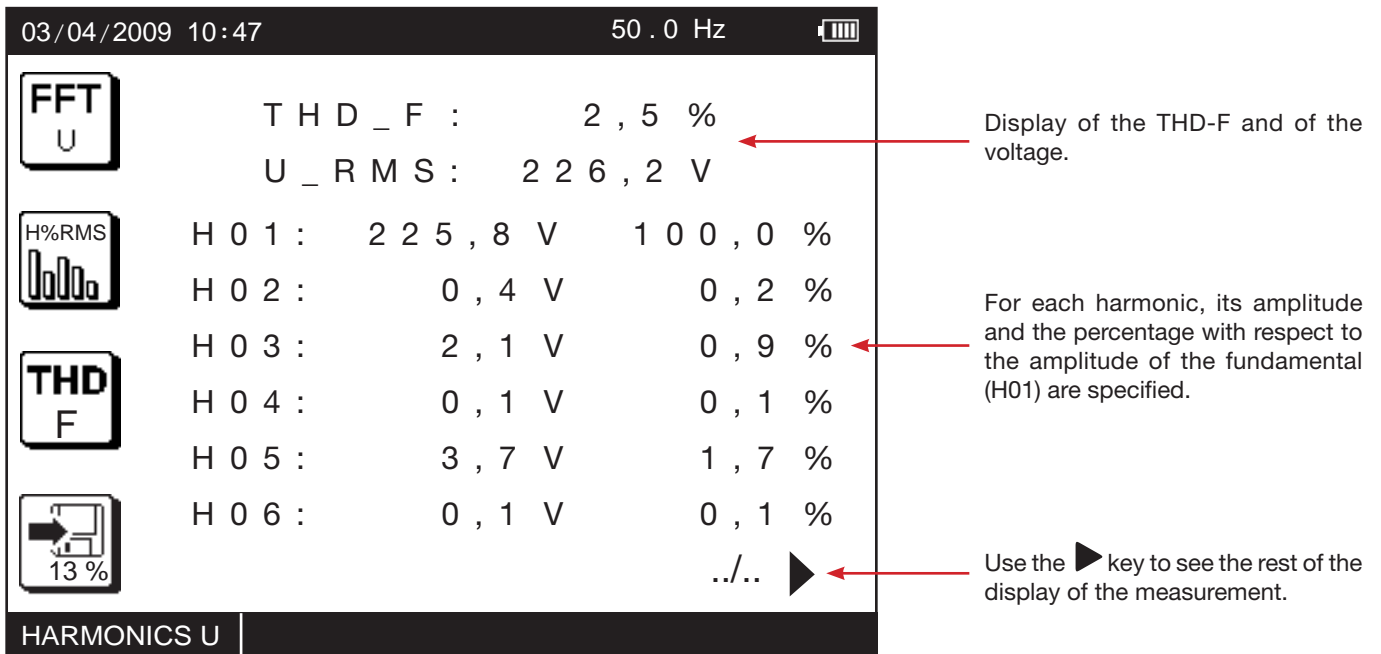

You must scroll through 6 other screens using the ▶ key to display the values of all 50 harmonics.

3.13.4. ERROR REPORTING

The commonest errors in the case of an analysis of a signal into harmonics are:

- The voltage is outside the measurement range.
- The frequency is outside the measurement range.
- The current is too low to be measured.
- The signal is not steady-state.



For help with connections or any other information, use the on-line help.

3.14. COMPENSATION FOR THE RESISTANCE OF THE MEASUREMENT LEADS

Compensation for the resistance of the measurement leads serves to neutralize their values and obtain a more accurate measurement when the resistance to be measured is low.

The device measures the resistance of the accessories (leads, probe tips, alligator clips, etc.) and subtracts this value from the measurements before displaying them.

Compensation for the resistance of the measurement leads is possible in continuity, 3P earth, and loop tests. It is different for each of these functions. It must be renewed at each change of accessories.



Start by pressing the key to enter the function.

3.14.1. IN CONTINUITY

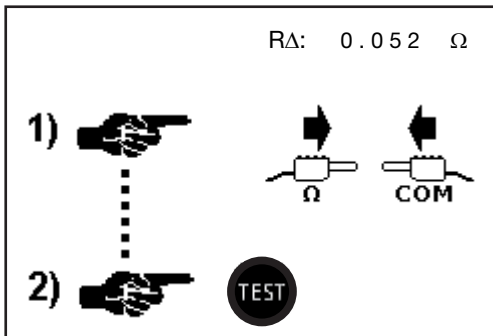

The current value of the compensation is displayed at top right. A value of zero indicates that no compensation has been determined.

Connect the two leads that you are going to use for the measurement to the Ω and COM terminals, short-circuit them, then press the TEST key.

The device measures the resistance of the leads and displays it. Press OK to validate or to keep the old value.

The R_{Δ} symbol, present on the bottom strip of the display unit, reminds you that the resistance of the leads is compensated.

3.14.2. IN 3P EARTH

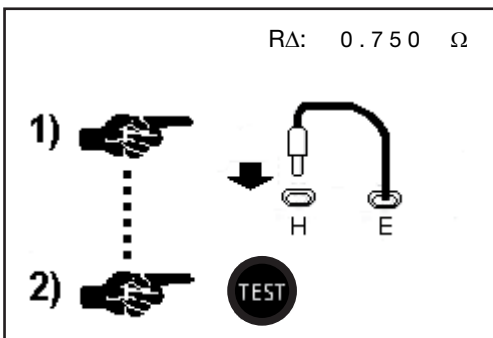

The current value of the compensation is displayed at top right. A value of zero indicates that no compensation has been determined.

Connect the lead that you are going to use to connect the E terminal to the earth between the H and E terminals, then press the TEST key.

The device measures the lead and displays its value. Press OK to validate or to keep the old value.

The R_{Δ} symbol, present on the bottom strip of the display unit, reminds you that the resistance of the leads is compensated.

3.14.3. IN LOOP (Z_s OR Z_l)

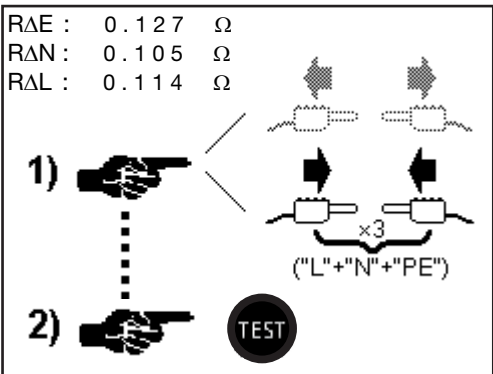

The current values of the compensations are displayed at top right. If the values are zero, no compensation has been determined.

Connect the three leads that you are going to use for the measurement to the L, N, and PE terminals, short-circuit them, then press the TEST key.

The device measures each of the three leads and displays their values. Press OK to validate or to keep the old value.

The R_{Δ} symbol, present on the bottom strip of the display unit, reminds you that the resistance of the leads is compensated.

3.14.4. ELIMINATING THE COMPENSATION

Proceed as for compensation, but rather than short-circuiting the leads, leave them disconnected. Then press the TEST key. The device removes the compensation, then returns to voltage measurement. The R_{Δ} symbol disappears from the display unit and the  icon is crossed out.

3.14.5. ERROR

- If the resistance of the measurement leads is too high (>2.5 Ω per lead), compensation is impossible. Check the connections and any junctions and leads that might be open-circuit.
- If, during a continuity, 3P earth, or loop impedance measurement, you obtain a negative measurement result, you must have changed the accessories without redoing the compensation. In this case, perform a compensation with the accessories you are now using.

3.15. ADJUSTMENT OF THE ALARM THRESHOLD

The device makes an audible signal:

- in continuity, resistance and insulation measurement, if the measurement is below threshold;
- in earth and loop measurement, if the measurement is above threshold;
- in test of residual current device, if the measurement is not between the two thresholds (Tmin and Tmax).

In continuity measurement, the audible signal is used to validate the measurement. In all the others functions, it reports an error.

The alarm threshold is adjusted in essentially the same way for all measurements.

Start by entering the alarm function by pressing the  or  key.

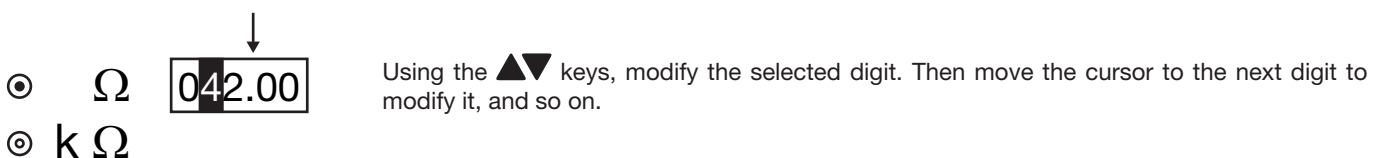
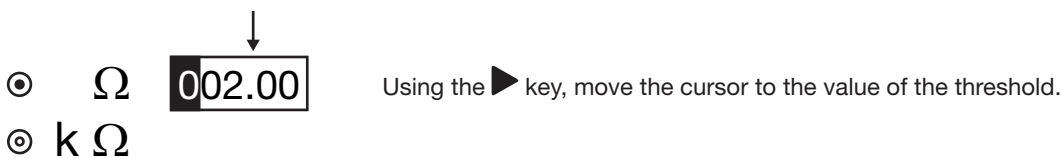
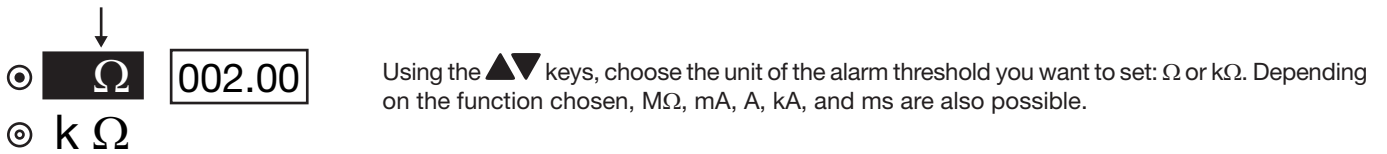
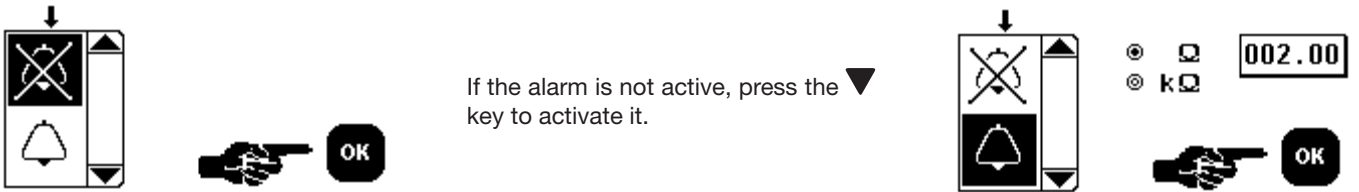



To validate the modified threshold, press the OK key.

To abort without saving, press the  key or turn the switch.

4. ERROR REPORTING

Generally, errors are reported in clear language on screen.

Example of error screen:

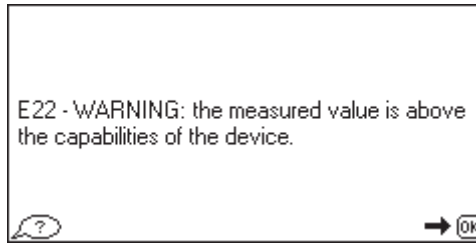

Press the OK key to erase the message.



Or press the help key for help in solving your problem.

The following screen is then displayed.

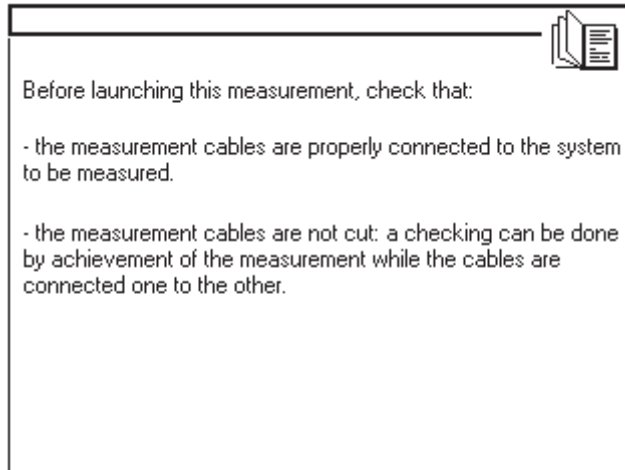

or



Press the OK key or the help key to erase the help screen.

4.1. NO CONNECTION



One or more terminals are not connected.

4.2. OUT OF MEASUREMENT RANGE

$> 40.0 \Omega$
 $< 5.0 V$

The value is outside the measurement range of the device. The minimum and maximum values depend on the function.

4.3. PRESENCE OF DANGEROUS VOLTAGE



The voltage is regarded as dangerous from 25, 50, or 65V, depending on the value of UL programmed in SET-UP. For measurements made without voltage (continuity, insulation, and 3P earth), if the device detects a voltage, it

disables starting of the measurement by the pressing of the TEST button and displays an explanatory error message.

For measurements that are made on live circuits, the device detects the absence of voltage, the absence of a protective conductor, a frequency or voltage outside the measurement range. The device then disables starting of the measurement by the pressing of the TEST button and displays an explanatory error message

4.4. INVALID MEASUREMENT



If the device detects an error in the measurement configuration or in the connection, it displays this symbol and a corresponding error message.

4.5. DEVICE TOO HOT

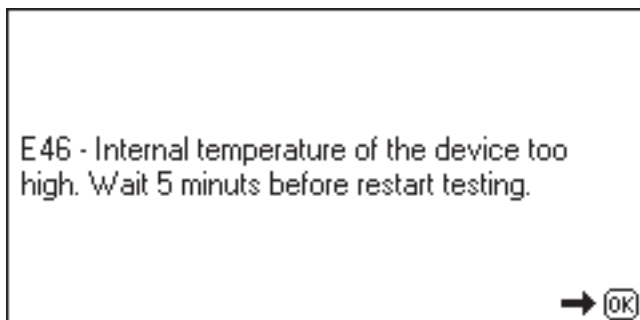

The internal temperature of the device is too high. Wait for the device to cool off before making another measurement. This case concerns essentially the test of residual current devices.

4.6. CHECK OF INTERNAL PROTECTION DEVICES

The device includes two internal protection devices that cannot be reset and that the user cannot replace. These devices act only under extreme conditions (e.g. a lightning strike).

To check the condition of these protections:

Set the switch to Z_s (R_A/SEL.).

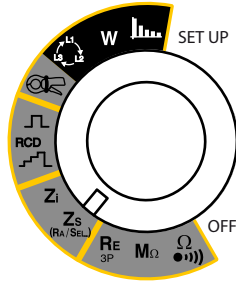

Disconnect the input terminals.

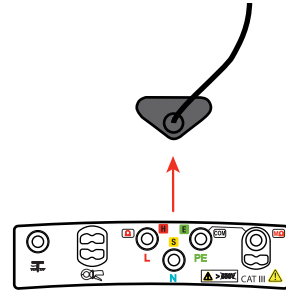

If the internal protection devices are intact, the display should indicate:

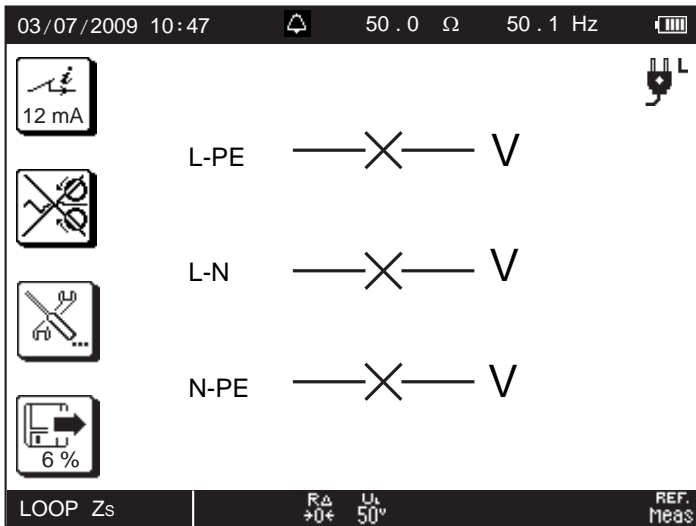

If U_{L-PE} does not display - x --, the protection in the L terminal has been activated.

If U_{N-PE} does not display - x --, the protection in the N terminal has been activated.

Case where both protections have been activated.

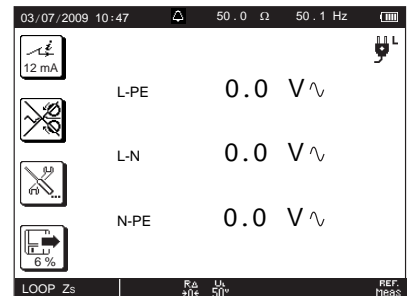
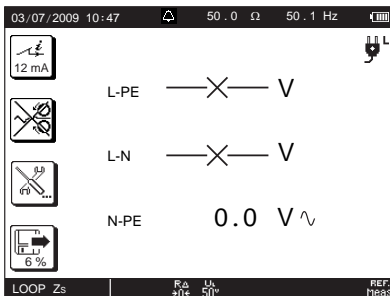
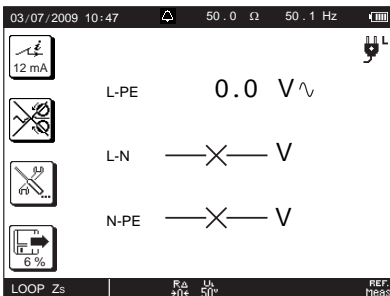

In these last three cases, the device must be sent in for repair (see §10.5).

5. SET-UP

Set the switch to SET-UP.

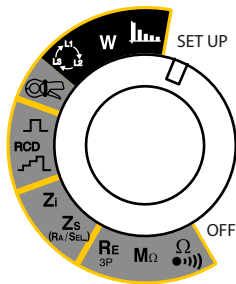

Use the directional keypad to select an icon, select a field, and modify it.

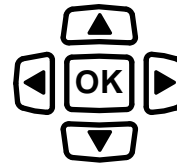

Used to exit from the current screen.



Used to display all parameters of the device:

- the software version (internal to the device),
- the hardware version (of the internal boards and components of the device),
- the date format,
- the time format,
- activation of the audible signal,
- the serial number,

.. \.. ► next page

- the duration of lighting of the backlighting,
- the duration of operation of the device before automatic switching off,
- the language.



To set the date and time and choose the format.



To activate or deactivate the audible signal.



To set the contact voltage to 25 V, 50 V (default), or 65 V.

- 50 V is the standard voltage (default).
- 25 V should be used for measurements in a damp environment.
- 65 V is the default voltage in some countries (Austria, for example).



Adjustment of the time to automatic switching off of the backlighting: 1 min, 2 min (default), 5 min, or 10 min.

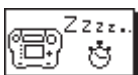

Adjustment of the time to automatic switching off of the device: 5 min (default), 10 min, 30 min, or ∞ (permanent operation).



Used to access the memory to:

- read the measurements already made,
- or prepare a tree before a measurement campaign.

See storage in §6.



To erase all of the memory.

The device requests confirmation before erasing all memory (formatting the memory).



To return to the factory configuration (compensation for resistance of measurement leads + all adjustable parameters in the various measurements). The device requests confirmation before executing.



To choose the language.

6. MEMORY FUNCTION

6.1. ORGANIZATION OF THE MEMORY AND NAVIGATION

The device has 4000 memory locations to record measurements. They are organized in a tree on three levels, as follows:

- ☐ SITE 1
 - ☐ ROOM 1
 - OBJECT 1
 - OBJECT 2
 - ☐ ROOM 2
 - OBJECT 1
- ☐ SITE 2
 - ☐ ROOM 1
 - ...

Navigation in the tree is done using the directional keypad. The titles of the SITES, ROOMS, and OBJECTS can be parameterized by the user.

If a SITE or ROOM is preceded by the ☐ sign, it means that this level has sub-levels that can be expanded using the ► key or the OK key. The ☐ sign is then replaced by the ☐ sign.

To compress the tree (change from the ☐ sign to the ☐ sign), use the ◀ or OK key.

Measurements are always recorded on an OBJECT. In the OBJECT, measurements are classified by TYPE OF TEST (continuity, insulation, loop, etc.). Each OBJECT can contain up to nine TESTS belonging to the same TYPE OF TEST. Each TEST corresponds to one measurement.

To see the tests contained in an OBJECT, go to the OBJECT and press the OK key.

A status symbol displayed to the right of the OBJECTS, of the TYPE OF TEST, and of the TEST indicates:

- ☐ that the OBJECT has not yet been tested,
- ☑ that all TESTS of the OBJECT are OK,
- ☒ that at least one TEST of the OBJECT is not OK.

6.2. ENTERING THE STORAGE FUNCTION

When a measurement is over, the device proposes recording it by displaying the recording icon (arrow pointing in) at bottom left of the measurement results:



The percentage indicates the level of occupancy of the memory.

If you want to record the measurement you have just made, press the key alongside the record icon.

Remark: For a measurement to be «recordable», the TEST button must have been pressed. It is not possible to record voltage measurements alone.

The device displays the following message:

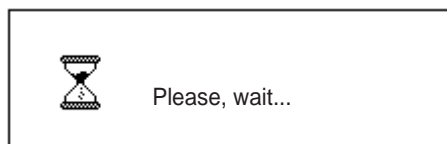

The following screen then appears:

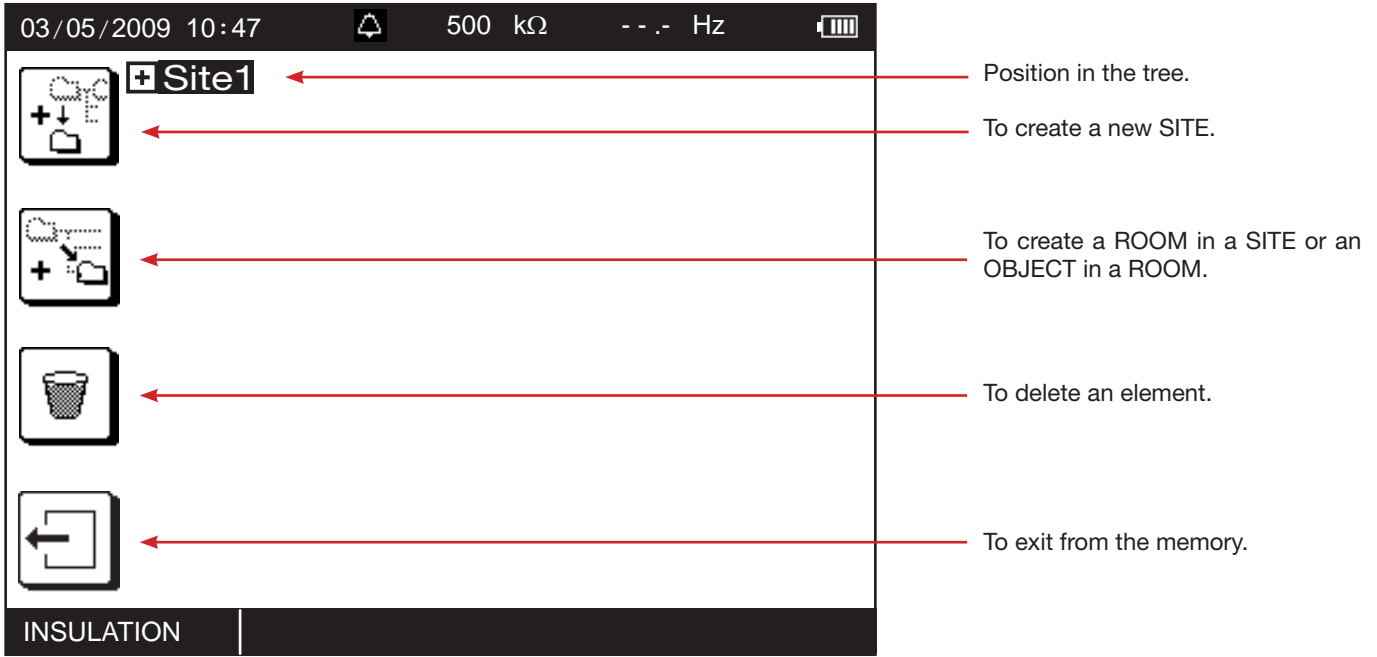

6.3. CREATE A TREE

As default, the device proposes the beginning of a tree (SITE1, ROOM1, OBJECT1). If you do not want to create a tree, this lets you record all of your measurements in OBJECT1.

To expand the tree, use the key or the OK key.

To create a new SITE, press the key.

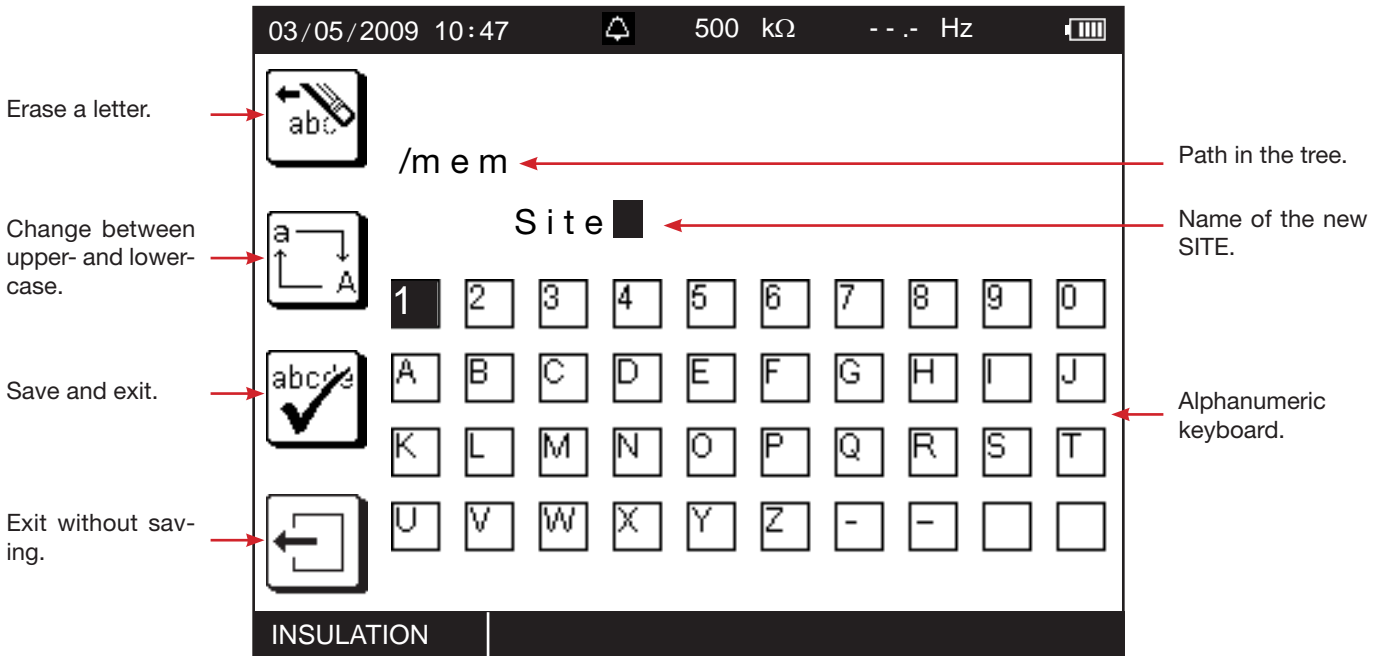

You can then rename the SITE. Start by erasing the existing text. Then move about on the keyboard using the directional keypad () and validate each letter by pressing the OK key.

A sustained press on one of the keys speeds up the scrolling



To add a ROOM to a SITE, place the cursor on the chosen SITE and press the  key. Give the ROOM a name and validate it. Then press the key again to create an OBJECT in the ROOM. This results in the following tree:

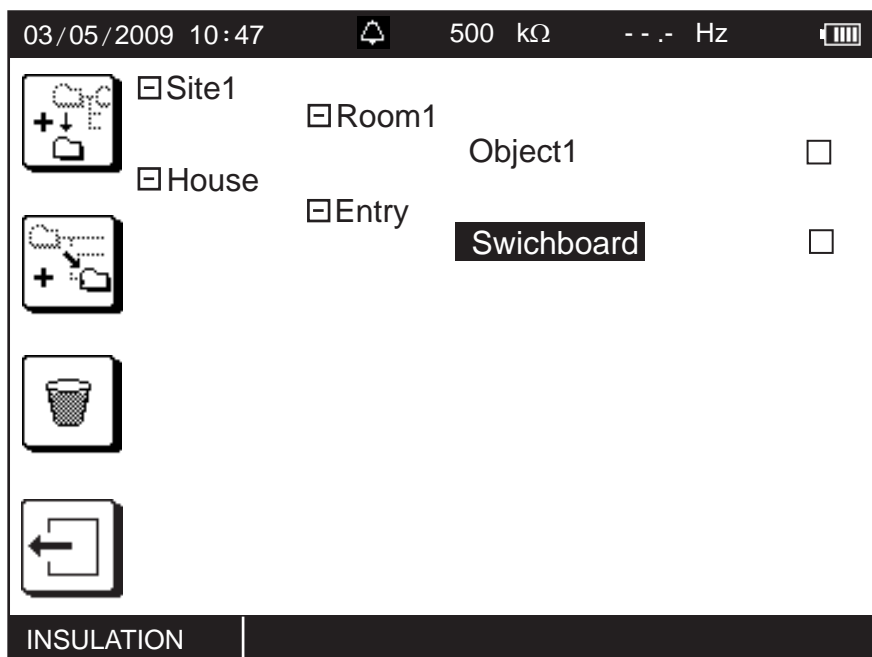

To avoid losing time when you are making the measurements, you can prepare your tree in advance.

6.4. RECORD THE MEASUREMENT

To record the measurement, place the cursor on the desired OBJECT and press the OK key.

For insulation, loop impedance, line impedance, current, and power measurements and the harmonic analysis, the device proposes indexing your measurement, because several measurements are possible.

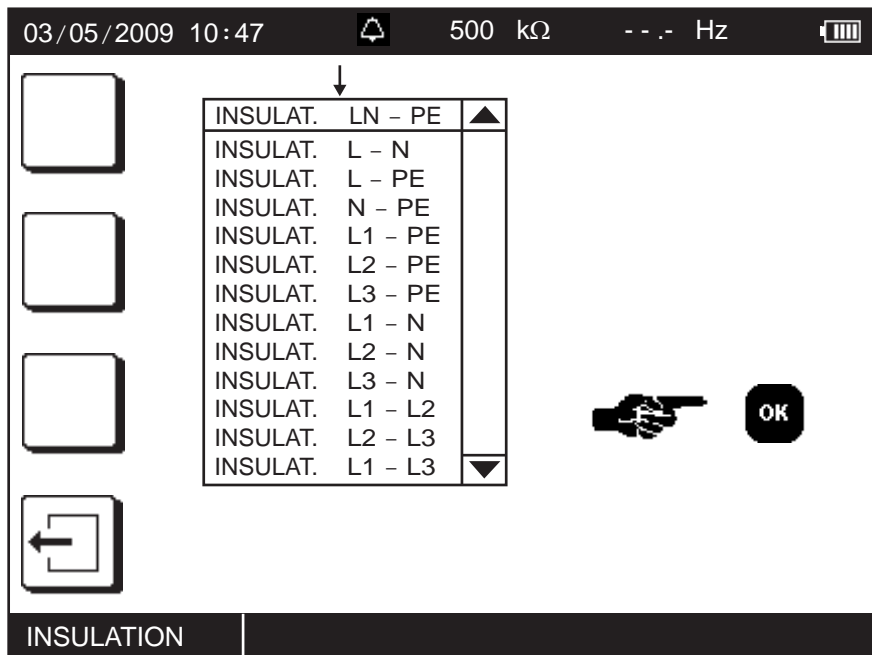

Using the ▲▼ arrows, select the type of insulation measurement you have just made and validate by pressing the OK key.

You can in this way make several insulation measurements on the electrical panel. And then move on to another type of measurement, still on the electrical panel, for example a loop impedance measurement.

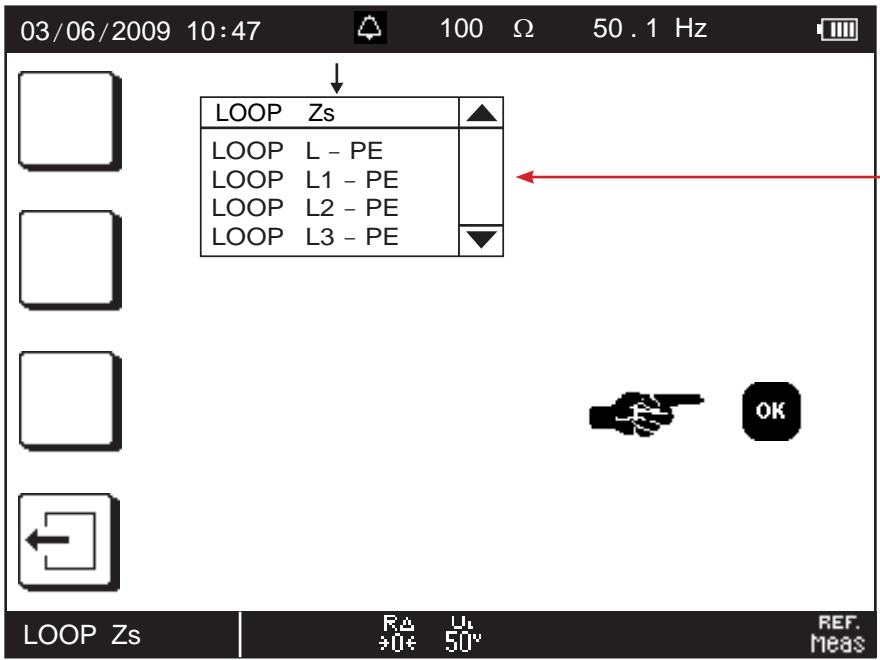

As in the case of insulation, you can index the measurement.

6.5. READ THE RECORDS



You can read the measurement made by pressing the  key. The device then displays the tree again. The last OBJECT on which a measurement has been recorded is selected.

To change levels in the tree, use the ◀ and ▶ keys.

To move on the same level (from SITE to SITE, ROOM to ROOM, or OBJECT to OBJECT), use the ▲▼ keys.

To see all of the measurements made on the selected OBJECT, press the OK key.

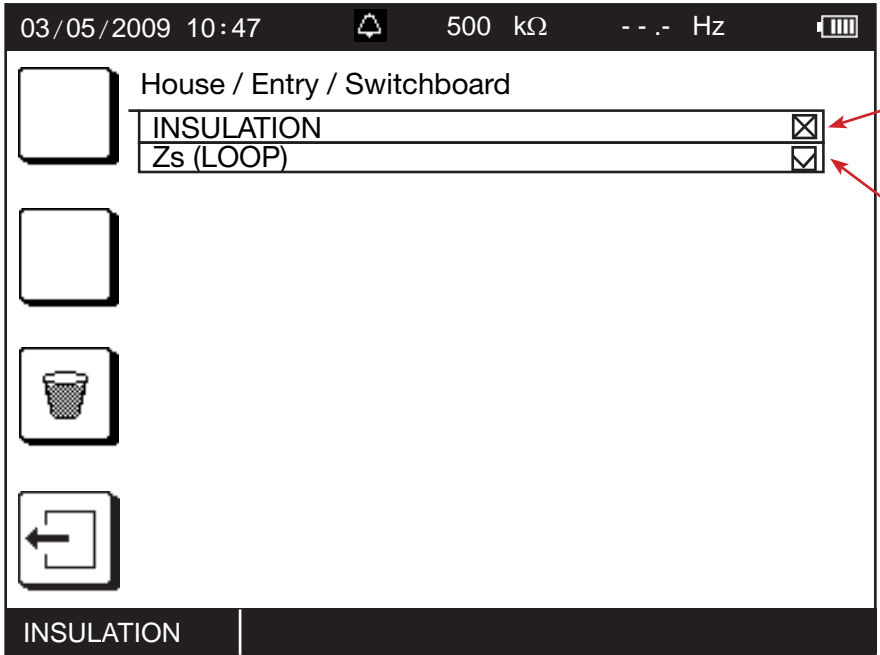

Insulation resistance measurements have been made on this OBJECT and at least one of them is not OK.

Loop impedance measurements have been made on this OBJECT and they are all OK.

Press the OK key to expand a TYPE OF TEST.

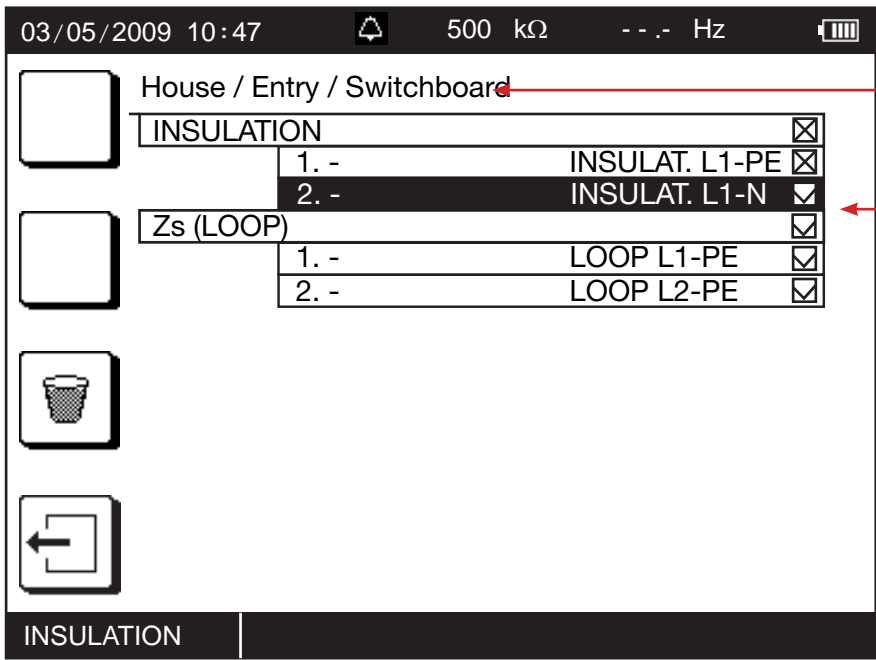

Path in the tree.

List of tests performed in the Panel OBJECT.



Press the OK key again to see the recorded measurement.

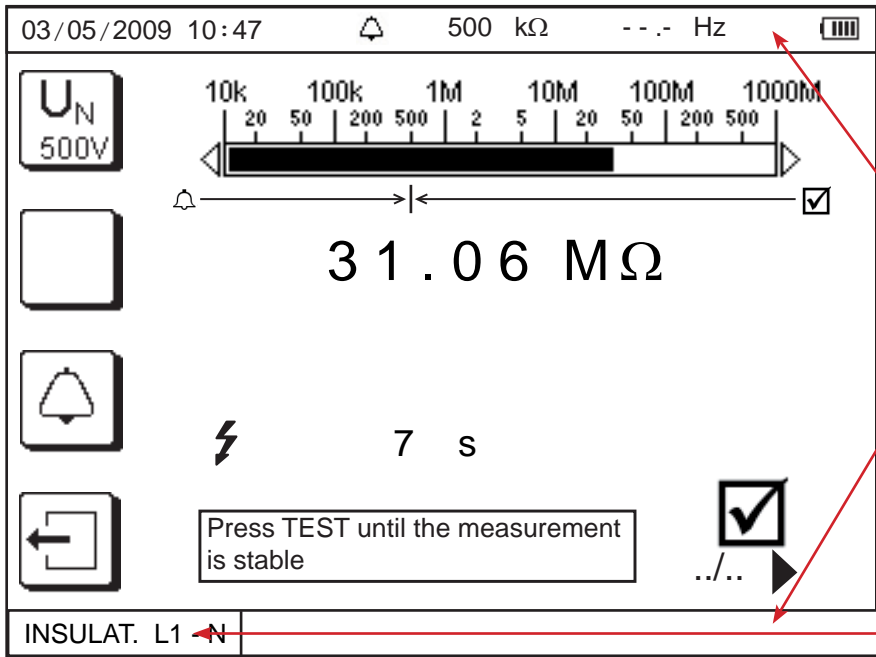

The top and bottom strips of the display unit are displayed in reverse video to clearly differentiate a measurement just made from a reading in memory.

Indexing of the measurement.





Press the key to return to the tree

6.6. ERASURE

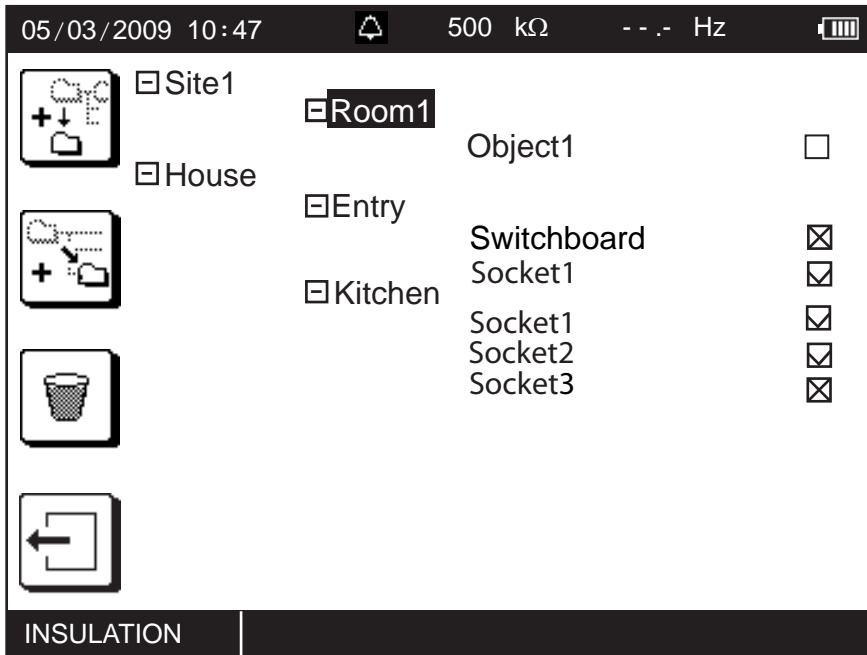
You can erase a SITE, a ROOM, an OBJECT or a record either when creating the tree or while reading in memory. Move the cursor onto the element to be erased using the keys of the directional keypad (▲▼◀▶).



Press the  key to erase ROOM1. The device asks you to confirm by pressing the OK key or abort by pressing the  key.

6.7. ERRORS

The commonest errors during storage are the following:

- The name given already exists. Change the name or index it (ROOM1, ROOM2, etc.)
- The memory is full. You must eliminate at least one OBJECT to be able to record your new measurement.
- It is not possible to record a measurement in a SITE or a ROOM. You must create an OBJECT in a ROOM or access an existing OBJECT and record the measurement there.

7. DATA EXPORT SOFTWARE

The data export software is in two parts:

- ICT (Installation Controller Transfer), used to configure the parameters of the measurements, prepare the tree in memory, and export the recorded measurements in an Excel file.
- Dataview, used to recover the measurements from the Excel file and present them in the form of a report conforming to the standard in your country.

Start by installing the driver and these software programs using the CD provided with the C.A. 6116.

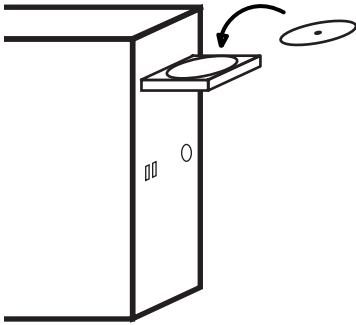

Then connect the device to the PC using the USB cord provided with the C.A. 6116 and removing the cover that protects the USB port of the device.

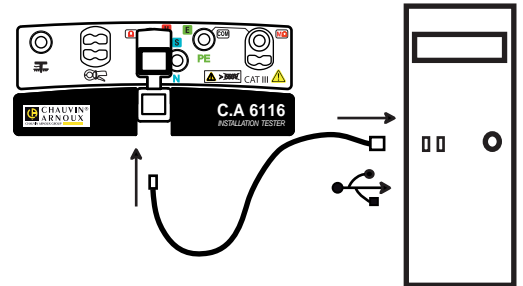

When the device is in communication with a PC, it does nothing else and its keys are inactive. It then displays the following message:

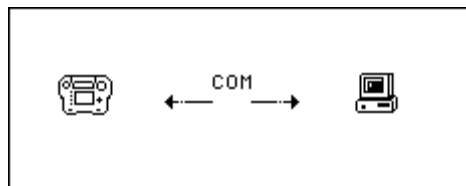

The data rate is 115,200 Bauds.

To use the data export software, refer to the help functions of the software.

Once the USB cord has been disconnected, the device restarts after a few seconds.

8. TECHNICAL CHARACTERISTICS

8.1. GENERAL REFERENCE CONDITIONS

Quantity of influence	Reference values
Temperature	20 ± 3 °C
Relative humidity	45 to 55 % HR
Supply voltage	9.6 ± 0.2 V
Electric field	< 1 V/m
Magnetic field	< 40 A/m
Supply	on battery (mains not connected)

The **intrinsic uncertainty** is the error defined under the reference conditions.

The **operating uncertainty** includes the intrinsic uncertainty plus the effects of variation of the quantities of influence (supply voltage, temperature, interference, etc.) as defined in standard IEC-61557.

8.2. ELECTRICAL CHARACTERISTICS

8.2.1. VOLTAGE MEASUREMENTS

Particular reference conditions:

Peak factor = 1.414 in AC

AC component <0.1% in DC measurement

DC component <0.1% in AC measurement

Measurement range (AC or DC)	0.2 - 399.9 V _~ 2.0 - 399.9 V ₌₌₌	400 - 550 V _~
Resolution	0.1 V	1 V
Intrinsic uncertainty	± (1.5 % + 2 ct)	± (1.5 % + 1 ct)
Input impedance	450 kΩ	
Frequency of use	DC and 15.3 ... 450 Hz	

Contact voltage measurements

Measurement range (AC)	2.0 - 100.0 V
Intrinsic uncertainty	± (15% + 2 ct)
Input impedance	6 MΩ
Frequency of use	15.3 ... 65 Hz

This voltage is displayed only if it exceeds U_L .

Measurements of potential of the voltage probe

The characteristics are the same as in the voltage measurements.

This voltage must normally be between 0 and U_L .

8.2.1. FREQUENCY MEASUREMENTS

Particular reference conditions:

- Voltage $\geq 2 V_{\sim}$
- or current $\geq 30 mA_{\sim}$ for the MN77 clamps,
 $\geq 10 mA_{\sim}$ for the C177 clamps,
 $\geq 50 mA_{\sim}$ for the C177A clamps.

Beyond these values, the frequency is indeterminate (display of - - - -).

Measurement range	15.3 - 399.9 Hz	400.0 - 499.9 Hz
Voltage range	10 ... 550 V	
Resolution	0.1 Hz	1 Hz
Intrinsic uncertainty	$\pm (0.1 \% + 1 \text{ ct})$	

8.2.3. CONTINUITY MEASUREMENTS

Particular reference conditions:

- Resistance of the leads: zero or compensated.
- Inductance of the leads: zero.
- External voltage on the terminals: zero.
- Inductance in series with the resistance: zero.

Compensation of the leads up to 5 Ω .

The maximum acceptable superposed external AC voltage is 0.5 VRMS in sine wave.

200 mA current

Measurement range	0.00 - 39.99 Ω
Resolution	0.01 Ω
Measurement current	$\geq 200 \text{ mA}$
Intrinsic uncertainty	$\pm (1.5\% + 2 \text{ ct})$
No-load voltage	9.5 V $\pm 10\%$
Maximum inductance in series	40 mH

12 mA current

Measurement range	0.00 - 39.99 Ω	40.0 - 399.9 Ω
Resolution	0.01 Ω	0.1 Ω
Measurement current	approximately 13 mA and $< 15 \text{ mA}$	
Intrinsic uncertainty	$\pm (1.5\% + 2 \text{ ct})$	
No-load voltage	9.5 V $\pm 10\%$	
Maximum inductance in series	40 mH	

8.2.4. RESISTANCE MEASUREMENTS

Particular reference conditions:

- External voltage on the terminals: zero.

Measurement range	0.0 - 3.999 k Ω	4.00 - 39.99 k Ω	40.0 - 399.9 k Ω
Resolution	1 Ω	10 Ω	100 Ω
Measurement current	$\leq 22 \mu\text{A}$	$\leq 22 \mu\text{A}$	$\leq 17 \mu\text{A}$
Intrinsic uncertainty	$\pm (1.5\% + 5 \text{ ct})$	$\pm (1.5\% + 2 \text{ ct})$	$\pm (1.5\% + 2 \text{ ct})$
No-load voltage	3.1 V $\pm 10\%$		

8.2.5. INSULATION RESISTANCE MEASUREMENTS

Particular reference conditions:

Capacitance in parallel: zero.

Maximum acceptable external AC voltage during the measurement: zero.

No-load voltage: $1.1 \times U_N$ or $1.2 \times U_N$ if $U_N = 50$ V.

Nominal current: ≥ 1 mA

Short-circuit current: ≤ 3 mA

Accuracy on the measurement of the test voltage: $\pm (1.5\% + 2 \text{ ct})$

Measurement range at 50 V	0.01 - 7.99 M Ω	8.00 - 39.99 M Ω	40.0 - 399.9 M Ω	400 - 1999 M Ω
Measurement range at 100 V	0.01 - 3.99 M Ω	4.00 - 39.99 M Ω		
Measurement range at 250 V	0.01 - 1.99 M Ω	2.00 - 39.99 M Ω		
Measurement range at 500 V	0.01 - 0.99 M Ω	1.00 - 39.99 M Ω		
Measurement range at 1000 V	0.01 - 0.49 M Ω	0.50 - 39.99 M Ω		
Resolution	10 k Ω	10 k Ω	100 k Ω	1 M Ω
Intrinsic uncertainty	$\pm (5\% + 3 \text{ ct})$	$\pm (2\% + 2 \text{ ct})$		

Typical measurement settling time as a function of the elements tested

These values include influences due to the capacitive component of the load, to the automatic range system, and to the regulation of the test voltage.

Test voltage	Load	Non-capacitive	With 100 nF	With 1 μ F
50 V - 100 V - 250 V - 500 V - 1000 V	10 M Ω	1 s	2 s	12 s
	1000 M Ω	1 s	4 s	30 s

Typical discharge time of a capacitive element to reach 25 V_{max}

Test voltage	50 V	100 V	250 V	500 V	1000 V
Discharge time (C in μ F)	0,25 s x C	0,5 s x C	1 s x C	2 s x C	4 s x C

Typical test voltage vs load curve

The voltage developed as a function of the resistance measured has the following form:

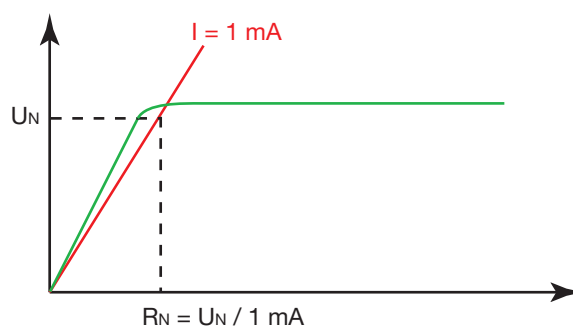

8.2.6. 3P EARTH RESISTANCE MEASUREMENTS

Particular reference conditions:

- Resistance of the E lead: zero or compensated.
- Interference voltages: zero.
- Inductance in series with the resistance: zero.
- $(R_H + R_S) / R_E < 300$ and $R_E < 100 \times R_H$ with R_H and $R_S \leq 15,00 \text{ k}\Omega$.

Compensation of the lead R_E up to 2.5Ω .

Measurement range	0.50 - 39.99 Ω	40.0 - 399.9 Ω	400 - 3999 Ω	0.20 - 15.00 $\text{k}\Omega$ ¹
Resolution	0.01 Ω	0.1 Ω	1 Ω	10 Ω
Intrinsic uncertainty	$\pm (2\% + 5 \text{ ct})$	$\pm (2\% + 2 \text{ ct})$		$\pm (10\% + 2 \text{ ct})$
Operating uncertainty	$\pm (9\% + 20 \text{ pt})$	$\pm (9\% + 5 \text{ pt})$		-
Typical peak-to-peak measurement current ²	4.3 mA	4.2 mA	3.5 mA	-
Measurement frequency	128 Hz			
No-load voltage	38.5 V peak-to-peak			

1: the 40 $\text{k}\Omega$ display range is used only for measurements of the R_H and R_S rods.

2: current at mid-range with $R_H = 1000 \Omega$.

Maximum acceptable interference voltage:

- 25 V on H from 50 to 500 Hz.
- 25 V on S from 50 to 500 Hz.

Accuracy on the measurement of the interference voltages:

Characteristics the same as for the voltage measurements.

8.2.7. LOOP IMPEDANCE MEASUREMENTS

Particular reference conditions:

- Voltage of the installation: 90 to 550 V.
- Stability of the voltage source: $< 0.05\%$.
- Frequency of the installation: 15.3 to 17.5 Hz and 45 to 65 Hz.
- Resistance of the leads: zero or compensated.
- Impedance of the inductive part of the measured impedance: $< 0.1 \times$ the resistive part.
- Contact voltage (potential of the protective conductor with respect to the local earth): $< 5 \text{ V}$.
- Residual leakage current of the installation: zero.

Compensation of the leads up to 5Ω .

Characteristics in 3-wire mode with tripping:

Measurement range	0.10 - 0.50 Ω	0.51 - 19.99 Ω	20.0 - 39.99 Ω	40.0 - 399.9 Ω	400 - 3999 Ω
Resolution	0.01 Ω			0.1 Ω	1 Ω
Peak measurement current between 90 and 280 V	1.50 to 4.77 A	1.23 to 4.66 A	1.03 to 3.84 A	0.26 to 3.21 A	0.03 to 0.82 A
Peak measurement current between 280 and 550 V	2.59 to 5.15 A	2.31 to 5.08 A	2.07 to 4.55 A	0.72 to 4.07 A	0.09 to 1.41 A
Intrinsic uncertainty on the impedance measurement	$\pm (10\% + 2 \text{ ct})$	$\pm (5\% + 2 \text{ ct})$			
Intrinsic uncertainty on the resistive part	$\pm (10\% + 2 \text{ ct})$	$\pm (5\% + 2 \text{ ct})$			
Intrinsic uncertainty on the inductive part ³	$\pm (10\% + 2 \text{ ct})$	$\pm (5\% + 2 \text{ ct})$		-	
Operating uncertainty on the impedance measurement	$\pm (17\% + 2 \text{ ct})$	$\pm (12\% + 2 \text{ ct})$			
Frequency of operation	15.3 ... 70 Hz				

3: the inductive part is displayed only when the impedance is $\leq 30 \Omega$.

Duration of the measurement: from 24 to 54 periods, depending on the voltage of the installation and the measured impedance.

If smoothing is activated (SMOOTH mode), the measurement result corresponds to the arithmetic mean of 5 values out of 7 (the

smallest and largest values are omitted). The instability of the intrinsic uncertainty is then halved (± 5 digits becomes ± 2.5 digits) and the duration of the measurement is of the order of 15 s.

Characteristics in non-tripping 3-wire mode:

Measurement range	0.20 - 1.99 Ω	2.00 - 39.99 Ω	40.0 - 399.9 Ω	400 - 3999 Ω
Resolution	0.01 Ω		0.1 Ω	1 Ω
RMS measurement current	choice of 6, 9, or 12 mA			
Intrinsic uncertainty on the impedance measurement ⁴	$\pm (15\% + 3 \text{ ct})$	$\pm (5\% + 3 \text{ ct})$	$\pm (5\% + 2 \text{ ct})$	$\pm (5\% + 2 \text{ ct})$
Intrinsic uncertainty on the resistive part	$\pm (15\% + 3 \text{ ct})$	$\pm (10\% + 3 \text{ ct})$	$\pm (5\% + 2 \text{ ct})$	$\pm (5\% + 2 \text{ ct})$
Intrinsic uncertainty on the inductive part	$\pm (15\% + 3 \text{ ct})$	$\pm (10\% + 3 \text{ ct})$	$\pm (5\% + 2 \text{ ct})$	$\pm (5\% + 2 \text{ ct})$
Operating uncertainty on the impedance measurement	$\pm (20\% + 3 \text{ ct})$	$\pm (12\% + 3 \text{ ct})$	$\pm (12\% + 2 \text{ ct})$	$\pm (5\% + 2 \text{ ct})$

4: There is no measurement of the inductive in L-PE loop part with a low current.
The error is defined for $0.1 \leq R_L / R_N \leq 10$ with R_L and $R_N \geq 1 \Omega$.

Duration of the measurement: from 4 to 71 periods, depending on the voltage of the installation and the measured impedance.

If smoothing is activated (SMOOTH mode), the measurement result corresponds to the arithmetic mean of 5 values out of 7 (the smallest and largest values are omitted). The instability of the intrinsic uncertainty is then halved (± 5 digits becomes ± 2.5 digits) and the duration of the measurement is of the order of 30 s.

Characteristics of the short-circuit current calculation:

Calculation formula : $I_k = U_{REF} / Z_S$

Calculation range	0.1 - 399.9 A	400 - 3999 A	4.00 - 6.00 kA
Resolution	0.1 A	1 A	10 A
Intrinsic uncertainty	$= \sqrt{(\text{Intrinsic uncertainty on the voltage measurement if } U_{MEAS} \text{ is used})^2 + (\text{Intrinsic uncertainty on the loop measurement})^2}$		
Operating uncertainty	$= \sqrt{(\text{Operating uncertainty on the voltage measurement if } U_{MEAS} \text{ is used})^2 + (\text{Operating uncertainty on the loop measurement})^2}$		

8.2.8. LINE IMPEDANCE MEASUREMENTS

Particular reference conditions:

Voltage of the installation: 90 to 550 V.

Stability of the voltage source: $< 0.05\%$.

Frequency of the installation: 15.3 to 17.5 Hz and 45 to 65 Hz.

Resistance of the leads: zero or compensated.

Impedance of the inductive part of the measured impedance: $< 0.1 \times$ the resistive part.

Compensation of the leads up to 5 Ω .

Characteristics in 2-wire mode:

Measurement range	0.10 - 0.50 Ω	0.51 - 19.99 Ω	20.0 - 39.99 Ω	40.0 - 399.9 Ω	400 - 3999 Ω
Resolution	0.01 Ω			0.1 Ω	1 Ω
Peak measurement current between 90 and 280 V	1.50 to 4.77 A	1.23 to 4.66 A	1.03 to 3.84 A	0.26 to 3.21 A	0.03 to 0.82 A
Peak measurement current between 280 and 550 V	2.59 to 5.15 A	2.31 to 5.08 A	2.07 to 4.55 A	0.72 to 4.07 A	0.09 to 1.41 A
Intrinsic uncertainty on the impedance measurement	± (10% + 2 ct)	± (5% + 2 ct)			
Intrinsic uncertainty on the resistive part	± (10% + 2 ct)	± (5% + 2 ct)			
Intrinsic uncertainty on the inductive part ⁵	± (10% + 2 ct)	± (5% + 2 ct)		-	
Operating uncertainty on the impedance measurement	± (17% + 2 ct)	± (12% + 2 ct)			

5: the inductive part is displayed only when the impedance is $\leq 30 \Omega$.

Duration of the measurement: from 24 to 54 periods, depending on the voltage of the installation and the measured impedance.

8.2.9. EARTH MEASUREMENTS ON LIVE CIRCUITS

Particular reference conditions:

Voltage of the installation: 90 to 550 V.

Stability of the voltage source: $<0.05\%$.

Frequency of the installation: 15.3 to 17.5 Hz and 45 to 65 Hz.

Resistance of the leads: zero or compensated.

Impedance of the inductive part of the measured impedance: $< 0.1 \times$ the resistive part.

Contact voltage (potential of the protective conductor with respect to the local earth): $<5 \text{ V}$.

Resistance of the voltage probe: $\leq 15 \text{ k}\Omega$.

Potential of the voltage probe with respect to the PE: $\leq U_L$.

Residual leakage current of the installation: zero.

Compensation of the leads up to $2,5 \Omega$ per lead.

Characteristics in tripping mode:

Measurement range	0.10 - 0.50 Ω	0.51 - 19.99 Ω	20.0 - 39.99 Ω	40.0 - 399.9 Ω	400 - 3999 Ω
Resolution	0.01 Ω			0.1 Ω	1 Ω
Peak measurement current between 90 and 280 V	1.50 to 4.77 A	1.23 to 4.66 A	1.03 to 3.84 A	0.26 to 3.21 A	0.03 to 0.82 A
Peak measurement current between 280 and 550 V	2.59 to 5.15 A	2.31 to 5.08 A	2.07 to 4.55 A	0.72 to 4.07 A	0.09 to 1.41 A
Intrinsic uncertainty on the impedance measurement	± (10% + 2 ct)	± (5% + 2 ct)			
Intrinsic uncertainty on the resistive part	± (10% + 2 ct)	± (5% + 2 ct)			
Intrinsic uncertainty on the inductive part ⁶	± (10% + 2 ct)	± (5% + 2 ct)		-	
Operating uncertainty on the impedance measurement	± (17% + 2 ct)	± (12% + 2 ct)			

6: the inductive part is displayed only when the impedance is $\leq 30 \Omega$.

Duration of the measurement: from 32 to 72 periods, depending on the voltage of the installation and the measured impedance.

Maximum acceptable resistance of the voltage probe: $15 \text{ k}\Omega$.

Accuracy on the probe resistance measurement: $\pm (10\% + 5 \text{ digits})$, resolution $0.1 \text{ k}\Omega$.

Maximum acceptable inductance for the measurement: 15 mH , resolution 0.1 mH .

If smoothing is activated (SMOOTH mode), the measurement result corresponds to the arithmetic mean of 5 values out of 7 (the smallest and largest values are omitted). The instability of the intrinsic uncertainty is then halved (± 5 digits becomes ± 2.5 digits) and the duration of the measurement is of the order of 15 s.

Calculation of the fault voltage if there is a short-circuit, U_{Fk} :

Measurement range	0.2 - 399.9 V \sim	400 - 550 V \sim
Resolution	0.1 V	1 V
Intrinsic uncertainty	$= \sqrt{(\text{Intrinsic uncertainty sur la mesure de tension si } U_{MEAS} \text{ est utilisé})^2 + (\text{Intrinsic uncertainty sur la mesure de boucle})^2}$	
Operating frequency	15.3 to 70 Hz	

Characteristics in non-tripping mode:

Measurement range	0.20 - 1.99 Ω	2.00 - 39.99 Ω	40.0 - 399.9 Ω	400 - 3999 Ω
Resolution	0.01 Ω		0.1 Ω	1 Ω
RMS measurement current	choice of 6. 9. or 12 mA			
Intrinsic uncertainty on the impedance measurement ⁷	$\pm (15\% + 3 \text{ ct})$	$\pm (5\% + 3 \text{ ct})$	$\pm (5\% + 2 \text{ ct})$	$\pm (5\% + 2 \text{ ct})$
Intrinsic uncertainty on the resistive part	$\pm (15\% + 3 \text{ ct})$	$\pm (10\% + 3 \text{ ct})$	$\pm (5\% + 2 \text{ ct})$	$\pm (5\% + 2 \text{ ct})$
Intrinsic uncertainty on the inductive part	$\pm (15\% + 3 \text{ ct})$	$\pm (10\% + 3 \text{ ct})$	$\pm (5\% + 2 \text{ ct})$	$\pm (5\% + 2 \text{ ct})$
Operating uncertainty on the impedance measurement	$\pm (20\% + 3 \text{ ct})$	$\pm (12\% + 3 \text{ ct})$	$\pm (12\% + 2 \text{ ct})$	$\pm (5\% + 2 \text{ ct})$

7: There is no measurement of the inductive in L-PE loop part with a low current.
The error is defined for $0,1 \leq R_L / R_N \leq 10$ with R_L and $R_N \geq 1 \Omega$.

Duration of the measurement: from 12 to 71 periods, depending on the voltage of the installation and the measured impedance.

Maximum acceptable resistance of the voltage probe: 15 k Ω .

Accuracy on the probe resistance measurement: $\pm (10\% + 5 \text{ digits})$, resolution 0.1 k Ω .

If smoothing is activated (SMOOTH mode), the measurement result corresponds to the arithmetic mean of 5 values out of 7 (the smallest and largest values are omitted). The instability of the intrinsic uncertainty is then halved (± 5 digits becomes ± 2.5 digits) and the duration of the measurement is of the order of 30 s.

Characteristics in selective mode:

Measurement range	0.50 - 39.99 Ω	40.0 - 399.9 Ω	400 - 3999 Ω
Resolution	0.01 Ω	0.1 Ω	1 Ω
Intrinsic uncertainty on the resistance measurement ⁸	$\pm (10\% + 10 \text{ ct})$		

8: there is no measurement of the inductive part in selective mode.

Duration of the measurement: from 32 to 72 periods, depending on the voltage of the installation and the measured impedance.

Maximum acceptable resistance of the voltage probe: 15 k Ω .

Accuracy on the probe resistance measurement: $\pm (10\% + 5 \text{ digits})$, resolution 0.1 k Ω .

The measurement current corresponds to the test current indicated in the table of characteristics in tripping mode divided by the ratio R_{SEL}/R_A avec $R_{SEL}/R_A \leq 100$. Beyond this, the maximum current, 20 mA peak, is reached.

8.2.10. TEST OF RESIDUAL CURRENT DEVICE

Particular reference conditions:

Voltage of the installation: 90 to 550 V.

Frequency of the installation: 15.3 to 17.5 Hz and 45 to 65 Hz.

Contact voltage (potential of the protective conductor with respect to the local earth): <5 V.

Resistance of the voltage probe (if used): < 100 Ω .

Potential of the voltage probe (if used) with respect to the PE: < U_L .

Residual leakage current of the installation: zero.

Limitation of the ranges according to the voltage

Range $I_{\Delta N}$	10 mA	30 mA	100 mA	300 mA	500 mA	650 mA	1000 mA	Variable
90 to 280 V	yes	yes	yes	yes	yes	yes	yes if ≥ 100 V and $R \leq 2 \Omega$	yes if ≤ 950 mA
280 to 550 V	yes	yes	yes	yes	yes	NO	NO	yes if ≤ 500 mA

The device makes the check when the TEST key is pressed.

The test current is also limited as a function of the nature of the test signal.

Limitation of the ranges in full-wave mode ( or )

Range $I_{\Delta N}$	10 mA	30 mA	100 mA	300 mA	500 mA	650 mA	1000 mA	Variable
Ramp	yes	yes	yes	yes	yes	yes	yes	yes
Pulse at $I_{\Delta N}$	yes	yes	yes	yes	yes	yes	yes	yes
Pulse at $2 \times I_{\Delta N}$	yes	yes	yes	yes	yes	NO	NO	yes if ≤ 500 mA
Pulse at $5 \times I_{\Delta N}$	yes	yes	yes	NO	NO	NO	NO	yes if ≤ 200 mA

Limitation of the ranges in half-wave mode ( or )

Range $I_{\Delta N}$	10 mA	30 mA	100 mA	300 mA	500 mA	650 mA	1000 mA	Variable
Ramp	yes	yes	yes	yes	yes	NO	NO	yes if ≤ 500 mA
Pulse at $I_{\Delta N}$	yes	yes	yes	yes	yes	NO	NO	yes if ≤ 500 mA
Pulse at $2 \times I_{\Delta N}$	yes	yes	yes	NO	NO	NO	NO	yes if ≤ 250 mA
Pulse at $5 \times I_{\Delta N}$	yes	yes	NO	NO	NO	NO	NO	yes if ≤ 100 mA

Characteristics in pulse mode:

Range $I_{\Delta N}$	10 mA - 30 mA - 100 mA - 300 mA - 500 mA - 650 mA - 1000 mA Variable (6 to 999 mA)				
Nature of the test	Determination of U_F	Non-tripping test	Tripping test	Tripping test (selective)	Tripping test
Test current	$0.2 \times I_{\Delta N} \dots 0.5 \times I_{\Delta N}^9$	$0.5 \times I_{\Delta N}$	$I_{\Delta N}$	$2 \times I_{\Delta N}$	$5 \times I_{\Delta N}$
Accuracy on the test current	+0 -7% ± 2 mA	+0 -7% ± 2 mA	-0 +7% ± 2 mA	-0 +7% ± 2 mA	-0 +7% ± 2 mA
Maximum duration of application of the test current	from 32 to 72 periods	1000 or 2000 ms	500 ms	500 ms	40 ms

9: this current can be adjusted in steps of $0.1 I_{\Delta N}$ and must not be less than 2,4 mA. As default, this current is $0.4 I_{\Delta N}$.

Characteristics in ramp mode:

Range $I_{\Delta N}$	10 mA - 30 mA - 100 mA - 300 mA - 500 mA - 650 mA - 1000 mA Variable (6 to 999 mA)	
Nature of the test	Determination of U_F	Tripping test
Test current	$0.2 \times I_{\Delta N} \dots 0.5 \times I_{\Delta N}^{10}$	$0.9573 \times I_{\Delta N} \times k / 28^{11}$
Accuracy on the test current	+0 -7% ± 2 mA	-0 +7% ± 2 mA
Maximum duration of application of the test current	from 32 to 72 periods	4600 ms to 50 and 60 Hz 4140 ms to 16.6 Hz
Accuracy on the indication of the tripping current	-	-0 +7% + 3.3 % $I_{\Delta N} \pm 2$ mA Resolution de 0.1 mA up to 400 mA and 1 mA thereafter

10: can be parameterized by the user.

11: k is between 9 and 31. The waveform so generated goes from $0.3 I_{\Delta N}$ to $1.06 I_{\Delta N}$ in 22 steps of 3.3% $I_{\Delta N}$ each having a duration of 200 ms (180 ms at 16.66Hz).

Characteristics of the trip time (T_A) :

	Pulse mode		Ramp mode
Measurement range	5.0 - 399.9 ms	400 - 500 ms	10.0 - 200.0 ms
Resolution	0.1 ms	1 ms	0.1 ms
Intrinsic uncertainty	± 2 ms		± 2 ms
Operating uncertainty	± 3 ms		± 3 ms

Characteristics of the fault voltage calculation (U_f) :

Calculation formula: $I_{AN} \times Z_{LPE}$ (or R_A or Z_A) and $2 \times I_{AN} \times Z_{LPE}$ (or R_E) if the test is done at $2 \times I_{AN}$.

Measurement range	5.0 - 70.0 V
Resolution	0.1 V
Intrinsic uncertainty	± (10% + 10 ct)

8.2.11. CURRENT MEASUREMENT

Particular reference conditions:

Peak factor = 1,414

DC component < 0.1 %

Frequency: 15.3 to 17.5 Hz and 45 to 65 Hz.

For the measurement of I_{SEL} , the intrinsic uncertainty is increased by 5%.

Characteristics with the MN77 clamp:

Transformation ratio: 1000 / 1

Measurement range	5.0 - 399.9 mA	0.400 - 3.999 A	4.00 - 19.99 A
Resolution	0.1 mA	1 mA	10 mA
Intrinsic uncertainty	± (2% + 5 ct)	± (1.5% + 2 ct)	± (1.2% + 2 ct)

When a voltage is connected between the L and PE terminals, the device synchronizes to the frequency of this voltage, allowing current measurements from 1 mA.

Characteristics with the C177 clamp:

Transformation ratio: 1000 / 1

Measurement range	5.0 - 399.9 mA	0.400 - 3.999 A	4.00 - 19.99 A
Resolution	0.1 mA	1 mA	10 mA
Intrinsic uncertainty	± (2% + 5 ct)	± (1.5% + 2 ct)	± (1.2% + 2 ct)

When a voltage is connected between the L and PE terminals, the device synchronizes to the frequency of this voltage, allowing current measurements from 0.5 mA.

Characteristics with the C177A clamp:

Transformation ratio: 10 000 / 1

Measurement range	0.020 - 3.999 A	4.00 - 39.99 A	40.0 - 199.9 A
Resolution	1 mA	10 mA	100 mA
Intrinsic uncertainty	± (1.5% + 2 ct)	± (1% + 2 ct)	± (1% + 2 ct)

When a voltage is connected between the L and PE terminals, the device synchronizes to the frequency of this voltage, allowing current measurements from 5 mA.

8.2.12. DIRECTION OF PHASE ROTATION

Particular reference conditions:

- Three-phase network.
- Voltage of the installation: 20 to 550 V.
- Frequency: 15.3 to 17.5 Hz and 45 to 65 Hz.
- Acceptable level of amplitude unbalance: 20%.
- Acceptable level of phase unbalance: 10%.
- Acceptable level of harmonics (voltage): 10%.

Characteristics:

The phase order is «positive» if rotation L1-L2-L3 is clockwise.
 The phase order is «negative» if rotation L1-L2-L3 is anticlockwise.
 The three voltages are measured (see the characteristics in §8.2.1) and indicated as U_{12} , U_{23} and U_{31} .

8.2.13. POWER MEASUREMENTS

Particular reference conditions:

- Sinusoidal voltage and current signals: $\cos\phi = 1$.
- Voltage ≥ 10 V.
- Current ≥ 0.1 A (for the C177A clamp).
- Frequency: 15.3 to 17.5 Hz and 45 to 65 Hz.
- No DC component.

Measurement range	5 - 3999 W	4.00 - 39.99 kW	40.0 - 110.0 kW ¹² 40.0 - 330.0 kW
Resolution	1 W	10 W	100 W
Intrinsic uncertainty	$\pm (2\% + 5 \text{ ct})$	$\pm (2\% + 2 \text{ ct})$	$\pm (2\% + 2 \text{ ct})$

12: full scale is 110 kW (550V x 200A) in single-phase and 330 kW in three-phase.

8.2.14. POWER FACTOR

Particular reference conditions:

- Voltage of the installation: 10 to 550 V.
- Current: 0.1 to 200 A.

Measurement range	$(\pm) 0.2 - 0.49$	$(\pm) 0.50 - 1.00$
Resolution	0.01	
Intrinsic uncertainty	$\pm (2\% + 2 \text{ ct})$	$\pm (1\% + 2 \text{ ct})$

If the power is zero, the power factor is indeterminate.

The power factor is, by definition, unsigned. But it is given a sign to indicate whether the load is inductive (+ sign) or capacitive (- sign). The sign is determined by the phase lead or lag between the voltage and the current.

8.2.15. HARMONICS

Particular reference conditions:

- Signal without inter-harmonics, of which the fundamental is stronger than the other harmonic components and than the DC component.
- Frequency of the fundamental: 16.66 Hz, 50 Hz, or 60 Hz ± 0.05 Hz.
- Peak factor of the signal ≤ 4 .
- For the C177A clamp: RMS signal greater than 10 V or 1 A.

Characteristics:

Characteristics of voltage display	10 to 550 V, the display range being determined by the value of the strongest harmonic component.
Characteristics of current display	1 to 200 A, the display range being determined by the value of the strongest harmonic component.
Stability of the current and voltage display	± 2 ct
Domain of use	Harmonics of orders 1 to 50
Measurement range for the harmonic factor	0.2 - 399.9 %
Detection threshold for the harmonic factor	0.1 %
Measurement range in THD-F and THD-R	0.2 - 100 %
Resolution for the harmonic factor, THD-F and THD-R	0.1%
Intrinsic uncertainty on the RMS value and the harmonic factor	Factor > 10% and order < 13: 5 ct Factor <10% and order < 13: 10 ct Factor > 10% and order > 13: 10 ct Factor > 10% and order > 13: 15 ct
Intrinsic uncertainty on the THD-F and THD-R	10 ct

Method and definitions:

Determination of harmonics: Cooley-Tukey FFT algorithm on 16 bits

Sampling frequency: 256 times the frequency of the fundamental

Filtering window: rectangular, 4 periods

THD-F: Total distortion referred to the fundamental of the signal.

$$THD-F = \frac{\sqrt{\sum_{n=2}^{n=50} H_n^2}}{H_1}$$

THD-R: Total distortion referred to the RMS value of the signal (also called DF: distortion factor).

$$THD-R = \frac{\sqrt{\sum_{n=2}^{n=50} H_n^2}}{R[RMS]}$$

8.3. VARIATIONS IN THE RANGE OF USE

8.3.1. VOLTAGE MEASUREMENT

Quantities of influence	Limits of the range of use	Variation of the measurement	
		Typical	Maximum
Temperature	-10 ... + 55 °C	1 %/10 °C ± 1 ct	2 %/10 °C + 2 ct
Relative humidity	10 ... 85 % RH at 45°C	2 %	3 % + 2 ct
Supply voltage	8.4 ... 10 V	0.1% or 1 ct	0.5% + 2 ct
Frequency	15.3 ... 450 Hz	0.5%	1% + 1 ct
Series mode rejection in AC	0 ... 500 V _{DC}	50 dB	40 dB
50/60Hz series mode rejection in DC	0 ... 500 V _{AC}	50 dB	40 dB
Common mode rejection in 50/60Hz AC	0 ... 500 V _{AC}	50 dB	40 dB

8.3.2. INSULATION MEASUREMENT

Quantities of influence	Limits of the range of use	Variation of the measurement	
		Typical	Maximum
Temperature	-10 ... + 55 °C	1 %/10 °C ± 1 ct	2 %/10 °C + 2 ct
Relative humidity	10 ... 85 % RH at 45°C	2 %	3 % + 2 ct
Supply voltage	8.4 ... 10 V	0.25% or 2 ct	2% + 2 ct
50/60Hz AC voltage superposed on the test voltage (U_N)	Ranges 50 V and 100 V R ≤ 100 MΩ : 2 V R > 100 MΩ : 0,7 V	1%	5% + 2 ct
	Ranges 250 V and 500 V R ≤ 100 MΩ : 6 V R > 100 MΩ : 2 V		
	Ranges 500 V and 1000 V R ≤ 100 MΩ : 10 V R > 100 MΩ : 3 V		
Capacitance in parallel on the resistance to be measured	0 ... 5 μF @ 1 mA	1%	1% + 1 ct
	0 ... 2 μF @ 2000 MΩ	1%	10% + 5 ct

8.3.3. RESISTANCE AND CONTINUITY MEASUREMENT

Quantities of influence	Limits of the range of use	Variation of the measurement	
		Typical	Maximum
Temperature	-10 ... + 55 °C	1 %/10 °C ± 1 ct	2 %/10 °C + 2 ct
Relative humidity	10 ... 85 % RH at 45°C	2 %	3 % + 2 ct
Supply voltage	8.4 ... 10 V	0.25% or 1 ct	1% + 2 ct
50/60Hz AC voltage superposed on the test voltage	0.5 V _{AC}	0,5%	1% + 2 ct

8.3.4. 3P EARTH MEASUREMENT

Quantities of influence	Limits of the range of use	Variation of the measurement	
		Typical	Maximum
Temperature	-10 ... + 55 °C	1 %/10 °C ± 1 ct	2 %/10 °C + 2 ct
Relative humidity	10 ... 85 % RH at 45°C	2 %	3 % + 2 ct
Supply voltage	8.4 ... 10 V	0.25% or 1 ct	1% + 1 ct
Voltage in series in the voltage measurement loop (S-E) Fundamental = 16.6/50/60Hz + odd harmonics	15 V ($R_E \leq 40 \Omega$) 25 V ($R_E > 40 \Omega$)	0.5% or 10 ct	2% + 50 ct 2% + 2 ct
Voltage in series in the current injection loop (H-E) Fundamental = 16.6/50/60Hz + odd harmonics	15 V ($R_E \leq 40 \Omega$) 25 V ($R_E > 40 \Omega$)		0.5% or 10 ct
Current loop rod resistance (R_H)	0 to 15 kΩ	0.3%	1% + 2 ct
Voltage loop rod resistance (R_S)	0 to 15 kΩ	0.3%	1% + 2 ct

8.3.5. CURRENT MEASUREMENT

Quantities of influence	Limits of the range of use	Variation of the measurement	
		Typical	Maximum
Temperature	-10 ... + 55 °C	1 %/10 °C ± 1 ct	2 %/10 °C + 2 ct
Relative humidity	10 ... 85 % RH at 45°C	2 %	3 % + 2 ct
Supply voltage	8.4 ... 10 V	0.1% or 2 ct	0.5% + 2 ct
Frequency	15.3 ... 45 Hz	1%	1% + 1 ct
	45 ... 450 Hz	0.5%	1.5% + 1 ct
50/60Hz series mode rejection in AC	0 ... 500 V _{AC}	50 dB	40 dB

8.3.6. EARTH MEASUREMENT ON LIVE CIRCUIT, LOOP AND SELECTIVE EARTH

Quantities of influence	Limits of the range of use	Variation of the measurement	
		Typical	Maximum
Temperature	-10 ... + 55 °C	1 %/10 °C ± 1 ct	2 %/10 °C + 2 ct
Relative humidity	10 ... 85 % RH at 45°C	2 %	3 % + 2 ct
Supply voltage	8.4 ... 10 V	0.5% or 2 ct	2% + 2 ct
Network frequency of the installation tested	99 to 101% of the nominal frequency	0.1% or 1 ct	0.1% + 1 ct
Network voltage of the installation tested	85 to 110% of the nominal voltage	0.1% or 1 ct	0.1% + 1 ct
Phase difference between the internal load and the measured impedance or inductance of the measured impedance or L/R ratio of the measured impedance	0 ... 20° or 0 ... 400 mH or 0 ... 500 ms	1%/10°	1%/10°
Resistance in series with the voltage probe (earth on live circuit only)	0 ... 15 kΩ	Negligible (taken into account in the intrinsic uncertainty)	Negligible (taken into account in the intrinsic uncertainty)
Contact voltage (U ₀)	0 ... 50 V	Negligible (taken into account in the intrinsic uncertainty)	Negligible (taken into account in the intrinsic uncertainty)

8.3.7. TEST OF RESIDUAL CURRENT DEVICE

Quantities of influence	Limits of the range of use	Variation of the measurement	
		Typical	Maximum
Temperature	-10 ... + 55 °C	1 %/10 °C ± 1 ct	2 %/10 °C + 2 ct
Relative humidity	10 ... 85 % RH at 45°C	2 %	3 % + 2 ct
Supply voltage	8.4 ... 10 V	0.1% or 1 ct	0.5% + 2 ct
Network frequency of the installation tested	99 to 101% of the nominal frequency	0.1% or 1 ct	0.1% + 1 ct
Network voltage of the installation tested	85 to 110% of the nominal voltage	0.1% or 1 ct	0.1% + 1 ct

8.3.8. DIRECTION OF PHASE ROTATION

No quantity of influence

8.3.9. POWER

Quantities of influence	Limits of the range of use	Variation of the measurement	
		Typical	Maximum
Temperature	-10 ... + 55 °C	1 %/10 °C ± 1 ct	2 %/10 °C + 2 ct
Relative humidity	10 ... 85 % RH at 45°C	2 %	3 % + 2 ct
Supply voltage	8.4 ... 10 V	0.1% or 1 ct	0.5% + 2 ct
Network frequency of the installation tested	99 to 101% of the nominal frequency	0.1% or 1 ct	0.1% + 1 ct
Network voltage of the installation tested	85 to 110% of the nominal voltage	0.1% or 1 ct	0.1% + 1 ct
Power factor	0.50 ... 1.00 at 45...65 Hz	0.5%	1% + 2 ct
	0.20 ... 0.49 at 45...65 Hz	1.5%	3% + 2 ct
	0.50 ... 1.00 at 15.3...17.5 Hz	2%	2.5% + 2 ct
	0.20 ... 0.49 at 15.3...17.5 Hz	4%	5% + 2 ct

8.3.10. VOLTAGE AND CURRENT HARMONICS

The quantities of influence and the associated variations are the same as for voltage measurements and current measurements, respectively.

8.4. INTRINSIC UNCERTAINTY AND OPERATING UNCERTAINTY

The C.A. 6116 installation tester complies with standard IEC-61557, which requires that the operating uncertainty, called B, be less than 30%.

- In insulation, $B = \pm (|A| + 1,15 \sqrt{E_1^2 + E_2^2 + E_3^2})$
 with A = intrinsic uncertainty
 E_1 = influence of the reference position $\pm 90^\circ$.
 E_2 = influence of the supply voltage within the limits indicated by the manufacturer
 E_3 = influence of the temperature between 0 and 35°C.
- In continuity measurement, $B = \pm (|A| + 1,15 \sqrt{E_1^2 + E_2^2 + E_3^2})$
- In loop measurement, $B = \pm (|A| + 1,15 \sqrt{E_1^2 + E_2^2 + E_3^2 + E_6^2 + E_7^2 + E_8^2})$
 with E_6 = influence of the phase angle from 0 to 18°.
 E_7 = influence of the network frequency from 99 to 101% of the nominal frequency.
 E_8 = influence of the network voltage from 85 to 110% of the nominal voltage.
- In earth measurement, $B = \pm (|A| + 1,15 \sqrt{E_1^2 + E_2^2 + E_3^2 + E_4^2 + E_5^2 + E_7^2 + E_8^2})$
 with E_4 = influence of the interference voltage in series mode (3 V at 16.6, 50, 60, and 400 Hz)
 E_5 = influence of the resistance of the rods from 0 to 100 x R_A but ≤ 50 kΩ.
- In test of residual current device, $B = \pm (|A| + 1,15 \sqrt{E_1^2 + E_2^2 + E_3^2 + E_5^2 + E_8^2})$
 with E_5 = influence of the resistance of the probes within the limits indicated by the manufacturer.

8.5. POWER SUPPLY

The device is powered by a 9.6 V, 4 Ah rechargeable NiMH battery pack.

This has many advantages:

- long life between charges with limited bulk and weight,
- the possibility of recharging your battery rapidly,
- a very small memory effect: you can recharge your battery even if it is not fully discharged, without reducing its capacity,
- protection of the environment through the absence of polluting materials such as lead and cadmium.

The NiMH technology allows a limited number of charging/discharging cycles that depends on the conditions of use and the charging conditions. Under optimum conditions, this number of cycles is 200.

The day before you use your device, check its charge condition. If the battery level indicator shows less than three bars, charge the device overnight (see §1.2).

The charging time is approximately 5 h.

To make the most of your battery and extend its effectiveness:

- Use only the charger supplied with your device. The use of another charger may prove dangerous!
- Charge your device only between 10 and 35°C.
- Observe the conditions of use and storage stated in this data sheet.

The mean battery life depends on the type of measurement and on how the device is used. Approximately:
16 h if the automatic switching off function is deactivated,
24 h if the automatic switching off function is activated,

8.6. ENVIRONMENTAL CONDITIONS

Indoor and outdoor use.

Operating range	0 to 55°C and 10% to 85% RH
Specified operating range ¹³	0 to 35°C and 10% to 75% RH
Range for recharging the battery	10 to 35°C
Range in storage (without battery)	-40°C to +70°C and 10% to 90% RH
Altitude	<2,000m
Pollution degree	2

13: This range corresponds to the range of the operating uncertainty defined by standard IEC-61557. When the device is used outside this range, it is necessary to add 1.5%/10°C and 1.5% between 75 and 90% RH to the operating uncertainty.

8.7. MECHANICAL CHARACTERISTICS

Dimensions (L x D x H) 280 x 190 x 128 mm
Weight approximately 2.4 kg

Protection class IP 53 per IEC-60 529 (Ed. 92) if the cover of the USB port is closed, IP 51 if it is open.
IK 04 per IEC-50102 (Ed. 95)

Free fall test Per IEC-61010-1 (Ed. 2 of 2001)

8.8. CONFORMITY TO INTERNATIONAL STANDARDS

The device is in conformity with IEC-61010-1 (Ed. 2 of 2001), 600V, CAT III.

Assigned characteristics: measurement category III, 600V with respect to earth, 550V in differential between the terminals, and 300V, CAT II on the charger input.

The device is in conformity with:



- IEC-61557 (Ed. 2 of 2007) parts 1, 2, 3, 4, 5, 6, and 7.
- IEC-61557 (Ed. 1 of 2001) part 10.

8.9. ELECTROMAGNETIC COMPATIBILITY (EMC)

The device is in conformity with standard IEC-61326-1 (Ed. 97) + A1 (Ed. 98) + A2 (Ed. 2001).

9. DEFINITIONS OF SYMBOLS

Here is a list of the symbols used in this document and on the display unit of the device.

3P	earth resistance measurement with 2 auxiliary rods.
AC	AC (Alternating Current) signal.
DC	DC (Direct Current) signal.
DF	Distortion Factor = THD-R.
E	E terminal (earth electrode, measurement current return terminal).
FFT	harmonic analysis of a signal (Fast Fourier Transform).
	selective residual current device, specific to Austria.
H	H terminal (measurement current injection terminal in 3P earth measurement).
Hz	Hertz: indicates the frequency of the signal.
I	current.
I_1	current in phase 1 of a three-phase network.
I_2	current in phase 2 of a three-phase network.
I_3	current in phase 3 of a three-phase network.
$I_{\Delta N}$	assigned differential operating current of the RCD to be tested.
I_a	RCD tripping current of the residual current device.
Ik	short-circuit current between the L and N, L and PE, N and PE, or L and L terminals.
IT	Type of link to earth defined in standard IEC-60364-6.
I_{SEL}	current flowing in the earthing resistance to be measured in selective earth measurement on live circuit.
L	L terminal (phase).
L_i	inductance in the L-N or L-L loop.
L_s	inductance in the L-PE loop.
N	N terminal (neutral).
P	active power, $P = U \cdot I \cdot PF$.
PE	PE terminal (protective conductor).
PF	power factor ($\cos\varphi$ for sinusoidal signal).
PIT	Permanent Insulation Tester.
φ	phase difference of the current with respect to the voltage.
R	mean resistance calculated from R_+ and R_- .
R_+	resistance measured with a positive current flowing from terminal Ω to terminal COM.
R_-	resistance measured with a negative current flowing from terminal Ω to terminal COM.
R_{\pm}	resistance measured alternately with a positive current, then a negative current.
R_{Δ}	resistance of the accessories subtracted from the measurement (compensation of the measurement leads).
RCD	acronym designating a Residual Current Device or switch.
R_A	earth resistance in earth measurement on live circuit.
R_{ASEL}	selective earth resistance in selective earth measurement on live circuit.
R_E	earth resistance connected to the E terminal.
R_H	resistance of the rod connected to the H terminal.
R_{L-N}	resistance in the L-N loop.
R_{L-PE}	resistance in the L-PE loop.
RMS	Root Mean Square: root-mean-square value of the signal, the square root of the mean of the squares of the signals.
R_{N-PE}	resistance in the N-PE loop.
R_N	nominal resistance in insulation measurement $R_N = U_N/1mA$.
R_{PI}	resistance of the auxiliary rod in earth measurement on live circuit.
R_{PE}	resistance of protective conductor PE.
R_S	resistance of the rod connected to the S terminal.
S	terminal S (acquisition of measurement potential for the earth resistance calculation).
	selective residual current device.
T_A	effective trip time of the residual current device.
THD-F	level of harmonic distortion referred to the fundamental.

THD-R	harmonic distortion factor referred to the RMS value of the signal.
TN	type of link to earth defined in standard IEC-60364-6.
TT	type of link to earth defined in standard IEC-60364-6.
U₁₂	voltage between phases 1 and 2 of a three-phase network.
U₂₃	voltage between phases 2 and 3 of a three-phase network.
U₃₁	voltage between phases 3 and 1 of a three-phase network.
U_C	contact voltage between conducting parts when they are touched simultaneously by a person or an animal (IEC-61557).
U_F	fault voltage appearing during a fault condition between accessible conducting parts (and/or external conducting parts) and the reference frame ground (IEC-61557).
U_{Fk}	fault voltage, in the event of a short-circuit, according to Swiss standard SEV 3569. $U_{Fk} = I_k \times Z_A = U_{REF} \times Z_A / Z_S$
U_{H-E}	voltage measured between terminals H and E.
U_L	conventional maximum contact voltage (IEC-61557).
U_{L-N}	voltage measured between the L and N terminals.
U_{L-PE}	voltage measured between the L and PE terminals.
U_N	nominal test voltage in insulation measurement, generated between the MΩ and COM terminals.
U_{N-PE}	voltage measured between the N and PE terminals.
U_{PE}	voltage between the PE conductor and the local earth measured when the user presses the TEST key.
U_{REF}	reference voltage for calculation of the short-circuit current.
U_{S-E}	voltage measured between the S and E terminals.
Z_A	earth impedance in earth measurement on live circuit.
Z_S	impedance in the loop between the phase and the protective conductor.
Z_i	impedance in the loop between the phase and the neutral or between two phases (line loop impedance).
Z_{L-N}	impedance in the L-N loop.
Z_{L-PE}	impedance in the L-PE loop.

10. MAINTENANCE

 For maintenance, use only the spare parts specified. The manufacturer cannot be held liable for any accident that occurs following a repair not performed by its customer service department or by an approved repairer.

10.1. CLEANING

Disconnect anything connected to the device and set the switch to OFF.

Use a soft cloth, dampened with soapy water. Rinse with a damp cloth and dry rapidly with a dry cloth or forced air. Do not use alcohol, solvents, or hydrocarbons.

10.2. REPLACING THE BATTERY

The battery of this device is specific: it has precisely matched protection and safety elements. Replacement of the battery by a model other than the one specified may result in damage to equipment or bodily injury by explosion or fire.

 To keep the device safe, replace the battery only with the original model.

Replacement procedure:

1. Disconnect anything connected to the device and set the switch to OFF.
2. Turn the two quarter-turn screws of the battery compartment cover using a tool, then remove the battery compartment cover.

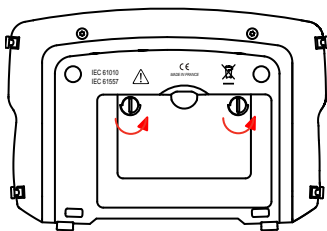

3. Turn the device over while holding the battery as it slides out of its compartment.

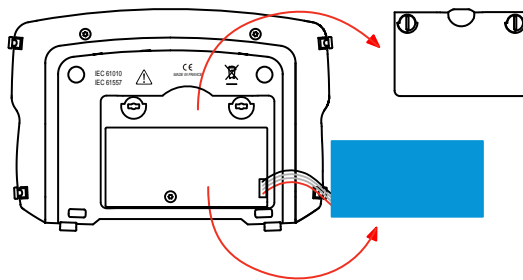

4. Disconnect the battery connector without pulling on the wires.
5. Connect the new battery. **The connector is polarized to prevent connection errors.**
6. Place the battery in its compartment and arrange the wires so that they do not protrude.

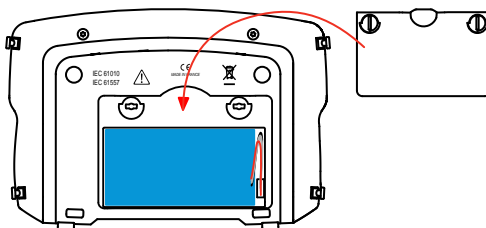

7. Put the battery compartment cover back in place and screw the two quarter-turn screws back.
8. Charge the new battery **fully** before using the device.
9. If the battery remained disconnected for more than 5 minutes, you may have to reprogram the date and time of the device (see §5).

Attention : Whenever the battery is disconnected, **even if it is not replaced**, it must be charged fully. This is so that the device will know the charge condition of the battery (this information is lost when it is disconnected).

10.3. RESETTING THE DEVICE

If the device crashes, it can be reset, like a PC.

Set the switch to Zs (RA/SEL).

Press the 3 keys indicated below simultaneously.

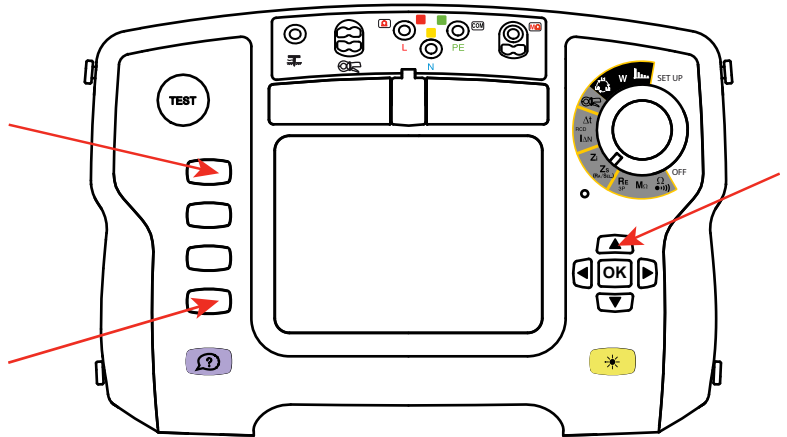
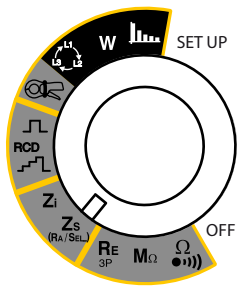

10.4. METROLOGICAL CHECK

 Like all measuring or testing devices, the instrument must be checked regularly.

This instrument should be checked at least once a year. For checks and calibrations, contact one of our accredited metrology laboratories (information and contact details available on request), at our Chauvin Arnoux subsidiary or the branch in your country.

10.5. REPAIR

For all repairs before or after expiry of warranty, please return the device to your distributor.

11. WARRANTY

Except as otherwise stated, our warranty is valid for **twelve months** starting from the date on which the equipment was sold. Extract from our General Conditions of Sale provided on request.

The warranty does not apply in the following cases:

- Inappropriate use of the equipment or use with incompatible equipment;
- Modifications made to the equipment without the explicit permission of the manufacturer's technical staff;
- Work done on the device by a person not approved by the manufacturer;
- Adaptation to a particular application not anticipated in the definition of the equipment or not indicated in the user's manual;
- Damage caused by shocks, falls, or floods.

12. TO ORDER

Installation Tester Model C.A 6116 Cat. #2138.01

Delivered with:

- one carrying bag
- one power cord
- one hand strap
- carrying strap for meter
- ICT data export software on CD-ROM
- USB cable (1.8m)
- one 3-Pin voltage lead with US plug
- one 3-Pin lead with color-coded (red, blue & green) stackable safety banana plugs
- one, set of 3, color-coded test probes (red, blue & green)
- one, set of 3, color-coded alligator clips (red, blue & green)
- one standard ground/earth kit
- one, set of 2, color-coded leads {3m} (red/black 4mm straight, 4mm right angle)
- one remote test probe
- 5 user manuals on CD (one per language)
- 5 safety sheets (one per language)

12.1. ACCESSORIES

Test Kit for 3-Pole (3-Point) Testing (150 ft)	Cat. #2135.35
Test Kit for 4-Pole (4-Point) Testing (300 ft)	Cat. #2135.36
Test Kit for 4-Pole (4-Point) Testing (500 ft)	Cat. #2135.37
Test Kit for 3-Pole (3-Point) Testing	Cat. #2135.38
AC Current Probe Model C177A	Cat. #2138.52
AC Current Probe Model MN77	Cat. #2138.53
Continuity Pole	Cat. #2138.54
Wrist strap	Cat. #2138.59

12.2. REPLACEMENT PARTS

Probe - Remote test probe	Cat. #2118.97
Battery - 9.6V NiMH battery	Cat. #2140.19
Cable - 5 ft USB cable	Cat. #2140.46
Lead - 3-Pin voltage lead with US plug	Cat. #2138.55
Lead - 3-Pin lead with color-coded (red, blue & green) stackable safety banana plugs	Cat. #2138.56
Lead - Set of 2, color-coded leads {3m} (red/black 4mm straight, 4mm right angle)	Cat. #2138.57
Strap - Carrying strap for meter	Cat. #2138.58
Clips - Set of 3, color-coded alligator clips (red, blue & green)	Cat. #2140.70
Probe - Set of 3, color-coded test probes (red, blue & green)	Cat. #2140.71
Power cord (1.8m)	Cat. #5000.27
Carrying case	Cat. #5000.28
Screen protection film	Cat. #5000.29



11 - 2009

Code 691945A02 - Ed. 1

DEUTSCHLAND - Chauvin Arnoux GmbH

Straßburger Str. 34 - 77694 Kehl / Rhein
Tel: (07851) 99 26-0 - Fax: (07851) 99 26-60

ESPAÑA - Chauvin Arnoux Ibérica S.A.

C/ Roger de Flor, 293 - 1a Planta - 08025 Barcelona
Tel: 90 220 22 26 - Fax: 93 459 14 43

ITALIA - Amra SpA

Via Sant'Ambrogio, 23/25 - 20050 Macherio (MI)
Tel: 039 245 75 45 - Fax: 039 481 561

ÖSTERREICH - Chauvin Arnoux Ges.m.b.H

Slamastrasse 29/2/4 - 1230 Wien
Tel: 01 61 61 9 61-0 - Fax: 01 61 61 9 61-61

SCANDINAVIA - CA Mätssystem AB

Box 4501 - SE 18304 TÄBY
Tel: +46 8 50 52 68 00 - Fax: +46 8 50 52 68 10

SCHWEIZ - Chauvin Arnoux AG

Moosacherstrasse 15 - 8804 AU / ZH
Tel: 044 727 75 55 - Fax: 044 727 75 56

UNITED KINGDOM - Chauvin Arnoux Ltd

Waldeck House - Waldeck Road - Maidenhead SL6 8BR
Tel: 01628 788 888 - Fax: 01628 628 099

MIDDLE EAST - Chauvin Arnoux Middle East

P.O. BOX 60-154 - 1241 2020 JAL EL DIB (Beirut) - LEBANON
Tel: (01) 890 425 - Fax: (01) 890 424

CHINA - Shanghai Pu-Jiang - Enerdis Instruments Co. Ltd

3 F, 3 rd Building - N° 381 Xiang De Road - 200081 SHANGHAI
Tel: +86 21 65 21 51 96 - Fax: +86 21 65 21 61 07

USA - Chauvin Arnoux Inc - d.b.a AEMC Instruments

200 Foxborough Blvd. - Foxborough - MA 02035
Tel: (508) 698-2115 - Fax: (508) 698-2118

<http://www.chauvin-arnoux.com>

190, rue Championnet - 75876 PARIS Cedex 18 - FRANCE

Tél. : +33 1 44 85 44 85 - Fax : +33 1 46 27 73 89 - info@chauvin-arnoux.fr

Export : Tél. : +33 1 44 85 44 38 - Fax : +33 1 46 27 95 59 - export@chauvin-arnoux.fr