



---

Adam Equipment

**AE 402  
Indicator**

(P.N. 3106610631, Revision B1, October 2010)

**Easy Reference:**

Model name of the scale:	
Serial number of the unit:	
Software revision number (Displayed when power is first turned on):	
Date of Purchase:	
Name of the supplier and place:	

# CONTENTS

1.0	INTRODUCTION.....	2
2.0	SPECIFICATIONS .....	3
3.0	INSTALLATION.....	4
3.1	LOCATING THE SCALES .....	4
3.2	LIST OF ACCESSORIES .....	4
3.3	SETTING UP THE SCALES.....	5
3.4	CONNECTIONS .....	5
	<b>3.4.1 CONNECTION OF LOAD CELL .....</b>	<b>5</b>
	<b>3.4.2 CONNECTION OF RS-232 .....</b>	<b>6</b>
	<b>3.4.3 CONNECTION OF RELAY DRIVERS.....</b>	<b>6</b>
4.0	KEY DESCRIPTIONS.....	7
5.0	DISPLAYS.....	8
6.0	OPERATION .....	9
6.1	ZEROING THE DISPLAY .....	9
6.2	TARING .....	9
6.3	WEIGHING A SAMPLE .....	10
6.4	PARTS COUNTING.....	11
6.5	CHECK-WEIGHING .....	12
6.6	ACCUMULATED TOTAL.....	15
6.7	PERCENT WEIGHING.....	16
6.8	ANIMAL (Dynamic) WEIGHING .....	18
	<b>6.8.1 ANIMAL WEIGHING PROCEDURE.....</b>	<b>19</b>
7.0	USER PARAMETERS .....	20
7.1	CHECK WEIGHING PARAMETERS.....	20
7.2	PERCENT WEIGHING and ANIMAL WEIGHING.....	21
7.3	RS-232 PARAMETERS.....	22
7.4	SCALE PARAMETERS .....	23
8.0	BATTERY OPERATION .....	25
9.0	RS-232 INTERFACE.....	26
9.1	INPUT COMMANDS FORMAT .....	29
10.0	RELAY INTERFACE.....	30
11.0	CALIBRATION .....	31
12.0	SERVICE SECTION .....	32
12.1	USING “1000” TO ENTER THE SERVICE PARAMETERS.....	32
12.2	USING “2006” TO ENTER THE SECURE PARAMETERS .....	33
12.3	PARAMETER DETAILS .....	34
	<b>12.3.1 F1 -CALIBRATION .....</b>	<b>34</b>
	<b>12.3.2 F2-DECIMAL POINT POSITION .....</b>	<b>34</b>
	<b>12.3.3 F3 – CAPACITY/ WEIGHING UNIT/INCREMENT .....</b>	<b>35</b>
	<b>12.3.4 F4 –INITIAL ZERO RANGE .....</b>	<b>36</b>
	<b>12.3.5 F5 -RE-ZERO RANGE.....</b>	<b>36</b>
	<b>12.3.6 F6 -SUCCESSIVE TARE.....</b>	<b>36</b>
	<b>12.3.7 F7 –ADC COUNTS .....</b>	<b>36</b>
	<b>12.3.8 F8 –ZERO MODE.....</b>	<b>36</b>
	<b>12.3.9 F9 –LOW VOLTAGE DETECTION .....</b>	<b>37</b>
	<b>12.3.10 FA –AZn Auto Zero Range.....</b>	<b>37</b>
	<b>12.3.11 Fb –FPS User Function Password .....</b>	<b>37</b>
13.0	ERROR CODES .....	38
14.0	REPLACEMENT PARTS AND ACCESSORIES .....	39
15.0	SERVICE INFORMATION.....	39
16.0	WARRANTY STATEMENT.....	40

## 1.0 INTRODUCTION





- The AE 402 indicator provides the user with the electronics necessary to build an accurate, fast, versatile weighing system.
- Functions are, weighing, check weighing, parts counting, animal weighing and percent weighing.
- The system includes automatic zero tracking, audible alarm for check-weighing, semi-automatic tare and an accumulation facility that allows the individual weights or counts to be stored and the total recalled.
- The scales have a bi-directional RS-232 interface for communicating with a PC or printer.
- RS-232 outputs include Real time Clock, English, German, French or Spanish language text and data required for GLP reports.
- The indicator can be used with 1- to 4 load cell platforms.
- Internal rechargeable battery and IP-65 rated enclosure allow for a fully portable and rigged weighing system.

## 2.0 SPECIFICATIONS

External resolution ratio	1/1000-1/30000
Non-linear error	±0.016% F.S
Range of signal input of the transducer	0-20mV
Load cell drive capacity	up to 4, 350Ω or 1000Ω load cells
Load cell excitation	+ 5V DC
Load Cell Connection	6 wire connection, 2 x excitation, 2 x sense, 2 x signal plus shield.
Calibration	Automatic External
Stabilisation Time	2 seconds typical
Power supply	6V 4Ah Rechargeable battery And AC/DC 12V 800mA adapter power;
Power consumption	0.1VA
Overall dimension	240 x 140 x 104 mm (including bracket)
Balance Housing	Indicator: IP 65 rated Stainless Steel
Net weight	2 kg
Operating temperature	0C-40C
Operating humidity	≤85% RH
Applications	General Purpose Weighing Scales
Functions	Weighing, Check weighing, Parts counting, Memory Accumulation, Animal weighing, Percent weighing
Display	6 digits, 40mm digit height LCD digital display with backlight
Weighing units	Grams, Kilogram, pound, ounce, pound/ounce; Newton;
Symbol indication	battery; stable; net weight; zero set; Animal Weighing; Hold
Interface	RS-232 bi-directional Interface

## 3.0 INSTALLATION

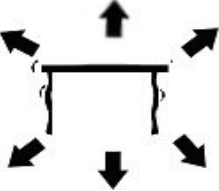
### 3.1 LOCATING THE SCALES

	<ul style="list-style-type: none"><li>• The scales should not be placed in a location that will reduce the accuracy.</li><li>• Avoid extremes of temperature. Do not place in direct sunlight or near air conditioning vents.</li></ul>
	<ul style="list-style-type: none"><li>• Avoid unsuitable tables. The table or floor must be rigid and not vibrate.</li></ul>
	<ul style="list-style-type: none"><li>• Avoid unstable power sources. Do not use near large users of electricity such as welding equipment or large motors.</li><li>• Do not place near vibrating machinery.</li></ul>
	<ul style="list-style-type: none"><li>• Avoid air movement such as from fans or opening doors. Do not place near open windows or air-conditioning vents.</li><li>• Keep the scales clean. Do not stack material on the scales when they are not in use.</li></ul>

### 3.2 LIST OF ACCESSORIES

Your packet contains-

- ✓ AC adapter
- ✓ Indicator
- ✓ Wall mount bracket and mounting hardware
- ✓ Instruction manual

### 3.3 SETTING UP THE SCALES

- Attach the power supply module to the connector on the side of the indicator. Press the **[On/Off]** key. The software revision number will be displayed followed by a self-test showing all digits before the zero is displayed along with the unit of weight that was selected last.

### 3.4 CONNECTIONS

#### 3.4.1 CONNECTION OF LOAD CELL

Please see figure 1

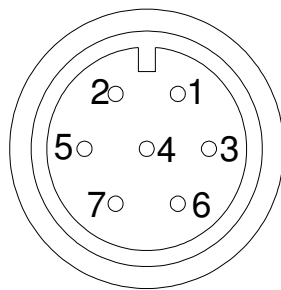

6: Pin +IN	+Signal
7: Pin -IN	-Signal
3: Pin AGND	Shield
1: Pin +E,	+Excitation
2: Pin +S	+Sense
4: Pin -E	-Excitation
5: Pin -S	-Sense

As viewed from the back of the indicator

#### Note:

For 4 wire load cell, connect the load cell +Excitation and +Sense together at the connector and -Excitation and -Sense together at the connector.

### 3.4.2 CONNECTION OF RS-232

RS-232 serial interface is a plug as figure 2 shows:

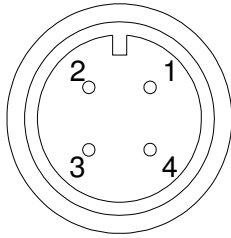

- 1: Pin GND, Signal Ground
- 2: Pin RXD, Received Data
- 3: Pin TXD, Transmitted Data

As viewed from the back of the indicator

See section 9 for details of the RS-232 Interface.

### 3.4.3 CONNECTION OF RELAY DRIVERS

The output to drive external relays is on the circuit board inside the enclosure. To gain access you must remove the 6 screws securing the front to the rear of the case. Pass the wires for the relays through the grommet on the rear panel. The wires will connect to the PCB using the terminal strip P1.

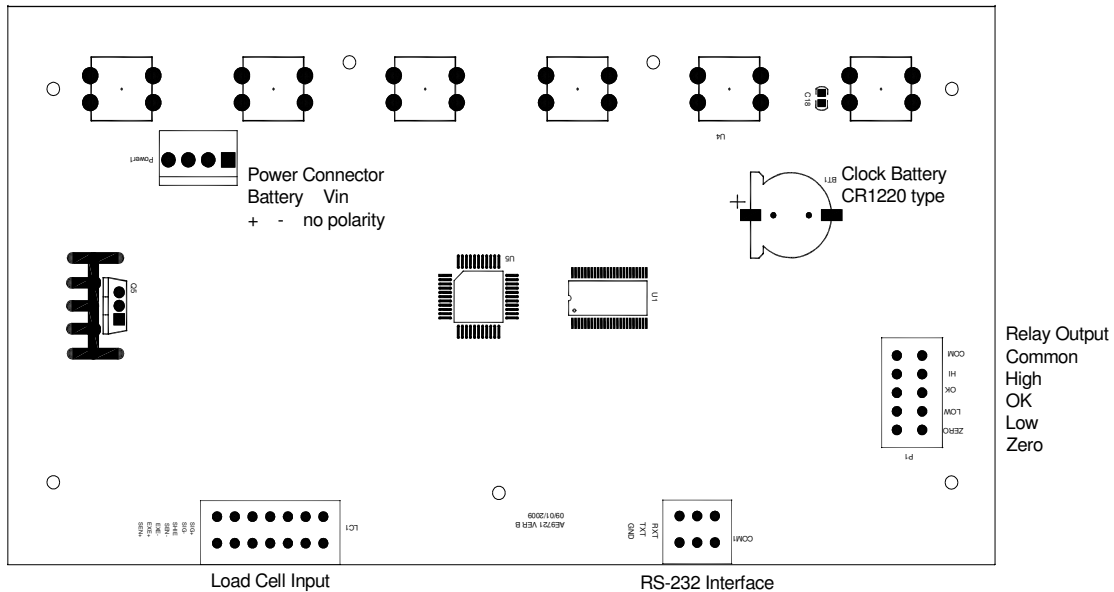



The circuit to control the relays requires an external voltage compatible with the relays used. For more information see section 10.

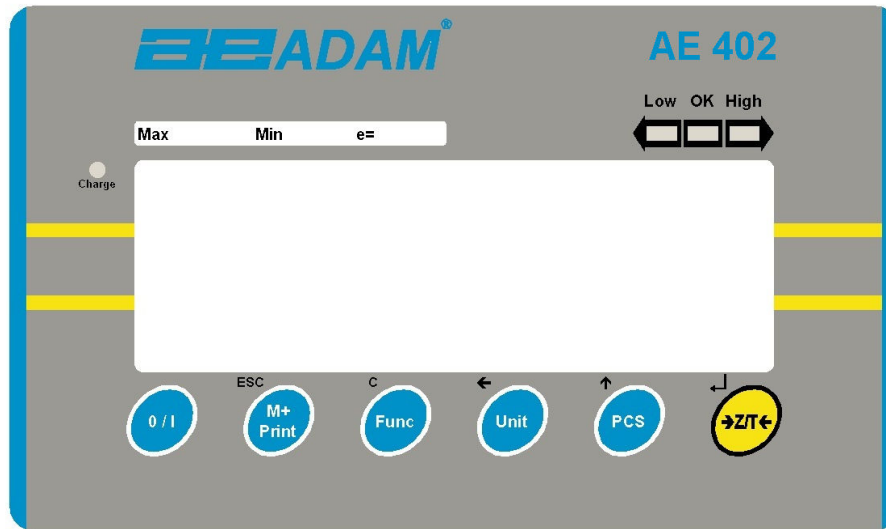

## 4.0 KEY DESCRIPTIONS



<p><b>[&gt;Z/T&lt;]</b></p>	<p>If near zero, Sets the zero point for all subsequent weighing. The display shows zero.</p> <p>Tares the scale. Stores the weight currently on the scale as tare value, subtracts the tare value from the gross weight and shows the results</p> <p>A secondary function,  is of "Enter" key used when setting up the value for the Parameters.</p>
<p><b>[Pcs/↑]</b></p>	<p>Selects parts counting. Used to set the sample quantities while parts counting.</p> <p>A secondary function,  is of incrementing the active digit when setting a value for Parameters.</p>
<p><b>[Unit/←]</b></p>	<p>Selects the weighing unit to be displayed from those which are enabled. See parameter S1 in section 7.4.</p> <p>A secondary function,  is to move the active/flashing digit to the left when setting values for Parameters.</p>

<b>[Func/C]</b>	<p>Selects the Functions of the scale. If the scale is weighing, it will select parts counting. If it is not in weighing mode, it will return the user to weighing.</p> <p>A secondary function (C) is to act as a clear key when setting values for Parameters.</p>
<b>[Print/M+/Esc]</b>	<p>Sends the results to a PC or a Printer using the RS-232 interface. It also adds the value to the accumulation memory if the accumulation function is not automatic.</p> <p>A secondary function (<b>ESC</b>) is to return to normal operation when the scale is in a Parameter setting mode.</p>
<b>[O/I]</b>	<p>To switch on and switch off the indicator.</p> <p>The AE402 will store the weighing unit in use and the check weighing values currently in memory when power is off.</p>

## 5.0 DISPLAYS

The LCD display will show a value and a unit to the right of the digits. In addition the LED's above the display will show when a weight is below or above check-weighing limits.

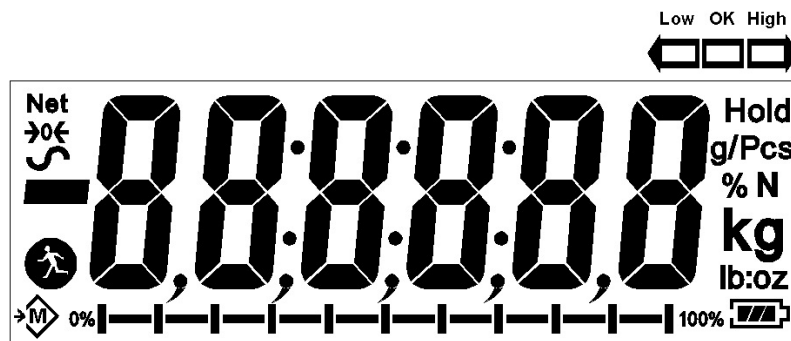

Other symbols will show when a weight has been tared (NET) the scale is at zero and stable, if a value has been stored in memory or when the animal weighing function has been enabled. A battery symbols will show the state of charge of the internal battery.

## 6.0 OPERATION

### 6.1 ZEROING THE DISPLAY

- You can press the [Z/T] key at any time to set the zero point. This will usually be necessary when the platform is empty. When the zero point is obtained the display will show an indicator for zero.



- The scale has an automatic re-zeroing function to account for minor drifting or accumulation of material on the platform. However you may need to press the [Z/T] key to rezero the scale if small amounts of weight are shown when the platform is empty.

### 6.2 TARING

- Zero the scale by pressing the [Z/T] key if necessary. The “ZERO” indicator will be ON.



- Place a container on the platform, a value for its weight will be displayed.

- Press the [Z/T] key to tare the scale. The weight that was displayed is stored as the tare value and that value is subtracted from the display, leaving zero on the display. The “NET indicator will be ON. As a product is added only the net weight of the product will be shown. The scale could be tared a second time if another type of product was to be added to the first one. Again only the weight that is added after taring will be displayed.



- When the container is removed a negative value will be shown. If the scale was tared just before removing the container this value is the gross weight of the container plus all products that was removed. The “ZERO” indicator will be on to indicate that the platform is back to the same condition as it was when zero was last set.
- To delete a Tare value, press [Z/T] when the pan is empty.

### 6.3 WEIGHING A SAMPLE

To determine the weight of a sample, first tare the empty container if it is to be used and then place the sample in the container. The display will show the net weight of the sample and the units of weight currently in use.



## 6.4 PARTS COUNTING

If parts counting is enabled, See section 7.4, it is possible to count parts using a sample of the parts to determine average piece weight.

- Before starting, tare the weight of any container that may be used, leaving the empty container on the scale. Place a known number of samples in the container, if used. The number should match the options for parts counting, i.e., 10, 20, 50, 100 or 200 pieces.
- When the scale is showing weight, pressing the [**Pcs/↑**] key will start the parts counting function.
- The scale will show “**P 10**” asking for a sample size of 10 parts. Change the sample size to the desired quantity by pressing the [**Pcs/↑**] key. It will cycle through the options: 10, 20, 50, 100, 200 and back to 10.



- Press the [**Z/T**] key again when the number matches the number of parts used as the sample. As more weight is added the display will show the number of parts (Pcs).



- Pressing the [**Unit/←**] key will display the unit weight (g/pcs), pressing it second time will display the net weight (pcs and kg) and the third time, it will be the count again (pcs).

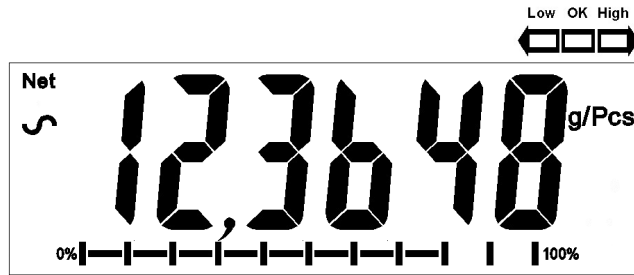

- Press the [Pcs/↑] key to return to normal weighing. Press the [Pcs/↑] key again to start counting a different sample.

## 6.5 CHECK-WEIGHING

Check-weighing is a procedure to cause lamps to come on (and if enabled, an alarm to sound) when the weight on the scale meets or exceeds values stored in memory. The memory holds the last values for a high and a low limit when the power is turned off. The user can set either one limit or both as described below.

See Section 7.1 for the procedure to set the limits. The limits can be set when the scale is in weighing or parts counting modes. After limits have been set the Check-weighing function is enabled.

When a weight is placed on the scale the LED's above the display will show if the weight is above or below the limits and the beeper will sound as described below, if the beeper is enabled (see section 7.1).

The relay outputs are open collector drivers to control an external relay. The relays will be active when the corresponding LED is on during check-weighing. The ZERO relay output will be on when the scale is showing the display is at Zero.

BOTH LIMITS SET	The display will show OK when the weight is between the limits	<p>F3 bEP = bP InL . The beeper will sound when the weight is between the limits, i.e. OK</p> <p>F3 bEP = bP OtL Beeper will sound if weight is outside the limits.</p>
LOW LIMIT SET HIGH LIMIT is set to zero	The display will show LOW when the weight is less than the Low Limit. Above the Low Limit the display will show OK,	<p>F3 bEP = bP InL . The beeper will be off when the weight is less than the Low Limit. Above the Low Limit the beeper will be on</p> <p>F3 bEP = bP OtL The beeper will be on sound when the weight is below the Low Limit</p>
HIGH LIMIT SET LOW LIMIT is set to zero	The display will show OK when the weight is less than the High Limit. Above the High Limit the display will show HIGH	<p>F3 bEP = bP InL . The beeper will be on when the weight is less than the High Limit. Above the High Limit the beeper will be off.</p> <p>F3 bEP = bP OtL The beeper will be off when the weight is below the High Limit, on when it is above the High limit.</p>
BOTH LIMITS SET. LOW IS SET GREATER THAN HIGH	This condition is not allowed.	

**NOTE:** Weight must be more than 20 scale divisions for check weighing to operate. Below 20 scale divisions the LED's will not light and the beeper will not be on.

The Check-weighing function can be set up during Weighing or Parts Counting by entering values as Low or/and High Limits keyed in by the user. The limits are displayed in **kg (or Lb)** or **pcs** respectively.



Checkweighing during Parts Counting

To disable the Check-Weighing function enter zero into both limits by pressing the **[Func/C]** key when the current limits values are displayed during the setting procedure, then pressing **[Z/T]** to store the zero values.

The values set for the check-weighing will remain in memory when the weighing units or the function changes to parts counting but will not be active. The will become active again when the weighing unit or parts counting that was active at the time the limits were set is reactivated.



## 6.6 ACCUMULATED TOTAL

- The scale can be set to accumulate manually by pressing the **[Print/M+/Esc]** key or automatically when a weight is removed from the scale. See the Section 7.3 for details of setting the Parameter “**C3 PRM**” and “**C4 Aon**”. The accumulation function is available when weighing or when counting parts. However the memory is cleared if the weighing units or functions are changed.
- When the weight (or count) displayed is stored in memory the display will show “**ACC 1**” and then the total in memory for 2 seconds before returning to weighing. The RS-232 interface will output to a printer or PC.
- Remove the weight, allowing the scale to return to zero and put a second weight on. When this value is stored, the display will show “**ACC 2**”, then the new total and finally the value of the second weight. Repeat as necessary to add all the values needed to the memory.
- To view the total in memory press the **[Print/M+/Esc]** key when there is no weight on the scale. The display will show the number of entries and the total.
- To clear the memory (set the value to zero) press the **[Func/C]** key during the time the totals are being displayed.

## 6.7 PERCENT WEIGHING

The scale can be set to perform percent weighing. See Section 7.2.

The scale will use a mass on the platform as the 100% reference weight. If the platform is empty (or the scale is tared) then the user can input a reference weight using the keypad.

- Press [Func/C]. The first option is **“Func 1”**, press the [Func/C] key again display **“Func 2”**.



- Press the [Z/T] key. **“P1 Pct”** will be displayed.



- Press [Z/T] again to enter percent weighing. The scale will set the sample mass on the platform as 100% reference weight.



- Remove the sample weight. Then any other weight placed on the scale will be displayed as a percentage of the original sample. For example, if 3500g is placed on the scale and percent weighing is selected, the display will show 100.0%. Remove the 3500g weight and place a 3000g weight. The display will show 85.7% as 3000g is 85.7% of 3500g.



- The number of decimal points will depend on the weight used in comparison to the capacity of the system. A smaller weight will show only “**100%**” while a larger weight might show “**100.00%**”.
- If the scale was showing zero weight when entering this function, then the user must manually enter the weight to be set as 100% as described below.
- Press the [Z/T] key. “**P1 Pct**” will be displayed.
- Press [Z/T] again to enter percent weighing. The scale will now accept a value the user enters as the reference weight.
- Enter the value using the [Unit/←] key and [Pcs/↑] key to set the values of the 100% mass.
- When set press the [Z/T] key to store the value. The display will show “**0.00 %**”.
- The weight entered must be greater than 50 scale divisions.
- Press [Unit/←] to return to weighing.

**NOTE:**

The display may jump by large numbers unexpectedly if small weights are used to set as 100% reference. The scale checks if the weight is too small and will show Error 7.

## 6.8 ANIMAL (DYNAMIC) WEIGHING

The scale can be set to animal (dynamic) weighing for weighing any items that are unstable or may move. See Section 7.4.

The scale will use a special filter to minimise the effects of any movement while the moving animal or unstable samples are on the scale.

- Press **[Func/C]**. The first option is **"Func 1"**, press the **[Func/C]** key again to display **"Func 2"**.



The image shows a digital display with the text "Func 2" in a large, black, monospaced font. The characters are slightly spaced out, and the background is white.

- Press the **[Z/T]** key. **"F2 Pct"** will be displayed. Press the **[Pcs/↑]** key to advance to the second function, **"P2 AnL"**, Animal weighing.



The image shows a digital display with the text "P2 AnL" in a large, black, monospaced font. The characters are slightly spaced out, and the background is white.

- Press **[Z/T]** to enter animal weighing. The scale will change to animal weighing and allow weighing of an unstable animal or sample on the platform.
- To use the Animal Weighing function it is necessary to set the amount of filtering required for the item to be weighed. More active animals will require a higher level of filtering to give a stable result. The display will show **"Flt x"** where x is a value from 1 to 5. The higher the value the greater the amount of filter will be. To increment the value shown press the **[Pcs/↑]** key then press the **[Z/T]** key to accept it.
- The display will flash **"Ani "** 2 times then show the current weight, 0.00. The scale is now ready to weigh.

## 6.8.1 ANIMAL WEIGHING PROCEDURE

- With the platform empty the display will show zero weight. Place containers or blankets onto the platform and press the **[Z/T]** key to zero the display. The scale may go into the animal (dynamic) weighing procedure when the items are placed on the scale but will return to showing zero when the **[Z/T]** key is pressed.
- Place the animal or sample to be weighed on the platform.
- The display will show the Animal/Dynamic weighing symbol  until a stable weight is determined. The time it takes for the stable value will depend upon the setting of the filter parameter in the first step.
- When a stable reading is found, the display will show this value, and the display will be locked until the **[Z/T]** key is pressed. The display will show the **“Hold”** symbol while the display is locked.



- To weigh a second subject press the **[Z/T]** key if necessary to zero the display, and place the next animal on the scale. The scale will detect the new weight and hold it as before.
- The scale will remain in the animal weighing mode until the **[Unit/←]** key is pressed. Then it will return to normal weighing.

## 7.0 USER PARAMETERS

Pressing the **[Func/C]** key during normal operation allows the user to access the parameters for customizing the scale. The parameters are split into 4 groups-

1. Check weighing parameters,
2. Percent and Animal Weighing Functions
3. RS-232 parameters and
4. Scale parameters

- When **[Func/C]** is pressed, display will first show **"Func 1"** for Check weighing parameters.
- Press either the **[Func/C]** key or the **[Pcs/↑]** to advance through the groups **"Func 1"**, **"Func 2"**, **"Func 3"** and **"Func 4"**. Press **[Z/T]** to enter the desired group of parameters.
- When in one of the sections press **[Print/M+/Esc]** to return to the group **"Func 1"**. If you press **[Print/M+/Esc]** again, the scale will exit the User Parameter section and return to normal weighing.

### 7.1 CHECK WEIGHING PARAMETERS

- Press **[Z/T]** to enter the group.
- Use the **[Unit/←]** key and **[Pcs/↑]** key to set the values or just the **[Pcs/↑]** key to select the options.
- Press **[Z/T]** to confirm the change and then advance to the next parameter by pressing the **[Pcs/↑]** key.

This group of parameters-

- Set low and high limits for check-weighing
- Enables or disables the check weighing alarm
- Enables or disables the negative check weighing

Parameter	Description	Options	Default setting
<b>F1 Lo</b>	Set Low limit.	Use the <b>[Unit/←]</b> key and <b>[Pcs/↑]</b> key to set the values of the lower limit. When set press the <b>[Z/T]</b> key to store the value and go to <b>F2 Hi</b>	<b>000000</b>
<b>F2 Hi</b>	Set High limit.	Use the <b>[Unit/←]</b> key and <b>[Pcs/↑]</b> key to set the values of the high limit. When set press the <b>[Z/T]</b> key to store the value and go to <b>F3 bEP</b>	<b>0000000</b>
<b>F3 bEP</b>	This parameter sets the Beeper to off or on. If set to on, the beeper can further be set to sound when the weighing result is within or outside the check-weighing limits.	bP oFF - Off bP inL - Within limits bP otL - Outside limits (>20d)	<b>bP inL</b>
<b>F4 nCK</b>	This parameter enables negative check weighing function with ability to do negative tare.	on oFF	<b>on</b>

## 7.2 PERCENT WEIGHING AND ANIMAL WEIGHING

See section 6.7 and 6.8 for details of these special weighing modes.

- Press **[Z/T]** to enter a parameter. Use the **[Unit/←]** key and **[Pcs/↑]** key to set the values or just the **[Pcs/↑]** key to select the options.
- Press **[Z/T]** to confirm the change and then advance to the next parameter by pressing the **[Pcs/↑]** key.

- Press **[Print/M+/Esc]** to return to the group **“Func 2”**. If you press **[Print/M+/Esc]** again, the scale will exit the User Parameter section and return to weighing.

Parameter	Description	Options	Default setting
<b>P1 Pct</b>	This parameter allows the user to enter the Percent weighing Function. See Section 6.7.	None	Enabled always
<b>P2 AnL</b>	Enter the Animal Weighing mode of operation, See section 6.8	Set the filter value.	Enabled Always

### 7.3 RS-232 PARAMETERS

- Press **[Z/T]** to enter a parameter. Use the **[Unit/←]** key and **[Pcs/↑]** key to set the values or just the **[Pcs/↑]** key to select the options.
- Press **[Z/T]** to confirm the change and then advance to the next parameter by pressing the **[Pcs/↑]** key.
- Press **[Print/M+/Esc]** to return to the group **“Func 3”**. If you press **[Print/M+/Esc]** again, the scale will exit the User Parameter section and return to weighing.

This group of parameters can be set by the user for setting the RS-232 active or not, baud rate, printing mode, accumulation mode, RS-232 language, and user or scale ID numbers.

Parameter	Description	Options	Default Values or setting
<b>C1 on</b>	Enable or disable the RS-232 interface	<b>Prt on</b> <b>Prt off</b>	<b>Prt on</b>
<b>C2 bd</b>	Baud Rate	<b>600</b> <b>1200</b> <b>2400</b> <b>4800</b> <b>9600</b> <b>19200</b>	<b>9600</b>



<b>C3 PrM</b>	Printing Mode- Manual, Continuous or Automatic	<b>mAn</b> , <b>Cont</b> (not on EC approved scales) <b>AUto</b>	<b>mAn</b>
<b>C4 Aon</b>	Enable or disable the Accumulation	<b>AC on</b> <b>AC off</b>	<b>AC on</b>
<b>C5 Ln</b>	Select Language	<b>EnGLi</b> (English) <b>FrEnCH</b> (French) <b>GErmAn</b> (German) <b>SPAn</b> (Spanish)	<b>EnGLi</b>
<b>C6 Uld</b>	Set User ID	To be entered manually	<b>000000</b>
<b>C7 Sid</b>	Set Scale ID	To be entered manually	<b>000000</b>

Scale will perform the following, depending on the Accumulation and Print Settings:

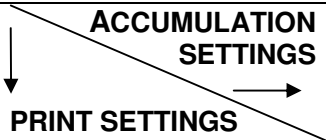
	<b>AC on</b>	<b>AC Off</b>
<b>AUto</b>	Accumulate and print automatically	Print automatically, Do not accumulate
<b>mAn</b>	Accumulate and Print only when <b>[Print/M+/Esc]</b> key pressed. If <b>[Print/M+/Esc]</b> is pressed a second time only print the weight.	Print when <b>[Print/M+/Esc]</b> key is pressed, Do not accumulate.
<b>Cont</b> Not available on approved scales	Print continuously. Accumulate when <b>[Print/M+/Esc]</b> key is pressed	Print continuously. Do not accumulate.

#### 7.4 SCALE PARAMETERS

- Press **[Z/T]** to view the list of parameters.
- Press **[Z/T]** to enter a parameter. Use the **[Unit/←]** key and **[Pcs/↑]** key to set the values or just the **[Pcs/↑]** key to select the options.
- Press **[Z/T]** to confirm the change and then advance to the next parameter by pressing the **[Pcs/↑]** key.
- Press **[Print/M+/Esc]** to return to the group **“FUNC 4”**. If you press **[Print/M+/Esc]** again, the scale will exit the User Parameter section and return to normal weighing.

This group of parameters is used to control the operation of the scale.

Parameter	Description	Options	Default setting
<b>S1 Un</b>	Enable or disable weighing units, will not allow to disable all units, at least one has to be enabled. Parts counting can be enabled/disabled	<b>Kg</b> <b>Grams</b> <b>lb</b> <b>oz</b> <b>lb:oz</b> <b>N (Newtons)</b> <b>PCS</b>	<b>Kg</b>
<b>S2 bl</b>	Backlight set to always on, always off or automatic on whenever a weight is placed or a key is pressed	<b>EL off</b> <b>EL on</b> <b>EL AU</b>	<b>EL AU</b>
<b>S3 AoF</b>	Auto Off- Disable or set time increment to turn off scale	<b>SLP 0</b> <b>SLP 1</b> <b>SLP 5</b> <b>SLP 10</b>	<b>SLP 0</b>
<b>S4 dt</b>	Set Time and Date format and settings. Format for date can be changed when the display shows mmddyy, ddmmyy or yymmdd by pressing the <b>[Pcs/↑]</b> key, then enter the date.	Enter the time manually.  Enter the date format and then the numeric value manually.	<b>00:00:00</b>  <b>mm:dd:yy</b>
<b>S5 diS</b>	Display all weights or only when stable	<b>ALL</b> <b>StAb</b>	<b>ALL</b>
<b>S6 Fi</b>	Filter setting to slow, normal or fast	<b>Slow</b> <b>nor</b> <b>FAST</b>	<b>nor</b>
<b>S7 SPS</b>	Password	Enter new pass word twice,, controls access to Func 1 to Func 4	Not active
<b>S8 CAL</b>	Calibration	Calibrate the scale. See Section 11.0	-

## **8.0 BATTERY OPERATION**

- The scales can be operated from the battery if desired. The battery life can be up to 70 hours depending on the load cells used and how the backlight is used.
- When the battery needs charging a symbol on the display will show less bars in the battery symbol. The battery should be charged when only the battery outline is on. Once the bars have been turned off the scale will still operate for a short time after which it will automatically switch off to protect the battery.
- To charge the battery, simply plug the adaptor into the mains power. The scale does not need to be turned on.
- The battery should be charged for 12 hours for full capacity.
- Near the display is an LED to indicate the status of battery charging. When the scale is plugged into the mains power the internal battery will be charged. If the LED is green the battery has a full charge. If it is Red the battery is nearly discharged and yellow indicates the battery is being charged.

## 9.0 RS-232 INTERFACE

The AE 402 indicator is supplied with bi-directional RS-232 interface as standard. The scale when connected to a printer or computer outputs the weight with the selected weighing unit through the RS-232 interface.

Specifications:

RS-232 output of weighing data

ASCII code

9600 Baud (user selectable)

8 data bits

No Parity

RS-232 serial interface is a plug as figure 2 shows:

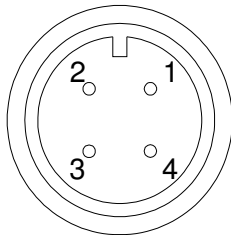

- 1: Pin GND, Signal Ground
- 2: Pin RXD, Received Data
- 3: Pin TXD, Transmitted Data

As viewed from the back of the indicator

The scale can be set to print text in English, French, German or Spanish. See the RS-232 parameters section for details.

### Data Format-Normal Output:

```
<cr><lf>
<cr><lf>
Date          12/09/2006 <cr><lf>
Time          14:56:27  <cr><lf>
<cr><lf>
Scale ID      123456   <cr><lf>           If ID is zero, it is left blank
User ID       234567   <cr><lf>
<cr><lf>
Net Wt        1.234 Kg <cr><lf>           Net Wt. (or Gross Wt.)
<cr><lf>
<cr><lf>
<cr><lf>
<cr><lf>
```

Only weight value along with the weighing unit is printed. If Percent weighing is used then % is shown in place of weighing units.

### Data Format-Parts Counting Output:

Weight, Unit weight and number of parts are printed.

```
<cr><lf>
<cr><lf>
Date          12/09/2006 <cr><lf>
Time          14:56:27  <cr><lf>
<cr><lf>
Scale ID      123456   <cr><lf>
User ID       234567   <cr><lf>
<cr><lf>
Net Wt.       1.234 Kg <cr><lf>           Net Wt. (or Gross Wt.)
Unit Wt.      123 g    <cr><lf>           g for metric and lb for pounds
PCS           10 pcs  <cr><lf>
<cr><lf>
<cr><lf>
<cr><lf>
<cr><lf>
```

### Data Format- Memory Recall Output:

```
<cr><lf>
Date          12/09/2006 <cr><lf>
Time          14:56:27  <cr><lf>
<cr><lf>
Scale ID      123456  <cr><lf>
User ID      234567  <cr><lf>
<cr><lf>
-----<cr><lf>
TOTAL
No.           5      <cr><lf>
Wt.          1.234 Kg <cr><lf>
<cr><lf>
PCS           10 pcs <cr><lf>
-----<cr><lf>
<cr><lf>
```

### Data Format- Continuous Output- Normal weighing:

```
ST,GROSS  1.234 Kg <cr><lf>
US,NET    0.000 Kg <cr><lf>
```

ST or US for STable or UnStable,  
NET or GROSS for Net Weight  
or Gross wt. and the weighing unit, kg, lb etc.

### Data Format- Continuous Output- Parts Counting:

```
ST Net    1.234 Kg <cr><lf>
U.W.     123 g   <cr><lf>
PCS      10 pcs <cr><lf>
<cr><lf>
<cr><lf>
```

Net Weight (or Gross wt.)  
Kg and g for metric and Lb for pounds

### NOTE:

1. The accumulated total will not be sent to the RS-232 when the continuous print is turned on.
2. The continuous print will only be for the current weight and the display data.
3. In other languages the format is the same but the text will be in the language selected.

Description	ENGLISH	FRENCH	GERMAN	SPANISH
Net weight	<b>Net Wt.</b>	<b>Pds Net</b>	<b>Net-Gew</b>	<b>Pso Net</b>
Weight per unit counted	<b>Unit Wt.</b>	<b>Pds unit</b>	<b>Gew/Einh</b>	<b>Pso/Unid</b>
Number of items counted	<b>Pcs</b>	<b>Pcs</b>	<b>Stck.</b>	<b>Piezas</b>
Number of weighing added to subtotals	<b>No.</b>	<b>Nb.</b>	<b>Anzhl</b>	<b>Num.</b>
Total weight and count printed	<b>Total</b>	<b>Total</b>	<b>Gesamt</b>	<b>Total</b>
Print date	<b>Date</b>	<b>Date</b>	<b>Datum</b>	<b>Fecha</b>
Print time	<b>Time</b>	<b>Heure</b>	<b>Zeit</b>	<b>Hora</b>
Scale ID number	<b>Scale ID</b>	<b>Bal ID</b>	<b>Waagen ID</b>	<b>Bal ID</b>
User ID Number	<b>User ID</b>	<b>Util ID</b>	<b>Nutzer ID</b>	<b>Usuario ID</b>

### 9.1 INPUT COMMANDS FORMAT

The scale can be controlled with the following commands. Press the **[Enter]** key of the PC after each command.

<b>T&lt;cr&gt;&lt;lf&gt;</b>	Tares the scale to display the net weight. This is the same as pressing <b>[Z/T]</b> .
<b>Z&lt;cr&gt;&lt;lf&gt;</b>	Sets the zero point for all subsequent weighing. The display shows zero.
<b>P&lt;cr&gt;&lt;lf&gt;</b>	Prints the results to a PC or printer using the RS-232 interface. It also adds the value to the accumulation memory if the accumulation function is not set to automatic.

## 10.0 RELAY INTERFACE

The AE 402 indicator is supplied with drivers to control external relays. The drivers could be used to control a number of different relays depending upon the users need. The relay drivers are isolated outputs requiring the use of an external power supply for the relays. Also see section 3.4.3.

Contact Adam Equipment or your supplier for a relay interface that is compatible with the relay drivers, however other interfaces can be used as long as the following conditions apply.

Connections to the drivers:

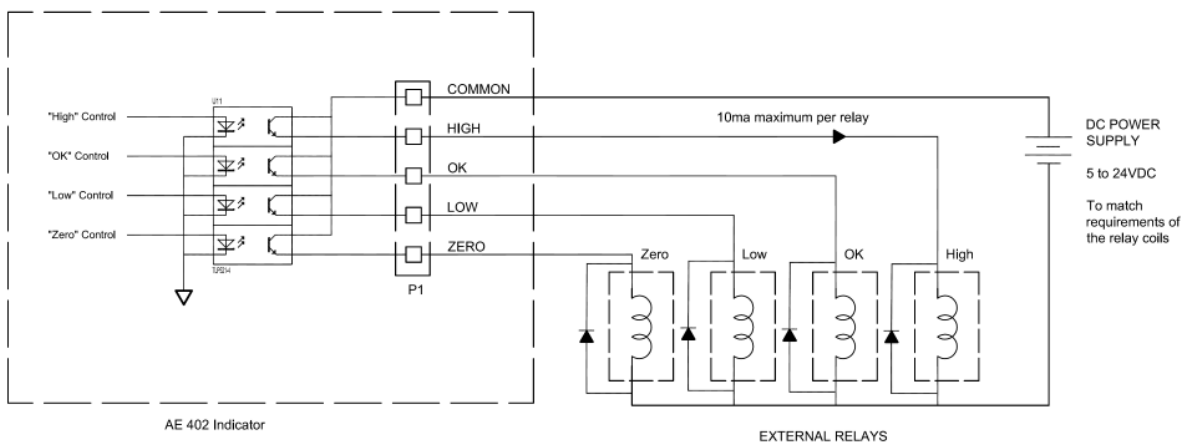

Connections are made to the PCB, Connector P1. The connector is a spring activated type, simply press on the top of the connector and insert the wire.

Do not exceed the safe limits of voltage or current of 24VDC or 15ma per output.

Depending upon the application it may be necessary to use a small relay to drive larger relays, or to provide additional protection to prevent electromagnetic interference (diodes as shown above) to this or other machinery.



## 11.0 CALIBRATION

The scale can be calibrated using the following procedure. To enter this procedure it is necessary to use Func 4 accessible using the **[Func/C]** key as described in section 7.4 or using the password access as described in section 12.

The AE 402 scales calibrate using either metric or pound weights, depending on the weighing unit in use before calibration. The display will show either "kg" or "lb" to identify the weights expected.

### PROCEDURE

- Enter the calibration section using Func 4, C8 CAL or using the password as described in section 12.
- The display will show "**unLoAd**".
- Remove any weight from platform, when the stable symbol is on press **[Z/T]**.
- The display will show "**Ld**" the "**0000XX**" to show the last calibration weight used. Place this calibration weight on the scale. Press the **[Z/T]** key. If the weight you put on the scale does not match the value displayed, press the **[Func/C]** key to clear the value then use the **[Unit/←]** key and **[Pcs/↑]** key to set the correct value. When it is correct press **[Z/T]**.
- If the calibration is acceptable the scale will run a self-test during which the calibration weight should be removed. If an error message "**FAIL L**" is shown try calibration again as a disturbance may have prevented a successful calibration.

After calibration the scale should be checked to verify the calibration is correct. If necessary repeat calibration, make sure that the scale is stable before accepting any weight.

## 12.0 SERVICE SECTION

The scales will allow entry to the parameters if the **[Tare]** key is pressed during the power on cycle. The passwords work as above.

In this case the display will show the passcode request screen, “**P - - - -**”. To continue enter a passcode as described below.

Entering passcode 0000 will allow calibration as shown in section 11.

Entering 1000 will allow access to a limited set of parameters described in section 12.1.

Entering the passcode 2006 will allow access to all parameters as shown in section 12.3.

### **12.1 USING “1000” TO ENTER THE SERVICE PARAMETERS**

Press the **[Z/T]** key during the display counting when turned on,

When “**Pn**” is displayed, enter the number 1000 using the **[Unit/←]** and **[Pcs/↑]** keys and then press **[Z/T]**.

The displays will show the first parameters, called “**F4 Int**”.

To select another parameter press the **[Pcs/↑]** key to advance through the parameters.

Press the **[Z/T]** key to enter a parameter.

To exit a parameter, press the **[Print/M+/Esc]** key.

The display will show the parameter number and a name.

When a parameter is entered by pressing the **[Z/T]** key, the displays will guide you through the parameter selected and the options available.

The parameters available are:

<b>"F4 Int"</b>	Initial Zero Range
<b>"F5 rEZ"</b>	Re-Zero range
<b>"F6 SCS"</b>	Successive Tare Enable
<b>"F7 Cnt"</b>	Display the A/D counts
<b>"F8 Zem"</b>	Zero Mode
<b>"F9 Lvd"</b>	Low voltage detection
<b>"FA AZn"</b>	Auto Zero Range
<b>"Fb FPS"</b>	User Function Password

The description of the parameters is shown in section 12.3

### **12.2 USING "2006" TO ENTER THE SECURE PARAMETERS**

Press the **[Z/T]** key during the display counting when turned on,

When **"Pn "** is displayed, enter the number 2006 using the **[Unit/←]** and **[Pcs/↑]** keys and then press **[Z/T]**. The displays will show the first parameters, called **"F1"** **"CAL"**.

To select another parameter press the **[Pcs/↑]** key to advance through the parameters.

Press the **[Z/T]** key to enter a parameter.

To exit a parameter, press the **[Print/M+/Esc]** key.

The display will show the parameter number and a name.

When a parameter is entered by pressing the **[Z/T]** key, the displays will guide you through the parameter selected and the options available.

The parameters available are:

<b>"F1 CAL"</b>	To enter the Calibration
<b>"F2 dEC"</b>	Decimal Point Position
<b>"F3 CAP"</b>	Default Weighing Unit and capacity
<b>"F4 Int"</b>	Initial Zero Range
<b>"F5 rEZ"</b>	Re-Zero range
<b>"F6 SCS"</b>	Successive Tare Enable
<b>"F7 Cnt"</b>	Display the A/D counts
<b>"F8 Zem"</b>	Zero Mode
<b>"F9 Lvd"</b>	Low voltage detection
<b>"FA AZn"</b>	Auto Zero Range
<b>"Fb FPS"</b>	User Function Password

## 12.3 PARAMETER DETAILS

### 12.3.1 F1 -CALIBRATION

To enter the calibration parameter, press the [Z/T] key when “F1” is displayed. The scale will be calibrated using 2 masses of approximately 1/3Maximum and Maximum. If the scale has been calibrated once the values will be stored. If this is the first time the scale is calibrated the user must enter the values for the calibration masses.

NOTE: It is necessary to set the decimal point location and the capacity before calibration is possible.

The display will instruct you to remove any weight from the scale, “UnloAd”. Press [Z/T].

The display will tell you to add the first weight to the scale: “Ld 1” “ 10 kg” If necessary change the value shown to match the weight to be used. Press [CE] to clear the old value and then enter the new value. All values entered are in whole numbers only.

Add the weight shown, wait for stability then press the [Z/T] key.

The display will tell you to add the second weight to the scale: “Ld 2” “ 30 kg”

Either add the weight shown, wait for stability then press the [Z/T] key or press the [Print/M+/Esc] key to accept the single point calibration and return to weighing.

The display will show “PASS” if the calibration is OK.

Remove the weight.

### 12.3.2 F2–DECIMAL POINT POSITION

To set the value for the decimal point location. The options are 0, 0.0, 0.00, 0.000, 0.0000

To enter this parameter, press the [Z/T] key when “F2 dEC” is shown.

The display will show the current setting.

Press the [Pcs/↑] key to change the value. Select from 0, 0.0, 0.00, 0.000, 0.0000

Press [Z/T] to accept the displayed value.

### 12.3.3 F3 – CAPACITY/ WEIGHING UNIT/INCREMENT

To enter this parameter, press the [Z/T] key when “**F3 CAP**” is shown. The display will show the current capacity and default weighing unit. Enter the numeric values using the [Unit/←] and [Pcs/↑] keys. The scale will check the number of division’s  $n = \text{maximum/increment}$  is less than 30,000 divisions. (3000 divisions for EC approved versions).

To select the weighing unit press the [Unit/←] until the default weighing unit is flashing, either kilogram (kg) or pounds (lb).

Press [Z/T] to accept the displayed value.

On non-approved versions the display then lets you select the increment, “**Inc 2**” For example 100kg x 0.01kg the increment is 10grams, but the last digit increments by 1.

The display will show the current increment value as used with the current decimal point position.

Press the [Pcs/↑] key to change the value. Select from 1, 2, 5, 10, 20 or 50

Not all increments may be available for the capacity you selected.

For EC Approved versions the scale will determine the increment that maintains the number of divisions to be 3000 or less.

Press [Z/T] to accept the displayed value.

Press [Print/M+/Esc] to return to weighing.

### 12.3.4 F4 –INITIAL ZERO RANGE

To enter this parameter, press the [Z/T] key when “**F4 int**” is shown.

The display will show the current initial zero range.

Press the [Pcs/□] key to change the value and press [Z/T] to accept the value.

Press [Print/M+/esc] to return to weighing.

### 12.3.5 F5 -RE-ZERO RANGE

To enter this parameter, press the [Z/T] key when “**F5 rEZ**” is shown.

The display will show the current re-zero range.

Press the [Pcs/↑] key to change the value.

Press [Z/T] to accept the value.

Press [Print/M+/esc] to return to weighing.

### 12.3.6 F6 -SUCCESSIVE TARE

To enter this parameter, press the [Z/T] key when “**F6 SCS**” is shown.

The display will show if the successive tare is on or off.

Press the [Pcs/↑] key to change the value.

Press [Z/T] to accept the displayed value.

Press [Print/M+/Esc] to return to weighing.

### 12.3.7 F7 –ADC COUNTS

To enter this parameter, press the [Z/T] key when “**F7 Cnt**” is shown.

This parameter allows you to view the A/D counts from the internal A/D converter.

This can be an aid to service.

Press the [Z/T] key to return to the PARAMETER menu.

Press the [Print/M+/Esc] key to return to weighing.

Typical value at zero is 30,000-90,000 (approx.).

Typical value at full capacity is 500,000 (approx.).

### 12.3.8 F8 –ZERO MODE

To enter this parameter, press the [Z/T] key when “**F8 ZEm**” is shown.

Select the Zero mode desired. In all but special cases Zero Mode 1 is used. The other 2 zero modes are for unique locations in the world and effect the +/- range of the zero.

Press the [Pcs/↑] key to change the value.

Press [Z/T] to accept the displayed value.

Press [Print/M+/Esc] to return to weighing.

### 12.3.9 F9 –LOW VOLTAGE DETECTION

This parameter allows detection of low voltage when the battery wears down.

To enter this parameter, press the [Z/T] key when “**F9 Lvd**” is shown.

The display will show if the LVD Mode is set to on or off.

Press the [Pcs/↑] key to change the value.

Press [Z/T] to accept the displayed value.

Press [Print/M+/Esc] to return to weighing.

### 12.3.10 FA –AZn Auto Zero Range

This parameter sets the auto zero range from 0 (Off) to 4d.

Calibration and parameter counting function to be active. To enter this parameter, press the [Z/T] key when “**FA AZn**” is shown.

The display will show if the current Auto Zero range.

Press the [Pcs/↑] key to change the value.

Press [Z/T] to accept the displayed value.

Press [Print/M+/Esc] to return to weighing.

### 12.3.11 Fb –FPS User Function Password

This parameter set a password to control access to the user functions as described in Section 7. If the password is set to 0000 the control is disable and the user has free access to the functions.

To enter this parameter, press the [Z/T] key when “**Fb FPS**” is shown.

The display will show “**P1----**” Enter the new password code followed by [Z/T] to accept.

The display will then show “**P2----**” Enter the new password code again followed by [Z/T] to accept. The same code number must be entered both times for the password to be set.

Press the [Unit/←] and [Pcs/↑] keys to enter the values.

Press [Print/M+/Esc] to return to weighing.

## 13.0 ERROR CODES

ERROR CODES	DESCRIPTION	SUGGESTIONS
<b>--OL--</b>	Over-range	<p>Remove weight from the scale.</p> <p>If the problem persists contact your dealer or Adam Equipment for assistance.</p>
<b>Err 1</b>	Time Setting Error	<p>Enter time using correct format and reasonable values. Format: hh:mm:ss</p>
<b>Err 2</b>	Date Setting Error	<p>Enter date using correct format and reasonable values. Format: yy:mm:dd</p>
<b>Err 4</b>	Zero Setting Error	<p>The scale was outside the normal zero setting range either when it was turned on or when the <b>[Zero]</b> key was pressed.</p> <p>Remove weight from the scale and try re-zeroing again. Use the <b>[Z/T]</b> key to set the display to zero value.</p> <p>If the problem persists contact your dealer or Adam Equipment for assistance.</p>
<b>Err 6</b>	A/D out of range	<p>The values from the A/D converter are outside the normal range.</p> <p>Remove the weight from the scale if overloaded. Make sure the pan is attached.</p> <p>Indicates the load cell or the electronics may be faulty. If the problem persists contact your dealer or Adam Equipment for assistance.</p>
<b>Err 9</b>	Check weigh limits error	<p>Shown if the low limit is set higher than the current high limit. Reset High limit or different low limit.</p>
<b>FAIL</b>	Calibration error.	<p>Improper calibration (should be within <math>\pm 10\%</math> of the factory calibration). The old calibration data will be retained until the calibration process is complete.</p> <p>If the problem persists contact your dealer or Adam Equipment for assistance.</p>



## 14.0 REPLACEMENT PARTS AND ACCESSORIES

If you need to order any spare parts and accessories, contact your supplier or Adam Equipment. A partial list of such items is as follows-

<ul style="list-style-type: none"> <li>• Power Supply Module</li> <li>• Replacement Battery</li> </ul>	<ul style="list-style-type: none"> <li>• Printer, etc.</li> </ul>
--	---

## 15.0 SERVICE INFORMATION

This manual covers the details of operation. If you have a problem with the scale that is not directly addressed by this manual then contact your supplier for assistance. In order to provide further assistance, the supplier will need the following information which should be kept ready:

### A. Details of your company

-Name of your company:

-Contact person's name:

-Contact telephone, e-mail,

fax or any other methods:

### B. Details of the unit purchased

(This part of information should always be available for any future correspondence. We suggest you to fill in this form as soon as the unit is received and keep a print-out in your record for ready reference.)

<b>Model name of the scale:</b>	
<b>Serial number of the unit:</b>	
<b>Software revision number</b> <b>(Displayed when power is first turned on):</b>	
<b>Date of Purchase:</b>	
<b>Name of the supplier and place:</b>	

## **16.0 WARRANTY STATEMENT**

Adam Equipment offers Limited Warranty (Parts and Labour) for the components failed due to defects in materials or workmanship. Warranty starts from the date of delivery.

During the warranty period, should any repairs be necessary, the purchaser must inform its supplier or Adam Equipment Company. The company or its authorised Technician reserves the right to repair or replace the components at any of its workshops depending on the severity of the problems. However, any freight involved in sending the faulty units or parts to the service centre should be borne by the purchaser.

The warranty will cease to operate if the equipment is not returned in the original packaging and with correct documentation for a claim to be processed. All claims are at the sole discretion of Adam Equipment.

This warranty does not cover equipment where defects or poor performance is due to misuse, accidental damage, exposure to radioactive or corrosive materials, negligence, faulty installation, unauthorised modifications or attempted repair or failure to observe the requirements and recommendations as given in this User Manual. Additionally rechargeable batteries (where supplied) are not covered under warranty.

Repairs carried out under the warranty does not extend the warranty period. Components removed during the warranty repairs become the company property.

The statutory right of the purchaser is not affected by this warranty. The terms of this warranty is governed by the UK law. For complete details on Warranty Information, see the terms and conditions of sale available on our web-site.

### Manufacturer's Declaration of Conformity

This product has been manufactured in accordance with the harmonized European standards, following the provisions of the below stated directives:

Electro Magnetic Compatibility Directive 2004/108/EC

Low Voltage Directive 2006/95/EC

Adam Equipment Co. Ltd.  
Bond Avenue, Denbigh East  
Milton Keynes, MK1 1SW  
United Kingdom



### FCC COMPLIANCE

This equipment has been tested and found to comply with the limits for a Class A digital device, pursuant to Part 15 of the FCC Rules. These limits are designed to provide reasonable protection against harmful interference when the equipment is operated in a commercial environment. The equipment generates, uses, and can radiate radio frequency energy and, if not installed and used in accordance with the instruction manual, may cause harmful interference to radio communications. Operation of this equipment in a residential area is likely to cause harmful interference in which case the user will be required to correct the interference at his own expense.

Shielded interconnect cables must be employed with this equipment to insure compliance with the pertinent RF emission limits governing this device.

Changes or modifications not expressly approved by Adam Equipment could void the user's authority to operate the equipment.

### WEEE COMPLIANCE

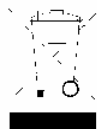

Sealed Lead Acid  
Battery  
Must be recycled  
Properly

Any Electrical or Electronic Equipment (EEE) component or assembly of parts intended to be incorporated into EEE devices as defined by European Directive 2002/95/EEC must be recycled or disposed using techniques that do not introduce hazardous substances harmful to our health or the environment as listed in Directive 2002/95/EC or amending legislation. Battery disposal in Landfill Sites is more regulated since July 2002 by regulation 9 of the Landfill (England and Wales) Regulations 2002 and Hazardous Waste Regulations 2005. Battery recycling has become topical and the Waste Electrical and Electronic Equipment (WEEE) Regulations are set to impose targets for recycling.

**ADAM EQUIPMENT** is an ISO 9001:2008 certified global company with more than 35 years experience in the production and sale of electronic weighing equipment.

For a complete listing of all Adam scales and balances visit our website at:

**[www.adamequipment.com](http://www.adamequipment.com)**

© Copyright by Adam Equipment Co. Ltd. All rights reserved. No part of this publication may be reprinted or translated in any form or by any means without the prior permission of Adam Equipment.

Adam Equipment reserves the right to make changes to the technology, features, specifications and design of the equipment without notice.

All information contained within this publication is to the best of our knowledge timely, complete and accurate when issued. However, we are not responsible for misinterpretations which may result from the reading of this material.

The latest version of this publication can be found on our Website.

---

**Head Office:**

***Adam Equipment Co. Ltd.***

Bond Avenue,

Milton Keynes,

MK1 1 SW

Tel: +44 (0)1908 274545

Fax: +44 (0)1908 641339

[sales@adamequipment.co.uk](mailto:sales@adamequipment.co.uk)

For regional office worldwide visit [www.adamequipment.com](http://www.adamequipment.com)