



Since 1887

**SI** Division of  
Scientific Industries, Inc.



# Instruction Manual: AGZN and AGCN Analytical Balances

## Table of Contents

Chapter 1: Cautionary Notes and Warnings .....	1
Chapter 2: Specifications .....	3
Chapter 3: Parts Description .....	4
Chapter 4: Keys, Display Indicators and Commands .....	5
Chapter 5: Unpacking the Scale and Getting Started .....	7
Chapter 6: Main Menu .....	9
Chapter 7: Calibration (CALIB) .....	10
7.1 Calibration - Automatic Internal .....	10
7.2 Calibration - External .....	11
Chapter 8: Units of Measure Selection (UNIT) .....	12
Chapter 9: Mode Configuration (MODE) .....	13
9.1 Animal Weighing Configuration .....	14
9.2 Parts Counting Configuration .....	16
9.3 Check Weighing Configuration .....	17
9.4 Display Hold Configuration .....	18
9.5 Percent Weighing Configuration .....	19
9.6 Totalizing Configuration .....	20
9.7 Density Measurement .....	21
9.7.1 Solid .....	28
9.7.2 Liquid .....	28
Chapter 10: Auto Zero Setting Mechanism – AZSM (AZSM) .....	24
Chapter 11: GLP Print and Data Configuration (GLP) .....	25
Chapter 12: Printing Data and Communication Ports (PORTS) .....	28
12.1 Baud Rate .....	28
12.2 Bits .....	29
12.3 Parity .....	29
12.4 Send (Data Format Configuration for PC / Printer) .....	30
12.5 Installing Drivers .....	31
12.6 Data Transmission and Exchange Protocol .....	32
Chapter 13: Time & Date (SET DATE) .....	34
13.1 Time .....	34
13.2 Date .....	35
Chapter 14: Restoring Default Factory Settings (RESET) .....	36
Chapter 15: Weighing (WEIGH) .....	37
15.1 Zeroing the Scale .....	37
15.2 Taring the Scale .....	38
15.3 Clearing the Tare .....	39
Chapter 16: Animal Weighing (ANIMAL) .....	40
Chapter 17: Parts Counting (PARTS) .....	43
Chapter 18: Check Weighing (CHECK) .....	46
Chapter 19: Display Hold (DISPLAY) .....	49
Chapter 20: Percent Weighing (PERCENT) .....	51
Chapter 21: Totalizing (TOTAL) .....	54
Chapter 22: Density Measurement (DENSITY) .....	54
22.1 Solid .....	56
22.2 Liquid .....	58
Chapter 23: Common Errors and Trouble Shooting .....	60
Chapter 24: Maintenance .....	61
Chapter 25: Accessories .....	62
Chapter 26: Replacement Parts .....	63
Chapter 27: Limited Warranty .....	64

## Chapter 1: Cautionary Notes and Warnings

### Important handling Cautions and Warnings

Always handle your scale with care.

Damage caused by improper handling is not covered under the scale's warranty.



Never drop or throw any articles onto the scale's pan or onto any other parts of the unit!



DO NOT let the scale fall or drop from its tabletop surface!

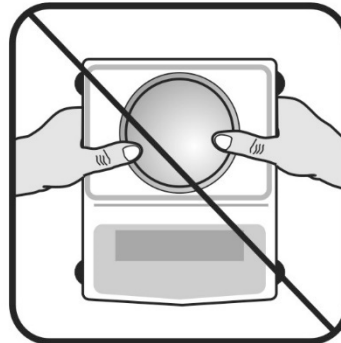

When moving the scale do not press or apply force onto the scales pan!



DO NOT pass or handle liquids directly over the scale to avoid spillage and liquid damage!

## CAUTIONARY NOTES AND PRECAUTIONS

Always handle your scale with care. The correct location and proper environment makes an important contribution to the accuracy of the weighing results of TORBAL precision scales.

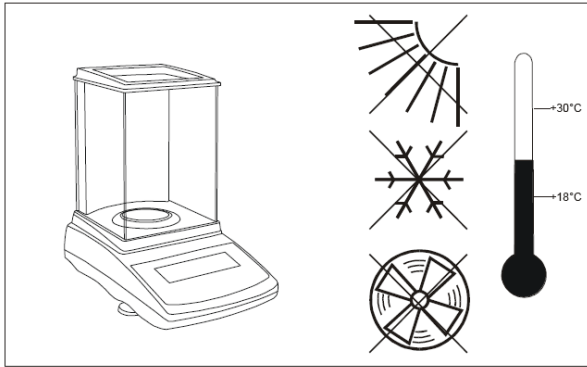

### The optimum location for your scale:

- Stable, vibration-free base as horizontal as possible
- Away from direct sunlight
- Not exposed to high temperature variations
- Away from direct drafts
- The best location is on a stable bench away from direct drafts, doors, windows, radiators and air conditioner vents.

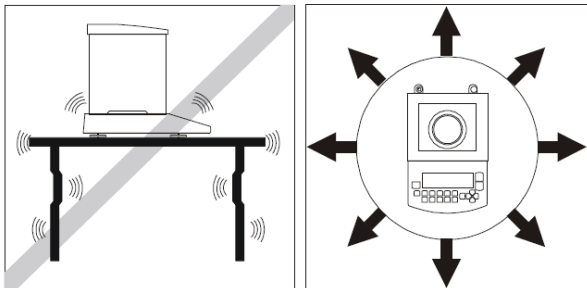

### CAUTION:



- The scale is designed for indoor use only.
- Do not operate the scale in hazardous areas or under dangerous conditions.
- Do not use the scale in locations subject to high humidity or dust.
- Do not connect cables in ways other than those mentioned in this manual.
- Set the scale on a firm, stable, horizontal surface.
- Never stand on or lean on this product. Equipment may fall or collapse, causing breakage and possible injury.
- Before moving the product, unplug it and unplug all cables connected to it.
- When storing, transporting or returning the scale for service, always use the original packaging.

### WARNING:



- Never attempt to repair, disassemble or modify the scale. Tampering with the scale may result in injury and cause greater damage to the equipment.
- Be sure to use the specified power source.
- Do not allow foreign matter to fall onto the scale.
- If water or other liquid spills onto the scale, unplug the power cord immediately and contact technical support.



## Chapter 2: Specifications

	Model			
	AGZN120	AGZN220	AGCN120	AGCN220
<b>Capacity</b>	120g	220g	120g	220g
<b>Readability (d)</b>	0.0001g			
<b>Verification (e)</b>	0.001 g			
<b>Repeatability (Standard Deviation)</b>	0.0001g			
<b>Linearity</b>	+/- 0.0002g			
<b>Tare Range</b>	-120g	-220g	-120g	-220g
<b>Stabilization time (typical)</b>	< 3s		< 3s	
<b>Automatic Internal Calibration</b>	No		Yes	
<b>Accuracy Class</b>	I			
<b>Pan Dimension</b>	90mm (3.5 in)			
<b>Weight Chamber Dimensions</b>	175 x 140x 230mm			
<b>Scale Dimension</b>	215 x 345 x 350mm			
<b>Operating Temperature</b>	+18C to +35C			
<b>RS232 Port</b>	Bidirectional – Standard			
<b>USB Port</b>	Type B			
<b>Ethernet Port</b>	Optional			
<b>Power Supply</b>	Input: 120VAC 60Hz 15W; Output: 12VDC 1.2A			
<b>Display Type</b>	LCD			
<b>Display Size</b>	3.75 in x 1 in (95.25 x 25.4 mm)			
<b>Weighing Units</b>	Grams (g), Kilogram (kg), Carat (ct), Pound (lb), Ounce (oz), Ounce Troy (ozt), Penny Weight (pwt)			
<b>Scale Net Weight</b>	13.27 lbs. (6 kg)			
<b>Application Modes</b>	Weighing, Animal Weighing, Parts Counting, Check Weighing, Display Hold, Percent Weighing, Totalizing, Density Measurement			
<b>Printing</b>	Yes			
<b>Warranty</b>	One Year			
<b>Parts Counting</b>	<b>Sample Size</b>	1 through 100		
	<b>Min Piece Weight</b>	3mg		
<b>Percent Weighing</b>	<b>Min Reference Weight</b>	1mg		
	<b>% Resolution Displayed (Reference Weight)</b>	0.1% (10mg to 700mg), 0.01% (700mg to 7g), 0.001% (>7g)		
<b>Animal Weighing</b>	<b>Time Intervals</b>	3 sec., 5 sec., 10 sec., 15 sec.		
	<b>Modes (Min Weight)</b>	Auto, Semi-Auto (1mg)		
<b>Totalizing</b>	<b>Modes (Min Weight)</b>	Auto, Semi-Auto (1mg)		
<b>Display</b>	<b>Modes (Min Weight)</b>	Auto, Semi-Auto (1mg)		

## Chapter 3: Parts Description

1	Pan
2	Pan Base
3	Draft Ring
4	Weighing Chamber Base
5	Keypad
6	Adjustable Leveling Feet
7	Level Indicator
8	LCD Display
9	Weighing Chamber
10	AC Adapter Socket
11	Calibration and Service Switch
12	RS232 Serial Port
13	USB Port

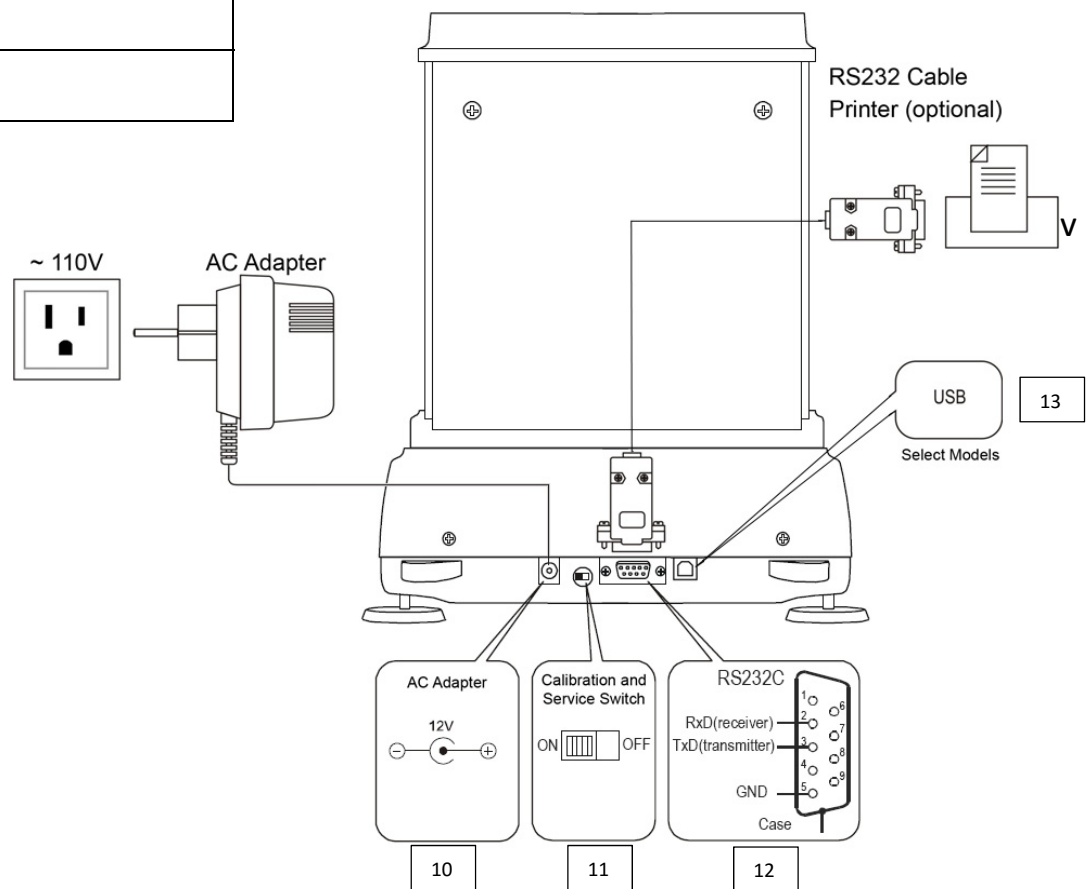
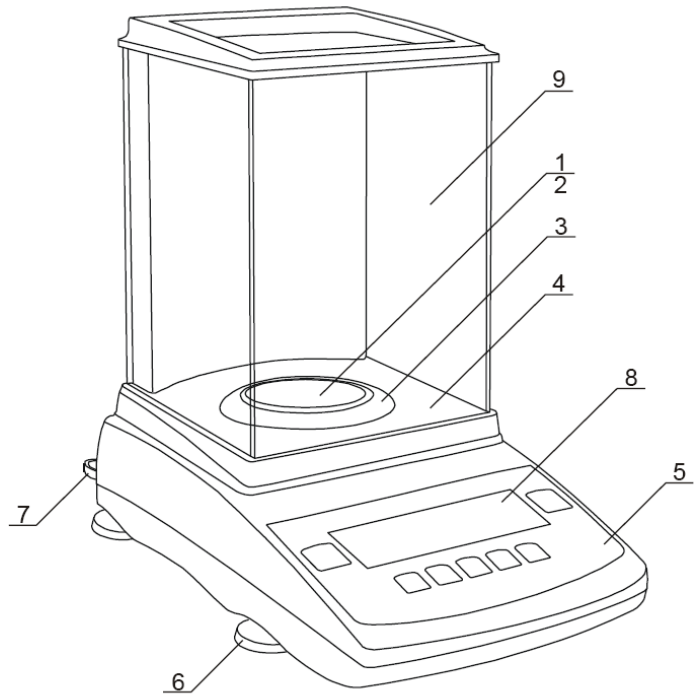

# Chapter 4: Keys, Display Indicators and Commands

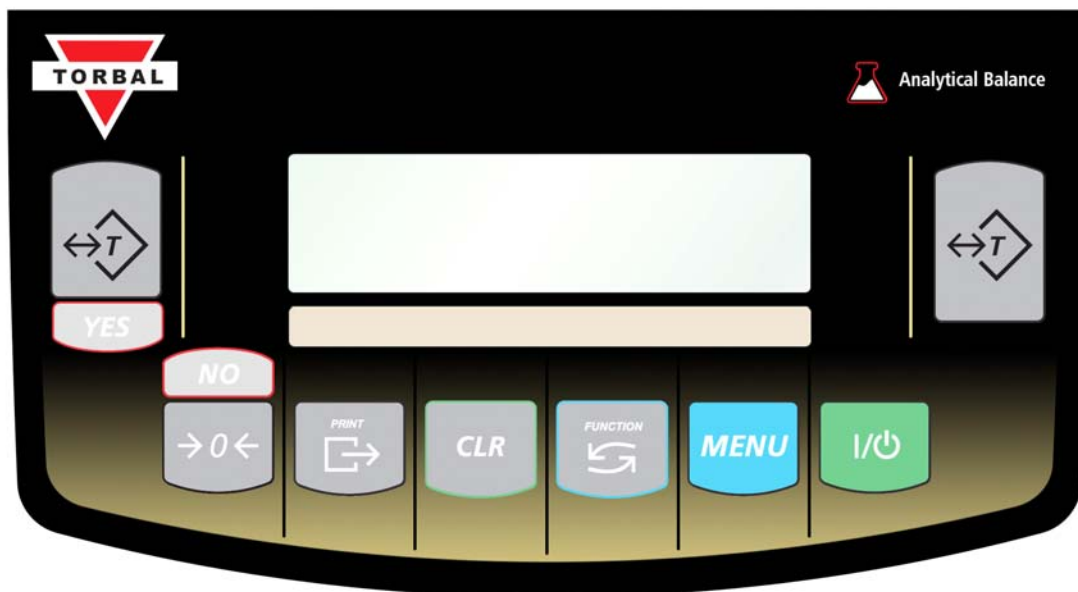

Key	Primary Function	Secondary Function
I/⏻	Power On/Off	-
↔T↔	<b>Tare</b> – used to tare the weighing pan	<b>Enter and YES (Accept)</b> – Used to enter or accept commands
→0←	<b>Zero</b> – used to zero the scale	<b>No (Reject)</b> – Used to reject commands or change values
MENU	<b>Menu</b> – used to access the main menu	<b>Recall</b> – In Totalizing this key is used to recall the Grand Total
<b>Function</b>	Function – Used to select an application mode	<b>Add/Start/Lock</b> – In Totalizing (Manual) this key is used to add a result to the total. In Animal Weighing (Manual) this key is used to initiate the animal weighing process. In Display Hold (Manual) this key is used to lock the weighing result on display.
➡	<b>Data Transfer</b> – used to print or transfer data to a PC via the communication ports	<b>Decimal</b> – Used to enter a decimal when assigning limit values in check-weighing
CLR	<b>Clear/Cancel</b> - Used to clear and cancel operations	<b>Exit</b> – Used to exit submenus
<b>Display Indicator</b>	<b>Description</b>	
OFF	Power Off	The scale is turned OFF and in standby mode.
AUT	AZSM (Auto-Zero Setting Mechanism)	AZSM is enabled and the scale maintains a “center of zero” condition within +/- 6d.
NET	Net Result	A tare was taken and the scale subtracted the tare weight from the gross weight to obtain the net weight.
↔0↔	Zero	The scale is maintaining a “center of zero” condition.
O	Current Setting	Indicated enabled functions or settings.



MODE	Main Menu	Indicates Main Menu Functions.
	Stability Indicator	The weighing result has stabilized and an accurate reading may be taken.
MIN	Minimum	In check weighing MIN indicates that the weighing result is below the selected under limit.
MAX	Maximum	In check weighing MAX indicates that the weighing result is above the selected over limit.
OK	Accept	In check weighing OK indicated that the weighing result is between the selected limits and the result is acceptable.
TOTAL	Total Result	In totalizing this indicator signals that the displayed result is a total sum.
PCS	Pieces	In parts count this indicator shows that the result is a piece count
%	Percent	In percent weighing this indicator shows that the result is a percentage.

Command or Abbreviation	Description
-----	Taring or re-zeroing in progress
CAL	The scale is in the calibration mode.
TARING	The scale is taring before the calibration process.
LOAD XXX g	Place a calibration weight on the pan to begin calibration.
C	Calibration in progress
CAL FIN	Calibration procedure is finished.
AW – X	In Animal Weighing, this command represents the average weighing time.
CONT	In Parts Counting, taring a container is required before continuing the counting transaction.
SAPL ON	In Parts Counting, or percent weighing this command indicates to place the sample on the pan.
SPL – XX	In Parts Counting, this command represents the current sample size setting.
FILL	In parts counting, begin counting.
UNDER	In Check Weighing, this command represents the under limit and indicates under result.
OVER	In Check Weighing, this command represents the over limit and indicates an over result.
ACCEPT	In Check Weighing, this command indicates that the weighing result is within the limit range.
TARE	In Check Weighing, tare before continuing.
SAMPLE	In Percent Weighing, this command indicates the weight of a stored reference weight.
READY	In Percent Weighing, this command indicates that the scale is ready for percent weighing based on a stored reference weight.
YES-NO	In Totalizing, this command indicates that a confirmation is required before the Totals are cleared.
PRINT	Printing in progress
COUNT FINISH, TO START COUNT PRESS C	In Parts Counting this command indicates that Parts Counting is finished.



## Chapter 5: Unpacking the Scale and Getting Started

1. Carefully remove the scale, pan, and all these components out of the packaging and place them on a stable base where the scale will not be affected by any mechanical vibrations or air moments.
2. After removing the chamber base (4), draft ring (3), pan base (2) and the pan (1) from their packaging, carefully install the chamber base (4) on the case of the balance as shown below. Once the chamber bases in place, install the draft ring (3). Once components 4 and 3 are in place install the pan base onto the scale by placing it on the pan support located in the middle of the scale. Once the pan base has been installed, carefully place the pan on the base as shown below.

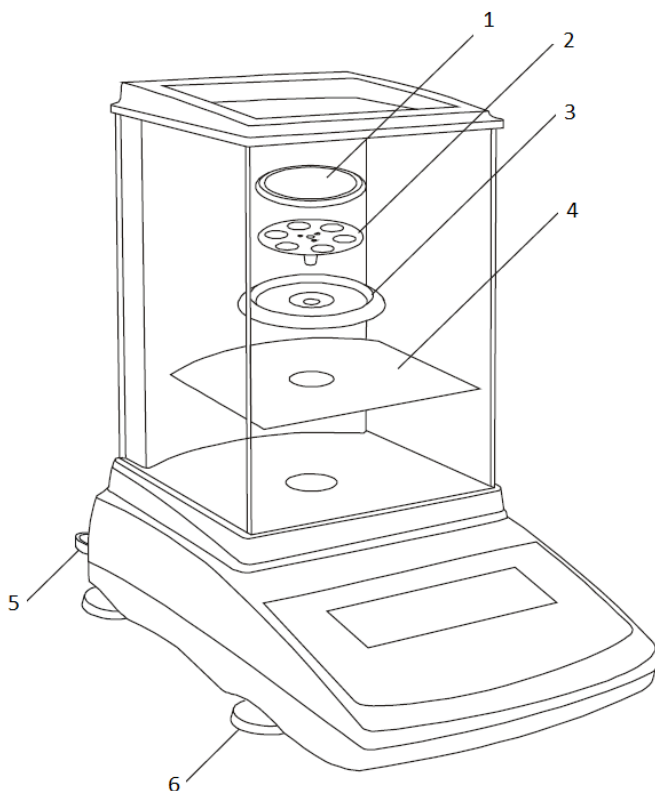

3. Once the pan has been installed, level the scale by adjusting the front feet (6) until the level indicator (5) shows the "air bubble" is in the center position of the sight glass. The level indicator is located in the rear left side of the scale.



Correct



Incorrect

- After leveling the scale, you may plug the AC adaptor to the AC adaptor socket located in the rear of the scale.

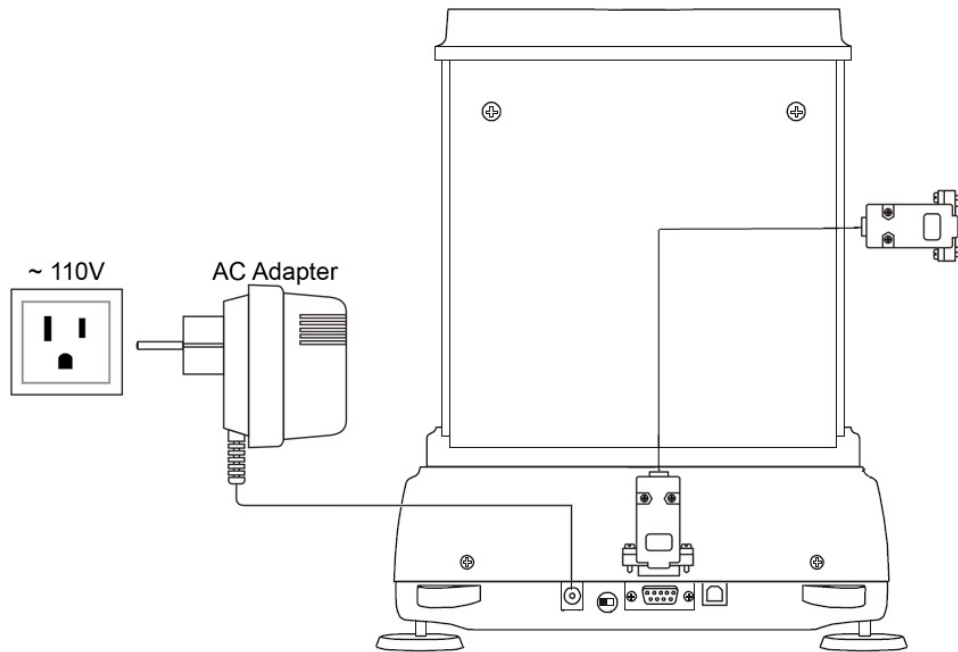

- When the AC adaptor is plugged into the wall outlet, the scale will automatically turn on, and go through its initialization process.

**Note – For Scales w/ Automatic Internal Calibration:** When the AC adapter is plugged into the wall outlet for the first time, the scale will automatically and frequently initialize temperature calibration as the internal parts of the scale heat up. The scale will display “—A1 t” when calibrating. Once the internal temperature stabilizes, the scale will calibrate whenever the temperature changes by 1 degree Celsius and at two-hour intervals. The scale loses internal temperature only when the unit is completely unplugged from the wall electrical outlet. When the unit is turned off with the On/Off key, the scale goes into standby mode and internal temperature is maintained.

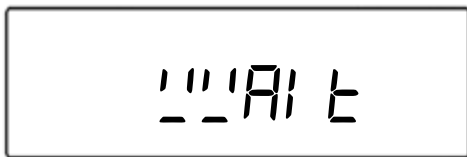

- To put the scale into standby mode, leave the AC adaptor plugged into both the scale and the wall outlet and press the Power “OFF” button. The “OFF” indicator will light up in the upper left corner of the display signaling the scale is in standby mode.

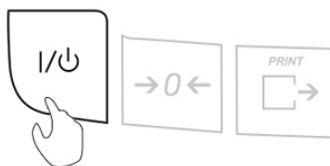

## Chapter 6: Main Menu

The *Main Menu* is used to configure the scale and its weighing modes. There are nine options within the Main Menu: Calibration (*CALIB*), Unit (*Unit*), Mode (*MODE*), AZSM (*AZSM*), GLP (*GLP*), Ports (*Ports*), Time/Date (*SEt Ed*) and Reset (*RESEt*).

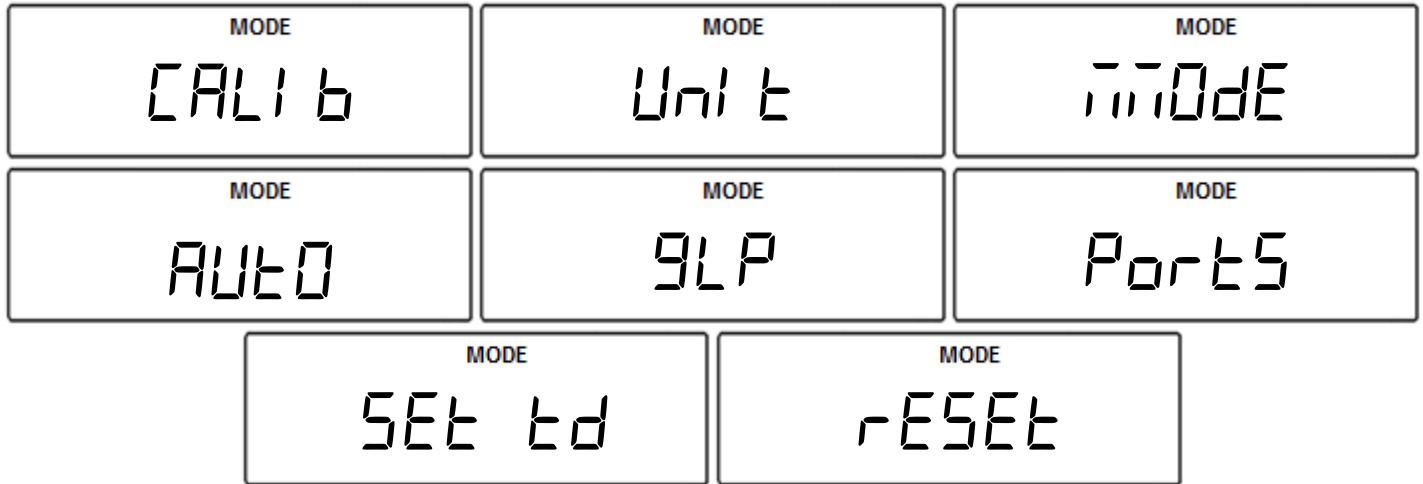

**Note:** Before entering the menu, complete and clear any active function by pressing the “CLR” key.

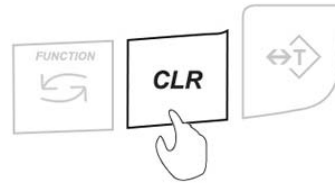

1. To enter the Main Menu, press the “MENU” key.

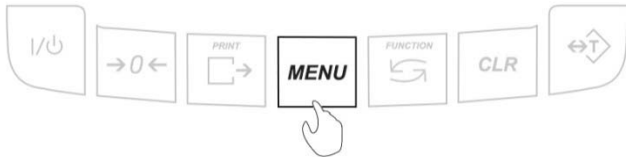

2. The scale will display available menu options sequentially. When the desired option is displayed, press the “T” (Yes) key to make the selection.

**Example** (Selecting Calibration):



**Note:** Scrolling through the options may be accelerated by manually pressing the “→0←” (NO) key.

3. To exit the Main Menu, Press the “CLR” key.

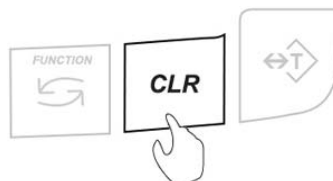

# Chapter 7: Calibration (CALIB)

## 7.1 Calibration - Automatic Internal (AGCN Models):

Automatic Internal Calibration Models: calibration is automatically performed every time the scale is turned ON or initialized. Calibration is also performed every time the internal temperature of the scale changes by 1°C or at 2 hour time intervals (whichever comes first).

When first plugged into the electrical wall outlet, temperature calibration will be performed regularly as the internal temperature of the scale increases to its operating level. Once the temperature stabilizes temperature calibration will be performed less frequently.

Calibration can be manually initialized by selecting the CAL START option from the main menu.

Function Options:

CAL Start	(START)	Force automatic internal calibration to begin.
CAL External	(CAL E)	Override Internal Automatic Calibration with external calibration weight.
CAL Report	(REPORT)	Print Calibration Report.
CAL Setup	(SETUP)	Select calibration mass value lower than scale’s capacity. External Calibration not legal for trade models only.
CAL Time	(CAL TIME)	Set automatic calibration frequency time interval.
CAL Temp	(CAL °C)	Set automatic calibration frequency interval based on temperature changes

1. Make sure the pan is free of any weight and stable.
2. To start calibration, press the “MENU” key. Select “CALIB” by pressing the “T” key.

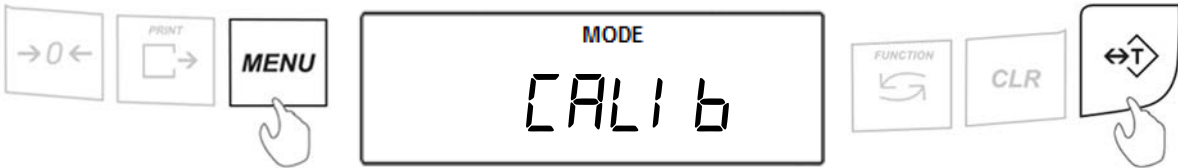

3. Select “CAL START” by pressing the “T” key. The scale will then begin to perform calibration.



4. During calibration the scale will display “CALIB”. When calibration is finished the scale will return to weighing mode.

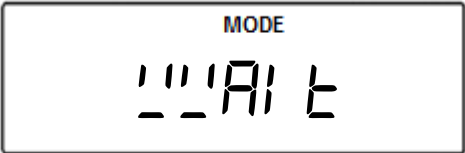

## 7.2 Calibration – External (AGZN Models):

External calibration can be performed with an external calibration weight equal to the scale’s capacity.

1. To start calibration, press the “MENU” key. Select “CAL ib” by pressing the “T” key.

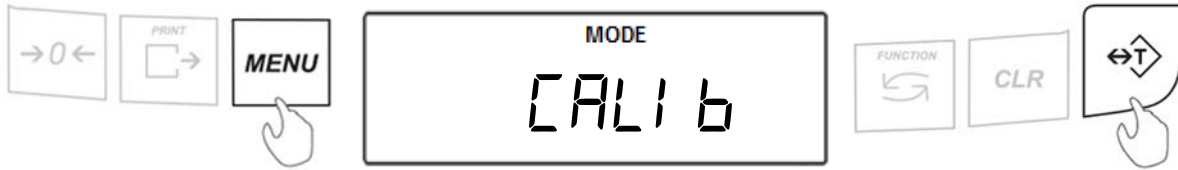

2. Select “CAL START” by pressing the “T” key. The scale will then begin to perform calibration.

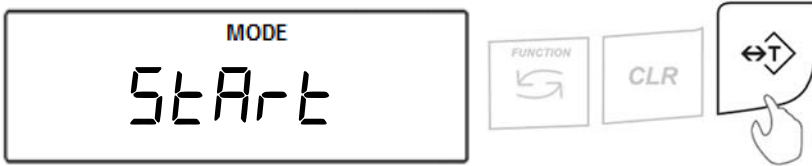

3. Wait for the scale to tare.

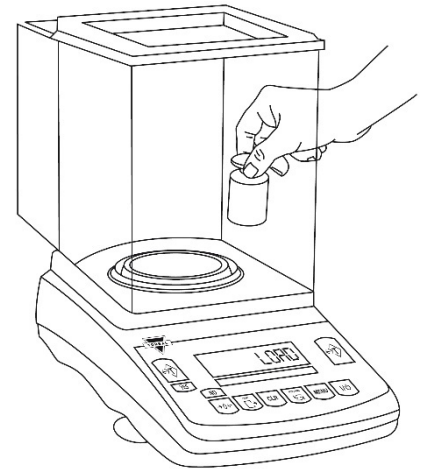

4. When prompted, load a calibration weight equal to the weight displayed on the screen. (Calibration weight varies by model).

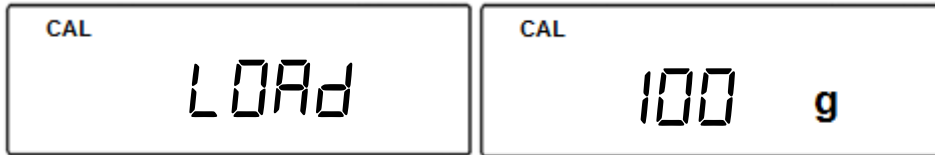

5. Wait for the scale to calibrate.

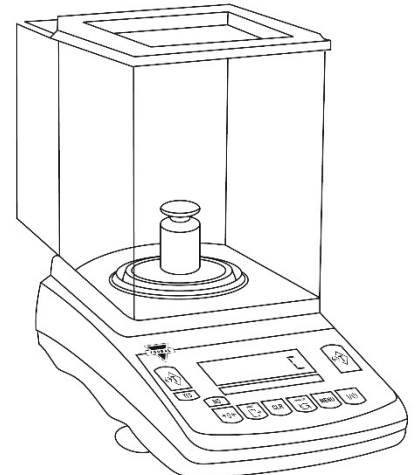
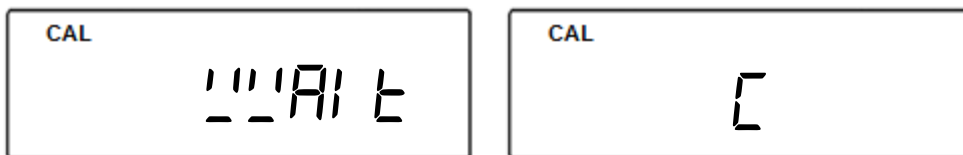



## Chapter 8: Units of Measure Selection (Unit) Not Legal for Trade models only

TORBAL AGZN/AGCN series scales can operate in nine different units of measure: grams (g), kilograms (kg), carats (ct), pounds (lb), Newton (N), grains (gn), ounces (oz), ounces troy (oz-t), and pennyweights (dwt).

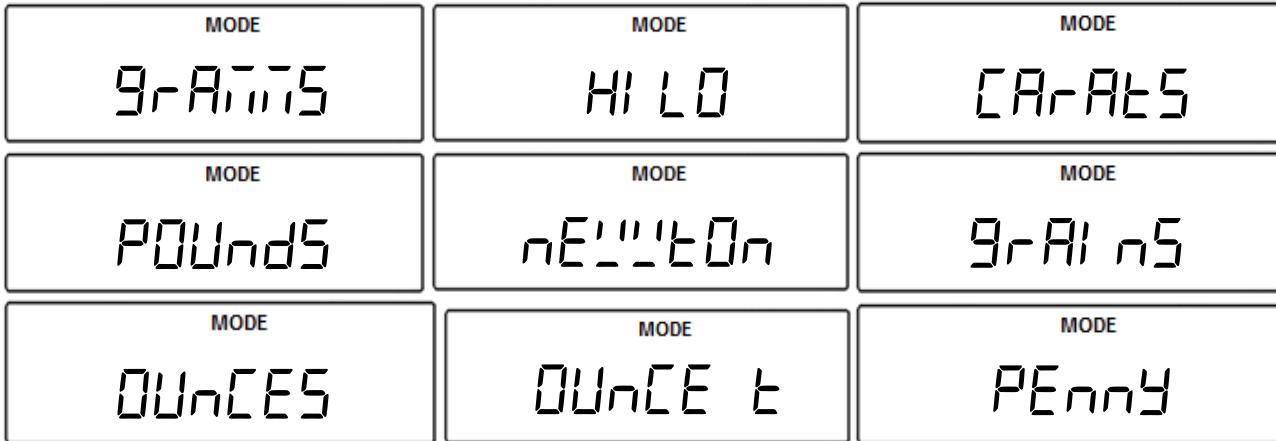

By factory default the scale is set to weigh in grams (g). To select a different unit, follow the steps below.

1. Press the “MENU” key. Select “Unit” by pressing the “T” key.

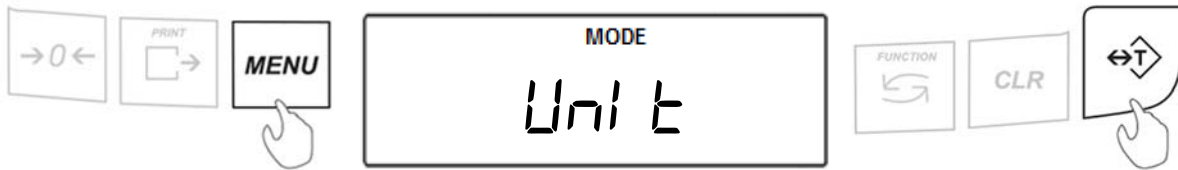

2. The scale will display available units of measure sequentially. When the desired unit is displayed, press the “T” (Yes) key to make the selection.

**Example (Selecting Kilograms):**



**Example (Selecting Ounces):**

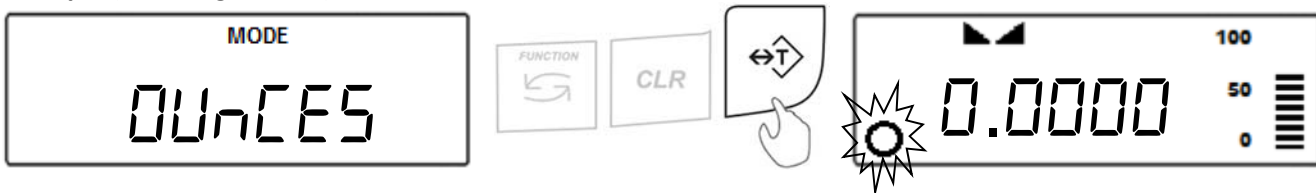

**Note:** When grams (g), kilograms (kg), carats (ct), pounds (lb), or Newton (N) are selected, the symbol for that unit will appear to the right of the display. When a unit of measure other than the aforementioned is selected, an indicator will appear in the bottom-left corner of the display.

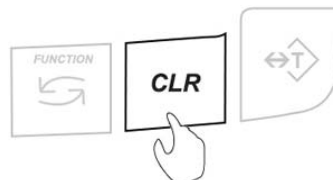

3. To exit the Main Menu, use the “CLR” key.

## Chapter 9: Mode Configuration (MODE) Not Legal for Trade models only

TORBAL AGZN/AGCN series scales can operate in six application modes: Animal Weighing (ANIMAL), Parts Counting (PARTS), Check Weighing (CHECK), Display Hold (DISPLAY), Percent Weighing (PERCENT), and Totalizing (TOTAL).

Before an application mode can be used, it must be enabled and configured. Once the application mode is enabled it will be available for selection from the Function Menu.

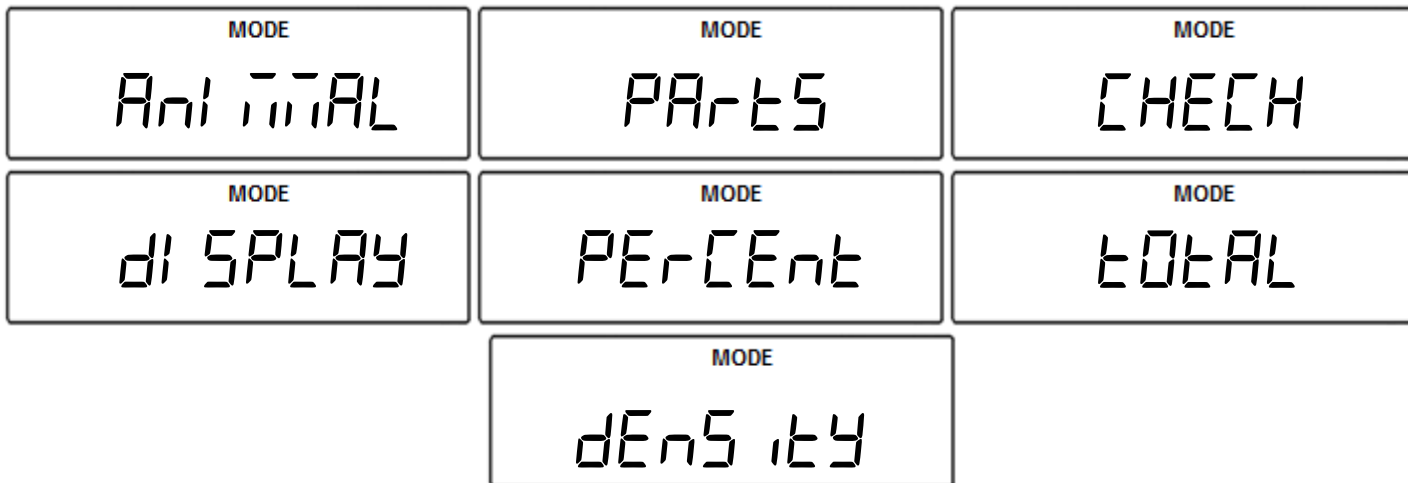

By factory default the scale is in the weighing mode (WEIGH). To enable other application modes, follow the steps below.

1. Press the “MENU” key. Select “MODE” by pressing the T key.

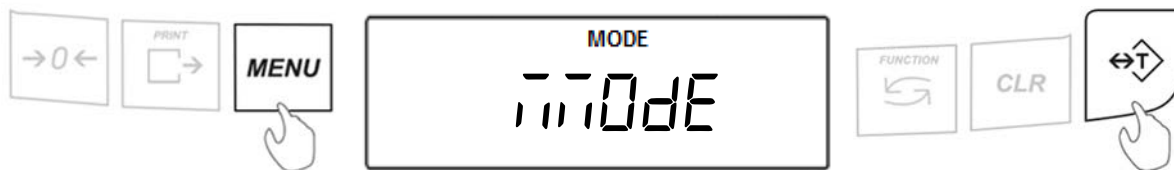

2. The scale will display available modes sequentially. When the desired mode is displayed, press the “T” key (Yes) to make the selection.

**Example** (Selecting Animal Weighing):

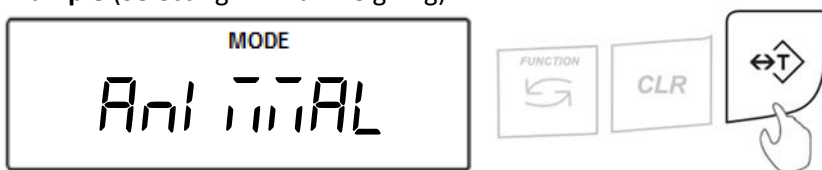

**Note:** Scrolling through the options may be accelerated by pressing the “→0←” (NO) key.

Check individual Mode sub-chapters for more information.

### 9.1 Animal Weighing Configuration

Animal weighing is used to weigh live animals and other dynamic loads. A choice of 3 different operating modes and 4 different weight integration periods ensures the user the best results in the least amount of time per measurement.

1. To enable Animal Weighing, select “Ani WtAL” in the Mode Menu by pressing “T” (YES) key.



2. Commands “An On” and “An OFF” will be displayed sequentially. To enable Animal Weighing, select “An On” with the “T” key. To disable Animal Weighing, select “An OFF” with the “T” key.

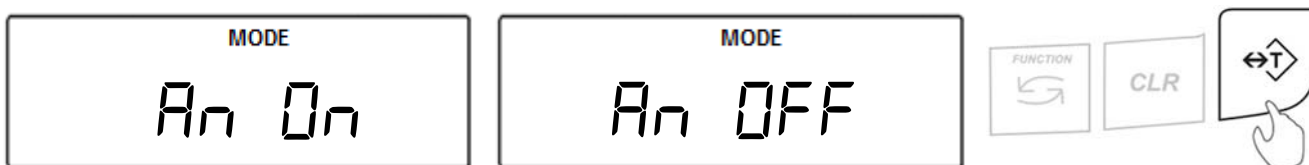

3. Animal weighing can operate in three different modes: Automatic (AUtO), Semi-automatic (SE-AUtO) and Manual (WtAL) (see Table 9.1). The three operating modes will display sequentially. When the desired mode is displayed, press the “T” key to make the selection.

**Example** (Selecting Automatic):



4. Once the desired operating mode for animal weighing has been selected, the scale will display time intervals for the animal weighing process, sequentially. The intervals are: 3 seconds (t- 3), 5 seconds (t- 5), 10 seconds (t- 10), and 15 seconds (t- 15). Select a time interval by pressing the “T” (Yes) key.

**Example** (Selecting 10 seconds):



**Note:** Select longer time intervals when weighing very active animals. Longer time intervals will allow the scale to take more readings while the animal is moving on the pan and provide an accurate result.



- After selecting the time interval, “dOnE” will be displayed, indicating that the function has been configured and it is ready to use.



To use the function, follow the directions given in Chapter 16. To exit the mode menu press the “CLR” key.

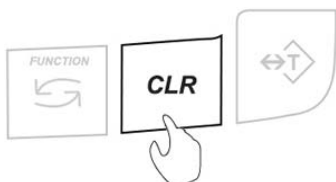

Mode	Configuration	Description
Automatic	Weighing Initialization: Automatic Result Clearing: Automatic Tare: Automatic	When set to Automatic, the scale will automatically begin the animal weighing process. Once the animal is removed from the weighing pan, the scale will automatically tare and prepare for the next weighing.
Semi-Automatic	Weighing Initialization: Automatic Result Clearing: Manual Tare: Manual	When set to Semi-Automatic, the scale will automatically begin the animal weighing process. Once the animal is removed from the weighing and the result remains displayed until it is manually cleared. The scale must be manually tared before the next weighing.
Manual	Weighing Initialization: Manual Result Clearing: Manual Tare: Manual	When set to Manual, the animal weighing process must be manually initialized. Once the animal has been weighed and the pan cleared the result must be manually cleared. The scale must be manually tared before the next weighing.

## 9.2 Parts Counting Configuration

Parts Counting is used to count a batch of items based on their weight. A sample is taken to determine the average piece weight of the items.

1. To enable Parts Counting, select “PARTS” in the Mode Menu by pressing “T” (YES) key.



2. Commands “Co On” and “Co OFF” will be displayed sequentially. To enable Parts Counting, select “Co On” with the “T” key. To disable Parts Counting, select “Co OFF” with the “T” key.

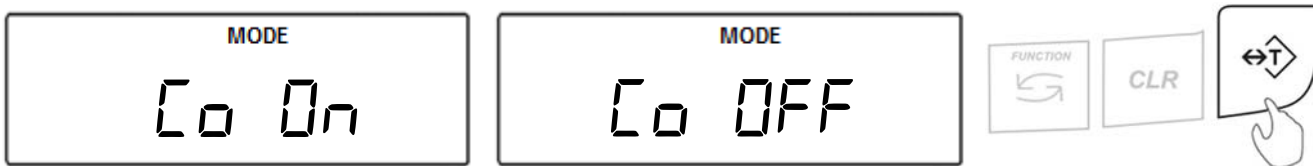

3. A sample size must be configured for establishing the average piece weight. The default sample size of 10 pieces will be displayed (SPL- 10). To accept the sample size press the “T” (YES) key. To change the sample size press the “→0←” (NO) key.



The sample size selection ranges from 1 to 100. Quickly press and release the “→0←” (NO) key to change the sample size by increments of one. Press and hold the “→0←” (NO) key to change the sample size in increments of five. Once a desired sample size is displayed, press the “T” (YES) key to accept and confirm the selection.

**Example** (Selecting SPL-99):

Press and hold the “→0←” key until the display reads 95. Apply four single presses until the sample size reads 99. Press the T key to confirm the selection.

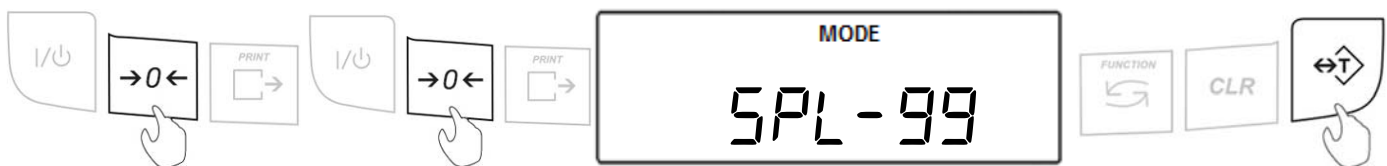

**Note:** Larger sample size results in a more accurate average piece weight. Select a sample size greater than 10 pieces if a large weight variance might exist between the counted pieces.

- After selecting the sample size, “dOnE” will be displayed, indicating that the function has been configured and it is ready to use.

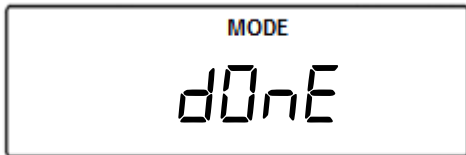

- To use the function follow the directions in Chapter 17. To exit the mode menu use the “CLR” key.

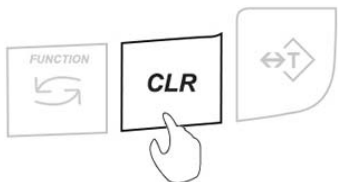

### 9.3 Check Weighing Configuration

The Check Weighing function is used to compare the weight of an object against a preset target range. Depending on the set tolerances, the scale will display “OvEr,” “UndEr,” or “RECEPt.”

- To enable Check Weighing, select “CHECH” in the Mode Menu by pressing “T” (YES) key.



- Commands “CHH On” and “CHH OFF” will be displayed sequentially. To enable Check Weighing, select “CHH On” with the “T” key. To disable Check Weighing, select “CHH OFF” with the “T” key.

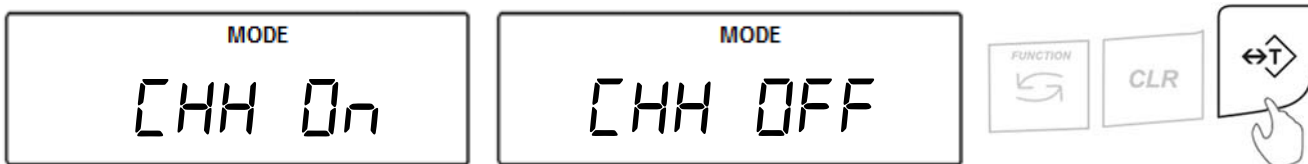

- After enabling Check Weighing, “dOnE” will be displayed, indicating that the function has been configured and it is ready to use.

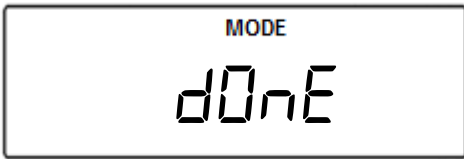

4. To use the function follow the directions in Chapter 18. To exit the mode menu use the “CLR” key.

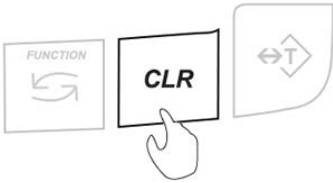

### 9.4 Display Hold Configuration

Display Hold is used to lock a weight reading on the screen, even after the weighed object has been removed from the pan.

1. To enable Display Hold, select “di SPLAY” in the Mode Menu by pressing “T” (YES) key.



2. Commands “di On” and “di OFF” will be displayed sequentially. To enable Display Hold, select “di On” with the “T” key. To disable Display Hold, select “di OFF” with the “T” key.

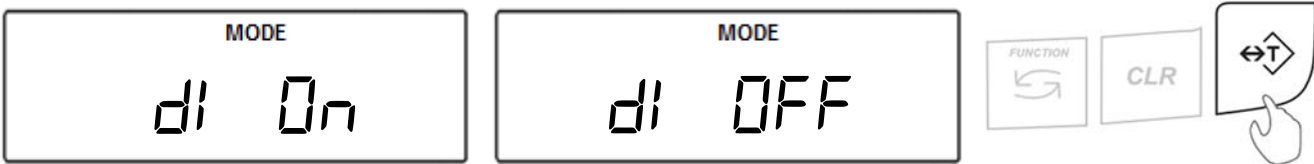

3. Display Hold can operate in three different modes: Automatic (AUtO), Semi-automatic (SE-AUtO) and Manual (MANUAL) (see Table 9.4). The three operating modes will display sequentially. When the desired mode is displayed, press the “T” key to make the selection.

**Example** (Selecting Automatic):



- After selecting the operating mode, “dOnE” will be displayed, indicating that the function has been configured and it is ready to use.



- To use the function follow the directions in Chapter 19. To exit the mode menu use the “CLR” key.

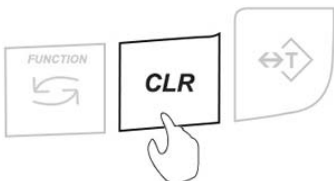

Operating Mode	Initialization	Description
Automatic	Display Hold Initialization: Automatic Result Clearing: Automatic Tare: Automatic	When set to Automatic, the scale will automatically lock and hold the first stable weight reading on the display. When the weight is removed the scale will automatically clear the result. Once the result is cleared the scale will automatically tare and prepare for the next weighing.
Semi-Automatic	Display Hold Initialization: Automatic Result Clearing: Manual Tare: Manual	When Set to Semi-Automatic, the scale will automatically lock and hold the first stable weight reading on the display. When the weight is removed it must be manually cleared. Before starting the next weighing the scale must be manually tared.
Manual	Weighing Initialization: Manual Result Clearing: Manual Tare: Manual	When set to manual, the first stable weight reading on the display must be locked manually. When the weight is removed it must be manually cleared. Before starting the next weighing the scale must be manually tared.

### 9.5 Percent Weighing Configuration

Percent Weighing is used to compare the relative weight of an unknown item to that of a previously stored sample.

- To enable Percent Weighing, select “PERCENT” in the Mode Menu by pressing “T” (YES) key.

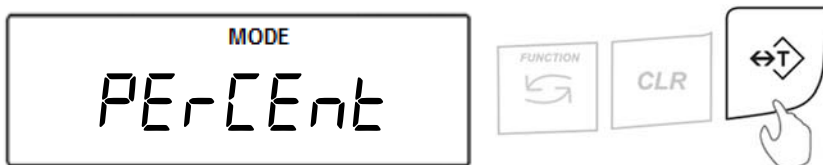

- Commands “PE On” and “PE OFF” will be displayed sequentially. To enable Percent Weighing, select “PE On” with the “T” key. To disable Percent Weighing, select “PE OFF” with the “T” key.

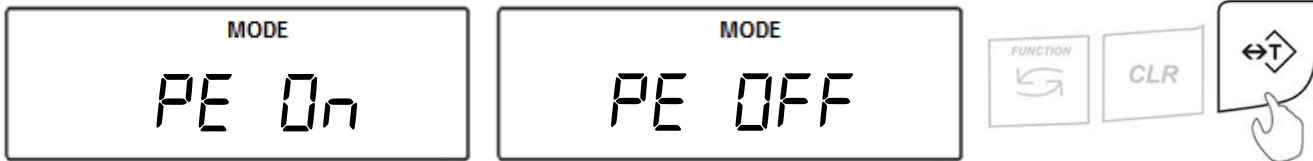

- After enabling Percent Weighing, “dOnE” will be displayed, indicating that the function has been configured and it is ready to use.

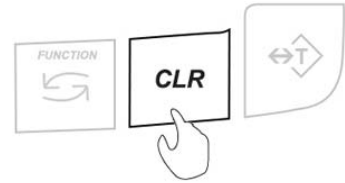
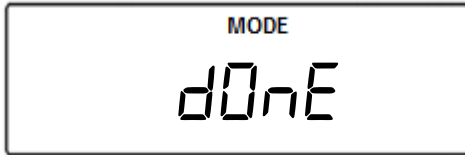

- To use the function follow the directions in Chapter 20. To exit the mode menu use the “CLR” key.

### 9.6 Totalizing Configuration

Totalizing is used to calculate the summation of multiple weights that are recorded sequentially.

- To enable Totalizing, select “tOTAL” in the Mode Menu by pressing “T” (YES) key.



- Commands “tOn” and “tOFF” will be displayed sequentially. To enable Totalizing, select “tOn” with the “T” key. To disable Totalizing, select “tOFF” with the “T” key.

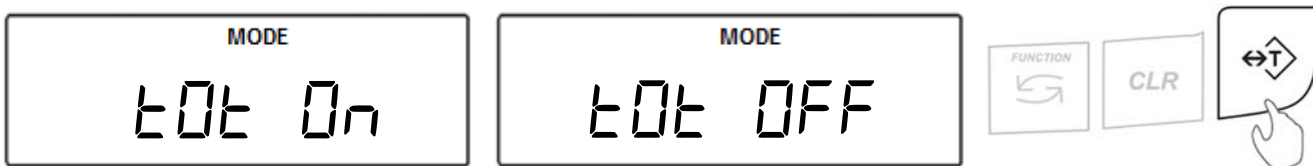

- Totalizing can operate in three different modes: Automatic (AUtO), Semi-automatic (SE-AUtO) and Manual (MANUAL) (see Table 9.6). The three operating modes will display sequentially. When the desired mode is displayed, press the “T” key to make the selection.

**Example** (Selecting Automatic):





- After selecting the operating mode, “dOnE” will be displayed, indicating that the function has been configured and it is ready to use.

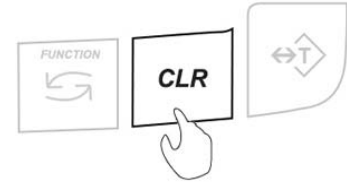
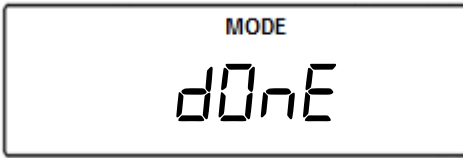

- To use the function follow the directions in Chapter 21. To exit the mode menu use the “CLR” key.

Table 9.6: Totalizing Operating Modes		
Automatic	Totalizing and Adding: Automatic	When set to Automatic, the scale will automatically add the first stable weight reading to the total.
Manual	Totalizing and Adding: Manual	When set to Manual each weigh has to be manually added to the total by pressing a designated key.

### 9.7 Density Measurement Configuration

The density calculation feature is used to assist in calculation of density in solids and liquids. To perform density calculation, a Density Kit (part no. AGC9171) is required.

Calculation Formula

SOLID	LIQUID
$\rho = \frac{m_1}{m_1 - m_2} * \rho$	$\rho = \frac{m_1 - m_2}{V}$
m 1 – mass calculation in air m 2 – mass calculation in liquid	m 1 – mass of the plunger in air m 2 – mass of the plunger in liquid V – Volume of the plunger

- To enable Density Measurement feature, select “dEnS iTy” in the Mode Menu by pressing “T” (YES) key.

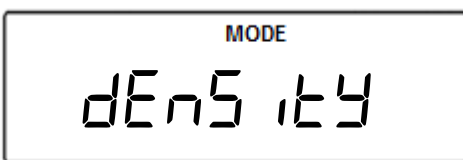

- Commands "dEn On" and "dEn OFF" will be displayed sequentially. To enable Density Measurement, select "dEn On" with the "T" key. To disable Totalizing, select "dEn OFF" with the "T" key.

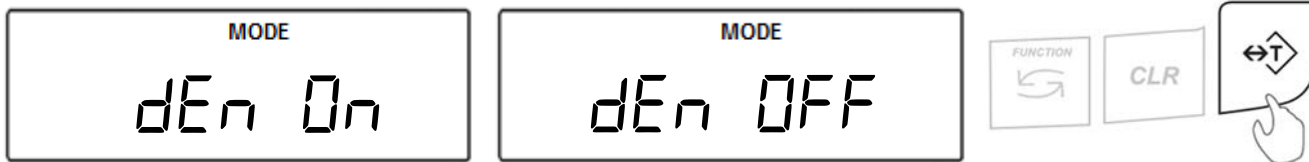

### 9.7.1 Solid

- To configure the function for density measurement of a SOLID press the T key when command "Sol id" is displayed.



- Options "H2O" H2O (distilled water), "EtHAnOL" ETHANOL, and "OtHEr" OTHER will scroll sequentially. Select the liquid that will be used in this density calculation by pressing the T key when the corresponding command is displayed.

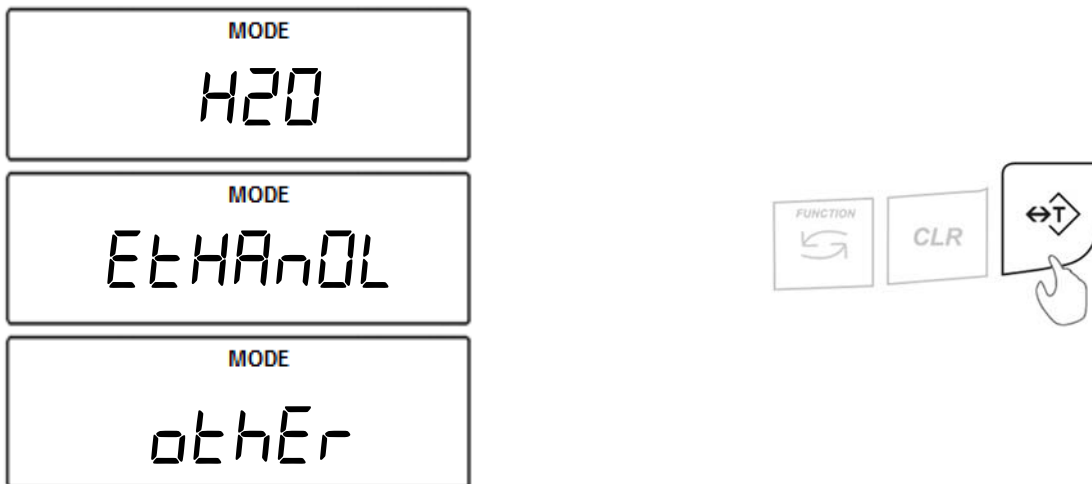

**NOTE:**

If you are using a liquid other than H2O (distilled water) or ETHANOL, select OTHER by pressing the T key and key in the density value of the liquid that will be used. To key in the density value of the liquid, use the following keys: The →0← key to increment a digit, the T key to accept and go to the next digit, and FUNCTION to accept the setting.



- Once the liquid for your density calculation has been selected, command t °C will be displayed indicating to key in the temperature of the liquid. Key in the temperature of the liquid with a precision to 0.5 (half a degree Celsius). To key in the temperature of the liquid, use the following keys: To key in the density value of the liquid, use the following keys: The →0← key to increment a digit, the T key to accept and go to the next digit, and FUNCTION to accept the setting.

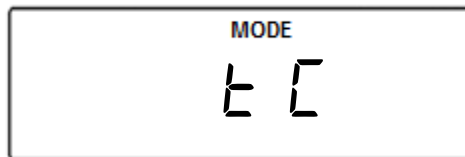

To increment a digit

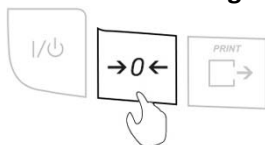

To accept and add the next digit



To insert a decimal

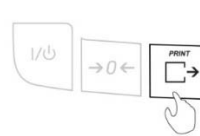

To accept the setting

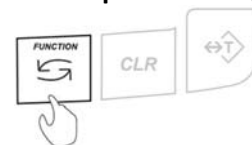

Press the T key to overwrite previously stored temperature value

### 9.7.2 Liquid

- To configure the function for density measurement of a Liquid press the T key when command "L iquid" is displayed.



- Options LIQUID is selected, PLUNGER "PLUNGER" will be displayed, indicating to enter the volume of the plunger used in the density kit, which can be found on the plunger hook included with the density kit.

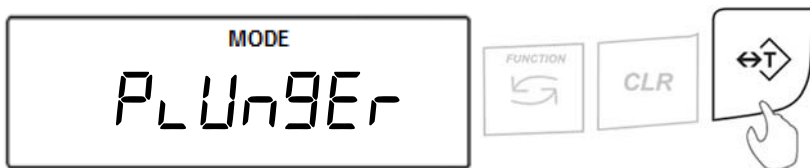

- To key in the volume of the plunger, use the following keys: The →0← key to increment a digit, the T key to accept and go to the next digit, and FUNCTION to accept the setting.

To increment a digit

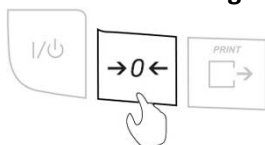

To accept and add the next digit



To insert a decimal

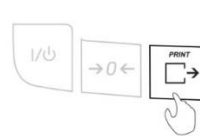

To accept the setting

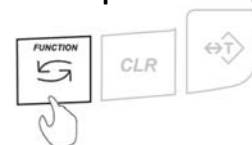

Press the T key to overwrite previously stored plunger value

# Chapter 10: Auto Zero Setting Mechanism – AZSM (AUTO)

All AGZN/AGCN scales are equipped with AZSM, the “Auto Zero Setting Mechanism.” AZSM automatically maintains a “center of zero” condition within +/- 6d (i.e. 6 mg on scales with 0.001g readability).

To enable or disable AZSM follow the steps below.

1. Press the “MENU” key. Select “AUTO” by pressing the “T” key.

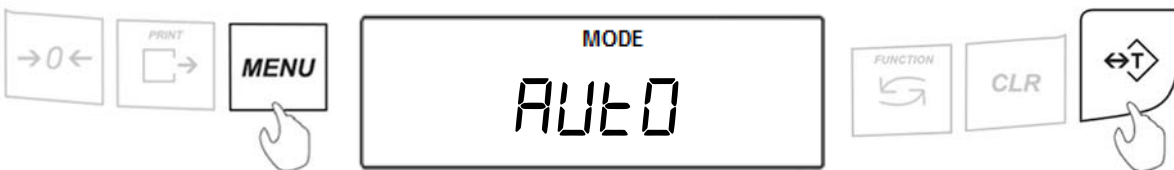

2. To enable AZSM press the “T” key when “AUTO On” is displayed. To disable AZSM press the “T” key when “AUTO OFF” is displayed.

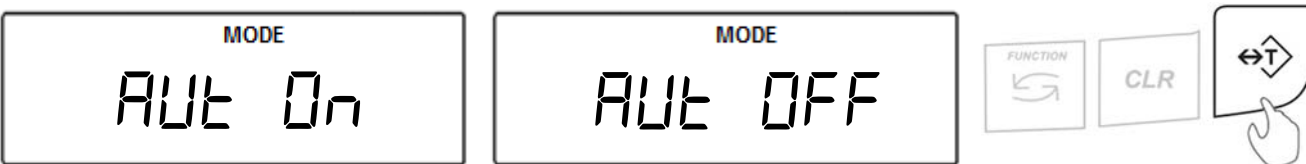

3. Once enabled, the “AUT” indicator will be displayed.





## Chapter 11: GLP Print and Data Configuration (GLP)

When enabled, GLP data will appear on every printed transaction receipt. The GLP printout includes Unit ID (*Unit Id*), User ID (*USER Id*), Project No. (*PROJECT*), Notes / Remarks field, and a Signature field.

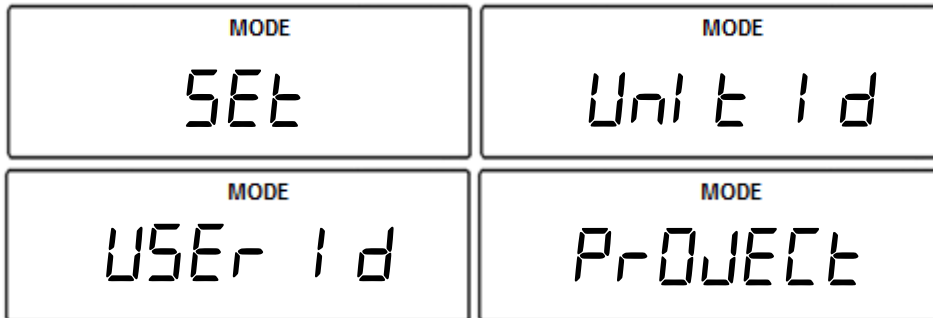

Example of printout:

TORBAL  
 Model: ATA220  
 Unit ID: 1234567  
 User ID: 7654321  
 Project No. 1234567

---

11/04/2014 10:49pm

100.000g

---

Notes / Remarks:

-----  
 Signature

-----END-----

To enable and configure GLP data printing, follow the steps below.

1. Press the “MENU” key. Select “GLP” by pressing the “T” (YES) key.

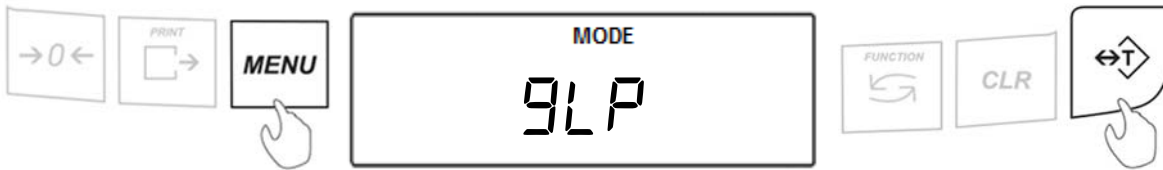

2. Select “SET” by pressing the “T” (YES) key.



3. To enable GLP, press the “T” key when “On” is displayed. To disable GLP, press the “T” key when “OFF” is displayed.

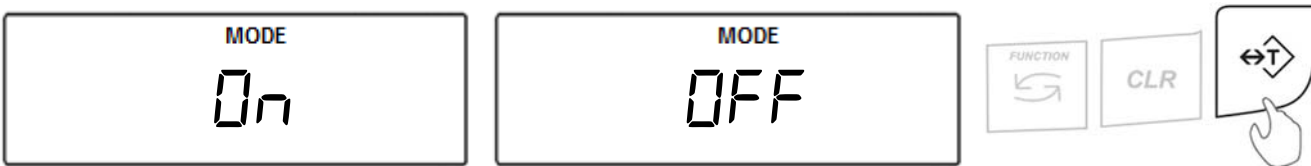

4. Once enabled, configurable options including Unit ID (Unit Id), User ID (User Id), Project No. (Project) will display. Select an option by pressing the “T” key.

**Example** (Selecting Model):

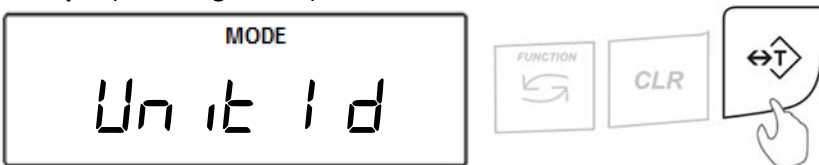

5. A dash will be displayed, indicating you may assign a value.

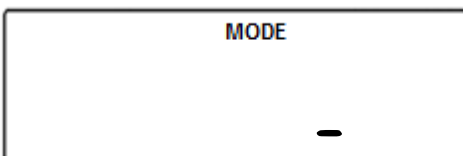

**Note:** ID numbers can consist of up to six digits.

6. Press the “→0←” key (NO) to increment a digit. Press the “T” (YES) to accept and add a digit.

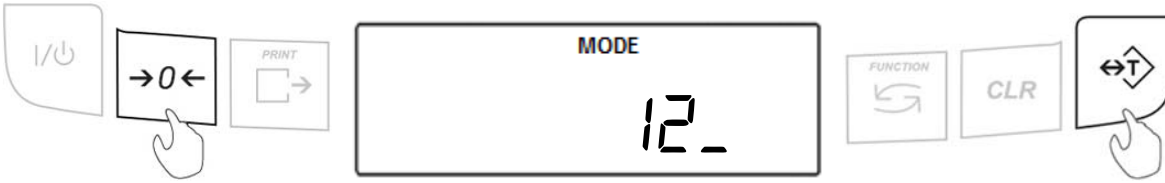

7. Press the “FUNCTION” key to accept the entire setting. Press the “CLR” key to clear and start over.

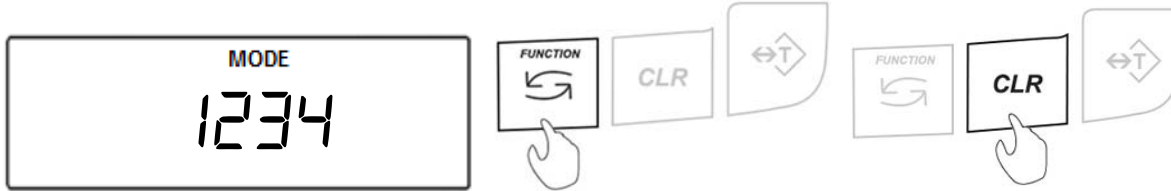

To become familiar with entering a value, refer to the example in **Table 11.1**.

<b>Table 11.1: Setting a Model Number</b>				
Current display	Action to take	Key to use	Number of depressions	Display becomes
-	Increment the digit	→0← (No)	6	5
5	Accept and go to next digit	T (Yes)	1	50
50	Increment the digit	→0← (No)	4	54
54	Accept and go to next digit	T (Yes)	1	540
540	Increment the digit	→0← (No)	3	543
543	Accept and go to next digit	T (Yes)	1	5430
5430	Increment the digit	→0← (No)	2	5432
5432	Accept the entire setting	T (Yes)	1	54320
54320	Increment the digit	→0← (No)	1	54321
54321	Accept the entire setting	FUNCTION	1	--

# Chapter 12: Printing Data and Communication Ports (Ports)

After a weighing or counting transaction is completed, a result data receipt can be printed. To initiate printing, press the data transfer key. Data may be sent to a printer or a PC via the Torbal Communication Software.

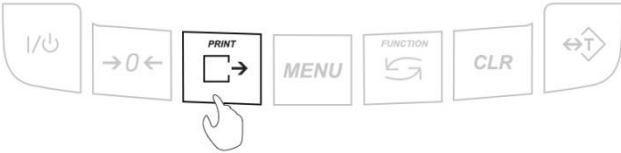

## USB and RS232 Ports

The scale is equipped with both USB and RS232 interface ports. These interfaces are both configurable through the Ports menu. The USB and RS232 can be configured by their baud rate, number of bits, and parity type.

1. To configure the ports, press the Menu key. Select "Ports" by pressing the "T" key.

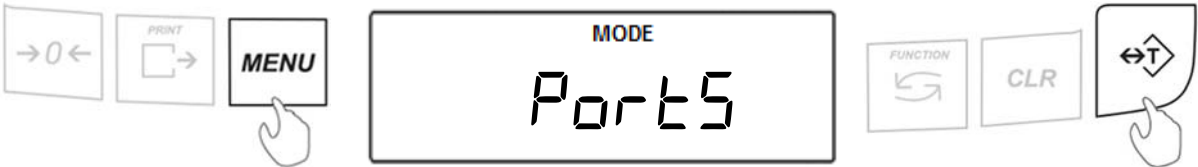

2. Choose the ports to be configured by selecting "rs232" or "usb". Confirm the selection by pressing the "T" key.

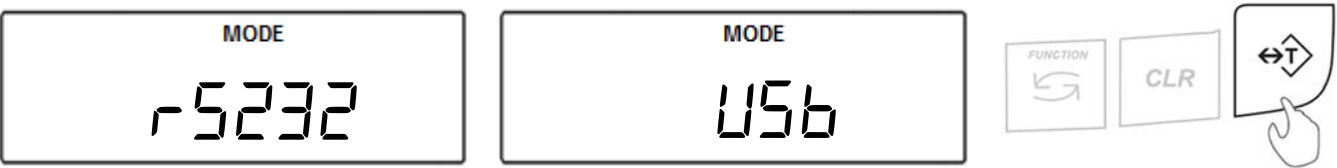

### 12.1 Baud Rate

1. To configure the Baud Rate select "baud" by pressing the "T" key.



- Choose the baud rate to be used (“1200”, “2400”, “4800”, “9600”, “19200”, “38400”, “57600”, and “115200”). To confirm the selection, press the “T” key.

**Example** (Selecting 9600):



## 12.2 Bits

- To configure the number of bits select “8 bitS” by pressing the “T” key.



- Choose “7 bitS” or “8 bitS”. To confirm the selection, press the “T” key.

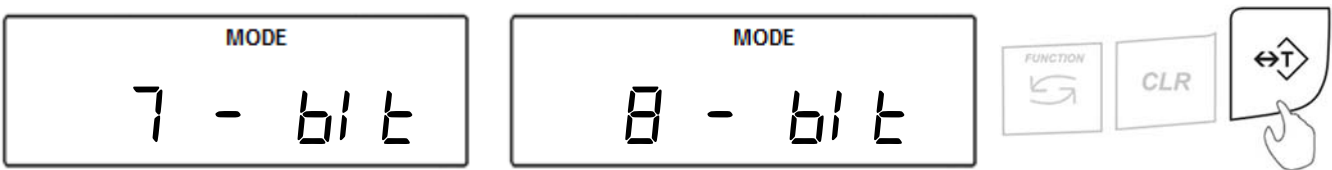

## 12.3 Parity

- To configure the parity type select “PARiTY” by pressing the “T” key.

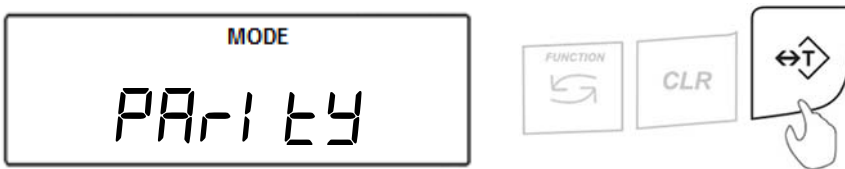

- Choose the parity type to be used (“none”, “odd”, and “Even”). To confirm the selection, press the “T” key.

**Example** (Selecting None):



## 12.4 Send – Sending Data to PC or Printer

- To configure the data sending format type select “SEnF” by pressing the “T” key.



- Choose the data sanding format (“oFF”, “StAb”, “noStAb”, “AUtO”, “rEīDUe” and “EuEn”). To confirm the selection, press the “T” key.

Stab (StAb)	Stable Required	Stable weighing result is required before data is sent
NoStab (noStAb)	No Stability Required	Result is sent as soon as the transfer data button is pressed. Scale does not wait for a stable result
Auto (AUtO)	Automatic	Weighing result is automatically transferred from the scale after it stabilizes (no push key required)
Cont (Cont)	Continuously	Weighing results is continuously transferred from the scale at all times. (no push key and no stability required)
Remove (rEīDUe)	Remove	Weighing result is automatically transferred from the scale once the mass has stabilized and was removed from the pan (no push key required).
Clean (CLEARn)	Exclude All Characters	All none mass result characters are excluded from data transfer. Scale sends only numeric mass values. Date, Time, Unit of measure are removed

**Example** (Selecting None):





## 12.5 Installing Drivers

Before connecting the scale to a computer the USB Port must be configured with the appropriate baud rate and other necessary parameters. To configure the USB Port, follow configuration steps from this chapter and apply them to the USB settings.

### PC Connection via USB

Once the USB port has been configured, connect the scale to the PC with a Standard A/B USB cable and follow the “Found New Hardware” configuration wizard as described below.

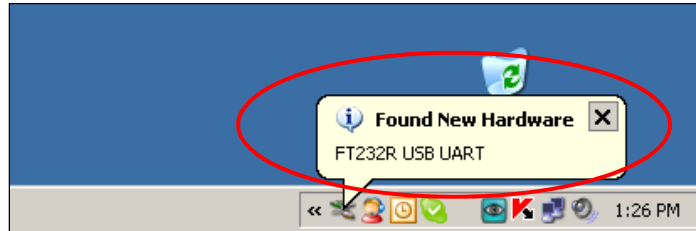

1. Allow Windows to connect to Windows Update in order to search for software. Select “Yes, this time only” and click “Next”. Once driver “FT232R USB UART” has been found, select “Install the software automatically (Recommended)” and click “Next”.

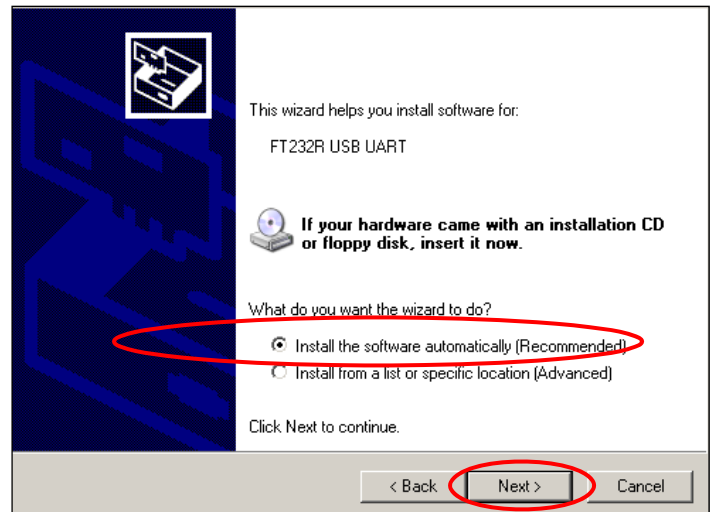
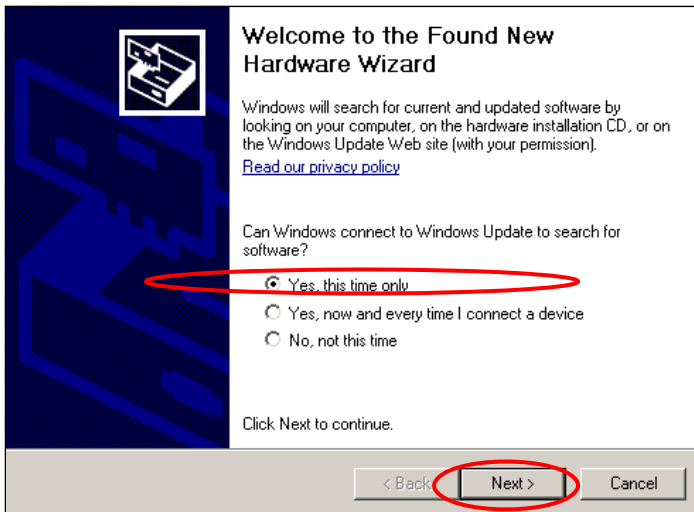

2. Windows will begin installation of the driver, when completed click “Finish”.

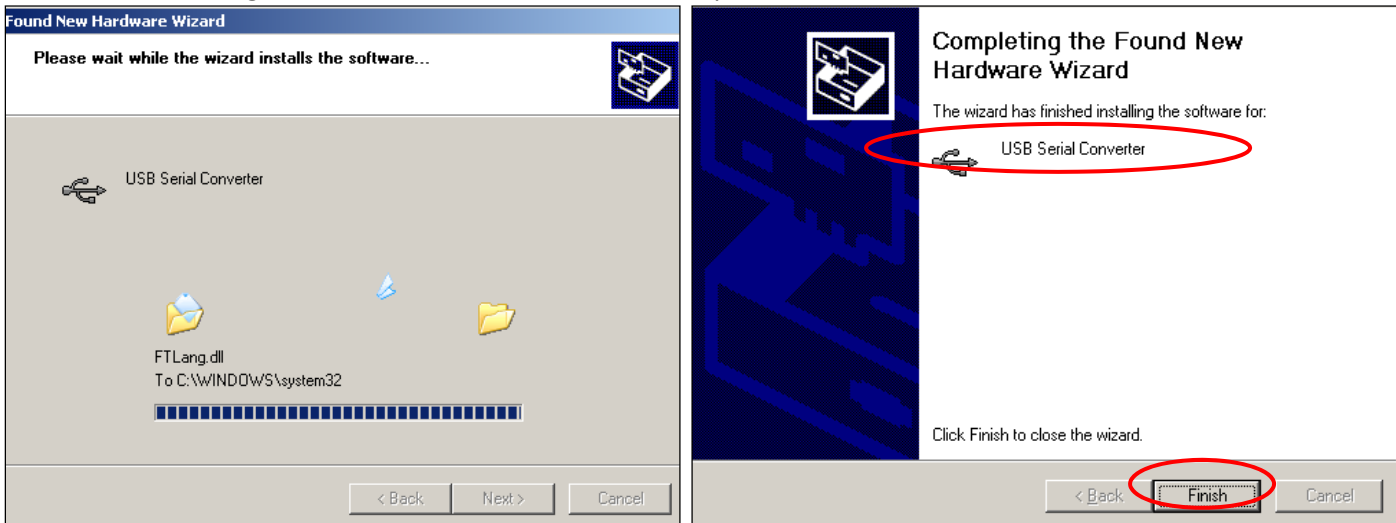

3. Once installation of the driver has been completed the scale is ready to communicate with the PC via the USB port.

## 12.6 Data Transmission and Exchange Protocol

### Data Transmission (LONG):

Transmission Parameters: 8 bits, 1 stop bit, no parity, baud rate 4800bps,

### Exchange data:

- Transmit the weight (equivalent to the Print Key, , in weighing:  
 Computer→Scale: **S I** CR LF (53h 49h 0Dh 0Ah) – initiating signal,  
 Scale→Computer: scale sends 16 Bytes of data as follows:

- |       |     |  |
|-------|-----|--|
| Byte  | 1   | - The charater '-' or space                  |
| Byte  | 2   | - space                                      |
| Bytes | 3,4 | - digit or space                             |
| Bytes | 5-9 | - digit, comma, or space                     |
| Byte  | 10  | - digit                                      |
| Byte  | 11  | - space                                      |
| Byte  | 12  | - k, l, c, p or space (for kg,lb,ct,pc, or%) |
| Byte  | 13  | - g, b, t, c or %                            |
| Byte  | 14  | - space                                      |
| Byte  | 15  | - CR   |
| Byte  | 16  | - LF   |

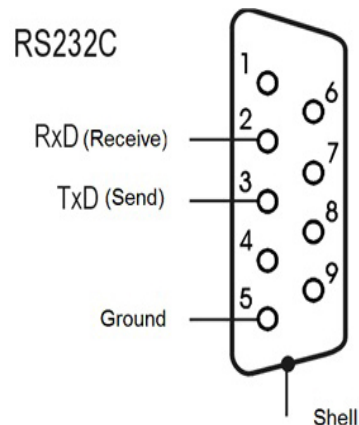

- ‘Tare the weight’ (corresponds to the →T← key in weighing):  
 Computer→Scale: **S T** CR LF (53h 54h 0Dh 0Ah),  
 Scale→Computer: no response.
- ‘Zero the scale’ (corresponds to the key →0← in weighing):  
 Computer→Scale: **S Z** CR LF (53h 5Ah 0Dh 0Ah),  
 Scale→Computer: no response.
- ‘Turn On / Off the Scale (corresponds to the key I/⏻ in weighing):  
 Computer→Scale: **S S** CR LF (53h 53h 0Dh 0Ah),  
 Scale→Computer: no response.
- ‘Display the MENU’ (corresponds to the key MENU in weighing):  
 Computer→Scale: **S F** CR LF (53h 46h 0Dh 0Ah),  
 Scale→Computer: no response.
- Setting the threshold 1 (optional):  
 Computer→Scale: **S L D1...DN** CR LF (53h 4Ch D1...DN 0Dh 0Ah)  
 where: D1...DN – Threshold value, up to 8 characters,  
 Scale→Computer: no response,
- Example:  
 To set 1000g in weight B1.5 (d=0.5g) type:  
 S L 1 0 0 0 . 0 CR LF (53h 4Ch 31h 30h 30h 30h 2Eh 30h 0Dh 0Ah).  
 To set 100kg in weight B150 (d=50g) type:  
 S L 1 0 0 . 0 0 CR LF (53h 4Ch 31h 30h 30h 2Eh 30h 30h 0Dh 0Ah),
- Setting the threshold 2 (optional):  
 Computer→Scale: **S H D1...DN** CR LF (53h 48h D1...DN 0Dh 0Ah),  
 where: D1...DN – threshold value, up to 8 characters,  
 Scale→Computer: no response

**Cable WK-1 Configuration**

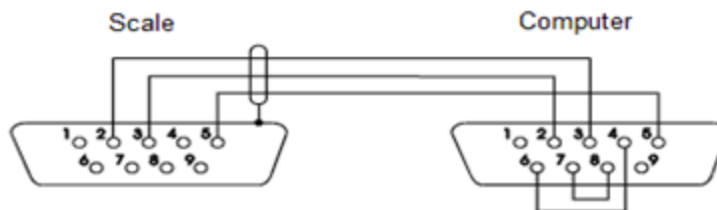

**Cable WD-1 Configuration**

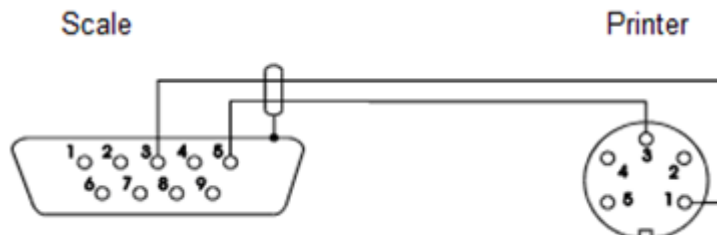

## Chapter 13: Time & Date (SEt Ed)

To set the current time and date, follow the steps below.

### 13.1 Time

1. Press the “MENU” key. Select “SEt Ed” by pressing the “T” key.

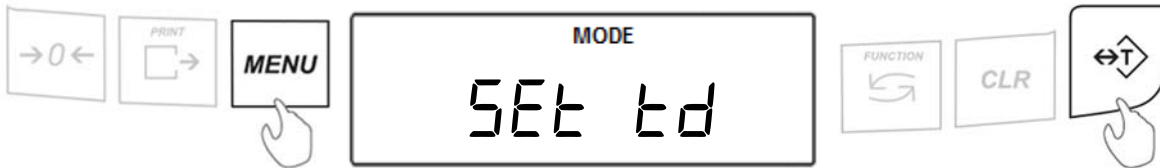

2. Select “Ed mE” by pressing the T key.



3. The current time setting will be displayed. To adjust the time press the “→0←” (NO) key.

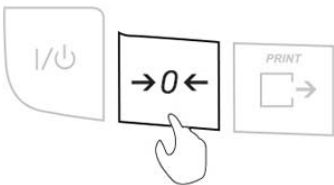

4. Use the →0← key to select “P” AM or “P” PM. Confirm selection with T key.

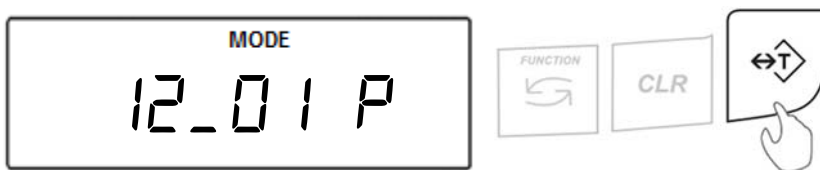

5. Use the →0← key to change minutes and hours. Press the T key to advance and confirm the time setting.

## 13.2 Date

1. Press the “MENU” key. Select “SEt Ed” by pressing the “T” key.

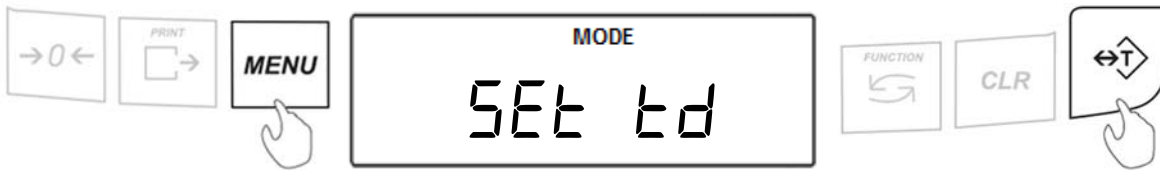

2. Select “dAtE” by pressing the T key.

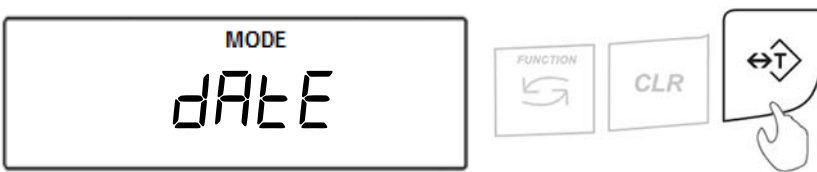

3. The current date will be displayed. To change the date, press the “T” key.



4. Use the →0← key to change minutes and hours. Press the T key to advance and confirm the time setting.

## Chapter 14: Restoring Default Factory Settings (rESEt)

The Reset function resets all modes and applications as well as restores default factory settings. To restore default factory settings follow the steps below.

1. Press the “MENU” key. Select “rESEt” by pressing the “T” key.

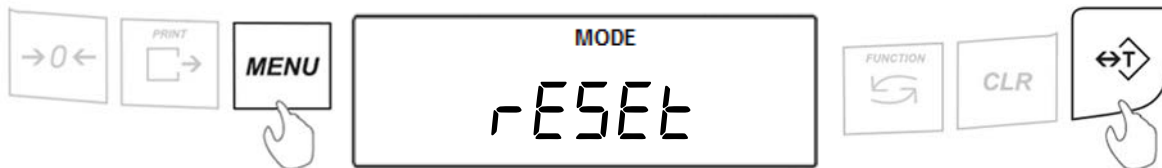

2. “YES-n0” will appear on the screen. To confirm and initialize the reset function, press the “T” (YES) key. To cancel and abort the reset press the “→0←” (NO) key.

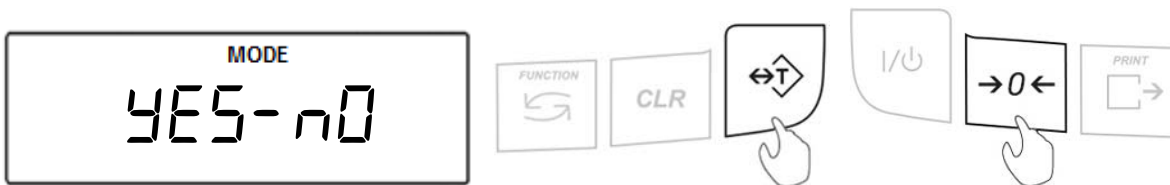

**Warning:** Resetting the scale will restore the default factory setting. Stored values will be lost and all functions will be disabled.

**Table 14.1: Factory Default Settings**

Weighing	Function: Always enabled
Animal Weighing	Function: Disabled Filtering Time: t-3 (3 seconds)
Parts Counting	Function: Disabled Sample Size: 10 pieces
Check Weighing	Function: Disabled Under Value: 0.000g Over Value: 0.000g
Display Hold	Function: Disabled
Percent Weighing	Function: Disabled Percent Reference Sample: 0.000g
Totalizing	Function: Disabled

## Chapter 15: Weighing (T T E I 9H)

1. To enter Weighing Mode, press the Function key. Select “T T E I 9H” by pressing the T key.

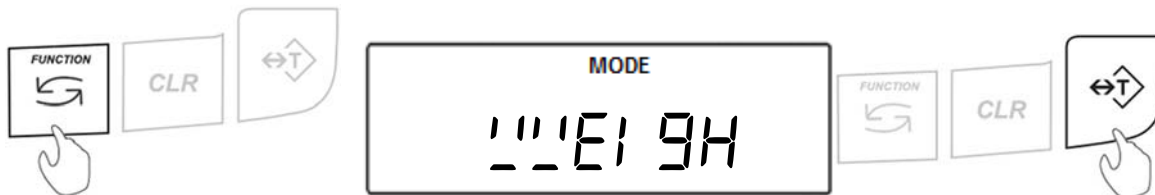

2. Wait for the stabilization indicator to appear. 



3. When weighing, always place the mass in the middle of the pan. The weighed result may be taken when the stabilization indicator reappears on the display.

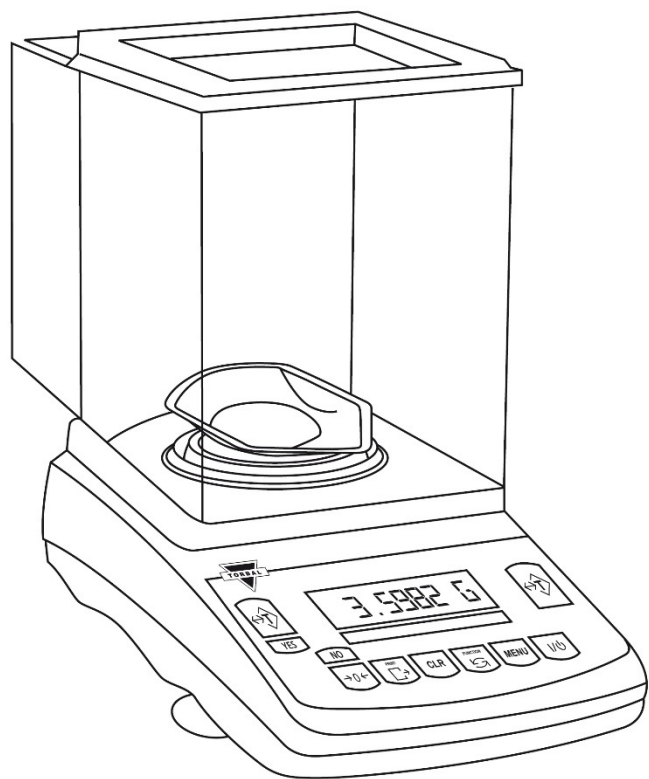

### 15.1 Zeroing the Scale

1. The scale is armed with the Auto Zero Setting Mechanism (AZSM). AZSM automatically maintains a center of zero condition within +/- .5d or 5mg.
2. The scale may be re-zeroed manually to obtain a new center of zero. To re-zero the scale manually with a weight that is out of the AZSM range, make sure the weight and the stabilization indicator are shown on the display.

3. Re-zero the scale by pressing the zeroing key.

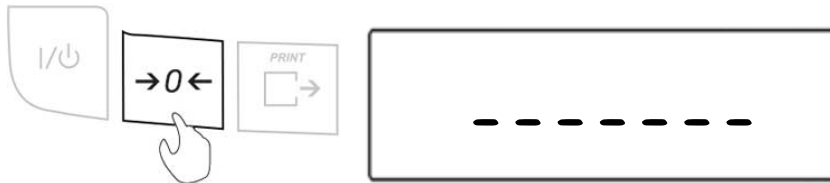

4. When finished re-zeroing, the scale will return to Weighing Mode and the display will indicate “0”. A new center of zero has been set, and the scale is ready for weighing.



**Note:** Re-zeroing the scale will reduce the capacity of the scale by the re-zeroed weight. The remaining capacity is displayed as a percentage on the right side of the display.

## 15.2 Taring the Scale

1. If a container is used for weighing, it may be tared. In taring the container, the scale subtracts the weight of the container from the gross weight to obtain the net weight.
2. To tare the weighing container, place it in the middle of the pan. The container’s weight will be shown on the display.



3. Once the stabilization indicator appears on the display, the container is ready to be tared. To tare the container, press the T button. The display will show a dotted line indicating that the scale has begun the taring process.





- When finished taring, the balance will return to Weighing Mode. The display will indicate “0”, and the NET indicator will be shown on the display signaling the next weight taken is a NET result.



**Note: Do not touch or move the scale during the taring process.**

### 15.3 Clearing the Tare

- To clear the tare, remove the tared object along with the NET weight from the pan. The scale will then display a negative NET tare result.



- To clear the tare, press the T button. The display will show dotted lines, indicating the tare is clearing.

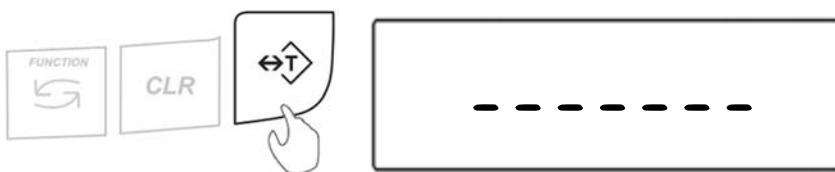

- When finished clearing the tare, the scale will return to Weighing Mode.



## Chapter 16: Animal Weighing (ANIMAL)

Animal weighing is used to weigh live animals and other dynamic loads. A choice of 3 different operating modes and 4 different weight integration periods ensures the user the best results in the least amount of time per measurement. An “A” indicator will appear on the screen to indicate the scale is in Percent Weighing mode.

1. To enter Animal Weighing Mode, press the “Function” key. Select “ANIMAL” by pressing the “T” key.

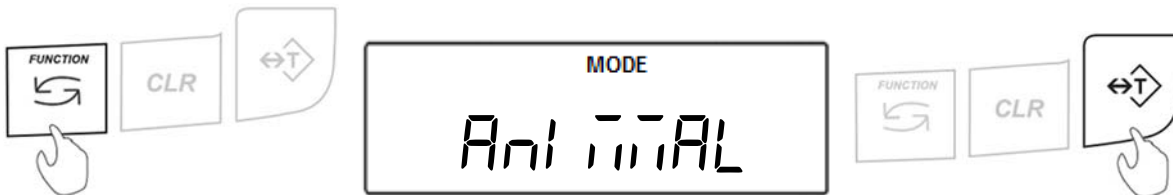

2. Place an empty weighing container on the pan. The container’s weight will be displayed. Wait for the weight to stabilize and press the “T” key to tare.

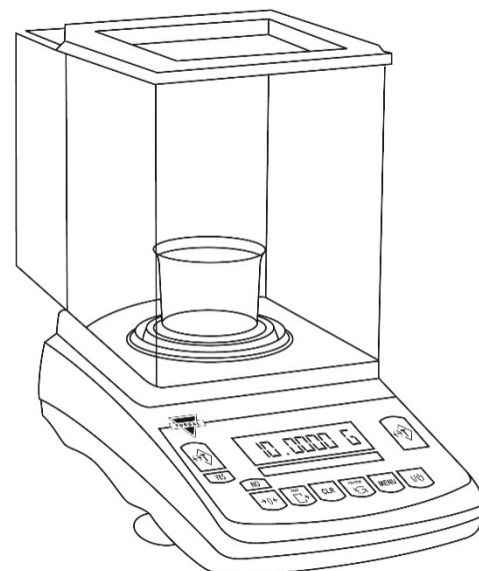
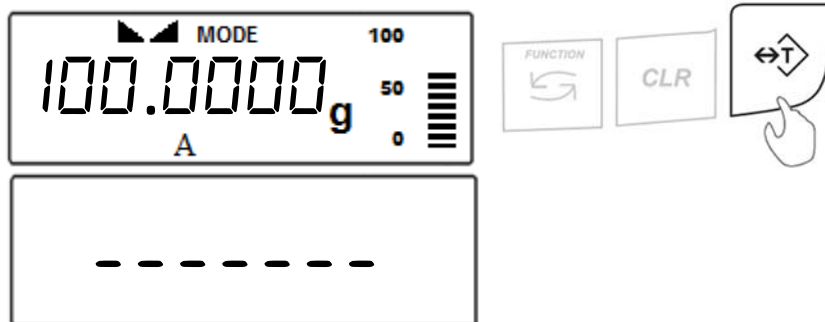

3. Once the scale has been tared, carefully place the animal into the container.

### Automatic and Semi-Automatic:

When set to Automatic or Semi-Automatic, the scale will automatically begin the animal weighing process with the first weight reading.

**Note:** In Automatic and Semi-Automatic modes the minimum weighing mass must be equal to or greater than 10d. To see this limit expressed in grams turn to detailed specifications in Chapter 2.

### Manual:

When set to manual, animal weighing must be initialized manually by pressing the “FUNCTION” key.

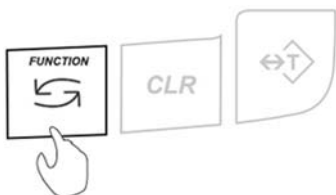

- Once the animal weighing process is initialized, the scale will display the time interval that was selected in the configuration mode and begin counting down. During the time interval the scale will record weight readings of the animal and calculate its average weight.

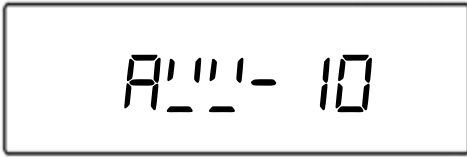

- After the time interval has elapsed the result will be displayed. The animal can now be removed from the pan.



- Clear the display.

**Automatic:**

When set to Automatic, the result will be automatically cleared after the animal is removed. The scale will perform an automatic tare and prepare for the next weighing.

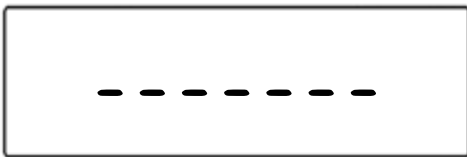

**Note:** If the weighing container is changed the scale must be tared manually by pressing the “T” key.

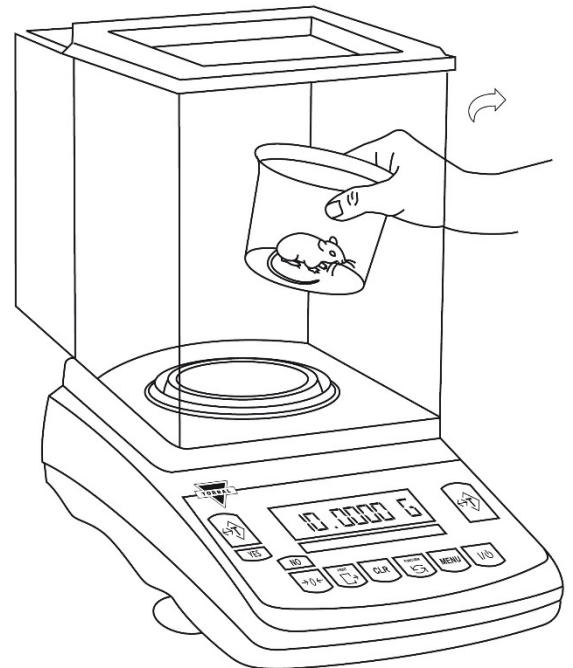
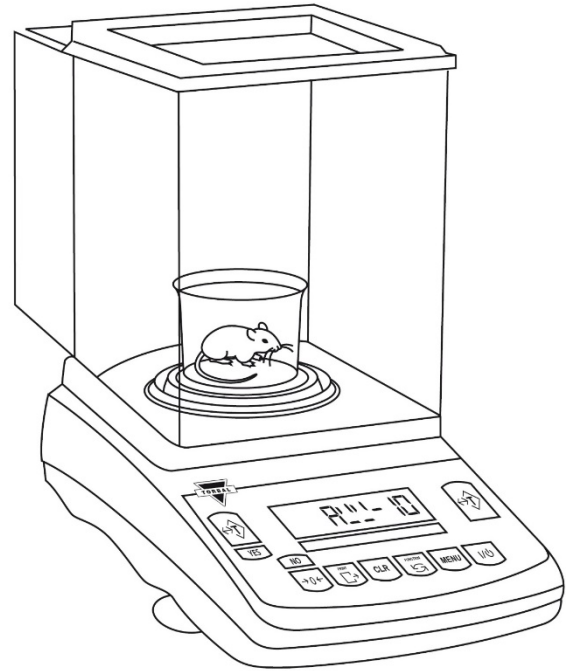

**Semi-Automatic and Manual:**

When set to Semi-Automatic or Manual, the weighing result will remain displayed and it must be manually cleared after the animal has been removed. To clear the weighing result, press the “C” key. After the result has been cleared, tare the scale by pressing the “T” key.

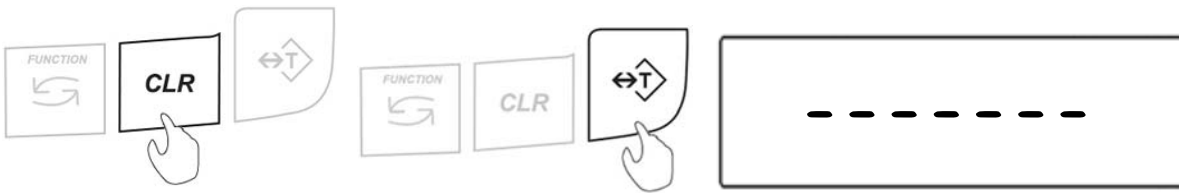

7. To exit animal weighing, press the “CLR” key to clear the function.

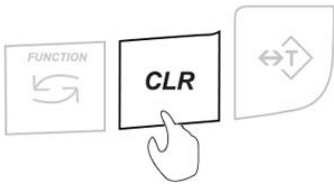

## Chapter 17: Parts Counting (PART5)

Parts Counting is used to count a batch of items based on their weight. A sample is taken to determine the average piece weight of the items. A “B” indicator will appear on the screen to indicate the scale is in Parts Counting mode.

1. To enter Parts Counting Mode, press the “Function” key. Select “PART5” by pressing the “T” key.

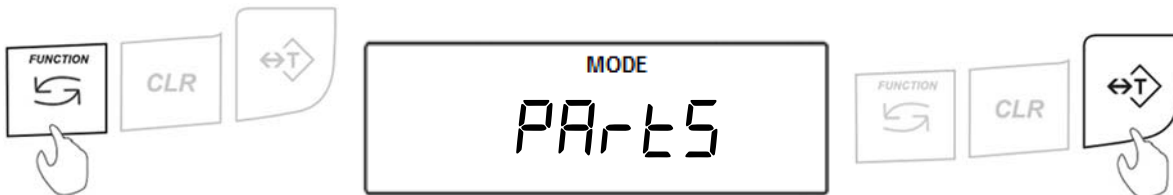

2. Place an empty weighing container on the pan. The container’s weight will be displayed. Wait for the weight to stabilize and press the “T” key to tare.

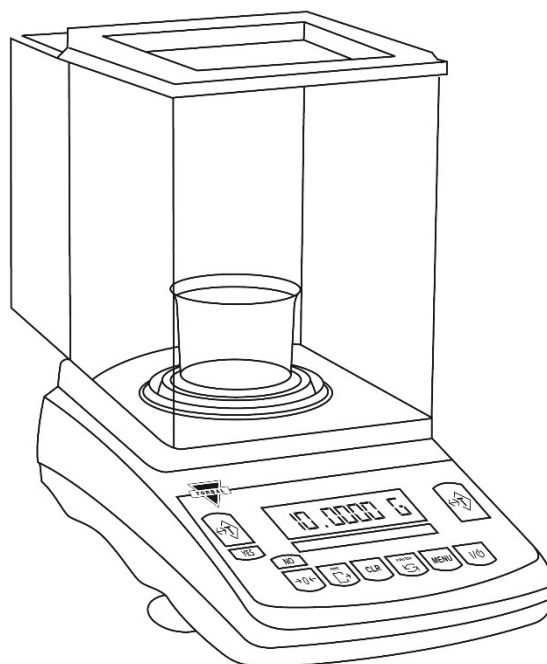
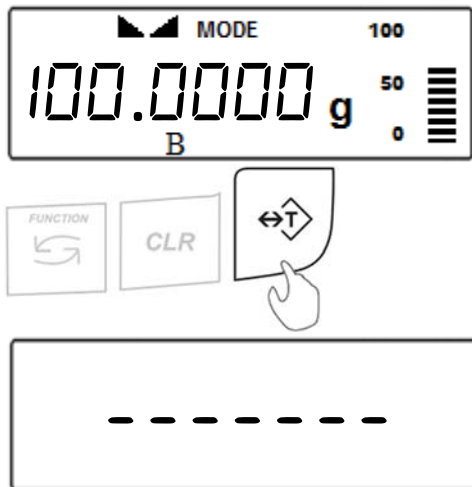

3. The default sample size that was previously configured will be displayed (**Example: SPL- 10**). To accept the sample size press the “T” (YES) key. To change the sample size press the “→0←” (NO) key.



The sample size selection ranges from 1 to 100. Quickly press and release the “→0←” (NO) key to change the sample size by increments of one. By pressing and holding the “→0←” (NO) key, the sample size will change in increments of five. Once a desired sample size is displayed, press the “T” (YES) key to accept and confirm the selection.

- After confirming the sample size, the display will read “SAPL 0n.” Place the sample into the weighing container.

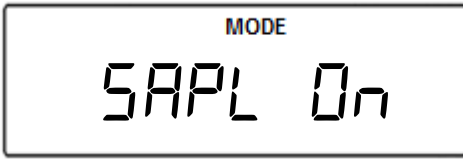
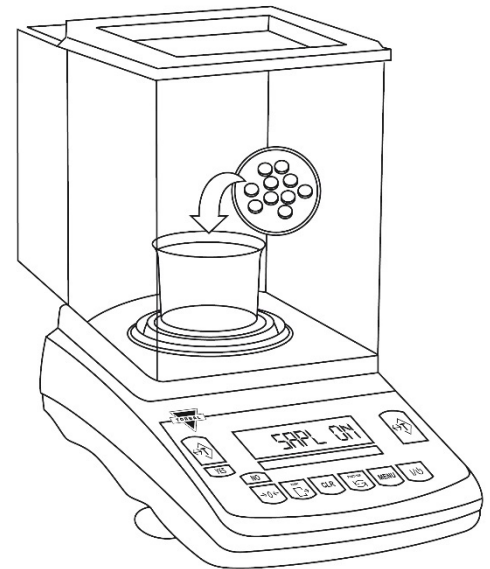

**Note:** Minimum individual piece weight must be equal to or greater than 3e. Attempting to set an average individual piece weight which is lower than 3e will result in a Sample Low Error (SAPL LE). To see this limit expressed in grams turn to detailed specifications in Chapter 2.

- The total weight of the sample will be displayed. Once the reading stabilizes, press the “T” key to accept the sample weight.

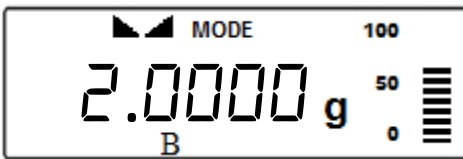
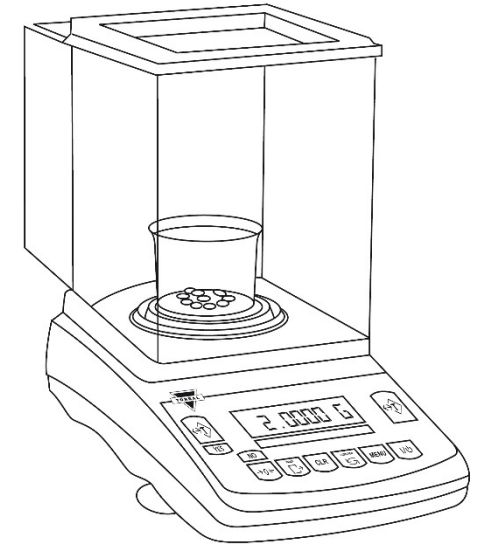

- The scale will flash “Fi LL” and then display the sample size (Example: 10 pcs) indicating to begin filling the remainder of the count. Begin to pour the pills into the container.

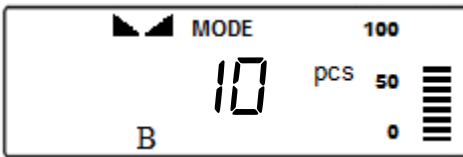
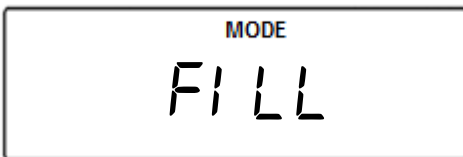
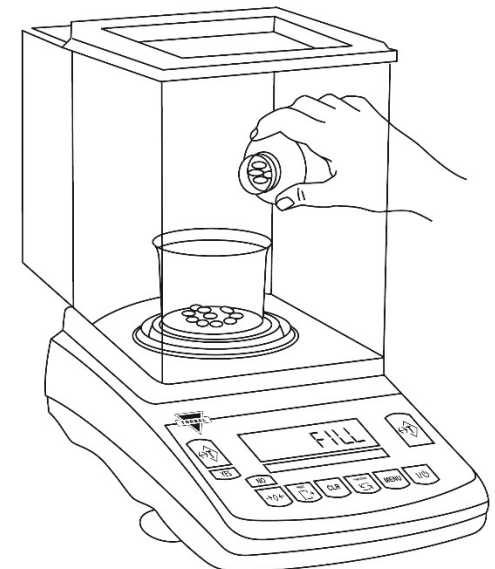

- The display will now indicate the number of pieces placed in the container. Stop filling when the desired count has been reached.

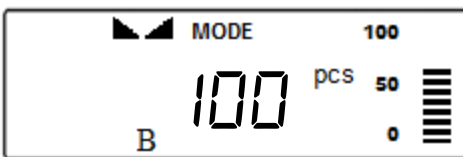

8. Once an accurate piece count has been taken, the container and its contents may be removed from the scale.
  
9. After the container with the counted pieces has been removed, the command “---, COUNT FInI SH, tO StARt COUNT Pr-ESS C” will appear on the display sequentially. Press the “CLR” key to begin a new count.

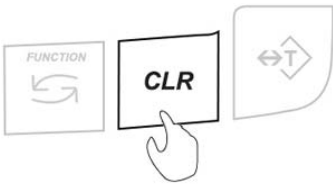
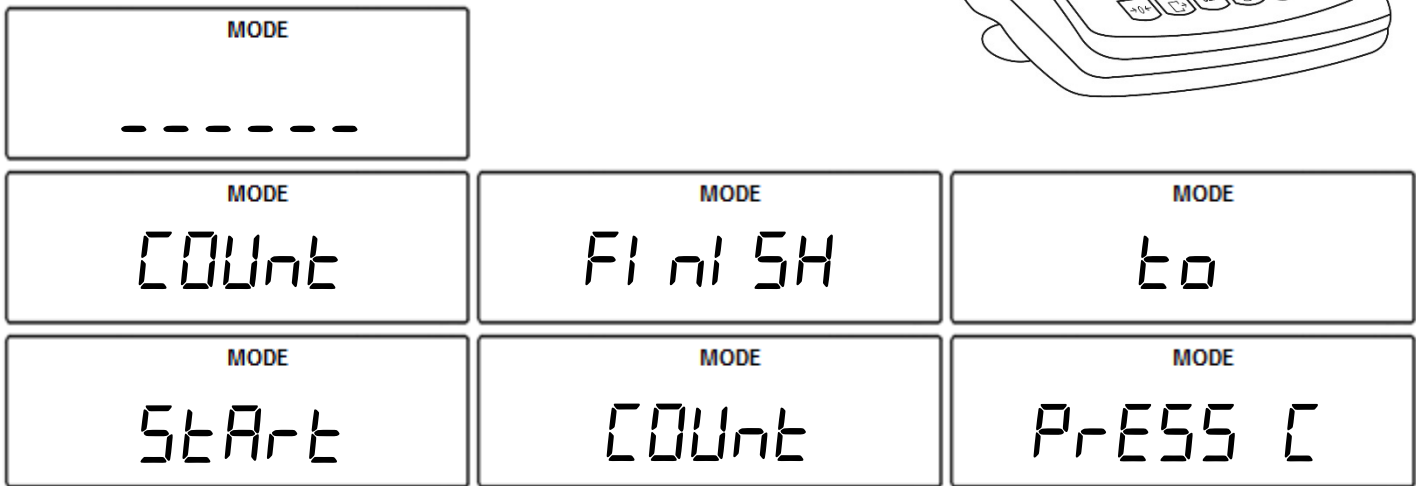
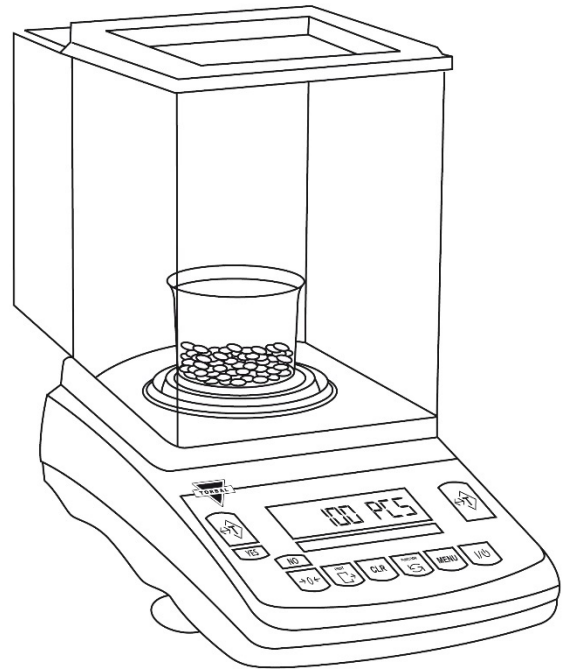

**Note:** If too many pieces have been placed into the container, remove the excess while the container is still on the scale’s pan. You may also remove the container from the pan, remove the extra pieces, and place it back on the pan to recheck the count. This may be performed while command “---, COUNT FInI SH, tO StARt COUNT Pr-ESS C” is displayed, but before pressing the “CLR” key. Once the “CLR” key is pressed the counting operation will reset.

10. To exit Parts Counting, press the “CLR” key to clear the function.

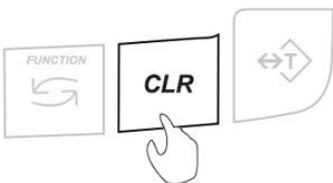

## Chapter 18: Check Weighing (CHECK)

The check weighing function is used to compare the weight of an object against a preset target range. To set the limits and use the check weighing function follow the steps below. A “C” indicator will appear on the screen to indicate the scale is in Check Weighing mode.

1. To enter Check Weighing Mode, press the “Function” key. Select “CHECK” by pressing the “T” key.

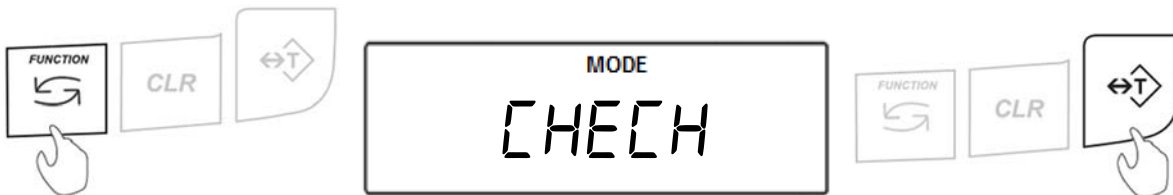

2. The current, set UNDER-limit and the command “Under” will appear on the display sequentially. To accept the current UNDER-limit, press the “T” (Yes) key. To change the limit, press the “→0←” key.

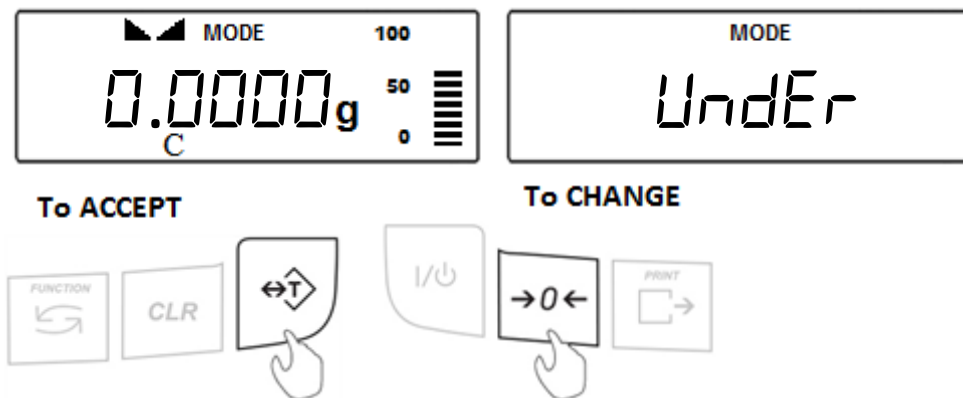

**Note:** The UNDER-limit displayed will be from the last time the function was used. If this is the first time the Check Weighing function is used, the limit will be set to 0.000g.

To enter a weight, use the following keys: the “→0←” (NO) key to increment a digit; “T” (YES) key to accept and go to the next digit; “P” key to insert a decimal; “FUNCTION” key to accept the entire setting; and “CLR” key to clear and start over. To become familiar with setting the weight limits, see **Table 16.1**.

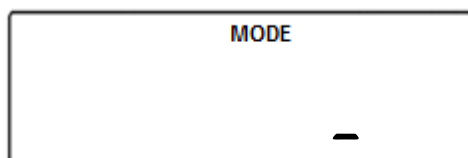



**Table 18.1; Example: Setting a weight limit of 20.123g**

Current display	Action to take	Key to use	Number of depressions	Display becomes
-	Increment the digit	→0← (No)	3	2
2	Accept and go to next digit	T (Yes)	1	20
20	Insert a decimal	Print	1	20.0
20.0	Increment the digit	→0← (No)	1	20.1
20.1	Accept and go to next digit	T (Yes)	1	20.10
20.10	Increment the digit	→0← (No)	2	20.12
20.12	Accept and go to next digit	T (Yes)	1	20.120
20.120	Increment the digit	→0← (No)	3	20.123
20.123	Accept the entire setting	FUNCTION	1	--

3. After setting the *UNDER*-limit, the current, set *OVER*-limit and the command “*OVER*” will appear on the display sequentially. To accept the current *OVER*-limit, press the “T” (Yes) key. To change the limit, press the “→0←” key.



To ACCEPT

To CHANGE



**Note:** The *OVER*-limit displayed will be from the last time the function was used. If this is the first time the Check Weighing function is used, the limit will be set to 0.000g.

To change the *OVER*-limit, follow the directions in **Steps 3 - 4** of this section and **Table 18.1**.

4. Once both limits have been set the scale will display “*TARE*”. Place a container on the pan and press the “T” key to tare.

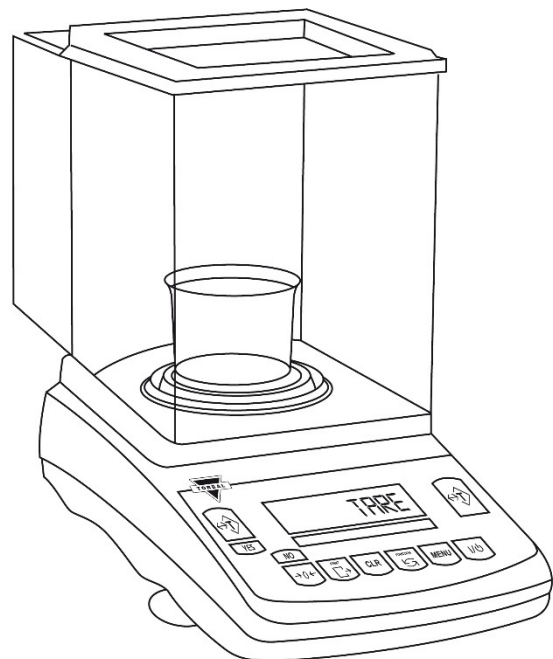
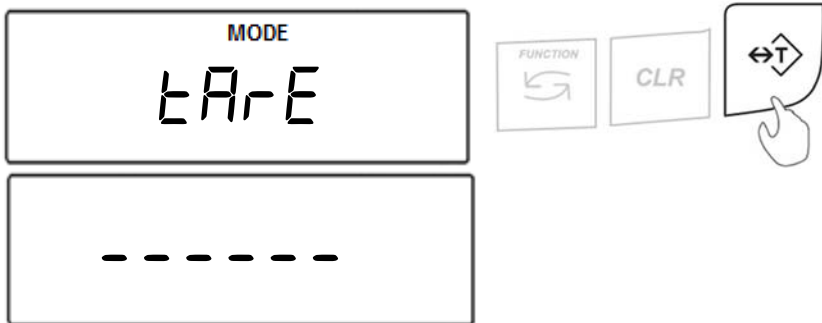

- The scale is now ready to use. To perform check weighing place your object on the pan to check whether the weight of the object falls within the designated range. If the weight is less than the lower limit the scale will display the weight of the object and the command "UndEr". If the weight falls within the range, the "ACCEPt" command will be displayed. If the weight exceeds the upper limit, the scale will display "OuEr".

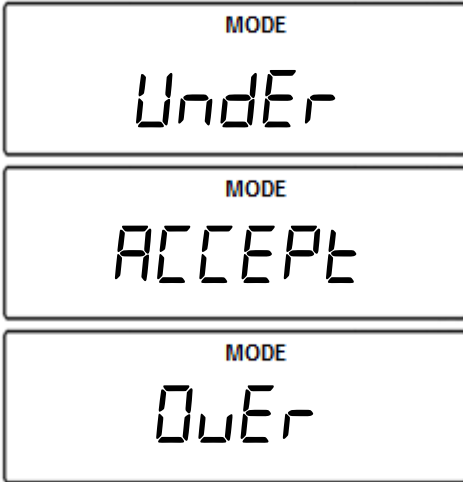
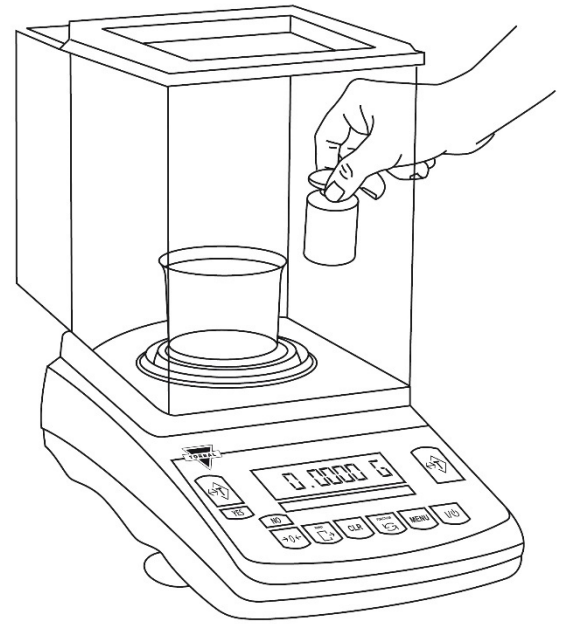

**Note:** To change the limit setting press "CLR" and repeat Steps 1 to 7. If the same limits are used, the scale can be tared without clearing the function and the new object can be weight-checked.

- To exit Check Weighing, press the "CLR" key to clear the function.

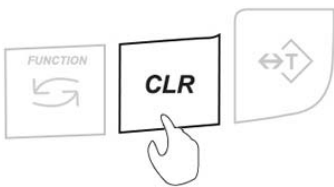
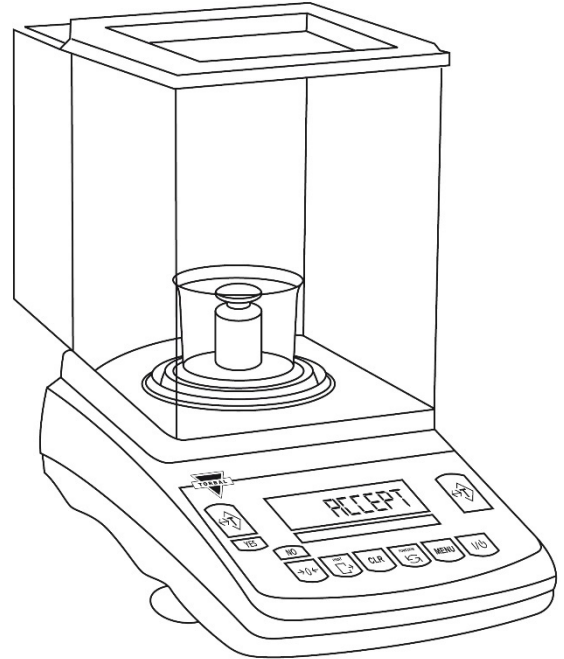

## Chapter 19: Display Hold (dI SPLAY)

Display Hold is used to lock a weight reading on the screen, even after the weighed object has been removed from the pan. A “D” indicator will appear on the screen to indicate the scale is in Display Hold mode.

1. To enter Display Hold Mode, press the “Function” key. Select “dI SPLAY” by pressing the “T” key.

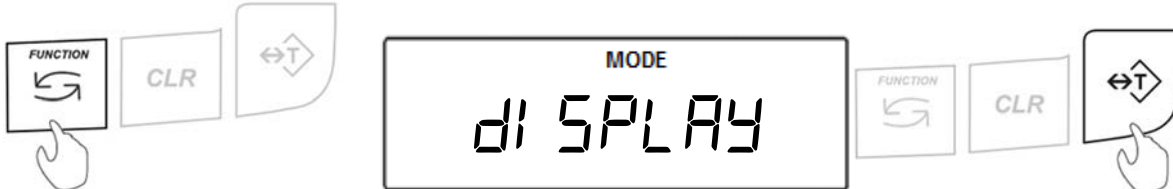

2. Place an empty weighing container on the pan. The container’s weight will be displayed. Wait for the weight to stabilize and press the “T” key to tare.

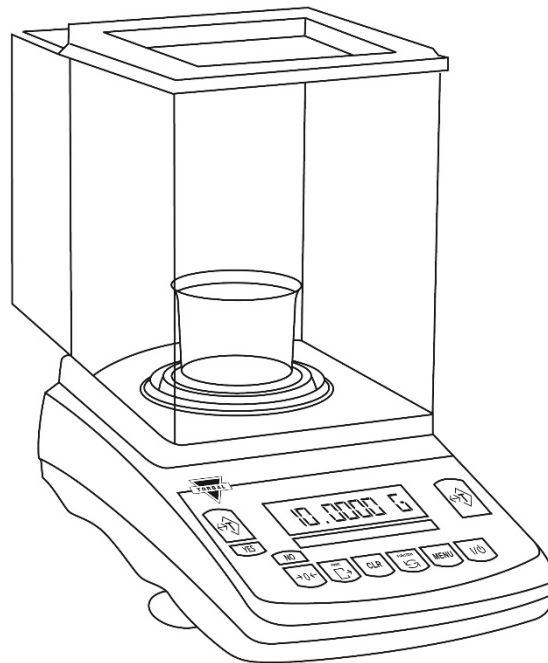
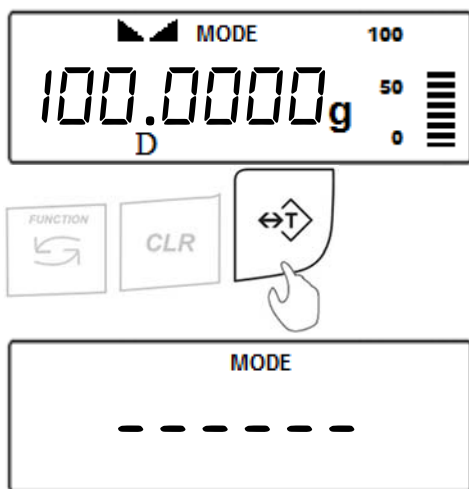

3. Place an object into the container.

### Automatic and Semi-Automatic:

When set to Auto or Semi-Auto, the scale will automatically lock the weighing result on the screen after it stabilizes. A display locked indicator will appear on the screen.

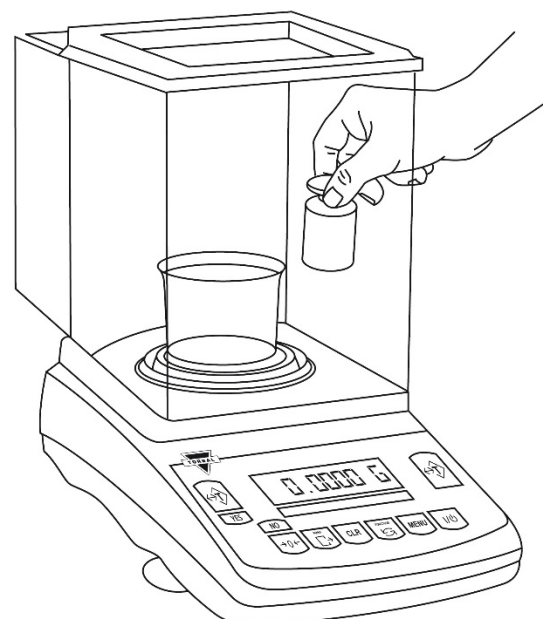
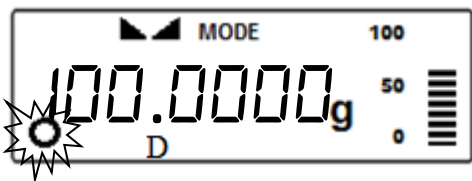

**Note:** In Automatic and Semi-Automatic modes the minimum weighing mass must be equal to or greater than 10d. To see this limit expressed in grams turn to the detailed specifications in Chapter 2.

**Manual:**

When set to Manual, press the “FUNCTION” key to lock the result on the screen.

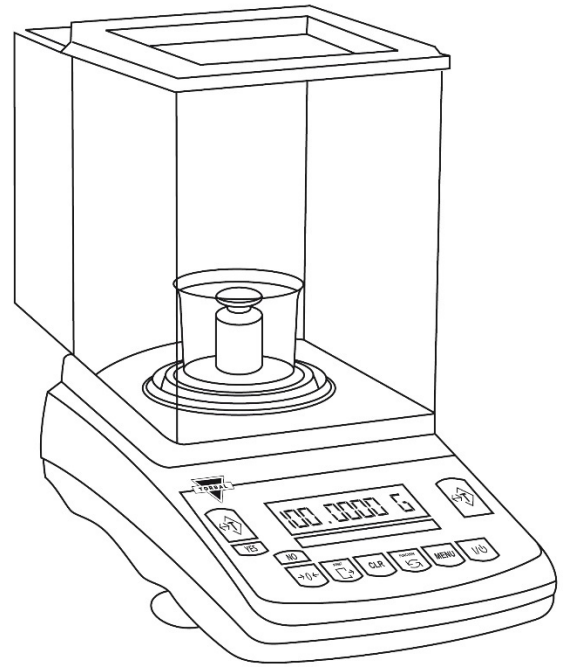

4. Clearing the display

**Automatic:**

When set to Automatic, the scale will automatically clear the result from the screen when the weight is removed from the container. The scale will perform an automatic tare and prepare for the next weighing.

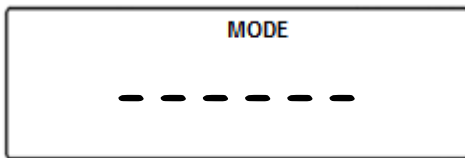

**Note:** If the weighing container is changed the scale must be tared manually by pressing the “T” key.

**Semi-Automatic and Manual:**

When set to Semi-Automatic or Manual, press the “CLR” key to remove the weighing result from the screen. Press the “T” key to tare the scale.

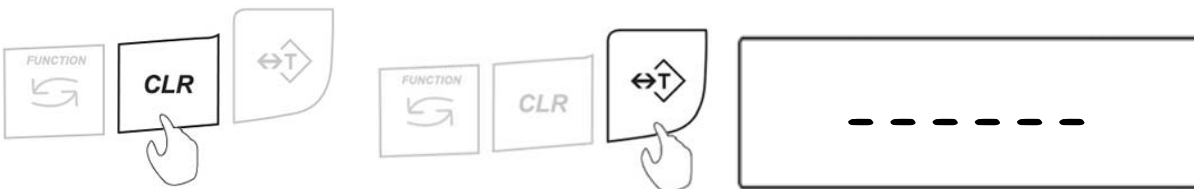

5. To exit Display Hold, press the “CLR” key.



# Chapter 20: Percent Weighing (PERCENT)

Percent Weighing is used to compare the relative weight of an unknown item to that of a previously stored sample. An “E” indicator will appear on the screen to indicate the scale is in Percent Weighing mode.

1. To enter Percent Weighing Mode, press the “Function” key. Select “PERCENT” by pressing the “T” key.

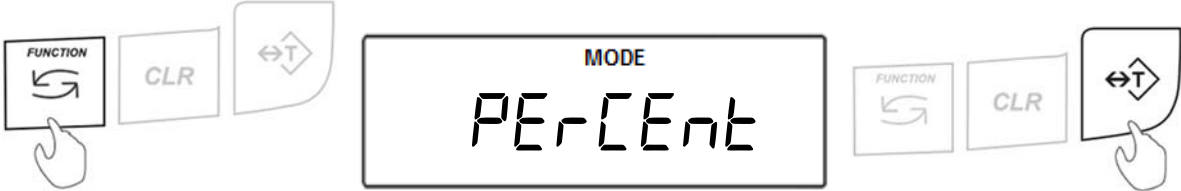

2. Place an empty weighing container on the pan. The container’s weight will be displayed. Wait for the weight to stabilize and press the “T” key to tare.

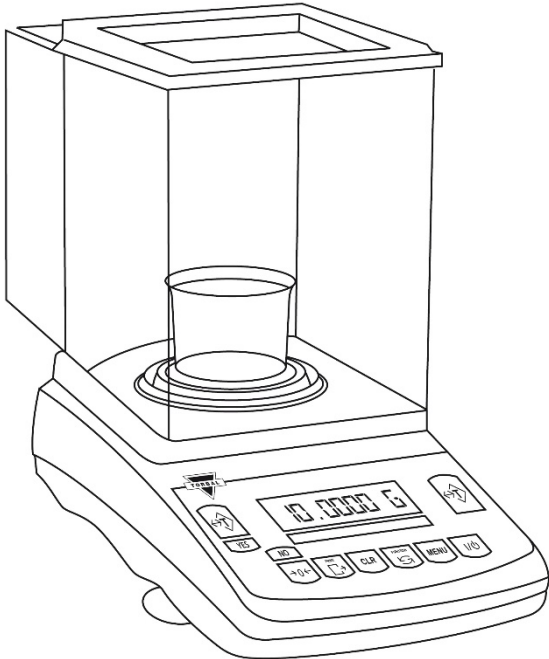
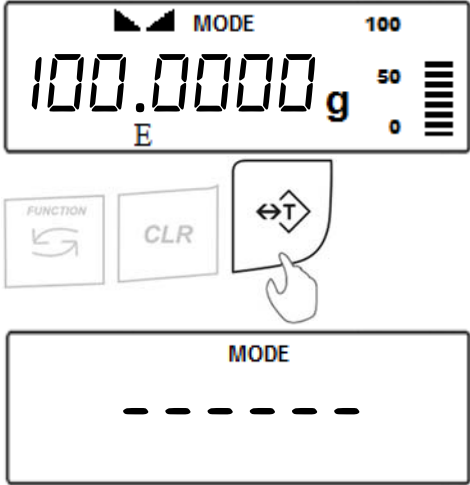

3. The scale will display the weight of the previously stored sample and the command “SAMPLE” sequentially. To accept the current sample weight, press the “T” (Yes) key. To change the sample weight, press the “→0←” key.

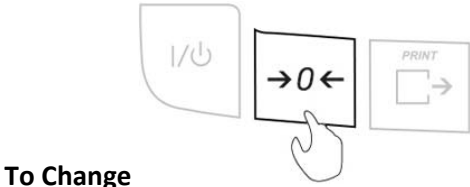
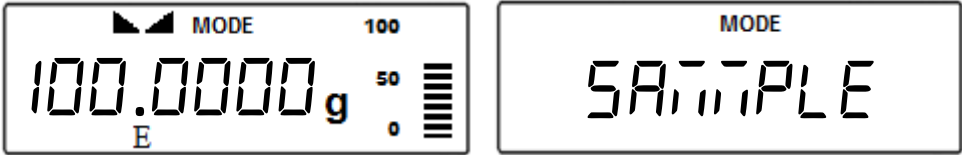

**Note:** If this is the first time the function is used, the sample weight will be 0.000g.

To change the sample weight, place a new sample in the weighing container when “SAPL 0n” is displayed. Once stabilized, press the “T” (Yes) key to accept the new weight.

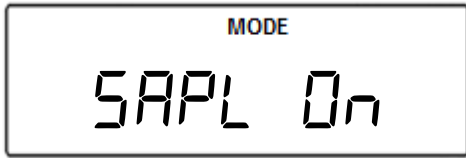
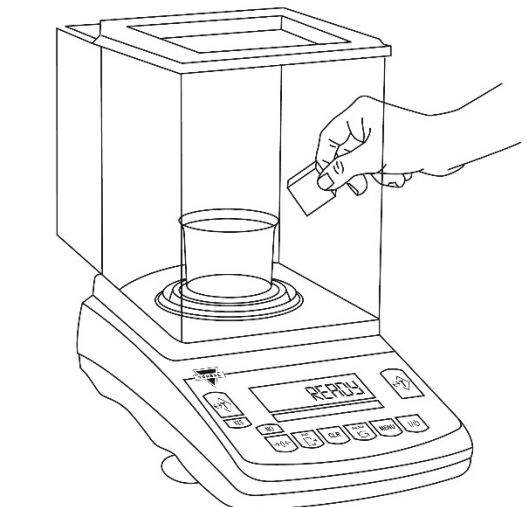
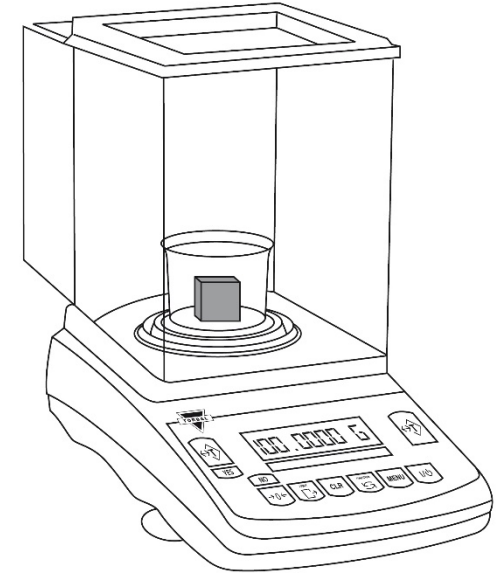
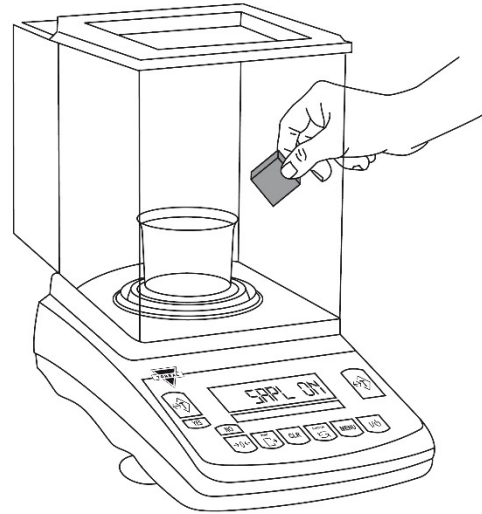

**Note:** The reference sample must be equal to or greater than 100d. Attempting to set a sample lower than 100d will result in a “SAPL L0” error.

4. After setting the sample weight, the command “rEAdy” will be displayed. Remove the sample and place the object on the pan.

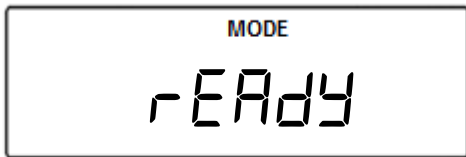

- The scale will express the weight of the object as a percentage of the stored sample.

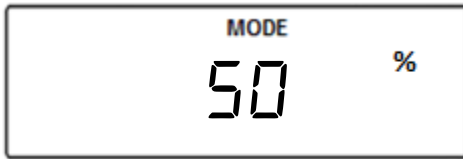

**Note:** To change the initial sample press “CLR” and repeat Steps 1 to 3. If the same sample weight is used, the scale can be tared without clearing the function and new objects can be weighed.

- To exit Percent Weighing, press the “CLR” key.

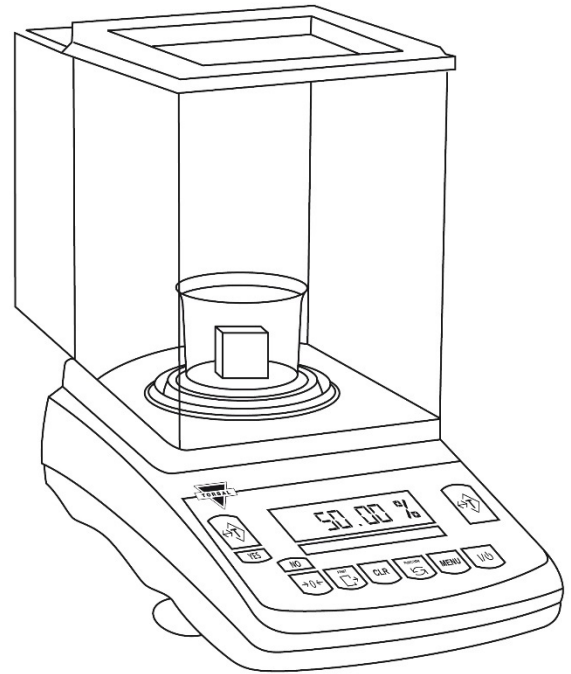
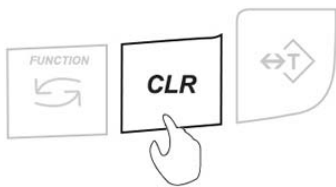

# Chapter 21: Totalizing (TOTAL)

Totalizing is used to calculate the summation of multiple weights that are recorded sequentially. An “F” indicator will appear on the screen to indicate the scale is in Totalizing Mode.

1. To enter Totalizing Mode, press the “Function” key. Select “TOTAL” by pressing the “T” key.

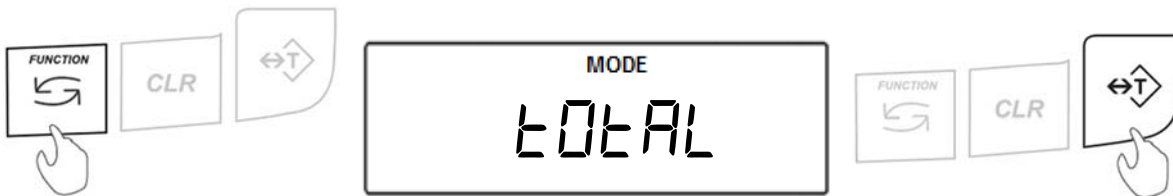

2. Place an empty weighing container on the pan. The container’s weight will be displayed. Wait for the weight to stabilize and press the “T” key to tare.

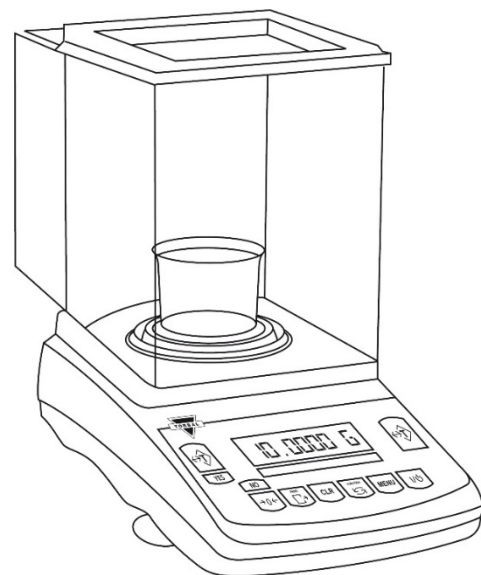
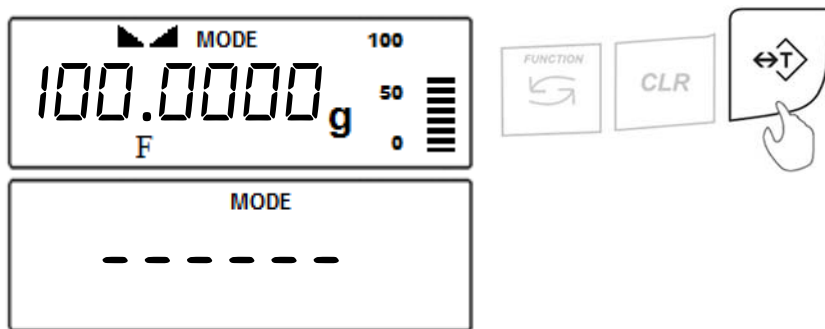

3. Place the first object in the container.

### Automatic and Semi-Automatic:

When set to Auto or Semi-Auto, the weight of the object will be added to the total automatically. A *TOTAL* indicator will appear on the display.

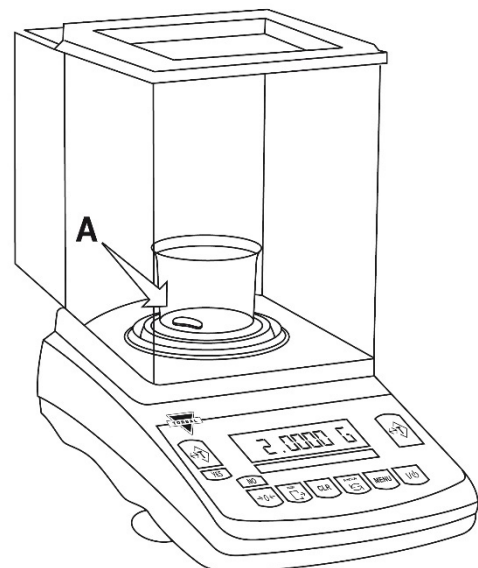
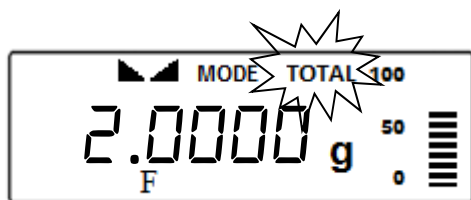

**Note:** In Automatic the minimum weight must be equal to or greater than 10d.



**Manual:** When set to Manual, press the “FUNCTION” key to add the weight to the total. A *TOTAL* indicator will appear on the display.

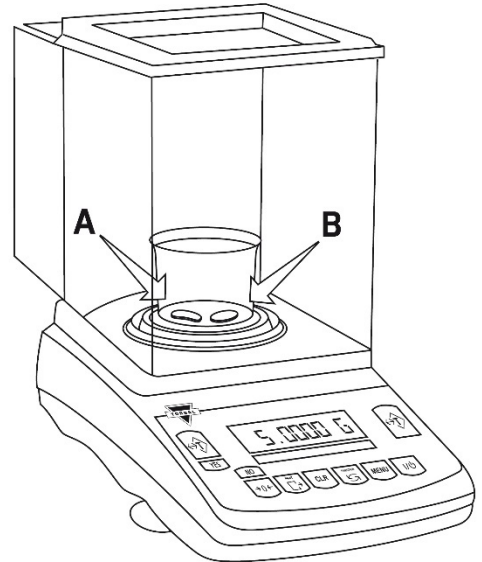

**Note:** With each added weight, the grand total result will appear on the display for approximately three seconds. To recall the grand total at any time, press the “MENU” key.

- Once a weight has been added to the total, remove the object from the pan or press the “T” key.

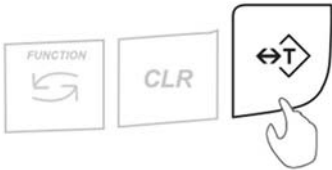

- Repeat **Steps 3 – 4** for the remainder of the samples.

- To clear the grand total and reset the function press the “CLR” key. “YES-NO” will appear on the display. To clear the function, press the “T” (Yes) key. To cancel the clear, press the “→0←” key.

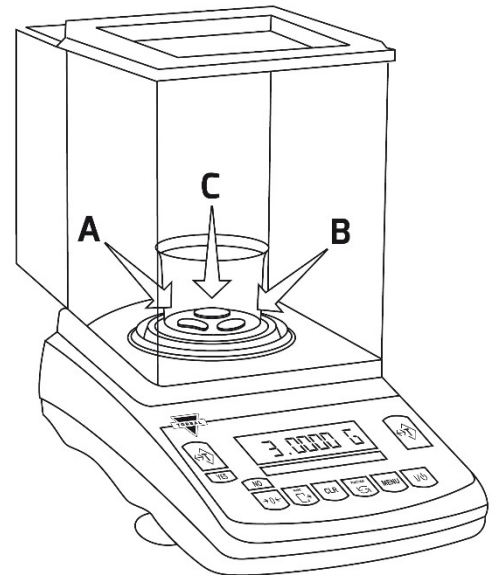

**To ACCEPT**

**To CHANGE**



- To obtain the total press the M key. To reset the compounding function and start a new recipe press the CLR key again while the total is displayed.

- To print the recipe, press the Print key.

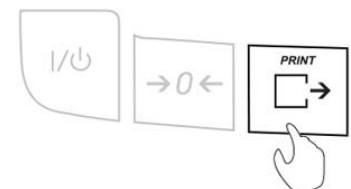

## Chapter 22: Density Measurement

The density calculation feature is used to assist in calculation of density in solids and liquids. To perform density calculation, a Density Kit (part no. AGC9171) is required.

Calculation Formula

SOLID	LIQUID
$\rho = \frac{m_1}{m_1 - m_2} * \rho$	$\rho = \frac{m_1 - m_2}{V}$
m 1 – mass calculation in air m 2 – mass calculation in liquid	m 1 – mass of the plunger in air m 2 – mass of the plunger in liquid V – Volume of the plunger

### 22.1 Solid

- To enter Density measurement, press the “Function” key. Select “dEnS i tY” by pressing the “T” key.

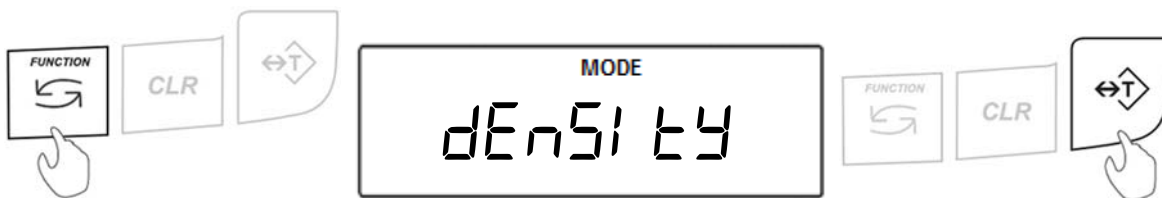

- Press the T key to tare the balance

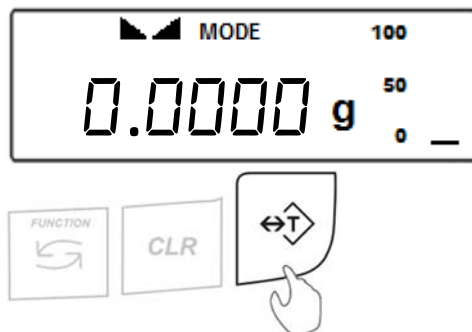

- Once the scale has been tared, place the solid object on the upper pan of the density kit to perform a weighing

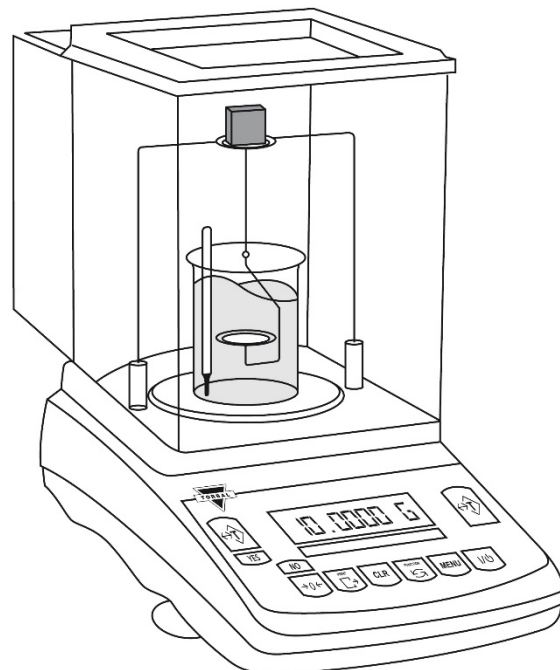

- Once the weight of the object stabilizes, press the Print key. M1 “ $\bar{\rho}$ ” will be displayed indicating that the weight of the object in air has been stored in the formula.

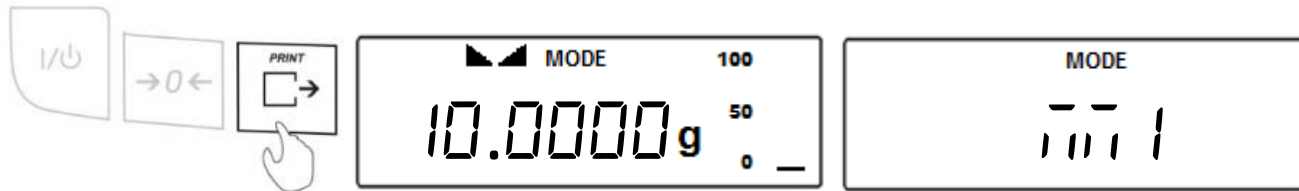

- Remove the object from the upper pan of the density kit and place it on the lower pan of the density kit to perform a weighing in liquid.
- Once the weight of the object stabilizes, press the Print key. M2 “ $\bar{\rho}$ ” followed by command RESULT “ $\bar{\rho}$ RESULT” will be displayed, indicating that the weight of the solid in the liquid has been stored in the formula and the density calculation has been performed.

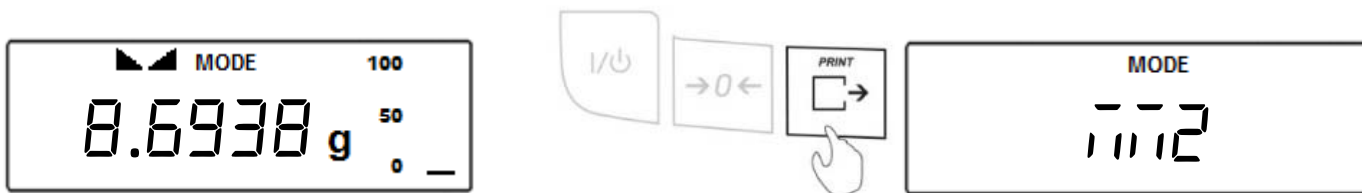
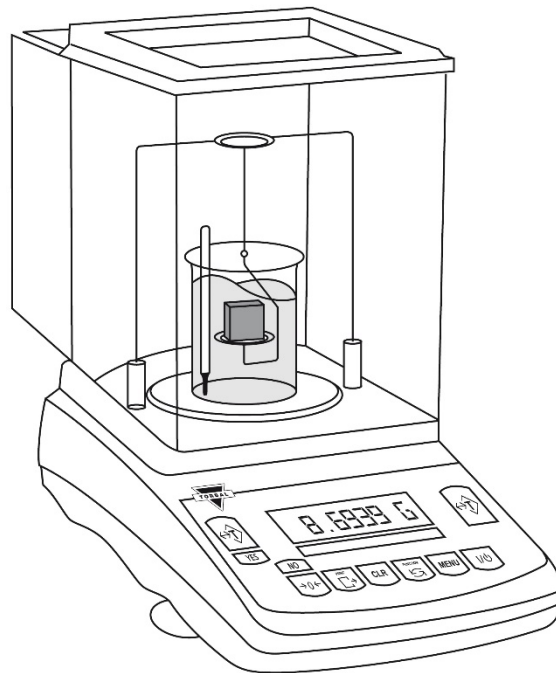

- The density of the object will be displayed and locked on the LCD.



- If a printer or a computer is connected to the scale, you may print detailed results of the performed density calculation by pressing the key.

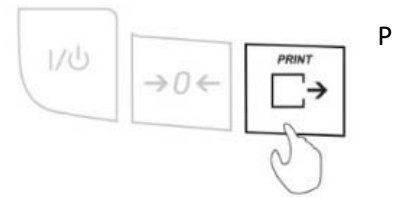

## 22.2 Liquid

- To enter Density measurement, press the “Function” key. Select “dEnS i tY” by pressing the “T” key.

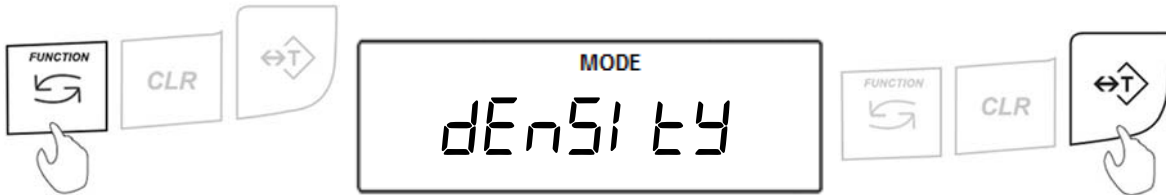

- Press the T key to tare the balance

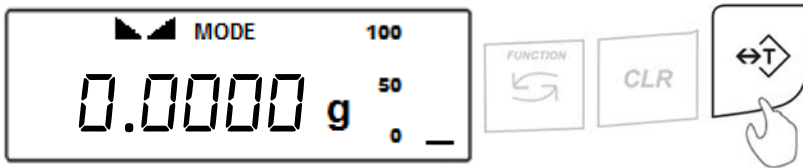

- Once the scale has been tared, hang the plunger on the wire support frame of the density apparatus.
- The weight of the plunger will be displayed. Once the weight is stable, press the Print key. M1 “m l” will be displayed, indicating that the weight of the plunger has been stored in the formula.

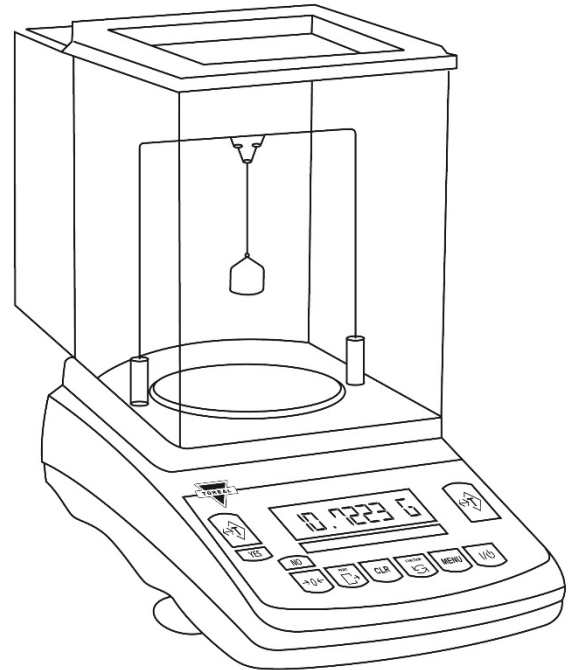
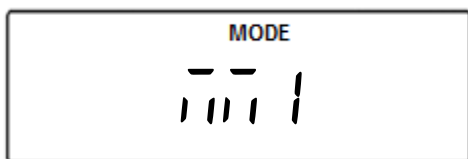
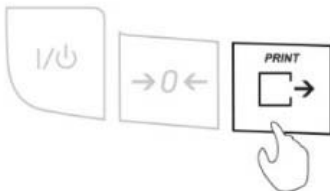
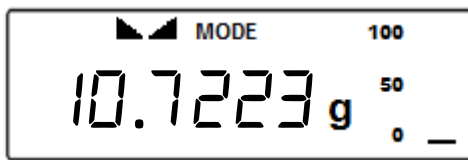

5. Submerge the plunger, by placing the beaker with the liquid on the base of the density apparatus.
6. As the plunger displaces the liquid in which it is submerged, the weight will decrease. Once the new weight stabilizes, press the Print key. M2 "1112" followed by RESULT "rESULT" will be displayed indicating that the new weight of the plunger has been stored in the formula and the density calculation has been performed.

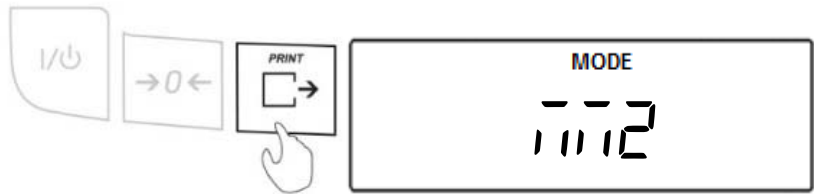
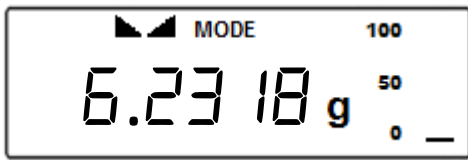
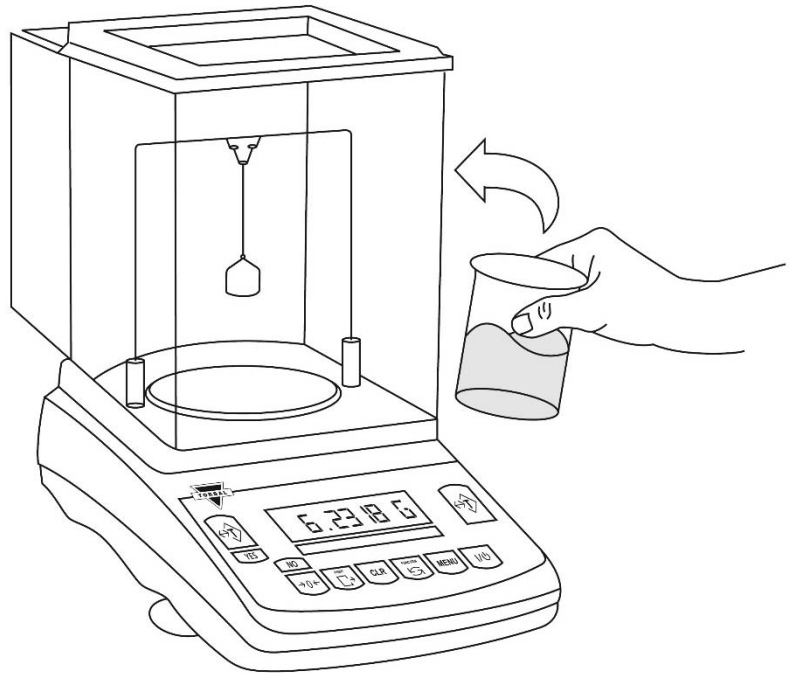

7. The density of the liquid will be displayed and locked on the LCD.

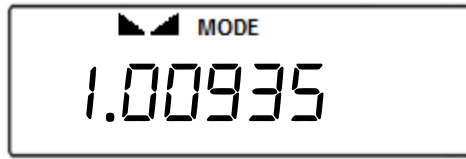
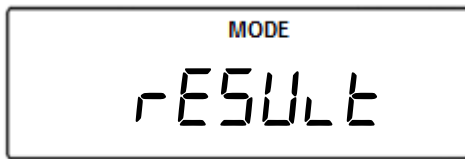

8. If a printer or a computer is connected to the scale, you may print detailed results of the performed density calculation by pressing the P key.

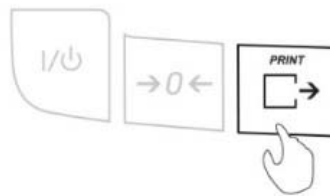



## Chapter 23: Common Errors and Trouble Shooting

Error or Indicator	Cause	Explanation / Solution
----	Below Zero	Re-zero the scale by pressing the “→0←” key.
--	Taring is not allowed	Place a weight on the pan before taking a tare.
- -	Re-zeroing is not allowed	Remove weight from the pan and clear stored tare values
L	Pan error	Make sure the pan is properly seated on the pan support.
H	Exceeded capacity	The scale has exceeded its weighing capacity. Reduce the weight.
Err – b	Pan not cleared on power-up	The pan was not empty while the scale was initiating at startup. Clear the pan and restart the scale.
Sapl LO (Parts Counting)	Average piece weight is too low	The average piece weight is lower than 3e. Be sure that individual piece weight is greater than 3e.
Sapl LO (Percent Weighing)	Sample reference weight is too low	The sample reference weight is lower than 100d. Increase the sample weight.
The scale will not turn on	Possible power failure	Check the power AC adapter connection.
Weighing results are not accurate	Inaccurate calibration	Calibrate the scale.
Weighing results are not stabilizing	Irregular environment	Eliminate drafts or vibrations.

## Chapter 24: Maintenance

### **Cleaning and maintaining your Prescription Scale:**

- Before cleaning the scale always unplug the A/C adapter from the electrical outlet.
- Use a soft, slightly damp cloth to clean the exterior housing of your scale.
- Wipe the scale gently. Do not allow any liquid to enter into the scale.
- Do not apply extensive pressure to the LCD display.
- Do not use chemicals or benzene when cleaning the surface. Corrosive chemicals may damage the finish.
- Alcohol may be used only to clean the scale's stainless steel pan or the draft ring.



## Chapter 25: Accessories

Description	Part No.
Draft Shield Cover (Select Models Only)	301086
Dust Cover	301056
RXP-4 Thermal Printer	301060
RS232 PC Cable	301058



## Chapter 26: Replacement Parts

Description	Part No.
A/C Adaptor	301054
Pan (115mm)	501094
Pan Base	501095
RS232 Printer Cable	-



## Chapter 27: Limited Warranty

### PURCHASER'S WARRANTY

**Warranty is valid only if your product has been registers within 30 days of receipt**

This product is a precision device made to exacting standards of scientific accuracy. It is guaranteed to have been adjusted and inspected for proper workmanship and performance, and certified for its currently advertised specifications before shipment. Scientific Industries' Products are warranted against defects in material and workmanship under normal use and service. This warranty is extended only to the first purchaser. This limited warranty will not apply if, upon inspection, it is found that the product was tampered with, misused, overloaded, or abused, mishandled, placed in an improper environment, improperly installed or adjusted, used for a purpose other than that for which it was designed, or repaired by unauthorized personnel. Scientific Industries' liability under this warranty is limited to furnishing labor and parts necessary to remedy the defect covered by this warranty and restore the product to normal operating condition. Purchasers may be charged a minimum repair fee for in-warranty products returned for repair if those products are determined to be problem-free. To make a claim under this limited warranty, you must first obtain an RMA number from Scientific Industries and return the product carefully packed, in its original packaging, shipping prepaid, with the RMA number written on the return package.

EXCEPT FOR THE LIMITED WARRANTY PROVIDED HEREIN, ALL OTHER WARRANTIES, EXPRESS AND IMPLIED, INCLUDING MERCHANTABILITY AND FITNESS FOR A PARTICULAR PURPOSE, ARE DISCLAIMED. In all events, consequential, incidental, special and other damages are excluded and Scientific Industries, Inc. shall have no liability beyond the repair or replace limited warranty provided above.



**SI** *Division of*  
**Scientific Industries, Inc.**

**Scientific Industries, Inc.**

80 Orville Dr.

Bohemia, NY 11716

Tel. (973)473-6900

Fax. (973)777-8302

[www.torbalscales.com](http://www.torbalscales.com)