



**THE DISPLAY CHOICE  
OF PROFESSIONALS™**

**NSD-6501Q, NSD-7501Q & NSD-8601Q LCD Display**

[www.agneovo.com](http://www.agneovo.com)

# **User Manual**

# TABLE OF CONTENTS

<b>SAFETY INFORMATION .....</b>	<b>1</b>
Federal Communications Commission (FCC) Notice (U.S. Only).....	1
CE .....	1
Electric, Magnetic and Electromagnetic Fields (“EMF”).....	2
Information for U.K. only.....	3
North Europe (Nordic Countries) Information.....	4
End-of-Life Disposal .....	5
Waste Electrical and Electronic Equipment-WEEE.....	5
Turkey RoHS .....	6
Ukraine RoHS .....	6
<b>PRECAUTIONS .....</b>	<b>7</b>
Cautions When Setting Up .....	7
Cautions When Using.....	8
Cleaning and Maintenance.....	8
Notice for the LCD Display .....	9
<b>CHAPTER 1: PRODUCT DESCRIPTION.....</b>	<b>10</b>
1.1 Unpacking .....	10
1.2 Package Contents .....	10
1.3 Preparing for the Installation .....	11
1.4 Wall Mounting Installation.....	11
1.4.1 VESA Grid .....	12
1.4.2 Ventilation Requirements for Enclosure Locating.....	13
1.5 Using the Remote Sensor and Power Status Indicator .....	13
1.6 LCD Display Overview .....	14
1.6.1 Control Panel.....	14
1.6.2 Input/Output Terminals .....	16
1.7 Remote Control .....	18
1.7.1 General Functions .....	18
1.7.2 ID Remote Control.....	20
1.7.3 Remote Control buttons on Android source .....	21
1.7.4 Inserting the Batteries in the Remote Control .....	23
1.7.5 Handling the Remote Control .....	23
1.7.6 Operating Range of the Remote Control.....	23
<b>CHAPTER 2: MAKING CONNECTIONS.....</b>	<b>25</b>
2.1 Connecting the Power .....	25
2.2 Connecting a Computer .....	27
2.2.1 Using VGA Input .....	27
2.2.2 Using DisplayPort Input.....	28
2.2.3 Using HDMI Input .....	30
2.3 Connecting External Equipment (Video Player).....	31
2.3.1 Using HDMI Video Input.....	31

# TABLE OF CONTENTS

2.4 Connecting Audio Equipment.....	33
2.4.1 Connecting an External Audio Device .....	33
2.5 Using the Card Reader.....	34
2.6 Connecting Multiple Displays in a Daisy-chain Configuration .....	35
2.6.1 Display Control Connection.....	35
2.7 IR Connection.....	36
2.8 IR Pass-Through Connection.....	36
<b>CHAPTER 3: USING THE LCD DISPLAY.....</b>	<b>37</b>
3.1 Turning on the Power .....	37
3.1.1 Initial Setup.....	37
3.2 Selecting the Input Source Signal .....	38
3.3 Adjusting the Volume.....	38
3.4 Changing the Picture Format .....	39
<b>CHAPTER 4: MULTIMEDIA MENU .....</b>	<b>40</b>
4.1 Accessing the Multimedia Menu.....	40
4.2 Media Player .....	41
4.2.1 Creating a Playlist .....	41
4.2.2 Modifying a Playlist.....	43
4.2.3 Playing Files in a Playlist.....	43
4.2.4 Media Player Settings .....	44
4.3 Browser .....	45
4.3.1 Adding an URL .....	45
4.3.2 Managing URLs List.....	47
4.4 Cloud Content Management Software (Cloud CMS) .....	48
4.5 PDF Player.....	49
4.5.1 Creating a Playlist .....	49
4.5.2 Modifying a Playlist.....	51
4.5.3 Displaying PDF Files in a Playlist.....	51
4.5.4 PDF Player Settings .....	51
4.6 Custom .....	52
4.6.1 Entering the Admin Mode .....	52
4.6.2 System Settings .....	53
4.6.3 Accessing Apps in Admin Mode .....	55
4.6.4 Displaying Content via CMS App .....	55
4.6.5 Installing Apps to the LCD Display .....	58
4.6.6 Accessing Network Settings in Admin Mode .....	58
4.6.7 Managing Storage in Admin Mode .....	59
<b>CHAPTER 5: ON SCREEN DISPLAY MENU.....</b>	<b>60</b>
5.1 Using the OSD Menu .....	60
5.2 OSD Menu Tree .....	62

# TABLE OF CONTENTS

<b>CHAPTER 6: ADJUSTING THE LCD DISPLAY .....</b>	<b>64</b>
6.1 Picture Settings .....	64
6.2 Screen Settings .....	68
6.3 Audio Settings .....	70
6.4 Configuration1 Settings .....	72
6.5 Configuration2 Settings .....	76
6.6 Advanced option Settings .....	78
<b>CHAPTER 7: APPENDIX.....</b>	<b>89</b>
7.1 Warning Messages.....	89
7.2 Supported Media Formats.....	89
7.3 Input Mode .....	91
7.4 Cleaning .....	93
7.5 Troubleshooting.....	94
7.6 Transporting the LCD Display .....	95
<b>CHAPTER 8: SPECIFICATIONS .....</b>	<b>98</b>
8.1 Display Specifications .....	98
8.2 Display Dimensions.....	100

# SAFETY INFORMATION

## Federal Communications Commission (FCC) Notice (U.S. Only)



This equipment has been tested and found to comply with the limits for a Class A digital device, pursuant to part 15 of the FCC Rules. These limits are designed to provide reasonable protection against harmful interference when the equipment is operated in a commercial environment. This equipment generates, uses, and can radiate radio frequency energy and, if not installed and used in accordance with the instruction manual, may cause harmful interference to radio communications. Operation of this equipment in a residential area is likely to cause harmful interference in which case the user will be required to correct the interference at his own expense.



Changes or modifications not expressly approved by the party responsible for compliance could void the user's authority to operate the equipment.

Use only an RF shielded cable that was supplied with the display when connecting this display to a computer device.

To prevent damage which may result in fire or shock hazard, do not expose this appliance to rain or excessive moisture.

THIS CLASS A DIGITAL APPARATUS MEETS ALL REQUIREMENTS OF THE CANADIAN INTERFERENCE CAUSING EQUIPMENT REGULATIONS.



This device complies with part 15 of the FCC Rules. Operation is subject to the following two conditions: (1) This device may not cause harmful interference, and (2) this device must accept any interference received, including interference that may cause undesired operation.

**CE**



**WARNING:** This equipment is compliant with Class A of EN55032/CISPR 32. In a residential environment this equipment may cause radio interference.

# SAFETY INFORMATION

## ***Wymagania Polskiego Centrum Badań i Certyfikacji***

Urządzenie powinno być zasilane z gniazda z przyłączonym obwodem ochronnym (gniazdo z kolkiem). Współpracujące ze sobą urządzenia (komputer, monitor, drukarka) powinny być zasilane z tego samego źródła.

Instalacja elektryczna pomieszczenia powinna zawierać w przewodzie fazowym rezerwową ochronę przed zwarciami, w postaci bezpiecznika o wartości znamionowej nie większej niż 16A (amperów).

W celu całkowitego wyłączenia urządzenia z sieci zasilania, należy wyjąć wtyczkę kabla zasilającego z gniazdką, które powinno znajdować się w pobliżu urządzenia i być łatwo dostępne.

Znak bezpieczeństwa "B" potwierdza zgodność urządzenia z wymaganiami bezpieczeństwa użytkownika zawartymi w PN-93/T-42107 i PN-89/E-06251.

## ***Pozostałe instrukcje bezpieczeństwa***

- Nie należy używać wtyczek adapterowych lub usuwać kolka obwodu ochronnego z wtyczki. Jeżeli konieczne jest użycie przedłużacza to należy użyć przedłużacza 3-żyłowego z prawidłowo połączonym przewodem ochronnym.
- System komputerowy należy zabezpieczyć przed nagłymi, chwilowymi wzrostami lub spadkami napięcia, używając eliminatora przepięć, urządzenia dopasowującego lub bezzakłóceńowego źródła zasilania.
- Należy upewnić się, aby nic nie leżało na kablach systemu komputerowego, oraz aby kable nie były umieszczone w miejscu, gdzie można byłoby na nie nadeptywać lub potykać się o nie.
- Nie należy rozlewać napojów ani innych płynów na system komputerowy.
- Nie należy wpychać żadnych przedmiotów do otworów systemu komputerowego, gdyż może to spowodować pożar lub porażenie prądem, poprzez zwarcie elementów wewnętrznych.
- System komputerowy powinien znajdować się z dala od grzejników i źródeł ciepła. Ponadto, nie należy blokować otworów wentylacyjnych. Należy unikać kładzenia luźnych papierów pod komputer oraz umieszczania komputera w ciasnym miejscu bez możliwości cyrkulacji powietrza wokół niego.

## **Electric, Magnetic and Electromagnetic Fields ("EMF")**

- We manufacture and sell many products targeted at consumers, which, like any electronic apparatus, in general have the ability to emit and receive electromagnetic signals.
- One of our leading Business Principles is to take all necessary health and safety measures for our products, to comply with all applicable legal requirements and to stay well within the EMF standards applicable at the time of producing the products.
- We are committed to develop, produce and market products that cause no adverse health effects.
- We confirm that if its products are handled properly for their intended use, they are safe to use according to scientific evidence available today.
- We play an active role in the development of international EMF and safety standards, enabling us to anticipate further developments in standardization for early integration in its products.

# SAFETY INFORMATION

## Information for U.K. only

WARNING - THIS APPLIANCE MUST BE EARTHED.

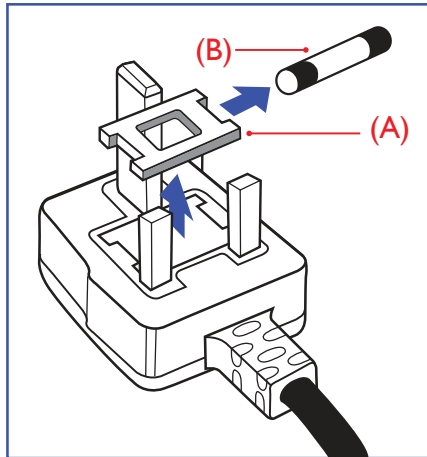

Important:

This apparatus is supplied with an approved moulded 13A plug. To change a fuse in this type of plug proceed as follows:

- 1 Remove fuse cover and fuse.
- 2 Fit new fuse which should be a BS 1362 5A, A.S.T.A. or BSI approved type.
- 3 Refit the fuse cover.

If the fitted plug is not suitable for your socket outlets, it should be cut off and an appropriate 3-pin plug fitted in its place.

If the mains plug contains a fuse, this should have a value of 5A. If a plug without a fuse is used, the fuse at the distribution board should not be greater than 5A.



Note:

The severed plug must be destroyed to avoid a possible shock hazard should it be inserted into a 13A socket elsewhere.

# SAFETY INFORMATION

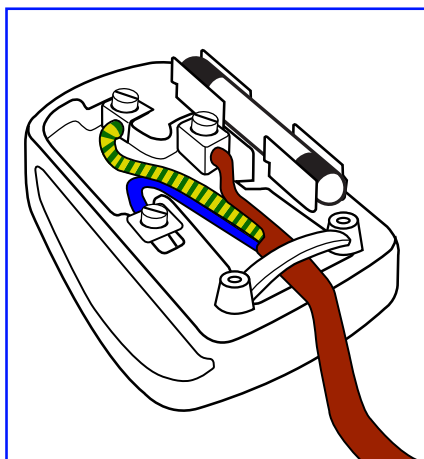

## How to connect a plug

The wires in the mains lead are coloured in accordance with the following code:

BLUE - "NEUTRAL" ("N")

BROWN - "LIVE" ("L")

GREEN & YELLOW - "EARTH" ("E")

- The GREEN & YELLOW wire must be connected to the terminal in the plug which is marked with the letter "E" or by the Earth symbol or coloured GREEN or GREEN & YELLOW.
- The BLUE wire must be connected to the terminal which is marked with the letter "N" or coloured BLACK.
- The BROWN wire must be connected to the terminal which marked with the letter "L" or coloured RED.

Before replacing the plug cover, make certain that the cord grip is clamped over the sheath of the lead - not simply over the three wires.

## North Europe (Nordic Countries) Information

Placering/Ventilation

**WARNING:** FÖRSÄKRA DIG OM ATT HUVUDBRYTARE OCH UTTAG ÄR LÄTÅTKOMLIGA, NÄR DU STÄLLER DIN UTRUSTNING PÅPLATS.

Placering/Ventilation

**ADVARSEL:** SØRG VED PLACERINGEN FOR, AT NETLEDNINGENS STIK OG STIKKONTAKT ER NEMT TILGÆNGLIGE.

Paikka/Ilmankierto

**VAROITUS:** SIJOITA LAITE SITEN, ETTÄ VERKKOJOHTO VOIDAAN TARVITTAESSA HELPOSTI IRROTTAA PISTORASIESTA.

Plassering/Ventilasjon

**ADVARSEL:** NÅR DETTE UTSTYRET PLASSERES, MÅ DU PASSE PÅ AT KONTAKTENE FOR STØMTILFØRSEL ER LETTE Å NÅ.



# SAFETY INFORMATION

## End-of-Life Disposal

Your new Public Information Display contains materials that can be recycled and reused. Specialized companies can recycle your product to increase the amount of reusable materials and to minimize the amount to be disposed of.

Please find out about the local regulations on how to dispose of your old display from your local dealer.

### (For customers in Canada and U.S.A.)

This product may contain lead and/or mercury. Dispose of in accordance to local-state and federal regulations. For additional information on recycling contact [www.eia.org](http://www.eia.org) (Consumer Education Initiative).

## Waste Electrical and Electronic Equipment-WEEE

### Attention users in European Union private households



Disposal of Waste Equipment by Users in Private Household in the European Union.

This symbol on the product or on its packaging indicates that this product must not be disposed of with your other household waste. Instead, it is your responsibility to dispose of your waste equipment by handing it over to a designated collection point for the recycling of waste electrical and electronic equipment. The separate collection and recycling of your waste equipment at the time of disposal will help to conserve natural resources and ensure that it is recycled in a manner that protects human health and the environment. For more information about where you can drop off your waste equipment for recycling, please contact your local city office, your household waste disposal service or the shop where you purchased the product.

For Private Households in the European Union. To help conserve natural resources and ensure the product is recycled in a manner that protects human health and the environment, we would like to bring your attention to the following:

- The crossed-out dustbin on the device or outer packaging indicates the product is compliant with European WEEE (Waste Electrical and Electronic Equipment) Directive
- Always dispose of the old devices separately from household waste
- Batteries should be removed beforehand and disposed separately to the right collection system
- You are responsible with regard to the deletion of personal data on old devices before disposal
- Private households can hand in their old devices free of charge
- For more information about where you can drop off your waste equipment for recycling, please contact your local city office, your household waste disposal service or the shop where you purchased the product

# SAFETY INFORMATION

## Attention users in United States:

Please dispose of according to all Local, State and Federal Laws. For the disposal or recycling information, contact: [www.mygreenelectronics.com](http://www.mygreenelectronics.com) or [www.eiae.org](http://www.eiae.org).

## End of Life Directives-Recycling



Your new Public Information Display contains several materials that can be recycled for new users.

Please dispose of according to all Local, State, and Federal laws.

## Restriction on Hazardous Substances statement (India)

This product complies with the "India E-waste Rule 2011" and prohibits use of lead, mercury, hexavalent chromium, polybrominated biphenyls or polybrominated diphenyl ethers in concentrations exceeding 0.1 weight % and 0.01 weight % for cadmium, except for the exemptions set in Schedule 2 of the Rule.

## E-Waste Declaration for India



This symbol on the product or on its packaging indicates that this product must not be disposed of with your other household waste. Instead it is your responsibility to dispose of your waste equipment by handing it over to a designated collection point for the recycling of waste electrical and electronic equipment. The separate collection and recycling of your waste equipment at the time of disposal will help to conserve natural resources and ensure that it is recycled in a manner that protects human health and the environment.

## Batteries



For EU: The crossed-out wheeled bin implies that used batteries should not be put to the general household waste! There is a separate collection system for used batteries, to allow proper treatment and recycling in accordance with legislation.

Please contact your local authority for details on the collection and recycling schemes.

For Switzerland: The used battery is to be returned to the selling point.

For other non-EU countries: Please contact your local authority for correct method of disposal of the used battery.

According to EU directive 2006/66/EC, the battery can't be disposed improperly. The battery shall be separated to collect by local service.

## Turkey RoHS

Türkiye Cumhuriyeti: EEE Yönetmeliğine Uygundur.

## Ukraine RoHS

Обладнання відповідає вимогам Технічного регламенту щодо обмеження використання деяких небезпечних речовин в електричному та електронному обладнанні, затвердженого постановою Кабінету Міністрів України від 3 грудня 2008 № 1057.

# PRECAUTIONS

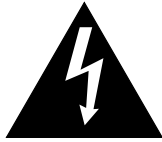

## Symbols used in this manual

	This icon indicates the existence of a potential hazard that could result in personal injury or damage to the product.
	This icon indicates important operating and servicing information.

## Notice

- Read this User Manual carefully before using the LCD display and keep it for future reference.
- The product specifications and other information provided in this User Manual are for reference only. All information is subject to change without notice. Updated content can be downloaded from our web site at [www.agneovo.com](http://www.agneovo.com).
- To protect your rights as a consumer, do not remove any stickers from the LCD display. Doing so may affect the determination of the warranty period.

## Cautions When Setting Up

- Do not place the LCD display near heat sources, such as a heater, exhaust vent, or in direct sunlight.
- Do not cover or block the ventilation holes in the housing.
- Place the LCD display on a stable area. Do not place the LCD display where it may subject to vibration or shock.
- Place the LCD display in a well-ventilated area.
- Do not place the LCD display outdoors.
- To avoid the risk of shock or permanent damage to the set, do not expose the display to dust, rain, water or an excessively moist environment.
- Do not spill liquid or insert sharp objects into the LCD display through the ventilation holes. Doing so may cause accidental fire, electric shock or damage the LCD display.

# PRECAUTIONS

## Cautions When Using

- Use only the power cord supplied with the LCD display.
- The power outlet should be installed near the LCD display and be easily accessible.
- If an extension cord is used with the LCD display, ensure that the total current consumption plugged into the power outlet does not exceed the ampere rating.
- Do not allow anything to rest on the power cord. Do not place the LCD display where the power cord may be stepped on.
- If the LCD display will not be used for an indefinite period of time, unplug the power cord from the power outlet.
- To disconnect the power cord, grasp and pull by the plug head. Do not tug on the cord; doing so may cause fire or electric shock.
- Do not unplug or touch the power cord with wet hands.
- When turning off the display by detaching the power cord, wait 6 seconds before re-attaching the power cord for normal operation.
- Do not knock or drop the display during operation or transportation.

## Cleaning and Maintenance

- To protect your display from possible damage, do not put excessive pressure on the LCD panel. When moving your display, grasp the frame to lift; do not lift the display by placing your hand or fingers on the LCD panel.
- Unplug the display if you need to clean it with a slightly damp cloth. The screen may be wiped with a dry cloth when the power is off. However, never use organic solvent, such as, alcohol, or ammonia-based liquids to clean your display.
- If your display becomes wet, wipe it with dry cloth as soon as possible.
- If a foreign substance or water gets in your display, turn the power off immediately and disconnect the power cord. Then remove the foreign substance or water, and send the unit to the maintenance center.
- In order to maintain the best performance of your display and ensure a longer lifetime, we strongly recommend using the display in a location that falls within the following temperature and humidity ranges.
  - ◆ Temperature: 0-40°C (32-104°F)
  - ◆ Humidity: 20-80% RH



### Warning:



Unplug the power cord from the power outlet and refer to qualified service

personnel under the following conditions:

- ◆ When the power cord is damaged.
- ◆ If the LCD display has been dropped or the housing has been damaged.
- ◆ If the LCD display emits smoke or a distinct odor.

# PRECAUTIONS

## Notice for the LCD Display

- In order to maintain the stable luminous performance, it is recommended to use low brightness setting.
- Due to the lifespan of the lamp, it is normal that the brightness quality of the LCD display may decrease with time.
- When static images are displayed for long periods of time, the image may cause an imprint on the LCD display. This is called image retention or burn-in.
  - ◆ To prevent image retention, do any of the following:
    - Set the LCD display to turn off after a few minutes of being idle.
    - Use a screen saver that has moving graphics or a blank white image.
    - Execute the ANTI-BURN-IN function of the LCD display. See **Configuration 1 > Panel Saving > ANTI-BURN-IN** section.
    - Switch desktop backgrounds regularly.
    - Adjust the LCD display to low brightness settings.
    - Turn off the LCD display when the system is not in use.
  - ◆ Things to do when the LCD display shows image retention:
    - Turn off the LCD display for extended periods of time. It can be several hours or several days.
    - Use a screen saver and run it for extended periods of time.
    - Use a black and white image and run it for extended periods of time.
- There are millions of micro transistors inside the LCD display. It is normal for a few transistors to be damaged and to produce spots. This is acceptable and is not considered a failure.
- **IMPORTANT:** Always activate a moving screen saver program when you leave your display unattended. Always activate a periodic screen refresh application if the unit will display unchanging static content. Uninterrupted display of still or static images over an extended period may cause “burn in”, also known as “after-imaging” or “ghost imaging”, on your screen. This is a well-known phenomenon in LCD panel technology. In most cases, the “burned in” or “after-imaging” or “ghost imaging” will disappear gradually over a period of time after the power has been switched off.
- **WARNING:** Severe “burn-in” or “after-image” or “ghost image” symptoms will not disappear and cannot be repaired. This is also not covered under the terms of your warranty.

# CHAPTER 1: PRODUCT DESCRIPTION

## 1.1 Unpacking

- This product is packed in a packaging box which contains standard accessories.
- Any other optional accessories will be packed separately.
- Considering the size and weight of the display, it is recommended that this product is carried out by two persons.
- After opening the packaging box, ensure that the included items are in good condition and complete.

## 1.2 Package Contents

When unpacking, check if the following items are included in the package. If any of them is missing or damaged, contact your dealer.

**LCD Display**



**Remote control**

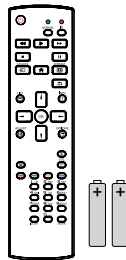

**Quick Start Guide**

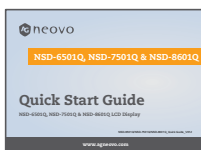

**HDMI cable**

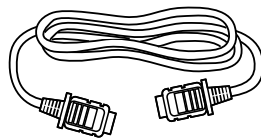

**Power cord**

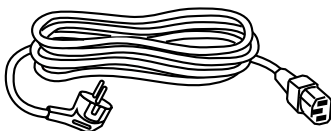

**RS232 cable**

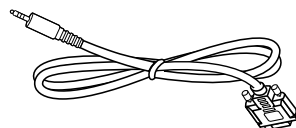

### Note:

- ◆ Remote control is shipped with the supplied AAA batteries.
- ◆ For all other regions, apply a power cord that conforms to the AC voltage of the power socket and has been approved by and complies with the safety regulations of the particular country (Type H05W-F, 2G or 3G, 0.75 or 1 mm<sup>2</sup> should be used).
- ◆ You might like to save the package box and packing material for shipping the display.
- ◆ The pictures are for reference only. Actual items may vary upon shipment.

# PRODUCT DESCRIPTION

## 1.3 Preparing for the Installation

- Due to the high power consumption, always use the plug exclusively designed for this product. If an extended line is required, please consult your service agent.
- The product should be installed on a flat surface to avoid tipping. The distance between the back of the product and the wall should be maintained for proper ventilation. Avoid installing the product in the kitchen, bathroom or any other places with high humidity so as not to shorten the service life of the electronic components.
- The product can normally operate only under 3000m in altitude. In installations at altitudes above 3000m, some abnormalities may be experienced.

## 1.4 Wall Mounting Installation

To mount this display to a wall, you will have to obtain a standard wall-mounting kit (commercially available). We recommend using a mounting interface that complies with TUV-GS and/or UL1678 standard in North America.

To wall-mount the LCD display, screw the mounting bracket to the VESA holes at the rear of the LCD display.

### NSD-6501Q

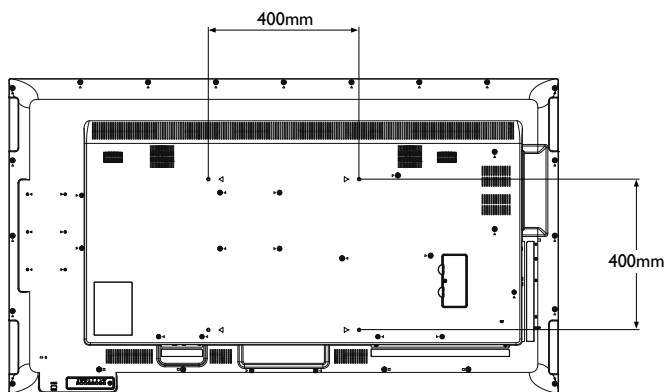

### NSD-7501Q

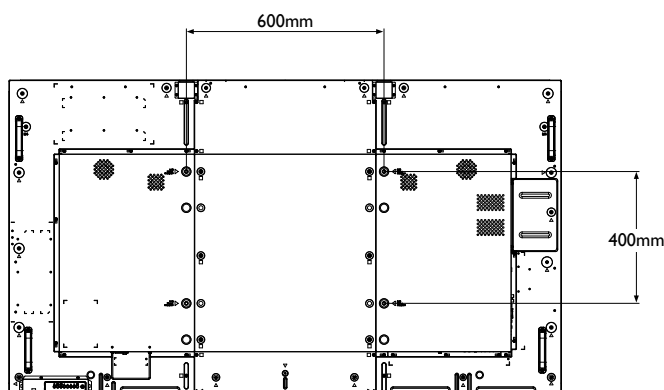

### Warning:

- ◆ Do not press too hard on the LCD panel or edge of the frame, as this may cause the device to malfunction.

### Note:

- ◆ Avoid the wall-mounting kit to block the ventilation holes on the back of the display.
- ◆ Secure the LCD display on a solid wall strong enough to bear its weight.
- ◆ Lay a protective sheet on a table, which was wrapped around the display when it was packaged, beneath the screen surface so as not to scratch the screen face.
- ◆ Ensure you have all accessories for mounting this display (wall mount, ceiling mount, etc).
- ◆ Follow the instructions that come with the base mounting kit. Failure to follow correct mounting procedures could result in damage to the equipment or injury to the user or installer. Product warranty does not cover damage caused by improper installation.

# PRODUCT DESCRIPTION

## NSD-8601Q

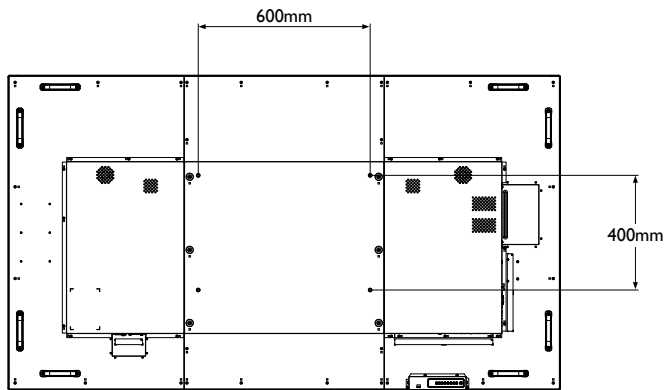

### 1.4.1 VESA Grid

Model Name	VESA Grid
NSD-6501Q	400(W) x 400(H) mm
NSD-7501Q	600(W) x 400(H) mm
NSD-8601Q	600(W) x 400(H) mm

#### Caution:

To prevent the display from falling:

- ◆ For wall or ceiling installation, we recommend installing the display with metal brackets which are commercially available. For detailed installation instructions, see the guide received with the respective bracket.
- ◆ To lessen the probability of injury and damage resulting from fall of the display in case of earthquake or other natural disaster, be sure to consult the bracket manufacturer for installation location.

#### Note:

- ◆ For NSD-6501Q wall-mounting kits, use M6 mounting screws (having a length 10 mm longer than the thickness of the mounting bracket) and tighten them securely.
- ◆ For NSD-7501Q / NSD-8601Q wall-mounting kits, use M8 mounting screws (having a length 15 mm longer than the thickness of the mounting bracket) and tighten them securely.
- ◆ Unit without base weight is 24.8 kg (NSD-6501Q), 53.3 kg (NSD-7501Q), or 63.8 kg (NSD-8601Q). The equipment and its associated mounting means still remain secure during the test. For use only with UL Listed Wall Mount Bracket with minimum weight/load is 32.8 kg (NSD-6501Q), 67.0 kg (NSD-7501Q), or 79.6 kg (NSD-8601Q).



# PRODUCT DESCRIPTION

## 1.4.2 Ventilation Requirements for Enclosure Locating

To allow heat to disperse, leave space between surrounding objects as shown in the diagram below.

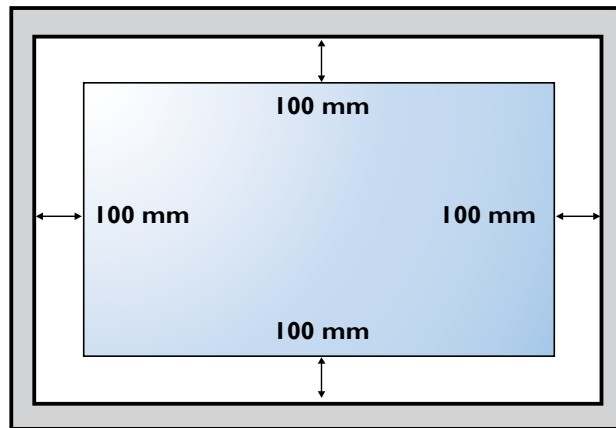

## 1.5 Using the Remote Sensor and Power Status Indicator

- If you want to obtain a better reception of remote control function, please adjust the indicator location to easily check the power status indicator.
- If you want to mount the display to the wall, please push the indicator switch upwards before installation.
- When adjusting the indicator location, make sure to push/pull the indicator switch firmly until it clicks into place.

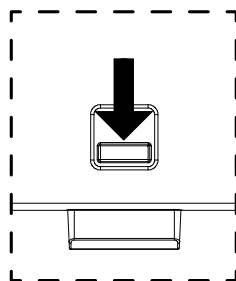

Push downward to reveal the indicator

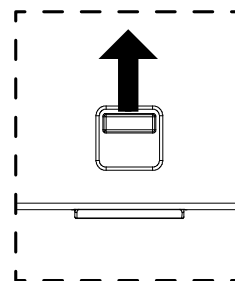

Pull upward to hide the indicator

# PRODUCT DESCRIPTION

## 1.6 LCD Display Overview

### 1.6.1 Control Panel

NSD-6501Q

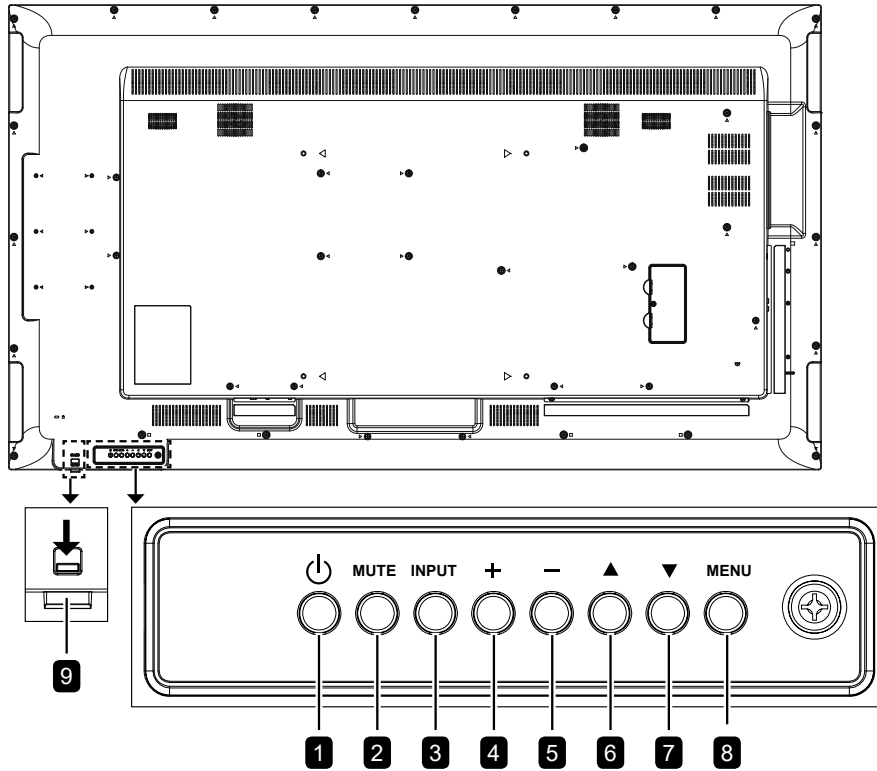

NSD-7501Q

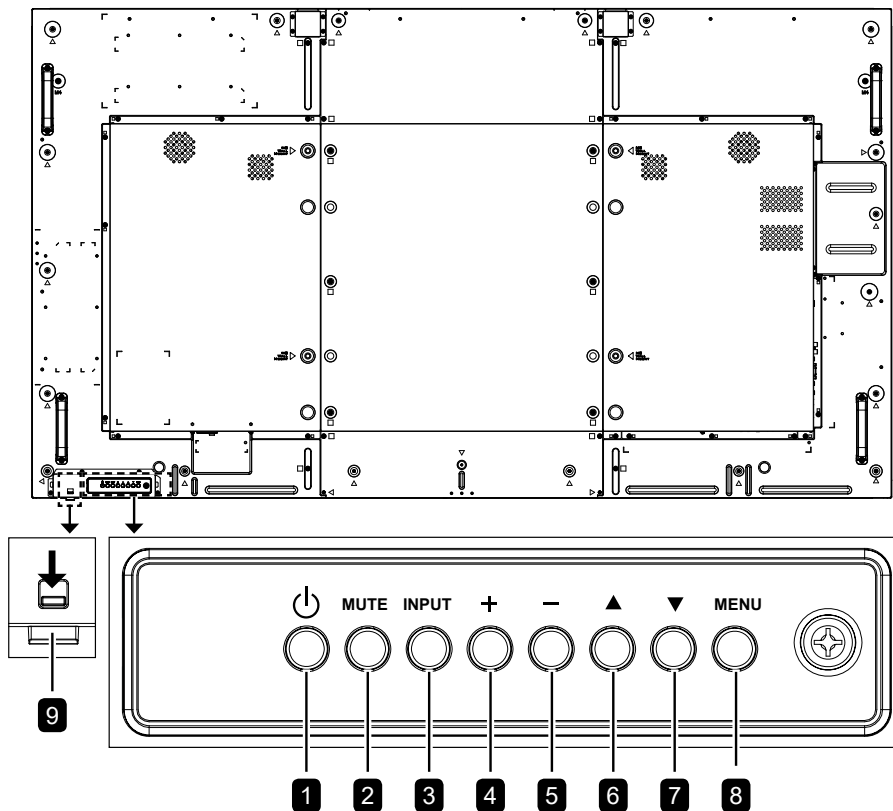

# PRODUCT DESCRIPTION

NSD-8601Q

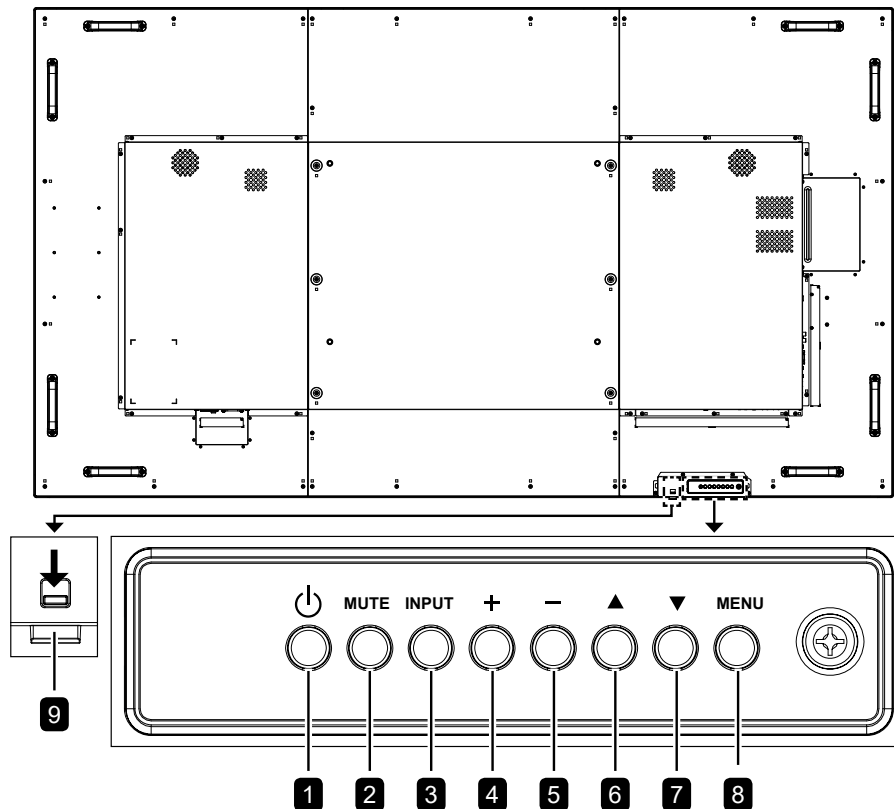

**1** [⏻] **Power**

Turn the display on or put the display to standby.

**2** **MUTE**

Switch the audio mute ON/OFF.

**3** **INPUT**

Choose the input source.

**4** [++] **Increase**

- Enter the submenu.
- Increase the audio output level while OSD menu is off.

**5** [--] **Decrease**

- Return to the previous menu.
- Decrease the audio output level while OSD menu is off.

**6** [▲] **Up**

Move the highlight bar up to select an option or increase the adjustment while OSD menu is on.

**7** [▼] **Down**

Move the highlight bar down to select an option or decrease the adjustment while OSD menu is on.

**8** **MENU**

- Activate the OSD menu when OSD menu is off.
- Hide the OSD menu while OSD menu is on.

**9** **Remote control sensor and power status indicator**

- Receive command signals from the remote control.
- Indicate the operating status of the display:
  - Lights green when the display is turned on
  - Lights red when the display is in standby mode
  - Blinks green and red when “Advanced option, Schedule” is enabled
  - Blinks red when a failure has been detected
  - Lights off when the main power of the display is turned off

# PRODUCT DESCRIPTION

## 1.6.2 Input/Output Terminals

### NSD-6501Q

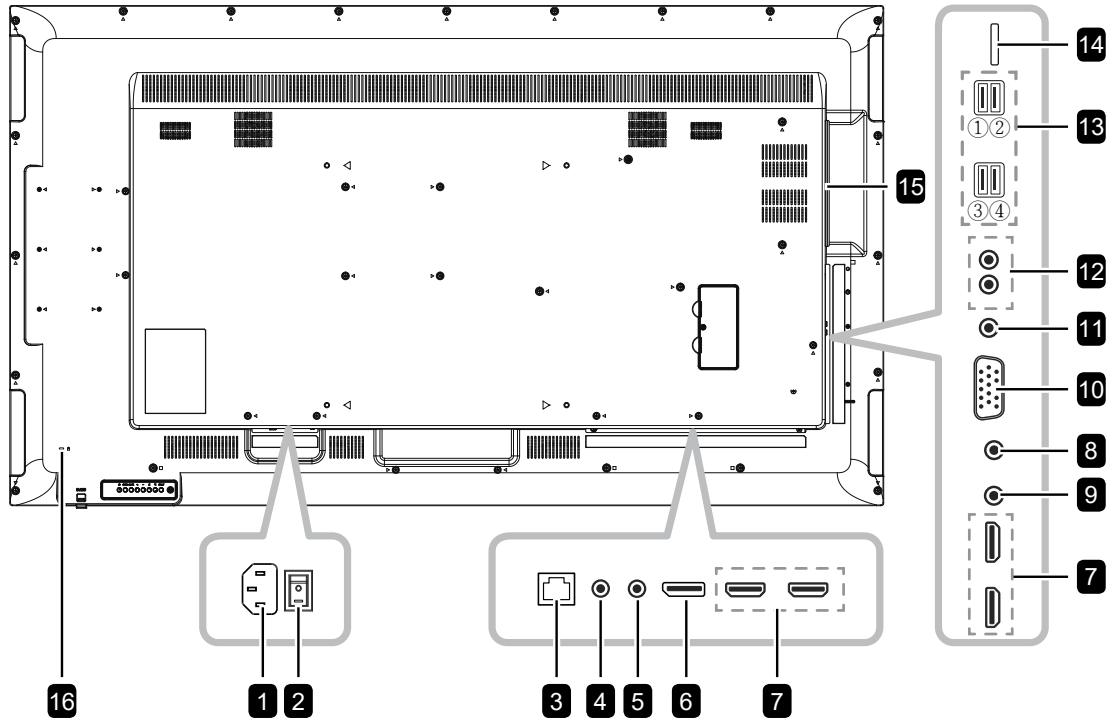

### NSD-7501Q

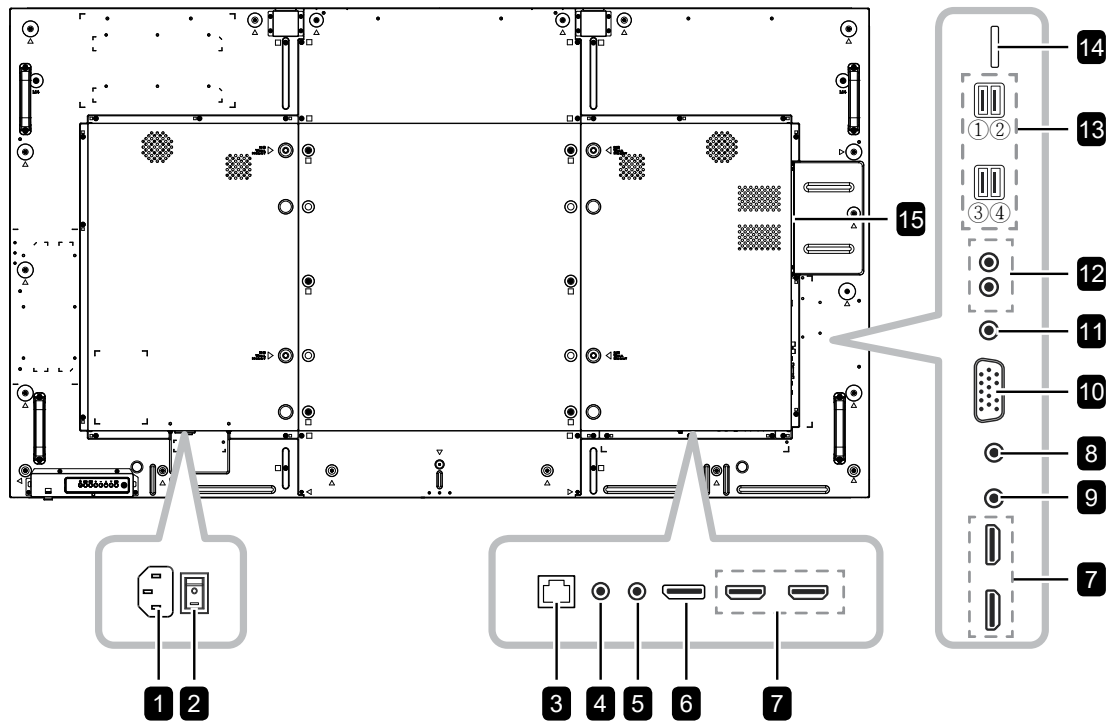

# PRODUCT DESCRIPTION

## NSD-8601Q

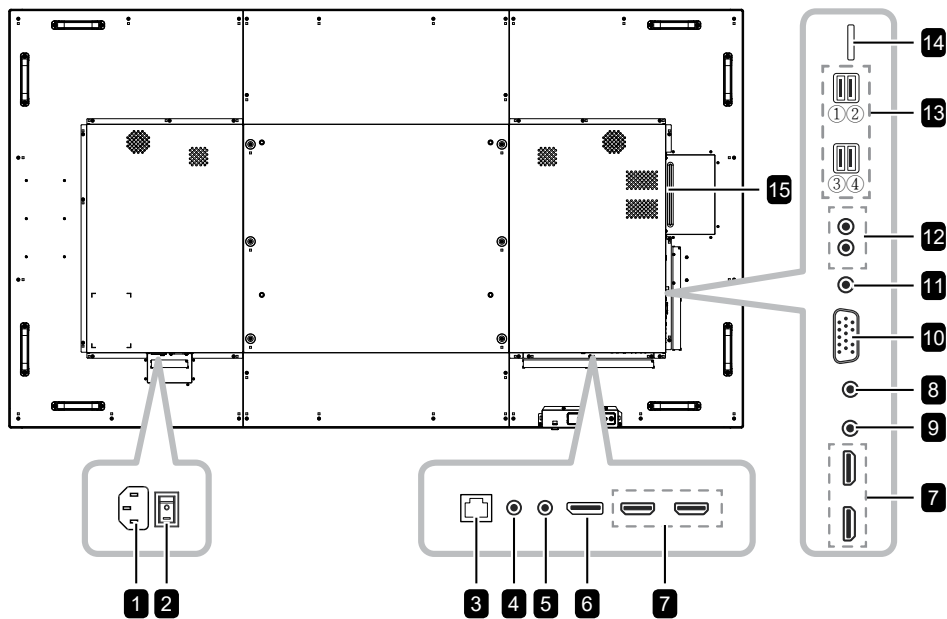

**1 AC IN**

AC power input from the wall outlet.

**2 Main power switch**

Switch the main power on/off.

**3 RJ45**

LAN control function for the use of remote control signal from the control center.

**4 RS232 IN**

RS232 network input for the loop-through function.

**5 RS232 OUT**

RS232 network output for the loop-through function.

**6 DisplayPort IN**

DisplayPort video input.

**7 HDMI1/HDMI2/HDMI3/HDMI4 IN**

HDMI video/audio input.

**8 IR IN**

IR signal input for the loop-through function.

**9 IR OUT**

IR signal output for the loop-through function.

**10 VGA IN (D-Sub)**

VGA video input.

**11 AUDIO IN**

Audio input for VGA source (3.5mm stereo phone).

**12 AUDIO OUT**

Audio output to external AV device (RCA).

**13 USB 2.0/3.0 PORT**

Connect your USB storage device.

① USB 2.0 x 1 (Service Port / Media Playback)

② USB 2.0 x 1 (Media Playback)

③ USB 3.0 x 1 (Media Playback)

④ USB power outlet x 1 (5V2A)

**14 MICRO SD CARD SLOT**

Insert a micro SD card into the slot.

**15 OPS SLOT**

Slot for installing the optional OPS module..

**16 Kensington Security Slot(NSD-6501Q Only)**

Used for security and theft prevention.

**Note:**

- ◆ This display's remote control sensor will stop working if the [IR IN] jack is connected.
- ◆ To remotely control your A/V device via this display, see page 36 for IR Pass-Through connection.

# PRODUCT DESCRIPTION

## 1.7 Remote Control

### 1.7.1 General Functions

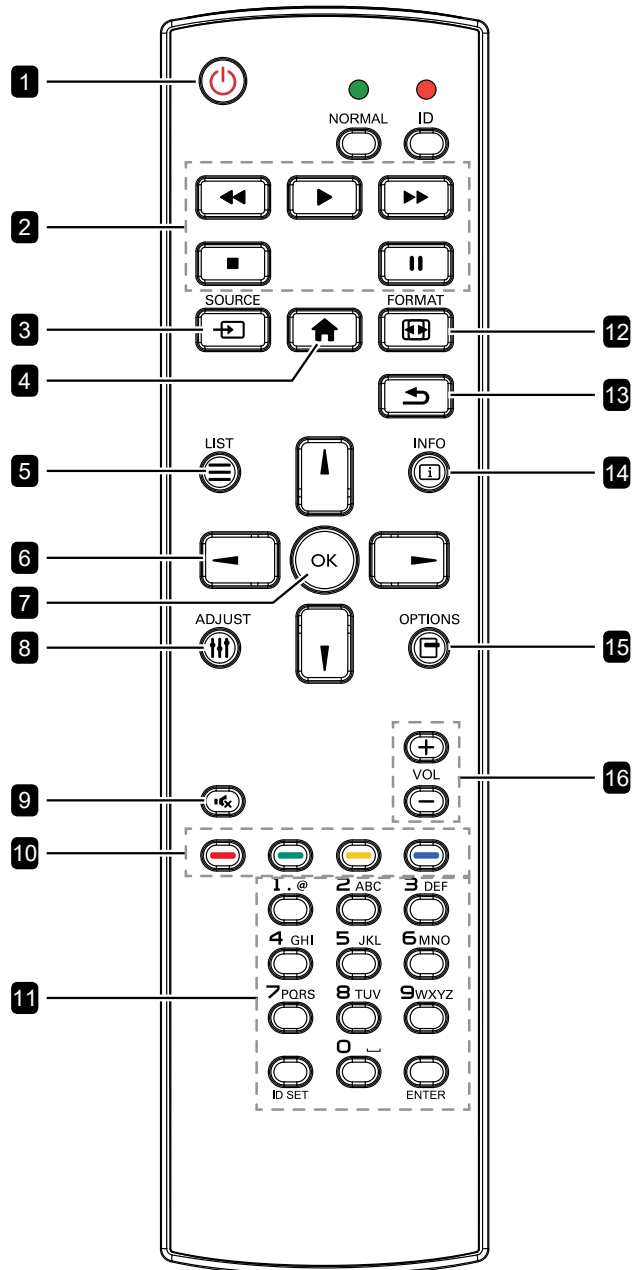

#### 1 [POWER] POWER

Turn the display on or to put the display into standby mode.

#### 2 [PLAY] PLAY

- Control playback in multimedia mode.
- Freeze feature
  - II: Freeze hot key for all inputs content.
  - ►: Unfreeze hot key for all input content.

#### 3 [SOURCE] SOURCE

**Root Menu:** Go to Video source OSD.

#### 4 [HOME] HOME

- **Root Menu:** Access the OSD menu.
- **Others:** Exit the OSD menu.

#### 5 [LIST] LIST

No function.

#### 6 [NAVIGATION] NAVIGATION buttons



- **Root Menu:** Go to Smart picture OSD.
- **Main Menu:** Move the highlight bar up to adjust the selected item.
- **IR Daisy Chain Menu:** Increase controlled Group ID number.



- **Root Menu:** Go to Audio source OSD.
- **Main Menu:** Move the highlight bar down to adjust the selected item.
- **IR Daisy Chain Menu:** Decrease controlled Group ID number.



- **Main Menu:** Return to the previous menu page.
- **Source Menu:** Exit the source menu.
- **Volume Menu:** Decrease the volume level.



- **Main Menu:** Enter the submenu or confirm a selection.
- **Source Menu:** Confirm the selected source.
- **Volume Menu:** Increase the volume level.

#### 7 [OK] OK

- **Root Menu:** Go to IR daisy chain OSD in Primary/Secondary mode.
- **Main Menu:** Confirm an entry or selection.

#### 8 [ADJUST] ADJUST

Go to Auto Adjust OSD (for VGA input only).

# PRODUCT DESCRIPTION

## 9 MUTE

Turn the mute function on/off.

## 10 COLOR

- Choose tasks or options.(for Media Input only).
- : Hot key for Window selection function.

## 11 [Number/ ID SET/ ENTER]

- Enter text for network setting.
- Set the display ID. See 1.7.2 ID Remote Control for more detail.

## 12 FORMAT

Change the aspect ratio.

## 13 BACK

Return to the previous menu or exit from the previous function.

## 14 INFO

View the information about the display.

## 15 OPTIONS

No function.

## 16 VOLUME

Adjust the volume level.

# PRODUCT DESCRIPTION

## 1.7.2 ID Remote Control

You can set the remote control ID when you want to use this remote control on one of several different displays.

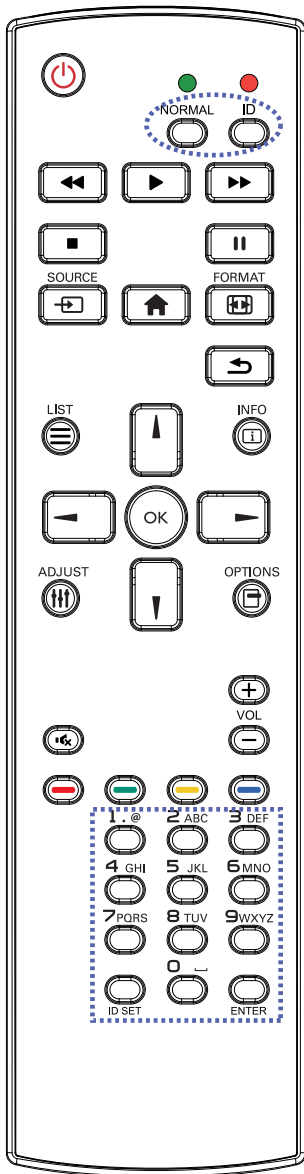

To set the remote control ID:

- 1 Press the **ID** button. The red LED blinks twice.
- 2 Press the **ID SET** button for more than 1 second to enter the ID mode. The red LED lights up. Press the **ID SET** button again will exit the ID mode. The red LED lights off.
- 3 Press the digit numbers [0] ~ [9] to select the display you want to control. For example:
  - Display ID #1: press [0], [1]
  - Display ID #11: press [1], [1]The numbers available are from [01] ~ [255].
  - Not pressing any button within 10 seconds will exit the ID mode.
  - If an error pressing of buttons other than the digits occurred, wait 1 second after the red LED lights off and then lights up again, then press the correct digits again.
- 4 Press the **ENTER** button to confirm. The red LED blinks twice and then lights off.

### Note:

- ◆ Press the **NORMAL** button. The green LED blinks twice, indicating the remote control returns to normal operation.
- ◆ It is necessary to set up the ID number for each display before selecting its ID number.



# PRODUCT DESCRIPTION

## 1.7.3 Remote Control buttons on Android source

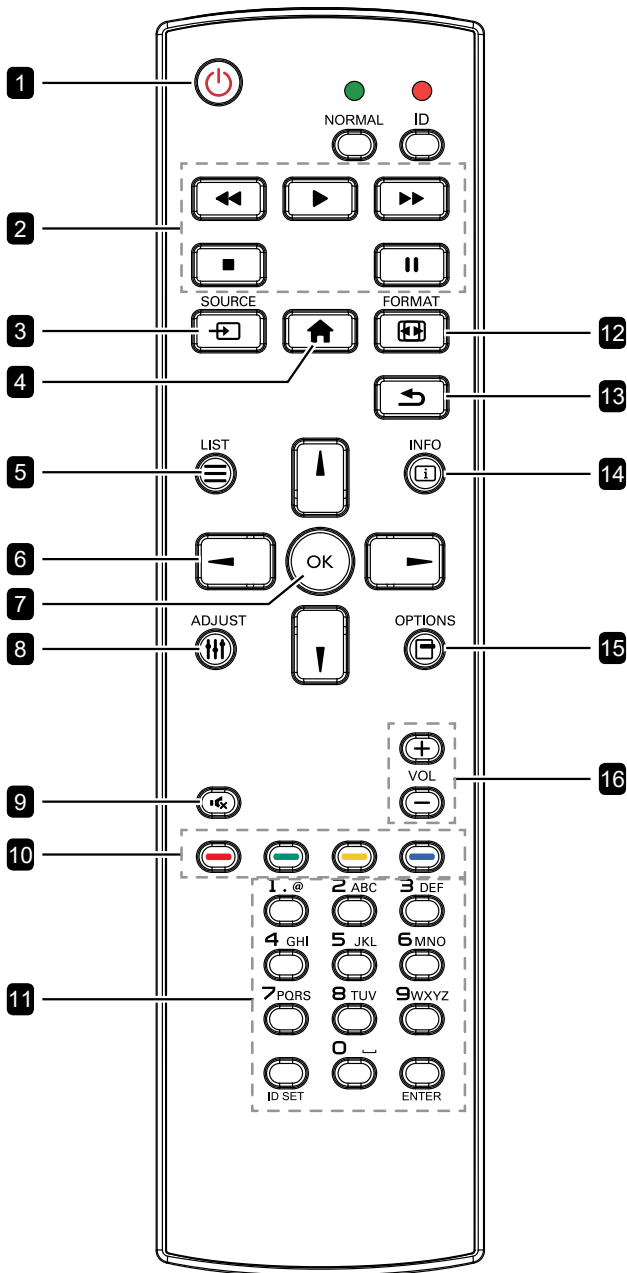

### 1 [🔌] POWER

Turn the display on or to put the display into standby mode.

The button is only controlled by Scalar.

### 2 PLAY

- Control playback of media (video/photo/music) files.

There are 4 ways to play media files

#### 1) File Manager

Find the media file from the File Manager and select it to play.

#### 2) **Media Player > Compose** > edit or new add playlist > choose any media files > press the ► button to play the media file directly.

#### 3) **Media Player > Play** > choose non-empty playlist > press the OK button to play all the media files in the playlist.

#### 4) Set media playlist in Boot on Source or Schedule by OSD menu.

- Play PDF file

There are 3 ways to play media files.

#### 1) File Manager

Find the pdf file from the File Manager and select it to play.

#### 2) **PDF Player > Play** > choose non-empty playlist > press the OK button to play all the PDF files in the playlist.

#### 3) Set pdf playlist in Boot on Source or Schedule by OSD menu.

- When playing the PDF or video file, press the ■ button to stop playing. Press the ► button to replay the media file from the beginning.
- When playing PDF or video file, press the || button to pause playing.
- All media files should be put at the folder, which is named "agn" with sub-folder, under the root directory of the specified storage (internal/USB/SD Card). All sub-folders (video/photo/music/pdf) are named by media types and should not be changed.

**videos:** {root dir of storage}/agn/video/

**photos:** {root dir of storage}/agn/photo/

**music:** {root dir of storage}/agn/music/

**pdfs :** {root dir of storage}/agn/pdf/

Note that the root directories of three storages are:

**Internal storage:** /sdcard

**USB storage:** /mnt/usb\_storage

**SD card:** /mnt/external\_sd

# PRODUCT DESCRIPTION

## 3 SOURCE

Choose input source.  
The button is only controlled by Scalar.







## 4 HOME

Access the OSD menu.  
The button is only controlled by Scalar.

## 5 LIST

- In the content of the webpage, move the focus up to the next clickable item.
- Move the focus up to the next control or widget such as buttons.

## 6 NAVIGATION buttons

- Navigate through menus and choose items.
- In the content of the webpage, press the following button to control the scroll bar of the screen:
  - » : Move the vertical scroll bar up or down.
  - » : Move the horizontal scroll bar left or right.
- When browsing the PDF files:
  - » In Zoom mode, press the / button to adjust the position of the screen.
  - » In Viewing mode, press the / button to go to the previous/next page.

## 7 OK

Confirm an entry or selection.





## 8 ADJUST

- In the content of the webpage, move the focus down to the next clickable item.
- Move the focus down to the next control or widget such as buttons.

## 9 MUTE

Turn the mute function on/off.  
The button is only controlled by Scalar.

## 10 COLOR

- /: No function on Android source. These two buttons are only controlled by Scalar.
- When browsing the PDF files:
  - » : Perform zoom-in.
  - » : Perform zoom-out.
  - » After zoom-in or zoom-out, press the OK button to revert the pdf file to the original size.

## 11 [Number/ ID SET/ ENTER]

- **ID SET/ENTER**: No function on Android source. These two buttons are only controlled by Scalar.
- When browsing the PDF files, enter the page number by pressing number buttons and then press the OK button to jump to the specific page.

## 12 FORMAT

Change the aspect ratio.  
The button is only controlled by Scalar.



## 13 BACK

Return to the previous menu or exit from the previous function.

## 14 INFO

- Display information about current input signal. It is shown by Scalar.
- **Media Player > Compose > edit or new add playlist > choose any media files > press the  button to show the information of the chosen media file.**

## 15 OPTIONS

- Open toolbar in Media Player or PDF Player.
- **Media Player > Compose > edit or new add playlist > press the  button to open toolbar. Toolbar is displayed on the left side of the screen.**
- **PDF Player > Compose > edit or new add playlist > press the  button to open toolbar. Toolbar is displayed on the left side of the screen.**

## 16 VOLUME

Adjust the volume level. The buttons are only controlled by Scalar.

# PRODUCT DESCRIPTION

## 1.7.4 Inserting the Batteries in the Remote Control

The remote control is powered by two 1.5V AAA batteries.

To install or replace batteries:

- 1 Press and then slide the cover to open it.
- 2 Align the batteries according to the (+) and (-) indications inside the battery compartment.
- 3 Replace the cover.

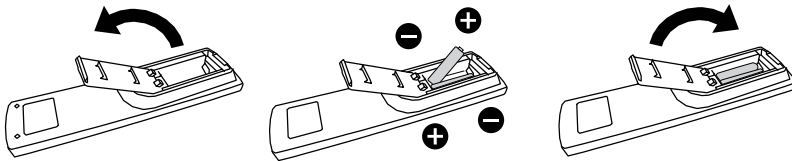

## 1.7.5 Handling the Remote Control

- Do not subject to strong shock.
- Do not allow water or other liquid to splash the remote control. If the remote control gets wet, wipe it dry immediately.
- Avoid exposure to heat and steam.
- Other than to install the batteries, do not open the remote control.

## 1.7.6 Operating Range of the Remote Control

Point the top of the remote control toward the display's remote control sensor (on the left or right side) when pressing a button.

When using the remote control, the distance from the remote control to the sensor on the display should be less than 5m/16ft, and the horizontal and vertical angles should be less than 30°.

### NSD-6501Q/NSD-7501Q

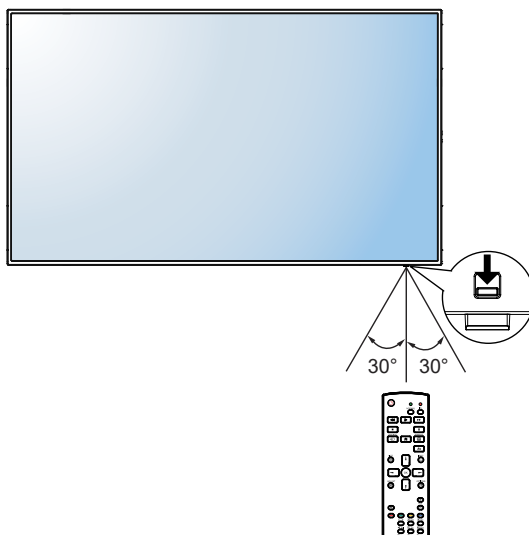

### ⚠ Caution:

The incorrect use of batteries can result in leaks or bursting. Be sure to follow these instructions:

- ◆ Place "AAA" batteries matching the (+) and (-) signs on each battery to the (+) and (-) signs of the battery compartment.
- ◆ Do not mix battery types.
- ◆ Do not combine new batteries with used ones. It causes shorter life or leakage of batteries.
- ◆ Remove the dead batteries immediately to prevent them from liquid leaking in the battery compartment. Don't touch exposed battery acid, as it can damage your skin.

### Note:

- ◆ If you do not intend to use the remote control for a long period, remove the batteries.
- ◆ The remote control may not function properly when the remote control sensor on this display is under direct sunlight or strong illumination, or when there is an obstacle in the path of signal transmission.

# PRODUCT DESCRIPTION

NSD-8601Q

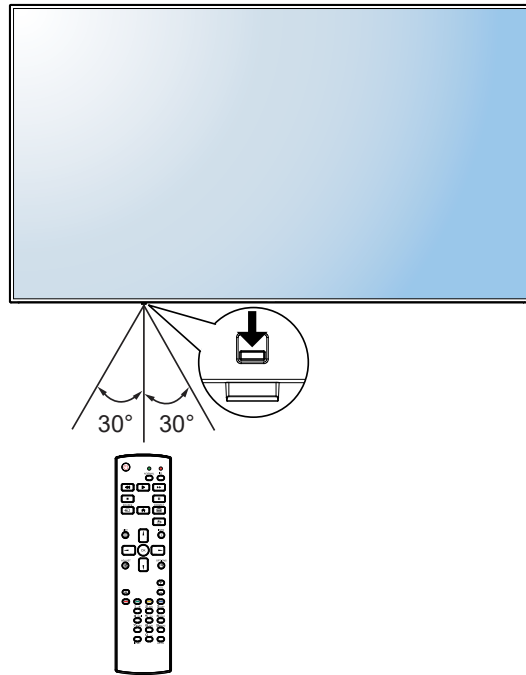

# CHAPTER 2: MAKING CONNECTIONS

## 2.1 Connecting the Power

- 1 Connect one end of the power cord to the AC IN connector at the rear of the LCD display.
- 2 Connect the other end of the power cord to a power outlet or a power supply.
- 3 Set the **Main Power** switch to ON.

### NSD-6501Q

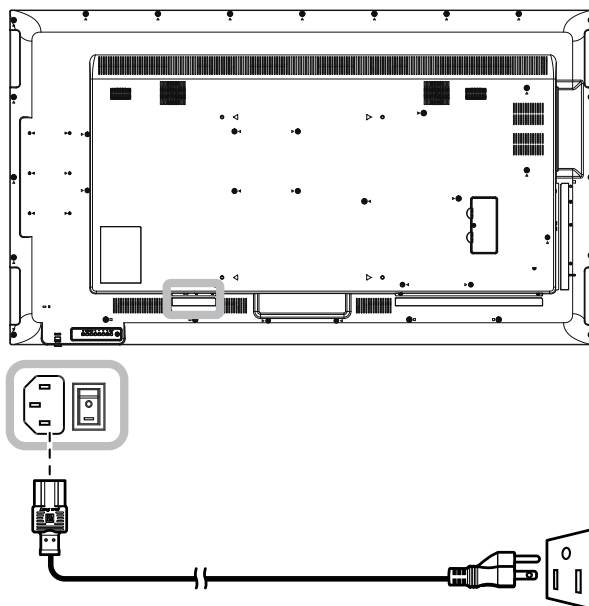

### NSD-7501Q

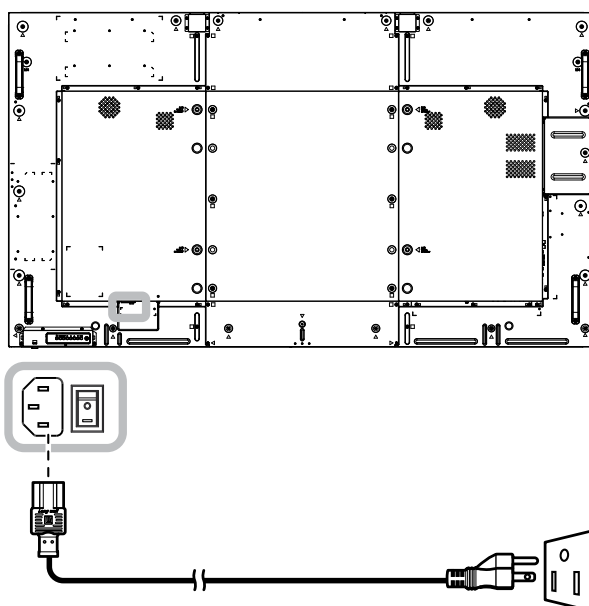

# MAKING CONNECTIONS

NSD-8601Q

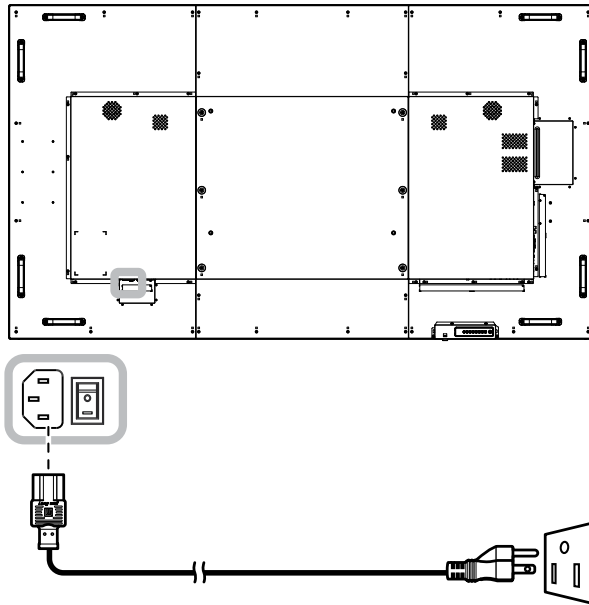

**⚡ Caution:**

- ◆ Make sure that the LCD display is not connected to the power outlet before making any connections. Connecting cables while the power is ON may cause electric shock or personal injury.
- ◆ When unplugging the power cord, hold the power cord by the plug head. Never pull by the cord.

# MAKING CONNECTIONS

## 2.2 Connecting a Computer

### 2.2.1 Using VGA Input

Connect one end of a D-sub cable to the VGA IN connector of the LCD display and the other end of a D-sub cable to the VGA OUT (D-Sub) connector of the computer.

For audio input, connect one end of an audio cable to the AUDIO IN connector of the LCD display and the other end of an audio cable to the AUDIO OUT connector of the computer.

#### NSD-6501Q

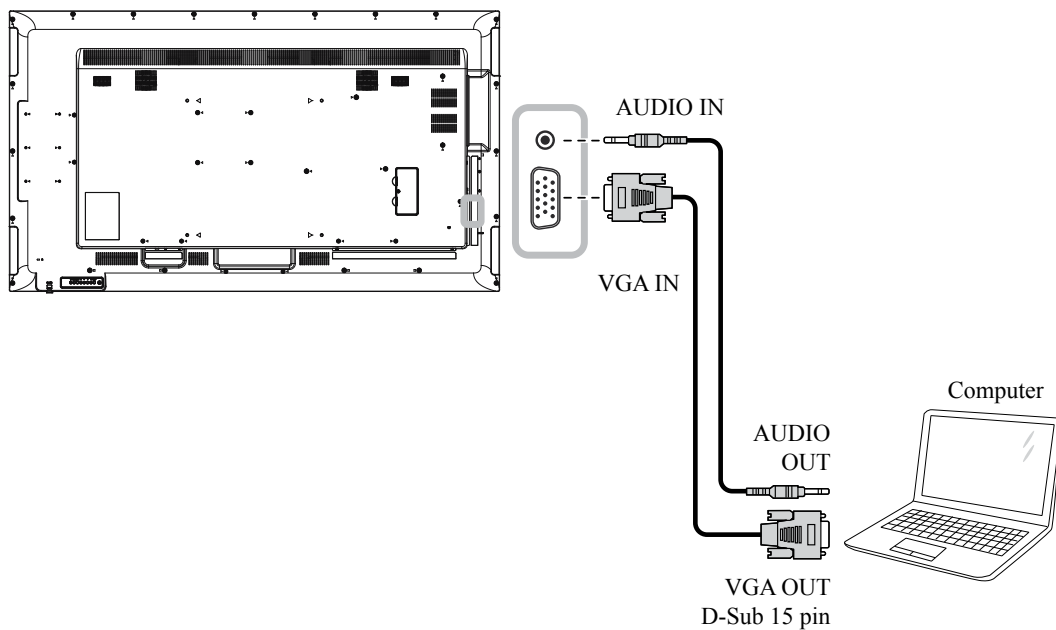

#### NSD-7501Q

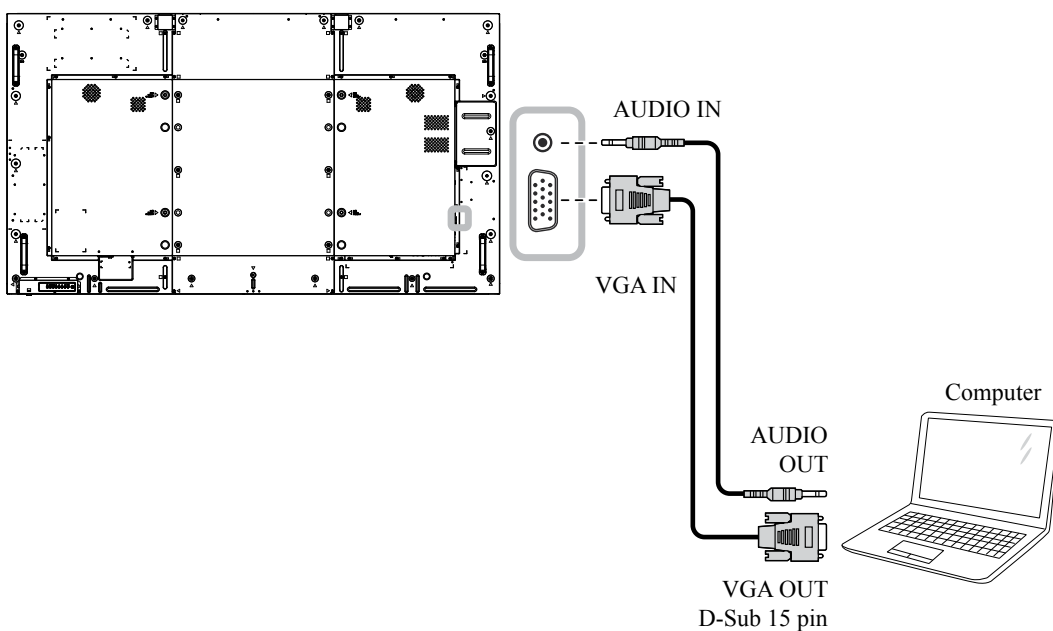

# MAKING CONNECTIONS

## NSD-8601Q

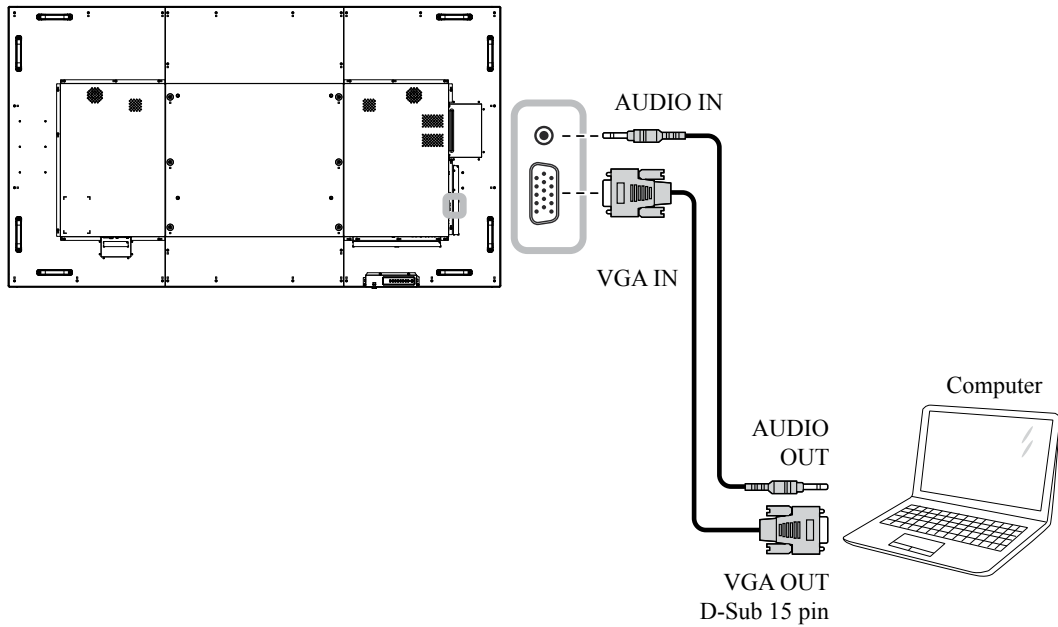

## 2.2.2 Using DisplayPort Input

Connect one end of a DisplayPort cable to the DisplayPort IN connector of the LCD display and the other end of a DisplayPort cable to the DisplayPort OUT connector of the computer.

## NSD-6501Q

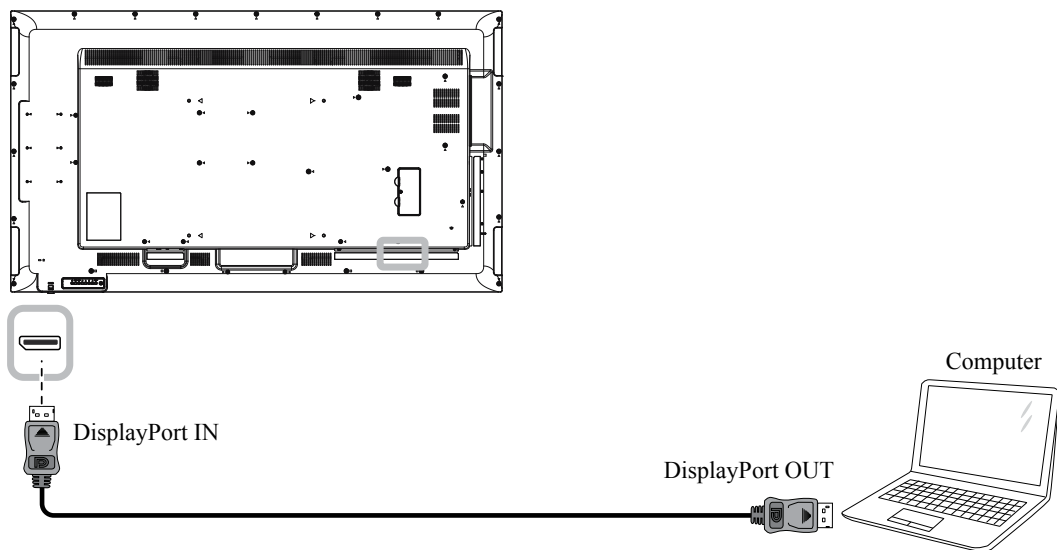



# MAKING CONNECTIONS

## NSD-7501Q

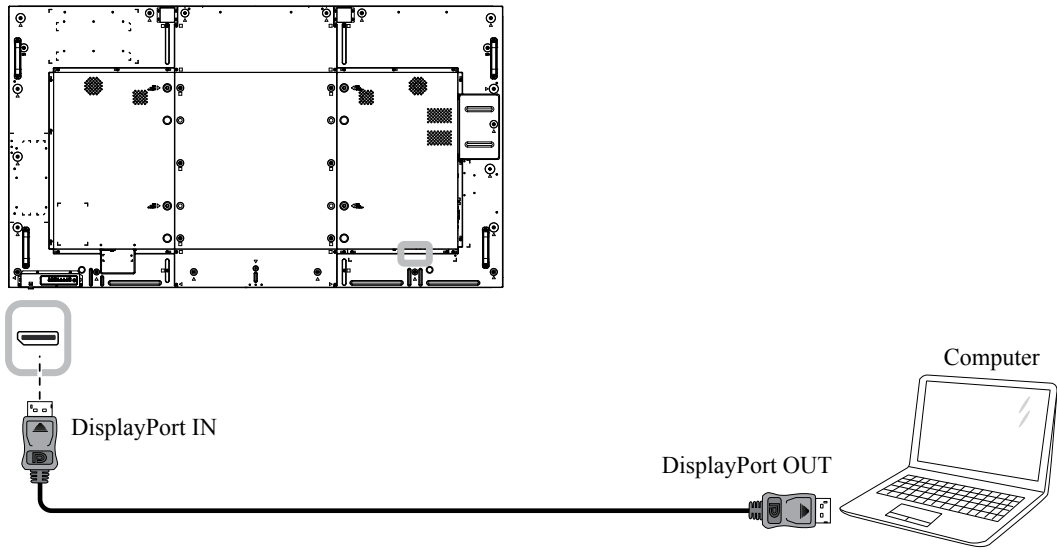

## NSD-8601Q

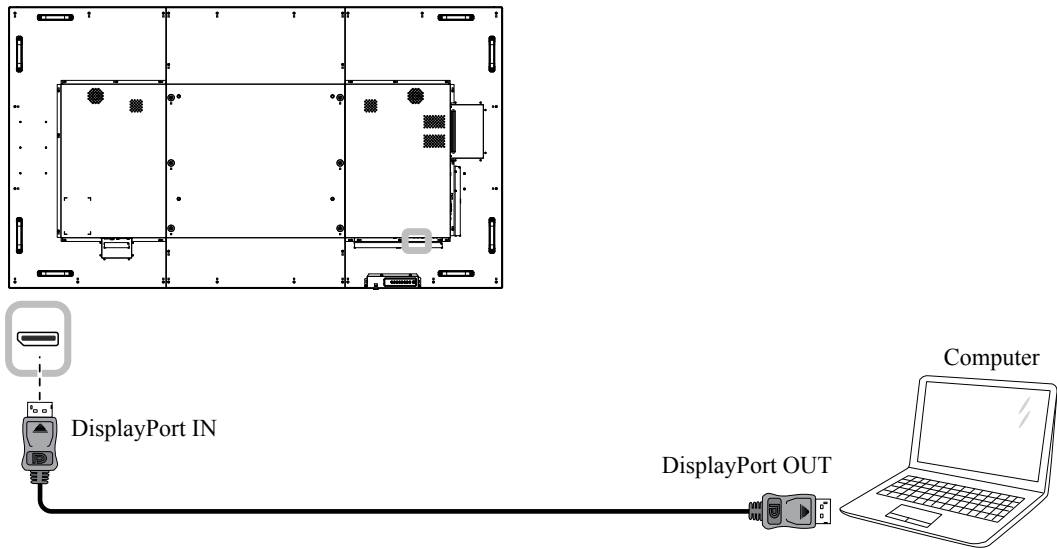

# MAKING CONNECTIONS

## 2.2.3 Using HDMI Input

Connect one end of an HDMI cable to the HDMI IN connector of the LCD display and the other end of an HDMI cable to the HDMI OUT connector of the computer.

### NSD-6501Q

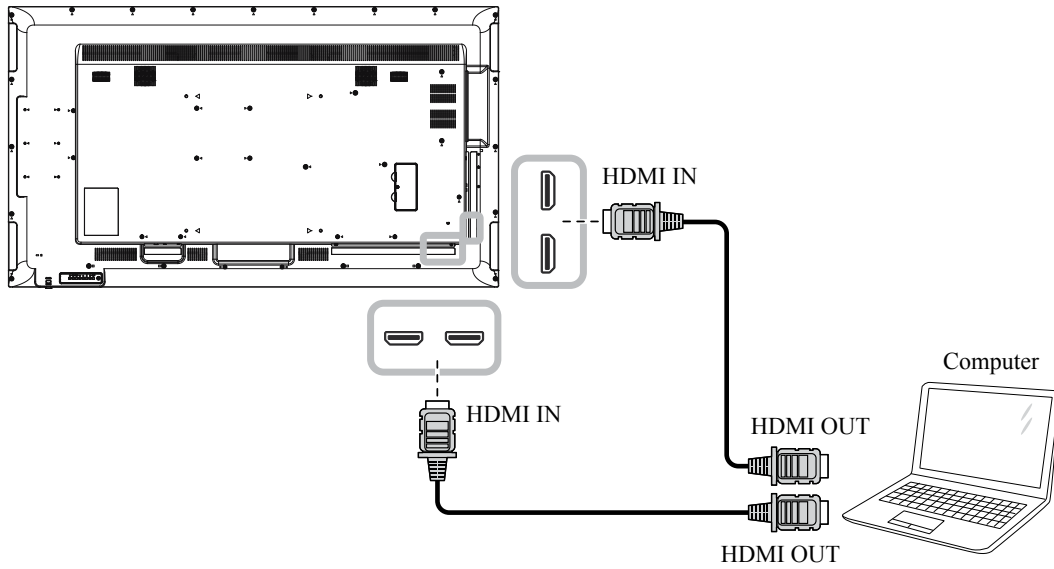

### NSD-7501Q

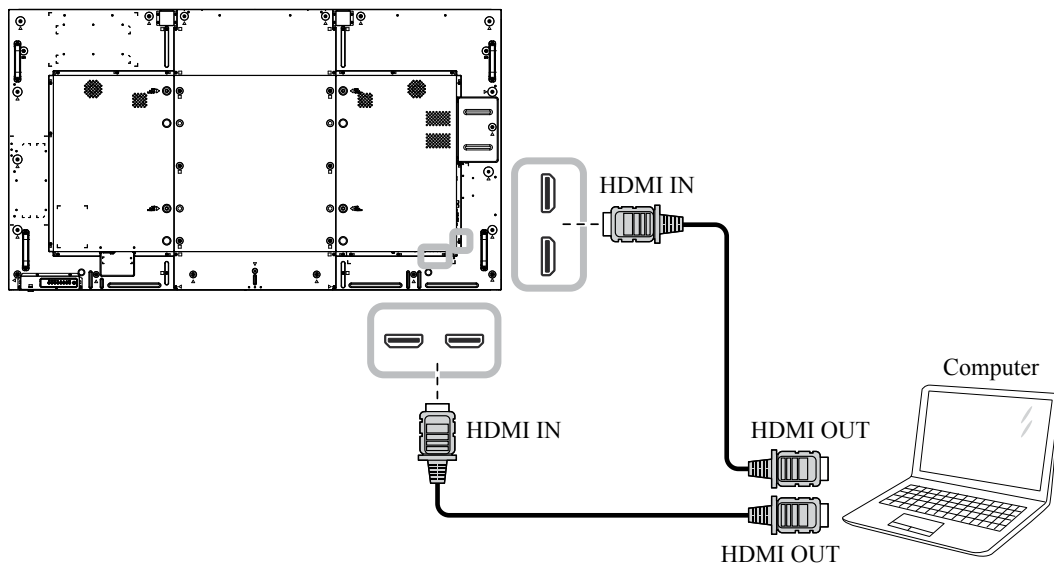

# MAKING CONNECTIONS

## NSD-8601Q

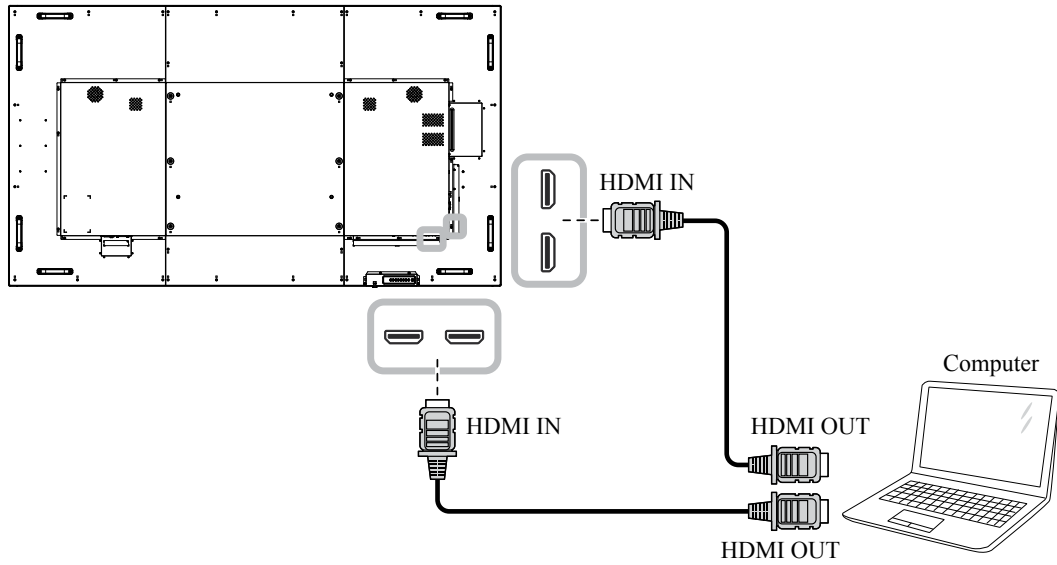

## 2.3 Connecting External Equipment (Video Player)

### 2.3.1 Using HDMI Video Input

Connect one end of an HDMI cable to the HDMI IN connector of the LCD display and the other end of an HDMI cable to the HDMI OUT connector of the video player.

## NSD-6501Q

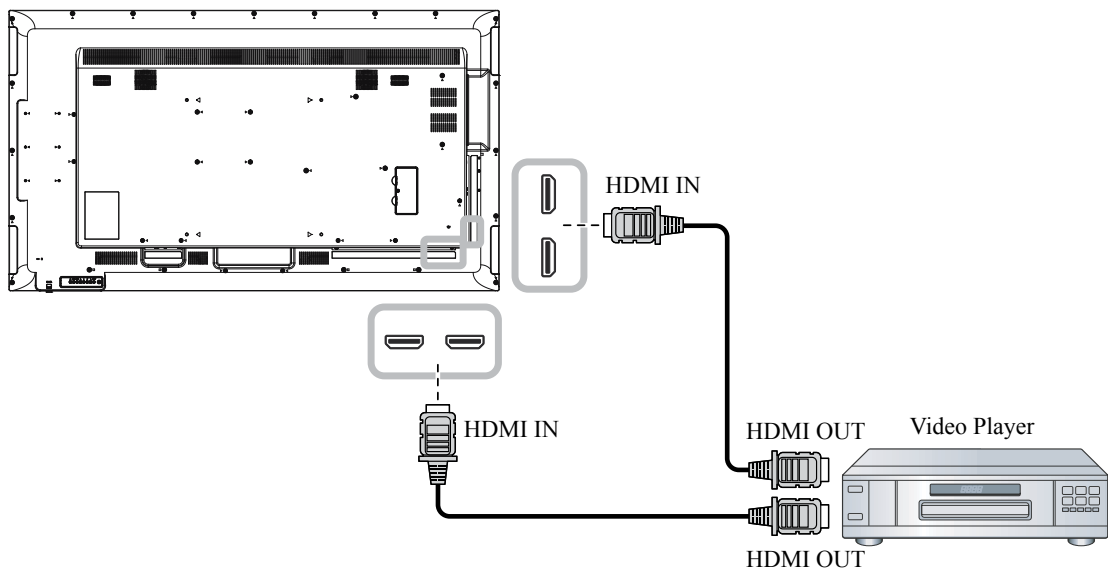

# MAKING CONNECTIONS

## NSD-7501Q

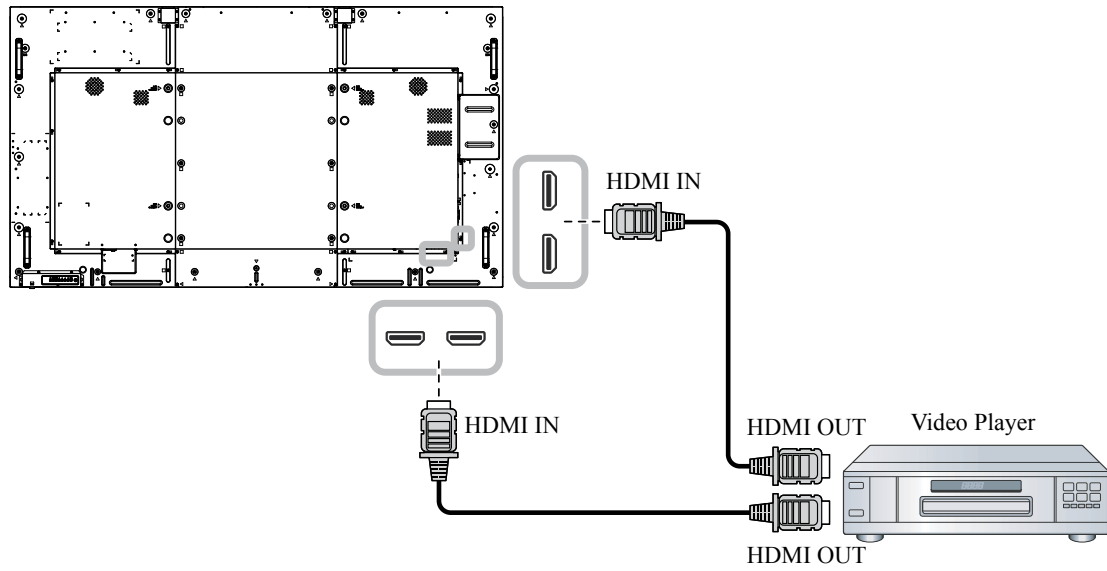

## NSD-8601Q

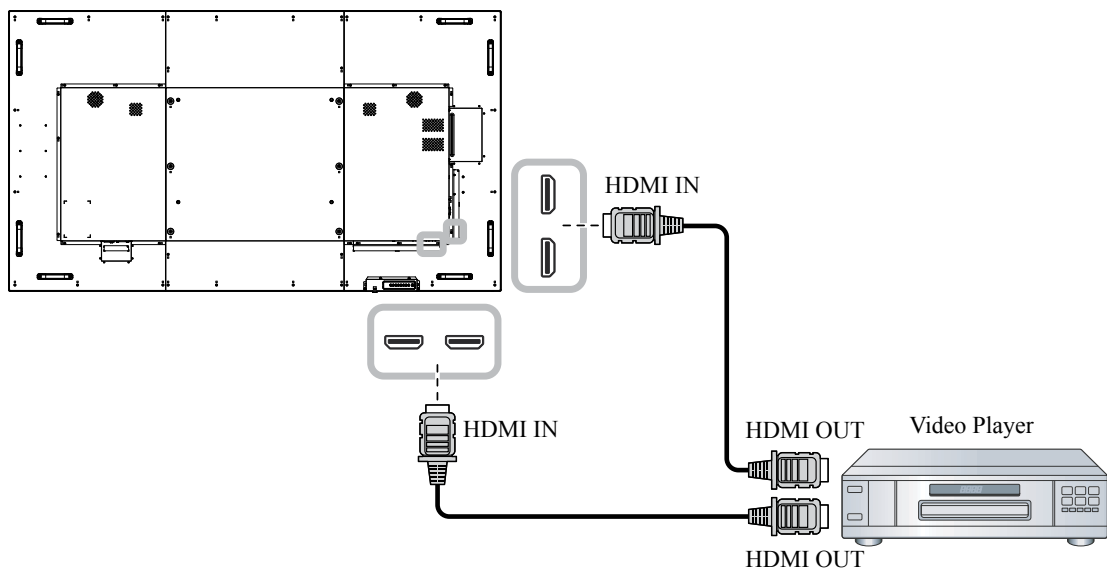

# MAKING CONNECTIONS

## 2.4 Connecting Audio Equipment

### 2.4.1 Connecting an External Audio Device

Connect one end of an audio cable to the AUDIO OUT connectors of the LCD display and the other end of an audio cable to the AUDIO IN connectors of the audio device.

#### NSD-6501Q

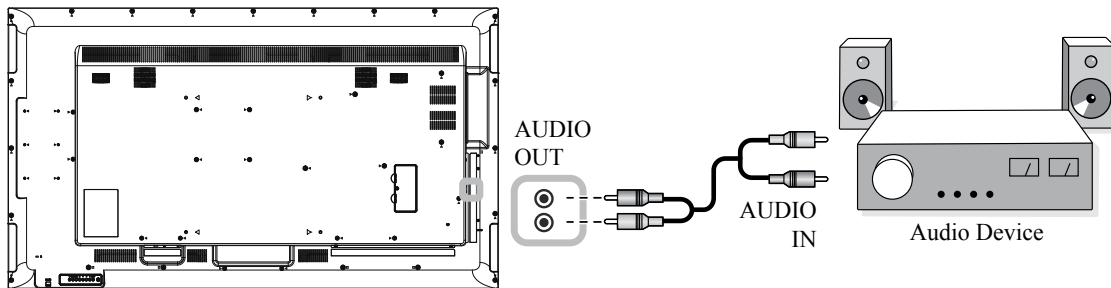

#### NSD-7501Q

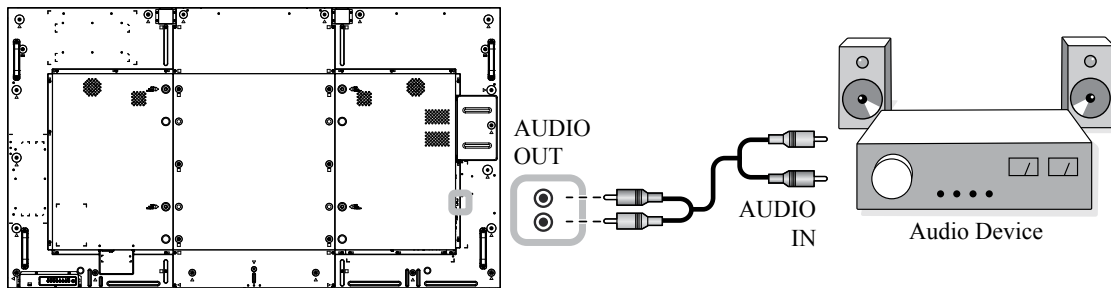

#### NSD-8601Q

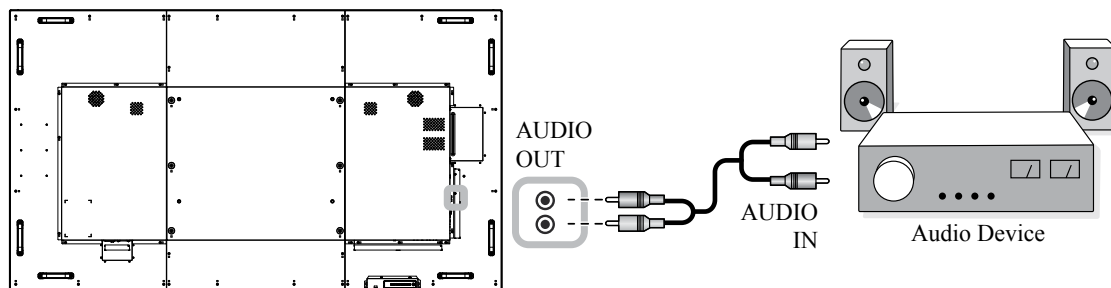

# MAKING CONNECTIONS

## 2.5 Using the Card Reader

Insert a micro SD card into the slot.

### NSD-6501Q

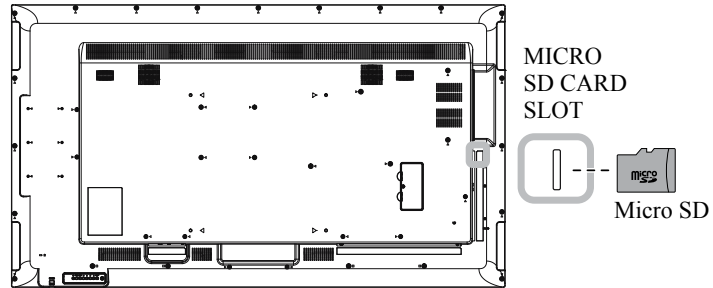

### NSD-7501Q

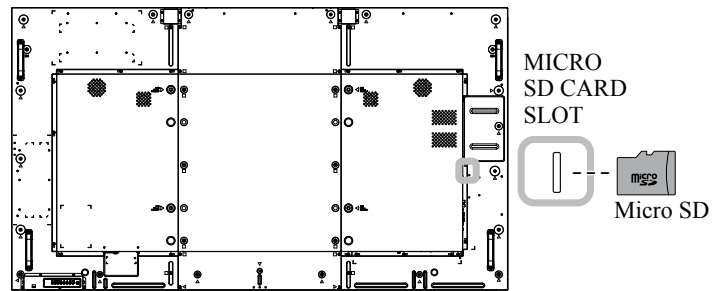

### NSD-8601Q

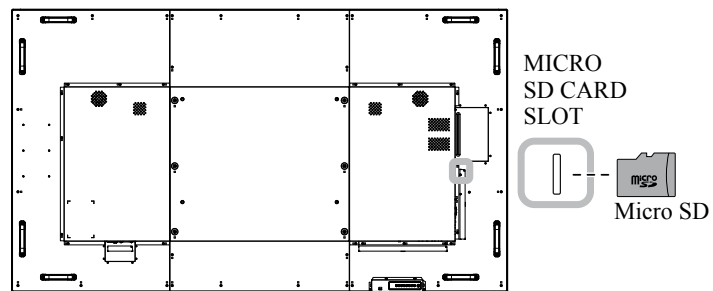

# MAKING CONNECTIONS

## 2.6 Connecting Multiple Displays in a Daisy-chain Configuration

You can interconnect multiple displays to create a daisy-chain configuration for applications such as a video wall.

**⚡ Caution:**

To avoid unnecessary strain on the bezel, it is highly recommended to keep a minimum space of 0.5mm in which a business card is able to slip between all displays on all sides.

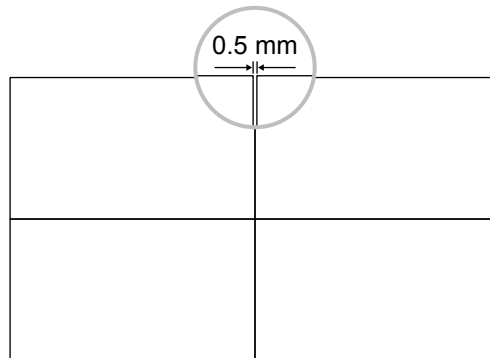

### 2.6.1 Display Control Connection

Connect the RS232 OUT connector of DISPLAY 1 to the RS232 IN connector of DISPLAY 2.

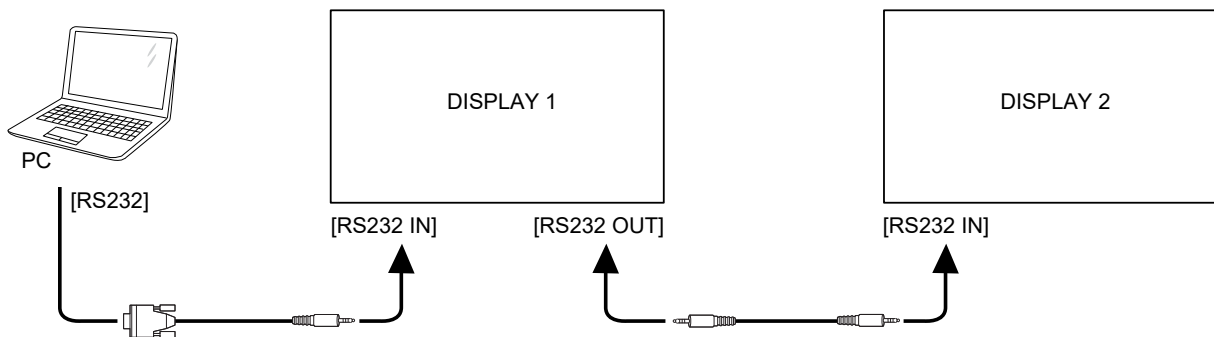

# MAKING CONNECTIONS

## 2.7 IR Connection

Connect the IR sensor cable to the IR IN connector of the LCD display.

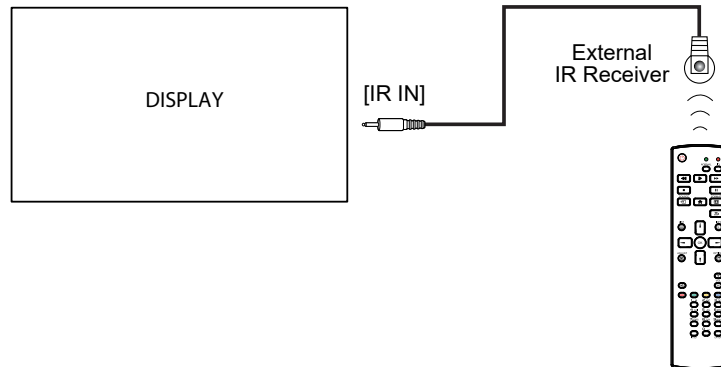

### Note:

- ◆ This display's remote control sensor will stop working if the [IR IN] is connected.
- ◆ IR loop through connection can support up to 9 displays.
- ◆ IR in daisy chain via RS232 connection can support up to 9 displays.

## 2.8 IR Pass-Through Connection

Connect one end of an IR extender cable to the IR OUT connector of the LCD display and the other end of an IR extender cable to the IR IN connector of the video player.

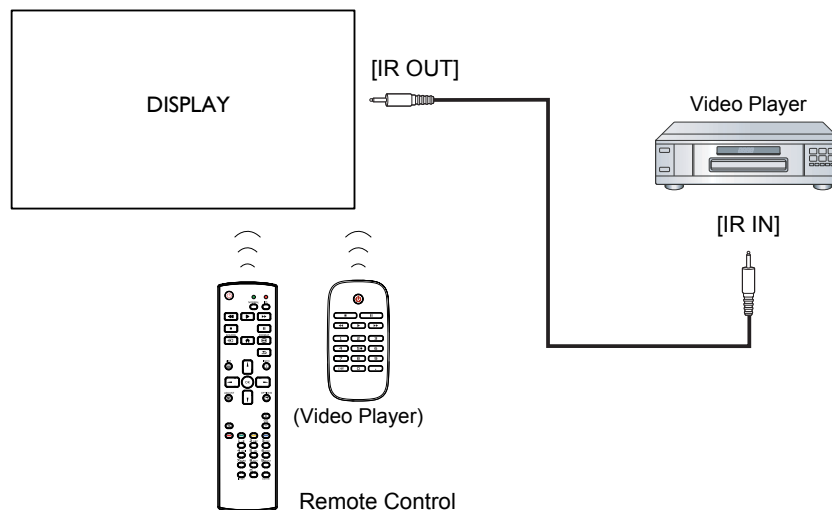



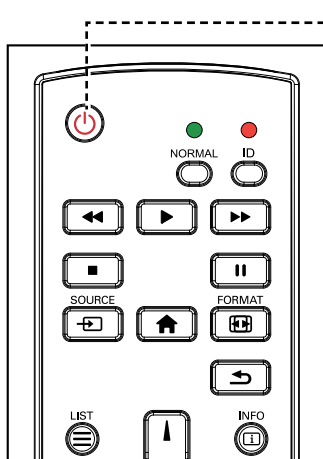

# CHAPTER 3: USING THE LCD DISPLAY

## 3.1 Turning on the Power



1 Plug the power cord to a power outlet or power supply.

2 Press the  button to turn the LCD display on.

When the LCD display is turned on, press the  button to turn off the LCD display.

### Note:

- ◆ The LCD display still consumes power as long as the power cord is connected to the power outlet. Disconnect the power cord to completely cut off power.

### 3.1.1 Initial Setup

After you turn on the LCD display, a Welcome screen opens. You are prompted to select the default OSD language, configure network settings, and more. Follow the on-screen instructions to complete the initial setup.

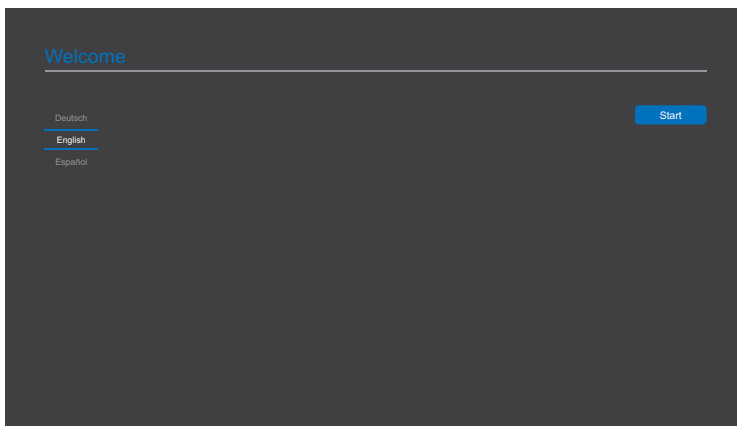

# USING THE LCD DISPLAY

## 3.2 Selecting the Input Source Signal

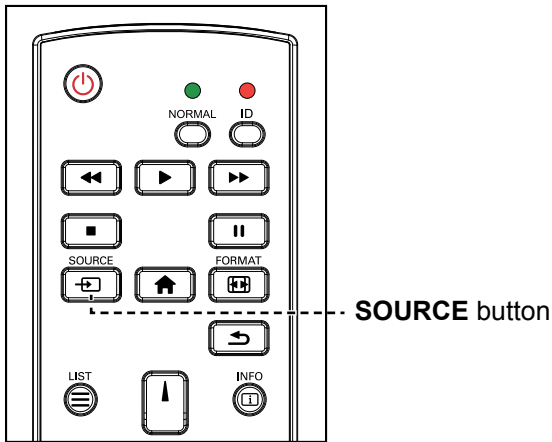

- 1 Press the button.
- 2 Press the or button to choose a device, then press the OK button.

### Note:

- ◆ After pressing the button, a menu with available input sources will be displayed on the screen.

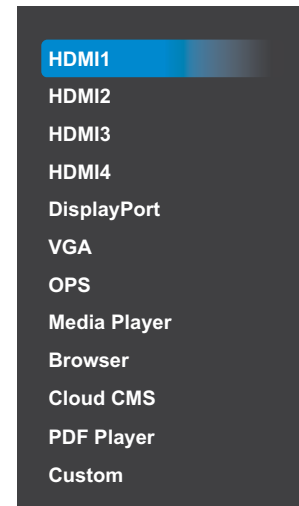

- ◆ If the selected input source signal is not connected to the LCD display or is turned off, the screen will display multi-color screen.

## 3.3 Adjusting the Volume

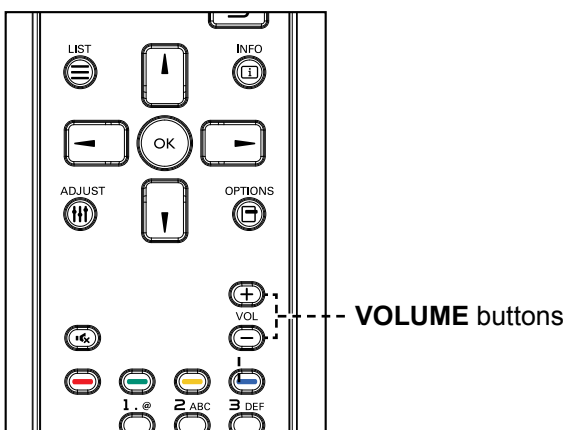

Press the or button to adjust the volume.

### Note:

- ◆ After pressing the or button, the volume icon is displayed on the screen automatically.



- ◆ Press the button to mute the audio.

# USING THE LCD DISPLAY

## 3.4 Changing the Picture Format

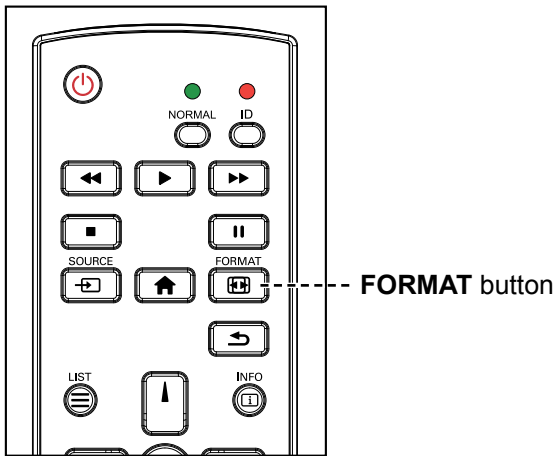

Press the  button repeatedly to change the picture format.

### Note:

The available picture formats include:

- ◆ **Full:** Restores the correct proportions of pictures transmitted in 16:9 using the full screen display.
- ◆ **4:3:** The picture is reproduced in 4:3 format and a black band is displayed on either side of the picture.
- ◆ **Real:** This mode displays the image pixel-by-pixel on screen without scaling the original image size.
- ◆ **21:9:** The picture is reproduced in 21:9 format and a black band at the top and bottom.
- ◆ **Custom:** Choose to apply the custom zoom settings set in the **Screen > Custom zoom** submenu.

# CHAPTER 4: MULTIMEDIA MENU

## 4.1 Accessing the Multimedia Menu



### Note:

- ◆ The control buttons described in this section are on the remote control.
- ◆ Press the  button once in any menu to return to the previous menu or repeatedly to return to the Hint screen as illustrated below.

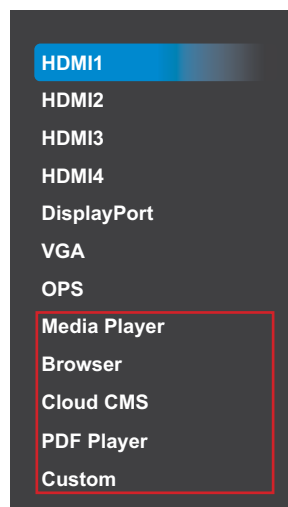

The multimedia menu consists of five items, such as Media Player, Browser, Cloud CMS, PDF Player, and Custom. To access the multimedia menu items, do the following:



- 1 Press the  button to open a list of input sources.
- 2 Press the  or  button to select **Media Player**, **Browser**, **Cloud CMS**, **PDF Player**, or **Custom** from the list.
- 3 Press the **OK** button on the remote control to open the item.

# MULTIMEDIA MENU

## 4.2 Media Player

Use the Media Player to play your favorite photo, video, and music files. The files can be grouped into playlists from various storage devices, such as internal storage, USB storage, and SD card. The total number of playlists can be up to seven but the media content of a single playlist is not limited.

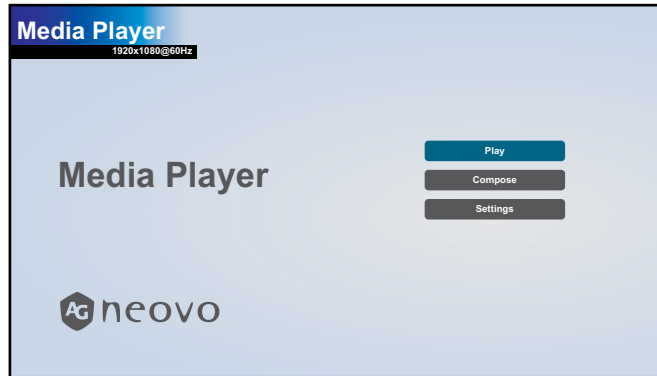

### 4.2.1 Creating a Playlist

To create a playlist, do the following:

- 1 Copy your photo, video, and/or music files on the storage device to the following paths respectfully:
  - Photo: {root dir of storage}/agn/photo/
  - Video: {root dir of storage}/agn/video/
  - Music: {root dir of storage}/agn/music/

#### Note:

- ◆ Music files can be selected and used as background music for a slideshow.
- 2 Connect the storage device to the LCD display (if necessary).
  - 3 Set the input source to **Media Player**. See “4.1 Accessing the Multimedia Menu”.
  - 4 Press the **▲** or **▼** button to select the **Compose** tab and then press the **OK** button to open the PlayList menu.

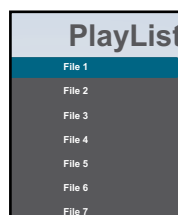

- 5 Press the **▲** or **▼** button to select a file among **File 1** to **File 7** where you want to add your media files and then press the **OK** button.
- 6 Press the **←** or **→** button to select a storage device where are saved your media files and then press the **OK** button.



#### Note:

- ◆ Press the **OK** button again if prompted to confirm the path.

# MULTIMEDIA MENU

A file browser opens where your media files on the storage device are displayed in the Source column and the content of the playlist is displayed in the Playlist column.

- 7 Press the **▲** or **▼** button to select the **Photo** or **Video** folder and then press the **OK** button. The folder content is displayed in the Source column.

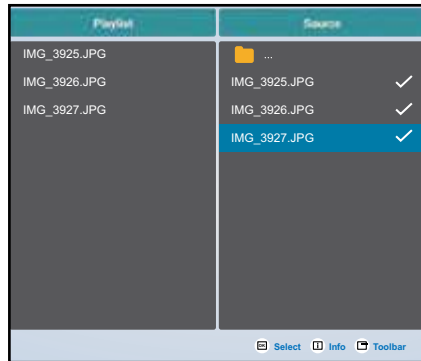

- 8 Press the **▲** or **▼** button to select a media file for reviewing (if necessary). Press any of the following buttons:
  - **OK Select**: To select a single file. Press the **OK** button again to deselect the file.
  - **Info**: To review the detailed information on the media file.
- 9 Press the **Option** button to start adding or modifying the playlist.

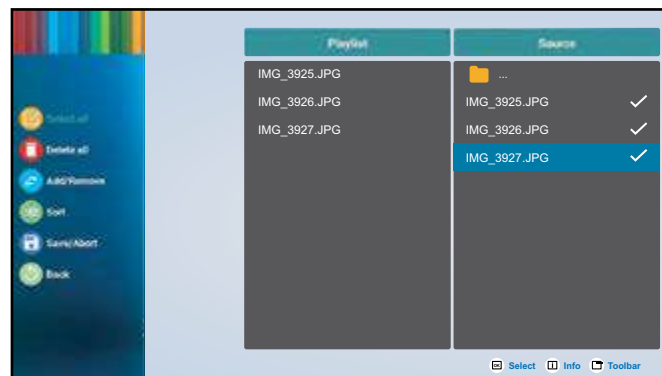

Then press the **▲** or **▼** button and press the **OK** button to select any of the following actions:

- **Select all**: Select all the visible media files on the storage device.
  - **Delete all**: Delete all the media files in the playlist.
  - **Add/Remove**: Add or remove the selected files from the playlist.
  - **Sort**: Sort the media files in the playlist one by one. The Sort menu opens.
    - a) Press the **▲** or **▼** button and then press the **OK** button to select the file. Next to the selected file appears **↑↓** icon.
    - b) Press the **▲** or **▼** button to adjust the file order in the Slideshow.
  - **Save/Abort**: Save the playlist or discard the modifications. Press the **←** or **→** button to select **Save** or **Abort** and then press the **OK** button to confirm. If you have added to the playlist only photos then you are prompted to add background music to the slideshow. Press the **▲** or **▼** button to select **Yes** or **No** and press the **OK** button to confirm. If you decide to add background music to the slideshow, you are prompted to select a music file from the Music folder.
  - **Back**: Close the toolbar.
- 10 Repeat steps 1 to 9 for creating more playlists.

# MULTIMEDIA MENU

## 4.2.2 Modifying a Playlist

To modify a playlist, do the following:

- 1 Set the input source to **Media Player**. See “4.1 Accessing the Multimedia Menu”.
- 2 Press the **▲** or **▼** button to select the **Compose** tab and then press the **OK** button to open the PlayList menu.
- 3 Press the **▲** or **▼** button to select the playlist that you want to modify and then press the **OK** button.

### Note:

- ◆ You can modify only playlists that have the  icon next to the **File #**, where “#” is the file number.

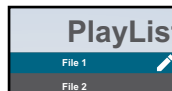

Those playlists that do not have the  icon are empty.

- 4 Press the **←** or **→** button to select **Edit** or **Delete** the playlist and then press the **OK** button to confirm.
- 5 Perform any of the modifications as described in steps 7 and 9 in “4.2.1 Creating a Playlist” section.

## 4.2.3 Playing Files in a Playlist

To play files in a playlist, do the following:

- 1 Set the input source to **Media Player**. See “4.1 Accessing the Multimedia Menu”.
- 2 Press the **▲** or **▼** button to select the **Play** tab and then press the **OK** button to open the PlayList menu.
- 3 Press the **▲** or **▼** button to select the playlist that you want to play and then press the **OK** button.

### Note:

- ◆ You can play only playlists that have the  icon next to the **File #**, where “#” is the file number.

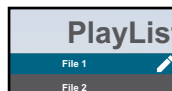

Those playlists that do not have the  icon are empty.

# MULTIMEDIA MENU

## 4.2.4 Media Player Settings

To configure Media Player settings, do the following:

- 1 Set the input source to **Media Player**. See “4.1 Accessing the Multimedia Menu”.
- 2 Press the **▲** or **▼** button to select the **Settings** tab and then press the **OK** button to open the Settings menu.
- 3 Press the **▲** or **▼** button to select any of the menu items and then press the **OK** button to enter its configuration menu:
  - **Repeat Mode**: Press the **▲** or **▼** button to set the playlist repeat mode to Repeat once or Repeat all and then press the **OK** button to save the setting.
  - **Slideshow Effect**: Press the **▲** or **▼** button to set the slideshow effect to **Random**, **Bounce**, **Fade in/out**, **Top to bottom**, **Zoom**, **Left to right**, **Right to left**, **Fold**, **Corner**, or **None** and then press the **OK** button to save the setting.

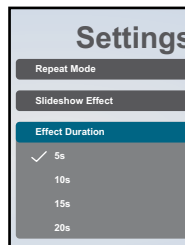

- **Effect Duration**: Press the **▲** or **▼** button to set the slideshow effect duration to **5s**, **10s**, **15s**, or **20s** and then press the **OK** button to save the setting.



# MULTIMEDIA MENU

## 4.3 Browser

Use the Browser app to save up to seven bookmarks (URLs) manually or import a list of URLs from a storage device, such as internal storage, USB storage, and SD card.

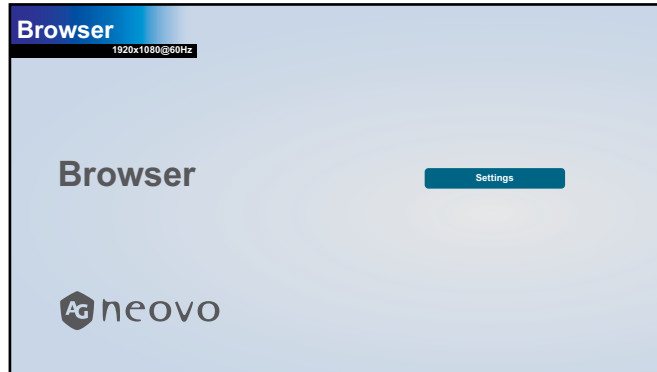

### 4.3.1 Adding an URL

To add an URL, do the following:

- 1 Set the input source to **Browser**. See “4.1 Accessing the Multimedia Menu”.
- 2 Press the OK button to open the **Settings** tab. A list of URLs opens.

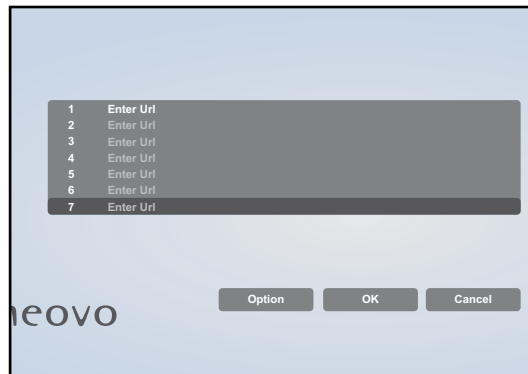

- 3 Do any of the following to add an URL:

— **Adding an URL manually**

- a) Press the  $\blacktriangle$  or  $\blacktriangledown$  button to select an available URL field (Enter url) and then press the OK button.
- b) Press the OK button again to open the virtual keyboard.

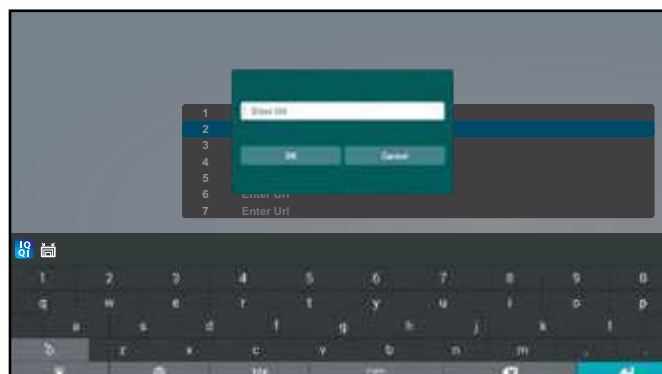

# MULTIMEDIA MENU

- c) Press the **↑**, **↓**, **←**, and/or **→** button to pick each character that appears in the URL name. After selecting a character, press the **OK** button to enter the character. Continue this step until all the characters in the URL are entered.
- d) Press the **↵** button to close the virtual keyboard.
- e) Press the **↓** button and select **OK** to save the URL or **Cancel** to discard the modifications. Then press the **OK** button to confirm the selection.

## — Adding a URL automatically

- a) Save a list of URLs in a text-file with the extension **“.txt”** where **“\*”** is the file name.
- b) Copy the text-file with the URLs to the storage device to the following path:  
`{root dir of storage}/agn/browser/`
- c) Connect the storage device to the LCD display (if necessary).
- d) Press the **↓** button repeatedly to scroll through the URLs in the list and access the **Option** button on the screen. Then press the **OK** button. A toolbar opens on the screen.
- e) Press the **↑** or **↓** button to select **Import** and then press the **OK** button.

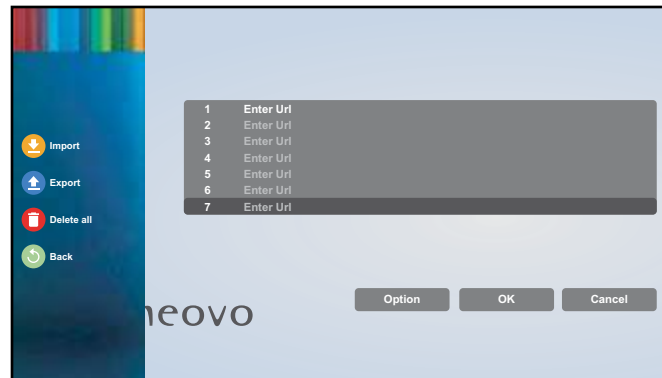

- f) Press the **←** or **→** button to select a storage device where is saved your text-file and then press the **OK** button.



### Note:

- ◆ Press the **OK** button again if prompted to confirm the path.

A **Please choose file** menu opens.



- g) Press the **OK** button to open the **browser** folder.

# MULTIMEDIA MENU

- h) Press the ◀ or ▶ button to select the text-file where are saved the URLs. Then press the OK button. You are prompted to confirm importing the file or cancel the procedure.
- i) Press the ◀ or ▶ button to select Import or Cancel and then press the OK button. After importing the text-file, the URLs appear in the URLs' list in the Browser app.

## 4.3.2 Managing URLs List

To manage URLs list on Browser app, do the following:

- 1 Set the input source to **Browser**. See “4.1 Accessing the Multimedia Menu”.
- 2 Press the OK button to open the **Settings** tab. A list of URLs opens.
- 3 To modify or open an URL, press the ▲ or ▼ button and select an URL. Then press the OK button. You are prompted to modify the URL or open the web page.

### Note:

- ◆ You need an active Internet connection to open a web page. To configure the network parameters, see “4.6.6 Accessing Network Settings in Admin Mode” on page 58.

Press the ◀ or ▶ button and then press the OK button to do any of the following:

- **Edit**: Modify the URL. See “— Adding an URL manually” on page 45 steps c to d.
  - **Play**: Open the webpage on the screen.
- 4 To perform other actions with the URLs list, such as export the list or delete all the entries, press the ▼ button repeatedly until you can select the **Option** button. Then press the OK button. A toolbar opens on the screen.
  - 5 Press the ▲ or ▼ button and then press the OK button to do any of the following:
    - **Export**: Press the ◀ or ▶ button to select the storage device where you want to save the current URLs list. Then press the OK button. After selecting the storage device, you are prompted to confirm the location and the file name of the URLs list. Press the ◀ or ▶ button to Save or Cancel the procedure.

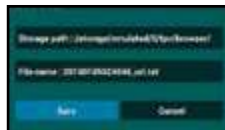

### Note:

- ◆ If you wish to save the URLs list to an external storage device, make sure to connect the storage device to the LCD display before exporting the file.
- **Delete all**: Delete all the URL entries in the list.
  - **Back**: Close the toolbar.

# MULTIMEDIA MENU

## 4.4 Cloud Content Management Software (Cloud CMS)

At Cloud CMS, you can create and schedule signage campaigns, manage devices, and update content from any device with an internet browser.

Ensure that your LCD display is properly connected to the internet. Then set the input source to **Cloud CMS**. A “*Device Registration*” message will appear on the screen.



You need to enter the “device code” in order to register your device to Cloud CMS.

### Note:

- ◆ To access Cloud CMS, register your device, and manage the signage campaigns, visit <https://login.neovosignage.com>. For detail information and settings, please refer to the **Neovo Signage Installation Guide**.

After you successfully added your device to Cloud CMS, the “*Device Registration*” message will not appear on the screen when you switch the input source to **Cloud CMS**. The signage campaign will automatically display on the screen when it is published from Cloud CMS.

# MULTIMEDIA MENU

## 4.5 PDF Player

Use the PDF Player to display your PDF files on the screen. The files can be grouped into playlists from various storage devices, such as internal storage, USB storage, and SD card. The total number of playlists can be up to seven but the PDF file content of a single playlist is not limited.

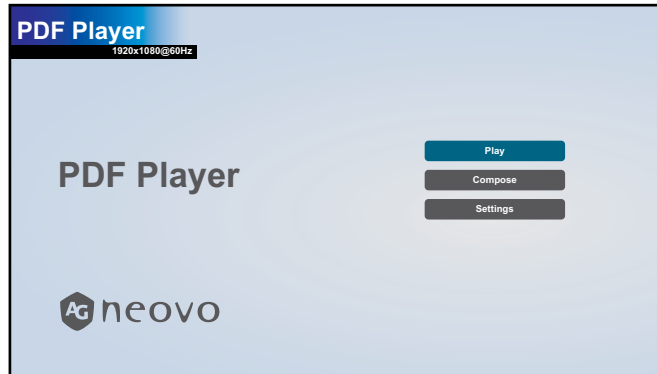

### 4.5.1 Creating a Playlist

To create a playlist, do the following:

- 1 Copy your PDF files on the storage device to the following path:  
— {root dir of storage}/agn/pdf/
- 2 Connect the storage device to the LCD display (if necessary).
- 3 Set the input source to **PDF Player**. See “4.1 Accessing the Multimedia Menu”.
- 4 Press the **▲** or **▼** button to select the **Compose** tab and then press the **OK** button to open the PlayList menu.

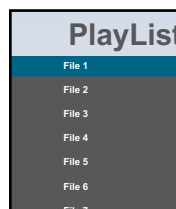

- 5 Press the **▲** or **▼** button to select a file among **File 1** to **File 7** where you want to add your PDF files and then press the **OK** button.
- 6 Press the **←** or **→** button to select a storage device where are saved your PDF files and then press the **OK** button.



#### Note:

- ◆ Press the **OK** button again if prompted to confirm the path.

A file browser opens where your PDF files on the storage device are displayed in the Source column and the content of the playlist is displayed in the Playlist column.

# MULTIMEDIA MENU

- 7 Press the **▲** or **▼** button to select the **PDF** folder and then press the **OK** button. The folder content is displayed in the Source column.

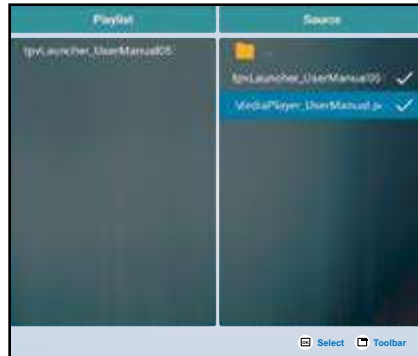

- 8 Press the **▲** or **▼** button to select a PDF file and then press the **OK** button. To select all the PDF files in the folder, proceed to step 9.
- 9 Press the **Options**  button to add or modify the playlist.

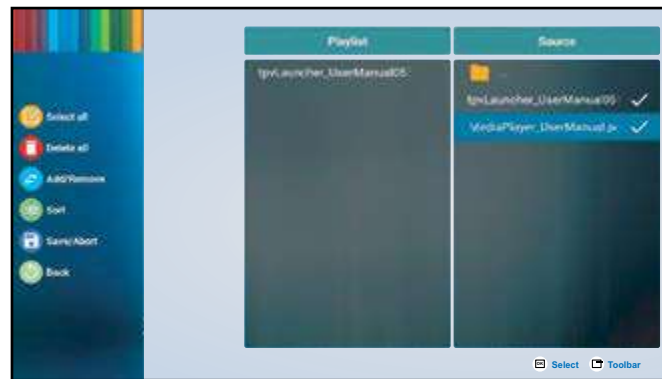

Then press the **▲** or **▼** button and press the **OK** button to select any of the following actions:

- **Select all**: Select all the PDF files on the storage device.
  - **Delete all**: Delete all the files in the playlist.
  - **Add/Remove**: Add or remove the selected files from the playlist.
  - **Sort**: Sort the PDF files in the playlist one by one. The Sort menu opens.
    - a) Press the **▲** or **▼** button and then press the **OK** button to select the file. Next to the selected file appears  icon.
    - b) Press the **▲** or **▼** button to adjust the file order in the Slideshow.
  - **Save/Abort**: Save the playlist or discard the modifications. Press the **◀** or **▶** button to select Save or Abort and then press the **OK** button to confirm.
  - **Back**: Close the toolbar.
- 10 Repeat steps 1 to 9 for creating more playlists.

# MULTIMEDIA MENU

## 4.5.2 Modifying a Playlist

To modify a playlist, do the following:

- 1 Set the input source to **PDF Player**. See “4.1 Accessing the Multimedia Menu”.
- 2 Press the **▲** or **▼** button to select the **Compose** tab and then press the **OK** button to open the PlayList menu.
- 3 Press the **▲** or **▼** button to select the playlist that you want to modify and then press the **OK** button.

### Note:

- ◆ You can modify only playlists that have the  icon next to the **File #**, where “#” is the file number.

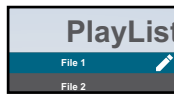

Those playlists that do not have the  icon are empty.

- 4 Press the **←** or **→** button to select **Edit** or **Delete** the playlist and then press the **OK** button to confirm.
- 5 Perform any of the modifications as described in steps 7 to 9 in “4.5.1 Creating a Playlist” section.

## 4.5.3 Displaying PDF Files in a Playlist

To display the PDF files in a playlist, do the following:

- 1 Set the input source to **PDF Player**. See “4.1 Accessing the Multimedia Menu”.
- 2 Press the **▲** or **▼** button to select the **Play** tab and then press the **OK** button to open the PlayList menu.
- 3 Press the **▲** or **▼** button to select the playlist that you want to display and then press the **OK** button.

### Note:

- ◆ You can display only playlists that have the  icon next to the **File #**, where “#” is the file number.

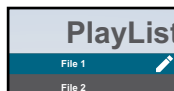

Those playlists that do not have the  icon are empty.

## 4.5.4 PDF Player Settings

To configure PDF Player settings, do the following:

- 1 Set the input source to **PDF Player**. See “4.1 Accessing the Multimedia Menu”.
- 2 Press the **▲** or **▼** button to select the **Settings** tab and then press the **OK** button to open the Settings menu.

# MULTIMEDIA MENU

- Press the **▲** or **▼** button to select any of the menu items and then press the **OK** button to enter its configuration menu:
  - **Repeat Mode**: Press the **▲** or **▼** button to set the playlist repeat mode to **Repeat once** or **Repeat all** and then press the **OK** button to save the setting.
  - **Effect Duration**: Press the **▲** or **▼** button to set the slideshow effect duration to **5s**, **10s**, **15s**, or **20s** and then press the **OK** button to save the setting.

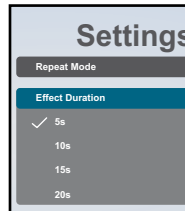

## 4.6 Custom

In Custom screen, you can enter the Admin Mode. The Admin Mode enables you full access to the system configuration settings, applications, network configuration parameters, and storage.

The default Custom screen is empty to prevent unauthorized access to the system.

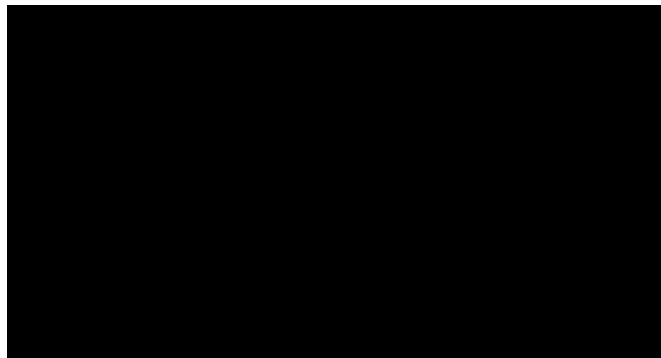

### 4.6.1 Entering the Admin Mode

To enter the Admin Mode, do the following:

- Set the input source to **Custom**. See “4.1 Accessing the Multimedia Menu”.
- Enter the Admin Mode by pressing the **▲** button once followed by entering numbers “1”, “6”, “6”, and “8” on the remote control. The Admin Mode screen opens.





# MULTIMEDIA MENU

## 4.6.2 System Settings

To access the system settings, do the following:

- 1 Enter the Admin Mode. See “4.6.1 Entering the Admin Mode” on page 52.
- 2 Do any of the following to access the system settings:
  - Press the ◀ or ▶ button to select the **Settings** tab and then press the OK button.
  - Press the ◀ or ▶ button and then press the OK button to open **Apps** tab > **Settings**.

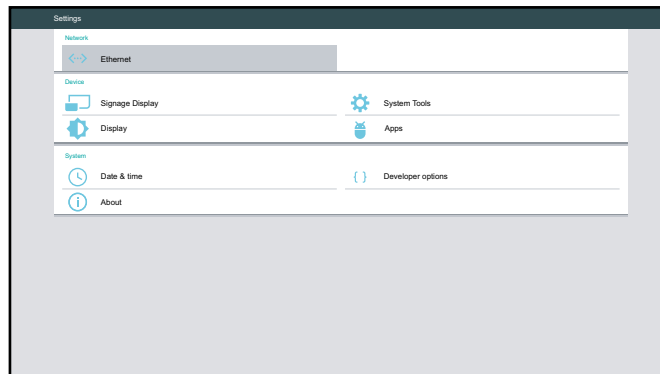

- 3 Modify any of the following settings:

### Note:

- ◆ Use the ◀, ▶, ▲, ▼, and/or OK button on the remote control to select items and adjust settings. If you need to enter characters, the virtual keyboard opens automatically on the screen after you select the item.

- **Network > Ethernet > Main Switch:** Enable or disable configuring Ethernet settings.
- **Network > Ethernet > Ethernet Configuration:** Review MAC address and configure the network connection settings, such as **Connection Type** (DHCP or static IP), **IP Address**, **Netmask**, **DNS Address**, and **Gateway**.
- **Device > Signage Display > General settings > Signage Display Name:** Review or modify the signage display name if necessary.
- **Device > Signage Display > General settings > Boot Logo:** Set boot animation. The system checks for the “boot animation.zip” file from the connected USB storage or SD card.



- **Device > Signage Display > General settings > Screenshot > Main Switch:** Enable or disable configuring screenshot settings.
- **Device > Signage Display > General settings > Screenshot > Screenshot:** Configure screenshot capturing settings, such as **Interval**, **Start/End time**, **Repeat**, **Save to** (storage selection), **Purge Screenshots**, and **Send screenshots via email**.
- **Device > Signage Display > Server settings > Email Notification > Main Switch:** Enable or disable configuring email notification settings.

# MULTIMEDIA MENU

- **Device > Signage Display > Server settings > Email Notification > SMTP:** Configure SMTP settings, such as **Server**, **Email**, **Password**, **SMTP Server name**, **Security type**, and **Port**.
- **Device > Signage Display > Server settings > Email Notification > Manager Email:** Enter manager email.
- **Device > Signage Display > Server settings > FTP > Main Switch:** Enable or disable configuring FTP settings.
- **Device > Signage Display > Server settings > FTP > FTP:** Configure FTP server connection settings, such as **Account**, **Password**, **Storage Path**, and **Port**.
- **Device > Signage Display > Server settings > SICP Network Port > Main Switch:** Enable or disable configuring Serial / Ethernet Interface Communication Protocol (SICP) settings.
- **Device > Signage Display > Server settings > SICP Network Port > SICP Network Port:** Set the SICP connection port (used for controlling the LCD display via RS232 / Ethernet).
- **Device > Signage Display > Source settings > Media Player:** Access to **Edit Play List** or **Edit Effect Settings**. For more information on Media Player, see “4.2 Media Player” on page 41.
- **Device > Signage Display > Source settings > Browser:** Access to Edit Bookmark. More information on adding bookmarks, see “4.3 Browser” on page 45.
- **Device > Signage Display > Source settings > CMS > Settings:** Configure CMS Server connection settings, such as **Server**, **Account**, **PIN Code**, and **Version**. For more information on CMS, see “Using a CMS Server for Content Source” on page 56.
- **Device > Signage Display > Source settings > CMS > Content:** Select the CMS content from a storage device, such as **Internal storage**, **SD card**, or **USB storage**. For more information on CMS, see “Displaying Content from an Attached Storage Device” on page 57.
- **Device > Signage Display > Source settings > PDF Player:** Access to **Edit Play List** or **Edit Effect Settings**. For more information on PDF Player, see “4.5 PDF Player” on page 49.
- **Device > Signage Display > Source settings > Custom App:** Assign the selected app as a custom source.
- **Device > Signage Display > Security > External Storage:** Check to lock or unlock using the external storage, such as SD card and USB storage.
- **Device > Display > Font size:** Set the font size to **Small**, **Normal**, **Large**, or **Huge**.
- **Device > System Tools > Clear storage:** Clear data on **All** storage devices, **Internal storage**, **USB storage**, or **SD card**.
- **Device > System Tools > Reset:** Perform **Factory Reset** to reset all system settings to the factory defaults.
- **Device > System Tools > Import & Export: Export Signage Display Settings** or **Import Signage Display Settings** to a specified storage device.
- **Device > System Tools > Clone > Clone Source:** Select a storage device among **Internal storage**, **SD card**, and **USB storage** for cloning.
- **Device > System Tools > Clone > Target Location:** Set the storage device among **Internal storage**, **SD card**, and **USB storage** as a target location for cloning.
- **Device > Apps:** Review and manage apps that are installed on your LCD display. The apps are categorized as **DOWNLOADED**, **RUNNING**, and **ALL**.

# MULTIMEDIA MENU

- **System > Date & time:** Access to **Select time zone** and review **NTP Server**.
- **System > About:** Set location for **System updates**, review **Legal information**, **Android version**, **Kernel version**, and **Build number**.
- **System > Developer options:** Configure advanced system settings (for Android system developers).

## 4.6.3 Accessing Apps in Admin Mode

To access installed apps in Admin Mode, do the following:

- 1 Enter the Admin Mode. See “4.6.1 Entering the Admin Mode” on page 52.
- 2 Press the ◀ or ▶ button to select the **Apps** tab and then press the OK button. The apps screen opens.



- 3 Press the ◀ or ▶ button to select the app and then press the OK button to open the app.

## 4.6.4 Displaying Content via CMS App

Using the CMS app, you can display any signage campaigns created by using the CMS software installed in your computer or imported the campaigns from a storage device.

### Installing the CMS Software

- 1 Go to the Download Centre in [displays.agneovo.com](http://displays.agneovo.com) to download the CMS software. Then following the on-screen instructions to complete the installation.
- 2 Launch the software.



# MULTIMEDIA MENU

- 3 Enter the account name and password.

## Note:

- ◆ Default access information:  
Account name: admin  
Password: admin

- 4 Create a campaign, configure the schedule, and publish the campaign. For more information on how to use the software, please refer to its documentation.

## Note:

- ◆ To obtain the software user guide, go to the Download Centre in [displays.agneovo.com](http://displays.agneovo.com).
- ◆ Before publishing the campaign, you have to configure the settings first so that your computer can act as a CMS Server. See “Using a CMS Server for Content Source” section.

## Using a CMS Server for Content Source

To access the content from a CMS Server (via the software installed in your computer), your LCD display needs to be connected to the same network segment with the CMS Server and you need to configure the connection parameters on your LCD display.

To configure your LCD display for displaying a content from a CMS Server, do the following:

- 1 Connect your LCD display to the network.
- 2 Set the input source to **Custom**. See “4.1 Accessing the Multimedia Menu”.
- 3 Enter the Admin Mode. See “4.6.1 Entering the Admin Mode” on page 52.
- 4 Press the ← or → button to select the **Settings** tab and then press the OK button.
- 5 Press the ↓ or ↑ button and then press the OK button to select **Signage Display > Source settings > CMS > Settings**.
- 6 Press the ↓ or ↑ button and then press the OK button to select and configure the CMS Server connection parameters, such as **Settings > Server / Account / PIN Code**.

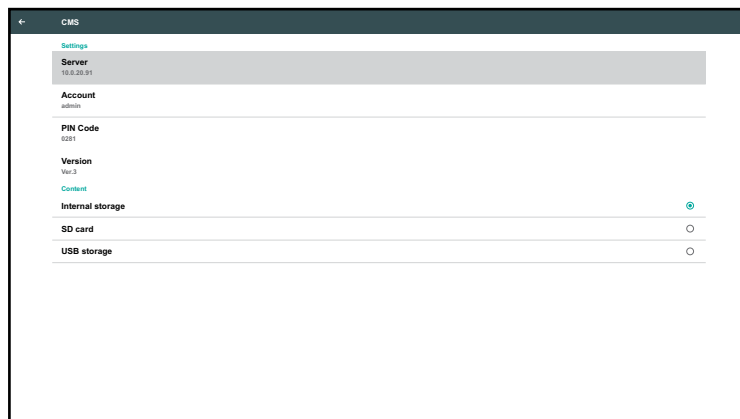

# MULTIMEDIA MENU

## Note:

- ◆ Enter your computer IP address in the Server field. You can obtain the account name and pin code data from the CMS software (in the **DEVICE** section).
- ◆ After the connection parameters are configured on the LCD display, the CMS Server will automatically detect a new device. The CMS Server manager can schedule the content displaying for the LCD display.
- ◆ When adding the LCD display as a new device to the CMS Server, it is recommended to use the Signage Display name as a Device Name.



- 7 To view the content from the CMS Server, exit **Settings** and select the **Apps** tab. Then select **CMS**.

## Displaying Content from an Attached Storage Device

You can configure the LCD display to use content from a storage device, such as internal storage, USB storage, and SD card.

To configure your LCD display to display CMS content from a storage device, do the following:

- 1 Copy the source files to the storage device in the following path:  
— {root dir of storage}/agn/CMS/
- 2 Connect the storage device to the LCD display (if necessary).
- 3 Set the input source to **Custom**. See “4.1 Accessing the Multimedia Menu”.
- 4 Enter the Admin Mode. See “4.6.1 Entering the Admin Mode” on page 52.
- 5 Press the **←** or **→** button to select the **Settings** tab and then press the OK button.
- 6 Press the **↓** or **↑** button and then press the OK button to select **Signage Display > Source settings > CMS > Content**.
- 7 Press the **↓** or **↑** button to select the storage device where the CMS content is saved and then press the OK button.
- 8 To view the content, exit **Settings** and select the **Apps** tab. Then select **CMS**.

# MULTIMEDIA MENU

## 4.6.5 Installing Apps to the LCD Display

To install new apps to your LCD display, do the following:

- 1 Download and copy the Android installation file named “\*.apk” where “\*” is the app’s name to the USB storage or SD card.
- 2 Connect the storage device with the installation file to the LCD display.
- 3 Enter the Admin Mode. See “4.6.1 Entering the Admin Mode” on page 52.
- 4 Press the ◀ or ▶ button to select **Storage** tab and then press the OK button.
- 5 Press the ◀ or ▶ button to select the storage device where is saved the installation file and press the OK button.
- 6 Press the ▲ or ▼ button to select the installation file and then press the OK button. A pop-up menu opens.
- 7 Press the ▲ or ▼ button to select **Open** and then press the OK button. Follow the on-screen instructions to install the app. After the installation is complete, the app becomes visible in **Apps** tab where you can access it.

## 4.6.6 Accessing Network Settings in Admin Mode

To access network configuration settings in Admin Mode, do the following:

- 1 Enter the Admin Mode. See “4.6.1 Entering the Admin Mode” on page 52.
- 2 Do any of the following to access the network settings:
  - Press the ◀ or ▶ button and then press the OK button to select the **Settings** tab > **Network** > **Ethernet** > **Ethernet Configuration**.
  - Press the ◀ or ▶ button to select **Network** tab and then press the OK button.

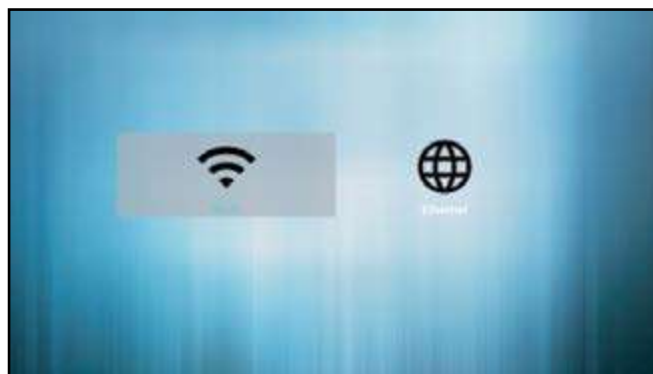

- 3 Press the ◀ or ▶ button to select the **Wi-Fi** tab or the **Ethernet** tab and then press the OK button to start configuring the connection settings.

### Note:

- ◆ The Wi-Fi configuration settings are visible only if you have connected a compatible Wi-Fi dongle to the LCD display. For a wireless connection, QM-Series displays are compatible with following Wi-Fi dongles: TP-LINK TL-WN725N (V3.0), TP-LINK Archer T4U (V3.0), and D-LINK DWA-182 (D1).

# MULTIMEDIA MENU



## 4.6.7 Managing Storage in Admin Mode

To access and manage storage in Admin Mode, do the following:

- 1 Enter the Admin Mode. See “4.6.1 Entering the Admin Mode” on page 52.
- 2 Do any of the following to access the storage:
  - Press the ◀ or ▶ button to select **Storage** tab and then press the OK button.
  - Press the ◀ or ▶ button and then press the OK button to select **Apps** tab > **File Manager**.
- 3 Press the ◀ or ▶ button to select the internal storage or any connected external storages, such as USB storage or SD card.
- 4 Press the ▲ or ▼ button to select the desired file and then press the OK button. A pop-up menu opens.
- 5 Press the ▲ or ▼ button and then the OK button to do any of the following:
  - **Open**: Open the file on the screen.
  - **Delete**: Delete the file.
  - **Copy**: Press the ▲ or ▼ button and select the destination storage device where you want to copy the file. Then press the OK button to complete the procedure.
  - **Move**: Press the ▲ or ▼ button and select the destination storage device where you want to move the file. Then press the OK button to complete the procedure.
  - **Select**: Enter the file Select Mode. Press the ▲ or ▼ button and then press the OK button to select file(s). After the file selection is done, press the OK button. Then press the ▲ or ▼ button to select an action from the pop-up menu among **Delete Selection**, **Copy Selection**, **Move Selection**, **Unselect**, and **Unselect All**. Press the OK button to complete the procedure.

# CHAPTER 5: ON SCREEN DISPLAY MENU

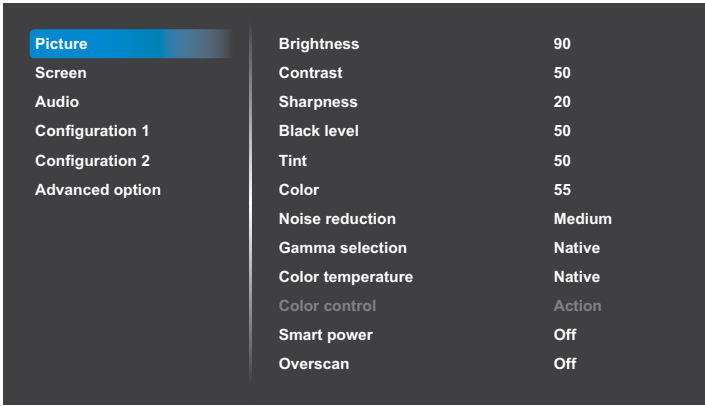
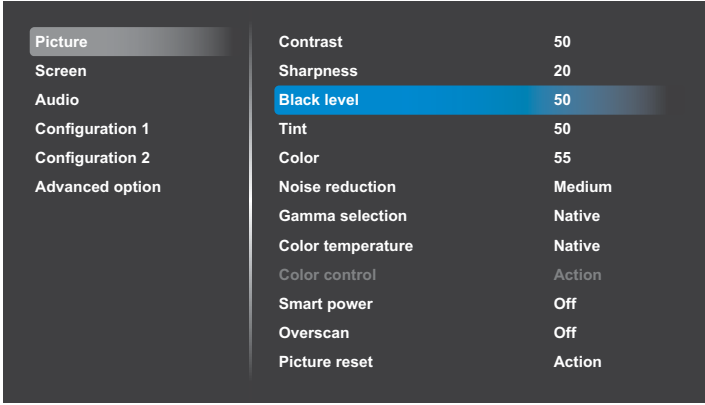
## 5.1 Using the OSD Menu

#	Menu Navigation	Operation	
		Control Panel	Remote Control
1	Display the main menu screen. 	Press the <b>MENU</b> button.	Press the <b>Home</b> button.
2	Enter the submenu.  <p>The highlighted item (blue) indicates the active submenu.</p>	1 Press the <b>▲</b> or <b>▼</b> button to select the menu item. 2 Press the <b>+</b> button to enter the submenu.	1 Press the <b>↓</b> or <b>↑</b> button to select the menu item. 2 Press the <b>OK</b> or <b>→</b> button to enter the submenu.
3	Adjust the settings. For example: 	1 Press the <b>▲</b> or <b>▼</b> button to select the submenu item. 2 Press the <b>+</b> button to open the submenu item. 3 Press the <b>▲</b> or <b>▼</b> button to adjust the value of the menu item.	1 Press the <b>↓</b> or <b>↑</b> button to select the submenu item. 2 Press the <b>OK</b> button to open the submenu item. 3 Press the <b>←</b> or <b>→</b> button to adjust the value of the menu item.
4	Exit the submenu.	Press the <b>MENU</b> or <b>←</b> button to return to the previous menu.	Press the <b>OK</b> or <b>↶</b> button to return to the previous menu.



# ON SCREEN DISPLAY MENU

#	Menu Navigation	Operation	
		Control Panel	Remote Control
5	Close the OSD window.	Press the <b>MENU</b> button or <b>—</b> button several times.	Press the <b>⬆</b> button or the <b>↶</b> button several times.

When settings are modified, all changes are saved when the user does the following:

- Proceeds to the another menu.
- Exits the OSD menu.
- Waits for the OSD menu to disappear.

## Note:

- ◆ Availability of some menu items depend on the input source signal. If the menu is not available, it is disabled and grayed out.

# ON SCREEN DISPLAY MENU

## 5.2 OSD Menu Tree

1	Picture	Brightness	90
2	Screen	Contrast	50
3	Audio	Sharpness	20
4	Configuration 1	Black level	50
5	Configuration 2	Tint	50
6	Advanced option	Color	55
		Noise reduction	Medium
		Gamma selection	Native
		Color temperature	Native
		Color control	Action
		Smart power	Off
		Overscan	Off

Main Menu	Submenu	Remarks
1. Picture	<ul style="list-style-type: none"> <li>• Brightness</li> <li>• Contrast</li> <li>• Sharpness</li> <li>• Black level</li> <li>• Tint</li> <li>• Color</li> <li>• Noise reduction</li> <li>• Gamma selection</li> <li>• Color temperature</li> <li>• Color control</li> <li>• Smart power</li> <li>• Overscan</li> <li>• Picture reset</li> </ul>	See page 64.
2. Screen	<ul style="list-style-type: none"> <li>• H position</li> <li>• V position</li> <li>• Clock</li> <li>• Clock phase</li> <li>• Zoom mode</li> <li>• Custom zoom</li> <li>• Auto adjust</li> <li>• Screen reset</li> </ul>	See page 68.

# ON SCREEN DISPLAY MENU







Main Menu	Submenu	Remarks
3. Audio	<ul style="list-style-type: none"> <li>• Balance</li> <li>• Treble</li> <li>• Bass</li> <li>• Volume</li> <li>• Audio out (line out)</li> <li>• Maximum volume</li> <li>• Minimum volume</li> <li>• Mute</li> <li>• Audio source</li> <li>• Audio reset</li> <li>• Audio Out Sync</li> </ul>	See page 70.
4. Configuration1	<ul style="list-style-type: none"> <li>• Switch on state</li> <li>• Panel saving</li> <li>• RS232 routing</li> <li>• Boot on source</li> <li>• WOL</li> <li>• RGB Range</li> <li>• Configuration1 reset</li> <li>• Factory reset</li> </ul>	See page 72.
5. Configuration2	<ul style="list-style-type: none"> <li>• OSD turn off</li> <li>• OSD H position</li> <li>• OSD V position</li> <li>• Information OSD</li> <li>• Logo</li> <li>• Monitor ID</li> <li>• Heat status</li> <li>• Monitor information</li> <li>• HDMI Version</li> <li>• Configuration2 reset</li> </ul>	See page 76.
6. Advanced option	<ul style="list-style-type: none"> <li>• IR control</li> <li>• Power LED light</li> <li>• Keyboard control</li> <li>• Off Timer</li> <li>• Date and time</li> <li>• Schedule</li> <li>• HDMI with One Wire</li> <li>• Language</li> <li>• OSD transparency</li> <li>• Power Save</li> <li>• OPS settings</li> <li>• Advanced option reset</li> </ul>	See page 78.

# CHAPTER 6: ADJUSTING THE LCD DISPLAY



## 6.1 Picture Settings

Picture	Brightness	90
Screen	Contrast	50
Audio	Sharpness	20
Configuration 1	Black level	50
Configuration 2	Tint	50
Advanced option	Color	55
	Noise reduction	Medium
	Gamma selection	Native
	Color temperature	Native
	Color control	Action
	Smart power	Off
	Overscan	Off

- 1 Press the **MENU** button on the control panel or the **⬆** button on the remote control to call out the OSD window.
- 2 Select **Picture**, then press the **+** button on the control panel or the **OK** button on the remote control.
- 3 Press the **▲/▼** button on the control panel or the **⬅/➡** button on the remote control to select an option.
- 4 Press the **+** button on the control panel or the **OK** button on the remote control to open the submenu item.

Item	Function	Operation	Range
Brightness	Adjust the luminance of the screen image.	Press the <b>▲/▼</b> button on the control panel or the <b>⬅/➡</b> button on the remote control to adjust the value.	0 to 100
	<div style="display: flex; justify-content: space-around;"> <div style="text-align: center;"> <p><i>Original Setting</i></p>  </div> <div style="text-align: center;"> <p><i>High Setting</i></p>  </div> <div style="text-align: center;"> <p><i>Low Setting</i></p>  </div> </div>		
Contrast	Adjust the difference between the black level and the white level.	Press the <b>▲/▼</b> button on the control panel or the <b>⬅/➡</b> button on the remote control to adjust the value.	0 to 100
	<div style="display: flex; justify-content: space-around;"> <div style="text-align: center;"> <p><i>Original Setting</i></p>  </div> <div style="text-align: center;"> <p><i>High Setting</i></p>  </div> <div style="text-align: center;"> <p><i>Low Setting</i></p>  </div> </div>		
Sharpness	Adjust the clarity and focus of the screen image.	Press the <b>▲/▼</b> button on the control panel or the <b>⬅/➡</b> button on the remote control to adjust the value.	0 to 100

# ADJUSTING THE LCD DISPLAY

Item	Function	Operation	Range
Black level	Adjusts the black level of the screen image. Low brightness setting makes black colour darker.	Press the ▲/▼ button on the control panel or the ←/→ button on the remote control to adjust the value.	0 to 100
Tint	Adjust the colour tint.		0 to 100
Color	Adjust the color saturation of the picture.		0 to 100
Noise reduction	Adjust the noise reduction to help remove noise from images. This helps produce clearer and crisper images.	<ol style="list-style-type: none"> <li>1 Press the ▲/▼ button on the control panel or the M/∇ button on the remote control to select the setting.</li> <li>2 Press the + button on the control panel or the OK button on the remote control to set the value.</li> </ol>	Off Low Medium High
		<div style="display: flex; justify-content: space-around;"> <div style="text-align: center;"> <p><i>Noise Reduction Off</i></p>  </div> <div style="text-align: center;"> <p><i>Noise Reduction On</i></p>  </div> </div>	
Gamma selection	Adjust the non-linear setting for picture luminance and contrast.	<ol style="list-style-type: none"> <li>1 Press the + button on the control panel or the OK button on the remote control to open the settings.</li> <li>2 Press the ▲/▼ button on the control panel or the M/∇ button on the remote control to select the setting.</li> <li>3 Repeat step 1 to set the setting.</li> <li>4 Press the ↓ button and then the ←/→ button on the remote control to select <b>CANCEL</b> or <b>OK</b>.</li> <li>5 Press the + button on the control panel or the OK button on the remote control to confirm the setting.</li> </ol>	Native 2.2 2.4 S gamma D-image Cancel OK

# ADJUSTING THE LCD DISPLAY

Item	Function	Operation	Range
Color temperature	Select a color temperature for the image. A lower color temperature will have a reddish tint, whilst a higher color temperature gives off a more bluish tint.	<ol style="list-style-type: none"> <li>1 Press the <b>+</b> button on the control panel or the <b>OK</b> button on the remote control to open the settings.</li> <li>2 Press the <b>▲/▼</b> button on the control panel or the <b>↕</b> button on the remote control to select the setting.</li> <li>3 Repeat step 1 to set the setting.</li> <li>4 Press the <b>↓</b> button and then the <b>←/→</b> button on the remote control to select <b>CANCEL</b> or <b>OK</b>.</li> <li>5 Press the <b>+</b> button on the control panel or the <b>OK</b> button on the remote control to confirm the setting.</li> </ol>	6500K 7500K 9300K 10000K Native User 1 User 2 OK Cancel
Color control	Adjust the color tones of the image precisely by changing the User-R (Red), User-G (Green) and User-B (Blue) settings independently.  <b>Note:</b> <ul style="list-style-type: none"> <li>• Color control option becomes available if you set the Color temperature to <b>User 1</b> or <b>User 2</b>.</li> </ul>	<ol style="list-style-type: none"> <li>1 Press the <b>▲/▼</b> button on the control panel or the <b>↕</b> button on the remote control to select the setting.</li> <li>2 Press the <b>+</b> button on the control panel or the <b>OK</b> button on the remote control to set the value.</li> <li>3 Press the <b>▲/▼</b> button on the control panel or the <b>←/→</b> button on the remote control to adjust the value.</li> </ol>	User-R (0-255) (User 1) User-G (0-255) (User 1) User-B (0-255) (User 1) 2000K - 10000K (User 2)

# ADJUSTING THE LCD DISPLAY

Item	Function	Operation	Range
Smart power	<p>Smart Power control is not relative to brightness control:</p> <ul style="list-style-type: none"> <li>• Initial setting Brightness               <ul style="list-style-type: none"> <li>» 70 (in the range from 0-100)</li> <li>» Power consumption 70% of maximum power consumption</li> </ul> </li> <li>• Smart Power               <ul style="list-style-type: none"> <li>» Off: No adaptation.</li> <li>» Medium: 80% of power consumption is relative to the current settings.</li> <li>» High: 65% of power consumption is relative to the current settings.</li> </ul> </li> </ul>	<ol style="list-style-type: none"> <li>1 Press the ▲/▼ button on the control panel or the M/  button on the remote control to select the setting.</li> <li>2 Press the + button on the control panel or the OK button on the remote control to set the value.</li> </ol>	<p>Off Medium High</p>
Overscan	<p>Change the display area of the image.</p> <ul style="list-style-type: none"> <li>• On: Display area is about 95%.</li> <li>• Off: Display area is about 100%.</li> </ul>	<ol style="list-style-type: none"> <li>1 Press the ▲/▼ button on the control panel or the M/  button on the remote control to select the setting.</li> <li>2 Press the + button on the control panel or the OK button on the remote control to set the value.</li> </ol>	<p>Off On</p>
Picture reset	<p>Reset all settings in the Picture menu to the factory preset values.</p>	<ol style="list-style-type: none"> <li>1 Press the ▲/▼ button on the control panel or the ←/→ button on the remote control to select the setting.</li> <li>2 Press the + button on the control panel or the OK button on the remote control to set the value.</li> </ol>	<p>CANCEL RESET</p>

# ADJUSTING THE LCD DISPLAY

## 6.2 Screen Settings

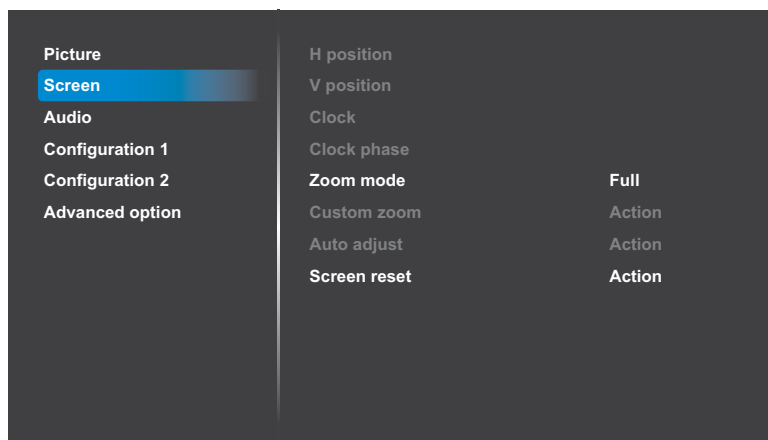

- 1 Press the **MENU** button on the control panel or the button on the remote control to call out the OSD window.
- 2 Press the button on the control panel or the button on the remote control to select **Screen**. Then press the button on the control panel or the **OK** button on the remote control.
- 3 Press the button on the control panel or the button on the remote control to select an option.
- 4 Press the button on the control panel or the **OK** button on the remote control to open the submenu item.

Item	Function	Operation	Range
H position	Move the image to the right or left. <b>Note:</b> • This option is available only if the input source is VGA.	Press the  button on the control panel or the  button on the remote control to adjust the value.	0 to 100
V position	Move the image up or down. <b>Note:</b> • This option is available only if the input source is VGA.		0 to 100
Clock	Adjust the width of the image. <b>Note:</b> • This option is available only if the input source is VGA.		0 to 100
Clock phase	Adjust to improve the focus, clarity and stability of the image. <b>Note:</b> • This option is available only if the input source is VGA.		0 to 100



# ADJUSTING THE LCD DISPLAY

Item	Function	Operation	Range
Zoom mode	<p>The pictures you receive may be transmitted in 16:9 format (wide screen) or 4:3 format (conventional screen). The 16:9 pictures sometimes have a black band at the top and bottom of the screen (letterbox format). Zoom mode will be deactivated when Anti-Burn-in™ is activated.</p> <p><b>Note:</b></p> <ul style="list-style-type: none"> <li>This option is not available in the following modes: Media Player, Browser, Cloud CMS, PDF Player, and Custom.</li> </ul>	<ol style="list-style-type: none"> <li>Press the <b>+</b> button on the control panel or the <b>OK</b> button on the remote control to open the settings.</li> <li>Press the <b>▲/▼</b> button on the control panel or the <b>↕</b> button on the remote control to select the setting.</li> <li>Repeat step 1 to set the setting.</li> <li>Press the <b>▼</b> button on the control panel or the <b>↓</b> button on the remote control. Then press the <b>▲/▼</b> button on the control panel or the <b>←/→</b> button on the remote control to select <b>CANCEL</b> or <b>OK</b>.</li> <li>Press the <b>+</b> button on the control panel or the <b>OK</b> button on the remote control to confirm the setting.</li> </ol>	<p>Full</p> <p>4:3</p> <p>Real</p> <p>21:9</p> <p>Custom</p> <p>Cancel</p> <p>OK</p>
Custom zoom	<p>Use this function to further customize the zoom settings to suit the image you want to display.</p> <p><b>Note:</b></p> <ul style="list-style-type: none"> <li>This option is not available in the following modes: Media Player, Browser, Cloud CMS, PDF Player, and Custom.</li> </ul>		
	Zoom: Expand the horizontal and vertical sizes of the image simultaneously.	<ol style="list-style-type: none"> <li>Press the <b>▲/▼</b> button on the control panel or the <b>↕</b> button on the remote control to select the setting.</li> <li>Press the <b>+</b> button on the control panel or the <b>OK</b> button on the remote control to enter value adjustment menu.</li> <li>Press the <b>▲/▼</b> button on the control panel or the <b>←/→</b> button on the remote control to adjust the value.</li> </ol>	<p>Zoom</p> <p>H Zoom</p> <p>V Zoom</p> <p>H position</p> <p>V position</p> <p>0 to 100</p>
	H Zoom: Expand the horizontal size of the image only.		
	V Zoom: Expand the vertical size of the image only.		
	H position: Move the horizontal position of the image left or right.		
V position: Move the vertical position of the image up or down.			

# ADJUSTING THE LCD DISPLAY

Item	Function	Operation	Range
Auto adjust	Use this function to automatically optimize the display of VGA input image. <b>Note:</b> • This option is available only if the input source is VGA.	<ol style="list-style-type: none"> <li>1 Press the ▲/▼ button on the control panel or the ←/→ button on the remote control to select the setting.</li> <li>2 Press the + button on the control panel or the OK button on the remote control to set the value.</li> </ol>	CANCEL OK
Screen reset	Reset all settings in the Screen menu to the factory preset values. • This option is not available in the following modes: Media Player, Browser, Cloud CMS, PDF Player, and Custom.	<ol style="list-style-type: none"> <li>1 Press the ▲/▼ button on the control panel or the ←/→ button on the remote control to select the setting.</li> <li>2 Press the + button on the control panel or the OK button on the remote control to set the value.</li> </ol>	CANCEL RESET



## 6.3 Audio Settings

Picture	Balance	50
Screen	Treble	50
<b>Audio</b>	Bass	50
Configuration 1	Volume	20
Configuration 2	Audio out(line out)	20
Advanced option	Maximum volume	100
	Minimum volume	0
	Mute	Off
	Audio source	Digital
	Audio reset	Action
	Audio Out Sync	Off

- 1 Press the **MENU** button on the control panel or the **↑** button on the remote control to call out the OSD window.
- 2 Press the ▲/▼ button on the control panel or the **↔** button on the remote control to select **Audio**. Then press the + button on the control panel or the OK button on the remote control.
- 3 Press the ▲/▼ button on the control panel or the **↔** button on the remote control to select an option.
- 4 Press the + button on the control panel or the OK button on the remote control to open the submenu item.

Item	Function	Operation	Range
Balance	Adjust to emphasize left or right audio output balance.	Press the ▲/▼ button on the control panel or the ←/→ button on the remote control to adjust the value.	0 to 100
Treble	Adjust to increase or decrease higher-pitched sounds.		0 to 100

# ADJUSTING THE LCD DISPLAY

Item	Function	Operation	Range
Bass	Adjust to increase or decrease lower-pitched sounds.	Press the ▲/▼ button on the control panel or the ←/→ button on the remote control to adjust the value.	0 to 100
Volume	Adjust to increase or decrease the audio output level.		0 to 100
Audio out (line out)	Adjust to increase or decrease line out output level.		0 to 100
Maximum volume	Adjust your own limitation for the maximum volume setting. This stops the volume from being playing at too loud.		0 to 100
Minimum volume	Adjust your own limitation for the minimum volume setting.		0 to 100
Mute	Turn the mute function on/off.	Press the <b>MUTE</b> button on the control panel or the  button on the remote control to set the value.	Off On
Audio source	Select the audio input source. There are no audio output when no video signal. <ul style="list-style-type: none"> <li>• Analog: Audio from audio input</li> <li>• Digital : Audio from HDMI audio.</li> </ul>	<ol style="list-style-type: none"> <li>1 Press the ▲/▼ button on the control panel or the  button on the remote control to select the setting.</li> <li>2 Press the + button on the control panel or the OK button on the remote control to set the value.</li> </ol>	Analog Digital
Audio reset	Reset all settings in the Audio menu to the factory preset values.	<ol style="list-style-type: none"> <li>1 Press the ▲/▼ button on the control panel or the ←/→ button on the remote control to select the setting.</li> <li>2 Press the + button on the control panel or the OK button on the remote control to set the value.</li> </ol>	CANCEL RESET
Audio Out Sync	Enable/disable audio out (line out) volume adjustability to sync with internal speakers.	<ol style="list-style-type: none"> <li>1 Press the ▲/▼ button on the control panel or the  button on the remote control to select the setting.</li> <li>2 Press the + button on the control panel or the OK button on the remote control to set the value.</li> </ol>	Off On

# ADJUSTING THE LCD DISPLAY

## 6.4 Configuration1 Settings

Picture	Switch on state	Force on
Screen	Panel saving	Action
Audio	RS232 routing	RS232
<b>Configuration 1</b>	Boot on source	Action
Configuration 2	WOL	Off
Advanced option	RGB Range	Full Range
	Configuration1 reset	Action
	Factory reset	Action

- 1 Press the **MENU** button on the control panel or the **⬆** button on the remote control to call out the OSD window.
- 2 Press the **▲▼** button on the control panel or the **↔** button on the remote control to select **Configuration 1**. Then press the **+** button on the control panel or the **OK** button on the remote control.
- 3 Press the **▲▼** button on the control panel or the **↔** button on the remote control to select an option.
- 4 Press the **+** button on the control panel or the **OK** button on the remote control to open the submenu item.

Item	Function	Operation	Range
Switch on state	<p>Select the display status used for the next time you connect the power cord.</p> <ul style="list-style-type: none"> <li>• Power off: The display will remain off when the power cord is connected to a wall outlet.</li> <li>• Force on: The display will turn on when the power cord is connected to a wall outlet.</li> <li>• Last status: The display will return to the previous power status (on/off/standby) when removing and replacing the power cord.</li> </ul>	<ol style="list-style-type: none"> <li>1 Press the <b>▲▼</b> button on the control panel or the <b>↔</b> button on the remote control to select the setting.</li> <li>2 Press the <b>+</b> button on the control panel or the <b>OK</b> button on the remote control to set the value.</li> </ol>	Power off Force on Last status

# ADJUSTING THE LCD DISPLAY

Item	Function	Operation	Range
Panel saving	Choose to enable the panel saving functions and thus reduce the risk of "image persistence" or "ghost-imaging".	<ol style="list-style-type: none"> <li>1 Press the ▲/▼ button on the control panel or the M button on the remote control to select the setting.</li> <li>2 Press the + button on the control panel or the OK button on the remote control to set the value.</li> </ol>	Brightness ANTI-BURN-IN
	Brightness: Set to <b>On</b> and the image brightness will be reduced to an appropriate level. The Brightness setting in the Picture menu will be unavailable when selected.		Off On
	Select the time interval for the display to slightly expand the image size and shift the position of pixels in four directions (up, down, left, or right). <b>Note:</b> <ul style="list-style-type: none"> <li>• Activating Anti-Burn-in™ will disable H Position, V Position and Zoom Mode in the Screen Menu.</li> </ul>	Press the ▲/▼ button on the control panel or the ←/→ button on the remote control to adjust the value.	Off Auto 10 to 900 Seconds
RS232-Routing	Select the network control port.	<ol style="list-style-type: none"> <li>1 Press the ▲/▼ button on the control panel or the M button on the remote control to select the setting.</li> <li>2 Press the + button on the control panel or the OK button on the remote control to set the value.</li> </ol>	RS232 LAN -> RS232 OPS RS232
Boot on source	Set the default source at boot up.		
	Last Input: Input source is the same as at last boot.	<ol style="list-style-type: none"> <li>1 Press the ▲/▼ button on the control panel or the ←/→ button on the remote control to select <b>Last Input</b> option.</li> <li>2 Press the + button on the control panel or the OK button on the remote control to set the value.</li> </ol>	CANCEL SAVE

# ADJUSTING THE LCD DISPLAY

Item	Function	Operation	Range
Boot on source	<p>Input: Input can be set to Media Player, Browser, Cloud CMS, PDF Player, Custom, DisplayPort, VGA, OPT, HDMI1, HDMI2, HDMI3 or HDMI4.</p>	<ol style="list-style-type: none"> <li>1 Press the <b>+</b> button on the control panel or the <b>OK</b> button on the remote control to uncheck the <b>Last Input</b> option.</li> <li>2 Press the <b>▲/▼</b> button on the control panel or the <b>↵</b> button on the remote control to select the <b>Input</b> option.</li> <li>3 Press the <b>+</b> button on the control panel or the <b>OK</b> button on the remote control to set the value.</li> </ol> <p><b>Note:</b> If you set the input to <b>Media Player, Browser, or PDF Player</b> then continue with setting the Playlist option in the following section (Playlist). If you set another input then follow steps 4 to 5.</p> <ol style="list-style-type: none"> <li>4 Press the <b>▼</b> button on the control panel or the <b>↓</b> button on the remote control. Then press the <b>▲/▼</b> button on the control panel or the <b>←/→</b> button on the remote control to select <b>CANCEL</b> or <b>OK</b>.</li> <li>5 Press the <b>+</b> button on the control panel or the <b>OK</b> button on the remote control to set the value.</li> </ol>	<p>HDMI1 HDMI2 HDMI3 HDMI4 DisplayPort VGA OPS Media Player Browser Cloud CMS PDF Player Custom</p>
	<p>Playlist: Select playlist index for Media Player, Browser, or PDF Player.</p>	<ol style="list-style-type: none"> <li>1 Repeat steps 1 to 3 in the previous (Input) section.</li> <li>2 Press the <b>▼</b> button on the control panel or the <b>↓</b> button on the remote control. Then press the <b>▲/▼</b> button on the control panel or the <b>↵</b> button on the remote control to select the playlist index.</li> <li>3 Press the <b>+</b> button on the control panel or the <b>OK</b> button on the remote control to set the value.</li> <li>4 Repeat steps 4 to 5 in the previous (Input) section.</li> </ol>	<p>0 to 7 CANCEL SAVE</p>







# ADJUSTING THE LCD DISPLAY



Item	Function	Operation	Range
WOL	Enable this feature to allow the display to be switched on over the network.	<ol style="list-style-type: none"> <li>1 Press the ▲/▼ button on the control panel or the M button on the remote control to select the setting.</li> <li>2 Press the + button on the control panel or the OK button on the remote control to set the value.</li> </ol>	Off On
RGB Range	Set the black level and white level for the RGB format.  <b>Note:</b> <ul style="list-style-type: none"> <li>• This option is not available in VGA mode.</li> </ul>		Auto Full Range Limited Range
Configuration1 reset	Reset all settings in the Configuration1 menu to the factory preset values.	<ol style="list-style-type: none"> <li>1 Press the ▲/▼ button on the control panel or the ←/→ button on the remote control to select the setting.</li> <li>2 Press the + button on the control panel or the OK button on the remote control to set the value.</li> </ol>	CANCEL RESET
Factory reset	Reset all your customized settings to the factory preset values, including Android settings.		CANCEL RESET

# ADJUSTING THE LCD DISPLAY

## 6.5 Configuration2 Settings

Picture	OSD turn off	45
Screen	OSD H position	50
Audio	OSD V position	50
Configuration 1	Information OSD	10
<b>Configuration 2</b>	Logo	On
Advanced option	Monitor ID	Action
	Heat status	25.88°C 78.59°F
	Monitor information	Action
	HDMI Version	1.4
	Configuration2 reset	Action

- 1 Press the **MENU** button on the control panel or the  button on the remote control to call out the OSD window.
- 2 Press the  button on the control panel or the  button on the remote control to select **Configuration 2**. Then press the  button on the control panel or the **OK** button on the remote control.
- 3 Press the  button on the control panel or the  button on the remote control to select an option.
- 4 Press the  button on the control panel or the **OK** button on the remote control to open the submenu item.

Item	Function	Operation	Range
OSD turn off	Set the period of time the OSD menu stays on the screen.	Press the  button on the control panel or the  button on the remote control to adjust the value.	Off 5 to 120
OSD H position	Set the OSD menu horizontal position on the screen.		50
OSD V position	Set the OSD menu vertical position on the screen.		50
Information OSD	Set the period of time the information OSD displayed on the upper left corner of the screen. The information OSD will appear on the screen when the input signal is changed. The information OSD will remain on the screen if the setting is set to <b>OFF</b> .		Off 1 to 60



# ADJUSTING THE LCD DISPLAY



Item	Function	Operation	Range
Logo	<p>Choose to enable or disable the picture of Logo when turn on your LCD display.</p> <p><b>Note:</b></p> <ul style="list-style-type: none"> <li>• If Logo is set to <b>On</b> then the OTS logo will show.</li> <li>• If Log is set to <b>Off</b> then the scalar OTS logo will not show.</li> <li>• If Logo is set to <b>User</b> then there will be no boot logo when power on.</li> <li>• Logo will not rotate with rotation setting/detection.</li> </ul>	<ol style="list-style-type: none"> <li>1 Press the ▲/▼ button on the control panel or the M button on the remote control to select the setting.</li> <li>2 Press the + button on the control panel or the OK button on the remote control to set the value.</li> </ol>	<p>Off</p> <p>On</p> <p>User</p>
Monitor ID	<p>Adjust the ID number for controlling the display via the RS232 connection. Each display must have a unique ID number when multiple sets of this display are connected.</p>	<ol style="list-style-type: none"> <li>1 Press the ▲/▼ button on the control panel or the M button on the remote control to select the setting.</li> <li>2 Press the + button on the control panel or the OK button on the remote control to set the value.</li> <li>3 Press the ▲/▼ button on the control panel or the ←/→ button on the remote control to adjust the value.</li> </ol>	<p>1~255</p>
Heat status	View the thermal status of the LCD display.		
Monitor information	View the information about your LCD display, including model name, serial number, operation hours, and software version.	N/A	
HDMI Version	<p>Set the HDMI version to 1.4 or 2.0.</p> <p><b>Note:</b></p> <ul style="list-style-type: none"> <li>• This option is available only if the input source is HDMI1 or HDMI2.</li> </ul>	<ol style="list-style-type: none"> <li>1 Press the ▲/▼ button on the control panel or the M button on the remote control to select the setting.</li> <li>2 Press the + button on the control panel or the OK button on the remote control to set the value.</li> </ol>	<p>1.4</p> <p>2.0</p>

# ADJUSTING THE LCD DISPLAY



Item	Function	Operation	Range
Configuration2 reset	Reset all settings in the Configuration2 menu to the factory preset values.	<ol style="list-style-type: none"> <li>1 Press the ▲/▼ button on the control panel or the ←/→ button on the remote control to select the setting.</li> <li>2 Press the + button on the control panel or the OK button on the remote control to set the value.</li> </ol>	<p>CANCEL</p> <p>RESET</p>

## 6.6 Advanced option Settings

Picture	IR control	Unlock
Screen	Power LED Light	On
Audio	Keyboard control	Unlock
Configuration 1	Off timer	Off
Configuration 2	Date and time	Action
<b>Advanced option</b>	Schedule	Action
	HDMI with One Wire	Off
	Language	English
	OSD transparency	Off
	Power Save	Mode 1
	OPS settings	Auto
	Advanced option reset	Action

- 1 Press the **MENU** button on the control panel or the  button on the remote control to call out the OSD window.
- 2 Press the ▲/▼ button on the control panel or the  button on the remote control to select **Advanced option**. Then press the + button on the control panel or the OK button on the remote control.
- 3 Press the ▲/▼ button on the control panel or the  button on the remote control to select an option.
- 4 Press the + button on the control panel or the OK button on the remote control to open the submenu item.

# ADJUSTING THE LCD DISPLAY

Item	Function	Operation	Range
IR control	<p>Select the operation mode of the remote control when multiple displays are connected via an RS232 connection.</p> <ul style="list-style-type: none"> <li>• Normal: All displays can be operated normally by the remote control unit.</li> <li>• Primary: Designate this display as the primary display for remote control operation. Only this display can be operated by the remote control. (In primary mode, IR key will always be processed regardless the monitor id/group settings).</li> <li>• Secondary: Designate this display as the secondary display. This display can not be operated by the remote control, and will only receive the control signal from the primary display via the RS232 connection.</li> <li>• Lock All / Lock all but Volume / Lock all but Power / Lock all except PWR &amp; VOL: Lock the remote control function of this display. To unlock, press and hold the  button on the remote control for 6 (six) seconds.</li> </ul>	<ol style="list-style-type: none"> <li>1 Press the ▲▼ button on the control panel or the  button on the remote control to select the setting.</li> <li>2 Press the + button on the control panel or the OK button on the remote control to set the value.</li> </ol>	<p>Unlock Lock All Lock All but Volume Lock All but Power Lock All except PWR &amp; VOL Primary Secondary</p>
Power LED light	Set the display LED indicator on or off.	<ol style="list-style-type: none"> <li>1 Press the ▲▼ button on the control panel or the  button on the remote control to select the setting.</li> <li>2 Press the + button on the control panel or the OK button on the remote control to set the value.</li> </ol>	<p>On Off</p>

# ADJUSTING THE LCD DISPLAY

Item	Function	Operation	Range
Keyboard control	<p>Enable or disable the keyboard (control panel buttons) function of the LCD display.</p> <ul style="list-style-type: none"> <li>• Unlock: Enable the keyboard function.</li> <li>• Lock All / Lock all but Volume / Lock all but Power / Lock all except PWR &amp; VOL: Disable all the keyboard function.</li> </ul> <p><b>Note:</b></p> <ul style="list-style-type: none"> <li>• To disable the keyboard control function, press both the <b>+</b> and <b>▲</b> on the control panel for more than 3 seconds.</li> </ul>	<ol style="list-style-type: none"> <li>1 Press the <b>▲/▼</b> button on the control panel or the <b>↵</b> button on the remote control to select the setting.</li> <li>2 Press the <b>+</b> button on the control panel or the <b>OK</b> button on the remote control to set the value.</li> </ol>	<p>Unlock</p> <p>Lock All</p> <p>Lock but Volume</p> <p>Lock All but Power</p> <p>Lock all except PWR &amp; VOL</p>
Off timer	Switch off the display after a given time.	Press the <b>▲/▼</b> button on the control panel or the <b>←/→</b> button on the remote control to adjust the value.	<p>Off</p> <p>1 to 24 Hours</p>
Date and time	Adjust the current date and time for the display's internal clock.		
	<p><b>Note:</b> The NTP Server is set automatically and cannot be altered.</p> <p>Auto Sync: Date and time are set automatically by the web server.</p>	<ol style="list-style-type: none"> <li>1 Press the <b>▲/▼</b> button on the control panel or the <b>←/→</b> button on the remote control to select <b>Auto Sync</b> option.</li> <li>2 Press the <b>+</b> button on the control panel or the <b>OK</b> button on the remote control to set the value.</li> </ol>	Auto Sync

# ADJUSTING THE LCD DISPLAY

Item	Function	Operation	Range
Date and time	Set date: Set date manually.	<ol style="list-style-type: none"> <li>1 Press the <b>+</b> button on the control panel or the <b>OK</b> button on the remote control to uncheck the <b>Auto Sync</b> option.</li> <li>2 Press the <b>▲/▼</b> button on the control panel or the <b>↕</b> button on the remote control to select the <b>Set date</b> option.</li> <li>3 Press the <b>+</b> button on the control panel or the <b>OK</b> button on the remote control to open the year field.</li> <li>4 Press the <b>▲/▼</b> button on the control panel or the <b>↕</b> button on the remote control to select the year.</li> <li>5 Press the <b>+</b> button on the control panel or the <b>OK</b> button on the remote control to set the value.</li> <li>6 Press the <b>▼</b> button on the control panel or the <b>➤</b> button on the remote control to select the month field.</li> <li>7 Repeat steps 4 to 5 to set the month.</li> <li>8 Repeat steps 6 to 7 to set the day.</li> <li>9 Press the <b>▼</b> button on the control panel or the <b>↓</b> button on the remote control. Then press the <b>▲/▼</b> button on the control panel or the <b>↔</b> button on the remote control to select <b>CANCEL</b> or <b>OK</b>.</li> </ol>	Set date
	Set time: Set time manually.	Repeat steps 1 to 9 in the previous section (Set date) to set time.	Set time

# ADJUSTING THE LCD DISPLAY

Item	Function	Operation	Range
Date and time	Choose time zone: Set the time zone in your area.	<ol style="list-style-type: none"> <li>1 Press the ▲/▼ button on the control panel or the M button on the remote control to select the <b>Choose time zone</b> field.</li> <li>2 Press the + button on the control panel or the OK button on the remote control to set the value.</li> <li>3 Press the ▲/▼ button on the control panel or the M button on the remote control to select the time zone.</li> <li>4 Press the + button on the control panel or the OK button on the remote control to set the time zone.</li> </ol>	Choose time zone
Schedule	<p>This function allows you to program up to 7 different scheduled time intervals for this display to activate.</p> <p>You can set:</p> <ul style="list-style-type: none"> <li>• Which input source the display will use for each scheduled activation period.</li> <li>• The time for the display to turn on and turn off.</li> <li>• The days in a week for the display to activate.</li> </ul> <p><b>Note:</b></p> <ul style="list-style-type: none"> <li>• We recommend you to set up current date and time in the Date and time menu before using this function.</li> <li>• After changing the Date and time option in the Advanced option menu, you need to set this Schedule again.</li> </ul>		
	After all the schedule parameters are set, you need to save the schedule.	Press the ▼ button on the control panel or the ↓ button on the remote control to access the <b>BACK</b> or <b>SAVE</b> option. Then press the ▲/▼ button on the control panel or the ←/→ button on the remote control to select <b>BACK</b> or <b>SAVE</b> .	BACK SAVE

# ADJUSTING THE LCD DISPLAY

Item	Function	Operation	Range
Schedule	Schedule list: Select the schedule from the list that you want to configure.	<ol style="list-style-type: none"> <li>1 Press the <b>+</b> button on the control panel or the <b>OK</b> button on the remote control twice to access the <b>Schedule list</b> option.</li> <li>2 Press the <b>▲/▼</b> button on the control panel or the <b>↕</b> button on the remote control to select the schedule list from <b>Schedule 1</b> to <b>Schedule 7</b>.</li> <li>3 Press the <b>+</b> button on the control panel or the <b>OK</b> button on the remote control to set the schedule list.</li> <li>4 Press the <b>▼</b> button on the control panel or the <b>↓</b> button on the remote control. Then press the <b>▲/▼</b> button on the control panel or the <b>←/→</b> button on the remote control to select <b>CANCEL</b> or <b>OK</b>.</li> </ol>	Schedule list 1 Schedule list 2 Schedule list 3 Schedule list 4 Schedule list 5 Schedule list 6 Schedule list 7 CANCEL OK
	Enable: Enable or disable the schedule.	<ol style="list-style-type: none"> <li>1 Press the <b>▲/▼</b> button on the control panel or the <b>↕</b> button on the remote control to select the setting.</li> <li>2 Press the <b>+</b> button on the control panel or the <b>OK</b> button on the remote control to set the setting.</li> <li>3 Press the <b>▲/▼</b> button on the control panel or the <b>↕</b> button on the remote control to select the option.</li> <li>4 Press the <b>+</b> button on the control panel or the <b>OK</b> button on the remote control to set the option.</li> </ol>	Off On

# ADJUSTING THE LCD DISPLAY

Item	Function	Operation	Range
Schedule	Start time: Set time when the schedule is turned on.	<ol style="list-style-type: none"> <li>1 Press the ▲/▼ button on the control panel or the M button on the remote control to select the <b>Start time</b> option.</li> <li>2 Press the + button on the control panel or the OK button on the remote control to open the start time field.</li> <li>3 Press the ▲/▼ button on the control panel or the M button on the remote control to select the hours.</li> <li>4 Press the + button on the control panel or the OK button on the remote control to set the hours.</li> <li>5 Press the ▼ button on the control panel or the ↓ button on the remote control. Then press the ▲/▼ button on the control panel or the ←/→ button on the remote control to select <b>CANCEL</b> or <b>OK</b>.</li> <li>6 Press the ▼ button on the control panel or the ▸ button on the remote control to select the minutes field and repeat steps 2 to 5 to set the minutes.</li> </ol>	Start time
	End time: Set time when the schedule is turned off.	Repeat steps 1 to 6 in the previous section (Start time) to set end time.	End time



# ADJUSTING THE LCD DISPLAY

Item	Function	Operation	Range
Schedule	Input: Set the input source.	<ol style="list-style-type: none"> <li>1 Press the ▲/▼ button on the control panel or the M button on the remote control to select the <b>Input</b> option.</li> <li>2 Press the + button on the control panel or the OK button on the remote control twice to open the input field.</li> <li>3 Press the ▲/▼ button on the control panel or the M button on the remote control to select the input source.</li> <li>4 Press the + button on the control panel or the OK button on the remote control to set the input source.</li> <li>5 Press the ▼ button on the control panel or the ↓ button on the remote control. Then press the ▲/▼ button on the control panel or the ←/→ button on the remote control to select <b>CANCEL</b> or <b>OK</b>.</li> </ol>	HDMI1 HDMI2 HDMI3 HDMI4 DisplayPort VGA OPS Media Player Browser Cloud CMS PDF Player Custom
	Playlist: If you set the input to <b>Media Player, Browser, or PDF Player</b> then you can set the playlist option.	Repeat steps 1 to 5 in the previous section (Input) to set the playlist option from 1 to 7.	CANCEL OK

# ADJUSTING THE LCD DISPLAY

Item	Function	Operation	Range
Schedule	Days of the week: Select the days of the week when the schedule is active.	<ol style="list-style-type: none"> <li>1 Press the ▲/▼ button on the control panel or the M button on the remote control to select the <b>Days of the week</b> option.</li> <li>2 Press the + button on the control panel or the OK button on the remote control twice to open the days of the week field.</li> <li>3 Press the ▲/▼ button on the control panel or the M button on the remote control to select the day.</li> <li>4 Press the + button on the control panel or the OK button on the remote control to set the day. Repeat steps 3 to 4 to set more days.</li> <li>5 Press the ▼ button on the control panel or the ↓ button on the remote control repeatedly to access the <b>SAVE</b> option. Then press the + button on the control panel or the OK button on the remote control to save the settings.</li> </ol>	SUN MON TUE WED THU FRI SAT SAVE
	Every week: Check this option to run the schedule every week.	<ol style="list-style-type: none"> <li>1 Press the ▲/▼ button on the control panel or the M button on the remote control to select the <b>Every week</b> option.</li> <li>2 Press the + button on the control panel or the OK button on the remote control to set the value.</li> </ol>	Every week
HDMI with One Wire	CEC control. <ul style="list-style-type: none"> <li>• Off: Disable CEC.</li> <li>• On: Enable CEC.</li> </ul>	<ol style="list-style-type: none"> <li>1 Press the ▲/▼ button on the control panel or the M button on the remote control to select the setting.</li> <li>2 Press the + button on the control panel or the OK button on the remote control to set the value.</li> </ol>	Off On

# ADJUSTING THE LCD DISPLAY

Item	Function	Operation	Range
Language	Set the OSD language.	<ol style="list-style-type: none"> <li>1 Press the <b>+</b> button on the control panel or the <b>OK</b> button on the remote control to select the value.</li> <li>2 Press the <b>▲/▼</b> button on the control panel or the <b>M</b> button on the remote control to select the setting.</li> <li>3 Press the <b>+</b> button on the control panel or the <b>OK</b> button on the remote control to set the setting.</li> <li>4 Press the <b>▼</b> button on the control panel or the <b>↓</b> button on the remote control. Then press the <b>▲/▼</b> button on the control panel or the <b>←/→</b> button on the remote control to select <b>CANCEL</b> or <b>OK</b>.</li> </ol>	English Deutsch 简体中文 Français Italiano Español Русский Polski Türkçe 繁體中文 日本語 Português العربية Danish Swedish Finnish Norwegian Dutch CANCEL OK
OSD Transparency	Adjust OSD transparency. <ul style="list-style-type: none"> <li>• Off: Transparency is off.</li> <li>• 5-100: Transparency level is 5-100.</li> </ul>	Press the <b>▲/▼</b> button on the control panel or the <b>←/→</b> button on the remote control to adjust the value.	Off 5 to 100

# ADJUSTING THE LCD DISPLAY

Item	Function	Operation	Range	
Power Save	Mode 1	If the LCD display cannot detect any input source signal, the "No Signal" message will appear on the screen, and the display will automatically turn off after 60 seconds. At this time, even if an input source is connected, the screen will be unable to be awakened.	<ol style="list-style-type: none"> <li>1 Press the ▲/▼ button on the control panel or the M button on the remote control to select the setting.</li> <li>2 Press the + button on the control panel or the OK button on the remote control to set the value.</li> </ol>	Mode 1 Mode 2 Mode 3 Mode 4
	Mode 2	Not supported		
	Mode 3	If the LCD display cannot detect any input source signal, the "No Signal" message will appear on the screen, and the display will automatically enter standby mode after 60 seconds. At this time, if an input source is connected, the screen can be awakened.		
	Mode 4	If the LCD display cannot detect any input source signal, the "No Signal" message will appear on the screen, and the display will not automatically turn off or enter standby mode.		
OPS settings	Set the OPS settings.		Auto Always off Always on	
Advanced option reset	Reset all settings except Date and Time in the Advanced option menu to factory preset values.	<ol style="list-style-type: none"> <li>1 Press the ▲/▼ button on the control panel or the ←/→ button on the remote control to select the setting.</li> <li>2 Press the + button on the control panel or the OK button on the remote control to set the value.</li> </ol>	CANCEL RESET	

# CHAPTER 7: APPENDIX

## 7.1 Warning Messages

Warning Messages	Cause	Solution
No Picture	The resolution or the refresh rate of the graphics card of the computer is set too high.	<ul style="list-style-type: none"> <li>Change the resolution or the refresh rate of the graphics card.</li> </ul>
No Picture	The LCD display cannot detect the input source signal.	<ul style="list-style-type: none"> <li>Check if the input source is turned ON.</li> <li>Check if the signal cable is properly connected.</li> <li>Check if any pin inside the cable connector is twisted or broken.</li> </ul>
keyboard(Key button) no function	The operation using the control panel buttons has been locked by the user.	<ul style="list-style-type: none"> <li>Disable the keyboard lock function in <b>Advanced option</b> &gt; <b>Keyboard control</b> menu. See page 80.</li> </ul>
Remote control no function	The operation using the remote control buttons has been locked by the user.	<ul style="list-style-type: none"> <li>Disable the remote control lock function in <b>Advanced option</b> &gt; <b>IR control</b> menu. See page 79.</li> </ul>

## 7.2 Supported Media Formats

### USB Multimedia Codec Formats

Video Decode				
Type	Video Codec	Container	Decode	Remark
MPEG1/2	MPEG1/2	MPEG program stream (.DAT, .VOB, .MPG, .MPEG)	V	Max Resolution: 1080P@60fps Max Bit Rates: 40Mbps
		MPEG transport stream (.ts, .trp <sup>2</sup> , .tp <sup>1,2</sup> )		
		MP4 (.mp4, .mov <sup>2</sup> )		
		3GPP <sup>1,2</sup> (.3gpp, .3gp)		
		AVI (.avi)		
	MKV (.mkv)			
MPEG-4	MPEG4	MP4 (.mp4, .mov <sup>2</sup> )	V	Max Resolution: 1080P@60fps Max Bit Rates: 40Mbps
		3GPP <sup>1,2</sup> (.3gpp, .3gp)		
		AVI (.avi)		
		MKV (.mkv)		
H.263	H.263	FLV (.flv)	V	Max Resolution: 1080P@60fps Max Bit Rates: 40Mbps
		AVI (.avi)		

# APPENDIX

Video Decode					
Type	Video Codec	Container	Decode	Remark	
H.264	H.264	FLV (.flv)	V	Max Resolution: 1080P@60fps Max Bit Rates: 135Mbps 4k2k@30fps	
		MP4 (.mp4, .mov <sup>2</sup> )			
		3GPP <sup>1:2</sup> (.3gpp, .3gp)			
		MPEG transport stream (.ts, .trp <sup>2</sup> , .tp <sup>1:2</sup> )			
		ASF (.asf)			
		WMV (.wmv)			
		AVI (.avi)			
	MKV (.mkv)				
H.265	H.265	MP4 (.mp4, .mov <sup>2</sup> )	V	Max Resolution: 4K2K@60fps Max Bit Rates: 100Mbps	
		3GPP <sup>1:2</sup> (.3gpp, .3gp)			
		MPEG transport stream (.ts, .trp <sup>2</sup> , .tp <sup>1:2</sup> )			
		MKV (.mkv)			
GOOGLE VP8	VP8	MKV (.mkv)	V	Max Resolution: 1080P@30fps Max Bit Rates: 20Mbps	
		WebM (.webm)			
Motion JPEG	MJPEG	AVI (.avi)		Max Resolution: 1920*1080 @30fps Max Bit Rates: 40Mbps	
		3GPP <sup>1:2</sup> (.3gpp, .3gp)			
		MP4 (.mp4, .mov <sup>2</sup> )			
		MKV <sup>2</sup> (.mkv)			

## Note:

- ◆ 1: Not supported in NSD-6501Q model.
- ◆ 2: Not supported in NSD-8601Q model.

Audio Decode					
Type	Audio Codec	Container	Decode	Channel	Remark
MPEG Audio	MPEG1/2/2.5	MP3	V	2	Bit Rate: 8kbps~320Kbps Sampling Rate: 16KHZ~48KHZ
	Audio Layer1/2/3				
Windows Media Audio	WMA Version 7, 8, 9,10 pro M0, 10 Pro M1, M10 Pro M2	Decode: WMA	V	2	Bit Rate: 8kbps~768Kbps Sampling Rate: 8KHZ~96(M10) KHz Non-support LBR
AAC Audio	MAIN, ADIF, ATDS Header AAC-LC and AAC-HE	File Format: AAC, M4A	V	5.1	Bit Rate: N/A Sampling Rate: 8KHZ~48KHZ

# APPENDIX

Image Decode				
Type	Image Codec	Container	Decode	Remark
JPEG	JFIF file format 1.02	File Format: JPG, JPEG	V	Max Resolution: 7000 x 7000 The limitation of max resolution depends on DRAM
BMP	BMP	File Format: BMP	V	Max Resolution: 15360 x 8640 The limitation of max resolution depends on DRAM
PNG	PNG	File Format: PNG	V	Max Resolution: 15360 x 8640 The limitation of max resolution depends on DRAM

## Note:

- ◆ Sound or video may not work if the contents have a standard bit rate/frame rate above the compatible Frame/sec listed in the table above.
- ◆ Video content with a Bit rate or Frame rate larger than the rate specified in the table above can cause choppy video during playback.

## 7.3 Input Mode

### VGA Resolution

Standard Resolution	Active Resolution		Refresh Rate	Pixel Rate	Aspect Ratio	Stand for Mode
	Horizontal Pixels	Vertical Lines				
VGA	640	480	60 Hz	25.175 MHz	4:3	Video Graphic Array
			72 Hz	31.5 MHz		
			75 Hz	31.5 MHz		
WVGA	720	400	70 Hz	33.75 MHz	16:9	Wide Video Graphic Array
SVGA	800	600	60 Hz	40 MHz	4:3	Super VGA
			75 Hz	49.5 MHz		
XGA	1024	768	60 Hz	65 MHz	4:3	Extended Graphic Array
			75 Hz	78.75 MHz		
WXGA	1280	768	60 Hz	79.5 MHz	5:3	Wide XGA
WXGA	1280	800	60 Hz	79.5 MHz	16:10	Wide XGA
SXGA	1280	1024	60 Hz	108 MHz	5:4	Super XGA
WXGA	1360	768	60 Hz	85.5 MHz	16:9	Wide XGA
UXGA <sup>1</sup>	1600	1200	60 Hz	162 MHz	4:3	Ultra XGA
HD1080	1920	1080	60 Hz	148.5 MHz	16:9	HD1080

## Note:

- ◆ 1280x768@60Hz can be supported but not shown in EDID table.
- ◆ 1: Not supported in NSD-6501Q model.

# APPENDIX

## SD Resolution

Standard Resolution	Active Resolution		Refresh Rate	Pixel Rate	Aspect Ratio
	Horizontal Pixels	Vertical Lines			
480i	720	480	29.97 Hz	13.5 MHz	4:3
480p			59.94 Hz	27 MHz	
576i	720	576	25 Hz	13.5 MHz	4:3
576p			50 Hz	27 MHz	

## HDTV Resolution

Standard Resolution	Active Resolution		Refresh Rate	Pixel Rate	Aspect Ratio
	Horizontal Pixels	Vertical Lines			
720p	1280	720	50 Hz	74.25 MHz	16:9
			60 Hz		
1080i	1920	1080	25 Hz	74.25 MHz	16:9
			30 Hz		
1080p	1920	1080	50 Hz	148.5 MHz	16:9
			60 Hz		
2160p (DP/OPS)	3840	2160	30 Hz	297 MHz	16:9
2160p (HDMI only)	3840	2160	30 Hz	297 MHz	
			50 Hz	594 MHz	
			60 Hz		

### General guidelines:

- The PC text quality is optimum in HD 1080 mode (1920 x 1080, 60Hz).
- Your PC display screen might appear different depending on the manufacturer (and your particular version of Windows).
- Check your PC instruction book for information about connecting your PC to a display.
- If a vertical and horizontal frequency-select mode exists, select 60Hz (vertical) and 31.5KHz (horizontal). In some cases, abnormal signals (such as stripes) might appear on the screen when the PC power is turned off (or if the PC is disconnected). If so, press the **INPUT** button to enter the video mode. Also, make sure that the PC is connected.
- When horizontal synchronous signals seem irregular in RGB mode, check PC standby mode or cable connections.
- The display settings table complies to the IBM/VESA standards, and based on the analog input.



# APPENDIX

- The best timing for the vertical frequency to each mode is 60Hz.

## 7.4 Cleaning

### Caution When Using the Display

- Do not bring your hands, face or objects close to the ventilation holes of the display. The top of the display is usually very hot due to the high temperature of exhaust air being released through the ventilation holes. Burns or personal injuries may occur if any body parts are brought too close. Placing any object near the top of the display could also result in heat related damage to the object as well as the display itself.
- Be sure to disconnect all cables before moving the display. Moving the display with its cables attached may damage the cables and thus cause fire or electric shock.
- Disconnect the power plug from the wall outlet as a safety precaution before carrying out any type of cleaning or maintenance procedure.

### Front Panel Cleaning Instructions



- The front of the display has been specially treated. Wipe the surface gently using only a cleaning cloth or a soft, lint-free cloth.
- If the surface becomes dirty, soak a soft, lint-free cloth in a mild detergent solution. Wring the cloth to remove excess liquid. Wipe the surface of the display to remove dirt. Then use a dry cloth of the same type to dry.
- Do not scratch or hit the surface of the panel with fingers or hard objects of any kind.
- Do not use volatile substances such as insect sprays, solvents and thinners.

### Cabinet Cleaning Instructions

- If the cabinet becomes dirty, wipe the cabinet with a soft, dry cloth.
- If the cabinet is extremely dirty, soak a lint-free cloth in a mild detergent solution. Wring the cloth to remove as much moisture as possible. Wipe the cabinet. Use another dry cloth to wipe over until the surface is dry.
- Do not allow any water or detergent to come into contact with the surface of the display. If water or moisture gets inside the unit, operating problems, electrical and shock hazards may result.
- Do not scratch or hit the cabinet with fingers or hard objects of any kind.
- Do not use volatile substances such as insect sprays, solvents and thinners on the cabinet.
- Do not place anything made from rubber or PVC near the cabinet for any extended periods of time.

# APPENDIX

## 7.5 Troubleshooting

Symptom	Possible Cause	Remedy
No picture is displayed	<ul style="list-style-type: none"> <li>The power cord has been disconnected.</li> <li>The main power switch on the back of the display is not switched on.</li> <li>The selected input has no connection.</li> <li>The display is in standby mode.</li> </ul>	<ol style="list-style-type: none"> <li>1 Plug in the power cord.</li> <li>2 Make sure the power switch is switched on.</li> <li>3 Connect a signal connection to the display.</li> </ol>
Interference displayed on the display or audible noise is heard	Caused by surrounding electrical appliances or fluorescent lights.	Move the display to another location to see if the interference is reduced.
Colour is abnormal	The signal cable is not connected properly.	Make sure that the signal cable is attached firmly to the back of the display.
Picture is distorted with abnormal patterns	<ul style="list-style-type: none"> <li>The signal cable is not connected properly.</li> <li>The input signal is beyond the capabilities of the display.</li> </ul>	<ul style="list-style-type: none"> <li>Make sure that the signal cable is attached firmly.</li> <li>Check the video signal source to see if it is beyond the range of the display. Please verify its specifications with this display's specification section.</li> </ul>
Display image doesn't fill up the full size of the screen	The picture format is not set correctly.	Press the  button and select a suitable picture format.
Can hear sound, but no picture	Improperly connected source signal cable.	Make sure that both video inputs and sound inputs are correctly connected.
Can see picture but no sound is heard	<ul style="list-style-type: none"> <li>Improperly connected source signal cable.</li> <li>Volume is turned all the way down.</li> <li><b>MUTE</b> function is turned on.</li> <li>No external speaker connected.</li> </ul>	<ul style="list-style-type: none"> <li>Make sure that both video and sound inputs are correctly connected.</li> <li>Press the <b>+</b> or <b>-</b> button to hear the sound.</li> <li>Switch the <b>MUTE</b> function off by using the  button.</li> <li>Connect the external speakers and adjust the volume to a suitable level.</li> </ul>
Some picture elements do not light up	Some pixels of the display may not turn on.	This display is manufactured using an extremely high level of precision technology: however, sometimes some pixels of the display may not display. This is not a malfunction.
After-Images can still be seen on the display after the display is powered off. (Examples of still pictures include logos, video games, computer images, and images displayed in 4:3 normal mode)	A still picture is displayed for an over extended period of time.	Do not allow a still image to be displayed for an extended period of time as this can cause a permanent after-image to remain on the display.

# APPENDIX

## 7.6 Transporting the LCD Display

To transport the LCD display for repair or shipment, place the display in its original packaging carton.

### NSD-6501Q

- 1 Place the LCD display inside the supplied protective bag.
- 2 Place the lower foam cushion inside the lower box (a).
- 3 Place the LCD display down in the lower box (b).
- 4 Place the upper foam cushion on top of the LCD display (c).
- 5 Place the accessories box on the designated area (if necessary).
- 6 Place the upper box on LCD display.
- 7 Secure the upper box to the lower box with the supplied locks (d).

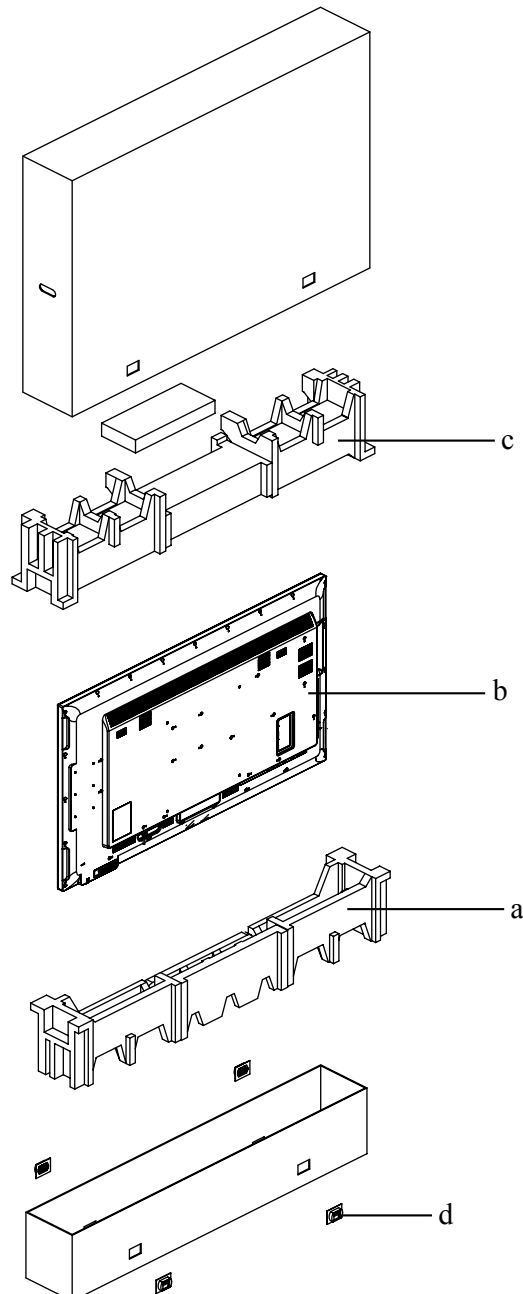

# APPENDIX

## NSD-7501Q

- 1 Place the LCD display inside the supplied protective bag.
- 2 Place the lower foam cushion inside the lower box (a).
- 3 Place the LCD display down in the lower box (b).
- 4 Place the upper foam cushion on top of the LCD display (c).
- 5 Place the accessories box on the designated area (if necessary).
- 6 Place the upper box on LCD display.
- 7 Secure the upper box to the lower box with the supplied locks (d).

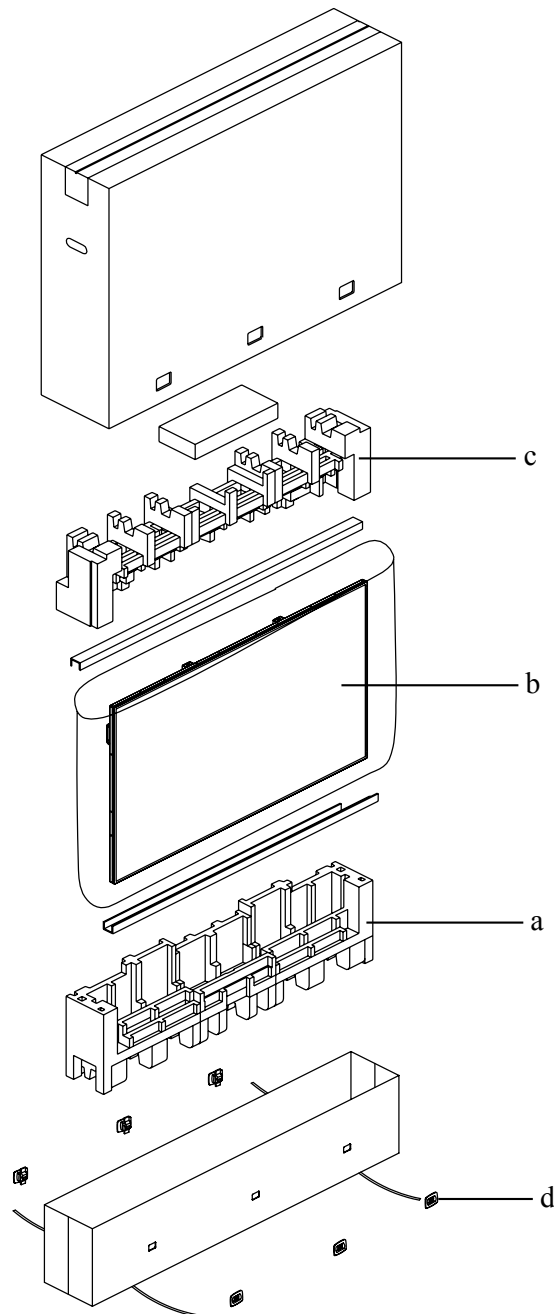

# APPENDIX

## NSD-8601Q

- 1 Place the LCD display inside the supplied protective bag.
- 2 Place the lower foam cushions inside the lower box (a).
- 3 Place the LCD display down in the lower box (b). Then place the thin foam cushion in front of the screen.
- 4 Place the upper foam cushions on top of the LCD display (c).
- 5 Place the accessories box on the designated area (if necessary).
- 6 Place the upper box on LCD display.
- 7 Secure the upper box to the lower box with the supplied locks (d).

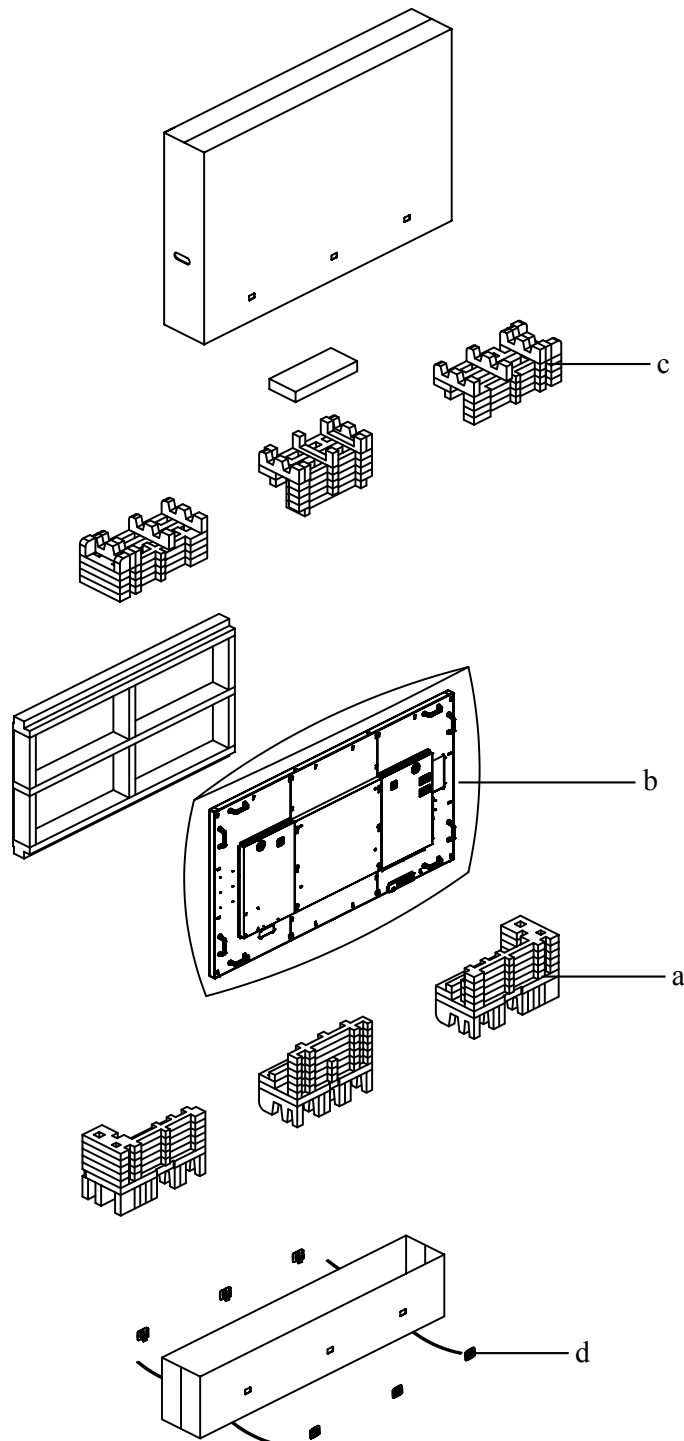

# CHAPTER 8: SPECIFICATIONS

## 8.1 Display Specifications

		NSD-6501Q	NSD-7501Q	NSD-8601Q
Panel	Panel Type	LED-Backlit TFT LCD (VA Technology)	LED-Backlit TFT LCD (IPS Technology)	LED-Backlit TFT LCD (IPS Technology)
	Panel Size	64.5"	74.5"	85.6"
	Max. Resolution	UHD 3840 x 2160	UHD 3840 x 2160	UHD 3840 x 2160
	Pixel Pitch	0.372 mm	0.429 mm	0.494 mm
	Brightness	350 cd/m <sup>2</sup>	410 cd/m <sup>2</sup>	410 cd/m <sup>2</sup>
	Contrast Ratio	4000:1	1200:1	1200:1
	Viewing Angle (H/V)	178°/178°	178°/178°	178°/178°
	Display Colour	1.07B	1.07B	1.07B
	Response Time	5 ms	5 ms	5 ms
	Surface Treatment	Anti-Glare Treatment (Haze 2%), 3H Hard Coating	Anti-Glare Treatment (Haze 2%), 2H Hard Coating	Anti-Glare Treatment (Haze 3%), 2H Hard Coating
	Frequency (H/V)	H Freq.	31 kHz-92 kHz	31 kHz-92 kHz
V Freq.		48 Hz-85 Hz	48 Hz-85 Hz	48 Hz-85 Hz
Input	DisplayPort	x 1	x 1	x 1
	HDMI	2.0 x 4	2.0 x 4	2.0 x 4
	VGA	15-Pin D-Sub	15-Pin D-Sub	15-Pin D-Sub
External Control	IR in/out	3.5 mm Phone Jack	3.5 mm Phone Jack	3.5 mm Phone Jack
	RS232 in/out	2.5 mm Phone Jack	2.5 mm Phone Jack	2.5 mm Phone Jack
	LAN	RJ45 x 1	RJ45 x 1	RJ45 x 1
Embedded Player	OS	Android 5.0.1	Android 5.0.1	Android 5.0.1
	CPU	1 Ghz Quad Core Full HD	1 Ghz Quad Core Full HD	1 Ghz Quad Core Full HD
	Memory	2 GB DDR3	2 GB DDR3	2 GB DDR3
	Storage	8 GB eMMC	8 GB eMMC	8 GB eMMC
Other Connectivity	USB	2.0 x 1 (Service Port / Media Playback) 2.0 x 1 (Media Playback) 3.0 x 1 (Media Playback) USB power outlet x 1 (5V2A)	2.0 x 1 (Service Port / Media Playback) 2.0 x 1 (Media Playback) 3.0 x 1 (Media Playback) USB power outlet x 1 (5V2A)	2.0 x 1 (Service Port / Media Playback) 2.0 x 1 (Media Playback) 3.0 x 1 (Media Playback) USB power outlet x 1 (5V2A)
	OPS Slot	Yes	Yes	Yes
	Micro SD Card Slot	Yes	Yes	Yes
Audio	Audio In	Stereo Audio Jack (3.5 mm) x 1	Stereo Audio Jack (3.5 mm) x 1	Stereo Audio Jack (3.5 mm) x 1
	Audio Out	Stereo Audio Jack (RCA) x 1	Stereo Audio Jack (RCA) x 1	Stereo Audio Jack (RCA) x 1
	Internal Speaker	10W x 2	10W x 2	10W x 2
Power	Power Supply	Internal	Internal	Internal
	Power Requirements	AC 100-240V, 50/60 Hz	AC 100-240V, 50/60 Hz	AC 100-240V, 50/60 Hz
	On Mode	185W (On)	233W (On)	295W (On)
	Standby Mode	< 0.5W	< 0.5W	< 0.5W
	Off Mode	< 0.3W	< 0.3W	< 0.3W
Operating Conditions	Temperature	0°C-40°C (32°F-104°F)	0°C-40°C (32°F-104°F)	0°C-40°C (32°F-104°F)
	Humidity	20%-80% (non-condensing)	20%-80% (non-condensing)	20%-80% (non-condensing)
Storage Conditions	Temperature	-20°C-60°C (-4°F-140°F)	-20°C-60°C (-4°F-140°F)	-20°C-60°C (-4°F-140°F)
	Humidity	10%-90% (non-condensing)	10%-90% (non-condensing)	10%-90% (non-condensing)
Mounting	VESA FPMPMI	Yes (400 x 400 mm)	Yes (600 x 400 mm)	Yes (600 x 400 mm)
Security	Kensington Security Slot	Yes	-	-

# SPECIFICATIONS

		NSD-6501Q	NSD-7501Q	NSD-8601Q
Dimensions	Product w/o Base (W x H x D)	1458.7 x 834.7 x 81.6 mm (57.4" x 32.9" x 3.2")	1676.6 x 955.0 x 73.8 mm (66.0" x 37.6" x 2.9")	1927.9 x 1098.9 x 85.9 mm (75.9" x 43.3" x 3.4")
	Packaging (W x H x D)	1655.0 x 1078.0 x 280.0 mm (65.2" x 42.4" x 8.2")	1832.0 x 1283.0 x 280.0 mm (72.1" x 50.5" x 8.2")	2224.0 x 1427.0 x 373.0 mm (87.6" x 56.2" x 14.7")
Weight	Product w/o Base	24.8 kg (54.7 lb)	53.0 kg (116.8 lb)	63.8 kg (140.7 lb)
	Packaging	35.2 kg (77.6 lb)	65.5 kg (144.4 lb)	93.0 kg (205.0 lb)

**Note:**

- ◆ All specifications are subject to change without prior notice.

# SPECIFICATIONS

## 8.2 Display Dimensions

### NSD-6501Q

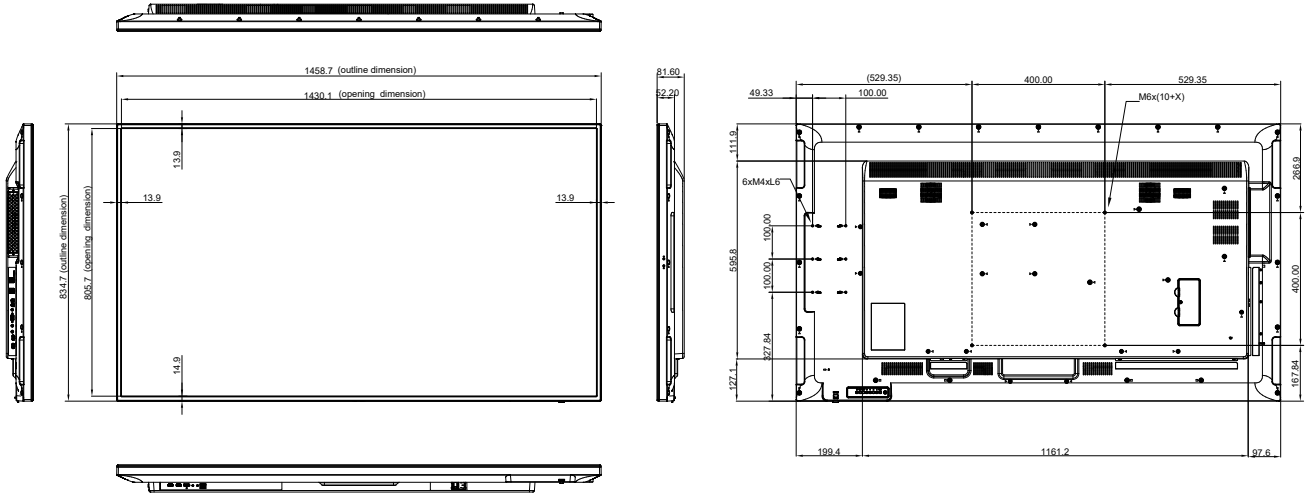

### NSD-7501Q

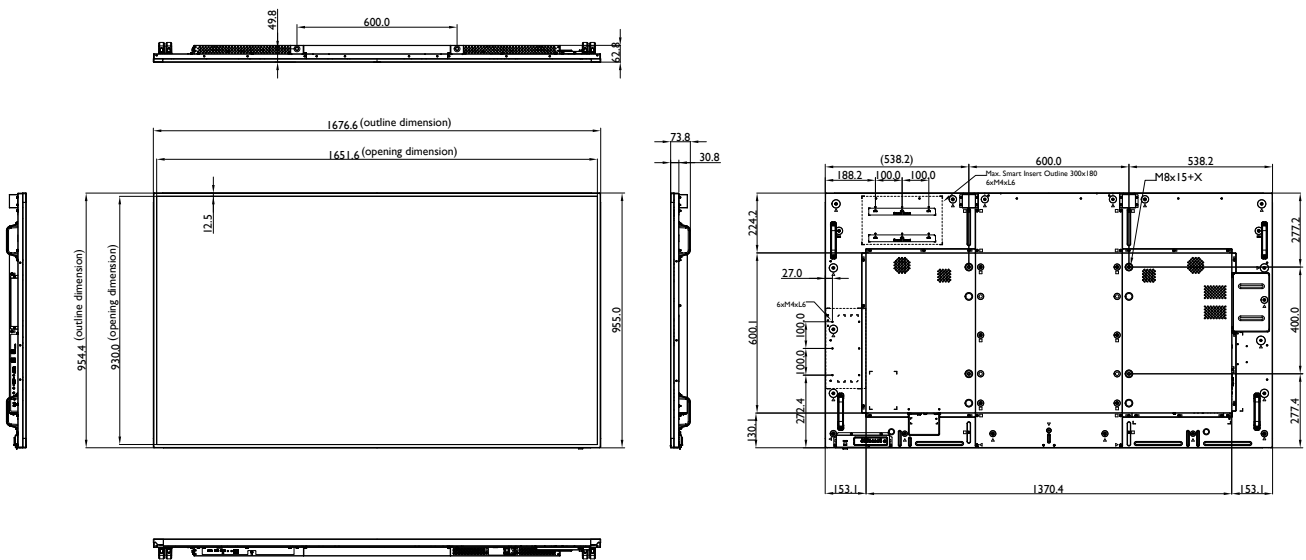



# SPECIFICATIONS

## NSD-8601Q

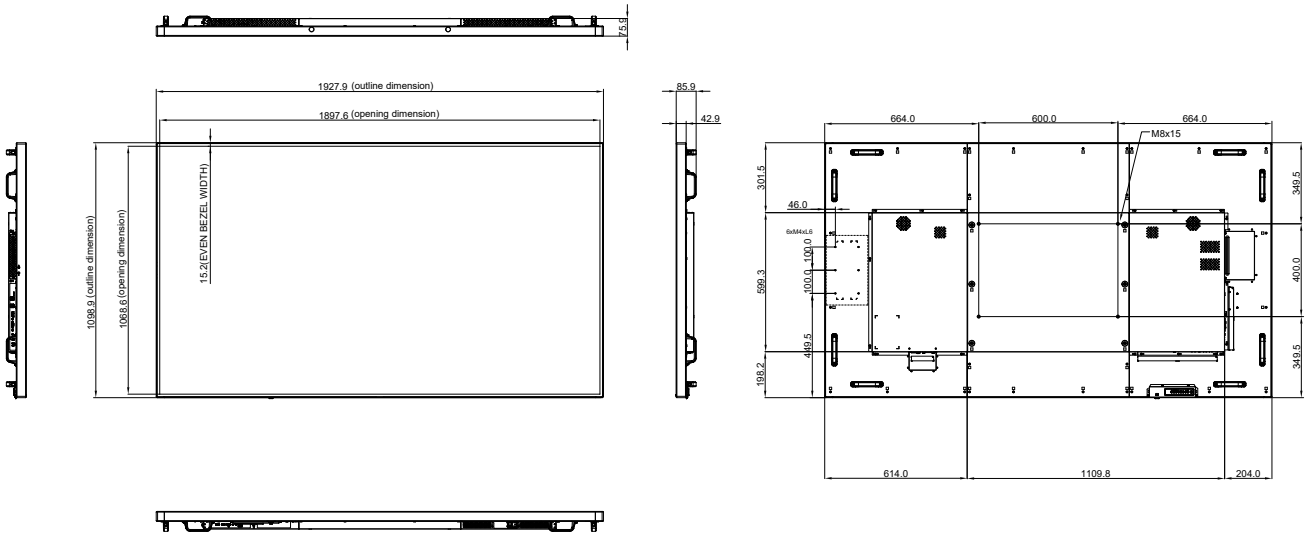

## AG Neovo

Company Address: 5F-1, No. 3-1, Park Street, Nangang District, Taipei, 11503, Taiwan.

Copyright © 2022 AG Neovo. All rights reserved.

NSD-6501Q/7501Q/8601Q Eprel registration number: 616905/616906/620087

ND6QA0/ND7Q00/ND8Q00\_UM\_V016