



THE DISPLAY CHOICE
OF PROFESSIONALS™

www.agneovo.com

TX-3202 Touch Screen Display
User Manual

TABLE OF CONTENTS

SAFETY INFORMATION

WEEE.....	4
-----------	---

PRECAUTIONS

Notice	5
Cautions When Setting Up	5
Cautions When Using.....	6
Cleaning and Maintenance.....	7
Notice for the LCD Display	7

CHAPTER 1: PRODUCT DESCRIPTION

1.1 Package Contents	8
1.2 Removing/Attaching Cable Cover	9
1.3 Wall Mounting.....	10
1.4 Mounting in Portrait Position	11
1.5 LCD Display Overview	12
1.5.1 Front View	12
1.5.2 Rear View.....	12
1.5.3 Control Buttons.....	13

CHAPTER 2: MAKING CONNECTIONS

2.1 Connecting the Power	16
2.2 Connecting Input Source Signals	17
2.3 Connecting USB for Touch Screen Control	18
Touch Disable Function.....	18
2.4 Ventilation Requirements for Enclosure Locating.....	19

CHAPTER 3: USING THE LCD DISPLAY

3.1 Turning on the Power	20
3.2 Displaying the OSD Menu	21
3.3 Adjusting Display Brightness	22
3.4 Adjusting Display Contrast	23

CHAPTER 4: ON SCREEN DISPLAY MENU

4.1 Using the OSD Menu	24
4.2 OSD Menu Tree	26

CHAPTER 5: ADJUSTING THE LCD DISPLAY

5.1 Picture Menu	27
5.2 Colour Menu.....	29
5.3 OSD Menu.....	30
5.4 System Menu	31

CHAPTER 6: APPENDIX

6.1 Warning Messages.....	33
6.2 Timing.....	34
6.3 Touch Screen Driver Installation.....	34
6.3.1 Optional Calibration Tool Install.....	34

TABLE OF CONTENTS

6.3.2 Driver Installation Instructions	35
6.4 Cleaning	36
6.5 Troubleshooting	37
6.6 Transporting the LCD Display	38

CHAPTER 7: SPECIFICATIONS

7.1 Display Specifications	39
7.2 Display Dimensions	40

SAFETY INFORMATION

WEEE

Disposal of Waste Equipment by Users in Private Household in the European Union.

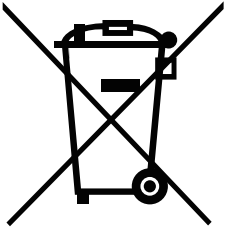

This symbol on the product or on its packaging indicates that this product must not be disposed of with your other household waste. Instead, it is your responsibility to dispose of your waste equipment by handing it over to a designated collection point for the recycling of waste electrical and electronic equipment. The separate collection and recycling of your waste equipment at the time of disposal will help to conserve natural resources and ensure that it is recycled in a manner that protects human health and the environment. For more information about where you can drop off your waste equipment for recycling, please contact your local city office, your household waste disposal service or the shop where you purchased the product.

For Private Households in the European Union. To help conserve natural resources and ensure the product is recycled in a manner that protects human health and the environment, we would like to bring your attention to the following:

- The crossed-out dustbin on the device or outer packaging indicates the product is compliant with European WEEE (Waste Electrical and Electronic Equipment) Directive
- Always dispose of the old devices separately from household waste
- Batteries should be removed beforehand and disposed separately to the right collection system
- You are responsible with regard to the deletion of personal data on old devices before disposal
- Private households can hand in their old devices free of charge
- For more information about where you can drop off your waste equipment for recycling, please contact your local city office, your household waste disposal service or the shop where you purchased the product

PRECAUTIONS

PRECAUTIONS

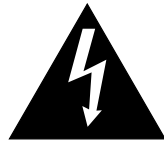

Symbols used in this manual



This icon indicates the existence of a potential hazard that could result in personal injury or damage to the product.



This icon indicates important operating and servicing information.

Notice

- Read this User Manual carefully before using the LCD display and keep it for future reference.
- The product specifications and other information provided in this User Manual are for reference only. All information is subject to change without notice. Updated content can be downloaded from our web site at www.agneovo.com.
- To protect your rights as a consumer, do not remove any stickers from the LCD display. Doing so may affect the determination of the warranty period.

Cautions When Setting Up



Do not place the LCD display near heat sources, such as a heater, exhaust vent, or in direct sunlight.



Do not cover or block the ventilation holes in the housing.



Place the LCD display on a stable area. Do not place the LCD display where it may be subject to vibration or shock.



Place the LCD display in a well-ventilated area.



Do not place the LCD display outdoors.



Do not place the LCD display in a dusty or humid environment.



Do not spill liquid or insert sharp objects into the LCD display through the ventilation holes. Doing so may cause accidental fire, electric shock or damage the LCD display.

PRECAUTIONS

Cautions When Using



Use only the power cord supplied with the LCD display.



The power outlet should be installed near the LCD display and be easily accessible.



If an extension cord is used with the LCD display, ensure that the total current consumption plugged into the power outlet does not exceed the ampere rating.



Do not allow anything to rest on the power cord. Do not place the LCD display where the power cord may be stepped on.



If the LCD display will not be used for an indefinite period of time, unplug the power cord from the power outlet.



To disconnect the power cord, grasp and pull by the plug head. Do not tug on the cord; doing so may cause fire or electric shock.



Do not unplug or touch the power cord with wet hands.



WARNING:

Unplug the power cord from the power outlet and refer to qualified service personnel under the following conditions:



- When the power cord is damaged.
- If the LCD display has been dropped or the housing has been damaged.
- If the LCD display emits smoke or a distinct odor.



Ceiling mount or mount on any other horizontal surface overhead are not advisable.



WARNING:

Installation in contravention of the instructions may result in undesirable consequences, particularly hurting people and damaging property. Users who have already mounted the display on the ceiling or any other horizontal surface overhead are strongly advised to contact AG Neovo for consultations and solutions to help ensure a most pleasurable and fulfilling display experience.

PRECAUTIONS

Cleaning and Maintenance



Do not attempt to service the LCD display yourself, refer to qualified service personnel.

Opening or removing the covers may expose you to dangerous voltage or other risks.

Notice for the LCD Display

In order to maintain the stable luminous performance, it is recommended to use low brightness setting.

Due to the lifespan of the lamp, it is normal that the brightness quality of the LCD display may decrease with time.

When static images are displayed for long periods of time, the image may cause an imprint on the LCD display. This is called image retention or burn-in.

To prevent image retention, do any of the following:

- Set the LCD display to turn off after a few minutes of being idle.
- Use a screen saver that has moving graphics or a blank white image.
- Switch desktop backgrounds regularly.
- Adjust the LCD display to low brightness settings.
- Turn off the LCD display when the system is not in use.

Things to do when the LCD display shows image retention:

- Turn off the LCD display for extended periods of time. It can be several hours or several days.
 - Use a screen saver and run it for extended periods of time.
 - Use a black and white image and run it for extended periods of time.
-

There are millions of micro transistors inside the LCD display. It is normal for a few transistors to be damaged and to produce spots. This is acceptable and is not considered a failure.

CHAPTER 1: PRODUCT DESCRIPTION

1.1 Package Contents

When unpacking, check if the following items are included in the package. If any of them is missing or damaged, contact your dealer.

LCD Display

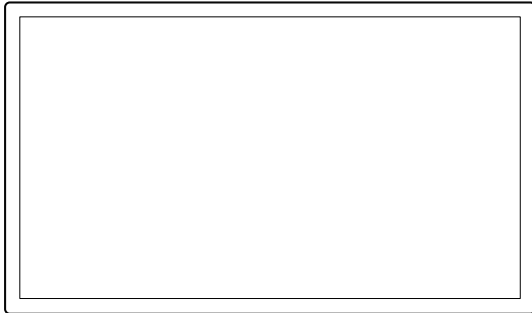

Quick Start Guide



Cable Ties (x3)

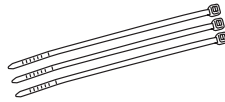

Cable Cover and Screw

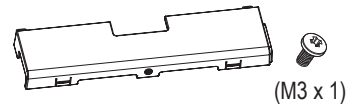

Power Cord



HDMI Cable

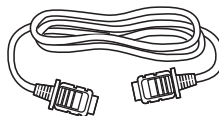

DisplayPort Cable

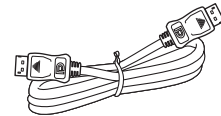

USB Cable



Note:(*)

- Use only the supplied power cord.
- The above pictures are for reference only. Actual items may vary upon shipment.

PRODUCT DESCRIPTION

1.2 Removing/Attaching Cable Cover

1. Lay the LCD display face down on a flat even surface.
2. Press on the cable cover latches and then remove the cable cover as shown in the illustration below.

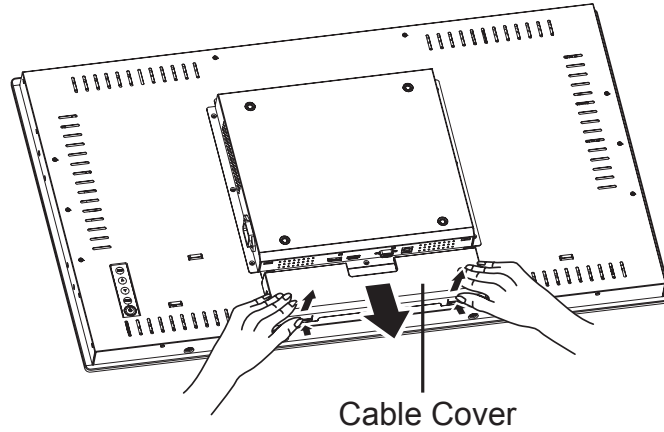

3. After connect the cables to the appropriate connectors and position all cables under the cover lip, attach the cable cover. Take the screw (M3 x 1) from the accessory box, and insert the screw into the cable cover and display.

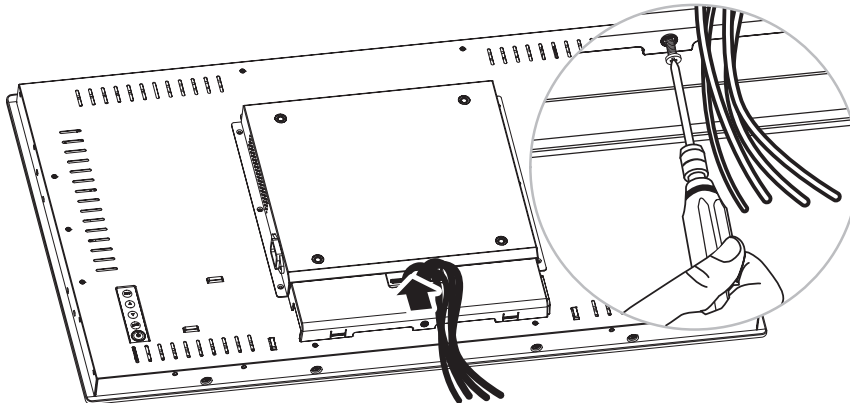

PRODUCT DESCRIPTION

1.3 Wall Mounting

To wall-mount the LCD display, screw the mounting bracket to the VESA holes at the rear of the LCD display.

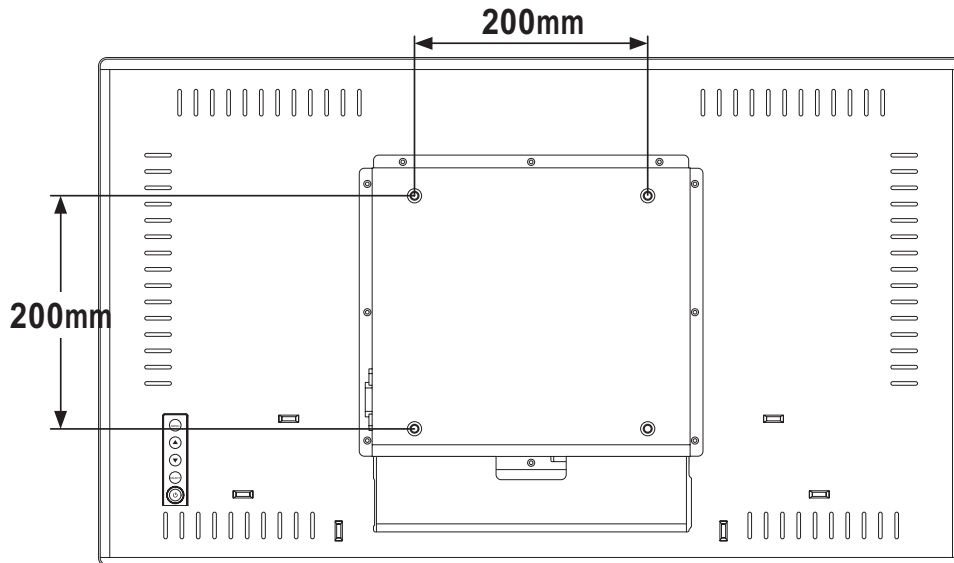

Note: Take measures to prevent the LCD display from falling down and lessen possible injury and damage to the display in case of earthquakes or other disasters.

- Use only the 200 x 200 mm wall mount kit recommended by AG Neovo. All AG Neovo wall mount kits comply with VESA standard.
- Secure the LCD display on a solid wall strong enough to bear its weight.
- It is suggested to wall mount the LCD display without tilting it facing downward.
- The distance between the back cover surface and the bottom of the screw hole is 10 mm. Please use four M6 screws diameter with proper length to mount your display. The mounting stand must be able to support at least 22.8 lb (10.4 kg).

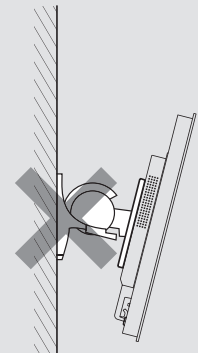

PRODUCT DESCRIPTION

1.4 Mounting in Portrait Position

This display can be installed in portrait position.

Rotate the display 90° clockwise.

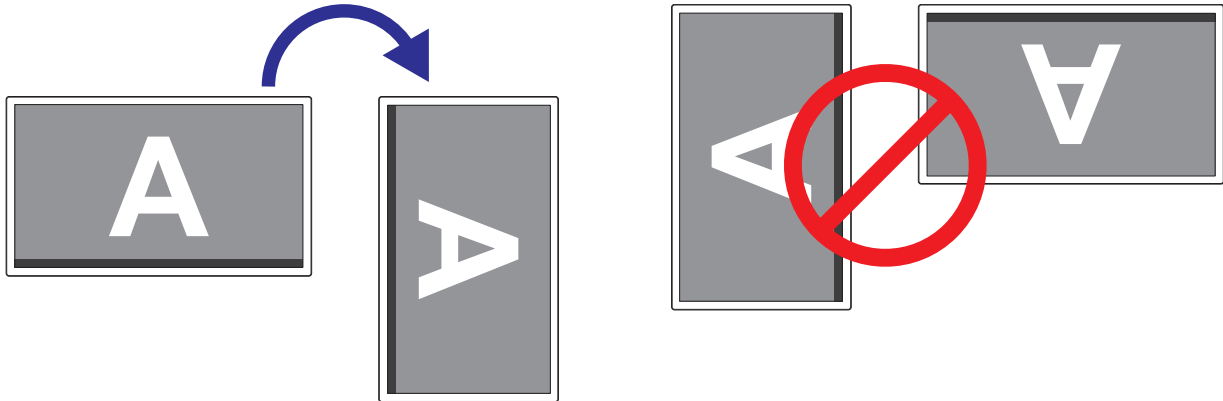

Note:

- ◆ Before mounting, make sure there is space to connect your devices. See “Chapter 2: Making Connections” on page 16.

PRODUCT DESCRIPTION

1.5 LCD Display Overview

1.5.1 Front View

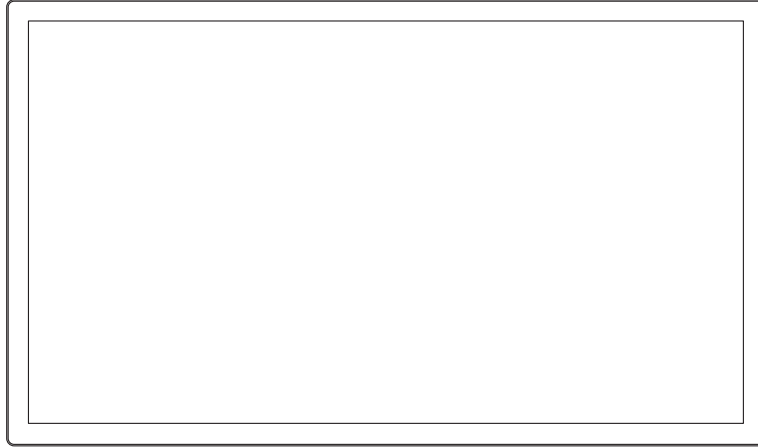

1.5.2 Rear View

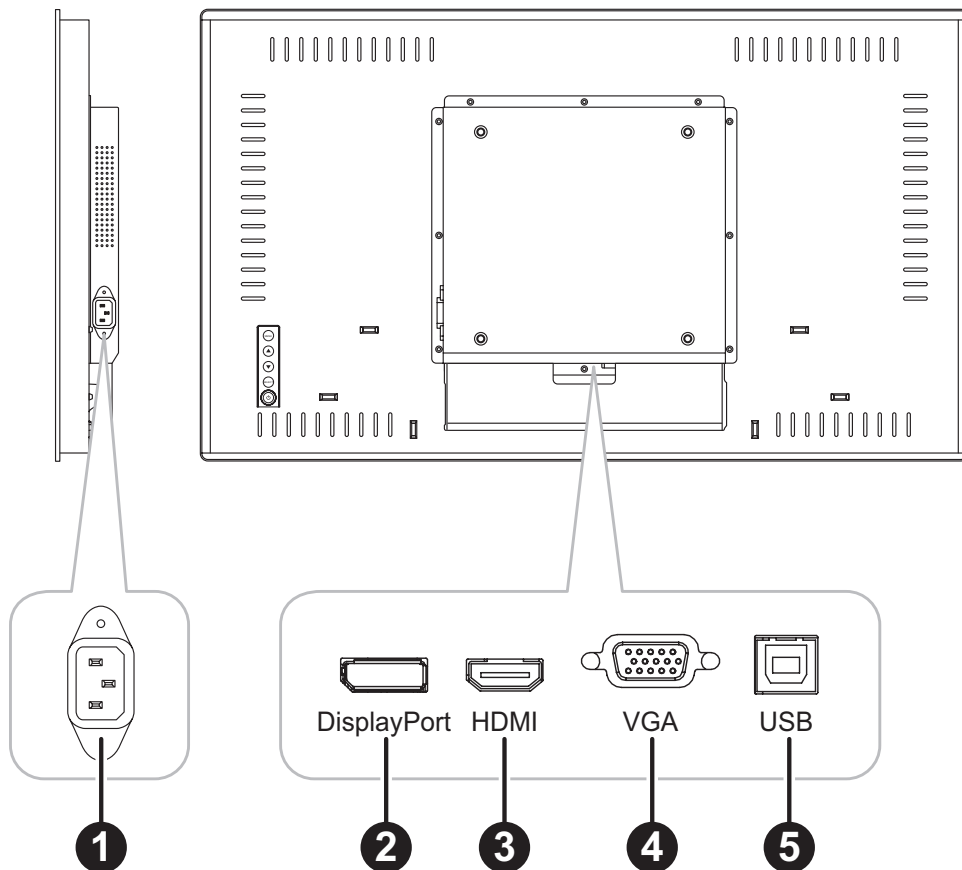

1 AC IN:
AC power input.

2 DisplayPort:
Connect DisplayPort signals input.

PRODUCT DESCRIPTION

- 3 **HDMI:**
Connect HDMI signals input.
- 4 **VGA:**
Connect VGA signals input.
- 5 **USB:**
Connect USB for touch screen control.

1.5.3 Control Buttons

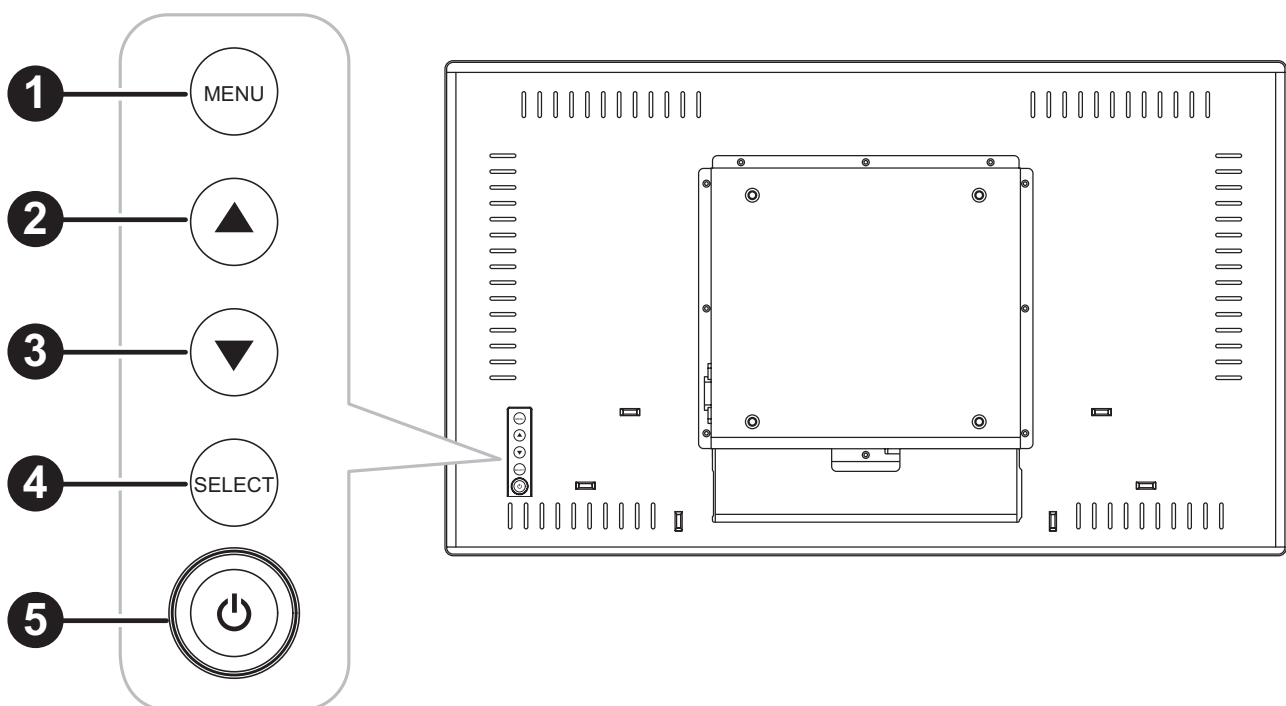

- 1 **MENU:**
 - OSD menu ON/OFF and return to main item.

PRODUCT DESCRIPTION

2

UP (▲): Hot Key: Brightness

- When OSD menu is ON, navigate through adjustment icons or adjust a function.
- When the UP key is pressed, the brightness can be adjusted. The UP/DOWN key can be used for brightness adjustment.

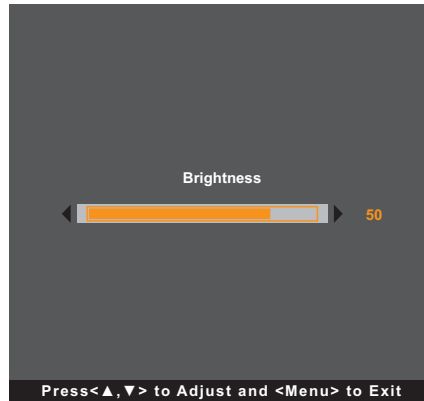

3

DOWN (▼): Hot Key: Contrast

- When OSD menu is ON, navigate through adjustment icons or adjust a function.
- When the DOWN key is pressed, the contrast can be adjusted. The UP/DOWN key can be used for contrast adjustment.

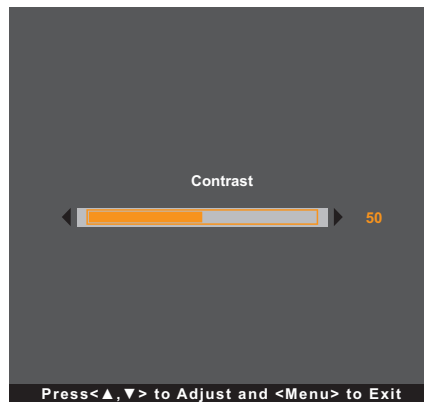

4

SELECT:

- When OSD menu is ON, the key is used for function adjustment confirmation.
- When selecting the input source:
 - If the display is in ON mode, press the SELECT key for 3 seconds to turn on the “Source Select” menu.
 - If the display is in Standby mode, press the SELECT key for 1 second to turn on the “Source Select” menu.

Note: For detailed adjustment of “Source Select”, please refer to page 32.

PRODUCT DESCRIPTION

5 POWER (⏻):

- Press to turn the display ON or OFF.

Note: To lock/unlock the MENU key and/or the ⏻ key, press the MENU and ▼ keys simultaneously. Then select the desired lock/unlock function.

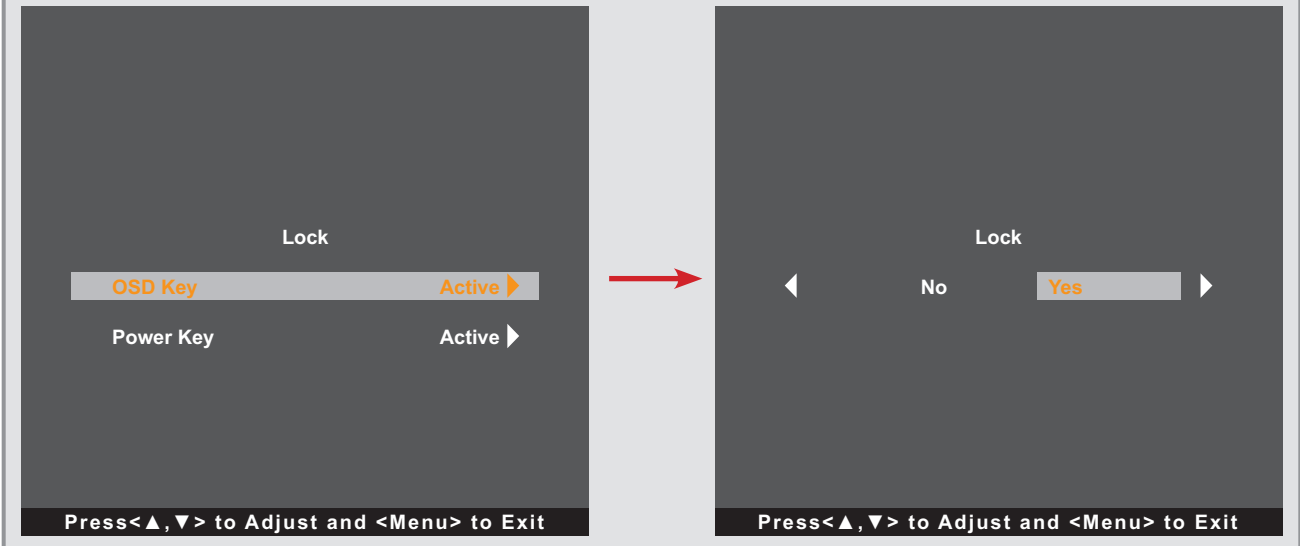

CHAPTER 2: MAKING CONNECTIONS



CAUTION:

Make sure that the LCD display is not connected to the power outlet before making any connections. Connecting cables while the power is ON may cause possible electric shock or personal injury.

2.1 Connecting the Power

1. Connect one end of the power cord to the AC IN connector at the rear of the LCD display.
2. Connect the other end of the power cord to a power outlet or a power supply.

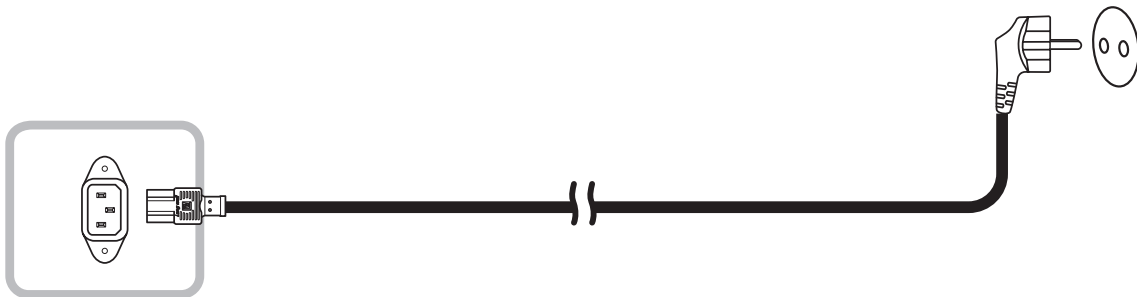

CAUTION:

When unplugging the power cord, hold the power cord by the plug head. Never pull by the cord.

MAKING CONNECTIONS

2.2 Connecting Input Source Signals

Input source signals can be connected with either of the following cables:

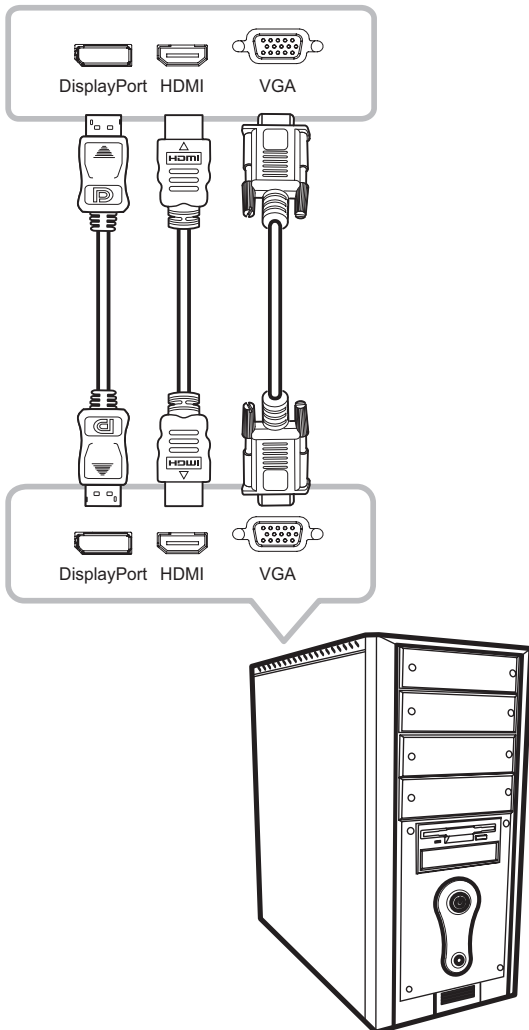

- **DisplayPort**

Connect one end of a DP cable to the DisplayPort connector of the LCD display and the other end to the DisplayPort connector of the computer.

- **HDMI**

Connect one end of an HDMI cable to the HDMI connector of the LCD display and the other end to the HDMI connector of the computer.

- **VGA**

Connect one end of a D-Sub (VGA) cable to the D-Sub (VGA) connector of the LCD display and the other end to the D-Sub (VGA) connector of the computer.

Note: To ensure the LCD display works well with your computer, please configure the display mode of your graphics card to make it less than or equal to 1920 x 1080 resolution and make sure the timing of the display mode is compatible with the LCD display. For compatible Video Modes of your LCD display, please refer to "6.2 Timing" on page 34.

MAKING CONNECTIONS

2.3 Connecting USB for Touch Screen Control

Connect one end of a USB cable to the USB connector of the LCD display and the other end to the USB connector of the computer.

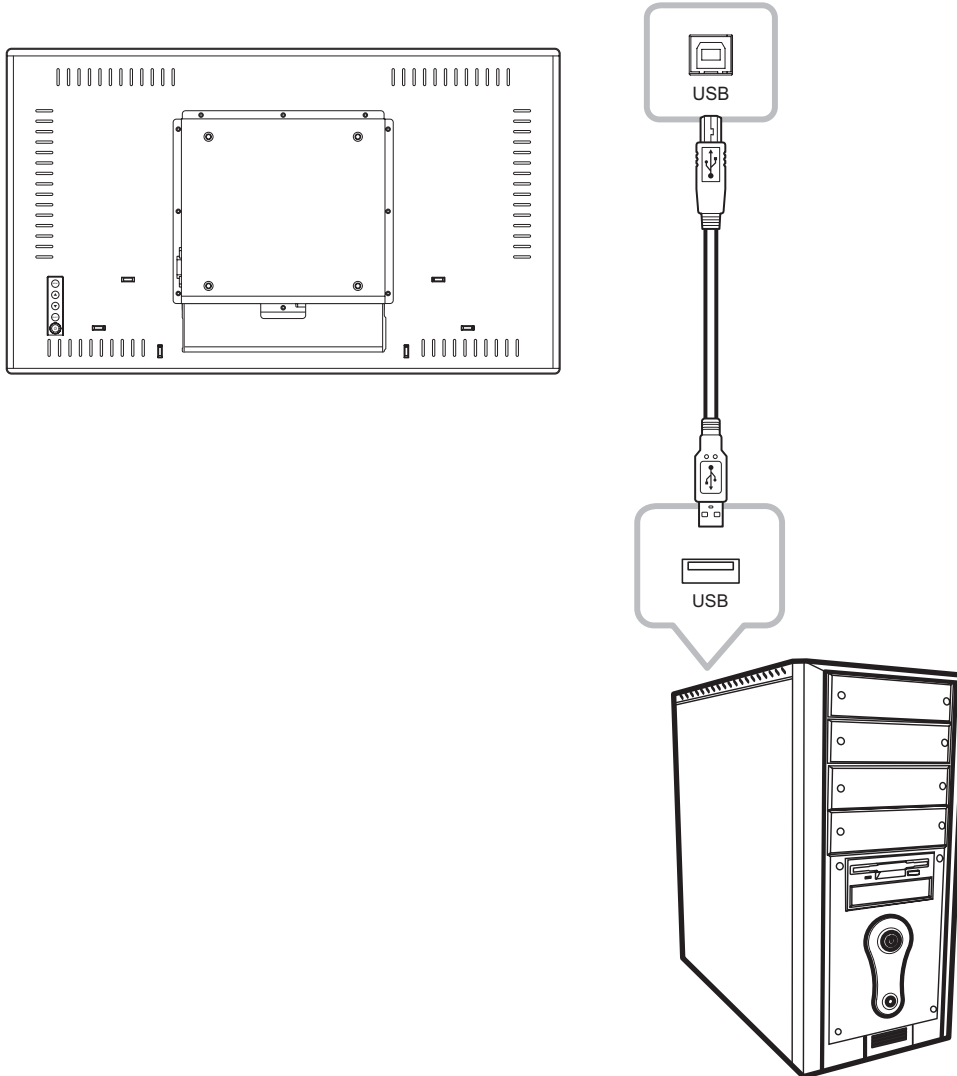

Touch Disable Function

To disable the touch function, do the following:

1. Press “MENU” and “SELECT” keys simultaneously. The “Touch disable” message appears on the screen.

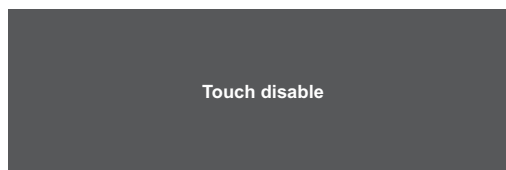

2. To enable the touch function, press “MENU” and “SELECT” keys simultaneously for five seconds.

MAKING CONNECTIONS

2.4 Ventilation Requirements for Enclosure Locating

To allow heat to disperse, avoid installing the LCD display directly on the cabinet wall and make sure the operating/storage temperature/humidity requirements are met as described below:

- Operating conditions: 0°C-40°C (32°F-104°F)
- Operating humidity (non-condensing): 20%-80%
- Operating altitude: < 10,000 feet (3,048m)
- Storage conditions: -20°C-60°C (-4°F-140°F)
- Storage humidity (non-condensing): 10%-90%
- Storage altitude: < 40,000 feet (12,192m)

CHAPTER 3: USING THE LCD DISPLAY

3.1 Turning on the Power

1. Connect the power to the LCD display. Refer to page 16.
2. Press the  key on the control panel to turn the LCD display on.

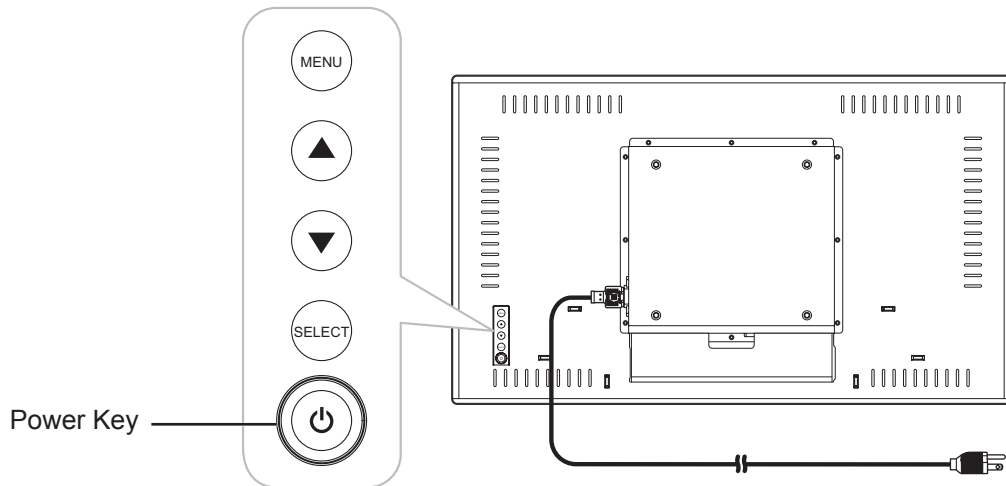

When the LCD display is turned on, press the  key on the control panel three times to turn off the LCD display.

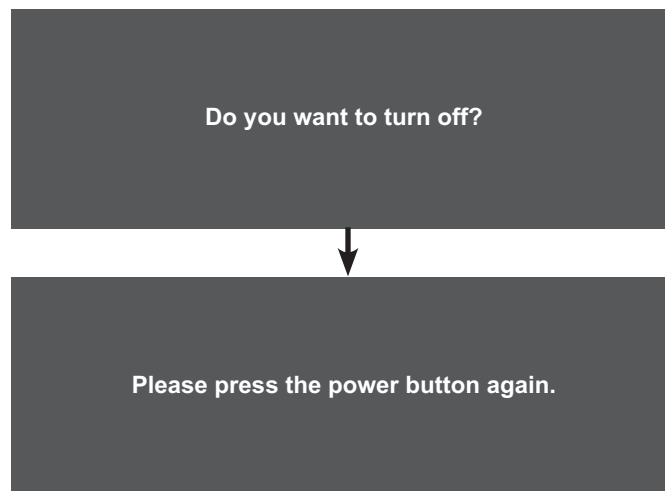

Note: The LCD display still consumes power as long as the power cord is connected to the power outlet. Disconnect the power cord to completely cut off power.

USING THE LCD DISPLAY

3.2 Displaying the OSD Menu

Press the MENU key to open the OSD menu. Press the MENU key again to close the OSD menu.

For more information on adjusting settings, refer to page 24.

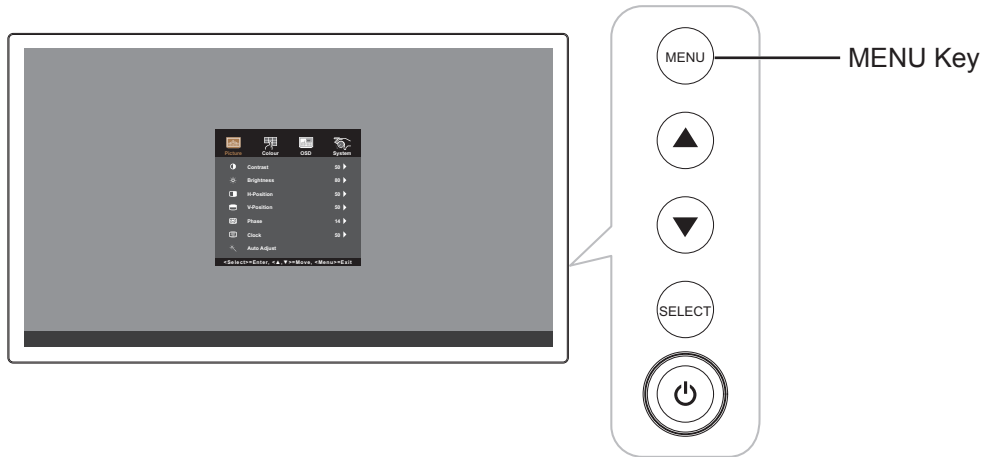

The following menu appears on the screen:

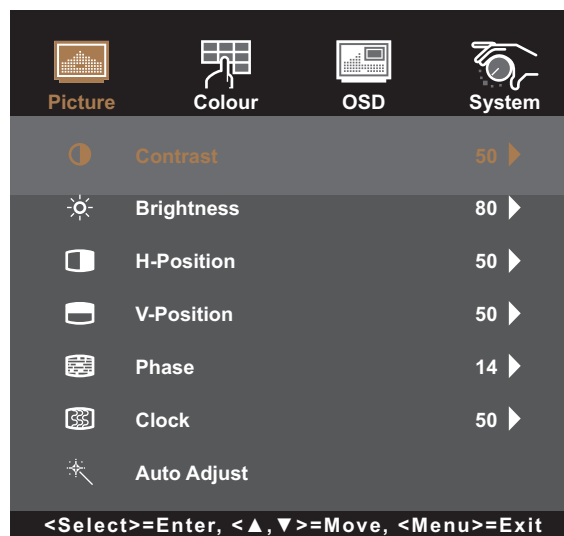

USING THE LCD DISPLAY

3.3 Adjusting Display Brightness

Press the ▲ key to open the Brightness quick menu.



The following menu appears on the screen:

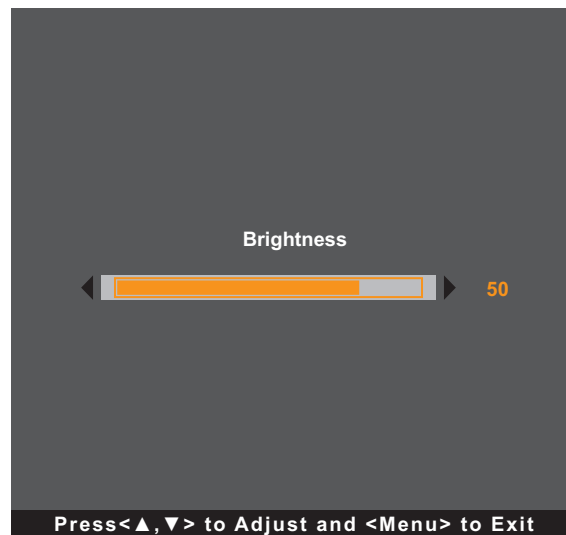

Then press the ▲/▼ keys to adjust the LCD display brightness level.

USING THE LCD DISPLAY

3.4 Adjusting Display Contrast

Press the ▼ key to open the Contrast quick menu.

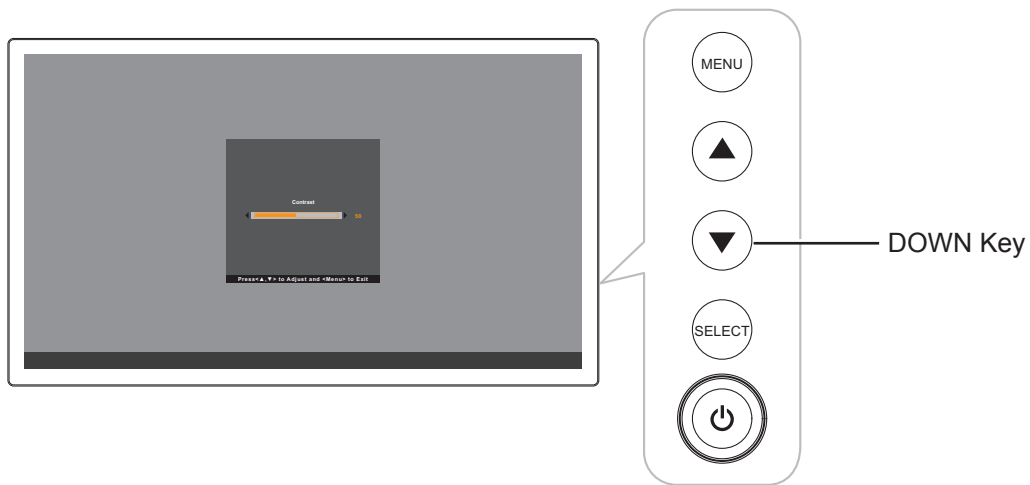

The following menu appears on the screen:

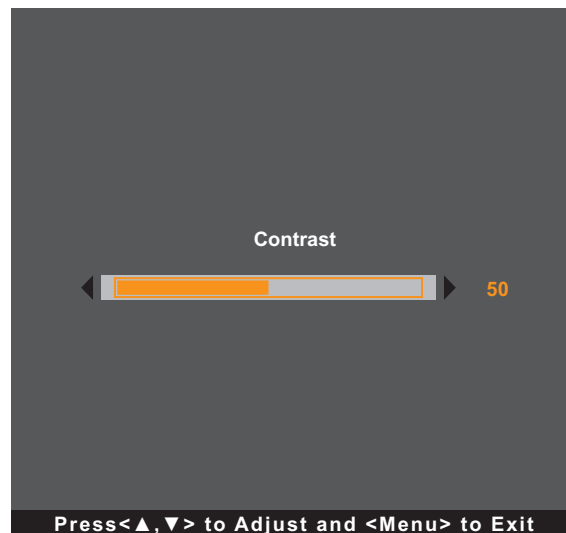

Then press the ▲/▼ keys to adjust the LCD display contrast level.

CHAPTER 4: ON SCREEN DISPLAY MENU

4.1 Using the OSD Menu

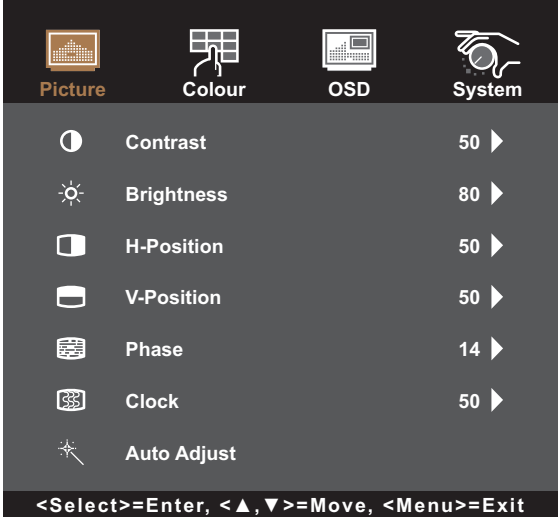
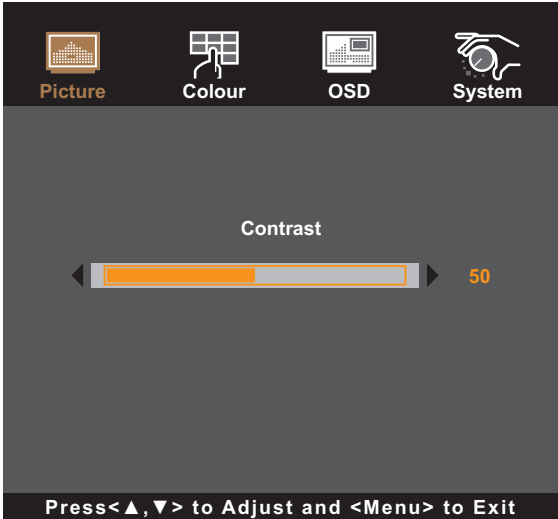
#	Menu Navigation	Operation
1	<p>Display the main menu screen.</p> 	<p>Press MENU.</p>
2	<p>Enter the submenu.</p>  <p>The active main menu and submenu icon is highlighted in orange.</p>	<ol style="list-style-type: none"> 1 Press ▲/▼ to select the main menu item. 2 Press SELECT to enter the submenu. 3 Press ▲/▼ to select the submenu item. 4 Press SELECT to enter the selected submenu.

ON SCREEN DISPLAY MENU

#	Menu Navigation	Operation
3	Adjust the settings or select the value. For example: 	<ol style="list-style-type: none"> 1 Press ▲/▼ to adjust the value or select the setting. 2 Press SELECT to confirm the setting (if necessary).
4	Return to the previous menu and/or close the OSD window.	Press MENU once to return to the previous menu. Press MENU repeatedly (if necessary) to close the OSD window.

Note: When settings are modified, all changes are saved when the user does the following:

- Proceeds to another menu
- Exits the OSD menu
- Waits for the OSD menu to disappear

ON SCREEN DISPLAY MENU

4.2 OSD Menu Tree

Main Menu	Submenu	Reference
Picture	Contrast	Refer to page 27.
	Brightness	
	H-Position	
	V-Position	
	Phase	
	Clock	
	Auto Adjust	
Colour	Colour	Refer to page 29.
	Red	
	Green	
	Blue	
	Picture Mode	
	Sharpness	
OSD	OSD Timeout	Refer to page 30.
	OSD Position	
	OSD H-Position	
	OSD V-Position	
	Touch Switch	
System	Reset	Refer to page 31.
	Language	
	Source Select	
	Information	
	Factory	



Note: Availability of some menu items depend on the input source signal. If the menu is not available, it is disabled and greyed out.

CHAPTER 5: ADJUSTING THE LCD DISPLAY

5.1 Picture Menu

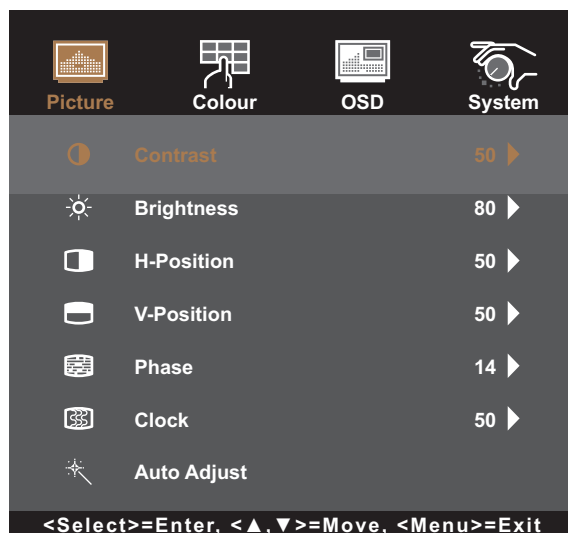
1. Press MENU on the control panel to call out the OSD window.
2. Press ▲/▼ to select Picture and then press SELECT to enter the menu.
3. Press ▲/▼ to select the submenu item and then press SELECT to enter its settings.

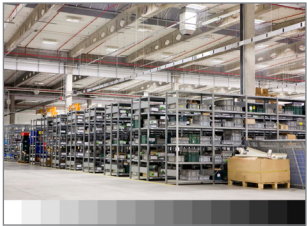
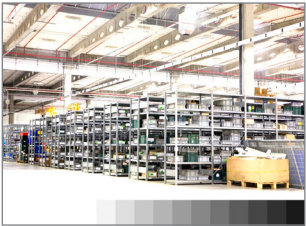
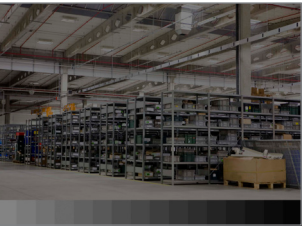
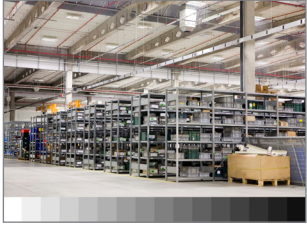

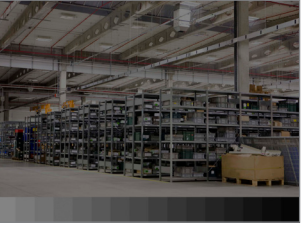
Item	Function	Operation	Range
Contrast	Adjusts the difference between the black level and the white level.	Press ▲/▼ to adjust the value.	0 to 100
	<div style="display: flex; justify-content: space-around;"> <div style="text-align: center;"> <p><i>Original Setting</i></p>  </div> <div style="text-align: center;"> <p><i>High Setting</i></p>  </div> <div style="text-align: center;"> <p><i>Low Setting</i></p>  </div> </div>		
Brightness	Adjusts the luminance of the screen image.	Press ▲/▼ to adjust the value.	0 to 100
	<div style="display: flex; justify-content: space-around;"> <div style="text-align: center;"> <p><i>Original Setting</i></p>  </div> <div style="text-align: center;"> <p><i>High Setting</i></p>  </div> <div style="text-align: center;"> <p><i>Low Setting</i></p>  </div> </div>		
H-Position (Horizontal Position)	Moves the screen image to the left or to the right.	Press ▲/▼ to adjust the value.	0 to 100
	<div style="border: 1px solid gray; padding: 5px; background-color: #f0f0f0;"> <p>Note: This menu item is only available if the source is VGA.</p> </div>		

ADJUSTING THE LCD DISPLAY

Item	Function	Operation	Range
V-Position (Vertical Position)	Moves the screen image up or down. Note: <i>This menu item is only available if the source is VGA.</i>	Press ▲/▼ to adjust the value.	0 to 100
Phase	Adjusts the phase timing to synchronise with the video signal. Note: <i>This menu item is only available if the source is VGA.</i>	Press ▲/▼ to adjust the value.	0 to 100
Clock	Adjusts the frequency timing to synchronise with the video signal. Note: <i>This menu item is only available if the source is VGA.</i>	Press ▲/▼ to adjust the value.	0 to 100
Auto Adjust	Automatically optimises image display.  Note: <i>This menu item is only available if the source is VGA.</i>	Press ▲/▼ to select the setting and then press SELECT to confirm.	No Yes

ADJUSTING THE LCD DISPLAY

5.2 Colour Menu

1. Press MENU on the control panel to call out the OSD window.
2. Press ▲/▼ to select Colour and then press SELECT to enter the menu.
3. Press ▲/▼ to select the submenu item and then press SELECT to enter its settings.

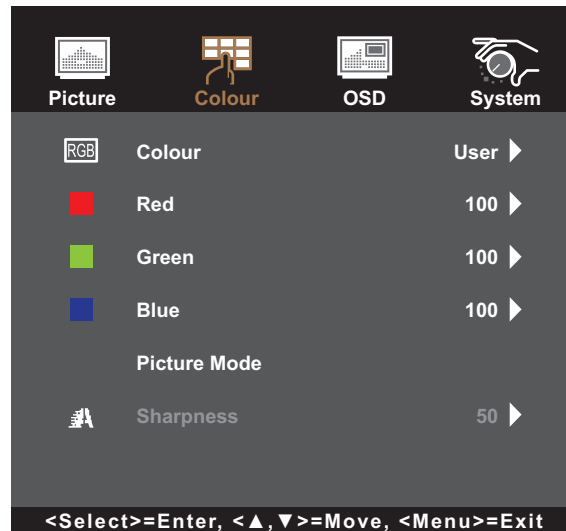

Item	Function	Operation	Range
Colour	Provides several colour adjustment settings.	Press ▲/▼ to select the setting and then press SELECT to confirm.	5500K 6500K 7500K 9300K User
	Colour temperature can be set to: <ul style="list-style-type: none"> • 5500K: Applies a reddish tint for warmer colours. • 6500K: This is the default colour temperature commonly used for normal lighting conditions. • 7500K: Applies the screen colour between red and blue. • 9300K: Applies a bluish tint for cooler colours. • User: This allows users to set the colour temperature by adjusting the Red, Green, and Blue value according to one's preference. 		
Sharpness	Adjusts the clarity and focus of the screen image.	Press ▲/▼ to adjust the value.	0 to 100

ADJUSTING THE LCD DISPLAY

5.3 OSD Menu

1. Press **MENU** on the control panel to call out the OSD window.
2. Press **▲/▼** to select **OSD** and then press **SELECT** to enter the menu.
3. Press **▲/▼** to select the submenu item and then press **SELECT** to enter its settings.

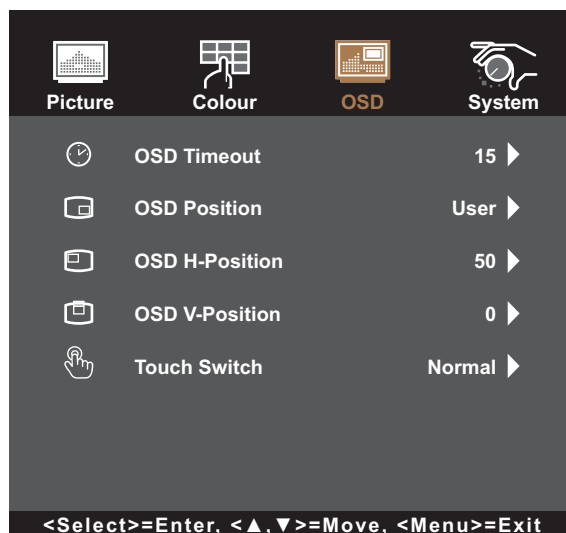

Item	Function	Operation	Range
OSD Timeout	Sets the length of time (in seconds) the OSD screen is displayed. When the time elapses, the OSD screen is automatically inactivated.	Press ▲/▼ to adjust the value.	5 to 60
OSD Position	Sets the OSD window location on the screen.	Press ▲/▼ to select the setting and then press SELECT to confirm.	User-defined
OSD H-Position (Horizontal Position)	Moves the OSD window to the left or right of the screen.	Press ▲/▼ to adjust the value.	0 to 100
OSD V-Position (Vertical Position)	Moves the OSD window up or down the screen.	Press ▲/▼ to adjust the value.	0 to 100

ADJUSTING THE LCD DISPLAY

Item	Function	Operation	Range
Touch Switch	<p>Sets the touch setting.</p> <ul style="list-style-type: none"> • Normal: Supports 30-point multi-touch. Touch the screen with bare fingers or stylus. • Glove: Supports 5-point multi-touch. Touch the screen with gloves on. • Through-Glass: Touch the screen through the glass. Supports 2-point multi-touch and maximum cover glass thickness ≤ 6 mm. <p>Note: After setting the Touch Switch setting, exit the OSD menu and restart the LCD display.</p>	Press ▲/▼ to select the setting and then press SELECT to confirm.	Normal Glove Through-Glass

5.4 System Menu

1. Press MENU on the control panel to call out the OSD window.
2. Press ▲/▼ to select System and then press SELECT to enter the menu.
3. Press ▲/▼ to select the submenu item and then press SELECT to enter its settings.



Item	Function	Operation	Range
Reset	Resets the device to the factory default settings.	Press ▲/▼ to select the setting and then press SELECT to confirm.	No Yes



ADJUSTING THE LCD DISPLAY

Item	Function	Operation	Range
Language	Selects the language used for OSD menus.	Press ▲/▼ to select the setting and then press SELECT to confirm.	English Français Deutsch Italiano Español 日本語 繁中 簡中
Source Select	Sets the input source. Note: <i>If the source is set to “Auto” then the display detects the input source automatically.</i>	Press ▲/▼ to select the setting and then press SELECT to confirm.	Auto VGA HDMI DP
Information	View the source, resolution, and frequency.	Press MENU to return to the System menu.	N/A
Factory	This maintenance function is for the serviceman to operate.	N/A	N/A

CHAPTER 6: APPENDIX

6.1 Warning Messages

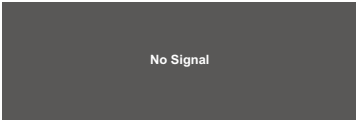
When any of these warning messages appear, check the following items.

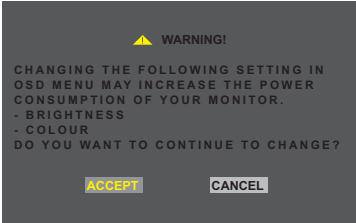
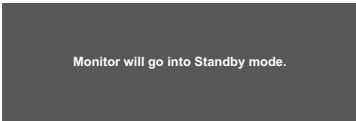
Warning Message	Cause	Solution
 <p>No Signal</p>	<p>The LCD display cannot detect the input source signal.</p>	<ul style="list-style-type: none"> √ Check if the input source is turned ON. √ Check if the signal cable is properly connected. √ Check if any pin inside the cable connector is twisted or broken.
 <p>Out of Range</p>	<p>The resolution or the refresh rate of the graphics card of the computer is set too high.</p> <div style="border: 1px solid gray; padding: 5px; margin-top: 10px;"> <p>Note: If you see the “Out of Range” message on the screen, then the OSD menu cannot be operated.</p> </div>	<ul style="list-style-type: none"> √ Change the resolution or the refresh rate of the graphics card.
 <p>▲ WARNING! CHANGING THE FOLLOWING SETTING IN OSD MENU MAY INCREASE THE POWER CONSUMPTION OF YOUR MONITOR. - BRIGHTNESS - COLOUR DO YOU WANT TO CONTINUE TO CHANGE? ACCEPT CANCEL</p>	<p>Increasing the brightness and/or contrast may increase the power consumption of the display.</p>	<ul style="list-style-type: none"> √ Select “ACCEPT” to confirm or “CANCEL” to cancel the modifications.
 <p>Monitor will go into Standby mode.</p>	<p>The LCD display is in Standby mode. The LCD display will enter Standby mode when experiencing a sudden signal disconnecting problem.</p>	<ul style="list-style-type: none"> √ Check if the signal cable is properly connected. √ The display can be activated by pressing any keyboard, triggering the mouse, or touching the screen. √ Check if the correct source is selected in the OSD > System > Source select menu. Refer to page 32.

CHAPTER 6: APPENDIX

6.2 Timing

Mode	Resolution	H-Freq. (KHz)	Bandwidth (MHz)	Polarity	
				H	V
1	640 x 480 60Hz	31.47	25.175	-	-
2	800 x 600 60Hz	37.88	40	+	+
3	1024 x 768 60Hz	48.36	65	-	-
4	1280 x 720 60Hz	44.77	74.5	-	+
5	1280 x 1024 60Hz	64	108	+	+
6	1366 x 768 60Hz	47.7	85.38	+	+
7	1680 x 1050 60Hz	65.2	146	-	+
8	1920 x 1080 60Hz	67.5	148.5	+	+

6.3 Touch Screen Driver Installation

The LCD display is available with USB connections. The touch driver can be downloaded from <https://www.eeti.com/documentation.html> website.

The supported operating systems are Windows® 7/8/10/11, Windows VISTA/XP/2000/CE/XP Embedded, Mac OS 10.10-10.14, Linux 2.6.36 later/3.x.x/4.x.x/5.x.x, Android 2.3 upwards (Windows 7/8/10/11 Multi touch without driver).

Please Note:

- Your LCD display is Microsoft® Windows® HID (Human Interface Device) compatible if you use the USB touch screen interface. No additional software driver is required for general operation of the touch screen.

Note: A calibration tool can be installed for improved touch position accuracy. Please refer to “6.3.1 Optional Calibration Tool Install”.

6.3.1 Optional Calibration Tool Install

To calibrate the touch screen in Windows 7/8/10/11 environment:

1. Tap Start > Control Panel > Hardware and Sound.

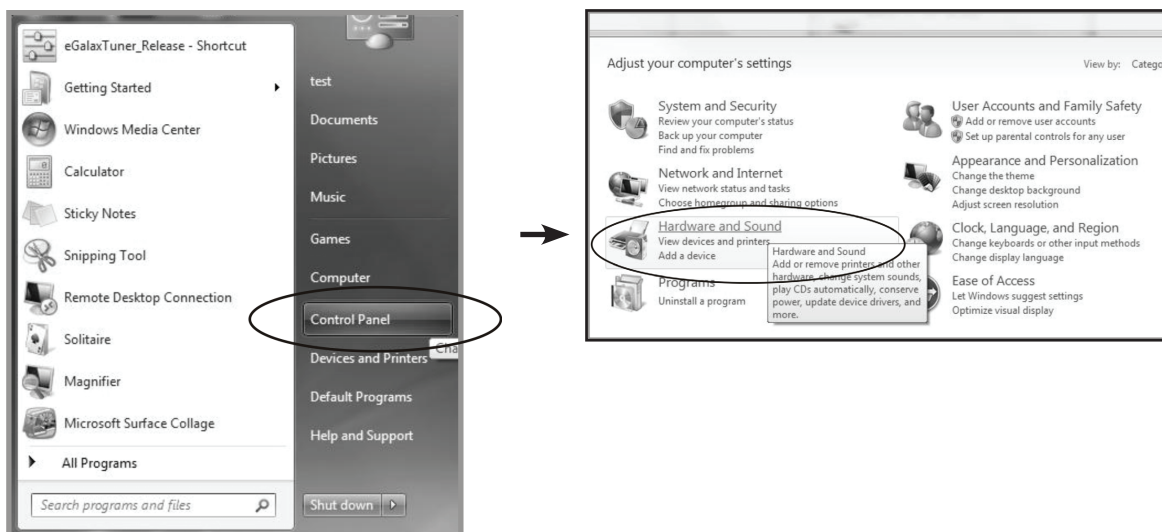

CHAPTER 6: APPENDIX

2. In Tablet PC Settings, tap “Calibrate the screen for pen or touch input”.
3. On the Display tab, in Display options, tap “Calibrate” and then “Yes” to allow the program to make changes.

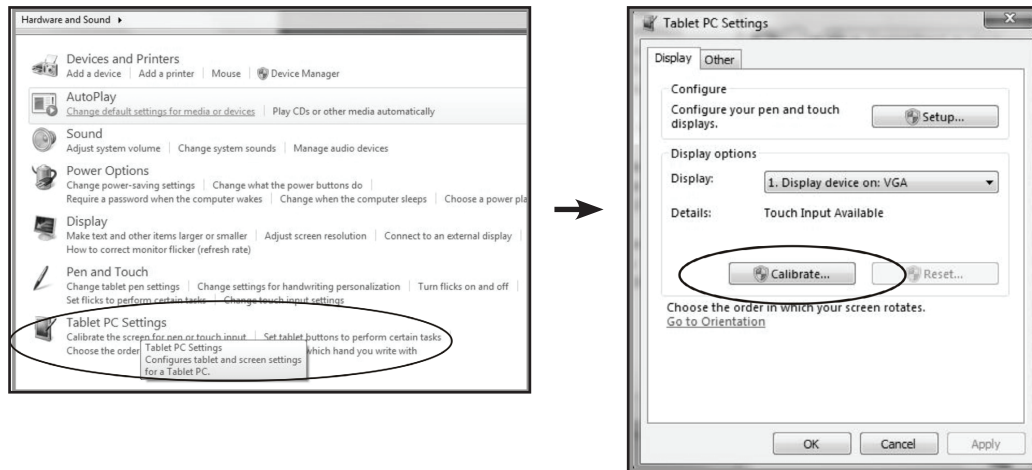

4. Follow the on-screen instructions to calibrate the touch screen.

6.3.2 Driver Installation Instructions

If you are using a PC running Windows VISTA, XP, 2000, follow the instructions below:

1. Power on the PC.
2. Make sure the USB cable is connected from the PC to the LCD display.
3. Open the corresponding driver folder file.
4. Follow the step-by-step instructions as shown on the pop-up windows.

If you are using a PC running Windows® XP Embedded, follow the instructions below:

- Express:
 1. Power on the computer.
 2. Make sure the USB cable is connected to the computer.
 3. Make sure your EWF is disabled. If your EWF is enabled, please disable the EWF by using the EWF Manager command.
 4. Once the EWF is disabled, click on the XP driver and follow the step-by-step instructions as shown on the pop-up windows.
- Custom:
 1. Power on the computer.
 2. Make sure the USB cable is connected to the computer.
 3. Follow the step-by-step instructions found in the driver folder file.

CHAPTER 6: APPENDIX

If you are using a PC running Windows® CE, follow the instructions below:

1. Power on the computer.
2. Make sure the USB cable is connected to the computer.
3. Using Platform Builder, build an image file by following the step-by-step instructions found in the driver folder file.

If you are using a PC running Linux, Android 2.1 upward and 4.0, Apple® Mac OS, follow the instructions below:

1. Power on the computer.
2. Make sure the USB cable is connected to the computer.
3. Follow the step-by-step instructions found in the driver folder file.

6.4 Cleaning

Front Panel Cleaning Instructions

- The front of the display has been specially treated. Wipe the surface gently using only a cleaning cloth or a soft, lint-free cloth.
- If the surface becomes dirty, soak a soft, lint-free cloth in a mild detergent solution. Wring the cloth to remove excess liquid. Wipe the surface of the display to remove dirt. Then use a dry cloth of the same type to dry.
- Do not use volatile substances such as insect sprays, solvents and thinners.

Cabinet Cleaning Instructions

- If the cabinet becomes dirty, wipe the cabinet with a soft, dry cloth.
- If the cabinet is extremely dirty, soak a lint-free cloth in a mild detergent solution. Wring the cloth to remove as much moisture as possible. Wipe the cabinet. Use another dry cloth to wipe over until the surface is dry.
- Do not allow any water or detergent to come into contact with the surface of the display. If water or moisture gets inside the unit, operating problems, electrical and shock hazards may result.
- Do not scratch or hit the cabinet with fingers or hard objects of any kind.
- Do not use volatile substances such as insect sprays, solvents and thinners on the cabinet.
- Do not place anything made from rubber or PVC near the cabinet for any extended periods of time.

APPENDIX

6.5 Troubleshooting

Problems	Possible Cause and Solution
No picture.	<ul style="list-style-type: none"> • Check if the LCD display is turned ON. • Check if the power cord is plugged into the power outlet and to the LCD display. • Check if the LCD display is properly connected to the input source. • Check if the input source is turned ON. • Check if the input source is in standby mode, move the mouse or press any key to wake it up. <div style="border: 1px solid black; padding: 5px; margin-top: 10px;"> <p>Note: Do not connect the USB cable to the LCD display in order to charge your laptop. Doing so will disable the LCD display to wake up from standby mode by simply touching the screen.</p> </div>
Partial image or incorrectly displayed image.	<ul style="list-style-type: none"> • Check to see if the resolution of your computer is higher than that of the LCD display. • Reconfigure the resolution of your computer to make it less than or equal to 1920 x 1080.
Image position is incorrect.	<ul style="list-style-type: none"> • For VGA input, adjust the “H-Position (Horizontal Position)” and “V-Position (Vertical Position)” settings in Picture menu. Refer to page 27.
The displayed texts are blurry.	<ul style="list-style-type: none"> • For VGA input, run the Auto Adjust function in Picture menu. Refer to page 28.
Red, blue, green, white dots appear on the screen.	<ul style="list-style-type: none"> • There are millions of micro transistors inside the LCD display. It is normal for a few transistors to be damaged and to produce spots. This is acceptable and is not considered a failure.
Faint shadows from a static image appear on the screen.	<ul style="list-style-type: none"> • Turn off the LCD display for extended periods of time. • Use a screen saver or a black and white image and run it for extended periods of time.
Dew formed on the LCD display.	<ul style="list-style-type: none"> • This normally happens when the LCD display is moved from a cold room to a hot room temperature. Do not turn ON the LCD display, wait for the dew condensation to disappear.

APPENDIX

6.6 Transporting the LCD Display

To transport the LCD display for repair or shipment, place the display in its original packaging box.

1. Place the two foam cushions on the top and bottom sides of the LCD display for protection.
2. Place the LCD display down in the box.
3. Place the accessory box on the designated area (if necessary).
4. Close and tape the box.

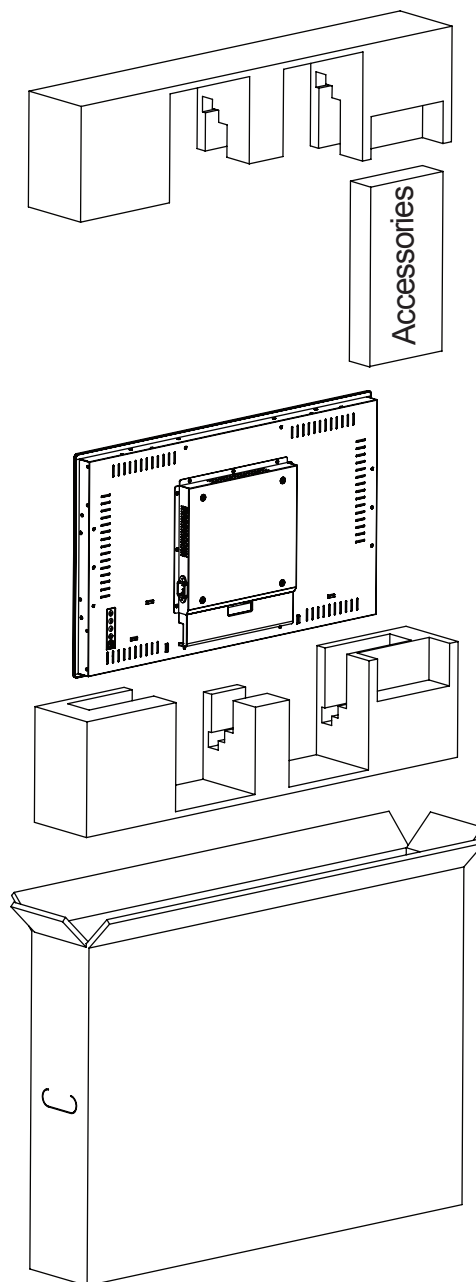

Note:

- *It is recommended to use the original packaging box.*
- *When repacking, carefully place the LCD display in its box and protect the glass panel from touching any object.*

CHAPTER 7: SPECIFICATIONS

7.1 Display Specifications

TX-3202		
Panel	Panel Type	LED-Backlit TFT LCD (VA Technology)
	Panel Size	31.5"
	Max. Resolution	FHD 1920 x 1080
	Pixel Pitch	0.3637 mm
	Brightness	500 cd/m ²
	Contrast Ratio	3000:1
	Viewing Angle (H/V)	178°/178°
	Display Colour	16.7M
	Response Time	5 ms
	Surface Treatment	Anti-Glare Treatment (Haze 2%), 3H Hard Coating
Frequency (H/V)	H Freq.	30 kHz-68 kHz
	V Freq.	47 Hz-63 Hz
Input	DisplayPort	x 1
	HDMI	1.4 X 1
	VGA	15-Pin D-Sub x 1
External Control	RJ11	-
Touch Screen	Technology	Projective Capacitive
	Positional Accuracy	± 2.5 mm
	Panel Interface	USB (Type-B)
	Multi-touch Plug & Play	30-point touch Windows® 7, 8, 10, 11
	Single Touch Support by Driver	Windows VISTA/XP/2000/CE/XP Embedded, Mac OS 10.10-10.14
	Multi-touch Support by Driver	Linux 2.6.36 later/3.x.x/4.x.x/5.x.x Android 2.3 upwards
Power	Power Requirements	AC 100-240V, 50/60 Hz
	On Mode	27.5W (On)
	Stand-by Mode	< 0.9W
	Off Mode	< 0.3W
	Power Supply	Internal
Glass	Thickness	2.75 mm (0.10")
	Transmission Rate	> 90%
	Hardness	> 7H
Operating Conditions	Temperature	0°C-40°C (32°F-104°F)
	Humidity	20%-80% (non-condensing)
Storage Conditions	Temperature	-20°C-60°C (-4°F-140°F)
	Humidity	10%-90% (non-condensing)
Mounting	VESA FPMPI	Yes (200 x 200 mm)
Stand	Tilt	-
Dimensions	Product with Base (W x H x D)	-
	Product w/o Base (W x H x D)	742.4 x 436.8 x 61.2 mm (29.2" x 17.1" x 2.4")
	Packaging (W x H x D)	890.0 x 630.0 x 155.0 mm (35.0" x 24.8" x 6.1")
Weight	Product with Base	-
	Product w/o Base	10.4 kg (22.8 lb)
	Packaging	12.9 kg (28.3 lb)

Note: All specifications are subject to change without prior notice.

CHAPTER 7: SPECIFICATIONS

7.2 Display Dimensions

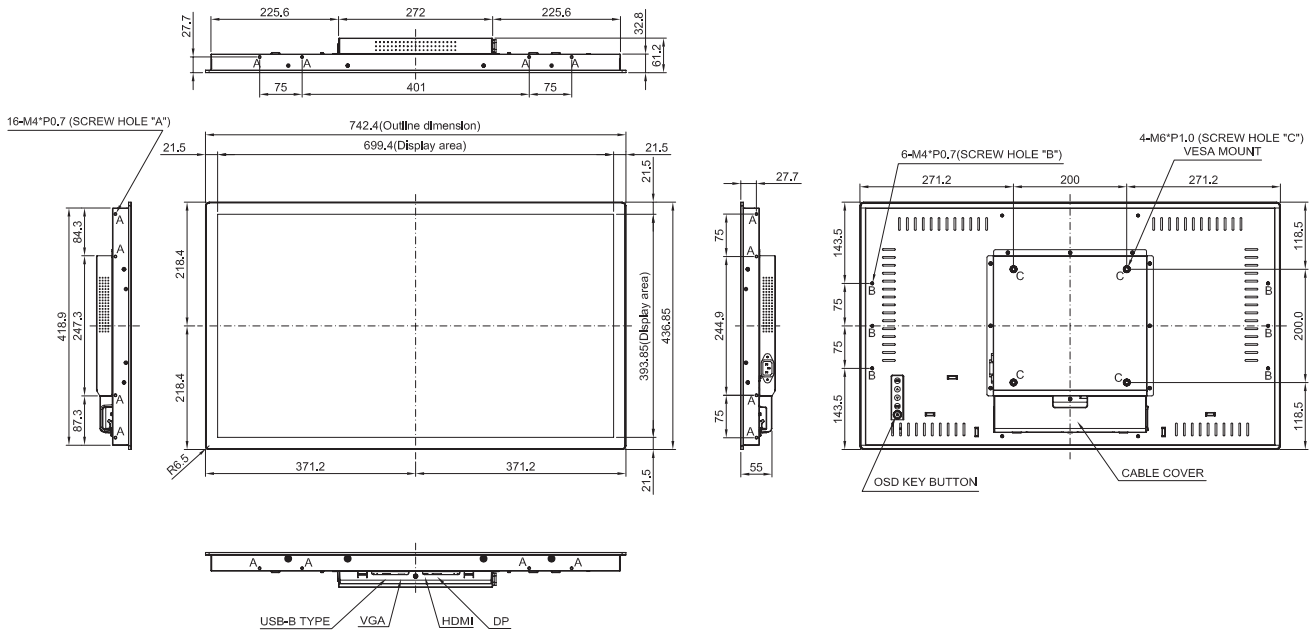

AG Neovo

Company Address: 5F-1, No. 3-1, Park Street, Nangang District, Taipei, 11503, Taiwan.

Copyright © 2022 AG Neovo. All rights reserved.

TX-3202 Eprel registration number: 581669

TX3220_UM_V014