

OWI INC USER MANUAL: Model: AMP1SGRN

GREEN AMPLIFIER WITH PRIORITY OVERRIDE



205 Westwood Ave, Long Branch, NJ 07740
Phone: 866-94 BOARDS (26273) / (732)-222-1511
Fax: (732)-222-7088 | E-mail: sales@touchboards.com

OWI User Manual: Model AMP1SGRN Speaker Amplifier with Priority Audio Override

PROPRIETARY NOTICE

The OWI Inc. product information and design disclosed herein were originated by and are the property of OWI Inc. OWI Inc. reserves all patent, proprietary design, manufacturing, reproduction, use and sales rights thereto, and to any article disclosed therein, except to the extent right(s) are expressly granted to others.

COPYRIGHT NOTICE

This manual is Copyright 2010, 2011 by OWI Inc. All rights reserved. Reproduction in whole or in part without written prior permission from OWI, Inc. is prohibited.

UNPACKING AND INSPECTION NOTICE

Immediately upon receipt of the equipment, inspect the shipping container and the contents carefully for any discrepancies or damage. Should there be any, notify the freight company and OWI, Inc. or the dealer where purchased at once.

LIMITED WARRANTY

1. This product has been thoroughly tested and inspected at the factory. It is warranted for one year from the date of purchase.
IT IS THE OWNERS' RESPONSIBILITY TO ESTABLISH THE DATE OF PURCHASE BY ACCEPTABLE EVIDENCE AT TIME SERVICE IS SOUGHT.
2. Any unit, which in the judgment of OWI INC, is defective or develops defects under normal use will be replaced or repaired without cost within the warranty period.
3. This warranty will be considered void if the unit is dropped, misused, abused and altered in any manner, overdriven with excess amplification exceeding manufacturer's specification, improperly serviced or accidentally damaged.
4. OWI Inc. shall have no liability whatsoever for consequential damages. The sole responsibility at the discretion of OWI Inc. under this warranty shall be limited to the repair of the product or replacement thereof. Any and all implied warranties including the implied warranty of merchantability are limited to the duration of this express limited warranty.
OWI, Inc. is NOT liable for incidental or consequential damages of any kind.
5. IMPORTANT: This warranty is void unless the attached card is completed and mailed to OWI Inc. within 10 days following the date of purchase. Units must be sent to OWI Inc. or to the dealer where purchased.

RETURN SHIPPING INSTRUCTIONS, Obtain a RETURN AUTHORIZATION from:

OWI Inc., 17141 Kingsview Ave, Carson, CA 90746.
Phone (310) 515-1900, Fax (310) 515-1606

FCC Notice: This equipment has been tested and found to comply with the limits for a Class A digital device, pursuant to part 15 of the FCC Rules. These limits are designed to provide reasonable protection against harmful interference when the equipment is operated in a commercial environment. This equipment generates, uses, and can radiate radio frequency energy and, if not installed and used in accordance with the instruction manual, may cause harmful interference to radio communications. Operation of this equipment in a residential area is likely to cause harmful interference in which case the user will be required to correct the interference at his or own expense.

Modifications not expressly approved by the manufacturer could void the user's authority to be operated under FCC rules.

Written for OWI Inc. by Stan Hubler, Smartsciences

Table of Contents

Description	Page
Proprietary, Copyright Notices	2
Unpacking and Inspection	2
Warranty Information	2
Return Shipping Instructions	2
Table of Contents	3
Important Safety Instructions	4 - 6
Introduction	7 - 8
Specifications	9 - 11
Illustration: Connection and Control	12
Chained Self Amplified Speakers Wiring	13
One, Two, Four Speaker Combination Wiring	14
Non-Priority Input Connectors Wiring	15
Priority Input Connectors Wiring	16
Speaker Out / RJ45 / Power Wiring	17
RJ45 Pin-Out	18
RS232 firmware	19
Installation	20 - 23
Operation	24 - 25
AMP1SGRN and MC4 Wiring Diagram	26
Maintenance	27
Trouble Shooting Guide	27

IMPORTANT SAFETY INSTRUCTIONS



CAUTION



RISK OF ELECTRIC SHOCK - DO NOT OPEN

NOTE: Installation is to be completed by a qualified electrical technician according to NEC/CEC code and applicable local codes.

CAUTION: The power supply is not to be used in air handling spaces.

CAUTION: To reduce the risk of electric shock: Do not remove the cover or back: No user-serviceable parts inside: refer servicing to qualified personnel.

The lightning flash with arrowhead within an equilateral triangle is intended to alert the user to the presence of uninsulated “dangerous voltage” within the product’s enclosure that may be of sufficient magnitude to constitute a risk of electric shock to persons.

The exclamation point within an equilateral triangle is intended to alert the user of the presence of important operating and maintenance (servicing) instructions in the literature accompanying the appliance.

The apparatus shall not be exposed to dripping or splashing and that no objects filled with liquids, such as vases, shall be placed on the apparatus.

IMPORTANT SAFETY INSTRUCTIONS

1. Read these instructions. All the safety and operation instructions should be read before this OWI product is operated.
2. Keep these instructions - The safety and operating instructions should be kept for future reference.
3. Heed all warnings - All warnings on this product and in these operating instructions should be followed.
4. Follow all instructions - All operating and other instructions should be followed.
5. Do not use this apparatus near water - for example, near a bathtub, washbowl, kitchen sink, laundry tub, in a wet basement, near a swimming pool, or a swamp.
6. Clean only with dry cloth.

Continues on next page

IMPORTANT SAFETY INSTRUCTIONS (Continued)

- 7. Do not block any ventilation openings. Install in accordance with the manufacturer's instructions. - This OWI product should be situated so that its location or position does not interfere with its proper ventilation. For example, the component should not be situated on a bed, sofa, rug, or similar surface that may block any ventilation openings, or placed in a built-in installation such as a bookcase or cabinet that may impede the flow of air through ventilation openings.**
- 8. Do not install the unit near any heat sources such as radiators, heat registers, stoves or other apparatus (including amplifiers) that produce heat.**
- 9. Do not defeat the safety purpose of the polarized or grounding-type plug. A polarized plug has two blades with one wider than the other. A grounding type plug has two blades and a third grounding prong. The wider blade or the third prong is provided for your safety. If the provided plug does not fit into your outlet, consult an electrician for replacement of the obsolete outlet.**
- 10. Protect the power cord from being walked on or pinched particularly at plugs, convenience receptacles, and the point where they exit the apparatus.**
- 11. Only use attachment/accessories specified by the manufacturers.**



Portable Cart Warning

- 12. Use only with the cart, stand, tripod, bracket or table specified by the manufacturer, or sold with the apparatus. When a cart is used, use caution when moving the cart/apparatus combination to avoid injury from tip-over.**
- 13. Unplug this apparatus during lightning storms or when unused for long periods of time.**
- 14. Refer all servicing to qualified service personnel. Servicing is required when the apparatus has been damaged in any way, such as power-supply cord or plug is damaged, liquid has been spilled or objects have fallen into the apparatus, the apparatus has been exposed to rain or moisture, does not operate normally, or has been dropped. The user should not attempt to service this OWI product beyond those means described in this operating manual. All other servicing should be referred to the OWI Service Department.**

Continues on next page

IMPORTANT SAFETY INSTRUCTIONS (Continued)

- 15. WARNING: To reduce the risk of fire or electric shock, do not expose this apparatus to rain or moisture.**
- 16. To prevent electric shock, do not use this polarized plug with an extension cord, receptacle or other outlet unless the blades can fully be inserted to prevent blade exposure.**
- 17. Exposure to extremely high noise levels may cause permanent hearing loss. Individuals vary considerably in susceptibility to noise-induced hearing loss, but nearly everyone will lose some hearing if exposed to sufficiently intense noise for a period of time. The U.S. Government's Occupational Safety and Health Administration (OSHA) has specified the permissible noise level exposures shown in the following chart. According to OSHA, any exposure in excess of these permissible limits could result in some hearing loss. To ensure against potentially dangerous exposure to high sound pressure levels, it is recommended that all persons exposed to equipment capable of producing high sound pressure levels use hearing protectors while the equipment is in operation. Ear plugs or protectors in the ear canals or over the ears must be worn when operating the equipment in order to prevent a permanent hearing loss if exposure is in excess of the limits set forth here.**
- 18. OWI recommends that this apparatus be placed on a switched power outlet, one that switches both sides and has contact separation of at least 3 millimeters.**

End of IMPORTANT SAFETY INSTRUCTIONS

Introduction

The OWI **AMP1SGRN** is a self powered speaker/amplifier. This unit can drive up to four speakers connected series parallel to have a net impedance of 8 ohms. With an included UL Listed, **Level 5** (Energy Star), 15 volt, 3.5 ampere power supply, the amplifier can output 32 watts, or 8 watts per speaker in a four speaker hook-up.

Special features of the OWI Mode AMP1SGRN include:

Energy Star Sleep Mode

If no audio is present on any input for a nominal, factory set, delay time of 2 minutes, the power amplifier is put into a low power “shutdown” mode. The delay time is settable, but for Energy Star rating, the maximum time is 30 minutes, the factory set time is 2 minutes. During sleep mode, power consumption of the speaker amplifier is less than one (1) watt. The power supply, during sleep mode, draws a very small power.

Three audio inputs: Normal, Auxiliary and Priority Override

The **Normal** input accepts a balanced input via a Phoenix style screw terminal plug (A9) or an unbalanced input via minijack A12. The A12 input can be microphone level or line level, set by A10. The line level can range from -20dBu to 0dBu. The microphone level input can be -40dBu. The minijack can accept mono or stereo inputs. The stereo channels are summed together. This audio is adjusted with potentiometer adjacent to “Auxiliary Input”. This input is muted during Priority Override. One use of the auxiliary input is for an infrared microphone.

Priority Override Feature

The **Priority** input accepts balanced input levels of jumper selected 100 volts audio, 70 volts audio, 25 volts audio and 1 volt (approximately line level) audio. Audio on the **Priority** input suspends audio on the **Normal** or **Auxiliary** input and switches the speaker amplifier to pass the **Priority** audio (A8). After the **Priority** audio stops, the unit waits a selectable time delay before returning to the **Normal** or **Auxiliary** audio input. The delay is computer settable via RS232 from 5 to 60 seconds. With an adapter, the USB connector on a computer can be used to set the delay.

Self Test Feature

This unit self tests itself by looking for a disconnected speaker string or otherwise high impedance. The self test occurs when either a manual button is pressed or when it is commanded by a computer. A good test is signaled by two flashes of a green LED and an RS232 output of “OKAY”. A bad test is signaled by two flashes of a red LED and an RS232 output of “FAIL”. The test uses a low frequency sine wave and it senses the audio current before and during the low frequency sine wave. The self test doesn't interfere with the other audio inputs and outputs.

Bass and Treble Controls (Equalization)

The bass and treble controls are located at A16. The bass control is closest to the auxiliary gain pot. The controls are centered for flat frequency response and turned right for a 10dB boost and turned left for a 10dB cut. The factory settings of the bass and treble controls are in the center position (for flat response). The 10dB bass boost and cut occurs at 50 Hz. The 10dB treble boost and cut occurs at 10 kHz.

Balanced Line Level Output

A nominal 0dB level, balanced output is available at terminal board A7. The source of this output is either pre-master fader or post-master fader, selectable by jumper JMP3 which is located under the component board, directly under the equalization pots. The master fader (Master Volume) is potentiometer A2, accessible under the grill. The equalization feature is not available on the balanced line level output during pre-master fader operation.

Power Amplifier Features

The power amplifier outputs 2 times 16 watts or 32 watts total into 8 ohms and 15VDC power. Higher power is available but not Energy Star. The class D power amplifier has reduced radiated electromagnetic interference (EMI) due to a special feature of the power amplifier, operating in a patented spread spectrum. The power amplifier protects itself from over-temperature, over-current, over-voltage conditions. The power amplifier will shut itself down during these conditions.

Infrared Wireless Microphone / "Auxiliary Input"

A 3.5mm connector is available to connect an infrared receiver. This receiver picks up an infrared signal from a special wireless microphone. The wireless microphone is interrupted by priority audio. There is a level adjustment pot on the circuit board to balance the microphone audio level against other audio input levels. Any line level may be input here.

RS232 Operation (19,200 baud, 8N1) Via the RJ45 (A5) Connection

The RS232 allows remote Self Test, reading of audio current, setting timers, verifying Priority/Normal state and verifying active vs. sleep state. The RJ45 also allows connection to the power input and connection to the normal audio input. An adapter is needed to connect to a male RS232 DB9 connector. An additional adapter is needed to go from the DB9 connector to a USB connector. The computer needs to have the driver for the adapter loaded into the computer. Optional digital volume control is selected via RS232.

IMPORTANT NOTE! This amplifier is intended for audio use only! Continuous sine wave drive into a load will cause the amplifier to shut itself down when it heats up.

SPECIFICATIONS (MODEL AMP1SGRN)

Mechanical “UL rating is dependent upon use of the Backcan and Tile Bridge”

Speaker Diameter	6.5 inches
Weight of Amplifier/Speaker Assembly	2.9 pounds
Height of Amplifier/Speaker Assembly	4.5 inches
Power Supply Weight	0.45 pounds
Power Supply Size	4.7”H x 2”W x 1.2”D
Backcan “Suitable for use in air handling spaces”	UL Listed Enclosure
Tile Bridge “Suitable for use in air handling spaces”	UL Listed Support Truss

Electrical, Power Supply - UL Listed, **Level 5** (Energy Star):

CAUTION: The Power Supply is not to be used in air handling spaces.

Input	100 to 240 VAC, 50-60 Hz, 1.4A
Output	15 VDC, 3.5 amperes

Electrical, Amplifier

Input voltage, nominal	(25 watts) 15 volts DC
Input current, operating (15VDC)	1.667 amperes peak
Input volt-amperes, peak (15VDC)	25 volt-amperes
Input voltage, maximum	16.5 volts, DC

Continues

SPECIFICATIONS (MODEL AMP1SGRN) (Continued)

Electronic, Amplifier

Frequency Response,	
EQ set to flat	50Hz to 15 kHz
Bass	±10dB@50Hz
Treble	±10dB@10kHz
THD + Noise	<1% at 15 watts, “A” weighted
S/N	>90 dB
Max Power Output (15V in)	2 times 16 watts or a total of 32 watts
DC Power, Standby	1.5 watts
AC Power, Sleep Mode (Energy Star)	less than 1 watt
DC Power,	
Short Circuit protected	Yes
Over current protected	Yes
Over voltage protected	Yes
Over temperature protected	Yes
Minimum Load Impedance	4.0 Ω (Two 8 Ω speakers in parallel)
Minimum Input impedance, Priority in	20,000 Ω
Minimum Input impedance, Bal. Line in	820 Ω
Minimum Input impedance, mini-jack	2300 Ω
Dynamic Mic input impedance	300 Ω
Warranty	1 year

Continues

SPECIFICATIONS (MODEL AMP1SGRN) (Continued)

SPEAKER SPECIFICATIONS

Impedance	8 ohms
Sensitivity	87dB SPL 1 w/m
Dispersion	140°
Max. Power	50 watts *
Nominal Power	25 watts
Frequency Response	65 Hz -20 kHz
Woofer Size	6.5"
Tweeter size	0.5"
Dimensions	8.75"
Cut Out Size	7 11/16"
Weight	2.51 pounds

**Note: Maximum power requires the replacement of the 15 volt supply with a 22 volt supply and Energy Star and UL approvals no longer apply.*

End of Specifications

SPEAKER WIRING DIAGRAM

AND "A" DESIGNATOR LOCATIONS

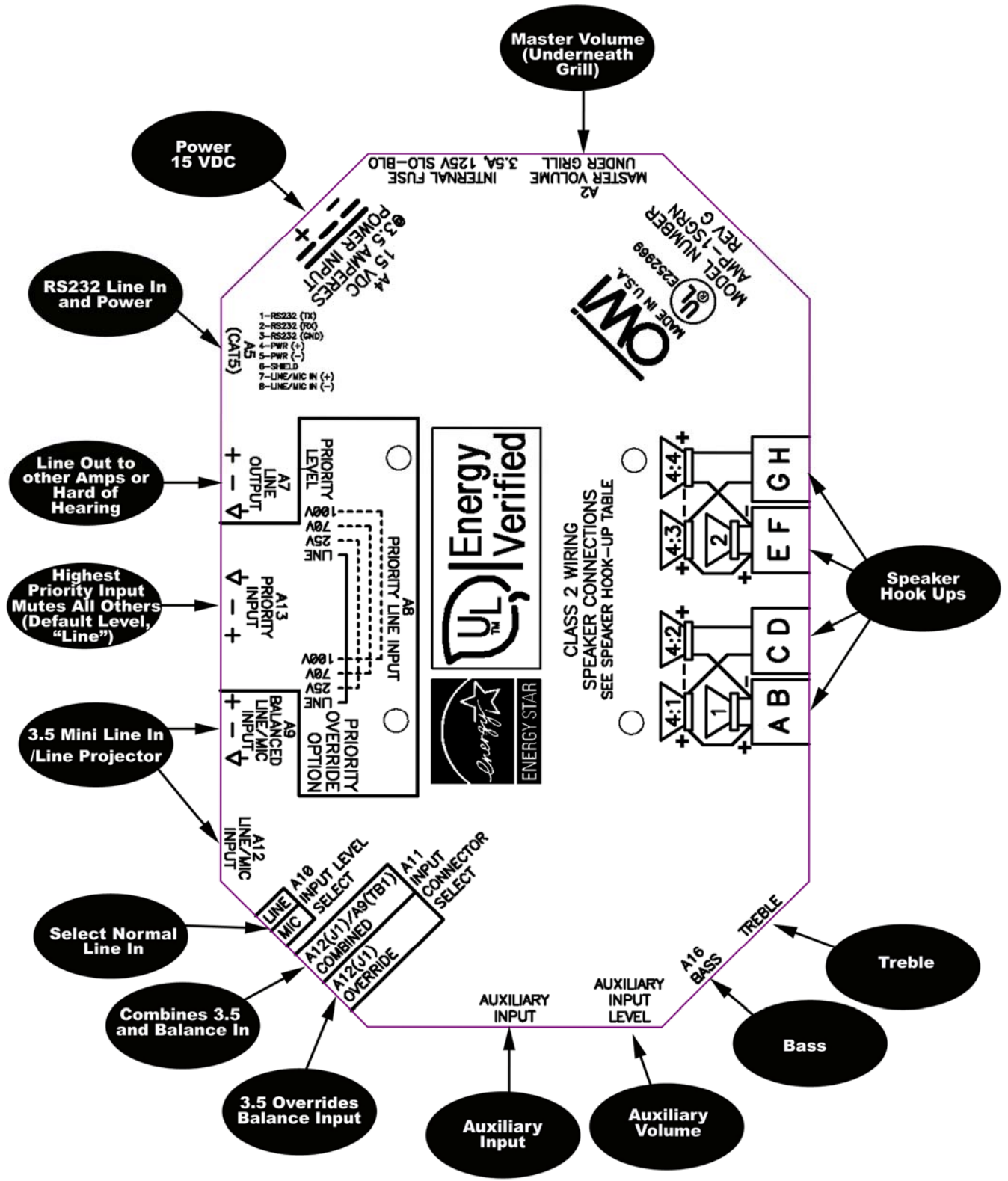

AMPLIFIED SPEAKER TO ANOTHER AMPLIFIED SPEAKER WIRING DIAGRAM

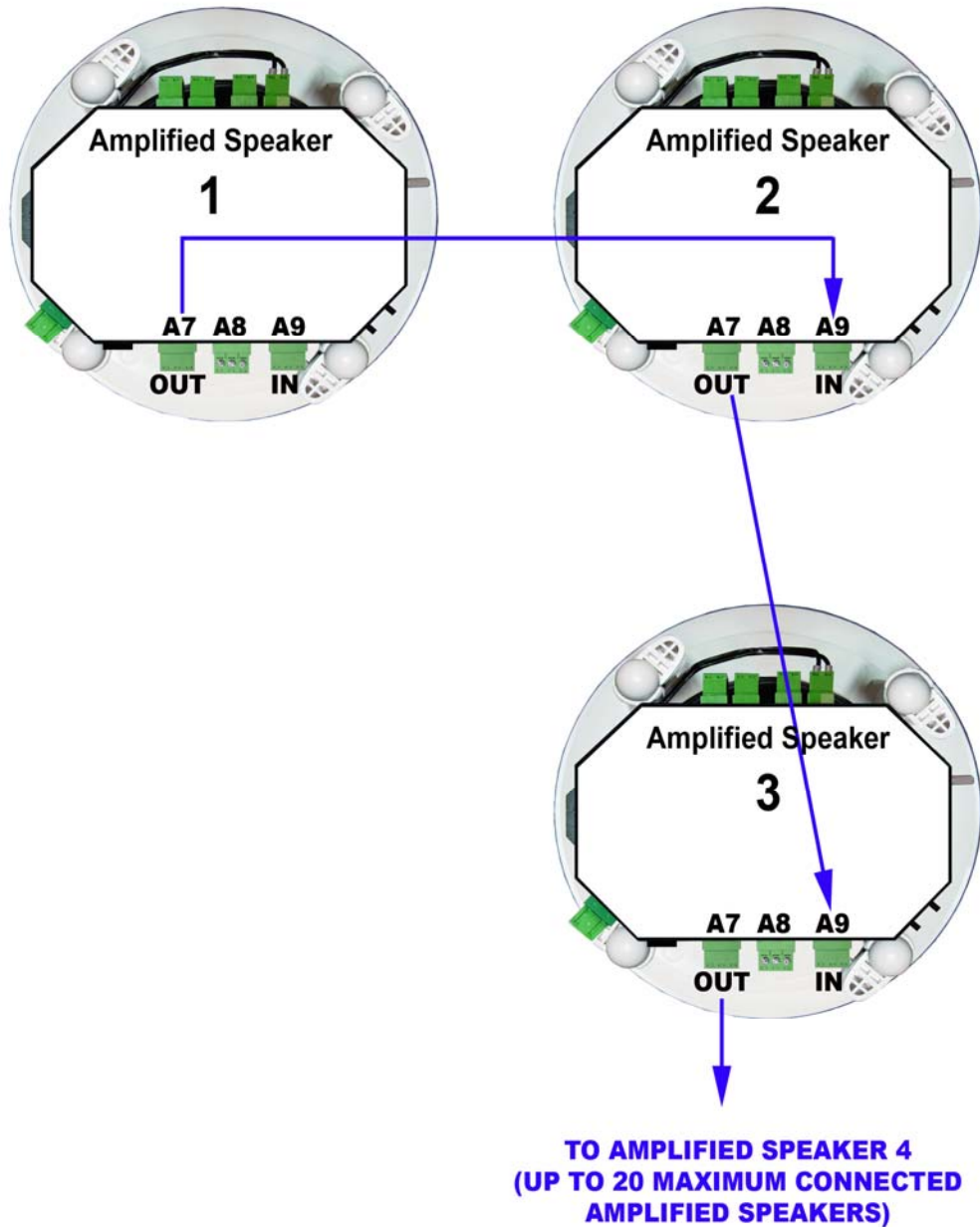

AMPLIFIED SPEAKER TO NON-AMPLIFIED SPEAKER HOOK UPS

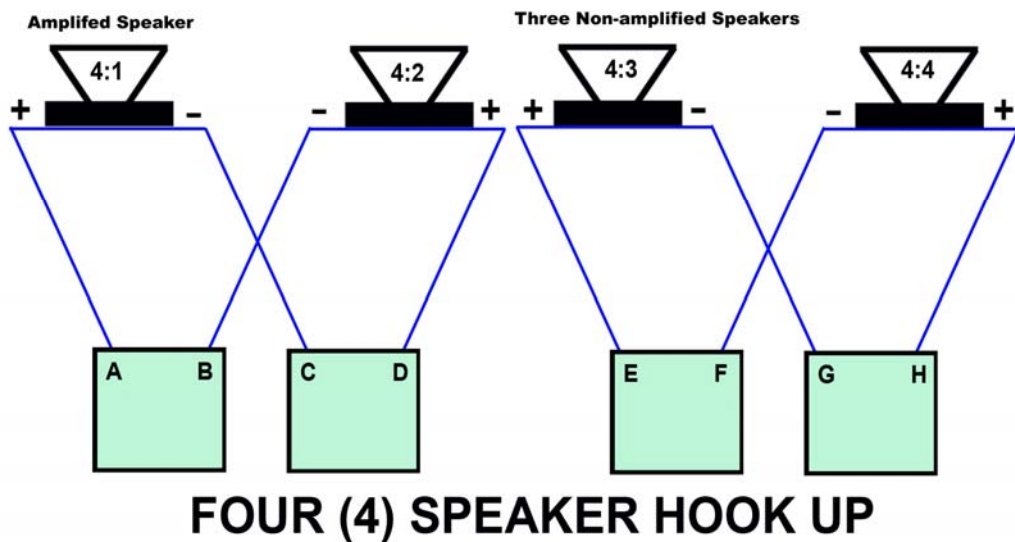
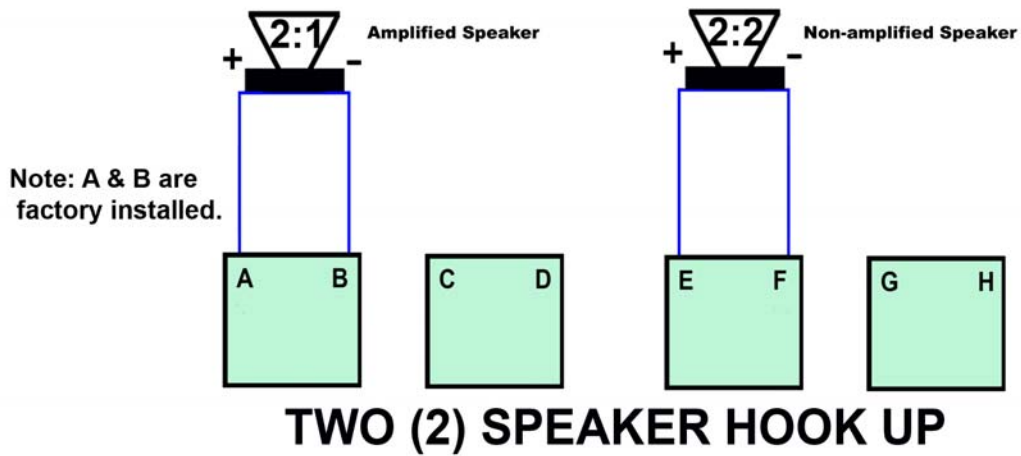
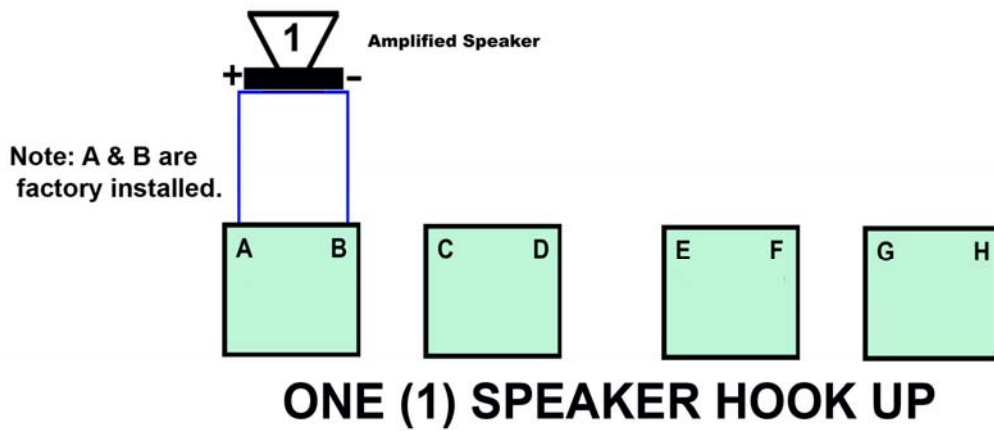

NON-PRIORITY INPUT CONNECTORS WIRING

Note: Auxiliary Input is the same as STEREO LINE IN, immediately below.

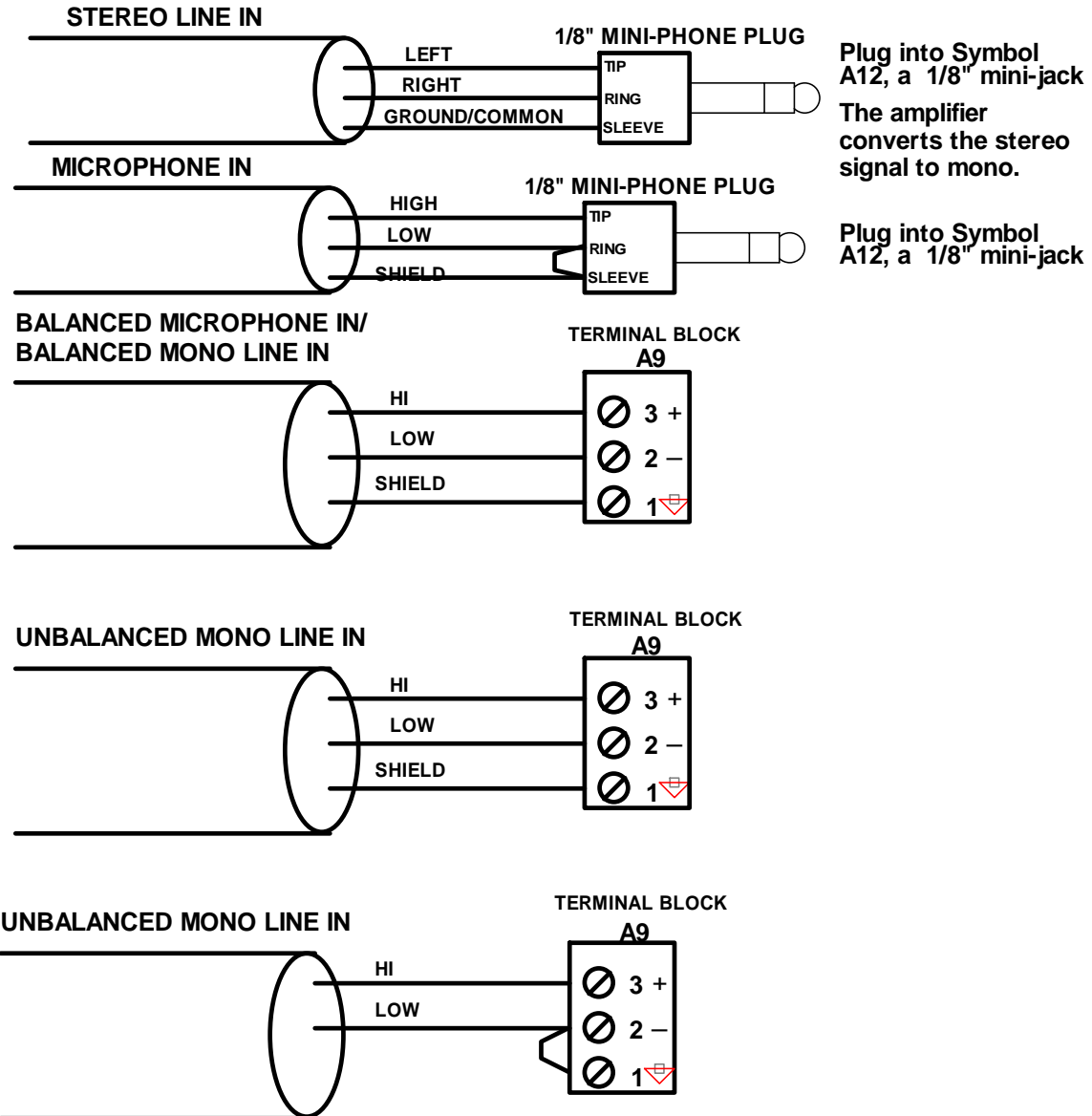

Continued on Next Page

PRIORITY INPUT CONNECTORS WIRING

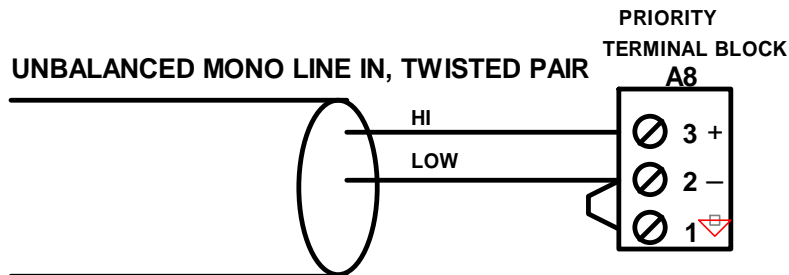
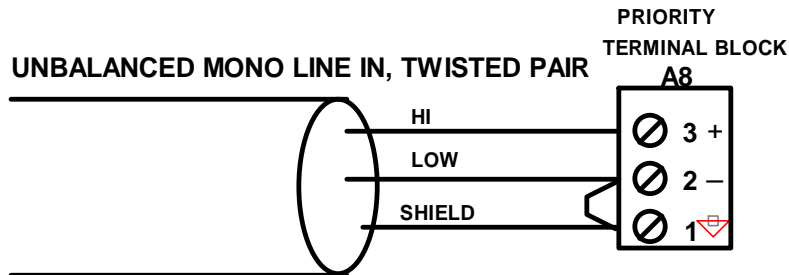
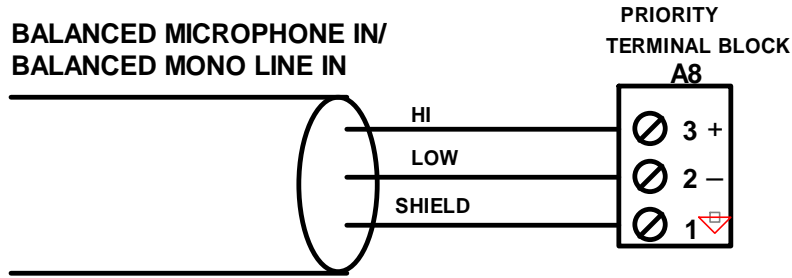

WIRING DIAGRAM: CONNECTOR FOR BALANCED LINE OUTPUT

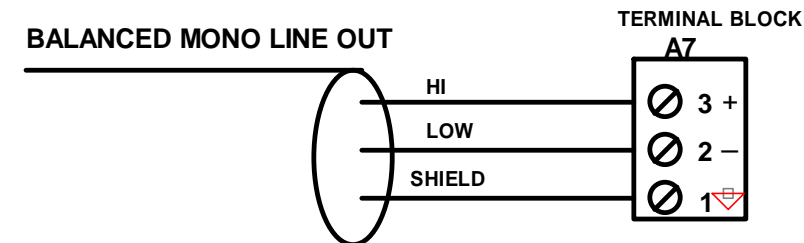

Continued on next page

SPEAKER OUT / RJ45 / POWER WIRING

The SPEAKER OUT terminal block identifiers are AB and EF.
Terminal blocks labeled CD and GH are jumper connectors used for four speaker operation.
See pages 12 and 14 for connection details:

Note: The RS232 connection is made via the RJ45 Connection, below.

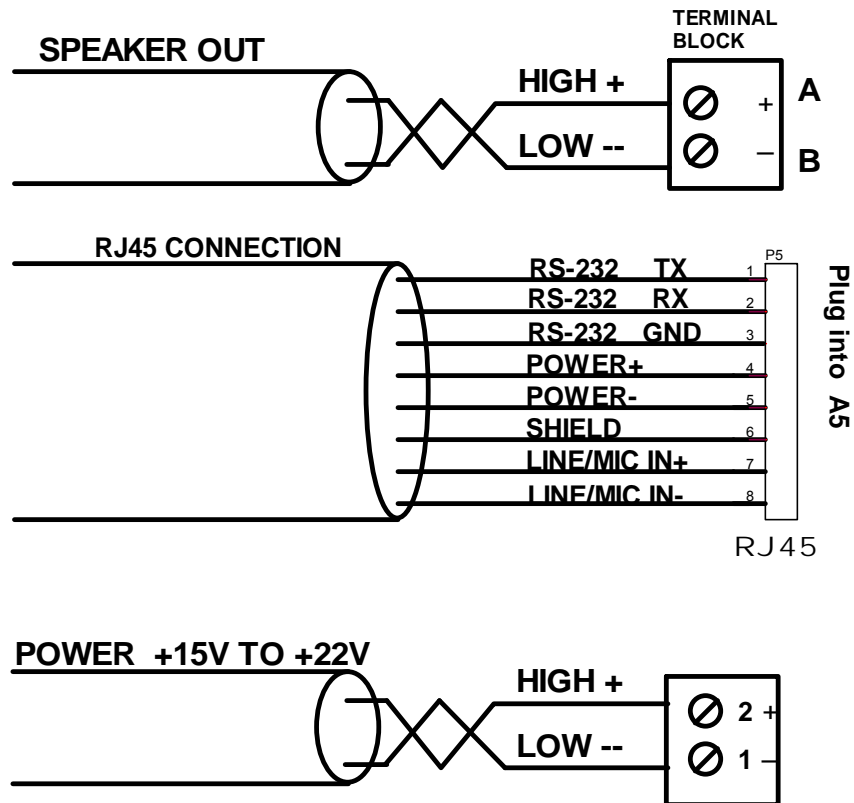





205 Westwood Ave, Long Branch, NJ 07740
Phone: 866-94 BOARDS (26273) / (732)-222-1511
Fax: (732)-222-7088 | E-mail: sales@touchboards.com

RJ45 PIN-OUT

Pin#	Function	Color Code	DE9 (Was DB9)
1	RS232 TX	White/Or	3 Transmit into PC Receive
2	RS232 RX	Orange	2 Receive into PC Transmit
3	RS232 Gnd	White/Grn	5 Ground
4	Power +15VDC	Blue	
5	Power Ground	White/Blu	
6	Shield Ground	Green	
7	Line In+, TB1-3	White/Brn	Non-Priority
8	Line In-, TB1-2	Brown	Non-Priority

Cable Wiring Schemes

TIA/EIA 568B Wiring

1		White and Orange
2		Orange
3		White and Green
4		Blue
5		White and Blue
6		Green
7		White and Brown
8		Brown

Where is pin #1?

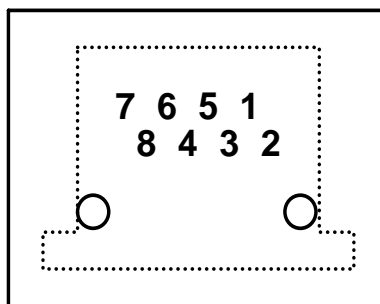
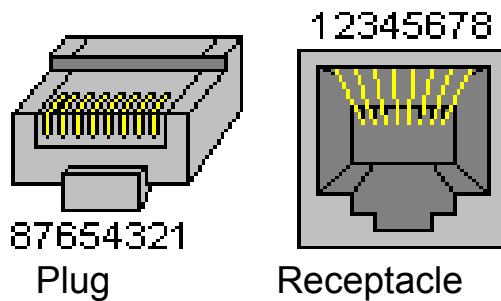

CAT5/CAT3 Jack

Non Traditional **Board Layout**

Note: The RJ-45 connector is on the component side. Shown here are the pins poking through from the component side of the board to the solder side of the board. But the connector pin-out is standard as pictured above.

The Green Speaker Amplifier RS232 firmware

RS232 settings are 19,200 baud, 8 bits, no parity, 1 stop bit (8N1) . N
8,19200,No,1,No

INPUT RS232 COMMANDS:

USER CHOICES MENU (Via Hyperterminal or Putty)

Press:

0 For self test

1 To set time after audio stops and before sleep, in 2 to 30 minutes.

Note: energy star maximum is 30 minutes; factory set time is 2 minutes.

2 To set delay time (2 to 60 seconds) for priority to normal delay.

3 To switch volume control from under the grill to RS232 control.

4 Future.

Note: to change audio volume press 1 (down) or 2 (up) outside of this menu.

5 To set/reset optional solid state relay.

6 To see moving display of relative power amplifier current.

7 To reboot.

8 Future.

9 To return to main (necessary to see selection results.)

T For time until sleep in seconds.

Note: you will have 1 minute to make a choice. If the menu times out, press U or u to restart.

0 Self test Supervision The Selftest routine reads the existing audio current, as a reference, then sends a low frequency signal through the power amplifier and reads the resulting current. The difference is compared to a known reference. The self test verifies that a speaker and its cable is okay (only self test with "0").

1 Sleeptime This the time from when audio stops and the unit goes to sleep. Factory set is 15 minutes, Energy star maximum is 30 minutes. Sleeptime is settable from 2 to 30 minutes.

2 Priority-to-Normal delay time. Settable from 2 to 60 seconds. It starts counting when priority audio stops, and flashes the red LED each second. On the computer, time left is shown.

3 RS232 Volume Control Switch chooses between the speaker grill volume control and an electronic volume control allowing 128 volume steps.

4 Future. To set the electronic volume control, press keys 1 and 2 when not in the menu.

5 Solid State Switch Press the 1 key to turn on the relay and 2 key to turn the relay off. The sleep mode overrides the control and turns the relay off.

6 Audio Current Reading Samples power amplifier current twenty times at 1 second intervals.

7 Reboot Restarts the Green's on board computer.

8 Future.

9 Main Return Sends the Green's on board computer to the beginning of the program, "Main".

T Time Until Sleep returns the time until sleep in seconds.

An adapter for the DB9 to USB connection is ATEN UC-232A.

INSTALLATION

NOTE: Installation is to be completed by a qualified electrical technician according to NEC/CEC code and applicable local codes.

Installation Instructions for Speaker Combination Model AMP1SGRN

The AMP1SGRN carton includes:

1. One (1) each AMP1SGRN (In-ceiling “Green” Amplified Speaker)
2. One (1) each UL Listed, Level 5 (Energy Star) Power Supply
3. One (1) each IEC Power Cord
4. Four (4) each Mounting screws
5. One (1) each cardboard template
6. One (1) each User Manual

The AMP1SGRN Combination carton includes items 1 to 6 above plus:

1. UL Listed 8 ohms in-ceiling speaker model IC6
2. UL Listed Backcan Enclosure (See Pages 22 & 23)
3. UL Listed Tile Bridge (See Pages 22 & 23)

**Note: Quantity of Ceiling speakers, tile bridge and backcan depends on the SKU of the AMP1SGRN Combination Program.*

Speaker Placement

Before installing your OWI speakers, consider the placement carefully, taking into effect the location of electrical, plumbing and other fixtures.

Placement in Ceiling

OWI speakers should be located above the primary listening area.

Mounting your OWI speakers

Determine the best area to mount your OWI speakers. It will be necessary to run your speaker wires to that location. This location must be free of obstructions, such as electrical conduits, HVAC ducts, or water lines.

Be sure the mounting surface is between 3/8 and 1 ¼ inches thick and that there is at least a 2 ¾ inch clearance behind the mounting surface. Make sure that no objects block the back of the speaker.

Remove the round cardboard disc from the template supplied and keep it for later use as a paint mask, if you decide to paint your speakers.

Use the template to mark the position for the mounting hole at the selected location. If you are not certain that no obstruction exists (electrical wiring, plumbing, etc.), you should start by cutting a small hole in the center of your penciled mounting hole with a drywall or keyhole saw,

cutting at a 45 degree angle towards the inside of the hole. Cutting a small hole at this angle will make drywall repair much easier. Once you have determined there are no obstructions in your desired mounting location, start cutting the finished hole at a 90 degree angle to the ceiling surface.

Route the speaker wires from your amplifier to your opening. Avoid routing the speaker wire near electrical wires. If you have to run them parallel, make certain to space the speaker wires at least 2 feet from the AC line. Do not nail or staple the speaker wire.

Prepare Your OWI Speakers for Mounting

Insert a paper clip into one of the grille openings, then pull upwards to remove the grille.

Turn the mounting tab 90° and push toward the grill. The grill will safely pop off.

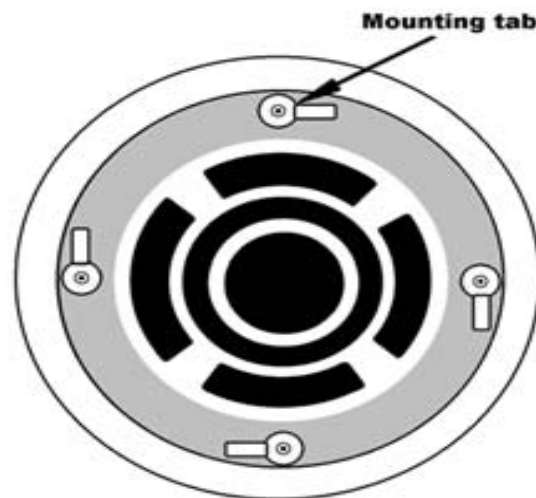
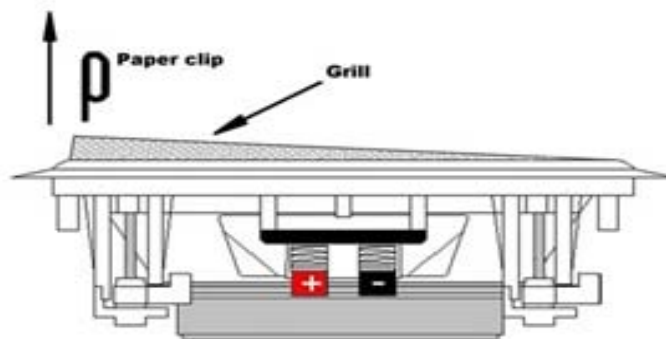

Be sure to position the four Mounting Tabs on your OWI speaker inward then insert the four (4) screws (supplied) from the front of the speaker into the screw opening.

DRYWALL/STUCKO/SHEET ROCKS CEILING ASSEMBLY

The Quick and Easy Way to Install the OWI TB (Tile Bridge) and the Backcan Enclosure with a 6-1/2" or 5-1/4" OWI In-Ceiling Speaker.

1. Position the enclosure over the speaker hole and align it with the screw holes in the tile bridge. Insert and tighten 4 screws through the enclosure into the holes on top of the tile bridge.

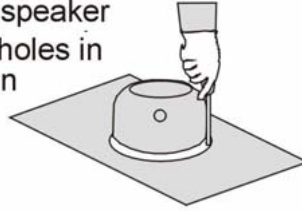

2. Insert and tighten four screws to attach the tile bridge to the beam.

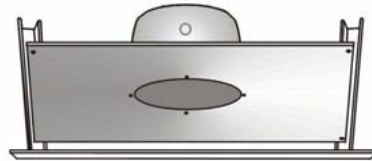

3. After hole is cut in the ceiling, connect the wires and install the speaker by tightening the screws of the four clamps.

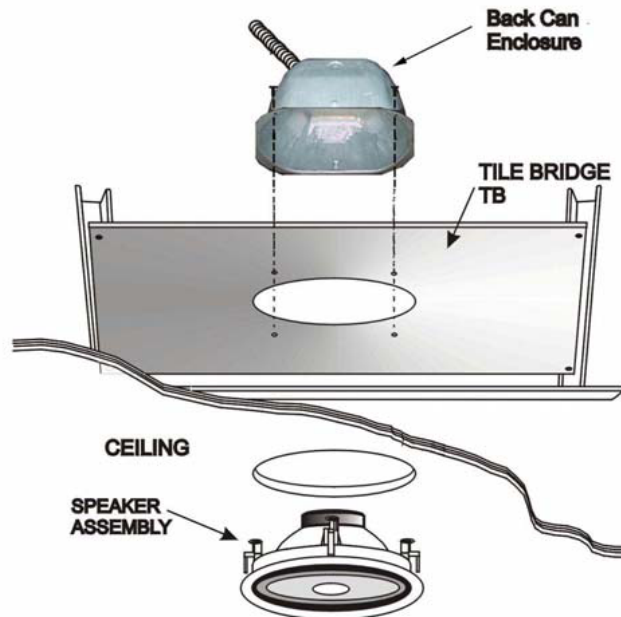
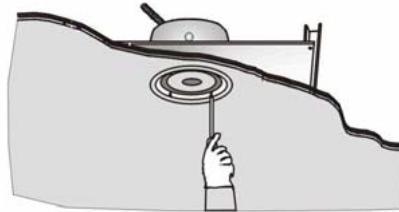

OWI INCORPORATED
17141 Kingsview Avenue, Carson, CA 90746-1207 USA
Tel: 310.515.1900 Fax: 310.515.1606
Email: info@owi-inc.com Website: www.owi-inc.com





OWI INCORPORATED
 17141 Kingsview Avenue, Carson, CA 90746-1207 USA
 Tel: 310.515.1900 Fax: 310.515.1606
 Email: info@owi-inc.com Website: www.owi-inc.com

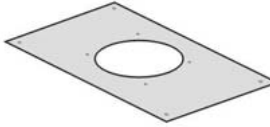
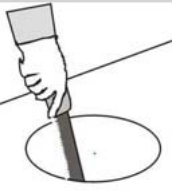
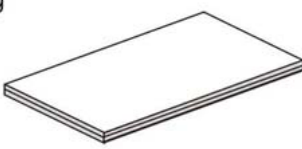
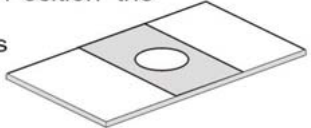
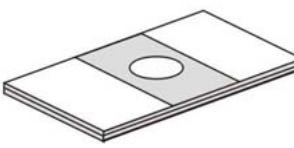
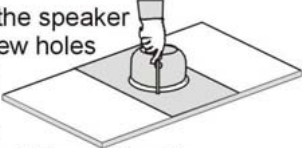
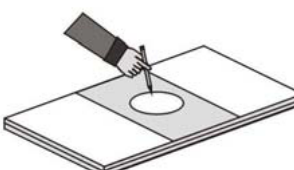
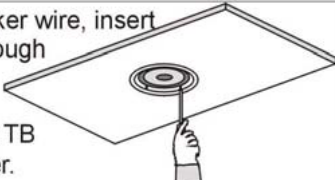

The Quick and Easy Way to Install the OWI TB (Tile Bridge) and the Backcan Enclosure with a 6-1/2" or 5-1/4" OWI In-Ceiling Speaker.
The TB will work on a 2' X 4', 2' X 2' lay-in type ceilings.

<p>1. Use one tile bridge (TB) as a template to make cut outs for all the ceiling tiles.</p> 	<p>5. Remove the template and saw out the circle (speaker hole). Set ceiling tiles aside.</p> 
<p>2. To save time, cut 2 ceiling tiles at the same time. Lay the ceiling tile face to face.</p> 	<p>6. Place one ceiling tile face down on the floor or on top of a table. Position the TB tile bridge across the tile with the speaker holes coinciding with each other.</p> 
<p>3. After finding the center of the ceiling tile, position the tile bridge template across the tile.</p> 	<p>7. Position the enclosure over the speaker hole and align it with the screw holes in the tile bridge. Insert and tighten 4 screws through the enclosure into the holes on top of the tile bridge through the ceiling tile.</p> 
<p>4. Draw a circle using the speaker hole of the template (tile bridge).</p> 	<p>8. After connecting the speaker wire, insert the speaker assembly through the hole and tighten the screws of the 4 clamps. The 4 clamps will hold the TB and the ceiling tile together.</p> 

TEE BAR CEILING ASSEMBLY

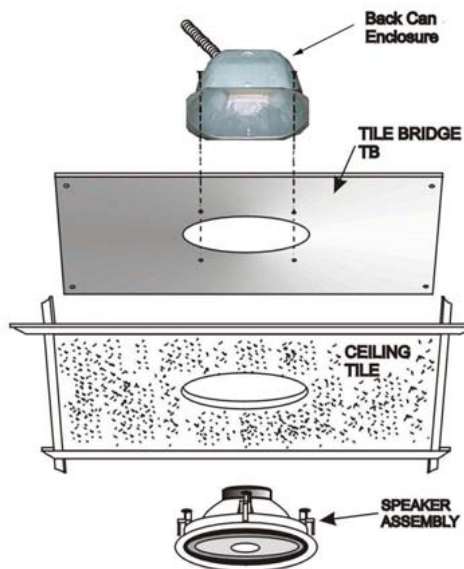

OPERATION

Refer to page 12 for “A” number locations.

- 1.) At location A8 set the dip switches for the expected input audio signal: 100 volts audio, 70 volts audio, 25 volts audio, or LINE LEVEL audio. This is the Priority.
- 2.) Input using a computer brings up the menu and select 2. Set the time, in seconds, from 5 to 60.
- 3.) At location JMP3 (located under the component board, directly under the equalization pots), JMP3 jumper affects the Line Level Output. The Pre-Fader position is not affected by the Master Fader which is the Main Speaker Volume Control. The Post-Fader position is affected by the Main Speaker Volume Control.
- 4.) The slider switch A11 chooses whether both inputs A12 and A9 are available or whether A12 shorts out A9.
- 5.) The slider switch, A10 chooses the expected non-interrupt signal level: microphone level or line level.
- 6.) The condition indicator red/green LED and the Main Speaker Volume Control are on a separate small printed circuit board. The function of the small printed circuit board is allow access to both the Main Speaker Volume Control from inside the grill, and to make the red/green LED visible, from below (ceiling mounted).

The meanings of the LED indications are below.

7.) Condition Indicator LED, Table of States

Normal Operation.....	Steady green
Self Test Result OK	Two blinks of green
Self Test Result Fail.....	Two blinks of red
Sleep Mode.....	Quick green flash
Priority Override	Steady Red
Priority Override Timeout Countdown.....	Red flash every second

8) Version Indicator LED, Power Up Only

Firmware Version Number, First Digit.....	Green flash
Firmware Version Number, Decimal Point...	1 Second pause
Firmware Version Number, Second Digit.....	Red flash

9) Power On Indicator LED, DS2 Power On Indicator (On PCB, Red)

Operation Continues

OPERATION

10) Controls

A2	Main Speaker (Grill) Volume Control
A8	Priority Input Level Select & Input
A10	Non-Priority Input Mic/Line Level Select
A11	Non-Priority Input Select
A16	Bass Adjust, ± 10 dB
Beside A16	Treble Adjust, ± 10 dB
Auxiliary Audio Input Level Set..... (Wireless Microphone)	Located next to A16
Manual Self Test.....	Located on the "Self Test" option board

- 11) Self-Test Details. Self-Test can be manual or computer triggered. This test looks for disconnected speakers or speakers whose voice coil is open. The test supplies a low frequency sine wave to the power amplifier. The current drawn by the unit due to the signal going through the speakers is monitored. If at least one 8 ohm speaker is connected, the circuit will test and the green LED indicator will flash four times. Otherwise, the Red LED will flash four times. Also, the unit will output an RS232 signal: "Self Test is OK" if good and "The self test failed", if bad. The test signal is approximately 20 to 25 Hertz, and at a very low level. A push button, located on the "Self Test" option board, allows a manual initiation of self-test with the same indications. The baud rate of the RS232 signal is 19,200. The protocol is 8 N 1 (8 data bits, no parity and 1 stop bit).
- 12) Priority return to Line input delays is settable by computer from 5 seconds to 60 seconds.
- 13) Sleep Mode: During this mode, the unit draws less than 1 watt from the power supply, and thus qualifies for the "Energy Star" rating.
- 14) Priority Override: Additional notes: During priority override, A9, A12 inputs are switched off. When the audio priority ceases, a timer begins to count second by second. When the timer reaches the preset time, the unit returns to the non-priority input. But, if during the timer operation, the priority audio reappears, the unit's input is immediately switched back to the priority and the timer is reset.

Notes: There are two master volume controls: one on the main circuit board and one on the small, attached circuit board with the LED on it, this is the primary control. If the Priority Level pot is at minimum, the Priority Interrupt becomes Priority Mute, where all audio is suspended so that another system can send Priority Audio.

The RS232/RJ45 connections are shown on Page 17

NOTE: RS232 Operation is detailed on pages 18

MAINTENANCE

The primary preventative maintenance is to make sure that that the power supply and unit are powered and that all connections are secure.

TROUBLE SHOOTING GUIDE

No Audio

Look at the Control Indicator LED for at least 15 seconds, if it doesn't light at all there may be a power failure. Check circuit breakers. Check to see that the unit's DC power supply is plugged in to the AC power. Check to see that the power supply's DC connector plug is secured onto the wire and then check to see that it is plugged into the unit's DC input connector.

You Have Power but No Audio

- >Check for disconnected speakers or open voice coil.
- >If the LED is briefly flashing every few seconds, the unit is in sleep mode because no audio is being sensed at either **Normal** input, **Auxiliary** input or the **Priority** input.
- >Initiate self test. If the LED blinks red, check the cables running to the speaker(s).
- >If the LED is blinking red every second, it is recovering from a Priority Override. When it times out, and there is non-priority, audio, you should hear audio. If still no audio, the non-priority audio may be silent, but the LED should be green, awaiting the resumption of audio.

You want to verify unit start-up and possibly the firmware revision number.

Interrupt the AC or DC power, wait 10 seconds, then turn the power back on again, and then look at the Control indicator LED. You should see one of the following the sequence:

Version No.:

Firmware Version Number, First Digit..... Green flash

Firmware Version Number, Decimal Point..... 1 second pause no LED on.

Firmware Version Number, Second DigitRed flash

Pause

Steady Green

The unit then should be operational.

End of Manual Text

Model: AMP1SGRN



205 Westwood Ave, Long Branch, NJ 07740
Phone: 866-94 BOARDS (26273) / (732)-222-1511
Fax: (732)-222-7088 | E-mail: sales@touchboards.com