



User Manual

AMPMA70V40

OWI 70V 40W Digital Mini Amplifier



IR Remote Control Model AMPIRMA70V40

All Rights Reserved
Version: AMPMA70V40V2013V1.0



205 Westwood Ave, Long Branch, NJ 07740
Phone: 866-94 BOARDS (26273) / (732)-222-1511
Fax: (732)-222-7088 | E-mail: sales@touchboards.com

70V 40W Digital Mini Amplifier

NOTICE: Please read this user manual carefully before using this product.

This manual is only for operation instruction only, not for any maintenance usage. The functions described in this version are updated until May, 2014. Any changes of functions and parameters since then will be informed separately. Please refer to the dealers for the latest details.

This manual is copyrighted by OWI Inc.. All rights reserved. No part of this publication may be copied or reproduced without the prior written consent of OWI Inc..

All product function is valid until 2014-05-03.

Update History

Version	Date	Update Content
1.0	2013.05.03	First version.

Table of Contents

1. Introduction	1
1.1 Introduction to AMPMA70V40.....	1
1.2 Features.....	1
1.3 Package Contents.....	1
2. Introduction of Product Appearance.....	2
2.1 Introduction of Front Panel	2
2.2 Introduction of Rear Panel	3
3. System Connection	4
3.1 Usage Precautions	4
3.2 System Diagram	4
3.3 Audio Signal Connection.....	4
3.3.1 Audio Output.....	4
3.3.2 Audio Inputs	5
3.4 System Applications.....	6
4. System Operations.....	6
4.1 Operations of Front Panel.....	6
4.1.1 Audio switching.....	6
4.1.2 Volume/EQ controlling.....	7
4.2 Operations of IR Remote	7
4.3 Operations of Control Software	8
4.3.1 Connection with Computer	8
4.3.2 Installation/uninstallation of RS232 Control Software	8
4.3.3 Running Environment	9
4.3.4 Function Settings.....	9
4.3.5 RS232 Communication Commands.....	10
5. Specifications	12
6. Panel Drawing.....	13
7. Remote Control AMPIRMA70V40	13
8. Troubleshooting and Maintenance.....	13
9. Safety Operation Guide.....	18
10. After-sales Service	19

1. Introduction

1.1 Introduction to AMPMA70V40

AMPMA70V40 is a 40 Watt power amplifier (Class-D) with output alternatively at 70V or 100V. It has 2 stereo inputs (1x3.5mm jack for line in, 2xRCA for L&R), 1 digital input & 1 balanced MIC. It is integrated with powerful functions, including ducking function, EQ control, MIC mixer etc, and MIC input supports 3 levels with condenser MIC, dynamic MIC & line audio input.

As for power amplifier we have normally voltages at 70V and 100V for different countries, but AMPMA70V40 is designed to integrate with both voltages to meet different requirements.

1.2 Features

- Mono audio output at 40Watt.
- Switchable between 70V and 100V.
- Ducking function.
- 16 ID codes for controlling between different AMPMA70V40 amplifiers.
- 3-level MIC input, supports condenser microphone, dynamic microphone and wireless microphone.
- MIC port can support balance/unbalance signal, suppress the external noise effectively.
- Two stereo audio inputs and one digital audio input, switchable by button, IR remote & RS232.
- Volume/Bass/Treble controllable by buttons, IR remote & RS232.
- Fast switching speed for good performance.
- Convection cooler, fan is not needed.
- LED indicator, for power and working status.
- Antistatic case design to provide good protection for long-term and stable performance.

1.3 Package Contents

- 1 x AMPMA70V40
- 1 x Power adapter (DC 24V)
- 2 x Mounting ears (separated from AMPMA70V40)
- 1 x RS232 cable
- 1 x IR remote
- 1 x IR receiver
- 4 x Screws
- 1 x User manual

Note: Please confirm if the product and the accessories are all included, if not, please contact with the dealers.

2. Introduction of Product Appearance

2.1 Introduction of Front Panel



Figure 1 Front Panel

No.	Name	Function
①	Audio Input Selection	To select the input audio source, after choosing the audio source, the corresponding LED indicator will be on. No.1 is for dual mono audio input (2 RCA connectors for L&R), No.2 is for stereo audio input (3.5mm mini jack), and No.3 is for digital fiber audio input.
②	Audio Control	Adjust the volume of the MIC, Line, or the level of Bass and Treble with this button
③	Volume Adjustment	To turn up/down or mute the corresponding audio. ▽ : Turn down the volume △ : Turn up the volume MUTE: Mute the output

2.2 Introduction of Rear Panel

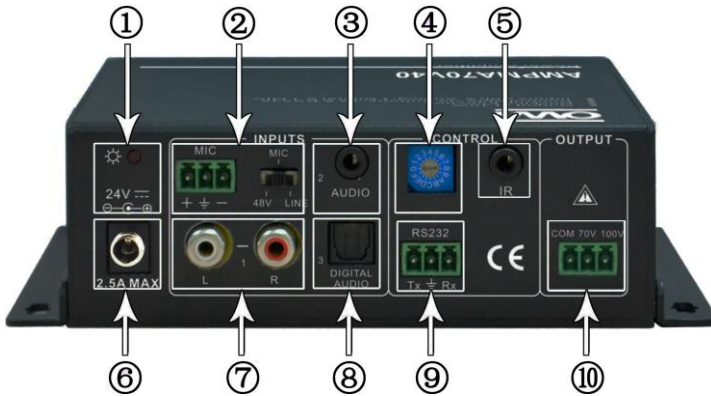

Figure 2 Rear Panel

No.	Name	Function
①	Power Indicator	Turns red when power on.
②	Microphone input port	3-pole captive screw connector for microphone input, the dial switch in right side is to select the micro input kind, including 48V (for condenser microphone), MIC (for dynamic microphone) and LINE (for line audio).
③	Audio Inputs	3.5mm mini jack for stereo audio input, it can be connected with audio source device such as DVD player.
④	ID Code	16 codes range from 0 to F (hexadecimal), works together with the PC control software.
⑤	IR Eye	To connect with the IR receiver, works together with the IR remote.
⑥	Power Port	To connect with the power adapter (DC24V).
⑦	2 x RCA	Dual-mono audio input, which can be connected with audio source device such as a PC.
⑧	Digital Audio Input	Fiber connector for digital audio input, it can be connected with a device with fiber port, such as blue-ray player.
⑨	RS232	3-pole captive screw connector for serial control, it can be connected with PC (Use a 3-pole captive to 9 pin female D connector and serial control software) to control AMPMA70V40.
⑩	Audio Output	To connect with audio output devices, such as speakers (To select 70V or 100V depends on the input voltage of the speakers). COM is for grounding (GND).

70V 40W Digital Mini Amplifier

3. System Connection

3.1 Usage Precautions

- 1) No working with empty load is allowed.
- 2) Speakers must be connected before power on.

3.2 System Diagram

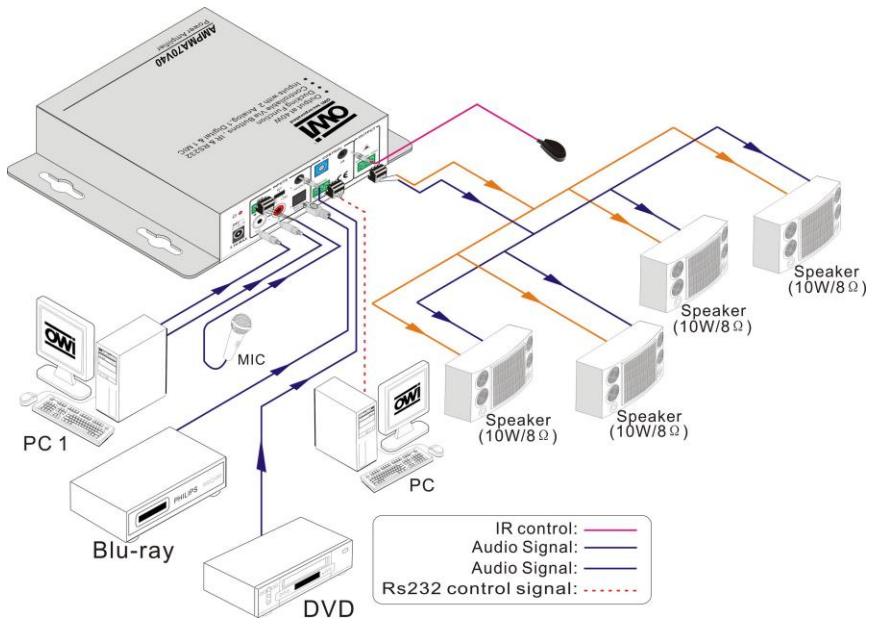

Figure 3 System Diagram

3.3 Audio Signal Connection

3.3.1 Audio Output

AMPMA70V40 supports mono audio output, and the output voltage is 70V or alternative 100V. With its dual-purpose design, it can be applied in different areas. The end COM is for grounding. The amplifier to be connected is mono audio output with a rated power at 40Watt, so AMPMA70V40 can be connected with several speakers in parallel connection way (Total power mustn't be more than 40Watt).

The following figure shows us how to connect with the speakers. Here we take the speakers 10Watt@8Ohms for each as example.

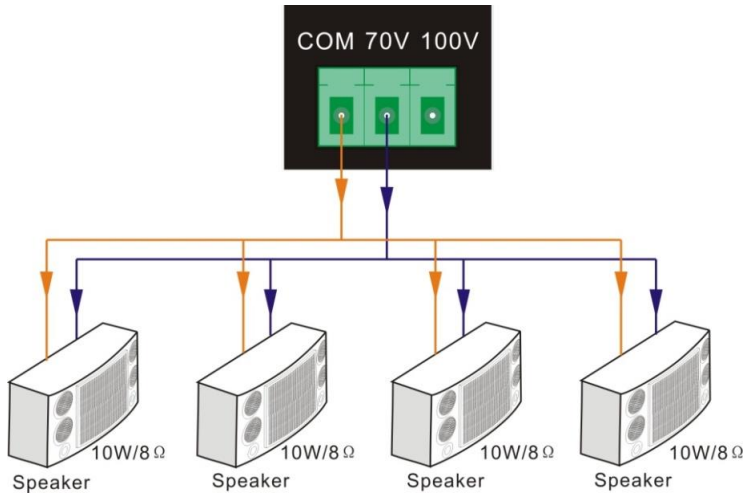

Figure 4 Audio Output Connection

3.3.2 Audio Inputs

AMPMA70V40 provides with 2 stereo audio inputs, one microphone input and one digital fiber audio input. The following figure shows the audio input ports.

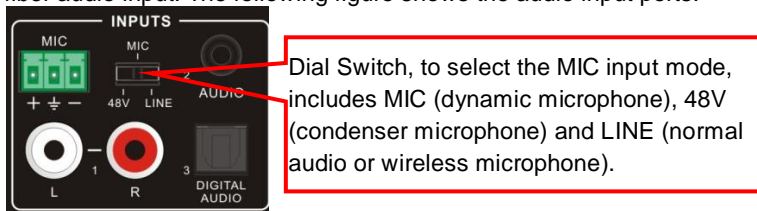

Figure 5 Audio Input Ports

➤ **48V phantom power input**

When the switch turns to “48V” (It has a good frequency characteristic, high input impedance and high sensitivity in this mode), the MIC input will provide a 48V phantom power. This is usually used for power supply for condenser microphone, Connection is: “+” connects to positive, “-” connects to negative and “ \equiv ” to ground.

Note: In this mode, only condenser microphone can be connected with.

➤ **MIC input**

When the switch turns to “MIC” (It has a low frequency characteristics, and wide frequency response in this mode), the microphone input is used for connecting with dynamic microphone. There are two different connections:

a) Unbalanced connection:

“+” and “ \equiv ” connect to ground, and “-” connects to signal.

70V 40W Digital Mini Amplifier

“-” and “” connect to ground, and “+” connects to signal.

b) Balanced connection: “+” connects to positive, “-” connects to negative and “” connects to ground.

➤ LINE input

When the switch turns to “LINE” (It has a low frequency characteristics, and wide frequency response in this mode), the microphone input is used for connecting with normal audio or wireless microphone output. There are two different connections:

a) Unbalanced connection:

“+” and “” connect to ground, and “-” connects to signal.

“-” and “” connect to ground, and “+” connects to signal.

b) Balanced connection: “+” connects to positive, “-” connects to negative and “” connects to ground.

● Digital Audio Input

AMPMA70V40 provides with a fiber optical port to connect with digital audio source device. With the SPF optical fiber, the audio signal can be transmitted faster, more stable, reliable, and can be transmitted over a long distance without distortion.

3.4 System Applications

AMPMA70V40 can be applied in different occasions, such as classroom, small meeting room, lecture hall, bar and hotel etc.

4. System Operations

4.1 Operations of Front Panel

The buttons provides the control of volume/EQ control and switching. The LED indicator will show the connecting status. The following content introduces audio switching and EQ control in detail.

Operations: Press the corresponding button again for cyclic switching.

4.1.1 Audio switching

There are three switchable audio inputs, one 2xRCA input, one 3.5mm jack input, and one digital fiber audio input, switchable through the buttons as below:

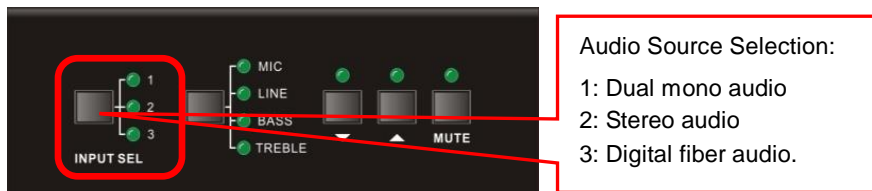

Figure 6 Audio Source Selection Button

70V 40W Digital Mini Amplifier

4.1.2 Volume/EQ controlling

The line volume and MIC volume can be controlled by the buttons.

The MIC Volume/LINE volume/LINE bass/LINE treble will be selected by the buttons, and controlled up/down/mute by the function buttons. Please check the picture below:

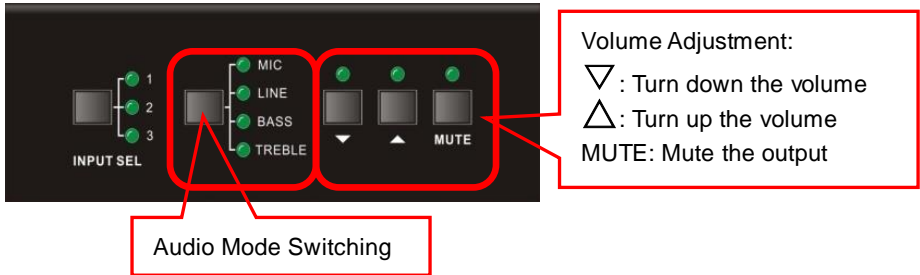

Figure 7 Audio Mode and Volume Adjustment buttons

For example, to turn up the line volume, you should select the “LINE” first, and then press the button “▲”.

4.2 Operations of IR Remote

AMPMA70V40 provides with an IR eye, with the IR Receiver and the IR remote, user can control AMPMA70V40 remotely.

Notice: The IR Receiver and the IR remote are all offered for charge.

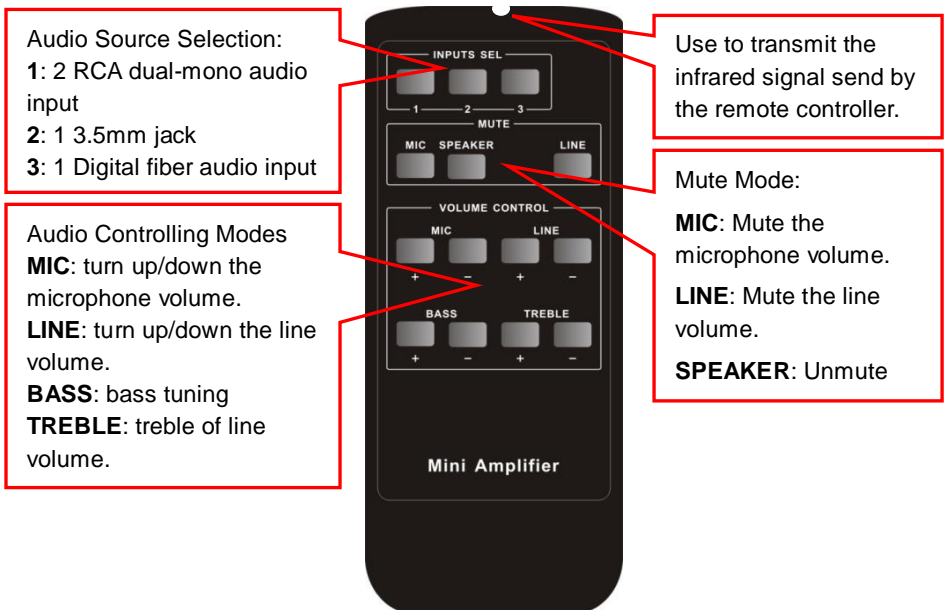

Figure 8 IR Remote

70V 40W Digital Mini Amplifier

IR receiver, works together with the IR remote. Please point the IR remote at the IR receiver when use, to avoid getting out of control as there is no signal detected.



3.5mm jack Insert it into the specialized AMPMA70V40 socket (3.5mm), to connect the IR receiver with AMPMA70V40.

Figure 9 IR Receiver

4.3 Operations of Control Software

4.3.1 Connection with Computer

When the amplifier connects to the COM1 or COM2 of the computer with control software, users can control it by that computer.

To control the amplifier, users should use a 3-pole male captive screw to 9-pin HD female connector and use the public COM software.



Figure 10 Connection of RS232 Port

4.3.2 Installation/uninstallation of RS232 Control Software

● Installation

- Connect the input source devices and the output device according to the system diagram.
- Copy the RS232 control software to one computer, and then connect the RS232 port of this computer and AMPMA70V40.
- Double-click the EXE program to execute the software.

Here we take the software **CommWatch.exe** as example. The icon is showed as below:



Figure 11 Control Software

- **Uninstallation** Delete all the control software files in corresponding file path.

70V 40W Digital Mini Amplifier

4.3.3 Running Environment

While the control software is installed, we can activate the software through the RS232 port and set the parameters, to make it able to send RS232 commands to control AMPMA70V40.

4.3.4 Function Settings

With the control software, we can easily switch the input channel, mute the output, check the working status, and adjust the volume etc. Please refer the details in *RS232 Communication Commands*.

The interface of the control software is showed as below:

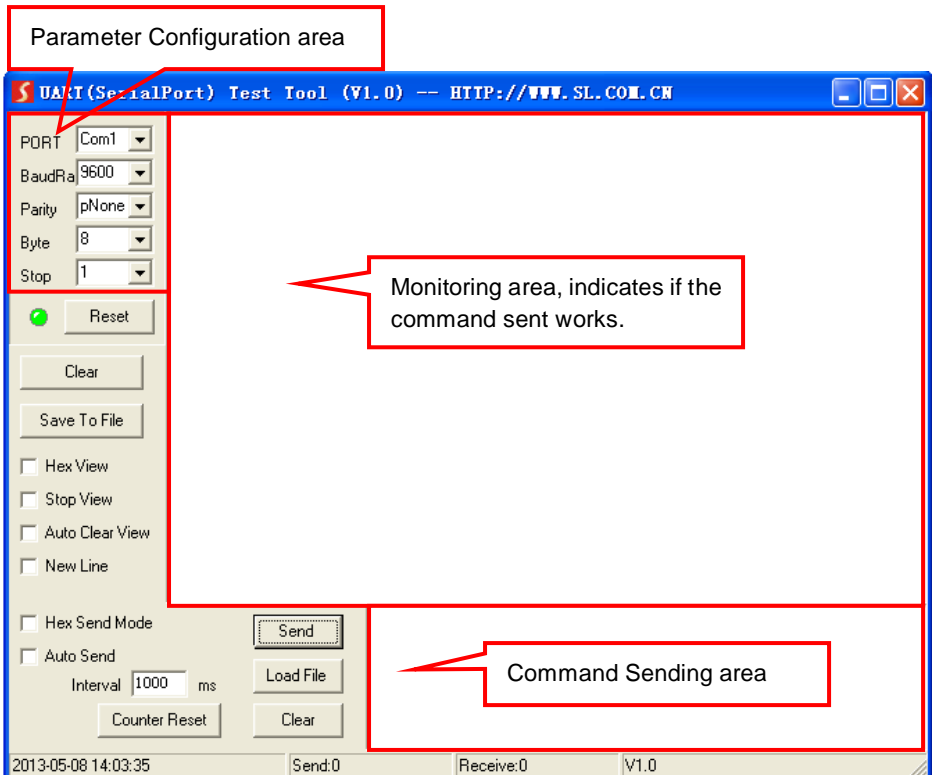

Figure 12 Main Interface of Control Software

70V 40W Digital Mini Amplifier

4.3.5 RS232 Communication Commands

Communication Protocol: RS232 Communication Protocol

Baud rate: 9600 Data bit: 8 Stop bit: 1 Parity bit: none

Command	Function Description	Feedback Code
1A1.	Switching the audio to input 1	A: 1 -> 1
2A1.	Switching the audio to input 2	A: 2 -> 1
3A1.	Switching the audio to input 3	A: 3 -> 1
0A0.	Mute Audio of MIC and Line out	Mute
1A0.	Mute audio of MIC	Mute MIC
2A0.	Mute audio of line out	Mute LIN
0A1.	Unmute Audio	Unmute Audio
600%	Checking the working status	A: 1 -> 1 Volume of MIC : 50 Volume of LINE : 50 Bass of LINE : 4 Treble of LINE : 4 Ducking Off
601%	MIC volume up	Volume of MIC: 51
602%	MIC volume down	Volume of MIC: 51
603%	Line volume up	Volume of LINE: 51
604%	Line volume down	Volume of LINE: 51
605%	Bass level up	Bass of LINE: 4
606%	Bass level down	Bass of LINE: 4
607%	Treble level up	Treble of LINE: 4
608%	Treble level down	Treble of LINE: 4
609%	Initialization, back to the default setting	Init OK
610%	Enable/disable the ducking function.	Ducking off/Ducking on
4[x][x]%	Preset the volume level of ducking function. [xx] arranges from [00] to [60]. 61 degrees in total.	Ducking of LINE: 50
5[x][x]%	Preset MIC volume, [xx] arranges from [00] to [60]. 61 degrees in total.	Volume of MIC: 50
7[x][x]%	Preset line volume, [xx] arranges from [00] to [60]. 61 degrees in total.	Volume of LINE: 50
8[x][x]%	Preset the bass level, [xx] arranges from [00] to [08]. 9 degrees in total.	Bass of LINE: 4
9[x][x]%	Preset the treble level, [xx] arranges from [00] to [08]. 9 degrees in total.	Treble of LINE: 4

Notice:

1. The letter inside bracket [] is the variable code, which is changeable.
2. The bracket [] is not included to the RS232 commands.
3. Any dot "." after the letters is part of the commands.

4. Ducking function:

When input with MIC, the volume of the line audio will be automatically turned down to the preset volume level, if there is no input MIC audio signal after 5 seconds, then the volume will be automatically turned up to the original one. If you need to disable/enable the ducking function, just send the command "**610%**" again.

5. ID coding

The ID codes of AMPMA70V40 ranges from 0 to F (hexadecimal), when sending RS232 commands, please take notice of the address of the ID code.

If the address of the ID code is **0**, any RS232 command is available.

If the address is in **1~F**, it has one unique ID code (If the ID code is not the same with the address, no RS232 command will work).

While the ID code is in **1~F**, please add "**ID/**" before sending the command.

For example, if the ID code is **5**, the RS232 command needed is "**604%**", the correct command is in this format: **5/604%**.

There is no need to add "**ID/**" before the command when the ID code is **0**.

Examples:

- 1) Switching the input 2 to the line out, the command is: **2A1**.
- 2) Turning up the volume of line audio, the command is: **603%**
- 3) Preset the MIC volume to "21" degree, the command is: **521%**
- 4) Checking the working status of AMPMA70V40, the command is: **600%**
- 5) If the ID code is **0**, sending command **601%** is able to turn up the MIC volume.
If the ID code is **2**, sending command **601%** will not work, and the MIC volume remains unchanged. The right command is **2/601%**.

5. Specifications

Audio Input		Audio Output	
Input	2 stereo audio 1 MIC 1 Digital fiber audio	Output	1 mono amplifier
Input Connector	2 RCA 1 3.5mm jack 1 3-pole 3.81mm captive screw connector 1 SPF fiber connector	Output Connector	1 3-pole 3.81mm captive screw connector
Input Impedance	>10KΩ	Output Type	Constant voltage 70V or 100V.
Audio General			
Frequency Response	120Hz ~ 20KHz	CMRR	>70dB@20Hz~20KHz
SNR	80dB (Max)	Bandwidth	120Hz ~ 20KHz
Rated Power Output	40Watt @8Ohms	THD + Noise	1%@1KHz, 0.3%@20KHz at nominal level
Voltage Gain	26dB		
Control Function			
RS232 Control	1 3-pole 3.81mm captive screw connector	Front Panel Control	buttons
ID Code Control	16 ID codes for control		
IR remote	14 Button Control (Powered by one lithium battery Model CR2025 - not included)		
General			
Temperature	-20 ~ +70°C	Humidity	10% ~ 90%
Power Supply	DC 24V power adapter	Power Consumption	5W
Case Dimension	6 1/32" (153mm) W x 1 47/64" (44mm) H x 5 43/64" (144mm) D	Product Weight	1.89 lbs (0.86Kg)

6. Panel Drawing

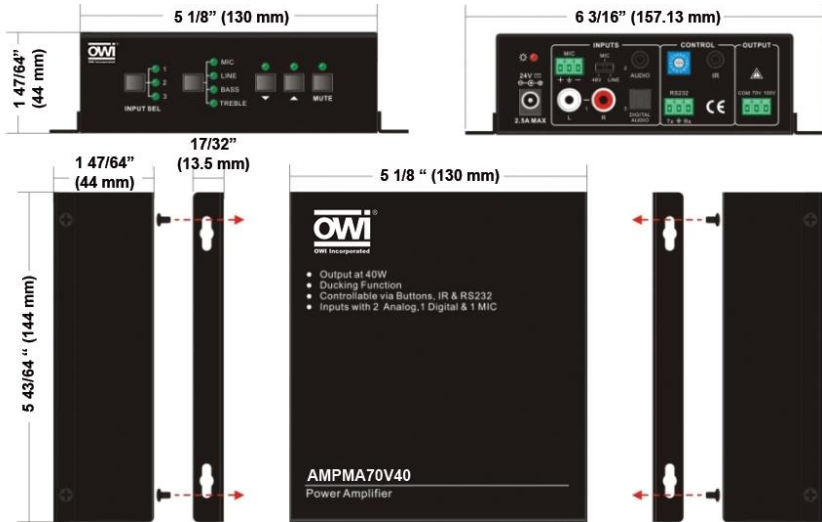

Figure 13 Panel Drawing

7. Remote Control AMPIRMA70V40



1. IR Receiver

1) Specification

- Case dimension: W40 x L30 x D15 mm
- Working Voltage: 2.5V~5V
- Cord Length: 1.5m
- Effective Receiving Range: 7m

70V 40W Digital Mini Amplifier

2) Appearance Description



Notes:

The IR receiver works tighter with the IR remote. You need to point the IR head of the IR remote at the IR receiver when using, to avoid getting out of control.

3) Usage of IR Receiver

Plug the receiver jack into the specialized AMPMA70V40 socket (3.5mm, marked with IR), to connect the IR receiver with AMPMA70V40. Then it is able to control AMPMA70V40 by receiving IR signal.

2. IR Remote

1) Specification

- Case Dimension: W125 x L51 x D10 mm
- Power Consumption: DC 3V
- Buttons: 14 in total
- Button Material: rubber
- Powered by one lithium battery, model name CR2025. (Battery not included).

70V 40W Digital Mini Amplifier

2) Appearance Description

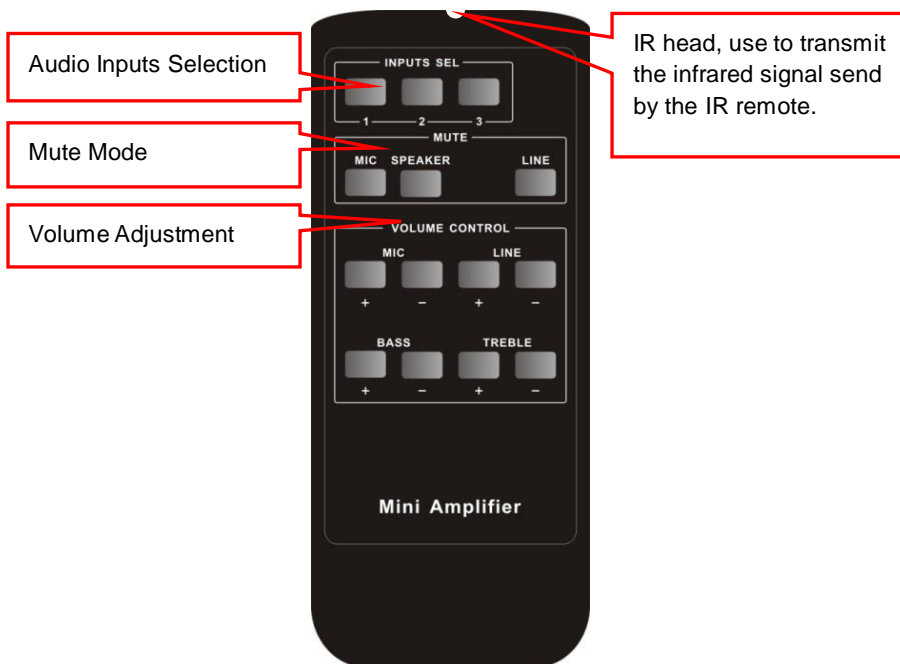

3) Audio Inputs Selection

There are 3 kinds of audio inputs:

- 1: 2xRCA dual-mono audio input
- 2: 3.5mm stereo audio input
- 3: digital fiber audio input

Operation: Select the wanted audio source, and press the corresponding button, then it will switch to this input and then to output.

4) Mute Mode

- **MIC:** Mute the microphone volume.
- **LINE:** Mute the line volume.
- **SPEAKER:** Unmute

Operation: Press the button MIC/LINE to mute the MIC/LINE volume, and press the button SPEAKER to unmute the present volume.

70V 40W Digital Mini Amplifier

5) Volume Adjustment

- **MIC:** turn up/down the microphone volume.
- **LINE:** turn up/down the line volume.
- **BASS:** bass tuning
- **TREBLE:** treble of line volume.

Operation: There are one "+" button and one "-" button for each mode of MIC, LINE, BASS and TREBLE, "+" is for volume up and "-" is for volume down.

3. Safety Guides

- 1) DO NOT use the device in a direct sunlight, rainfall or humid environment.
- 2) DO NOT install the device next to a heat source area, or beside an electric heaters or a hot stove.

8. Troubleshooting and Maintenance

1) When there is no output audio:

- Check if there is any signal at the input.
- Check if there is any signal at the output.

We can check these by using an oscilloscope or a multimeter. If there is no signal input/output, maybe the input/output cables broken or the connectors loosen, please change for another cable.

- Check if the output port number is the same with the controlled one.
- If not the problem mentioned above, probably there is something broken inside the unit, please send it to the dealer for repair.

2) If the **POWER** indicator doesn't work or no respond to any operation, please make sure the power cord connection is good.

3) If the output sound is interfered, please make sure the system is grounded well.

4) If the static becomes stronger when connecting the audio connectors, it is probably due to bad grounding, please check the grounding and make sure it is connected properly, otherwise it would damage the amplifier

5) If the AMPMA70V40 amplifier cannot be controlled by the keys on the front panel, RS232 port or the IR remote, the unit may have already been broken. Please send it to the dealer for repair.

9. Safety Operation Guide

In order to guarantee the reliable operation of the equipment and safety of the staff, please abide by the following proceeding in installation, using and maintenance:

- 1) The system must be earthed properly. Please do not use two blades plugs and ensure the alternating power supply ranged from 100v to 240v and from 50Hz to 60Hz.
- 2) Do not put the switcher in a place of too hot or too cold.
- 3) As the power generating heat when running, the working environment should be maintained fine ventilation, in case of damage caused by overheat.
- 4) Please cut off the general power switch in humid weather or left unused for long time.
- 5) Before following operation, ensure that the alternating current wire is pull out of the power supply:
 - Take off or reship any components of the equipment.
 - Take off or rejoin any pin or other link of the equipment.
- 6) As to non-professional or without permission, please DO NOT try to open the casing of the equipment, DO NOT repair it on your own, in case of accident or increasing the damage of the equipment.
- 7) DO NOT splash any chemistry substance or liquid in the equipment or around.

10. After-sales Service

- 1) If there appear some problems when running AMPMA70V40, please check and deal with the problems reference to this user manual. Any transport costs are borne by the users during the warranty.
- 2) You can email to our after-sales department or make a call, please tell us the following information about your cases.
 - Product version and name.
 - Detailed failure situations.
 - The formation of the cases.
- 3) We offer products for all three-year warranty, which starts from the first day you buy this product (The purchase invoice shall prevail).
- 4) Any problem is same with one of the following cases listed, we will not offer warranty service but offer for charge.
 - Beyond the warranty.
 - Damage due to incorrectly usage, keeping or repairing.
 - Damage due to device assembly operations by the maintenance company non-assigned.
 - No certificate or invoice as the proof of warranty.
 - The product model showed on the warranty card does not match with the model of the product for repairing or had been altered.
 - Damage caused by force majeure.

Remarks: For any questions or problems, please try to get help from your local distributor, or email OWI at: techhelp@owi-inc.com.

Touchboards

205 Westwood Ave, Long Branch, NJ 07740
Phone: 866-94 BOARDS (26273) / (732)-222-1511
Fax: (732)-222-7088 | E-mail: sales@touchboards.com



www.owi-inc.com

OWI INCORPORATED

Tel: 310-515-1900

Fax: 310-515-1606

Email: info@owi-inc.com

Website: www.owi-inc.com