



Associated
Power Technologies
A DIVISION OF IKONIX USA

300XAC Series

Modular AC Power Source

Operation Manual for Models

310XAC
320XAC
340XAC
360XAC

Ver. 1.24
PART # 39101





DECLARATION OF CONFORMITY

Manufacturer: Associated Power Technologies, Inc.
Address: 28105 N. Keith Drive
 Lake Forest, IL 60045 **USA**
Product Name: 300XAC Power Source
Model Number: 310XAC, 320XAC

Conforms to the following Standards:

Safety: EN 61010-1:2010

EMC: EN 61326-1:2013 Class A
 EN 55011 :2009+A2 :2010 Group 1 Class A
 EN 61000-3-2 : 2006+A1 :2009+A2 :2009/
 IEC 61000-3-2 :2005+A1 :2008+A2 :2009
 EN 61000-3-3 :2013/IEC 61000-3-3 :2013
 EN 61326-1 :2013(Industrial Locations)
 EN 61000-4-2 :2009/IEC 61000-4-2 :2008
 EN 61000-4-3 :2006+A1 :2008+A2 :2010/
 IEC 61000-4-3 :2006+A1 :2007+A2 :2010
 EN 61000-4-4 :2012/ IEC 61000-4-4 :2012
 EN 61000-4-5 :2006/ IEC 61000-4-5 :2005
 EN 61000-4-5 :2006/ IEC 61000-4-5 :2005
 EN 61000-4-6 :2014/ IEC 61000-4-6 :2013
 EN 61000-4-8 :2010/ IEC 61000-4-8 :2009
 EN 61000-4-11 :2004/ IEC 61000-4-11 :2004

Supplementary Information

*The product herewith complies with the requirements of the **Low Voltage Directive 2014/35/EU, the EMC Directive 2014/30/EU** and the **RoHS Directive 2011/65/EU** with respect to the following substances: Lead (Pb), Mercury (Hg), Cadmium (Cd), Hexavalent chromium (Cr (VI)), Polybrominated biphenyls (PBB), Polybrominated diphenyl ethers (PBDE), Deca-BDE included.*

Last two digits of the year in which the CE marking was affixed: 10

The technical file and other documentation are on file with Associated Research, Inc.



 Joseph Guerriero
 President
 Associated Power Technologies, Inc.
 Lake Forest, Illinois USA
 July 20, 2017

Table of Contents

1. Introduction.....	1
1.1 Warranty	1
1.2 Glossary of Terms.....	2
1.3. Safety Symbols	5

1.4	Safety Precautions	5
1.5	Service and Maintenance	5
2.	Getting Started.....	7
2.1	Unpacking and Inspection	7
2.2	Input/Output Power Considerations	7
2.3	Output Current Capability	9
2.4	Instrument Power Switch	11
2.5	Selecting the Appropriate Wire Gauge.....	13
2.6	Power Cable	13
2.7	Supplied Input Accessories (360XAC Only).....	15
2.8	Environmental Conditions.....	15
2.9	Packaging.....	15
3.	Specifications and Controls	17
3.1	Specifications	17
3.2	Instrument Controls	29
3.2.1	Front Panel Controls.....	29
3.2.2	Rear Panel Controls	31
3.2.3	Soft Keys	34
4.	Programming Instructions.....	36
4.1	Powering on the Instrument.....	36
4.1.1	Set Screen Description.....	37
4.1.2	Security	38
4.1.3	Lock.....	39
4.1.4	Mem Lock.....	39
4.2	System Parameters Description	40
4.3	Editing System Parameters	43
4.3.1	Editing Auto Run Mode.....	44
4.3.2	Editing Out Mode.....	45
4.3.3	Editing Single Step (PROGRAM Mode only)	45
4.3.4	Editing Alarm	46
4.3.5	Editing Contrast.....	46
4.3.6	Editing Power Up.....	47
4.3.7	Editing Loop Cycle (PROGRAM Mode only)	48
4.3.8	Editing V Hi-Lmt & V Lo-Lmt (MANUAL Mode only)	48
4.3.9	Editing F Hi-Lmt & F Lo-Lmt (MANUAL Mode only)	49
4.3.10	Editing Start and End Angle (MANUAL Mode only)	50
4.3.11	Editing Results	51
4.3.12	Editing Transient (MANUAL Mode only)	52
4.3.13	Editing OC Fold	53
4.3.14	Editing Lock.....	53
4.3.15	Editing Mem Lock.....	54
4.3.16	Editing Volt Sense	55
4.3.17	Editing Sync Signal.....	55
4.3.18	Editing Function (Option 08 only)	56
4.4	Using Memories and Steps (PROGRAM Mode only)	57
4.4.1	Selecting a Memory	57

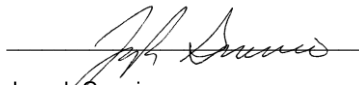
4.4.2	Naming a Memory	59
4.4.3	Selecting a Step	60
4.5	Test Parameters Description.....	60
4.6	Editing Test Parameters.....	65
4.6.1	Editing Start and End Angle (PROGRAM Mode only)	66
4.6.2	Editing the Memory Cycle (PROGRAM Mode only)	68
4.6.3	Editing the Memory (PROGRAM Mode only)	69
4.6.4	Editing the Step (PROGRAM Mode only).....	69
4.6.5	Editing Voltage	70
4.6.6	Editing Frequency.....	71
4.6.7	Editing Transient * (PROGRAM Mode only)	71
4.6.8	Editing Trans-Volt* (PROGRAM Mode only).....	72
4.6.9	Editing Trans-Site* (PROGRAM Mode only)	73
4.6.10	Editing Trans-Time* (PROGRAM Mode only).....	74
4.6.11	Editing Trans-Cycle* (PROGRAM Mode only).....	74
4.6.12	Editing Ramp Up (PROGRAM Mode only)	76
4.6.13	Editing Timer Unit (PROGRAM Mode only).....	77
4.6.14	Editing Delay (PROGRAM Mode only)	77
4.6.15	Editing Dwell (PROGRAM Mode only)	78
4.6.16	Editing Ramp Down (PROGRAM Mode only)	79
4.6.17	Editing Step Cycle (PROGRAM Mode only).....	79
4.6.18	Editing A Hi-Lmt & A Lo-Lmt (PROGRAM Mode only)	80
4.6.19	Editing P Hi-Lmt & P Lo-Lmt (PROGRAM Mode only)	81
4.6.20	Editing Ap Hi-Lmt & Ap Lo-Lmt (PROGRAM Mode only).....	82
4.6.21	Editing CF Hi-Lmt & CF Lo-Lmt (PROGRAM Mode only).....	83
4.6.22	Editing PF Hi-Lmt & PF Lo-Lmt (PROGRAM Mode only)	84
4.6.23	Editing VA Hi-Lmt & VA Lo-Lmt (PROGRAM Mode only)	85
4.6.24	Editing Q Hi-Lmt & Q Lo-Lmt (PROGRAM Mode only).....	87
4.6.25	Editing Prompt.....	88
4.6.26	Editing Connect	89
4.6.27	Editing Phase Set (Option 08 – PROGRAM Mode only)	89
4.7	Reviewing Test Results.....	90
5.	Test Modes	92
5.1	Description of Test Modes	92
5.2	Initializing a Test in PROGRAM Mode	92
5.2.1	AC Output.....	92
5.2.2	DC Output	94
5.3	Initializing a Test in MANUAL Mode	96
5.3.1	AC Output.....	96
5.3.2	DC Output	97
6.	Multiple Instrument Operation.....	99
6.1	Configuring Sources for Parallel and Polyphase Operation.....	99
6.1.1	Operating Mode Definitions	99
6.1.2	Connecting the Interface Cable	99
6.1.3	Output Wiring Diagrams	100
6.2	Power Up Considerations in Parallel and Polyphase Mode.....	103

6.3	Initializing a Test in Parallel or Polyphase Mode	104
6.4	Error Messages in Parallel and Polyphase Mode	105
7.	Displayed Messages.....	106
7.1	OTP – Over Temperature Protection	106
7.2	OCP – Over Current Protection	106
7.3	OPP – Over Power Protection	106
7.4	OVP – Output Voltage Protection	107
7.5	A-SH – Amplifier Shutdown Protection	107
7.6	RCP – Reverse Current Protection.....	107
7.7	LVP- Low Voltage Protection	107
8.	Remote PLC	108
8.1	Signal Output.....	108
8.2	Signal Input - 7 Memory Recall (Opt. 04).....	108
9.	Bus Remote Interface USB/GPIB/RS-232	110
9.1	USB/RS-232 Interface	110
9.1.1	RS-232 Connector.....	111
9.1.2	Communication Port Configuration.....	111
9.1.3	Sending and Receiving Commands	111
9.2	GPIB Interface	112
9.2.1	GPIB Connector	112
9.2.2	GPIB Address.....	112
9.3	Interface Functions	112
9.4	USB/GPIB/RS-232 Interface Command List.....	113
9.4.1	Basic Commands and Query Commands	114
9.4.2	3 Φ 4W Queries.....	117
9.4.3	1 Φ 3W Queries.....	118
9.4.4	Program Commands and Companion Queries.....	118
9.4.5	System Commands and Companion Queries	122
9.4.6	IEEE 488.2 Common Commands.....	123
10.	Calibration Procedure	128
10.1	Hardware Verification and Calibration Procedure	128
10.2	Activate Non-Calibration Mode	128
10.3	Adjust Control Circuit Power Voltage	128
10.4	Adjust the Amplifier Inverter DC Bus Voltage.....	129
10.5	Clear the Output High Frequency Noise	129
10.6	Adjust the “0” Volts and “110” Volts DC Offset	129
10.7	Adjust Wattmeter Offset.....	130
10.8	Adjust Hardware OCP Set Point.....	131
10.9	Exit Non-Calibration Mode.....	131
10.10	Software Calibration Procedure	131
10.11	Enter Calibration Mode	133
10.12	Calibration of Voltage 150.0V.....	133
10.13	Calibration of Voltage 300.0V.....	134
10.14	Calibration of High and Low Current Range.....	135
10.15	Calibration of High and Low Power Range	135
10.16	Calibration of Peak Current.....	136

11.	Options.....	138
11.1	Opt. 02 – Grounded Neutral	138
11.2	Opt. 03 – GPIB Card	138
11.3	Opt. 04 – 7 Remote Memories Select.....	138
11.4	Opt. 06 – Ethernet Card.....	138
11.4.1	Ethernet Card Setup.....	139
11.4.2	Saving New Settings	141
11.4.3	Power Up.....	141
11.4.4	Ethernet Card Menu	143
11.4.5	IP Setup.....	143
11.4.6	IP Address	144
11.4.7	Gateway IP	144
11.4.8	Subnet Mask	144
11.4.9	Device Name	145
11.4.10	MAC Address	146
11.4.11	Barcode Input	146
11.4.12	Autostart	148
11.4.13	Ethernet Card Settings Commands and Companion Queries..	149
11.4.14	Ethernet Card Settings Command Wait Times.....	151
11.5	Opt. 08 – Linking Card.....	151
12.	Service and Maintenance.....	152
13.	Replacement Parts List	153

1. Introduction

1.1 Warranty

Associated Power Technologies, Inc. (APT), certifies that the instrument listed in this manual meets or exceeds published manufacturing specifications. This instrument was calibrated using standards that are traceable to the National Institute of Standards of Technology.

Your new instrument is warranted to be free from defects in workmanship and material for a period of (3) years from date of shipment. During the warranty period, you must return the instrument to Associated Power Technologies, Inc. or its branches for repair. Associated Power Technologies reserves the right to use its discretion on replacing the faulty parts or replacing the assembly or the whole unit.

APT will void your warranty under the following states:

- Operation of the instrumentation under non-normal conditions
- Any non-authorized modifications, tampering or physical damage
- Elimination of any connections in the earth grounding system or bypassing any safety systems
- Use of non-authorized parts in the repair of this instrument. Parts used must be parts that are recommended by APT as an acceptable specified part.

This warranty does not cover accessories not of Associated Power Technologies, Inc. manufacture.

Except as provided herein, APT, makes no warranties to the purchaser of this instrument and all other warranties, expressed or implied (including, without limitation, merchantability or fitness for a particular purpose) are hereby excluded, disclaimed and waived.

APT recommends that your instrument be calibrated on a twelve month cycle. Instruments returned to APT annually for calibration fall under our extended warranty which can be extended up to five years. Each year the instrument is returned to APT in consecutive years the warranty is extended one additional year. This process can be repeated up to four years for a 5-Year Warranty.

Instruments returned for warranty repair within the first six months of the warranty period, will have the warranty extended for one year from the date of repair at no charge. Instruments received after the first six months can have the warranty extended for 3 months after its original expiration date at no charge or the

warranty can be extended for a full year at the cost of an annual calibration.

1.2 Glossary of Terms

Alternating Current (AC) - current that reverses direction on a regular basis (usually 60 times per second in the United States). Measured in amps.

AC Power Source - An instrument that takes one AC voltage and frequency level and converts it into another AC voltage and frequency level.

Amplifier - a circuit that boosts an input signal from one level to another.

Apparent Power - The total power generated or consumed by a device due to real and reactive circuit components. Measured in VA (volt-amps).

Calibration - the process of comparing an unknown value with a reference standard and reporting the results. For example: Applied = 1.30V, Indicated = 1.26V (or Error = -0.04V). Calibration may include adjustment to correct any deviation from the value of the standard.

Crest Factor - The ratio of peak current (I_{peak}) to RMS current (I_{RMS}).

Complex Power – the vector sum of the real and reactive power components of a circuit. Measured in VA (volt-amps).

Direct Current (DC) - current that only flows in one direction. Direct current comes from a polarized source, meaning one terminal is always at a higher potential than the other. Measured in amps.

Frequency - The number of times a waveform completes a cycle in a period of time. Measured in hertz.

Inrush Current - A term used to describe the current needed to power a load upon start-up. Some loads require a large/inrush starting current in order to operate.

Linear Power Source - a power source that uses a simple amplifier to linearly increase the amplitude of the output waveform.

Modular - capability that allows the operator to interconnect multiple 300XAC power sources in order to increase the power output or power configuration beyond that of a single instrument.

OC Fold - Over current fold back is a technology used in power sources that keeps output current constant by reducing the voltage in order to power loads that may have a high inrush current.

Parallel Mode - up to 3x 300XAC modular AC power sources can be configured with their outputs tied in parallel, allowing for the system to output three times a single instrument's nominal output current rating.

PFC - Power Factor Correction is a method by which an inductance is inserted into the input circuit of a power source to improve the power factor and overall efficiency of the system.

Phase Angle - the degree of measurement that corresponds to an AC waveform's amplitude. Measured from 0 – 360 degrees.

PLC - Programmable Logic Control is an automation method using relay or digital technology.

Polyphase Mode - multiple 300XAC modular AC power sources can be configured to provide output voltages of up to 600VAC (output configured for 1 Φ 3W) or provide 3 Φ output power (output configured for 3 Φ 4W).

Power - A generic term used to describe electrical work being done. There are many types of power, including real power, reactive power, apparent power, and complex power.

Power factor - The ratio of real power (watts) to apparent power (VA). Based on a scale from 0 to 1 to determine how reactive and resistive a load is.

Reactive Power – the power absorbed by capacitive or inductive elements in a circuit. This power does no work. Measured in VAR (volt-amps reactive).

Real Power – the power that performs work in a circuit. Measured in watts.

Response Time - The time that is needed to regulate the voltage, current, frequency, and power output when a load is added to the power source.

Safety Agency Listing - A safety mark given to a product that has met stringent benchmarks as classified by the authorized agency.

SmartConfig - this feature allows the operator to change the output of AC power sources in a linked system from Parallel to Polyphase modes with a simple button push. Changing internal cables or dip switches is not required.

SmartDetect - this feature automatically assigns the appropriate master/slave designation for each AC power source in a linked system without the need for the operator to reconfigure internal hardware.

Steady State Current - A term used to describe the current when the load is running nominally after the inrush current.

Switching Power Source - A power source that uses switching technology (integrated circuits and components) in order to generate the output waveform.

Total Harmonic Distortion (THD) - A percentage that is used to identify the degree of the noise/unclean signal in a power source's output waveform.

Transient - a momentary change (spike or dip) in a voltage or current waveform that can affect the performance of the DUT.

Verification - comparison of measured results against a specification, usually the manufacturer's published performance figures for the product (e.g. *Error = -0.04V*, *Spec = ±0.03V*, result: "FAIL").

Voltage - The amount of force that is needed to move current from point to point. Measured in volts.

1.3. Safety Symbols

1.3.1 Product Marking Symbols



Product will be marked with this symbol when it is necessary to refer to the operation and service manual in order to prevent injury or equipment damage.



Product will be marked with this symbol when hazardous voltages may be present.



Product will be marked with this symbol at connections that require earth grounding.

1.3.2 Caution and Warning Symbols

WARNING

Calls attention to a procedure, practice, or condition that could possibly cause bodily injury or death.

CAUTION

Calls attention to a procedure, practice, or condition that could possibly cause damage to equipment or permanent loss of data.

1.4 Safety Precautions

- This product and its related documentation must be reviewed for familiarization with safety markings and instructions before operation.
- Before applying power verify that the instrument is set to the correct line voltage and the correct fuse is installed

WARNING

To prevent accidental injury or death, these safety procedures must be strictly observed when handling and using the test instrument.

1.5 Service and Maintenance

User Service

To prevent electric shock do not remove the instrument cover. There are no user serviceable parts inside. Routine maintenance or cleaning of internal parts is not

necessary. Any external cleaning should be done with a clean dry or slightly damp cloth. Avoid the use of cleaning agents or chemicals to prevent any foreign liquid from entering the cabinet through ventilation holes or damaging controls and switches, also some chemicals may damage plastic parts or lettering. Any replacement cables and high voltage components should be acquired directly from APT or its distributors.

Service Interval

The instrument must be returned at least once a year to an APT authorized service center for calibration and inspection of safety related components. APT will not be held liable for injuries suffered if the instrument is not properly maintained and safety checked annually.

User Modifications

Unauthorized user modifications will void your warranty. APT will not be responsible for any injuries sustained due to unauthorized equipment modifications or use of parts not specified by APT. Instruments returned to APT with unsafe modifications will be returned to their original operating condition at the customer's expense.

2. Getting Started

This section contains information for the unpacking, inspection, preparation for use and storage of your APT product.

2.1 Unpacking and Inspection

Your instrument was shipped in a protective shipping carton designed to protect the instrument through the shipping process. If the shipping carton is damaged, inspect the contents for visible damage such as dents, scratches, or broken display. If the instrument is damaged, notify the carrier and APT's customer support department. Please save the shipping carton and packing material for the carrier's inspection. Our customer support department will assist you in the repair or replacement of your instrument. Please do not return your product without first notifying us.

Safe Lifting and Carrying Instructions

Proper methods of lifting and carrying can help to protect against injury. Follow the recommendations below to ensure that instruments are handled in a safe manner.

- Determine if the instrument can be lifted by one individual or requires additional support.
- Make sure that your balance is centered and your feet are properly spaced, shoulder width apart behind the instrument.
- Bend at the knees and make sure your back is straight.
- Grip the instrument with your fingers and palms and do not lift unless your back is straight.
- Lift up with your legs, not your back.
- Keep the instrument close to your body while carrying.

Lower the instrument by bending your knees. Keep you back straight.

2.2 Input/Output Power Considerations

Special care should be taken when making connections to the input and output terminal blocks located on the rear panel of the 300XAC. Ensure that the

appropriate wire gauges are used to assemble a satisfactory line cord. Failure to assemble a quality line cord could result in fire or personal injury. Refer to the following graphs for input/output current requirements:

310XAC Input Current vs. Output Current

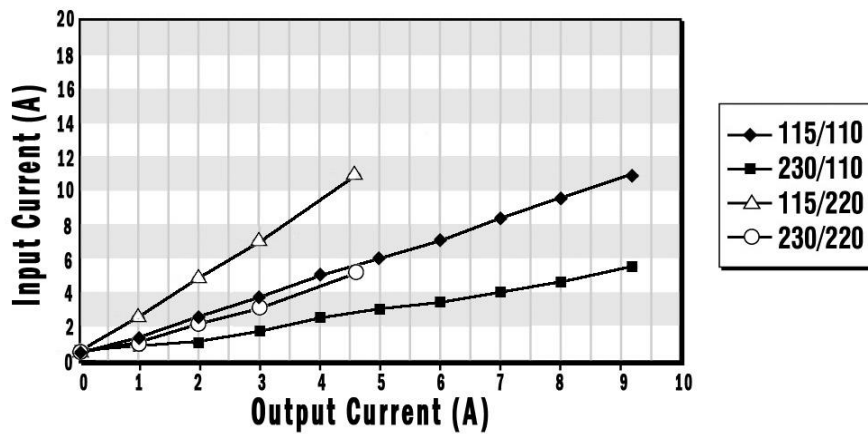

310XAC

320XAC Input Current vs. Output Current

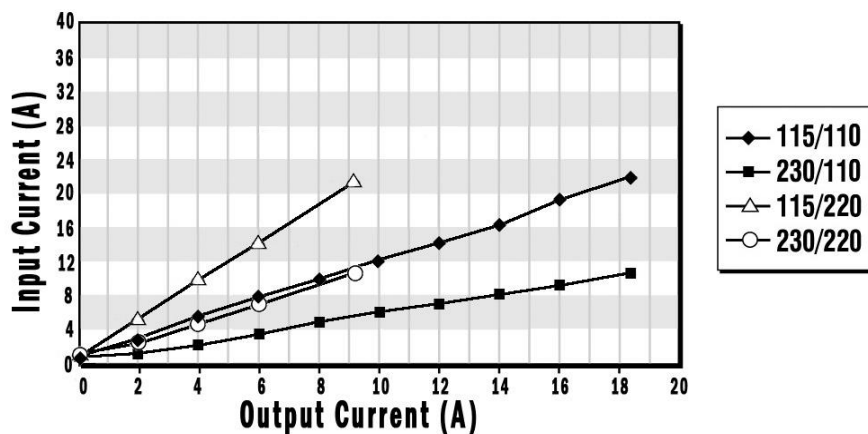

320XAC

340XAC Input Current vs. Output Current

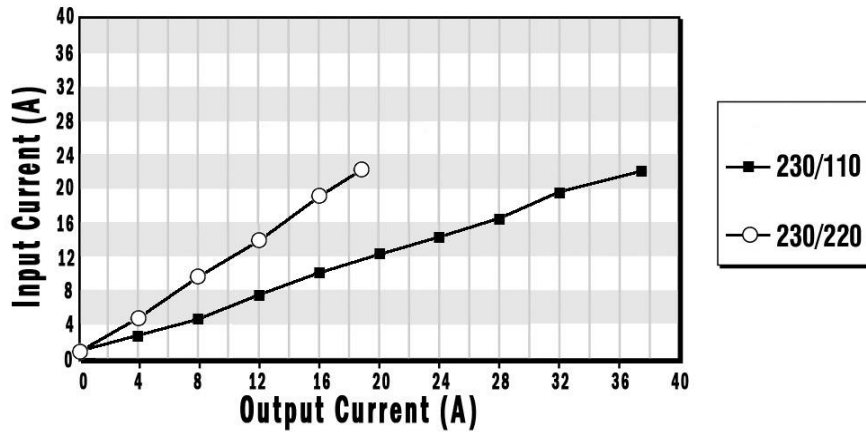

340XAC

360XAC Input Current vs. Output Current

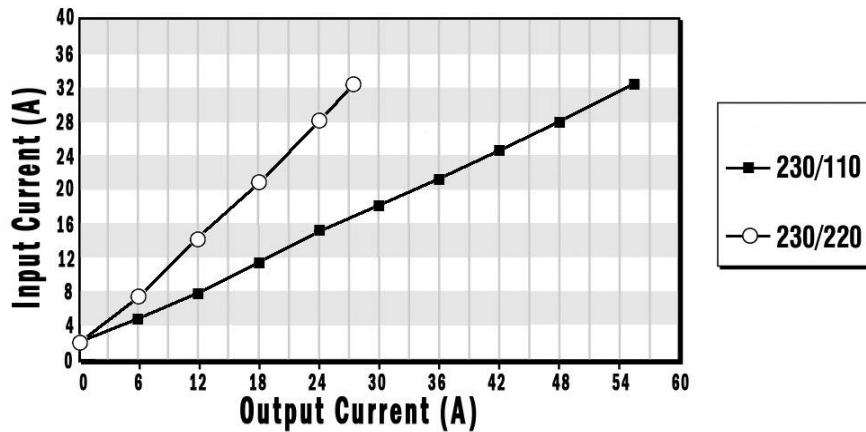

360XAC

2.3 Output Current Capability

The following charts indicate the output current capability of each 300XAC model depending on the output voltage and the selected voltage range:

310XAC

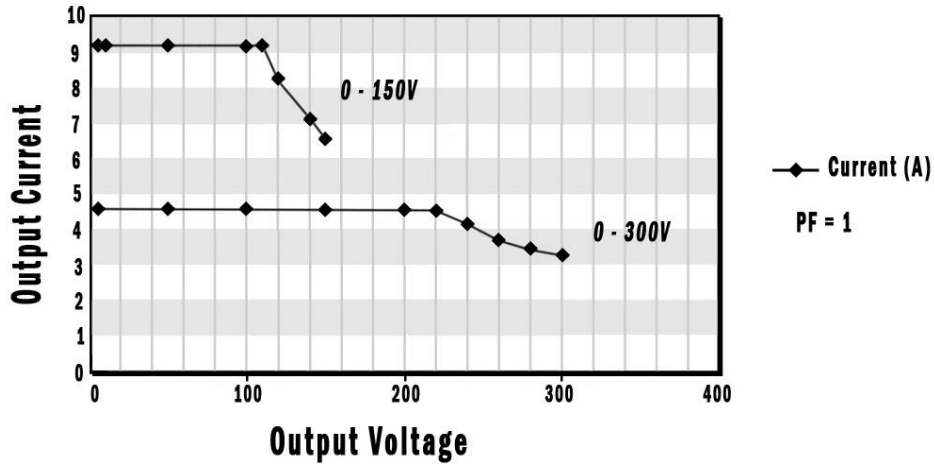

310XAC

320XAC

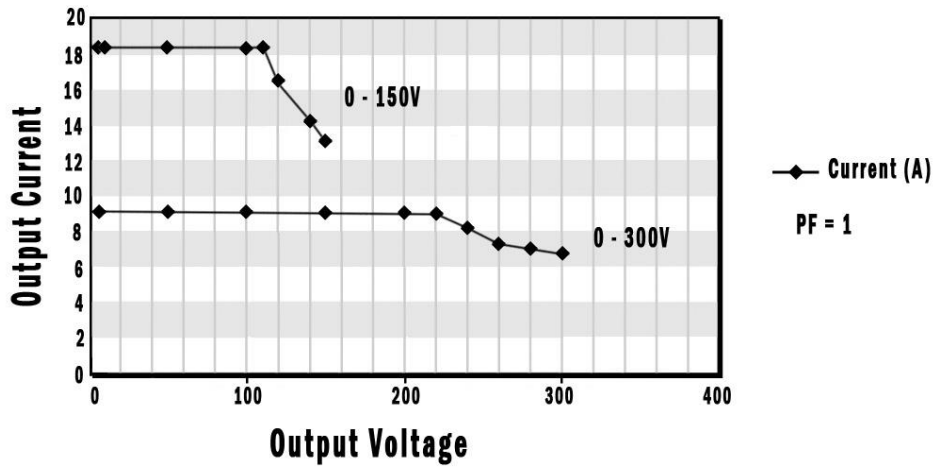

320XAC

340XAC

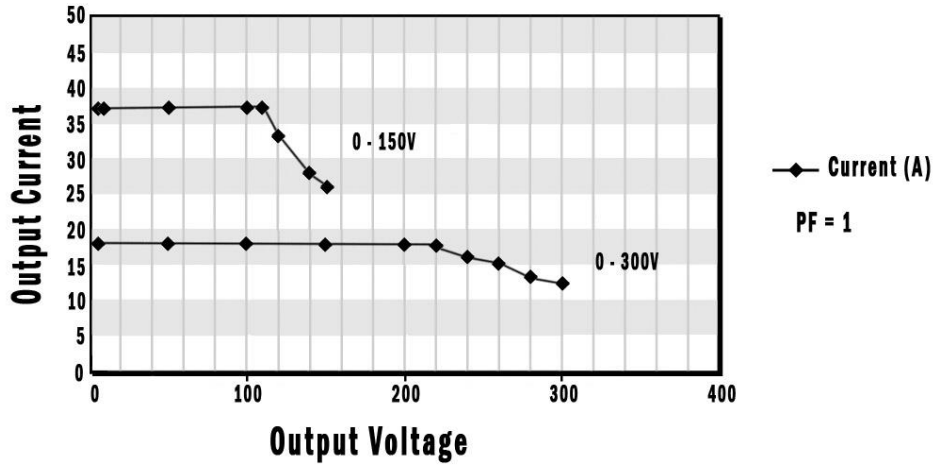

340XAC

360XAC

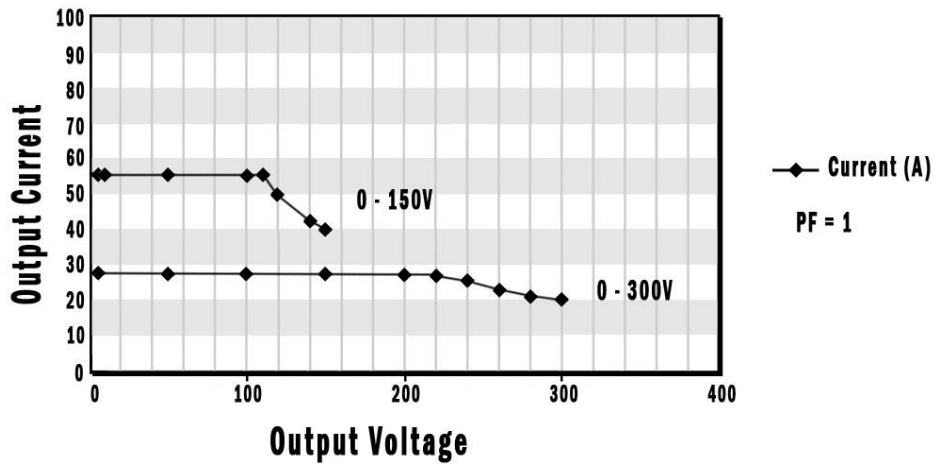

360XAC

2.4 Instrument Power Switch

The power switch that is included in the instrument is not considered a disconnecting device. It only disconnects one current carrying conductor to power off the device. The user should configure the equipment with an external

switch or circuit breaker for disconnecting it from each operating energy supply source. In compliance with EN61010-1 for permanently connected equipment this switch should meet the following guidelines.

- a.) It shall be included in the building installation.
- b.) It shall be in close proximity to the equipment and within easy reach of the operator.
- c.) It shall be marked as the disconnecting device for the equipment
- d.) It shall not interrupt the protective earth conductor.

2.5 Selecting the Appropriate Wire Gauge

Below is a table which provides recommended appropriate wire gauges for the 300XAC.

310XAC	Input			Output				
Terminal	Line	Neutral	Ground	Line	Neutral	Ground	Nsense	Lsense
Gauge	12 AWG	12 AWG	12 AWG	14 AWG	14 AWG	14 AWG	18 AWG	18 AWG

320XAC	Input			Output				
Terminal	Line	Neutral	Ground	Line	Neutral	Ground	Nsense	Lsense
Gauge	12 AWG	12 AWG	12 AWG	14 AWG	14 AWG	14 AWG	18 AWG	18 AWG

340XAC	Input			Output				
Terminal	Line	Neutral	Ground	Line	Neutral	Ground	Nsense	Lsense
Gauge	10 AWG	10 AWG	10 AWG	10 AWG	10 AWG	10 AWG	18 AWG	18 AWG

360XAC	Input			Output				
Terminal	Line(A,B,C)	Neutral (A,B,C)	Ground	Line	Neutral	Ground	Nsense	Lsense
1 Φ 2W	10 AWG	10 AWG	10 AWG	8 AWG	8 AWG	8 AWG	18 AWG	18 AWG
3 Φ 3W	12 AWG	N/A	12 AWG					
3 Φ 4W	14 AWG	14 AWG	14 AWG					

2.6 Power Cable

WARNING

Before connecting power to this instrument, the protective ground (earth) terminals of this instrument must be connected to the protective conductor of the line (mains) power cord. The main plug shall only be inserted in a socket outlet (receptacle) provided with a protective ground (earth) contact. This protective ground (earth) must not be defeated by the use of an extension cord without a protective conductor (grounding).

WARNING

The mains plug is used as the disconnecting device and shall remain readily operable. The socket-outlet shall be installed near the equipment and shall be easily accessible.

WARNING

The main plug shall only be inserted in a socket outlet with a protective ground (earth) contact. This protective ground **must not be defeated** by the use of an extension cord without a protective conductor.

CAUTION

Do not replace the power supply cord with an improperly rated cord. For North American: A UL listed and CSA labeled power cord must be used with the instrument in the United States and Canada. The power cord must include a NEMA5-15 style male plug, SVT or SJT cord sets, and be rated for at least 125VAC, 10A, number 16 gauge (or 125VAC, 15A, number 14 gauge) wire or larger, and the length of the cord does not exceed 2 m must be used. For European: A certified power supply cord not lighter than light PVC sheathed flexible cord according to IEC 60227, designation H03 VV-F or H03 VVH2-F (for equipment mass not exceeding 3 kg), or H05 VV-F or H05 VVH2-F2 (for equipment mass exceeding 3 kg), and be rated for at least 3G 0.75 mm² (for rated current up to 10 A) or 3G 1.0mm² (for rated current over 10 A up to 16 A) wire or larger, and the length of the cord does not exceed 2 m must be used.

360XAC Power Cable Considerations

The 360XAC can be powered with several different input power configurations. Refer to the diagram below for connecting a single phase, 3 phase wye, and 3 phase delta power source to the instrument:

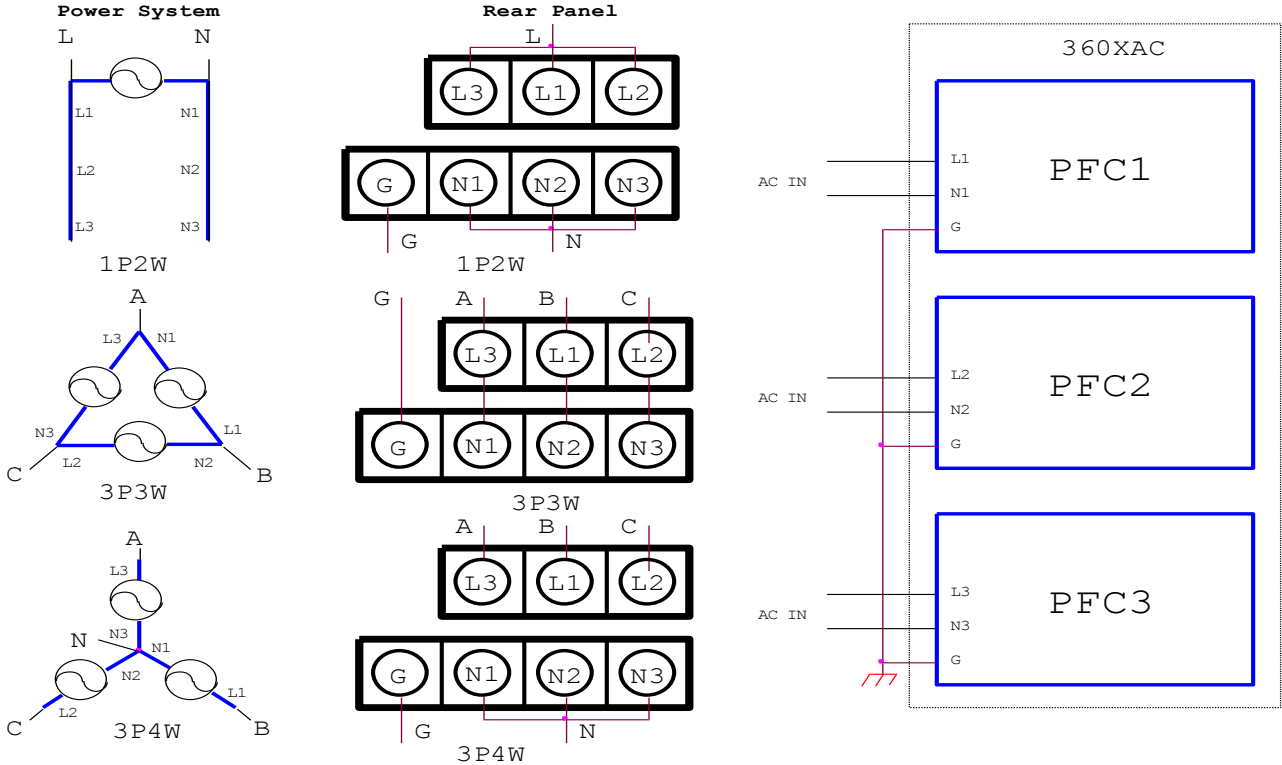

2.7 Supplied Input Accessories (360XAC Only)

Accessory:	1P2W	3P3W	3P4W
Shorting Bar 39177	-	3	-
Shorting Bar 39178	1	-	1
Shorting Bar 39179	1	-	-
Screw 39243	2	-	1

2.8 Environmental Conditions

Operating Environment

Temperatures: 5° - 40° C (41° - 104° F)

Relative humidity: 20% - 80%

Altitude: 2,000 meters (6,562 feet)



Do not block any ventilation openings to prevent over heating of the equipment. Keep the ventilation slits uncovered during operation. Failure to do so could cause the instrument to overheat and may damage internal

components.

The instrument should also be protected against temperature extremes which may cause condensation within the instrument.

If the instrument is used in a matter not specified by the manufacturer, the protection provided by the instrument may be impaired.

Storage and Shipping Environment

This instrument may be stored or shipped in environments with the following limits:

Temperature.....-40° to +55° C

Altitude.....7,620 meters (25,000 feet)

2.9 Packaging

Please enclose the instrument with all options, accessories and test leads. All

returns must be accompanied by a return material authorization (RMA) number which is provided by the customer support department. Failure to ship your instrument without a RMA number will result in additional fees for handling and storage.

APT will not be responsible for any repair costs associated with shipping damage as a result of improper packaging. The customer is responsible for providing adequate shipping insurance coverage while shipping an instrument in the event of loss or damage while in transit.

3. Specifications and Controls

3.1 Specifications

INPUT	310XAC	320XAC	340XAC	360XAC
Phase	1Φ			1Φ or 3Φ
Voltage	100 - 240 V ± 10%		200 - 240 V ± 10%	1Φ: 200 - 240 V ± 10% 3Φ3W: 200 - 240 V ± 10% 3Φ4W: 346 - 416 V ± 10%
Frequency	47 - 63 Hz			

OUTPUT AC VOLTAGE

Voltage			5 - 300 V		5 - 300 V	
Power			1 KVA	2 KVA	4 KVA	6 KVA
Max Current <i>Line to Neutral</i>	5 - 150 V	L	9.2 A @ 110 V	18.4 A @ 110 V	36.8 A @ 110 V	55.2 A @ 110 V
	5 - 300 V	H	4.6 A @ 220 V	9.2 A @ 220 V	18.4 A @ 220 V	27.6 A @ 220 V
Inrush Current (peak)	5 - 150 V	L	36.8 A	73.6 A	147.2 A	220.8 A
	5 - 300 V	H	18.4 A	36.8 A	73.6 A	110.4 A
Frequency			40.0 - 1000 Hz			
Phase			1Φ (Linking Available for 1Φ3W or 3Φ4W)			
THD			< 0.5% (Resistive Load) at 40.0-70.0Hz and output voltage 80 - 140V Low Range or 160 - 280V High Range, <1% (Resistive Load) at 70.1-500Hz and output voltage 80 - 140V or 160 - 280V, <1.5% (Resistive Load) at 501-1000Hz and output voltage 100 - 140V Low Range or 160 - 280V High Range.			
Crest Factor			≥3			
Line Regulation			± 0.1 V			
Load Regulation			± 0.5 V			
DC Offset			± 5 mV			

OUTPUT DC VOLTAGE

Voltage			5 - 420 V		5 - 420 V	
Power			1000 W	2000 W	4000 W	6000 W
Max Current	5 - 210 V	L	4.8 A	9.6 A	19.2 A	28.8 A
	5 - 420 V	H	2.4 A	4.8 A	9.6 A	14.4 A
Ripple & Noise (rms)	5 - 210 V	L	< 500 mV		< 720 mV	
	5 - 420 V	H	< 800 mV		< 1100 mV	
Ripple & Noise (p-p)			< 3.0 Vp-p		< 4.0 Vp-p	

MEASUREMENT AC

		310XAC	320XAC	340XAC	360XAC
Voltage	Range	0.0 - 400.0 V			
	Resolution	0.1 V			
	Accuracy	± (1% of reading + 2 counts) > 5 V		± (1% of reading + 5 counts) > 5 V	
Frequency	Range	0.0 - 1000 Hz			
	Resolution	0.1 Hz			

	Accuracy	L	$\pm 0.1 \text{ Hz @ } 0.0 - 500 \text{ Hz}$
		H	$\pm 0.2 \text{ Hz @ } 501 - 1000 \text{ Hz}$



**MEASUREMENT
AC Cont.**

			310XAC	320XAC	340XAC	360XAC	
Current (rms)	Range	L	0.005 A - 1.200 A	0.005A - 2.400 A	x	x	
		H	1.00 A 13.00A	2.00 A - 26.00 A	0.05 A - 52.00 A	0.05 A - 78.00 A	
	Resolution	L	0.001 A		x		
		H	0.01 A		0.01 A		
Accuracy	L	± (1% of reading + 5 counts)			± (1% of reading + 5 counts) @ 40 - 100 Hz, ± (1% of reading + 5 counts) @ 101 - 500 Hz > 0.1A, ± (1% of reading + 5 counts) @ 501 - 1000 Hz > 0.2A		
	H	± (1% of reading + 5 counts)					
Current (peak)	Range		0.0 A- 38.0 A	0.0 A - 76.0 A	0.0 A - 152.0 A	0.0A - 228 A	
	Resolution		0.1 A				
	Accuracy		± (1% of reading + 5 counts)				
Power (W)	Range	L	0.0 W - 120.0 W	0.0 W - 240.0 W	x	x	
		H	100 W - 1300 W	200 W - 2600 W	0 W - 5200 W	0 W - 7800 W	
	Resolution	L	0.1 W		x	x	
		H	1 W				
	Accuracy	L	± (2% of reading + 15 counts) at PF ≥ 0.2			x	x
		H	± (2% of reading + 5 counts) at PF ≥ 0.2	± (2% of reading + 5 counts) at PF ≥ 0.2			
Power Apparent (VA)	Range	L	0.0 VA - 120.0 VA	0.0 VA - 240.0 VA	x	x	
		H	100 VA - 1300 VA	200 VA - 2600 VA	0 VA - 5200 VA	0 VA - 7800 VA	
	Resolution	L	0.1 VA		x	x	
		H	1 VA				
	Accuracy		V x A, Calculated Value				
Power Reactive (Q)	Range	L	0.00 VAR - 120.0 VAR	0.0 VAR - 240.0 VAR	x	x	
		H	0 VAR - 1300 VAR	0 VAR - 2600 VAR	0 VAR - 5200 VAR	0 VAR - 7800 VAR	
	Resolution	L	0.1 VAR		x	x	
		H	1 VAR				
	Accuracy		$\sqrt{(va)^2 - (w)^2}$, calculated value				
Power Factor	Range		0 - 1.000				
	Resolution		0.001				
	Accuracy		W/VA, Calculated value and displayed to 3 significant digits				
Crest Factor	Range		0 - 10.00				
	Resolution		0.01				
	Accuracy		Ap/A, Calculated value and displayed to 2 significant digits				

**MEASUREMENT
DC**

			310XAC	320XAC	340XAC	360XAC
Voltage	Range		0.0 - 420.0 V		0.0 - 420.0 V	
	Resolution		0.1 V			
	Accuracy		± (1% of reading + 2 counts)		± (1% of reading + 5 counts)	
Current	Range	L	0.010 A - 1.200A	0.010 A - 2.400	x	x

| | | | | A | | |

**MEASUREMENT
DC Cont.**

			310XAC	320XAC	340XAC	360XAC
		H	1.00 A - 13.00 A	2.00 A - 26.00 A	0.05 A - 52.00 A	0.05 A - 78.00 A
	Resolution	L	0.001 A			
		H	0.01 A			
	Accuracy	L	± (1% of reading + 5 counts)			
		H	± (1% of reading + 5 counts)			
Power	Range	L	0.0 W - 120.0 W	0.0 W - 240.0 W	x	x
		H	100 W - 1300 W	200 W - 2600 W	0 W - 5200 W	0 W - 7800 W
	Resolution	L	0.1 W		x	x
		H	1 W			
	Accuracy	L	± (2% of reading + 5 counts)		x	x
		H	± (2% of reading + 5 counts)			

TEST SETTING PARAMETERS

			310XAC	320XAC	340XAC	360XAC
Memory			Range 1 - 50 Locations			
Memory Cycle			0 - 9999, 0 = Cont., 1 = OFF			
Step	AC		Range 1 - 9			
	DC		Range 1-5			
Step Cycle			0 - 9999, 0 = Cont., 1 = OFF			
Voltage Output			AC, DC			
Voltage	Range	AC	5.0 - 300.0 V High/Auto Mode		5.0 - 300.0	
		DC	5.0 - 420.0 V High/Low Range		5.0 - 420.0	
	Resolution		0.1 V			
	Accuracy		± (1% of reading + 2 counts)		± (1% of reading + 5 counts) > 5 V	
Voltage Hi-Lmt	AC		5.0 V - 300 V		5.0 V - 300 V	
	DC		5.0 V - 420 V		5.0 V - 420 V	
Voltage Lo-Lmt	AC		5.0 V - 300 V		5.0 V - 300 V	
	DC		5.0 V - 420 V		5.0 V - 420 V	
Frequency Hi-Lmt	Range		40.0 - 1000 Hz			
Frequency Lo-Lmt	Range		40.0 - 1000 Hz			
Frequency	Resolution		0.1 Hz @ 40.0 - 99.9 Hz, 1 Hz @ 100 - 1000 Hz			
	Accuracy		±0.03%			
Current (rms) Hi-Lmt	Range	AC	0.005 A - 9.2 A, 0 = OFF	0.005 A - 18.4 A, 0 = OFF	0.05 A - 36.8 A, 0 = OFF	0.05 A - 55.2 A, 0 = OFF
		DC	0.01 A - 4.60 A	0.01 A - 9.60 A	0.10 A - 18.40 A	0.10 A - 27.6 A
Current (rms) Lo-Lmt	AC		0.005 A - 9.2 A	0.005 A - 18.4 A	0.05 A - 36.8 A	0.05 A - 55.2 A
	DC		0.01 A - 4.60 A	0.01 A - 9.60 A	0.10 A - 18.40 A	0.10 A - 27.6 A
Current (rms)	Resolution		0.01 Amp			
	Accuracy		± (2.0% of setting + 2 counts)			
Current (peak) Hi-Lmt			0.0 A - 38.0 A, 0 = OFF	0.0 A - 76.0 A, 0 = OFF	0.0 A - 152.0 A, 0 = OFF	0.0A - 228 A, 0 = OFF
Current (peak) Lo-Lmt			0.0 A - 38.0 A	0.0 A - 76.0 A	0.0 A - 152.0 A	0.0A - 228 A
Power Hi-Lmt			0.0 W - 1000 W, 0 = OFF	0.0 W - 2000 W, 0 = OFF	0 W - 4000 W, 0 = OFF	0 W - 6000 W, 0 = OFF

TEST SETTING PARAMETERS Cont.			310XAC	320XAC	340XAC	360XAC
Power Lo-Lmt			0.0 W - 1000 W, 0 = OFF	0.0 W - 2000 W, 0 = OFF	0.0 W - 4000 W, 0 = OFF	0.0 W - 6000 W, 0 = OFF
Power Apparent Hi-Lmt			0.0 VA - 1000 VA, 0 = OFF	0.0 VA - 2000 VA, 0 = OFF	0 VA - 4000 VA, 0 = OFF	0 VA - 6000 VA, 0 = OFF
Power Apparent Lo-Lmt			0.0 VA - 1000 VA, 0 = OFF	0.0 VA - 2000 VA, 0 = OFF	0 VA - 4000 VA, 0 = OFF	0 VA - 6000 VA, 0 = OFF
Power Reactive Hi-Lmt			0.0 VAR - 1000 VAR, 0 = OFF	0.0 VAR - 2000 VAR, 0 = OFF	0 VAR - 4000 VAR, 0 = OFF	0 VAR - 6000 VAR, 0 = OFF
Power Reactive Lo-Lmt			0.0 VAR - 1000 VAR, 0 = OFF	0.0 VAR - 2000 VAR, 0 = OFF	0 VAR - 4000 VAR, 0 = OFF	0 VA - 6000 VA, 0 = OFF
Power Factor Hi-Lmt			0.000 - 1.000, 0 = OFF			
Power Factor Lo-Lmt			0.000 - 1.000			
Crest Factor Hi-Lmt			0.00 - 10.00, 0 = OFF			
Crest Factor Lo-Lmt			0.00 - 10.00			
Timer Unit			Second, Minute, Hour			
Ramp Up	Range	AC	0.00 - 999.9			
		DC	1.0 - 999.9, 0 = OFF			
	Resolution		0.1 (second, minute, hour)			
	Accuracy		± (0.1% + 0.05 sec.)			
Delay	Range		0.5sec - 999.9 sec (1.0 – 999.9 when linked), 0.1 min - 999.9 min, 0.1 hr - 999.9 hr			
	Resolution		0.1 (second, minute, hour)			
	Accuracy		± (0.1% + 0.1 sec)			
Dwell			0.5 - 999.9 (1.0 – 999.9 when linked), 0 = Constant			
	Resolution		0.1 second, minute, hour			
	Accuracy		± (0.1% + 0.1 sec)			
Ramp Down	Range	AC	0.5 - 999.9			
		DC	1.0 - 999.9, 0 = OFF			
	Resolution		0.1 (second, minute, hour)			
	Accuracy		± (0.1% + 0.05 sec.)			
Phase Setting	Linking		A/B/C 3Φ4W (120°), L1 - N & L2 - N 1Φ3W (180°)			
Prompt			Alphanumeric			
Start Angle			0° - 359°			
End Angle			0° - 359°			
Start & End Angle	Resolution		1°			
	Accuracy		±1% (45 Hz - 65 Hz)			
Connect			ON, OFF			
Transient			ON, OFF (Only 40 Hz - 70 Hz is available)			
Trans-Volt			0.0 V - 300.0 V			
Trans-Site			0.0 - 25.0 msec			
Trans-Time			0.5 - 999.9 msec			
Trans-Cycle			0-9999, 0=Constant			

**SYSTEM
PARAMETERS**

		310XAC	320XAC	340XAC	360XAC
Auto Run		Program, Manual			
Output Mode	Manual	AC, DC			
Single Step	Program	ON, OFF			
Alarm		0 - 9, 0 = OFF, 9 = High			
Contrast		1 - 9, 9 = High			
Power Up		ON, OFF, LAST			
Loop Cycle	Program	0 - 9999, 0 = Cont., 1 = OFF			
Results		LAST, P/F, ALL			
OC Fold		ON, OFF; response time < 1.4 seconds			
Transient	Manual	ON, OFF			
Lock		ON, OFF			
Mem Lock		ON, OFF			
Volt Sense		INT, EXT			
Synch Signal		START, EVENT, OFF, 5 V DC Signal			
Linking		AUTO DETECT (Parallel, 1Φ3W, 3Φ4W)			
Re-Config		YES, NO			
Address		IP, GPIB, RS-485			

GENERAL		310XAC	320XAC	340XAC	360XAC
Safety Agency Listing		CE, cTUVus, RoHS2			
Enhanced Over Load Capacity		Over current 110% can hold for 1000 ms without protection			
Operation Key Feature		Soft key, Numeric Key, Rotary Knob			
Remote Output Signal		Output (Pass, Fail, Test in Process)			
Calibration		Front Panel			
Key Lockout		Soft Key & Password Protected			
Synch Output Signal		5 V DC			
Graphic Display		260 x 64 Monographic, LCD			
Interface		USB/RS-232, Optional GPIB or Ethernet			
Barcoding		Barcode Capable			
Protection Circuit		Over Current, Over Temperature, Over Power, Over Voltage			
Fan		Temperature Controlled			
Rear Output		Terminal Block			
Rack Mount Handles		Standard			No Caster Wheels
PFC		97% at Full Load			
Efficiency		75% at Full Load		80% at Full Load	
CE Mark		Yes			
Parallel/Poly-Phase Output		Multiple Source Linking: L1 - N & L2 - N 1Φ3W (180°), A/B/C 3Φ4W (120°)			
Operation Environment		0 - 40°C / 20 - 80% RH			
Dimensions		430 (W) x 133.5 (H) x 530 (D) mm		430 (W) x 267 (H) x 500 (D) mm	430 (W) x 400.5 (H) x 500 (D) mm
Net Weight		21 Kg	22 Kg	37 kg	53 Kg



OPTIONS			310XAC	320XAC	340XAC	360XAC
Grounded Neutral	Option	2	All Models			
GPIB Card	Option	3	All Models			
7 Remote Memories Select	Option	4	Input (Test, Reset, Recall Memory 1 - 7)			
Ethernet/RS-232/Barcode	Option	5	All Models			
Linking Card	Option	8	All Models			

LINKING PARALLEL AC OUTPUT 1Φ2W							310XAC	320XAC	340XAC	360XAC
Linked Units			2 - 3 Units, 1Φ2W (L1 - N)							
Voltage		Phase		5 - 300 V			5 - 300 V			
Power Max	# Units	2	1.8 KVA	3.6 KVA	7.2 KVA	10.8 KVA				
		3	2.7 KVA	5.4 KVA	10.8 KVA	16.2 KVA				
Max Current <i>Line</i>	5 - 150 V	L(2)	14.72 A @ > 20 V and < 120 V	29.44 A @ > 20 V and < 120 V	58.88 A @ > 20 V and < 120 V	88.32 A @ > 20 V and < 120 V				
		L(3)	22.08 A @ > 20 V and < 120 V	44.16 A @ > 20 V and < 120 V	88.20 A @ > 20 V and < 120 V	132.48 A @ > 20 V and < 120 V				
	5 - 300 V	H(2)	7.36 A @ > 20 V and < 240 V	14.72 A @ > 20 V and < 240 V	29.44 A @ > 20 V and < 240 V	44.16 A @ > 20 V and < 240 V				
		H(3)	11.04 A @ > 20 V and < 240 V	22.08 A @ > 20 V and < 240 V	44.16 A @ > 20 V and < 240 V	66.24 A @ > 20 V and < 240 V				

LINKING POLY-PHASE AC OUTPUT 1Φ3W							310XAC	320XAC	340XAC	360XAC
Linked Units			2 Units @ 180°, 1Φ3W (L1-L2 - N)							
Voltage	Phase		10 - 600 V			10 - 600 V				
	Line		5 - 300 V			5 - 300 V				
Power	Max		2 KVA	4 KVA	8 KVA	12 KVA				
Max Current <i>Phase</i>	5 - 300 V	L(1)	9.2 A @ 100 V	18.4 A @ 110 V	36.8 A @ 110 V	55.2 A @ 110 V				
	5 - 600 V	H(1)	4.6 A @ 220 V	9.2 A @ 220 V	18.4 A @ 220 V	27.6 A @ 220 V				
Max Current <i>Line</i>	5 - 300 V	L(2)	9.2 A @ 220 V	18.4 A @ 220 V	36.8 A @ 220 V	55.2 A @ 220 V				
	5 - 600 V	H(2)	4.6 A @ 440 V	9.2 A @ 440 V	18.4 A @ 440 V	27.6 A @ 440 V				

LINKING POLY-PHASE AC OUTPUT 3Φ4W							310XAC	320XAC	340XAC	360XAC
Linked Units			3 Units @ 120°, 3Φ4W (L1-L2-L3 - N)							
Voltage	Phase		5 - 300 V			5 - 300 V				
	Line		5 - 520 V			5 - 520 V				
Power	Max		3 KVA	6 KVA	12 KVA	18 KVA				
Max Current <i>Phase</i>	5 - 150 V	L(1)	9.2 A @ 110 V	18.4 A @ 110 V	36.8 A @ 110 V	55.2 A @ 110 V				
	5 - 300 V	H(1)	4.6 A @ 220 V	9.2 A @ 220 V	18.4 A @ 220 V	27.6 A @ 220 V				
Max Current <i>Line</i>	5 - 150 V	L(3)	9.2 A @ 190.5 V	18.4 A @ 190.5 V	36.8 A @ 190.5 V	55.2 A @ 190.5 V				
	5 - 300 V	H(3)	4.6 A @ 381 V	9.2 A @ 381 V	18.4 A @ 381 V	27.6 A @ 381 V				
Max Current <i>Phase Delta</i>	5 - 260 V	L(3)	5.31 A @ 190.5 V	10.62 A @ 190.5 V	21.24 A @ 190.5 V	31.87 A @ 190.5 V				
	5 - 520 V	H(3)	2.65 A @ 381 V	5.31 A @ 381 V	10.62 A @ 381 V	15.93 A @ 381 V				

**LINKING PARALLEL DC OUTPUT
1Φ2W**

			310XAC	320XAC	340XAC	360XAC
Linked Units			2 - 3 Units, 1Φ2W (L1 - N)			
Voltage Line			5 - 420 V		5 - 420 V	
Power Max	# Units	2	1.6 KVA	3.2 KVA	6.4 KVA	9.6 KVA
		3	2.4 KVA	4.8 KVA	9.6 KVA	14.4 KVA
Max Current Line	5 - 210 V	L(2)	7.68 A @ 210 V	15.36 A @ 210 V	30.72 A @ 210 V	46.08 A @ 210 V
		L(3)	11.52 A @ 210 V	23.04 A @ 210 V	46.08 A @ 210 V	69.12 A @ 210 V
	5 - 420 V	H(2)	3.84 A @ 420 V	7.68 A @ 420 V	15.36 A @ 420 V	23.04 A @ 420 V
		H(3)	5.76 A @ 420 V	11.52 A @ 420 V	23.04 A @ 420 V	34.56 A @ 420 V

MEASUREMENT (Total)

LINKING PARALLEL 1Φ2W

			310XAC	320XAC	340XAC	360XAC
Voltage	Range		0.0 - 400.0 V			
	Resolution		0.1 V			
	Accuracy		± (1% of reading + 2 counts) > 5 V		± (1% of reading + 5 counts) > 5 V	
Frequency	Range		0.0 - 1000.0 Hz			
	Resolution		0.1 Hz			
	Accuracy	L	± 0.1 Hz @ 0.0 - 500 Hz			
H		± 0.2 Hz @ 501 - 1000 Hz				
Current (rms)	Range	2	0.00 A - 26.00 A	0.00 A - 52.00 A	0.00 A - 104.0 A	0.00 A - 156.0 A
		3	0.00 A - 39.00 A	0.00 A - 78.00 A	0.00 A - 156.0 A	0.00 A - 234.0 A
	Resolution		0.01 A		0.01A ≤ 99.99A, 0.1A > 100.0A	
	Accuracy	L	± (1.5% of reading + 15 counts) x # of Linked Units @ 40 - 70 Hz & Current is > 1.00 A		± (1.5% of reading + 15counts)x Link Units at 40 - 70Hz, and current(r.m.s) > 2.00A	± (1.5% of reading + 15counts)x Link Units at 40 - 70Hz, and current(r.m.s) > 3.00A
		H	± (1.5% of reading + 15 counts) x # of Linked Units @ 70.1 - 1000 Hz & Current is > 5.00 A			
Power (W)	Range	2	0 W - 2600 W	0 W - 5200 W	0 W -10400 W	0 W - 15600 W
		3	0 W - 3900 W	0 W - 7800 W	0 W - 15600 W	0 W - 23400 W
	Resolution		1 W			
	Accuracy		± (2% of reading + 10 counts) x (# of Linked Units) at PF ≥ 0.2, 40 - 500 Hz, and Current > 5.0 A ± (2% of reading + 10 counts) x (# of Linked Units) at PF ≥ 0.3, 501 - 1000 Hz, and Current > 5.0 A			
Power Apparent (VA)	Range	2	0 W - 2600 VA	0 W - 5200 VA	0 W -10400 VA	0 W - 15600 VA
		3	0 W - 3900 VA	0 W - 7800 VA	0 W - 15600 VA	0 W - 23400 VA
	Resolution		1 VA			
	Accuracy		V x A, Calculated Value			

MEASUREMENT (Total)

LINKING PARALLEL 1Φ2W

		310XAC	320XAC	340XAC	360XAC
Power Reactive (Q)	Range	2	0 W - 2600 VAR	0 W - 25200 VAR	0 W - 10400 VAR
		3	0 W - 3900 VAR	0 W - 7800 VAR	0 W - 15600 VAR
	Resolution	1 VAR			
	Accuracy	$\sqrt{(VA)^2 - (W)^2}$, Calculated Value			

MEASUREMENT (Total)

LINKING PARALLEL 1Φ2W

Cont.

		310XAC	320XAC	340XAC	360XAC
Power Factor	Range	0 - 1.000			
	Resolution	0.001			
	Accuracy	W / VA, Calculated and displayed to three significant digits			

MEASUREMENT (Total)

LINKING POLY-PHASE 1Φ3W

			310XAC	320XAC	340XAC	360XAC
Voltage	Range	2	L1 Voltage + L2 Voltage			
	Resolution		0.1 V			
	Accuracy		Summation of linked sources, Calculated and displayed to one significant digit			
Frequency	Range		0.0 - 1000.0 Hz			
	Resolution		0.1 Hz			
	Accuracy	L	± 0.1 Hz @ 0.0 - 500 Hz			
		H	± 0.2 Hz @ 501 - 1000 Hz			
Current (rms)	Range	2	(L1 Current + L2 Current)/2			
	Resolution	L	0.001 A	X	X	
		H	0.01 A			
	Accuracy		± (1% of reading +5counts) at 40~70Hz ± (1% of reading +5counts) at 70.1~500Hz, and output current (r.m.s) > 0.200A ± (1% of reading +5counts) at 501~1000Hz, and output current (r.m.s) > 0.300A			
Power (W)	Range	2	L1 Power + L2 Power			
	Resolution	L	0.1 W	X	X	
		H	1 W			
	Accuracy	2	L1 Power + L2 Power, Calculated Value			
Power Apparent (VA)	Range	2	L1 VA + L2 VA			
	Resolution	L	0.1 VA	X	X	
		H	1 VA			
	Accuracy	2	L1 VA + L2 VA, Calculated Value			
Power Reactive (Q)	Range	2	L1 VAR + L2 VAR			
	Resolution	L	0.1 VAR		X	
		H	1 VAR			
Power Factor	Accuracy	2	L1 VAR + L2 VAR, Calculated Value			
	Range		0 - 1.000			
	Resolution		0.001			
	Accuracy		(L1 P + L2 P) / (L1 VA + L2 VA), Calculated and displayed to three significant digits			

MEASUREMENT (Total)

LINKING POLY-PHASE 3Φ4W

		310XAC	320XAC	340XAC	360XAC
Voltage	Range	(A+B+C)/√3			
	Resolution	0.1 V			
	Accuracy	(A+B+C)/3 , Calculated and displayed to one significant digit			
Frequency	Range	0.0 - 1000.0 Hz			
	Resolution	0.1 Hz			
	Accuracy	L	± 0.1 Hz @ 0.0 - 500 Hz		
		H	± 0.2 Hz @ 501 - 1000 Hz		
Current (rms)	Range	(A+B+C)/3			
	Resolution	L	0.001 A		
		H	0.01 A		
	Accuracy	± (1% of reading +5counts) at 40~70Hz ± (1% of reading +5counts) at 70.1~500Hz, and output current (r.m.s) > 0.200A ± (1% of reading +5counts) at 501~1000Hz, and output current (r.m.s) > 0.300A			
Power (W)	Range	A Power + B Power + C Power			
	Resolution	L	0.1 W	X	X
		H	1 W		
	Accuracy	Calculated Value			
Power Apparent (VA)	Range	A VA + B VA + C VA			
	Resolution	L	0.1 VA	X	X
		H	1 VA		
	Accuracy	Calculated Value			
Power Reactive (Q)	Range	A VAR + B VAR + C VAR			
	Resolution	1 VAR			
	Accuracy	Calculated Value			
Power Factor	Range	0 - 1.000			
	Resolution	0.001			
	Accuracy	Sum P / Sum VA, Calculated and displayed to three significant digits			

MEASUREMENT (Total)

LINKING PARALLEL DC

		310XAC	320XAC	340XAC	360XAC
Voltage	Range	0.0 - 420.0 V			
	Resolution	0.1 V			
	Accuracy	± (1% of reading + 2 counts) > 5 V		± (1% of reading + 5 counts) > 5 V	
Current	Range	2	0.05 A - 26.00 A	0.05 A - 52.00 A	0.05 A - 104.00 A
		3	0.05 A - 39.00 A	0.05 A - 78.00 A	0.05 A - 156.00 A
	Resolution	0.01 A			
	Accuracy		± (1% of reading + 5 counts) x # of Linked Units, Current > 1.00 A	± (1% of reading + 5 counts) x # of Linked Units, Current > 1.00 A	± (1% of reading + 5 counts) x # of Linked Units, Current > 2.00 A
Power (W)	Range	2	0 W - 2600 W	0 W - 25200 W	0 W - 10400 W
		3	0 W - 3900 W	0 W - 7800 W	0 W - 15600 W
	Resolution	1 W			
Accuracy	± (2% of reading + 5 counts) x # of Linked Units				

Why use the term “Counts”?

Associated Power Technologies publishes some specifications using COUNTS which allows us to provide a better indication of the tester’s capabilities across measurement ranges. A COUNT refers to the lowest resolution of the display for a given measurement range. For example, if the resolution for voltage is 1V then 2 counts = 2V.

3.2 Instrument Controls

3.2.1 Front Panel Controls

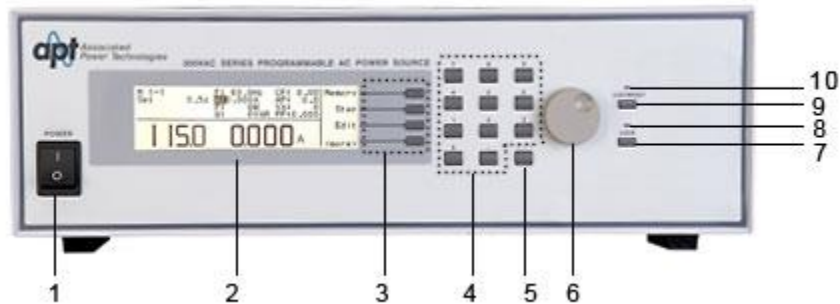

1. **Power Switch:** Rocker style power switch with international ON (|) and OFF (0). Please refer to pg. 10 for proper installation of a disconnecting device.
2. **Graphic LCD:** 240 x 64 Monographic LCD.
3. **Soft Keys:** Multifunctional selection keys used to select parameters, select screens, and edit parameters.
4. **Number Keypad:** Keys used to enter numerical data.
5. **Delete Key:** Used to delete text characters and numerical data.
6. **Rotary Knob:** Used to adjust the voltage output in MANUAL Mode, or DC Mode.
7. **Lock Key:** Used to lock out the front panel.
8. **Lock LED:** When lit indicates the instrument front panel is locked.
9. **Test/Reset Key:** Used to turn ON/OFF output voltage, or used to reset the instrument in the event of a failure condition.
10. **Test/Reset LED:** When lit indicates output is active, or when blinking indicates the instrument is in a failure condition.

3.2.2 Rear Panel Controls

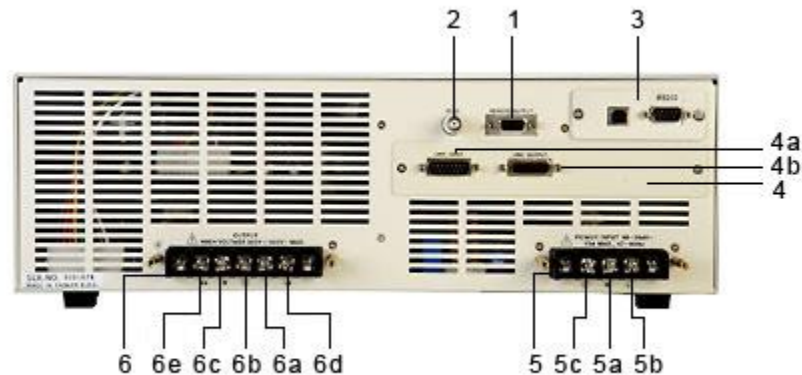

1. **Remote Output Connector:** Provides output to monitor PASS, FAIL, Test-In-Process via relay contact closures.
2. **Sync Output Connector:** Provides the capability to monitor a 5 VDC output signal.
3. **Automated Interface Card:** Interface card used to control, program, and capture data.
4. **Linking Card (Opt. 08):** provides input and output communication ports for operating multiple instruments in parallel and polyphase modes.
 - 4a. **Interface Input:** Interface input connector for connecting the instrument to a master power source. Connecting the interface cable to this port automatically designates the instrument as a slave unit.
 - 4b. **Interface Output:** Interface output connector for connecting the instrument to a slave power source. Connecting the interface cable to this port automatically designates the instrument as a master unless an interface cable is also connected to the Interface Input port (in this case the instrument is automatically configured as a slave).
5. **Input Terminal Power Block:** provides input power to the instrument. Models 310XAC and 320XAC require 90-264 VAC 1Ø, 47-63 Hz.
 - 5a. N: Neutral input screw terminal.

5b. L: Line input screw terminal.

5c. G: Earth ground (chassis) connection.

6. Output Terminal Power Block: provides output power to the DUT.

6a. L: Line output screw terminal.

6b. G: Earth ground (chassis) connection.

6c. N: Neutral output screw terminal.

6d. Ls: Line voltage sense screw terminal.

6e. Ns: Neutral sense screw terminal.

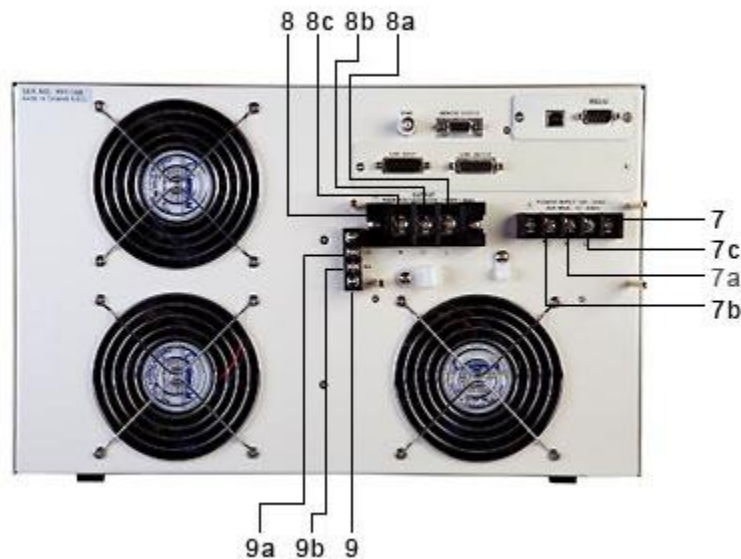

7. Input Terminal Power Block: provides input power to the instrument.
Model 340XAC requires 180-284 VAC 1Ø, 47-63 Hz.

7a. N: Neutral input screw terminal.

7b. G: Earth ground (chassis) connection.

7c. L: Line input screw terminal.

8. Output Terminal Power Block: provides output power to the DUT.

8a. L: Line output screw terminal.

8b. G: Earth ground (chassis) connection.

8c. N: Neutral output screw terminal.

9. External Sense Output Terminal Block: provides screw terminals for external voltage sense leads.

9a. L: Line voltage sense screw terminal.

9b. N: Neutral voltage sense screw terminal.

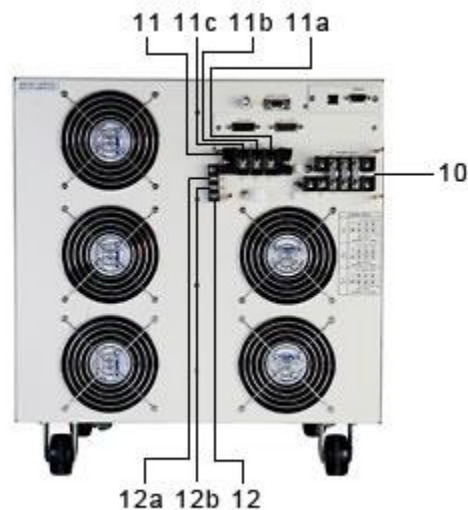

10. Input Terminal Power Block: provides input power to the instrument.
Model 360XAC requires 180-264 VAC 1Ø, 180-264 VAC 3Ø or 312-457 VAC 3Ø at 47-63 Hz.

11. Output Terminal Power Block: provides output power to the DUT.

11a. L: Line output screw terminal.

11b. G: Earth ground (chassis) connection.

11c. N: Neutral output screw terminal.

12. External Sense Output Terminal Block: provides screw terminals for external voltage sense leads.

12a. L: Line voltage sense screw terminal.

12b. N: Neutral voltage sense screw terminal.

3.2.3 Soft Keys

The soft keys enable the operator to navigate through the instrument, change the meter display, name files, and change parameters. Below is a list of all available soft keys.

Soft Key	Description
Memory	Allows you to enter the memory location to change a memory
Step	Allows you to change step location
Edit	Allows you to edit parameters
<more>	Allows you to move to additional selections
Result	Allows you to review the results after a test
System	Allows you to change the instruments settings and parameters
Exit	Allow you to exit the current screen
Name	Allow you to name a memory
List	Allows you to see the list of memories available
∨	Allows you to scroll through the list sequentially, or move down a character listing
Page ^	Allows you to page up through the list
Page ∨	Allows you to page down through the list
Load	Allows you to load a memory
Enter	Allows you to enter a parameter
Esc	Allows you to exit a parameter setting screen
<top>	Allows you to move to the previous screen of selections
>	Allows you to move to the right through a character listing
<	Allows you to move to the left through a character listing
Select	Allows you to select a memory
Meter	Allows you to toggle through the different meter settings/readings

Soft Key	Description
Edit	Allows you to enter a parameter screen to change a parameter
^	Allows you to scroll through the list sequentially
Prev	Allows you to scroll to the previous parameter setting
Next	Allows you to scroll to the next parameter setting
Change	Allows you to open up the parameter for changing
Result	Allows you to open up the results screen
System	Allows you to open up the parameters for the system
Cycle	Allows you to open the cycle mode
Keypad	Allows you to open the numeric keypad in test mode
Trig.	Allows you to trigger the surge/drop parameters in test mode

4. Programming Instructions

4.1 Powering on the Instrument

Turn on the Power switch located on the lower left-hand corner of the front panel. The Initialization screen will appear.

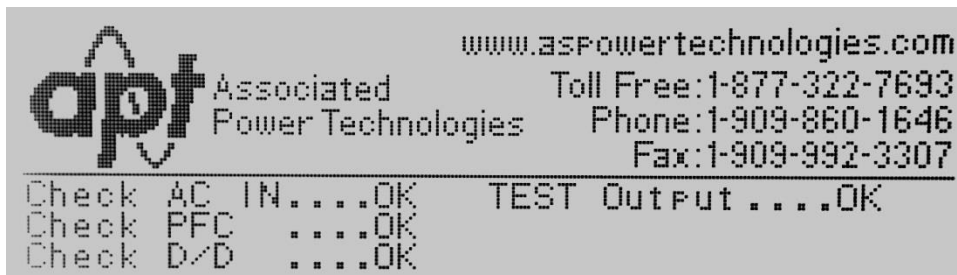

After a few seconds the Initialization screen will change to the Set screen. The Set screen will be displayed as follows when in PROGRAM Mode:



If you press the <more> soft key within the Set screen, the soft keys will change to include Result, System, and <top> in the PROGRAM Mode.



If you are in MANUAL Mode there will not be a step number 1 next to the M 1 and the Set screen will appear as follows:

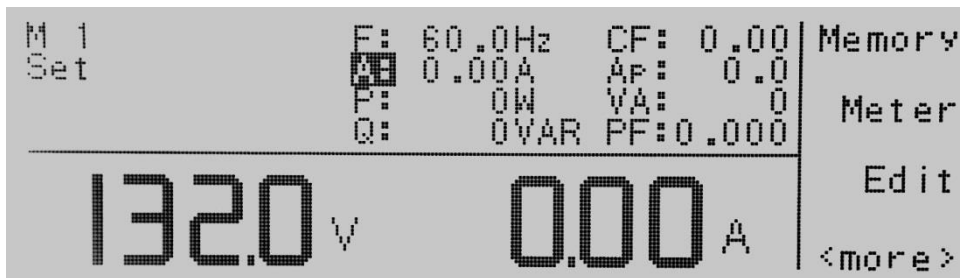

If you press the <more> soft key within the Set screen, the soft keys will change to Result, System, and <top> in the MANUAL Mode.



4.1.1 Set Screen Description

When the instrument is in the Set screen the parameters indicate their current settings. However, when the indicator LED is active on the Test/Reset key the parameter settings will display their output value.

Set Screen Parameters	Description of Parameters
M1-1	Memory and step location
1.0s	Instrument timer for output
F: 60.0 Hz	Frequency
Ap:	Peak Current
Set	Status of instrument at the present time. Possible readings are set, dwell, pass, abort, or other failure conditions.
P: 0.0W	Power
A: 0.000A	Current
PF: 0.000	Power Factor
Memory	Memory soft key used to change memory location
120.0V (left meter reading)	Meter for voltage
0.00A (right meter reading)	Meter for parameters of F, Ap, P, A & PF
Q: 0 VAR	Reactive Power
VA: 0	Apparent Power

CF: 0.00	Crest Factor
Parall-Master	Indicates the instrument is set up in Parallel mode as the master (Option 08 only)
Parall-Slave	Indicates the instrument is set up in Parallel mode as the slave (Option 08 only)
1Φ3W: L1-N	Indicates the instrument is set up in 1Φ3W mode as L1-N (Option 08 only)
1Φ3W: L2-N	Indicates the instrument is set up in 1Φ3W mode as L2-N (Option 08 only)
3Φ4W: A Phase	Indicates the instrument is set up in 3Φ4W mode as Phase A (Option 08 only)
3Φ4W: B Phase	Indicates the instrument is set up in 3Φ4W mode as Phase B (Option 08 only)
3Φ4W: C Phase	Indicates the instrument is set up in 3Φ4W mode as Phase C (Option 08 only)

4.1.2 Security

Creating a Password

Creating a password prevents unauthorized access to the Lock parameters in the System menu. Once a password has been created, lock functions will require the password to access them.

Press and hold the <top> soft key while powering up the instrument, the Edit Password screen should now be displayed. The display will appear as follows:

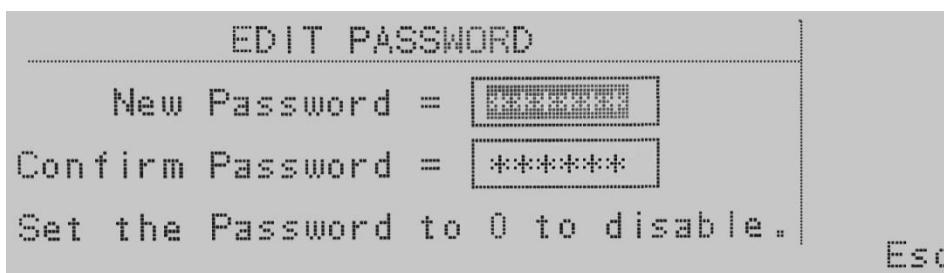

You may now type in the new password using the numeric keypad. Press the Enter key to accept the new password or press the Esc key to escape. After you type in your new password, you will be required to confirm your new password by typing it again into the “Confirm Password” field. Press the Enter key to confirm the new password or press the Esc key to escape.

If the password is set to 0, the Lock and Mem Lock parameters may be accessed by editing Lock and Mem Lock soft keys in the System Parameters menu. In this

case, the key lockout on the front panel is enabled by pressing the Lock button.

If the password has been set to anything but 0, a password entry pop-up screen will appear to access the Lock and Mem Lock parameters as well as key lockout on the front panel of the unit. The password default is preset to 0 at the factory.

Forgotten Password

If you have forgotten your password, a new password should be entered or enter “0” to disable the password. The old password cannot be recovered.

Secure Lock and Mem Lock Access

If a password has been created, when you press the Lock or Mem Lock soft key or the key lockout on the front panel, a password pop-up screen will appear. The pop-up message will appear as follows:



In order for you to access the Lock or Mem Lock parameters, you will now have to enter the proper password. If you have forgotten the password, please refer to the Forgotten Password instructions in the Security section.

4.1.3 Lock

From the Set screen press the <more> soft key. Press the System soft key. Highlight the Lock parameter using the ^, v soft keys. When the Lock parameter is highlighted, you may turn the function ON and OFF by pressing the Change soft key. Press the Enter key to accept the new setting or the Esc key to cancel and return to the original setting. When the Enter key is pressed, the new security setting will take immediate effect.

Selecting Lock “ON” restricts access to parameter and system settings. The level of security is determined by the Mem Lock function.

4.1.4 Mem Lock

From the Set screen press the <more> soft key. Press the System soft key.

Highlight the Mem Lock parameter using the \wedge , \vee soft keys. When the Mem Lock parameter is highlighted, you may turn the function ON and OFF by pressing the Change soft key. Press the Enter key to accept the new setting or the Esc key to cancel and return to the original setting.

Mem Lock is a sub-function of the Lock setting. In order for the Mem Lock function to work, the Lock must first be turned ON. Selecting the Mem Lock OFF will allow the user to access all available memory locations but restricts access to memory and step editing capabilities. Selecting the Mem Lock ON will allow the user to only run the currently loaded memory.

4.2 System Parameters Description

The system parameters change the overall operation of the AC power source. If the operator elects to edit the system parameters this will apply a universal change to every memory and step location for the AC power source when in the Test Parameters menu. The operator cannot independently change these settings from one memory or step location to another.

1. **Auto Run** - places the AC power source into one of two modes (PROGRAM/MANUAL). In the PROGRAM Mode the operator will have the ability to program individual memories and steps with user selectable testing parameters such as test time, high and low limits, etc.

In the MANUAL Mode the operator will have limited choices in selecting and editing testing parameters. The key difference is that in MANUAL Mode the operator cannot connect steps or have fixed testing times. The output is either ON or OFF in the MANUAL Mode.

2. **Out Mode** - configures the instrument for AC or DC voltage output.

3. **Single Step (PROGRAM mode)** - controls how the instrument will proceed from one test step to the next in a testing sequence when in the Auto Run mode of PROGRAM.

When this parameter is selected on the source will sequence from one test step to the next only when the Test/Reset key is pressed between each step. When the Single Step parameter is on the source will pause after each step has completed a test routine and passed based on the programmed testing parameters. If a PASS occurs for the step the operator can proceed to the next step in the sequence. If a FAIL occurs for the step the operator will not be able to proceed in the test sequence. They will have to restart from the beginning of the test sequence or step number one.

If the parameter is selected off the source will automatically sequence from one step the next regardless if a pass or failure has occurred for a particular step.

4. **Alarm** - controls the volume level of the alarm if a failure is detected. This setting is from 1 – 9 with 9 being the loudest volume level.

5. **Contrast** - controls the contrast of the display. The setting is from 1 – 9 with 9 being the darkest contrast.

6. **Power Up** - controls how the output will react once the power switch is toggled on. There are three selections (OFF, ON, LAST). When the parameter is in the OFF state the operator must initialize a test by pressing the Test/Reset key on power up. If the parameter is in the ON state the output will automatically be energized when the source is powered on. If the parameter is in the LAST state the source will provide an output according to how this setting was last programmed prior to powering off the source.

7. **Loop Cycle (PROGRAM Mode)** - allows the operator to program the source to automatically repeat an overall testing sequence when in the PROGRAM Mode. This eliminates the need for the operator to press the Test/Reset key or send multiple test commands to the source to repeat a test sequence. Loop Cycle is only selectable when the source is configured for AC output.

8. **V Hi-Lmt (MANUAL Mode)** - allows the operator to select a maximum voltage threshold or ceiling level when programming the output voltage in the testing parameters screen.

9. **V Lo-Lmt (MANUAL Mode)** - allows the operator to select a minimum voltage threshold or floor level when programming the output voltage in the testing parameters screen.

10. **F Hi-Lmt (MANUAL Mode)** - allows the operator to select a maximum frequency threshold or ceiling level when programming the output frequency in the testing parameters screen. F Hi-Lmt is only selectable when the source is configured for AC output.

11. **F Lo-Lmt (MANUAL Mode)** - allows the operator to select a minimum frequency threshold or floor level when programming the output frequency in the testing parameters screen. F Lo-Lmt is only selectable when the source is configured for AC output.

12. **Start Angle (MANUAL Mode)** - provides the operator the flexibility to select the starting angle of the sine wave when the output voltage is generated. Start Angle is only selectable when the source is configured for AC output.
13. **End Angle (MANUAL Mode)** - provides the operator the flexibility to select the ending angle of the sine wave when output voltage is terminated. End Angle is only selectable when the source is configured for AC output.
14. **Results** - changes how the data will be displayed on the LCD graphic display after a test is completed. There are three selections available (LAST, ALL, P/F). The LAST setting displays the last step within the program sequence. The ALL setting will display the results of every step within the test sequence in a list format. The P/F, or PASS/FAIL, will display banner text of PASS or FAIL depending on the results of the test.
15. **OC Fold** - reduces the voltage, or folds the voltage back, in a linear fashion while maintaining a constant current to help run inductive loads. Response time < 1.4 seconds.
16. **Transient (MANUAL Mode)** - allows the operator to perform transient testing while in Manual Mode. Transient is only selectable when the source is configured for AC output.
17. **Lock** – allows the operator to lock out the buttons and rotary knob on the front panel. The level of security is determined by the Mem Lock function.
18. **Mem Lock** – allows the operator to restrict access to memory and step locations. Lock must be set to ON in order for Mem Lock to function.
19. **Volt Sense** - configures the for internal or external voltage sensing. If internal is selected, the instrument will measure the output voltage at the output relay. If external is selected, the user must connect sensing wires from the Ls and Ns terminals located on rear panel output terminal block to the DUT. Using external sense will provide a more accurate measurement when a large voltage drop occurs over the output wires.
20. **Sync Signal** - provides an output signal that may be used to trigger an oscilloscope. The output signal is provided on the rear panel via the BNC connector labeled Sync. There are 3 Sync signal options: 1) OFF: the Sync output is disabled, 2) ON: the Sync signal is active during testing, 3) EVENT: the Sync signal is active when the output voltage changes.

21. Function (Option 08) - configures instruments for either Parallel, 1 Φ 3W or 3 Φ 4W operation when multiple AC power sources are interconnected. Parallel operation allows the operator to increase the total output current by connecting 2 or 3 sources in parallel. 1 Φ 3W operation allows the operator to increase the output voltage to 600 VAC using 2 sources outputting voltage at 180 degrees. 3 Φ 4W operation allows the operator to configure the instruments for 3 Φ operation.

4.3 Editing System Parameters

To edit System parameters press the <more> soft key from the set screen so the soft keys read Result, System, and <top>. The screen should be as follows when in PROGRAM Mode.



When the System soft key is pressed the system parameter screen will open and show all the parameters available for editing. The screen will look as follows:

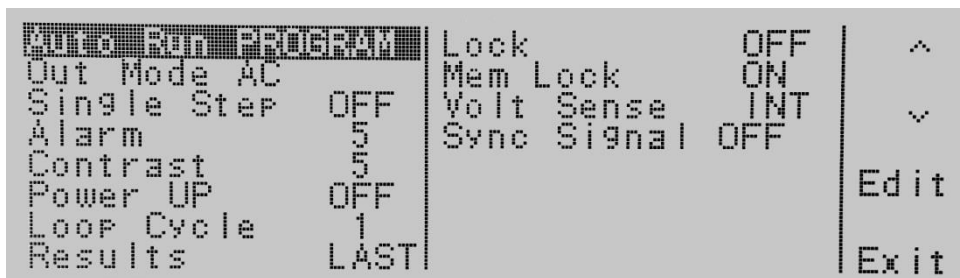

If the system parameters are set to MANUAL Mode, the screen will look as follows:



Use the ^, v soft keys to navigate through the System parameters. Press the Edit soft key to select the parameter. The parameter will be highlighted black if it is available for editing. Press the Edit soft key to open up the system parameter for editing. The Exit soft key will return you back to the set screen. If you open any System parameter screen you can navigate through the System parameters by using the Prev and Next soft keys.

4.3.1 Editing Auto Run Mode

Use the ^, v soft keys to navigate to the Auto Run parameter. Pressing the Edit soft key will provide the following screen:

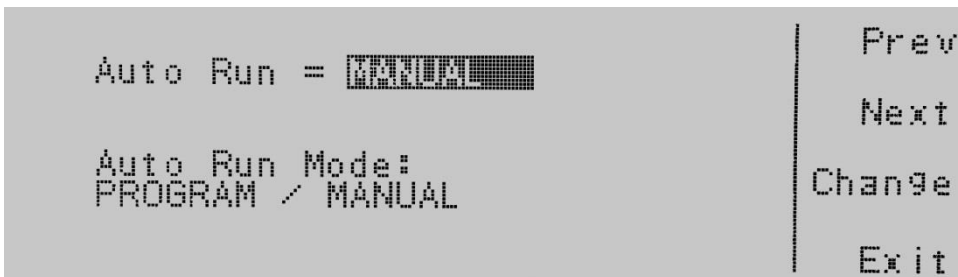

Auto Run = indicates the status of the run mode that is programmed into the instrument.

Auto Run Mode: indicates the run mode that can be programmed into the instrument.

Press the Change soft key to toggle the Auto Run Mode to PROGRAM/MANUAL. To save the parameter, press the Enter soft key. To cancel the editing of the Auto Run Mode, press the Esc soft key. When the Enter soft key is pressed the Auto Run Mode is accepted and you transition into the next system parameter: Out Mode.

4.3.2 Editing Out Mode

Use the ^, v soft keys to navigate to the Out Mode parameter. Pressing the Edit soft key will provide the following screen:

```

Out Mode = DC
Output Mode:
AC /DC
Prev
Next
Change
Exit
    
```

Out Mode = indicates the instrument is configured to output AC or DC voltage.

Output Mode: indicates the output mode that can be programmed into the instrument.

Press the Change soft key to toggle the Out Mode to AC or DC. To save the parameter, press the Enter soft key. To cancel the editing of the Out Mode, press the Esc soft key. When the Enter soft key is pressed the Out Mode is accepted and you transition into the next system parameter: Single Step.

4.3.3 Editing Single Step (PROGRAM Mode only)

Use the ^, v soft keys to navigate to the Single Step parameter. Pressing the Edit soft key will provide the following screen:

```

Single Step = OFF
Single Step Mode:
ON = TEST for next step.
OFF = Run all steps.
Prev
Next
Change
Exit
    
```

Single Step = indicates the status of the single step mode that is programmed into the instrument.

Single Step Mode: indicates the single step mode that can be programmed into the instrument.

Press the Change soft key to toggle the Single Step Mode to ON/OFF. To save

the parameter, press the Enter soft key. To cancel the editing of the Single Step Mode, press the Esc soft key. When the Enter soft key is pressed the Single Step Mode is accepted and you transition into the next system parameter: Alarm.

4.3.4 Editing Alarm

Use the \wedge , \vee soft keys to navigate to the Alarm parameter. Pressing the Edit soft key will provide the following screen:

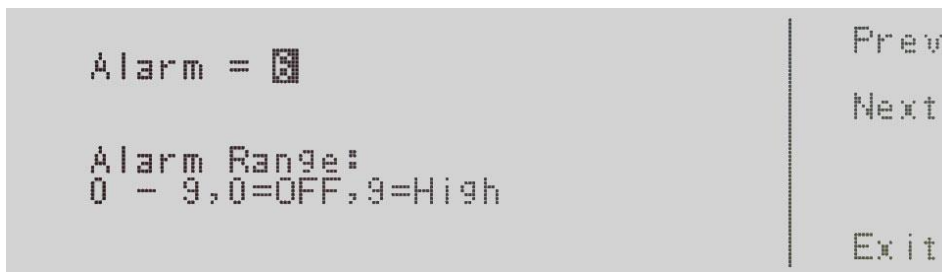

Alarm = indicates the status of the alarm volume that is programmed into the instrument.

Alarm Range: indicates the alarm range that can be programmed into the instrument.

Use the numeric keypad to enter in the alarm volume. Press the Enter soft key to accept the parameter. To cancel the editing of the alarm volume, press the Esc soft key. To move to the next system parameter for editing, press the Next or Prev soft key. The Exit soft key is also available to return to the System parameter screen. When the Enter soft key is pressed the Alarm volume is accepted and you transition into the next system parameter: Contrast.

4.3.5 Editing Contrast

Use the \wedge , \vee soft keys to navigate to the Contrast parameter. Pressing the Edit soft key will provide the following screen:



Contrast = indicates the status of the contrast setting that is programmed into the instrument.

Contrast Range: indicates the contrast range that can be programmed into the instrument.

Use the numeric keypad to enter in the contrast. The ranges available are 1 – 9, where 9 is the highest contrast or the darkest. Press the Enter soft key to accept the parameter. To cancel the editing of contrast setting, press the Esc soft key. To move to the next system parameter for editing, press the Next or Prev soft key. The Exit soft key is also available to return to the System parameter screen. When the Enter soft key is pressed the Contrast is accepted and you transition into the next system parameter: Power Up.

4.3.6 Editing Power Up

Use the \wedge , \vee soft keys to navigate to the Power Up parameter. Pressing the Edit soft key will provide the following screen:

```

Power UP = OFF
Power UP Mode:
ON = Output voltage on at
      power UP.
OFF = Output voltage off at
      power UP.
LAST= Same as last power down.

```

Prev
 Next
 Change
 Exit

Power UP = indicates the power up mode that is programmed into the instrument.

Power UP Mode: indicates the power up mode that can be programmed into the instrument.

The power up modes available are ON, OFF or LAST. In the ON mode output will be supplied on power up of the instrument. In the OFF mode output will NOT be supplied on power up of the instrument. In the LAST mode output will be supplied according to the last state the instrument was in prior to power off.

Press the Change soft key to toggle the Power UP Mode to ON/OFF/LAST. To save the parameter, press the Enter soft key. To cancel the editing of the Power Up feature press the Esc soft key. When the Enter soft key is pressed the Power Up parameter is accepted and you transition into the next system parameter.

4.3.7 Editing Loop Cycle (PROGRAM Mode only)

Use the \wedge , \vee soft keys to navigate to the Loop Cycle parameter (only selectable for AC output). Pressing the Edit soft key will provide the following screen:



Loop Cycle = indicates the number of loop cycles that will be performed when the output is active.

Loop Cycle Range: = indicates the selections available for the Loop Cycle Range.

The options available are 0 – 9999, 0=Cont., 1=Off. The 0 – 9999 selection programs the instrument to repeat the test cycle x number of times. The 0=Cont. selection indicates that the test loop will repeat in ∞ . The 1=Off selection indicates that the test loop will perform only one cycle. Use the numeric keypad to enter in the Loop Cycle Range. Press the Enter soft key to accept the parameter. To cancel the editing of Loop Cycle Range, press the Esc soft key. To move to the next system parameter for editing, press the Next or Prev soft key. The Exit soft key is also available to return to the System parameter screen. When the Enter soft key is pressed the Loop Cycle Mode is accepted and you transition into the next system parameter.

4.3.8 Editing V Hi-Lmt & V Lo-Lmt (MANUAL Mode only)

Use the \wedge , \vee soft keys to navigate to the V Hi-Lmt or V Lo-Lmt parameter. Pressing the Edit soft key will provide one of the following screens:



V Hi-Lmt = indicates the voltage high limit that is programmed into the instrument.

Voltage High Limit Range: indicates the voltage range that can be programmed into the instrument.

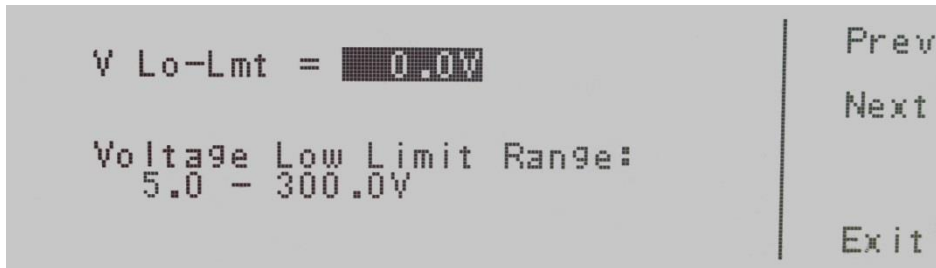

V L-Lmt = indicates the voltage low limit that is programmed into the instrument.

Voltage Low Limit Range: indicates the voltage range that can be programmed into the instrument.

To change the voltage high limit or low limit use the numeric keypad and type the voltage value. Once you type in a number a shaded black box (■) will begin blinking acknowledging the parameter is being changed. Press the Enter soft key to accept the parameter, or press the Esc key to move back to the V Hi-Lmt or V Lo-Lmt parameter screen. When the Enter soft key is pressed the voltage is accepted and you transition into the next system parameter: Frequency Limit.

If you wish to bypass editing this parameter and move to the next parameter you can press the Prev or Next soft key.

4.3.9 Editing F Hi-Lmt & F Lo-Lmt (MANUAL Mode only)

Use the \wedge , \vee soft keys to navigate to the F Hi-Lmt or F Lo-Lmt parameter (only selectable for AC output). Pressing the Edit soft key will provide one of the following screens:

F Hi-Lmt = indicates the frequency high limit that is programmed into the instrument.

Frequency High Limit Range: indicates the frequency range that can be programmed into the instrument.



F Lo-Lmt = indicates the frequency low limit that is programmed into the instrument.

Frequency Lo Limit Range: indicates the frequency range that can be programmed into the instrument

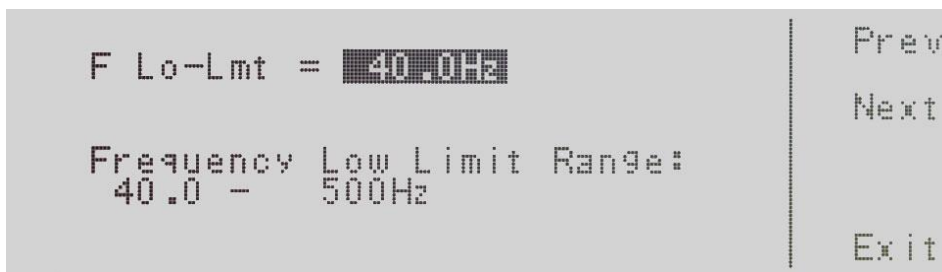

To change the frequency high limit or low limit use the numeric keypad and type the frequency value. Once you type in a number a shaded black box (■) will begin blinking acknowledging the parameter is being changed. Press the Enter soft key to accept the parameter, or press the Esc key to move back to the F Hi-Lmt or F Lo-Lmt parameter screen. When the Enter soft key is pressed the frequency is accepted and you transition into the next system parameter: Start and End Angle.

If you wish to bypass editing this parameter and move to the next parameter you can press the Prev or Next soft key.

4.3.10 Editing Start and End Angle (MANUAL Mode only)

Use the \wedge , \vee soft keys to navigate to the Start Angle or End Angle parameter (only selectable for AC output). Pressing the Edit soft key will provide one of the following screens:

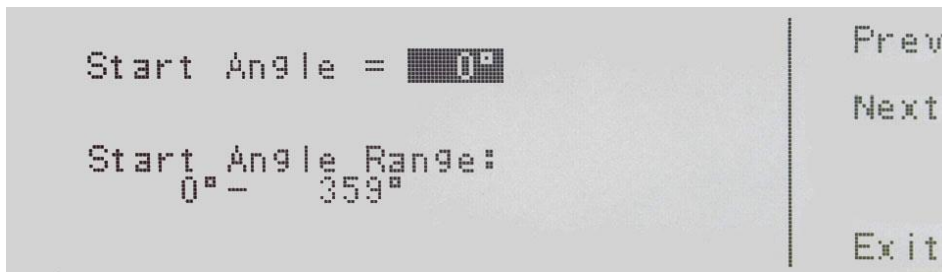

Start Angle = indicates the start angle that is programmed into the instrument.

Start Angle Range: indicates the start angle range that can be programmed into the instrument.



End Angle = indicates the end angle that is programmed into the instrument.

End Angle Range: indicates the end angle range that can be programmed into the instrument.

To change the start angle or end angle use the numeric keypad and type the degree value. Once you type in a number a shaded black box (■) will begin blinking acknowledging the parameter is being changed. Press the Enter soft key to accept the parameter, or press the Esc key to move back to the Start Angle or End Angle parameter screen. When the Enter soft key is pressed the degree angle is accepted and you transition into the next parameter: Results.

If you wish to bypass editing this parameter and move to the next parameter you can press the Prev or Next soft key.

4.3.11 Editing Results

Use the \wedge , \vee soft keys to navigate to the Results parameter. Pressing the Edit soft key will provide the following screen:

```

Results = LAST
Results Mode:
ALL = View all steps.
P/F = View full screen PASS
      or FAIL.
LAST = View only last step.
    
```

Prev
Next
Change
Exit

Results = indicates the results mode that is programmed into the instrument.

Results Mode: indicates the results mode that can be programmed into the instrument.

The Results Modes available are ALL, P/F, or LAST. The ALL mode will show all the testing results after the test is completed. The P/F mode will show only a pass/fail banner after the test is completed. The LAST mode will show only the last test or step that was performed when the test completes. Press the Change soft key to toggle the results mode to ALL, P/F, LAST. To save the parameter, press the Enter soft key. To cancel the editing of the Results Mode press the Esc soft key. When the Enter soft key is pressed the Results Mode is accepted and you transition into the next system parameter.

If you wish to bypass editing this parameter and move to the next parameter you can press the Prev or Next soft key.

4.3.12 Editing Transient (MANUAL Mode only)

Use the ^, v soft keys to navigate to the Transient parameter (only selectable for AC output). Pressing the Edit soft key will provide the following screens:

```

Transient = OFF
Transient Mode:
ON  = Enable the parameter
      in EDIT function.
OFF = Disable the parameter
      in EDIT function.
    
```

Prev
Next
Change
Exit

Transient = indicates the Transient Mode that is programmed into the instrument.

Transient Mode: indicates the Transient Modes that can be programmed into the instrument.

The Transient Modes available are ON and OFF. Press the Change soft key to toggle the mode to ON or OFF. To save the parameter, press the Enter soft key. To cancel the editing of the Transient Mode press the Esc soft key. When the Enter soft key is pressed the Transient Mode is accepted and you transition into the next system parameter: Lock.

If you wish to bypass editing this parameter and move to the next parameter you can press the Prev or Next soft key.

4.3.13 Editing OC Fold

Use the \wedge , \vee soft keys to navigate to the OC Fold parameter. Pressing the Edit soft key will provide the following screens:

```

OC Fold = 
Over Current Fold Mode:
ON = Enable voltage fold
    back mode.
OFF = Disable voltage fold
    back mode.
    
```

Prev

Next

Change

Exit

OC Fold = indicates the OC Fold Mode that is programmed into the instrument.

OC Fold Mode: indicates the OC Fold Mode that can be programmed into the instrument.

The OC Fold Modes available are ON and OFF. Press the Change soft key to toggle the mode to ON or OFF. To save the parameter, press the Enter soft key. To cancel the editing of the OC Fold Mode press the Esc soft key. When the Enter soft key is pressed the OC Fold Mode is accepted and you transition into the next system parameter: Transient.

If you wish to bypass editing this parameter and move to the next parameter you can press the Prev or Next soft key.

4.3.14 Editing Lock

Use the \wedge , \vee soft keys to navigate to the Lock parameter. Pressing the Edit soft key will provide the following screen:

```
Lock = OFF
Lock Mode.
ON = Keys are locked.
OFF = Keys are not locked.
Prev
Next
Change
Exit
```

Lock = indicates the security lock that is programmed into the instrument.

Lock Mode: indicates the lock mode that can be programmed into the instrument.

The Lock Modes available are ON and OFF. Press the Change soft key to toggle the mode to ON or OFF. To save the parameter, press the Enter soft key. To cancel the editing of the Lock Mode, press the Esc soft key. The level of security is determined by the Mem Lock function. When the Enter soft key is pressed the Lock Mode is accepted and you transition into the next system parameter: Mem Lock.

If you wish to bypass editing this parameter and move to the next parameter you can press the Prev or Next soft key.

4.3.15 Editing Mem Lock

Use the \wedge , \vee soft keys to navigate to the Mem Lock parameter. Pressing the Edit soft key will provide the following screen:

```
Mem Lock = OFF
Mem Lock Mode.
ON = Operator can not recall
    memories.
OFF = Operator can recall
    memories.
Prev
Next
Change
Exit
```

Mem Lock = indicates the security lock that is programmed into the instrument.

Mem Lock Mode: indicates the lock mode that can be programmed into the instrument.

The Mem Lock Modes available are ON and OFF. Press the Change soft key to toggle the mode to ON or OFF. To save the parameter, press the Enter soft key.

To cancel the editing of the Mem Lock Mode, press the Esc soft key. The Mem Lock parameter will only initiate if Lock Mode is set ON. When the Enter soft key is pressed the Mem Lock Mode is accepted and you transition into the next system parameter: Volt Sense.

If you wish to bypass editing this parameter and move to the next parameter you can press the Prev or Next soft key.

4.3.16 Editing Volt Sense

Use the \wedge , \vee soft keys to navigate to the Volt Sense parameter. Pressing the Edit soft key will provide the following screen:

```
Volt Sense = 0.0000
Voltage Sense Mode:
INT = Select internal Voltage:
EXT = Select external Voltage:
Change
Exit
Prev
Next
```

Volt Sense = indicates the voltage sense that is programmed into the instrument.

Voltage Sense Mode: indicates the voltage sense mode that can be programmed into the instrument.

The Volt Sense Modes available are INT and EXT. Press the Change soft key to toggle the mode to INT or EXT. To save the parameter, press the Enter soft key. To cancel the editing of the Volt Sense Mode, press the Esc soft key. When the Enter soft key is pressed the Volt Sense Mode is accepted and you transition into the next system parameter: Sync Signal.

If you wish to bypass editing this parameter and move to the next parameter you can press the Prev or Next soft key.

4.3.17 Editing Sync Signal

Use the \wedge , \vee soft keys to navigate to the Sync Signal parameter. Pressing the Edit soft key will provide the following screen:

```

Sync Signal = OFF
Sync Single Mode:
OFF = Output Disabled.
ON = Output During Testing.
EVENT= Output On Volt Change.
  
```

Prev
 Next
 Change
 Exit

Sync Signal = indicates the Synch signal that is programmed into the instrument.

Sync Signal Mode: indicates the Sync signal mode that can be programmed into the instrument.

The Synch Signal Modes available are OFF, ON, EVENT, and FREQ. Press the Change soft key to toggle the mode. To save the parameter, press the Enter soft key. To cancel the editing of the Sync Signal Mode, press the Esc soft key. When the Enter soft key is pressed the Sync Signal Mode is accepted and you transition into the next system parameter: Auto Run.

If you wish to bypass editing this parameter and move to the next parameter you can press the Prev or Next soft key.

4.3.18 Editing Function (Option 08 only)

Use the \wedge , \vee soft keys to navigate to the Function parameter. Pressing the Edit soft key will provide the following screen:

```

Function = 3Ø4W
Link Function Mode:
PARALLEL = 3 Linked Sources
           For 1Ø Output.
3Ø4W     = L1-N & L2-N & L3-N
           @ 120°.
  
```

Prev
 Next
 Change
 Exit

Function = indicates the Link Function mode for operating two instruments in a master-slave configuration.

Link Function Mode: indicates the Link Function mode that can be programmed into the instrument.

The Link Function Modes available are Parallel and 1 Φ 3W (two interconnected

instruments) or Parallel, 1 Φ 3W and 3 Φ 4W (three interconnected instruments). Press the Change soft key to toggle the mode. To save the parameter, press the Enter soft key. To cancel the editing of the Link Function Mode, press the Esc soft key. When the Enter soft key is pressed the Link Function Mode is accepted and you transition into the next system parameter: Auto Run.

If you wish to bypass editing this parameter and move to the next parameter you can press the Prev or Next soft key.

4.4 Using Memories and Steps (PROGRAM Mode only)

4.4.1 Selecting a Memory

When in the Set screen use the soft keys <more> or <top> to navigate so the first soft key shows Memory.



Now press the Memory soft key and you will see the following screen:



Memory = will show you the current memory that is active.

Name = will list the name of the memory location. If a name hasn't been programmed for the memory location this will be blank as shown above.

The Memory Range: indicates the valid range you can select for this parameter screen. You can select 1 through 50 memory locations.

Two methods are available in selecting a memory.

1. Type in the memory number from the numeric keypad. Once you type in a number a shaded black box (■) will begin blinking acknowledging the parameter is being changed. You will also receive new text at the bottom of the display “Enter to save, Esc to cancel”. To accept the data entry select the Enter soft key, or to cancel the data entry select the Esc soft key.



2. Press the List soft key to bring up a list of all programmed memories of the instrument. In order to get to the List soft key you will have to press the <more> soft key one time. The display will look as follows:



Next you will press the List soft key to provide a list of memories programmed into the instrument. The screen will look as follows:

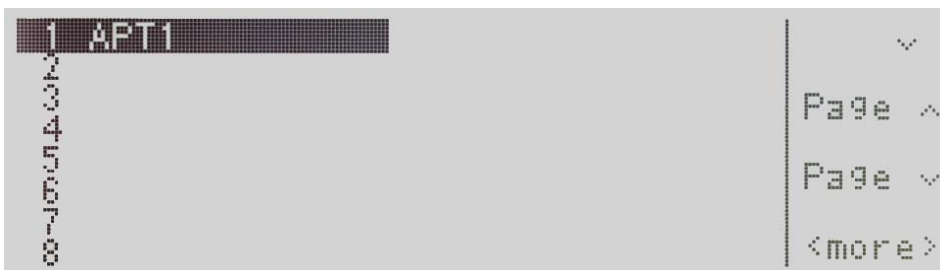

Navigation through the memory list is handled by the v, Page ^ and Page v soft keys. To select the memory list you must press the <more> soft key. The screen

will look as follows:

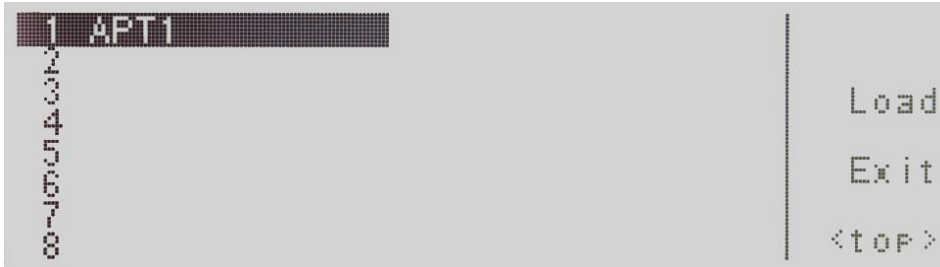

Now press the Load soft key, which will load the memory and bring you back to the set screen with the current memory and its parameters. If you press the Exit soft key you will be brought back to memory screen, and if you press the Exit soft key again you will go back to the Set screen.

4.4.2 Naming a Memory

To name a memory location you will need to press the <more> soft key when in the memory screen.



Now press the Name soft key. This will bring you to the character map for entering the memory name. The numeric keypad is also available for creating a memory name. Press the <top> soft key to use the > soft key and v soft key. Press the Select soft key to choose your characters. If you use the numeric keypad the character will be entered automatically when the keypad is pressed. To delete a character use the <- - key on the numeric keypad. The memory name can not be longer than 10 characters. The screen will look as follows:



Now press the <more> soft key which will bring you to the following screen:



To save the memory under the current name you selected via the character map/numeric keypad press the Enter soft key.

Pressing the Esc soft key versus the Enter soft key will bring you back to the main memory screen. The screen is as follows:

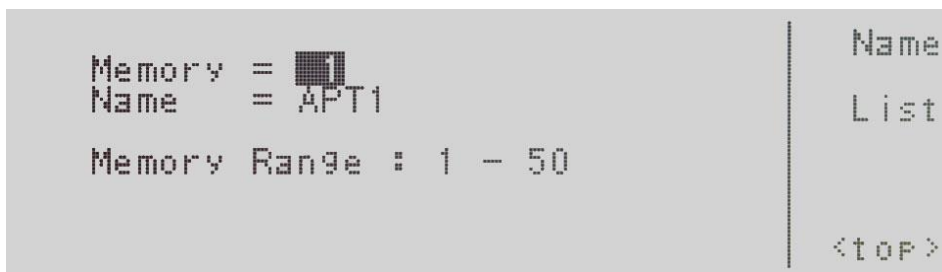

4.4.3 Selecting a Step

To select a step press the Step soft key and the steps will sequence through. Each time the Step soft key is pressed the step will increase by one increment. There are 9 steps available. After the 9th step you will return to step number 1.

4.5 Test Parameters Description

It is important to note that any changes made within the Test Parameter screen will be associated with the individual memory and step location indicated on the

display. These parameter settings when edited are not universal for each memory and step location. The operator must edit each individual memory location and step location if multiple test routines are required.

1. **Start Angle (PROGRAM Mode only)** - provides the operator the flexibility to select the starting angle of the sine wave when the output voltage is generated. Start Angle is only selectable when the source is configured for AC output.
2. **End Angle (PROGRAM Mode only)** - provides the operator the flexibility to select the ending angle of the sine wave when output voltage is terminated. End Angle is only selectable when the source is configured for AC output.
3. **Memory Cycle (PROGRAM Mode only)** - gives the operator the flexibility to program how many times the memory test sequence will repeat when in the PROGRAM Mode. This eliminates the need for the operator to press the Test/Reset key or send multiple test commands to the source to repeat a memory test sequence.
4. **Memory** - gives the operator the flexibility to change and edit the memory location (1-50).
5. **Step (PROGRAM Mode only)** - gives the operator the flexibility to change and edit the step location (1 – 9).
6. **Voltage** - gives the operator the flexibility to edit the voltage output.
7. **Frequency** - gives the operator the flexibility to edit the frequency output. Frequency is only selectable when the source is configured for AC output.
8. **Transient (PROGRAM Mode only)** - gives the operator the flexibility to enable or disable the transient function. Note: Transient Mode simulates the effect of high speed voltage spikes and sags. For this reason, when Transient Mode is set to ON, test parameters 9 through 28 will no longer be displayed. Transient is only selectable when the source is configured for AC output.
9. **Ramp Up (PROGRAM Mode only)** - gives the operator the flexibility to increase the voltage output over a duration of time prior to achieving the programmed output voltage.

10. Timer Unit (PROGRAM Mode only) - determines the time increment that will be used for testing when the source is in PROGRAM Mode. The operator can select between Second/Minute/Hour.

11. Delay (PROGRAM Mode only) - gives the operator the flexibility to program a time delay, or warm up time. There is a voltage output present from the source, but the high and low limit thresholds are essentially ignored during this period.

12. Dwell (PROGRAM Mode only) - gives the operator the flexibility to program the actual test time. This time begins after the ramp up time has completed. The high and low limit thresholds are active once the delay time has completed.

13. Ramp Down (PROGRAM Mode only) - gives the operator the flexibility to program a time duration in which the output voltage is reduced to zero after the dwell time has completed.

14. Step Cycle (PROGRAM Mode only) - gives the operator the flexibility to program the number of looping cycles for a particular step. For example if the operator would like to have a step repeat five times the step cycle would be programmed to five. Step Cycle is only selectable when the source is configured for AC output.

15. A Hi-Lmt (PROGRAM Mode) - gives the operator the flexibility to program a maximum current threshold or ceiling level. When this level is reached a failure will occur.

16. A Lo-Lmt (PROGRAM Mode only) - gives the operator the flexibility to program a minimum current threshold or floor level. If a minimum current level is not reached a failure will occur. This insures a load is attached to the power source and there is a minimum current present.

17. P Hi-Lmt (PROGRAM Mode only) - gives the operator the flexibility to program a maximum wattage threshold or ceiling level. When this level is reached a failure will occur.

18. P Lo-Lmt (PROGRAM Mode only) - gives the operator the flexibility to program a minimum wattage threshold or floor level. If a minimum wattage level is not reached a failure will occur. This insures a load is attached to the power source and there is a minimum wattage present.

19. **Ap Hi-Lmt (PROGRAM Mode only)** - gives the operator the flexibility to program a maximum peak current threshold or ceiling level. When this level is reached a failure will occur. Ap Hi-Lmt is only selectable when the source is configured for AC output.

20. **Ap Lo-Lmt (PROGRAM Mode only)** - gives the operator the flexibility to program a minimum peak current threshold or floor level. If a minimum peak current level is not reached a failure will occur. This ensures a load is attached to the power source and there is a minimum peak current present. Ap Lo-Lmt is only selectable when the source is configured for AC output.

21. **CF Hi-Lmt (PROGRAM Mode only)** - gives the operator the flexibility to program a maximum crest factor threshold or floor level. When this level is reached a failure will occur. CF Hi-Lmt is only selectable when the source is configured for AC output.

22. **CF Lo-Lmt (PROGRAM Mode only)** - gives the operator the flexibility to program a minimum crest factor threshold or floor level. If a minimum crest factor level is not reached a failure will occur. CF Lo-Lmt is only selectable when the source is configured for AC output.

23. **PF Hi-Lmt (PROGRAM Mode only)** - gives the operator the flexibility to program a maximum power factor threshold or ceiling level. When this level is reached a failure will occur. PF Hi-Lmt is only selectable when the source is configured for AC output.

24. **PF Lo-Lmt (PROGRAM Mode only)** - gives the operator the flexibility to program a minimum power factor threshold or floor level. If a minimum power factor level is not reached a failure will occur. This insures a load is attached to the power source and there is a minimum power factor present. PF Lo-Lmt is only selectable when the source is configured for AC output.

25. **VA Hi-Lmt (PROGRAM Mode only)** - gives the operator the flexibility to program a maximum apparent power threshold or floor level. When this level is reached a failure will occur. VA Hi-Lmt is only selectable when the source is configured for AC output.

26. **VA Lo-Lmt (PROGRAM Mode only)** - gives the operator the flexibility to program a minimum apparent power threshold or floor level. If a minimum apparent power level is not reached a failure will occur. VA Lo-Lmt is only selectable when the source is configured for AC output.

27. Q Hi-Lmt (PROGRAM Mode only) - gives the operator the flexibility to program a maximum reactive power threshold or floor level. When this level is reached a failure will occur. Q Hi-Lmt is only selectable when the source is configured for AC output.

28. Q Lo-Lmt (PROGRAM Mode only) - gives the operator the flexibility to program a minimum reactive power threshold or floor level. If a minimum reactive power level is not reached a failure will occur. Q Lo-Lmt is only selectable when the source is configured for AC output.

29. Trans-Volt - gives the operator the flexibility to program a surge or drop in the voltage output. Whether the voltage is a surge or a drop depends on the voltage that is programmed for this parameter. For example if the output voltage is programmed at 120 volts and the operator programs in a Trans-Volt of 150 volts this would be a surge of 30 volts. The opposite holds true; if the Trans-Volt is programmed at 90 volts this would be a drop of 30 volts. Trans-Volt is only selectable when the source is configured for AC output.

30. Trans-Site - gives the operator the flexibility to program the specific point in the sine wave to initialize the surge or the drop voltage. For example since a 60 Hz sine wave occurs 60 times per second, if the operator programs the Trans-Site for 8 milliseconds the surge or the drop voltage will occur at the halfway point (8 millisecond) of the sine wave or at the 180° point. Trans-Site is only selectable when the source is configured for AC output.

31. Trans-Time - gives the operator the flexibility to program the overall time duration of the surge or drop voltage. For example if the Trans-Site is 8 milliseconds; the output voltage is 120 volts; the surge voltage is 150 volts; and the Trans-Time is 20 milliseconds when the sine wave reaches the 8 millisecond point (180°) the voltage will surge to 150 volts. This surge will hold for 20 milliseconds before the voltage output returns to 120 volts. Trans-Time is only selectable when the source is configured for AC output.

32. Trans-Cycle - gives the operator the flexibility to program whether the transient voltage will occur continuously for each size wave of the test routine. The operator has the choice of selecting 0 or 1-9999. Trans-Cycle is only selectable when the source is configured for AC output.

33. Phase Set (Option 08 only) - gives the operator the flexibility to adjust the hi- and lo-limits for all phases during 1Φ3W and 3Φ4W modes. Selecting L1-N will allow the operator to set the limits for the instrument providing L1-N output voltage. Selecting L2-N will allow the operator to set the limits for the instrument providing the L2-N output voltage. Selecting Phase A, B, C will

allow the operator to set the limits for the instrument providing the Phase A, B, C output voltage. Limits must be set for each phase in all steps (PROGRAM mode only).

34. Prompt (PROGRAM Mode only) - gives the operator the flexibility to program a message unique to a particular step. The message will be shown on the LCD graphic display prior to the test beginning for that particular step test routine. At this point the test routine will be interrupted and the operator must press the Test/Reset key to begin the test sequence.

24. Connect (PROGRAM Mode only) - gives the operator the flexibility to program whether one step will be linked or connected to another step. For example in order to links step one to step two, the Connect parameter must be turned ON. Steps can only be connected in sequential order.

4.6 Editing Test Parameters

To edit testing parameters press the Edit soft key from the set screen. The following screen will be displayed if the system parameters are set to PROGRAM Mode:

```

Start Angle 0° | Timer Unit SECOND | ^
End Angle 0° | Delay 0.5s |
Memory Cycle 1 | Dwell 60.0s | v
Memory 1 | Ramp Down 0.0s |
Step 1 | Step Cycle 1 | Edit
Voltage 100.0V | Phase Set C |
Frequency 60.0Hz | A Hi-Lmt 9.00A |
Ramp UP 60.0s | <more> | Exit
  
```

```

A Lo-Lmt 0.00A | PF Lo-Lmt 0.000 | ^
P Hi-Lmt 0W | VA Hi-Lmt 0VA |
P Lo-Lmt 0W | VA Lo-Lmt 0VA | v
Ap Hi-Lmt 0.0A | Q Hi-Lmt 0VAR | Edit
Ap Lo-Lmt 0.0A | Q Lo-Lmt 0VAR |
CF Hi-Lmt 0.00 | Prompt |
CF Lo-Lmt 0.00 | Connect OFF | Exit
PF Hi-Lmt 0.000 |
  
```

Use the ^, v soft keys to navigate to the testing parameter that will be changed. When you press the Edit soft key you will be moved to the specific parameter screen for editing. If you press the Exit soft key you will be brought back to the set screen.

If the Transient parameter is turned OFF you will not see the testing parameters for Trans-Volt, Trans-Site, Trans-Time, and Trans-Cycle. If the Transient parameter is turned ON you will not see the testing parameters for Ramp Up, Timer Unit, Delay, Dwell, Ramp Down, Step Cycle, A Hi-Lmt, A Lo-Lmt, P Hi-Lmt, P Lo-Lmt, Ap Hi-Lmt, Ap Lo-Lmt, CF Hi-Lmt, CF Lo-Lmt, PF Hi-Lmt, PF Lo-Lmt, VA Hi-Lmt, VA Lo-Lmt, Q Hi-Lmt, and Q Lo-Lmt.

If the system parameters are set to MANUAL Mode the following display will be shown:

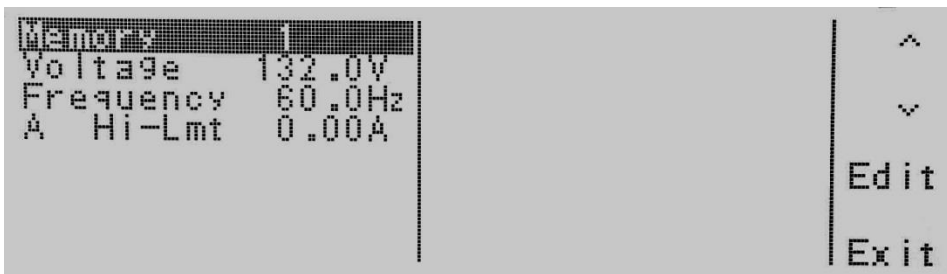

If the system parameters are set to MANUAL Mode and the Transient parameter is turned ON, the following display will be shown:

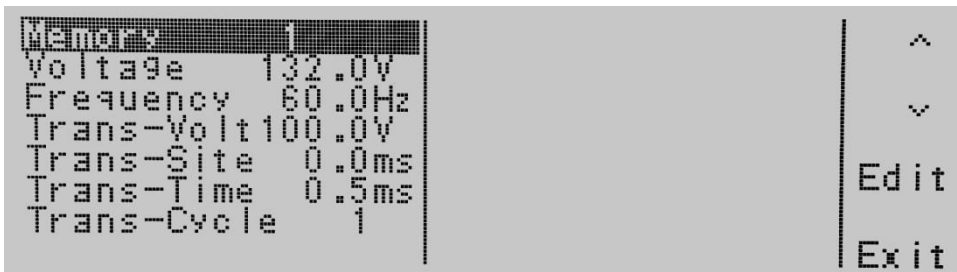

Use the ^, v soft keys to navigate to the testing parameter that will be changed. When you press the Edit soft key you will be moved to the specific parameter screen for editing. If you press the Exit soft key you will be brought back to the set screen.

4.6.1 Editing Start and End Angle (PROGRAM Mode only)

Use the ^, v soft keys to navigate to the Start Angle or End Angle parameter (only selectable for AC output). Pressing the Edit soft key will provide one of the following screens:

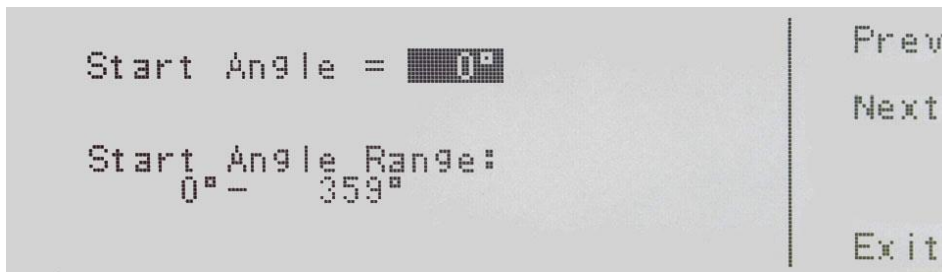

Start Angle = indicates the start angle that is programmed into the instrument.

Start Angle Range: indicates the start angle range that can be programmed into the instrument.



End Angle = indicates the end angle that is programmed into the instrument.

End Angle Range: indicates the end angle range that can be programmed into the instrument.

If you edit the start angle or end angle on a particular step, all 9 steps in that memory location will automatically be set to the same start angle and end angle.

If several steps are connected together to form a sequence of tests, the start angle will apply to the first step in the sequence and the end angle will apply to the last step in that sequence.

If memories are connected together as part of a test sequence, the start angle will apply to the first step in the sequence and the end angle will apply to the last step in the sequence. For example, memory 1 step 7 is linked to memory 1 step 8, memory 1 step 9 and memory 2 step 1 to create a four step sequence of tests. If the start angle is set to 90 degrees and the end angle is set to 180 degrees, the output voltage waveform at memory 1 step 7 will have a start angle at 90 degrees and the output voltage waveform at memory 2 step 1 will end at a 180 degree angle.

To change the start angle or end angle use the numeric keypad and type the

degree value. Once you type in a number a shaded black box (■) will begin blinking acknowledging the parameter is being changed. Press the Enter soft key to accept the parameter, or press the Esc soft key to move back to the Start Angle or End Angle parameter screen. When the Enter soft key is pressed the degree angle is accepted and you transition into the next parameter: Memory Cycle.

If you wish to bypass editing this parameter and move to the next parameter you can press the Prev or Next soft key.

4.6.2 Editing the Memory Cycle (PROGRAM Mode only)

Use the \wedge , \vee soft keys to navigate to the Memory Cycle parameter. Pressing the Edit soft key will provide the following screen:



Memory Cycle = indicates the number of cycles that will be performed when the output is active.

Memory Cycle Range: = provides the selections available for the Memory Cycle. The options available are 0 – 9999, 0=Cont., 1=Off. The 0 – 9999 selection programs the instrument to repeat the test cycle x number of times. The 0=Cont. selection indicates that the test cycle will repeat in ∞ . The 1=Off selection indicates that the test cycle will perform only one cycle.

To change the Memory Cycle, use the number keypad to select the memory cycle range and press the Enter soft key to accept the number. To cancel the editing of the Memory Cycle press, the Esc soft key. When the Enter soft key is pressed and the Memory Cycle is accepted, you transition into the next parameter: Memory.

If you wish to bypass editing this parameter and move to the next parameter you can press the Prev or Next soft key.

4.6.3 Editing the Memory (PROGRAM Mode only)

Use the \wedge , \vee soft keys to navigate to the Memory parameter. Pressing the Edit soft key will provide the following screen:

```
Memory = █  
Name   = APT1  
Memory Range : 1 - 50  
|  
Prev  
Next  
Exit  
<more>
```

Refer to section 4.3.1 for editing the Memory. If you wish to bypass editing this parameter and move to the next parameter you can press the Prev or Next soft key.

4.6.4 Editing the Step (PROGRAM Mode only)

Use the \wedge , \vee soft keys to navigate to the Step parameter. Pressing the Edit soft key will provide the following screen:

```
Step = █  
Step Range: 1 - 9  
|  
Prev  
Next  
Exit
```

Step = indicates the step location within the memory.

Step Range: 1 – 9 indicates the step ranges available for selection.

To change the step, use the numeric keypad to select the step number and press the Enter soft key to accept the step. To cancel the editing of the step number, press the Esc soft key.

The Step parameter can also be edited from the set screen. If you hit the Step soft key, you can use the Step + and Step – soft keys to increase or decrease the step number.

When the Enter soft key is pressed and the Step is accepted you transition into

the next parameter: Voltage.

If you wish to bypass editing this parameter and move to the next parameter you can press the Prev or Next soft key.

4.6.5 Editing Voltage

Use the \wedge , \vee soft keys to navigate to the Voltage parameter. Pressing the Edit soft key will provide the following screen:

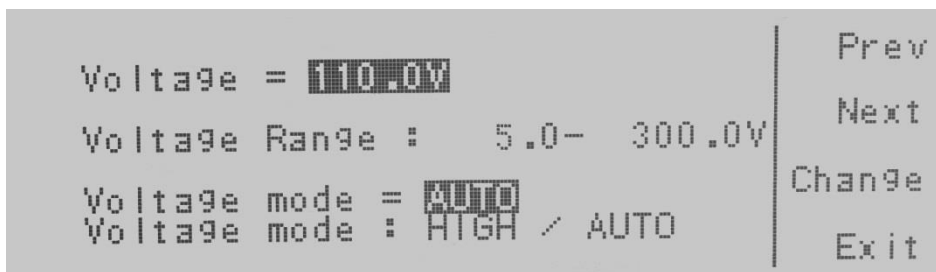

Voltage = indicates the voltage currently programmed into the instrument.

Voltage Range: 0.0- 300 indicates the voltage range that can be programmed into the instrument.

Voltage Mode: indicates whether the instrument is in the Auto or High mode.

Setting the Voltage mode to Auto, the system will automatically interpret the voltage range and switch to the high or low voltage output range. Setting the Voltage mode to High will put the output voltage into the high voltage output range and the current is limited to half as compared to the current limit in the low voltage output range. (Refer to the specification table in **3. Specifications and Controls** regarding current output based on voltage output range). Setting of voltage range may not influence the existing output voltage setting.

To change the voltage, use the numeric keypad and type the voltage. Once you type in a number a shaded black box (■) will begin blinking acknowledging the parameter is being changed. Press the Enter soft key to accept the parameter, or press the Esc soft key to move back to the voltage parameter screen. When the Enter soft key is pressed the voltage parameter is accepted and the system transitions into the next parameter: Frequency.

To change the Voltage mode from Auto to High press the Change soft key to toggle between the two selections. To accept the selection, press the Enter soft key. To cancel the selection, press the Esc soft key. You must press the Enter

soft key to accept the range. To transition into the next parameter of frequency output you must press the Next soft key if you do not change the voltage setting.

If you wish to bypass editing this parameter and move to the next parameter you can press the Prev or Next soft key.

4.6.6 Editing Frequency

Use the \wedge , \vee soft keys to navigate to the Frequency parameter (only selectable for AC output). Pressing the Edit soft key will provide the following screen:



Frequency = indicates the frequency currently programmed into the instrument. Frequency Range: 40.0 – 500 Hz indicates the frequency range that can be programmed into the instrument.

To change the frequency, use the numeric keypad and type the frequency. Once you type in a number a shaded black box (■) will begin blinking acknowledging the parameter is being changed. Press the Enter soft key to accept the parameter, or press the Esc key to move back to the Frequency Parameter screen. When the Enter soft key is pressed the frequency is accepted and you transition into the next parameter: Transient.

If you wish to bypass editing this parameter and move to the next parameter you can press the Prev or Next soft key.

4.6.7 Editing Transient * (PROGRAM Mode only)

Use the \wedge , \vee soft keys to navigate to the Transient parameter (only selectable for AC output). Pressing the Edit soft key will provide the following screens:

```

Transient = 0000
Transient Mode:
ON = Enable the parameter
    in EDIT function.
OFF = Disable the parameter
     in EDIT function.
  
```

Prev
 Next
 Change
 Exit

Transient = indicates the Transient mode that is programmed into the instrument.

Transient Mode: indicates the Transient mode that can be programmed into the instrument.

The Transient modes available are ON and OFF. Press the Change soft key to toggle the mode to ON or OFF. To save the parameter, press the Enter soft key. To cancel the editing of the Transient mode press, the Esc soft key. When the Enter soft key is pressed the Transient mode is accepted and you transition into the next parameter: Trans-Volt*.

If you wish to bypass editing this parameter and move to the next parameter you can press the Prev or Next soft key.

*If the Transient parameter is turned ON additional parameters of Trans-Volt, Trans-Site, Trans-Time, and Trans-Cycle will be present in the Test Parameters screen.

4.6.8 Editing Trans-Volt* (PROGRAM Mode only)

Use the ^, v soft keys to navigate to the Trans-Volt parameter (only selectable for AC output). Pressing the Edit soft key will provide the following screen:

```

Trans-Volt = 100.00V
Transient Voltage Range:
0.0 - 150.0V
  
```

Prev
 Next
 Exit

Trans-Volt = indicates the Trans-Volt that is programmed into the instrument.

Transient Voltage Range: indicates the transient voltage range that can be

programmed into the instrument.

To change the Transient voltage, use the numeric keypad and type the voltage. Once you type in a number a shaded black box (■) will begin blinking acknowledging the parameter is being changed. Press the Enter soft key to accept the voltage, or press the Esc soft key to move back to the Trans-Volt parameter screen. When the Enter soft key is pressed the voltage is accepted and you transition into the next parameter: Trans-Site.

If you wish to bypass editing this parameter and move to the next parameter you can press the Prev or Next soft key.

*Parameter is only available if the Trans parameter is turned ON.

4.6.9 Editing Trans-Site* (PROGRAM Mode only)

Use the ^, v soft keys to navigate to the Trans-Site parameter (only selectable for AC output). Pressing the Edit soft key will provide the following screen:



Trans-Site = indicates the transient site that is programmed into the instrument.

Transient Site Range: indicates the transient site range that can be programmed into the instrument.

To change the Transient site use the numeric keypad and type the time. Once you type in a number a shaded black box (■) will begin blinking acknowledging the parameter is being changed. Press the Enter soft key to accept the time, or press the Esc soft key to move back to the Trans-Site Parameter screen. When the Enter soft key is pressed the time is accepted and you transition into the next parameter: Trans-Time.

If you wish to bypass editing this parameter and move to the next parameter you can press the Prev or Next soft key.

*Parameter is only available if the Transient parameter is turned ON.

4.6.10 Editing Trans-Time* (PROGRAM Mode only)

Use the \wedge , \vee soft keys to navigate to the Trans-Time parameter (only selectable for AC output). Pressing the Edit soft key will provide the following screen:

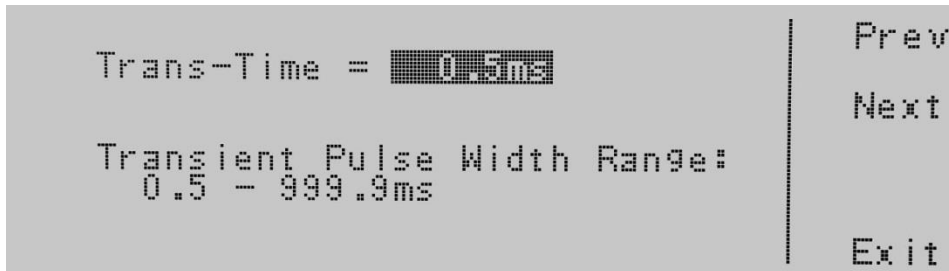

Trans-Time = indicates the Transient time that is programmed into the instrument.

Transient Pulse Width Range: indicates the Transient pulse width range that can be programmed into the instrument.

To change the Transient pulse width use the numeric keypad and type the time. Once you type in a number a shaded black box (■) will begin blinking acknowledging the parameter is being changed. Press the Enter soft key to accept the time, or press the Esc soft key to move back to the Trans-Time parameter screen. When the Enter soft key is pressed the time is accepted and you transition into the next parameter: Trans-Cont.

If you wish to bypass editing this parameter and move to the next parameter you can press the Prev or Next soft key.

*Parameter is only available if the Transient parameter is turned ON.

4.6.11 Editing Trans-Cycle* (PROGRAM Mode only)

Use the \wedge , \vee soft keys to navigate to the Trans-Cycle parameter (only selectable for AC output). Pressing the Edit soft key will provide the following screen:



Trans-Cycle = indicates the Transient mode that is programmed into the instrument.

Transient Trig Mode: indicates the Transient trigger mode that can be programmed into the instrument.

If the Transient Trig mode is ON the transient parameters previously programmed will trigger automatically once the test starts. This will continue to be active until the Trig. soft key is pressed or a failure occurs. If the Transient Trig Mode is OFF the Transient parameter previously programmed will only trigger when the Trig. soft key is pressed

For example, given the following parameters:

Parameter	Value
Output Voltage	100Vrms
Output Frequency	50 Hz
Transient Voltage	60Vrms
Transient Site	25ms
Transient Time	1ms

When the Trig. soft key is hit one time while the Trans-Cycle is set to OFF, the waveform will look like this:

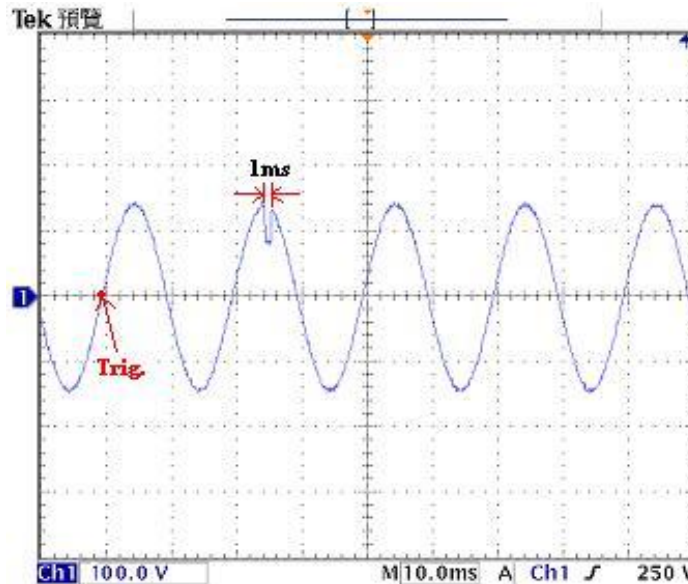

When the Enter soft key is pressed the time is accepted and you transition into the next parameter: Prompt

If you wish to bypass editing this parameter and move to the next parameter you can press the Prev or Next soft key.

*Parameter is only available if the Transient parameter is turned ON.

4.6.12 Editing Ramp Up (PROGRAM Mode only)

Use the \wedge , \vee soft keys to navigate to the Ramp Up parameter. Pressing the Edit soft key will provide the following screen:



Ramp Up = indicates the ramp up time that is programmed into the instrument.

Ramp Up Time Range: indicates the ramp up time range that can be

programmed into the instrument.

To change the ramp up time, use the numeric keypad and type the time. Once you type in a number a shaded black box (■) will begin blinking acknowledging the parameter is being changed. Press the Enter soft key to accept the time, or press the Esc key to move back to the Ramp Up Time Parameter screen. When the Enter soft key is pressed the time is accepted and you transition into the next parameter: Timer Unit.

If you wish to bypass editing this parameter and move to the next parameter you can press the Prev or Next soft key.

4.6.13 Editing Timer Unit (PROGRAM Mode only)

Use the ^, v soft keys to navigate to the Timer Unit parameter. Pressing the Edit soft key will provide the following screen:

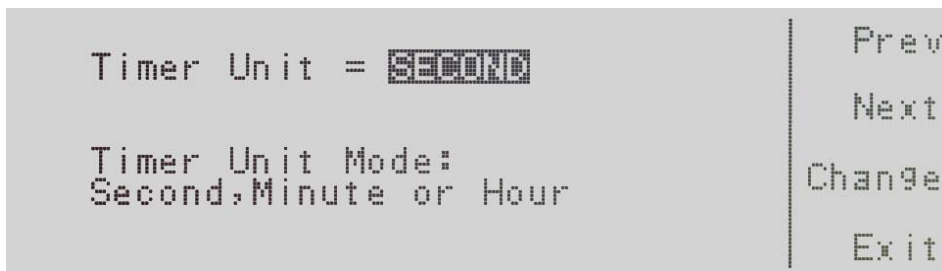

Timer Unit = indicates the timer unit mode that is programmed into the instrument.

Timer Unit Mode: indicates the timer unit mode that can be programmed into the instrument.

The power up modes available are Second, Minute or Hour. Press the Change soft key to toggle the timer unit mode to Second/Minute/Hour. To save the parameter, press the Enter soft key. To cancel the editing of the Timer Unit Mode, press the Esc soft key. When the Enter soft key is pressed the Timer Unit Mode is accepted and you transition into the next parameter: Delay Time.

4.6.14 Editing Delay (PROGRAM Mode only)

Use the ^, v soft keys to navigate to the Delay parameter. Pressing the Edit soft key will provide the following screen:



Delay = indicates the delay time that is programmed into the instrument.

Delay Time Range: indicates the delay time range that can be programmed into the instrument.

To change the delay time, use the numeric keypad and type the time. Once you type in a number a shaded black box (■) will begin blinking acknowledging the parameter is being changed. Press the Enter soft key to accept the time, or press the Esc soft key to move back to the Delay Time Parameter screen. When the Enter soft key is pressed, the time is accepted and you transition into the next parameter: Dwell.

If you wish to bypass editing this parameter and move to the next parameter you can press the Prev or Next soft key.

4.6.15 Editing Dwell (PROGRAM Mode only)

Use the \wedge , \vee soft keys to navigate to the Dwell parameter. Pressing the Edit soft key will provide the following screen:



Dwell = indicates the dwell time that is programmed into the instrument.

Dwell Time Range: indicates the dwell time range that can be programmed into the instrument.

To change the dwell time, use the numeric keypad and type the time. Once you

type in a number a shaded black box (■) will begin blinking acknowledging the parameter is being changed. Press the Enter soft key to accept the time, or press the Esc soft key to move back to the Dwell Time Parameter screen. When the Enter soft key is pressed, the time is accepted and you transition into the next parameter: Ramp Down.

If you wish to bypass editing this parameter and move to the next parameter you can press the Prev or Next soft key.

4.6.16 Editing Ramp Down (PROGRAM Mode only)

Use the ^, v soft keys to navigate to the Ramp Down parameter. Pressing the Edit soft key will provide the following screen:



Ramp Down = indicates the ramp down time that is programmed into the instrument.

Ramp Down Time Range: indicates the ramp down time range that can be programmed into the instrument.

To change the ramp down time, use the numeric keypad and type the time. Once you type in a number a shaded black box (■) will begin blinking acknowledging the parameter is being changed. Press the Enter soft key to accept the time, or press the Esc soft key to move back to the Ramp Down Time Parameter screen. When the Enter soft key is pressed the time is accepted and you transition into the next parameter: Step Cycle.

If you wish to bypass editing this parameter and move to the next parameter you can press the Prev or Next soft key.

4.6.17 Editing Step Cycle (PROGRAM Mode only)

Use the ^, v soft keys to navigate to the Step Cycle parameter (only selectable for AC output). Pressing the Edit soft key will provide the following screen:



Step Cycle = indicates the step cycle that is programmed into the instrument.

Step Cycle Range: indicates the step cycle range that can be programmed into the instrument.

The ranges available are 0 – 9999, 0=Cont., 1=Off. The 0 – 9999 selection programs the instrument to repeat the test step cycle x number of times. The 0=Cont. selection indicates that the test cycle will repeat in ∞ . The 1=Off selection indicates that the test cycle will perform only one cycle. When the “Enter” soft key is pressed the step cycle is accepted and you transition into the next parameter: A Hi-Lmt.

If you wish to bypass editing this parameter and move to the next parameter you can press the Prev or Next soft key.

4.6.18 Editing A Hi-Lmt & A Lo-Lmt (PROGRAM Mode only)

Use the \wedge , \vee soft keys to navigate to the A Hi-Lmt or Lo-Lmt parameter. Pressing the Edit soft key will provide one of the following screens:



A Hi-Lmt = indicates the current high limit that is programmed into the instrument.

Current High Limit Range: indicates the current range that can be programmed into the instrument. If you select the 0=OFF a high limit current range is turned OFF. The editing of the A Hi-Lmt parameter is available in the PROGRAM and

MANUAL Mode.



A Lo-Lmt = indicates the current low limit that is programmed into the instrument. Current Low Limit Range: indicates the current range that can be programmed into the instrument.

The A Lo-Lmt parameter setting is only available in the PROGRAM Mode.

To change the current high limit or low limit, use the numeric keypad and type the current value. Once you type in a number a shaded black box (■) will begin blinking acknowledging the parameter is being changed. Press the Enter soft key to accept the parameter, or press the Esc soft key to move back to the Current Parameter screen. When the Enter soft key is pressed the current is accepted and you transition into the next parameter: P Hi-Lmt.

If you wish to bypass editing this parameter and move to the next parameter you can press the Prev or Next soft key.

4.6.19 Editing P Hi-Lmt & P Lo-Lmt (PROGRAM Mode only)

Use the \wedge , \vee soft keys to navigate to the P Hi-Lmt or P Lo-Lmt parameter.

Pressing the Edit soft key will provide one of the following screens:



P Hi-Lmt = indicates the power high limit that is programmed into the instrument.

Power High Limit Range: indicates the power range that can be programmed into the instrument. If you select the 0=OFF a high limit power range is turned OFF.



P Lo-Lmt = indicates the power low limit that is programmed into the instrument.

Power Low Limit Range: indicates the power range that can be programmed into the instrument.

To change the Power High Limit or Low Limit, use the numeric keypad and type the power value. Once you type in a number a shaded black box (■) will begin blinking acknowledging the parameter is being changed. Press the Enter soft key to accept the parameter, or press the Esc key to move back to the Power Parameter screen. When the Enter soft key is pressed the power is accepted and you transition into the next parameter: Ap Hi-Lmt.

If you wish to bypass editing this parameter and move to the next parameter you can press the Prev or Next soft key.

4.6.20 Editing Ap Hi-Lmt & Ap Lo-Lmt (PROGRAM Mode only)

Use the ^, v soft keys to navigate to the Ap Hi-Lmt or Ap Lo-Lmt parameter (only selectable for AC output). Pressing the Edit soft key will provide one of the following screens:



Ap Hi-Lmt = indicates the peak current high limit that is programmed into the instrument.

Peak Current High Limit Range: indicates the peak current range that can be

programmed into the instrument. If you select the 0=OFF a high limit peak current range is turned OFF.

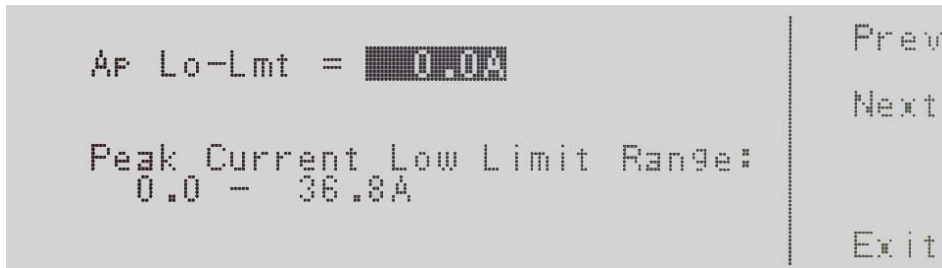

Ap Lo-Lmt = indicates the peak current low limit that is programmed into the instrument.

Peak Current Low Limit Range: indicates the peak current range that can be programmed into the instrument.

To change the Peak Current High Limit or Low Limit use the numeric keypad and type the peak current value. Once you type in a number a shaded black box (■) will begin blinking acknowledging the parameter is being changed. Press the Enter soft key to accept the parameter, or press the Esc key to move back to the Peak Current Parameter screen. When the Enter soft key is pressed the peak current is accepted and you transition into the next parameter: CF Hi-Lmt.

If you wish to bypass editing this parameter and move to the next parameter you can press the Prev or Next soft key.

4.6.21 Editing CF Hi-Lmt & CF Lo-Lmt (PROGRAM Mode only)

Use the ^, v soft keys to navigate to the CF Hi-Lmt or CF Lo-Lmt parameter (only selectable for AC output). Pressing the Edit soft key will provide one of the following screens:

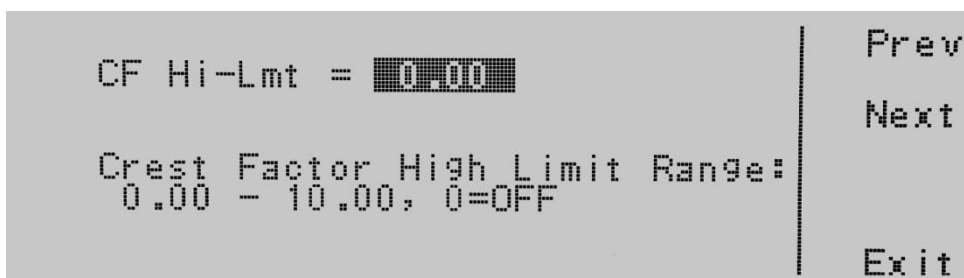

CF Hi-Lmt = indicates the crest factor high limit that is programmed into the

instrument.

Crest Factor High Limit Range: indicates the crest factor range that can be programmed into the instrument. If you select the 0=OFF high limit crest factor range is turned OFF.

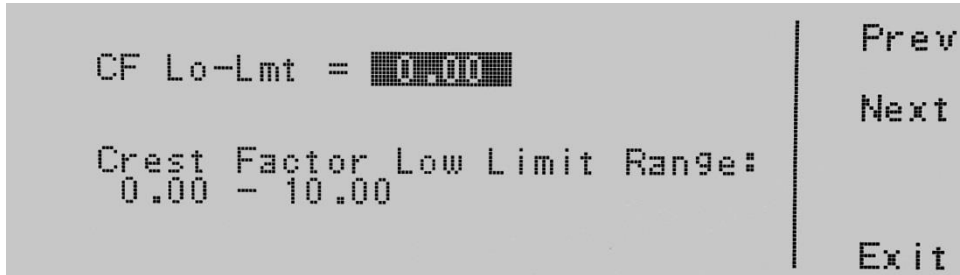

CF Lo-Lmt = indicates the crest factor low limit that is programmed into the instrument.

Crest Factor Low Limit Range: indicates the crest factor range that can be programmed into the instrument.

To change the Crest Factor High Limit or Low Limit use the numeric keypad and type the peak current value. Once you type in a number a shaded black box (■) will begin blinking acknowledging the parameter is being changed. Press the Enter soft key to accept the parameter, or press the Esc key to move back to the Crest Factor Parameter screen. When the Enter soft key is pressed the crest factor is accepted and you transition into the next parameter: PF Hi-Lmt.

If you wish to bypass editing this parameter and move to the next parameter you can press the Prev or Next soft key.

4.6.22 Editing PF Hi-Lmt & PF Lo-Lmt (PROGRAM Mode only)

Use the ^, v soft keys to navigate to the PF Hi-Lmt or PF Lo-Lmt parameter (only selectable for AC output). Pressing the Edit soft key will provide one of the following screens:

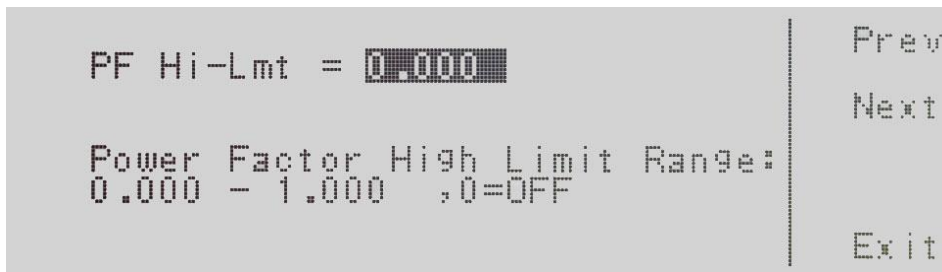

PF Hi-Lmt = indicates the power factor high limit that is programmed into the instrument.

Power Factor High Limit Range: indicates the power factor range that can be programmed into the instrument. If you select the 0=OFF a high limit power factor range is turned OFF.

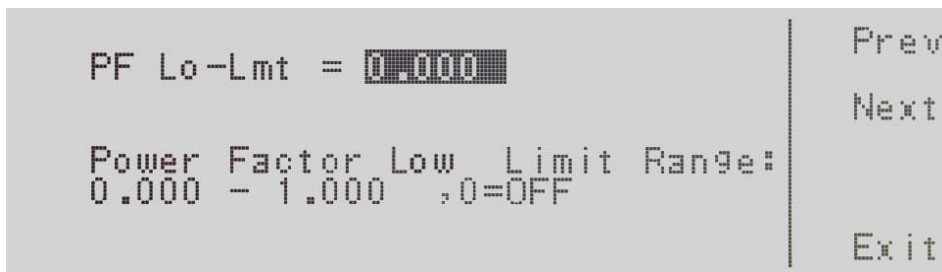

PF Lo-Lmt = indicates the power factor low limit that is programmed into the instrument.

Power Factor Low Limit Range: indicates the power factor range that can be programmed into the instrument.

To change the Power Factor High Limit or Low Limit use the numeric keypad and type the power factor value. Once you type in a number a shaded black box (■) will begin blinking acknowledging the parameter is being changed. Press the Enter soft key to accept the parameter, or press the Esc key to move back to the Power Factor Parameter screen. When the Enter soft key is pressed the power factor is accepted and you transition into the next parameter: VA Hi-Lmt.

If you wish to bypass editing this parameter and move to the next parameter you can press the Prev or Next soft key.

4.6.23 Editing VA Hi-Lmt & VA Lo-Lmt (PROGRAM Mode only)

Use the ^, v soft keys to navigate to the VA Hi-Lmt or VA Lo-Lmt parameter (only

selectable for AC output). Pressing the Edit soft key will provide one of the following screens:

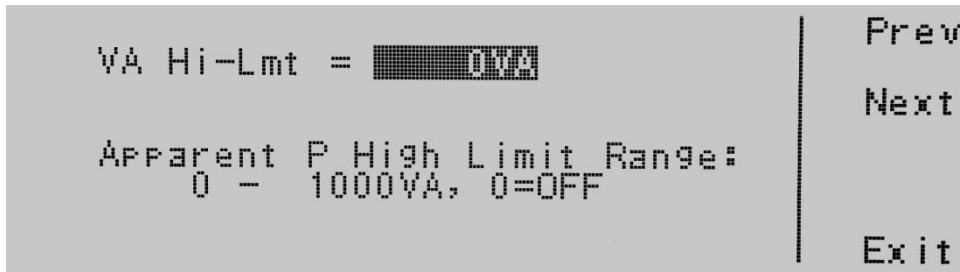

VA Hi-Lmt = indicates the apparent power high limit that is programmed into the instrument.

VA High Limit Range: indicates the apparent power range that can be programmed into the instrument. If you select the 0=OFF apparent power range is turned OFF.

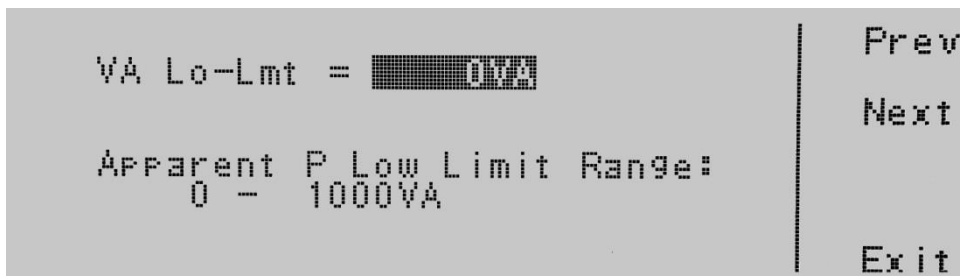

VA Lo-Lmt = indicates the apparent power low limit that is programmed into the instrument.

VA Low Limit Range: indicates the apparent power range that can be programmed into the instrument.

To change the Apparent Power High Limit or Low Limit use the numeric keypad and type the peak current value. Once you type in a number a shaded black box (■) will begin blinking acknowledging the parameter is being changed. Press the Enter soft key to accept the parameter, or press the Esc key to move back to the Apparent Power Parameter screen. When the Enter soft key is pressed the apparent power is accepted and you transition into the next parameter: Q Hi-Lmt.

If you wish to bypass editing this parameter and move to the next parameter you can press the Prev or Next soft key.

4.6.24 Editing Q Hi-Lmt & Q Lo-Lmt (PROGRAM Mode only)

Use the \wedge , \vee soft keys to navigate to the Q Hi-Lmt or Q Lo-Lmt parameter (only selectable for AC output). Pressing the Edit soft key will provide one of the following screens:

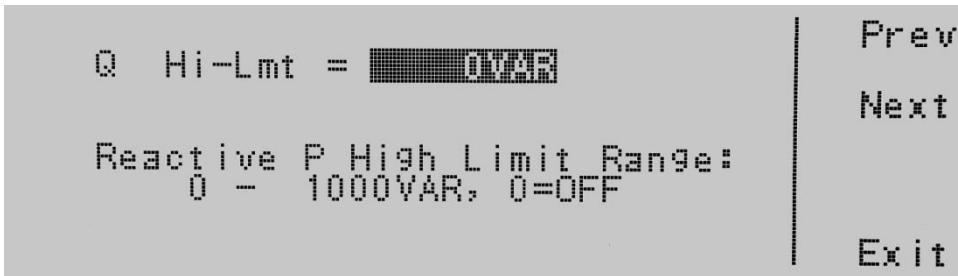

Q Hi-Lmt = indicates the reactive power high limit that is programmed into the instrument.

Reactive Power High Limit Range: indicates the reactive power range that can be programmed into the instrument. If you select the 0=OFF reactive power high limit range is turned OFF.

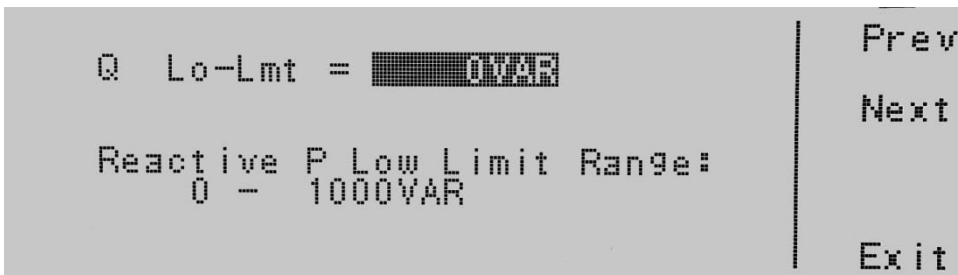

Q Lo-Lmt = indicates the reactive power low limit that is programmed into the instrument.

Reactive Power Low Limit Range: indicates the reactive power range that can be programmed into the instrument.

To change the Reactive Power High Limit or Low Limit use the numeric keypad and type the peak current value. Once you type in a number a shaded black box (■) will begin blinking acknowledging the parameter is being changed. Press the Enter soft key to accept the parameter, or press the Esc key to move back to the Reactive Power Parameter screen. When the Enter soft key is pressed the peak current is accepted and you transition into the next parameter: Prompt.

If you wish to bypass editing this parameter and move to the next parameter you

can press the Prev or Next soft key.

4.6.25 Editing Prompt

Use the ^, v soft keys to navigate to the Prompt parameter. Pressing the Edit soft key will provide the following screen:

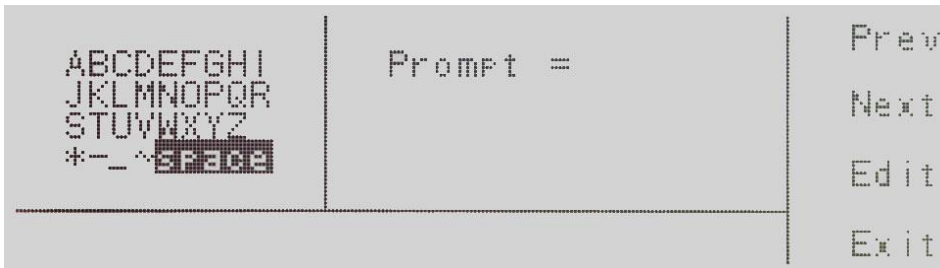

Press the “Edit” soft key and a blinking shaded black box (■) will appear notifying you that characters can be inserted into the prompt field. Use the soft keys > and v to highlight the character you would like to use. Press the Select soft key to accept the character. You can also use the numeric keypad to enter characters. When the numeric keypad is used the number is inserted automatically and the Select soft key is not needed. To delete a character use the Backspace key <- - located on the numeric keypad. There are 32 characters spaces available for the prompt message. To save the prompt message press the <more> soft key which will bring you to the following screen.



Press the Enter soft key to accept the prompt message. To cancel the prompt message, press the Esc soft key. When the Enter soft key is pressed the prompt is accepted and you transition into the next parameter: Step Cycle.

If you wish to bypass editing this parameter and move to the next parameter you can press the Prev or Next soft key.

4.6.26 Editing Connect

Use the \wedge , \vee soft keys to navigate to the Connect parameter. Pressing the Edit soft key will provide the following screen:



Connect = indicates the status of the connect mode that is programmed into the instrument.

Step Connect Mode: indicates the connect mode that can be programmed into the instrument.

Press the Change soft key to toggle the connect mode ON/OFF. To save the parameter, press the Enter soft key. To cancel the editing of the step mode press the Esc soft key. When the Enter soft key is pressed the connect mode is accepted and you transition into the next parameter: Memory Cycle.

If you wish to bypass editing this parameter and move to the next parameter you can press the Prev or Next soft key.

When the connect mode is ON there will be an underscore $_$ next to the step number in the set screen. It will look as follows:



4.6.27 Editing Phase Set (Option 08 – PROGRAM Mode only)

Use the \wedge , \vee soft keys to navigate to the Phase Set parameter. Pressing the Edit soft key will provide the following screen:

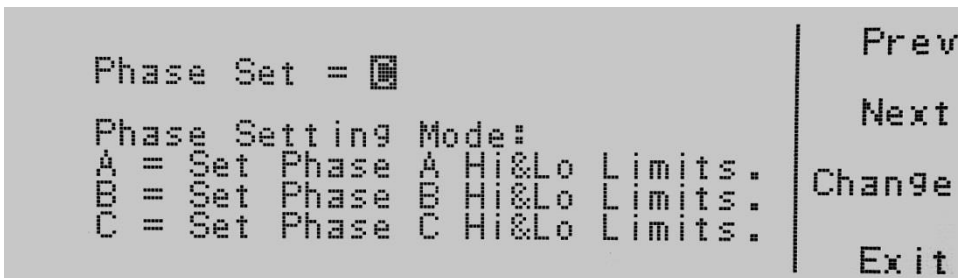

Phase Set = indicates the Phase Setting mode for operating two instruments in a master-slave configuration.

Phase Setting Mode: indicates the Phase Setting mode that can be programmed into the instrument.

The Phase Setting Modes available are L1-N and L2-N (two interconnected instruments) or L1-N, L2-N and L3-N (three interconnected instruments). Press the Change soft key to toggle the mode. To save the parameter, press the Enter soft key. To cancel the editing of the Phase Setting Mode, press the Esc soft key. When the Enter soft key is pressed the Phase Setting Mode is accepted and you transition into the next system parameter: Function.

If you wish to bypass editing this parameter and move to the next parameter you can press the Prev or Next soft key.

4.7 Reviewing Test Results

To review the testing results press the Result soft key in the set screen. You may have to use the <more> soft key to get to the Results soft key. The screen will look as follows when you are in the correct screen:

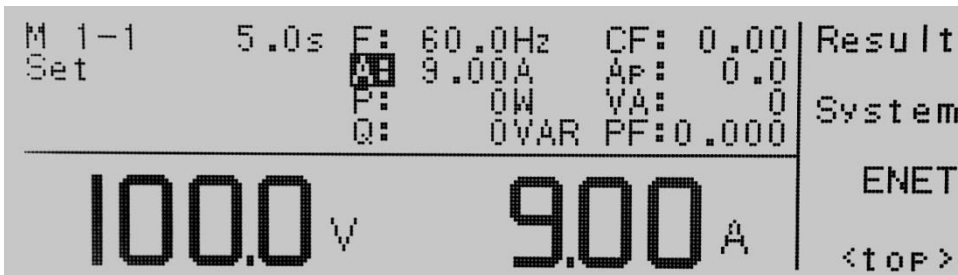

Press the Result soft key to view the results. The screen will look as follows:

1-1P	Pass	
	Settings	Results
	100.0V	100.0V
	60.0Hz	60.0Hz
	0W	0.0W
	9.00A	0.000A
	0.0AP	0.0AP
		Page ^
		Page v
		Exit

If you have multiple steps linked together you will have to use the navigation soft keys in order to toggle through each step to review the results. Press the Exit soft key to move back to the set screen.

5. Test Modes

5.1 Description of Test Modes

Within the System Parameter settings of Auto Mode you have two selections available (PROGRAM/MANUAL).

The PROGRAM Mode will run your testing routine according to the parameters that have been entered within the testing parameters screen when the TEST/RESET key is pressed. In most cases there will be a testing time associated with the test mode unless the time has been selected to ∞ or the cycle mode is ON.

The MANUAL Mode will run your testing routine according to the parameters currently programmed into the instrument when the Test/Reset key is pressed. However, there is no test time associated with the MANUAL Mode. The output is continuous until the Test/Reset key is pressed again.

5.2 Initializing a Test in PROGRAM Mode

5.2.1 AC Output

When the AUTO RUN parameter in the System Parameters menu is set to PROGRAM Mode the Set screen will be displayed as follows:

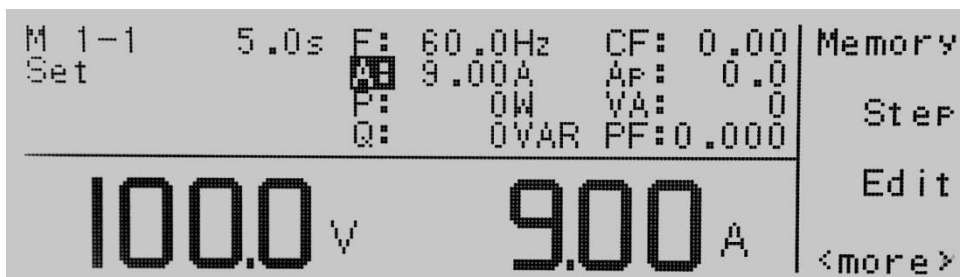

To initialize the test press the Test/Reset key and the LED for the key will illuminate. The text "Set" on the set screen will turn to Dwell, in addition your soft keys will change to include Meter, Cycle, Keypad, and Trig*.

*Only available if Transient parameter is set to OFF.



If you press the Meter soft key a shaded black box (■) will highlight the meter parameters of F; A; P; Q; CF; Ap; VA; PF; and the display will read the output on the on the right side of the display. Every time the meter key is pressed it will toggle through the meter parameters.

If you press the Cycle soft key the display will change and provide you the cycle information from Step, Memory, and Loop. This will take the place of the meter reading on the right side of the display. To move back to the meter reading, press the Meter soft key.

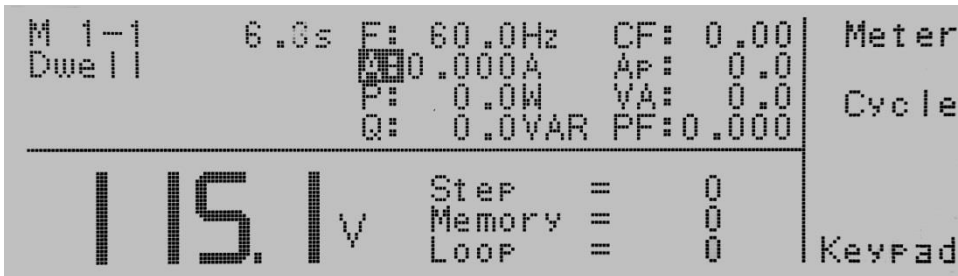

If you press the Keypad soft key the display will show the text Voltage = above the voltage meter on the left hand side of the display. A shaded black box (■) will be flashing waiting for a voltage value to be entered from the numeric keypad. Once the value has been typed into the instrument you must press the Enter soft key to accept the value. The Esc soft key is available to exit out of this mode and move back to the test screen.

If you press the Trig. soft key you will hear a beep which is notification that the trigger has been activated for the Transient parameters that have been entered into the instrument.

When the test cycle has completed the display will show you the meter readings and the soft keys will change to Meter, Cycle, Exit. You can toggle through the meter displays or show the cycles by pressing the appropriate soft keys. The display will also show you the test status where the text “Dwell” was located. If the test passes you will see Pass. If you press the Exit soft key the screen will

reset back to the set screen.

5.2.2 DC Output

When the AUTO RUN parameter in the System Parameters menu is set to PROGRAM Mode the Set screen will be displayed as follows:

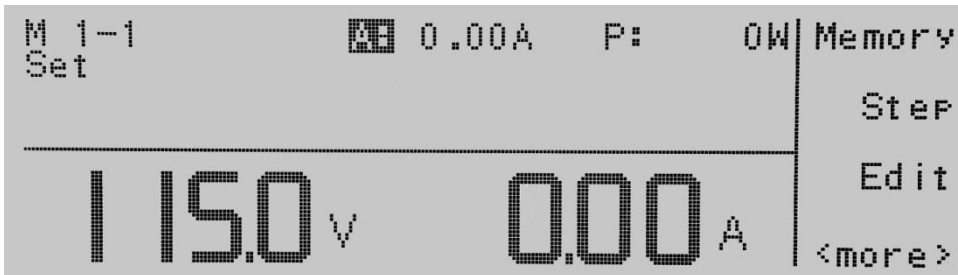

To initialize the test press the Test/Reset key and the LED for the key will illuminate. The text “Set” on the set screen will turn to Dwell, in addition your soft keys will change to include Meter and Keypad. The output will run continuously until the Test/Reset key is pressed again, or there is a failure condition.

When the RESET key is pressed or a Hi-Limit failure occurs, the instrument DC output voltage has a fixed 1 second ramp down discharge time. The Test/Reset LED flashes during this ramp down period to indicate the output is still active.

If you press the Meter soft key a shaded black box (■) will highlight the meter parameters P: or A: and the display will read the output on the right side of the display. Every time the meter key is pressed it will toggle between the two meter parameters.

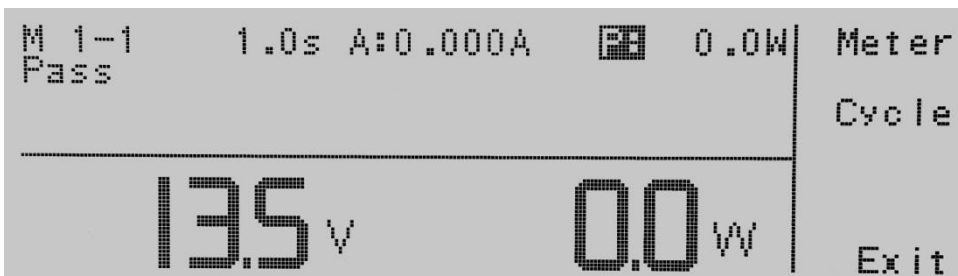

If you press the Keypad soft key the display will show the text Voltage = above the voltage meter on the left hand side of the display. A shaded black box (■) will be flashing waiting for a voltage value to be entered from the numeric keypad. Once the value has been typed into the instrument you must press the Enter soft key to accept the value. The Esc soft key is available to exit out of this mode and

move back to the test screen.

5.3 Initializing a Test in MANUAL Mode

5.3.1 AC Output

When the AUTO RUN parameter in the System Parameters is set to the MANUAL Mode the Set screen will be displayed as follows:



To initialize the test press the Test/Reset key and the LED for the key will illuminate. The text “Set” on the set screen will turn to Dwell, in addition your soft keys will change to include Meter, AUTO, Keypad, and Trig. In the MANUAL Mode output will run continuously until the Test/Reset key is pressed again, or there is a failure condition.



If you press the Meter soft key a shaded black box (■) will highlight the meter parameters of F:, A:, P:, Q:, CF:, Ap:, VA:, PF:, and the display will read the output on the on the right side of the display. Every time the meter key is pressed it will toggle through the meter parameters.

If you press the AUTO soft key a shaded black box (■) will toggle between AUTO & HIGH. The AUTO Mode will toggle the voltage range from low to high based on the voltage setting. This allows you to receive maximum current based on the voltage range you have selected. If the HIGH Mode is selected the current will always be at 50% of the maximum capacity of the instrument at any voltage level selected whether it would be in the low or high range.

If you press the Keypad soft key the display will show the text Voltage = above the voltage meter on the left hand of the display. A shaded black box (■) will be flashing waiting for a voltage value to be entered from the numeric keypad. Once the value has been typed into the instrument you must press the Enter soft key to accept the value. The Esc soft key is available to exit out of this mode and move back to the test screen.

In the MANUAL Mode the Rotary Knob on the front panel also becomes active. It can be used to adjust voltage or frequency. When the instrument is in an idle state, it can also be used to edit the Hi-Lmt. To adjust the frequency with the Rotary Knob the meter selection must be on F. To adjust the voltage with the Rotary Knob the meter can be on any selection except F. To adjust the Hi-Lmt with the Rotary Knob the meter selection must be on Hi-Lmt. To adjust the output, rotate the knob either clockwise or counterclockwise. Clockwise rotations will increase the output, whereas counterclockwise rotations will decrease the output. If LOCK is set to ON, the Rotary Knob is disabled.

If you press the Trig. soft key you will hear a beep which is notification that the trigger has been activated for the Transient parameters that have been entered into the instrument.

5.3.2 DC Output

When the AUTO RUN parameter in the System Parameters menu is set to MANUAL Mode the Set screen will be displayed as follows:

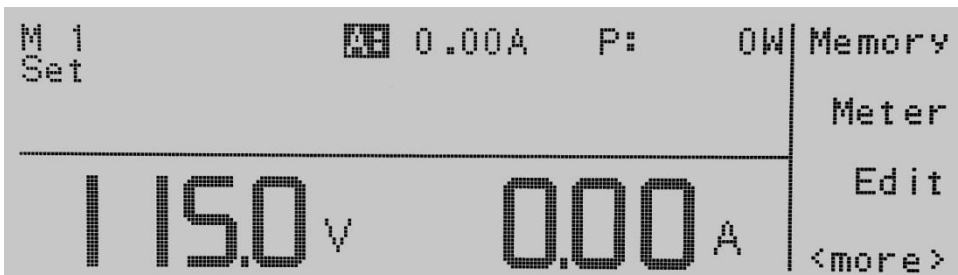

To initialize the test press the Test/Reset key and the LED for the key will illuminate. The text “Set” on the set screen will turn to Dwell, in addition your soft keys will change to include Meter and Keypad. The output will run continuously until the Test/Reset key is pressed again, or there is a failure condition.

When the RESET key is pressed or a Hi-Limit failure occurs, the instrument DC output voltage has a fixed 1 second ramp down discharge time. The Test/Reset LED flashes during this ramp down period to indicate the output is still active.

If you press the Meter soft key a shaded black box (■) will highlight the meter parameters P: or A: and the display will read the output on the right side of the display. Every time the meter key is pressed it will toggle between the two meter parameters.

If you press the Keypad soft key the display will show the text Voltage = above the voltage meter on the left hand side of the display. A shaded black box (■) will be flashing waiting for a voltage value to be entered from the numeric keypad. Once the value has been typed into the instrument you must press the Enter soft key to accept the value. The Esc soft key is available to exit out of this mode and move back to the test screen.

The Rotary Knob on the front panel also becomes active. To adjust the voltage rotate the knob either clockwise or counterclockwise. Clockwise rotations will increase the voltage, whereas counterclockwise rotations will decrease the voltage. If LOCK is set to ON, the Rotary Knob is disabled.

6. Multiple Instrument Operation

6.1 Configuring Sources for Parallel and Polyphase Operation

The 300XAC is a modular power source capable of interconnection to up to two (2) additional sources with Option 08 Linking Card installed. While all 300XAC models are modular, each model is only capable of being interconnected with another instrument of the same model. For example, model 310XAC may only be interconnected with either one (1) or two (2) additional model 310XAC instruments. A model 310XAC cannot be interconnected with a different model such as the 320XAC.

6.1.1 Operating Mode Definitions

When multiple instruments are connected together, the operator has the option to run the instruments in Parallel or Polyphase modes.

Parallel mode - two (2) or three (3) instruments connected together in parallel may be used to increase the total current output of the system.

Polyphase mode - two (2) or three (3) instruments connected together may be used in Polyphase mode. There are two versions of Polyphase mode. If two (2) instruments are interconnected 1 Φ 3W mode is available. This mode allows the operator to increase the output voltage to up to 600 VAC by configuring the two sources to output voltage at 180 degrees apart. If three (3) instruments are interconnected 3 Φ 4W mode is available. This mode allows the operator to configure the instruments for three phase operation. Each phase will output voltage 120 degrees apart.

6.1.2 Connecting the Interface Cable

In order to setup instruments to function in Parallel or Polyphase mode, Option 08 Linking Card is needed for each instrument that will be interconnected. The Option 08 Linking Card will be supplied with an interface cable that must be connected between each linked instrument. Connect the female end of the interface cable to the connector labeled "Interface Out" on the Option 08 Linking Card on the rear panel of the instrument that will be set up as the Master. Connect the male end of the interface cable to the connector labeled "Interface In" on the Option 08 Linking Card on the rear panel of the instrument that will be set up as Slave (1). If another slave unit needs to be added, connect the female end of the additional interface cable to the connector labeled "Interface Out" on the rear panel of the Slave (1) instrument. Connect the male end of the interface

cable to the connector labeled “Interface In” on the Option 08 Linking Card on the rear panel of the instrument that will be set up as Slave (2).

Note: APT’s SmartDetect feature will automatically configure the instruments as master and slave depending on how the interface cable is connected. The operator does not need to adjust any settings on the instruments’ front panel. APT’s SmartConfig feature will automatically adjust the firmware to display the appropriate output modes depending on the number of sources that are interconnected.

6.1.3 Output Wiring Diagrams

The following diagrams detail the correct setup for configuring multiple 300XAC power sources to operate in Parallel and Polyphase modes. Make sure that the instruments are OFF before attempting to make any connections.

Parallel Mode (1Φ2W)

In this condition, each instruments’ Line output must be connected together and each instruments’ Neutral output must be connected together at the load. See the figure below for the Parallel mode output wiring diagram:

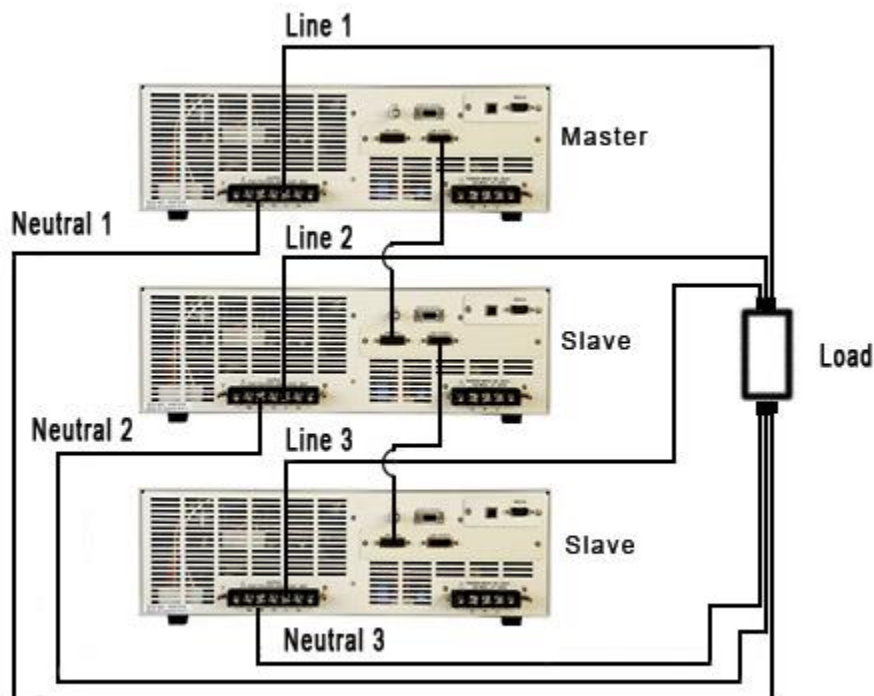

Polyphase Mode (1 Φ 3W)

In this configuration, the operator must connect the Neutrals of both instruments together and utilize both Line outputs to achieve full voltage. See the figure below for the 1 Φ 3W output wiring diagram:

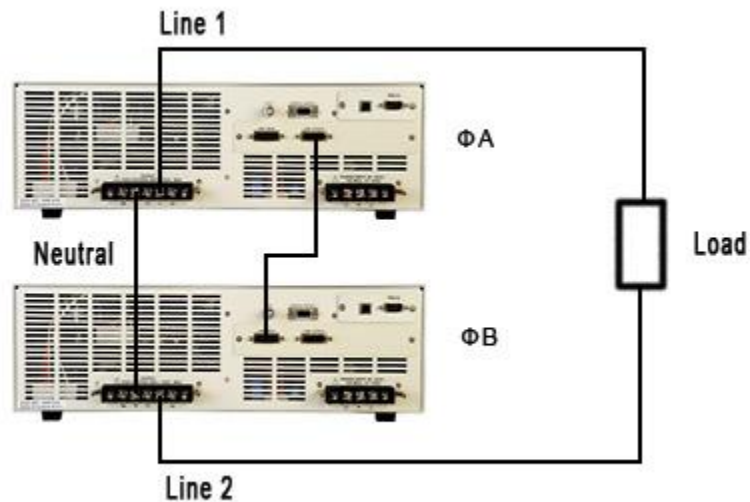

Polyphase Mode (3 Φ 4W)

In this configuration, the operator must connect the Neutrals of all sources together and utilize the Line outputs to achieve full voltage. See the figure below for the 3 Φ 4W output wiring diagram:

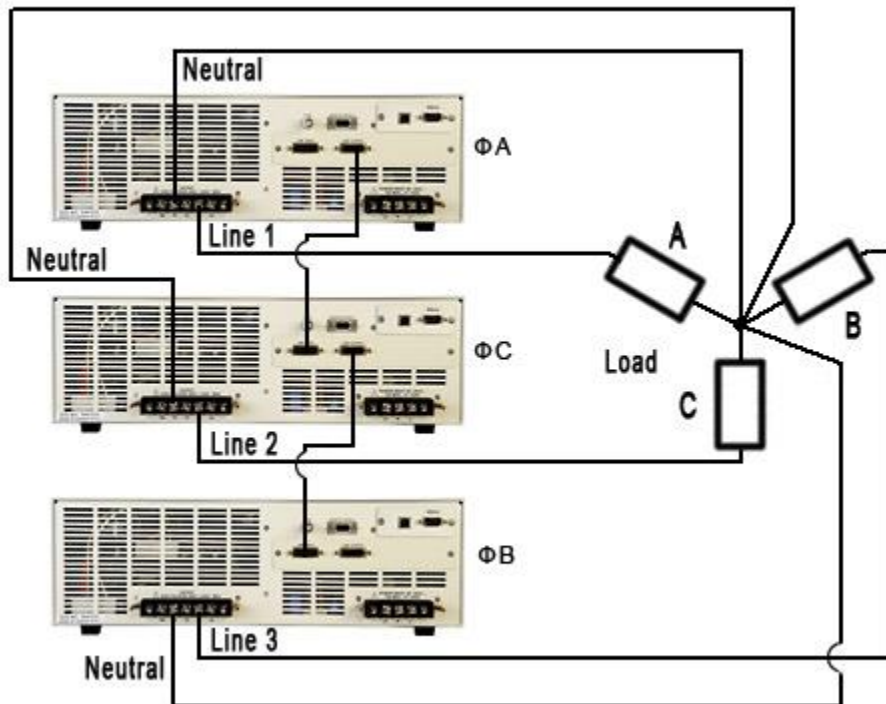
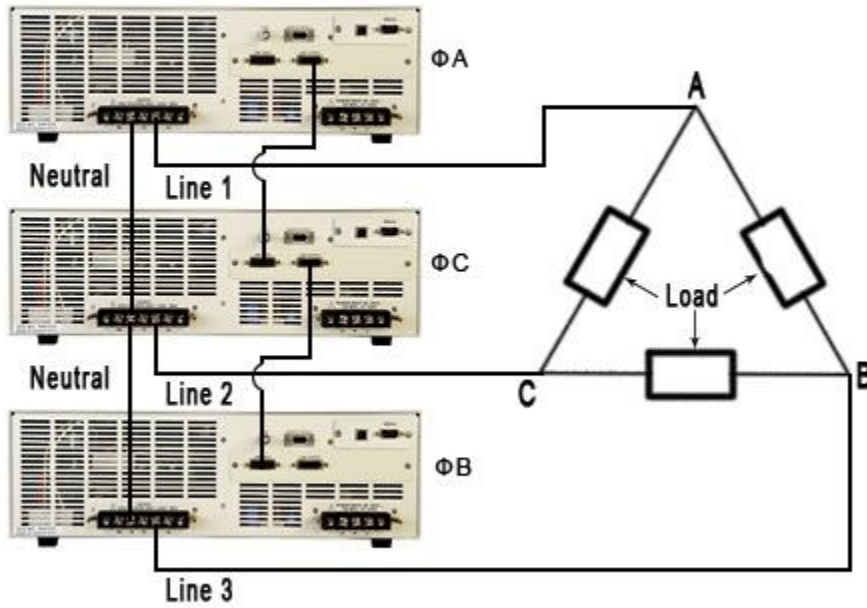

6.2 Power Up Considerations in Parallel and Polyphase Mode

After making the appropriate output connections and verifying the interface cable(s) are connected correctly, turn on the power to all instruments. The initialization screen will be displayed:

```

www.aspowertechologies.com
apt Associated Toll Free:1-877-322-7693
Power Technologies Phone:1-909-860-1646
Fax:1-909-860-2727
-----
Check AC IN....OK TEST Output....OK
Check PFC ....OK Linking slave1.OK
Check D/D ....OK Linking slave2.OK

```

If a slave instrument fails to power on the alarm will sound and the following error message will be displayed:

```

www.aspowertechologies.com
apt Associated Toll Free:1-877-322-7693
Power Technologies Phone:1-909-860-1646
Fax:1-909-992-3307
-----
Check AC IN....OK TEST Output....OK
Check PFC ....OK Linking slave1 FAIL
Check D/D ....OK

```

If multiple slave units are connected, the master will prompt the operator to enable the second slave. The prompt will be displayed as follows:

```

www.aspowertechologies.com
apt Detect Slave2! -322-7693
Do you want to add it? -860-1646
Press YES to add. -992-3307
Press NO to exit. YES
NO

```

Press the Yes soft key to enable the second slave instrument. Press the No soft key to disable the second slave instrument.

After the Yes or No soft key has been pressed, the set screen will be displayed. The set screen will change depending on the type of mode for which the instruments are configured. If the instruments are set for Parallel mode the Set

screen will appear as follows:



If two (2) instruments are connected and set for Polyphase mode the Set screen will appear as follows:



If three (3) instruments are connected and set for Polyphase mode the Set screen will appear as follows:



6.3 Initializing a Test in Parallel or Polyphase Mode

The front panel display(s) of the slave unit(s) will not be editable in Parallel or Polyphase modes. All user editable controls will be available from the front panel of the master instrument. After all parameters have been entered into the instrument, the operator may begin the test.

While a test is running, the front panel display will include the Phase key. Pressing the Phase key allows the operator to view the meters for each individual

phase, as well as total measurements.

For detailed information on initializing a test, please refer to section **5. Test Modes**.

6.4 Error Messages in Parallel and Polyphase Mode

If the power to the master instrument is turned off during operation or the interface cable is unplugged, the slave instrument display will show the following message:

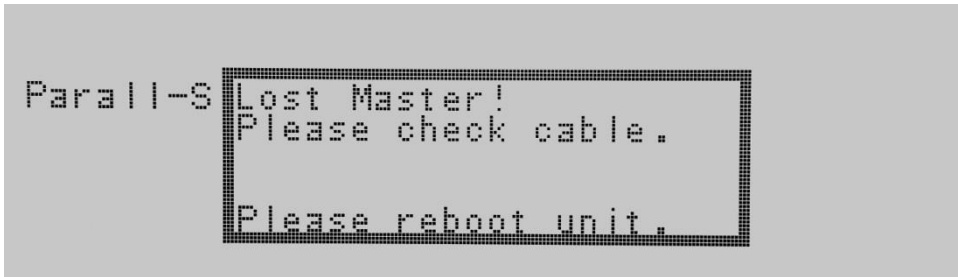

If the power to a slave instrument is turned off during operation or the interface cable is unplugged, the master instrument display will show the following message:

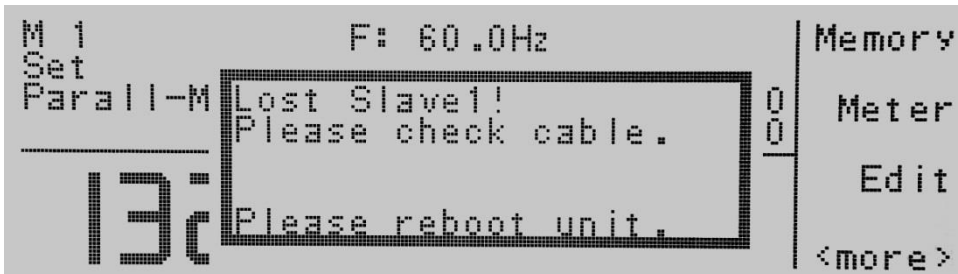

7. Displayed Messages

During any abnormal conditions, there are several error messages that could be indicated in the display. When an abnormal condition occurs the output will disable and the alarm will sound. The Test/Reset LED indicator will also begin flashing. Pressing the Test/Reset key will reset the audible alarm and the abnormal condition will be displayed.



All error messages occur in abnormal conditions and therefore must be recorded. Check the cause of the error to ensure the problem is eliminated before restarting the operation, or contact Associated Power Technologies, Inc., or our official distributors for further assistance.

Display Message	Definition
OTP	Over Temperature Protection
OCP	Over Current Protection
OPP	Over Power Protection
OVP	Output Voltage Protection
A-SH	Amplifier Shutdown Protection
RCP	Reverse Current Protection
LVP	Low Voltage Protection
LCD-Fail	LCD Temperature Protection

7.1 OTP – Over Temperature Protection

Displayed if the heat sink of the instrument has exceeded 130° C. The voltage and current displays will show the overloaded voltage or current respectively. The LED indicator for the Test/Reset key will be blinking.

7.2 OCP – Over Current Protection

Displayed if the output current has exceeded 110% of maximum current rating for greater than 1 second or there is a short circuit for less than 1 second. The LED indicator for the Test/Reset key will be blinking.

7.3 OPP – Over Power Protection

Displayed if the output power has exceeded 110% of maximum power rating for 1 second. The LED indicator for the Test/Reset key will be blinking.

7.4 OVP – Output Voltage Protection

Displayed if the output voltage has exceeded 5 V of the setting voltage in the 0-150V range, or has exceeded 10 V of the setting voltage in the 0-300V range. The LED indicator for the Test/Reset key will be blinking.

If an OVP error occurs on the next power up cycle on the displays will show Volt Err.

7.5 A-SH – Amplifier Shutdown Protection

Displayed if the amplifier is in an abnormal condition. The LED indicator for the Test/Reset key will be blinking.

7.6 RCP – Reverse Current Protection

Displayed if the power source detects negative current feeding back into the source. RCP will trip when negative power exceeds 20W (310XAC), 40W (320XAC), 89W (340XAC) and 120W (360XAC) of the instrument's power rating. The LED indicator the Test/Reset key will be blinking.

7.7 LVP- Low Voltage Protection

Displayed if the power source detects a discrepancy between the output voltage and the voltage setting of 10V or greater for more than 1sec. The LED indicator the Test/Reset key will be blinking.

7.8 LCD-Fail - LCD Temperature Protection

Displayed if the LCD temperature has exceeded 40° C. This error will self-clear once the power source has cool downed sufficiently to continue operations.

8. Remote PLC

8.1 Signal Output

The rear panel connector of the 300XAC Series provides output signals to remotely monitor PASS, FAIL, and PROCESSING conditions via a 9-Pin D-type connector. When a terminal becomes active the relay closes thereby allowing the external voltage to operate an external device. The following table provides the conditions of each pin and the relay state.

Condition	Pins	Relay State
PASS	Connection between PIN 1 & PIN 2	Closes on PASS and is opened on next test initialized
FAIL	Connection between PIN 3 & PIN 4	Closes on FAIL and is opened when next test is initialized
PROCESSING	Connection between PIN 5 & PIN 6	Closes when test initialized and opens after test is completed

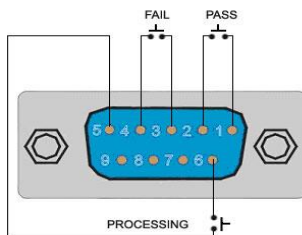

8.2 Signal Input - 7 Memory Recall (Opt. 04)

The 300XAC Series also provides an optional remote input interface (Opt. 04) to control any test operation via remote. The 9-Pin D-Type connector signals for Test, Reset, and 7 Memories (M1 – M7) input control signals. PLC remote functions will be activated once the PLC Remote from the System setup Parameter is turned on. Upon turning on the PLC Remote setting, the TEST/RESET LED will be lit and the buzzer will beep twice before returning to the RESET condition, when any key on the front panel is pressed. Whenever there is an abnormal output detected the instrument can be reset by pressing the TEST/RESET key or the initializing a reset through the PLC remote

The following table provides the conditions of each pin and the relay state:

Condition	Pins	Relay State
TEST	Connection between PIN 3 & PIN 5	Momentary contact closure
RESET	Connection between PIN 2 & PIN 5	Momentary contact closure

Memory Input Control

Selection of up to 7 memory locations is achieved by using a Normally Open (N.O) Momentary Button. The truth table below provides the pin locations needed in order to select the memories.

Memory	PIN 1	PIN 9	PIN 8
M1	OFF	OFF	ON
M2	OFF	ON	OFF
M3	OFF	ON	ON
M4	ON	OFF	OFF
M5	ON	OFF	ON
M6	ON	ON	OFF
M7	ON	ON	ON

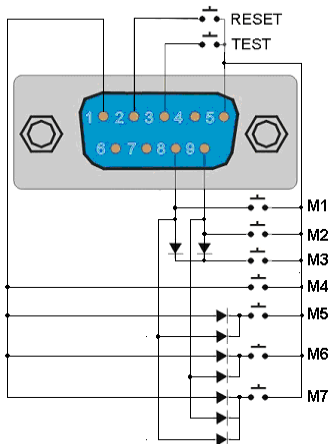

9. Bus Remote Interface USB/GPIB/RS-232

This section provides information on the proper use and configuration of bus remote interface. The USB/RS-232 remote interface is standard on model 300XAC series but the GPIB (IEEE-488) interface option can be substituted for the USB/RS-232 interface. Please refer to the Option section of this manual for details on the 300XAC series options.

The USB/RS-232 interface card requires the user to download a driver in order for the instrument to recognize the USB interface. The driver can be found on the Associated Research, Inc. website:

<http://www.aspowertechologies.com/support/USB-driver.aspx>

Click on “USB/RS-232 Driver” to download the driver. This link contains an automatic extract and install program. Follow the instructions of the installation program to initialize the driver install. NOTE: The USB port acts as a USB to RS-232 converter. As a result, the PC will recognize the USB port as a virtual COM port.

The USB/RS-232 interface also uses the same command set as the GPIB interface for setting of test parameters. However there are many functions of the GPIB 488.2 interface that are not available through USB/RS-232. The IEEE-488 interface included with the 300XAC series conforms to the requirements of the IEEE-488.2 standard.

9.1 USB/RS-232 Interface

This interface is standard on the 300XAC series. This interface provides all of the control commands and parameter setting commands of the GPIB interface with the exception of the 488.2 Common Command the Status Reporting commands and SRQ capability. All commands can be found in the command list, section 12.9 of this manual. The identification command *IDN is also available through USB/RS-232.

9.1.1 RS-232 Connector

The RS-232 connection is configured as follows for a 9 pin Serial Port Interface.

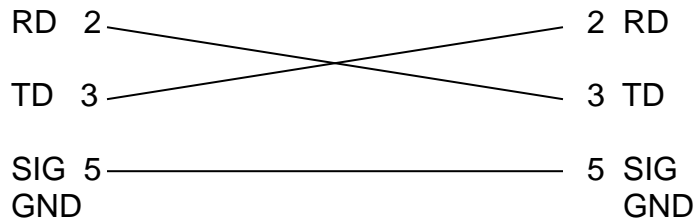

9.1.2 Communication Port Configuration

The COM port should have the following configuration:

- 9600 baud
- 8 data bits
- No polarity
- 1 stop bit

This interface does not support XON/XOFF protocol and any hardware handshaking. The controller should be configured to ignore the Handshaking Lines DTR (PIN 4), DSR (PIN 6) and RTS (PIN 9). If the port cannot be configured through software to ignore the lines, the handshaking lines should then be jumped together in two different sets. The PIN 4 and 6 jumped together while PIN 7 & 8 jumped together at the controller end of the cable.

9.1.3 Sending and Receiving Commands

Sending Commands

When sending commands over the USB/RS-232 bus the instrument will send a response string of 06 Hex or 6 decimal and Acknowledge (ACK) ASCII control code if the transfer was recognized and completed by the instrument. If there is an error with the command string that is sent, the instrument will respond with 15 Hex or 21 decimal and the Not Acknowledge (NAK) ASCII code. The ACK or NAK response allows for software handshaking in order to monitor and control data flow.

Receiving Commands

When requesting data from the instrument it will automatically send the data back to the controller input buffer. The controller input buffer will accumulate the data being sent from the instrument including the ACK and NAK response strings, until

the controller has read it. When the strings or command has been sent it must be terminated with LF=(0AH), such as "TEST"+LF.

9.2 GPIB Interface

9.2.1 GPIB Connector

Connection is usually accomplished with a 24-conductor cable with a plug on one end and a connector at the other end. Devices may be connected in a linear, star or a combination configuration.

The standard connector is the Amphenol or Cinch Series 57 Microribbon or AMP CHAMP type. The GPIB uses negative logic with standard transistor-transistor logic (TTL) levels. When DAV is true, for example, it is a TTL low level ($\leq 0/8$ V), and when DAV is false, it is a TTL high level (≥ 2.0 V).

Restrictions and Limitations on the GPIB

- A maximum separation of 4 m between any two devices and an average separation of 2 m over the entire bus.
- A maximum total cable length of 20 m.
- No more than 15 device loads connected to each bus, with no less than two-thirds powered on. For example 1 GPIB controller and a maximum of 14 GPIB instruments.
- **Note:** A bus extender, which is available from numerous manufacturers, is available to overcome these limitations.

9.2.2 GPIB Address

Each device on the GPIB (IEEE-488) interface must have a unique address. You can set the address of the 300XAC to any value between 0 and 30. The address can only be set from the front panel. The address is stored in non-volatile memory and does not change when the power has been off or after a remote reset.

- **The address is set to 8 when the instrument is shipped from the factory.**

9.3 Interface Functions

The capability of a device connected to the bus is specified by its interface functions. These functions provide the means for a device to receive, process, and send messages over the bus. The interface functions are listed in the chart

below.

GPIB 488.1 INTERFACE FUNCTIONS

Interface Function	Subset	Description
Source Handshake	SH1	Complete Source handshake capability
Acceptor Handshake	AH1	Complete Acceptor handshake capability
Talker	T6	Talker functions (unaddress if MLA)
Listener	L4	Listener functions (unaddress if MTA)
Service Request	SR1	Complete Service request capability
Remote Local	RL0	No remote/local capability
Parallel Poll	PP0	No parallel poll capability
Device Clear	DC1	Complete Device clear capability
Device Trigger	DT0	No device trigger capability
Controller	C0	No controller capability
Electrical Interface	E2	Three-state drivers

Controllable Items	Test and Reset control.
	Setting of test parameters for tests.
	Reading of instrument status and test results.
Data Codes	ASCII
Delimiter	NL (+ EOI)

9.4 USB/GPIB/RS-232 Interface Command List

A GPIB read command must be sent after the command strings, to retrieve any data from a query command (?). The APT 300XAC series GPIB bus will not send any data to the controller without being queried. The USB/RS-232 bus will automatically send any response back to the controller's input buffer. Each command string should be terminated the ASCII control code, New Line <NL>, OAh or the end of line EOL message for GPIB.

The following conventions are used to describe the commands syntax. Braces ({ }) enclose each parameter for a command string. Triangle brackets (< >) indicate that you must substitute a value for the enclosed parameter. The Pipe (|) is used to separate different parameter options for a command. Do not include any of the above characters when sending the commands. The command and the value should be separated with a space.

All commands that end with a question mark (?) are query commands and required an IEEE-488 read command to retrieve the data from the device's output buffer.

9.4.1 Basic Commands and Query Commands

The following commands are used to control actual output voltage and current from the instrument. This command set also includes query commands. These query commands will retrieve data from the instrument. The GPIB bus application requires an IEEE-488 read command to be sent after the query command. These commands include functions for retrieving test data, test results and metering values.

Command	Description	AC Program Mode	AC Manual Mode	DC Program Mode	DC Manual Mode	Unit
TEST	TEST	Power On				
RESET	RESET	Power Off				
TD?	Testing meters data	Memory, Step, Status, Freq, Volt, Curr, Power, APeak, PF, Q, CF, VA, Timer	Memory, Status, Freq, Volt, Curr, Power, APeak, PF, Q, CF,VA	Memory, Step, Status, Volt, Curr, Power, Timer	Memory, Status, Volt, Curr, Power	
RD XX?	Results meters data					
TDFREQ?	Testing frequency meter					Hz
TDVOLT?	Testing voltage meter	5.0~300.0		5.0~420.0		V
TDCURR?	Testing current meter	See Note1	See Note1	See Note2	See Note2	A
TDAP?	Testing current peak meter	See Note4				A
TDP?	Testing power meter	See Note3				W
TDPF?	Testing pf meter	0.000~1.000				
TDQ?	Testing Q meter	See Note3				
TDCF?	Testing CF meter	0.00~10.00				
TDVA?	Testing VA meter	See Note3				VAR
TDTIMER?	Testing timer meter	0.0~999.9		0.0~999.9		s/m/h
METER X	SELECT METER X	X=0-8,0=F,1=A,2=P,3=Q,4=CF,5=AP,6=V A,7=PF,8=CYCLE	X=0-7,0=F,1=A,2=P,3=Q,4=CF,5=AP,6=VA,7=PF	X=1,2,8 1=A,2=P,8=CYCLE	X=1,2 1=A,2=P	
METER?	SELECT METER?					
SDTRG	TRANSIENT TRIGGER		Trigger one time TRANSIENT			
STEPCYCLE?	STEP CYCLE?					
MEMORYCYCLE?	MEMORY CYCLE?					
LOOPCYCLE?	LOOP CYCLE?					

TEST

Turns on the output voltage at the selected step loaded into memory.

RESET

Turns the output voltage off or resets the instrument in the event of a failure.

TD?

Read the active data being displayed on the LCD display while the test is in process. Will also read the last data taken when the test sequence has completed. Each parameter is separated by commas and includes memory number, step number, test status, frequency value, voltage value, current value, power value, peak current value, power factor value and timer metering. The syntax for the command response is {memory, step, status, frequency, voltage, current, power, peak current, power factor, timer}. Each meter will contain only the value and not the units. Current and peak current are displayed in amps while power is displayed in Watts.

RD <step number>?

Read the results for an individual step. The step number is the actual step number that has been saved within the file, not the order of which the steps were executed. For example if the test was executed starting from step 3 and ending with step 5 then the first step test results will be found in location 3 not in location 1. Each parameter is separated by commas and includes step number, test type, test status, and metering. The syntax for this command response is {memory, step, status, frequency, voltage, current, power, peak current, power factor, timer}. ACW test displays 4 meters. Each meter will contain only the value and not the units. Each meter will contain only the value and not the units. Current and peak current are displayed in amps while power is displayed in Watts.

TDFREQ?

Read the active frequency value being displayed while a test is in process.

TDVOLT?

Read the active voltage value being displayed while a test is in process.

TDCURR?

Read the active current value being displayed while a test is in process.

TDAP?

Read the active peak current value being displayed while a test is in process.

TDP?

Read the active power value being displayed while a test is in process.

TDPF?

Read the active power factor value being displayed while a test is in process.

TDQ?

Read the active reactive current value being displayed while a test is in process.

TDCF?

Read the active crest factor value being displayed while a test is in process.

TDVA?

Read the active apparent power value being displayed while a test is in process.

TDTIMER?

Read the active timer meter value being displayed while a test is in process.

METER {4|3|2|1|0}

Selects the metered value that is displayed while a test is in process. 4 sets the meter = power factor, 3 sets the meter = current, 2 sets the meter = power, 1 sets the meter = peak current and 0 sets meter = frequency.

METER?

Read the selected meter value. Returns value of 0 – 4.

SDTRG

Triggers a one shot surge/drop in order to simulate loading or brown out conditions.

STEPCYCLE?

Read the value of the current step cycle signal. When the step cycle has been activated the query will return a value of 0 for continuous, 1 for Off or a range from 0~9999 cycles.

MEMORYCYCLE?

Read the value of the current memory cycle signal. When the memory cycle has been activated the query will return a value of 0 for continuous cycling, 1 for Off or a range from 0~9999 cycles.

LOOPCYCLE?

Read the value of the current loop cycle signal. When the loop cycle has been activated the query will return a value of 0 for continuous cycling, 1 for Off or a range from 0~9999 cycles.

9.4.2 3Φ4W Queries

The following commands are used to query the instrument while in Polyphase mode.

Command	Description	AC Program Mode	AC Manual Mode
TDA?	Testing AØ meter data	Memory, Step, Status, Freq, Volt, Curr, Power, APeak, PF, Q, CF, VA, Timer	Memory, Status, Freq, Volt, Curr, Power, APeak, PF, Q, CF, VA
TDB?	Testing BØ meter data		
TDC?	Testing CØ meter data		
TDE?	Testing ΣØ meter data		
RDA XX?	Results AØ meter data		
RDB XX?	Results BØ meter data		
RDC XX?	Results CØ meter data		
RDE XX?	Results ΣØ meter data		

TDA?

Read the selected Phase A meter values while a test is in process. Query only available in AC Program mode and AC Manual mode.

TDB?

Read the selected Phase B meter values while a test is in process. Query only available in AC Program mode and AC Manual mode.

TDC?

Read the selected Phase C meter values while a test is in process. Query only available in AC Program mode and AC Manual mode.

TDE?

Read the total (Phase A + B + C) meter values while a test is in process. Query only available in AC Program mode and AC Manual mode.

RDA XX?

Read the selected Phase A results once a test has completed. Query only available in AC Program mode and AC Manual mode.

RDB XX?

Read the selected Phase B results once a test has completed. Query only available in AC Program mode and AC Manual mode.

RDC XX?

Read the selected Phase C results once a test has completed. Query only available in AC Program mode and AC Manual mode.

RDE XX?

Read the selected total (Phase A + B + C) results once a test has completed. Query only available in AC Program mode and AC Manual mode.

9.4.3 1 Φ 3W Queries

The following commands are used to query the instrument while in Parallel mode.

COMMAND	DESCRIPTION	AC Program Mode	AC Manual Mode	DC Program Mode	DC Manual Mode
TDL1N?	Testing L1-N meter data	Memory, Step, Status, Freq, Volt, Curr, Power, APeak, PF, Q, CF, VA, Timer	Memory, Status, Freq, Volt, Curr, Power, APeak, PF, Q, CF, VA	Memory, Step, Status, Volt, Curr, Power, Timer	Memory, Status, Volt, Curr, Power
TDL2N?	Testing L1-N meter data				
TDL1L2?	Testing L1-L2 meter data				
RDL1N XX?	Results L1-N meter data				
RDL2N XX?	Results L2-N meter data				
RDL1L2 XX?	Results L1-L2 meter data				

TDL1N?

Read the selected L1-N meter values while a test is in process.

TDL2N?

Read the selected L2-N meter values while a test is in process.

TDL1L2?

Read the selected total (L1-L2) meter values while a test is in process.

RDL 1N XX?

Read the selected L1-N results once a test has completed.

RDL 2N XX?

Read the selected L2-N results once a test has completed.

RDL 1L2 XX?

Read the total (L1-L2) results once a test has completed.

9.4.4 Program Commands and Companion Queries

These commands are used to modify individual test parameters within each step. Many of these commands require a parameter value to be included with the command. The companion query command will read the parameter. The writing

of the parameter requires that the unit not be included with the value, only the numeric value should be included with the command. Also, when the query commands are sent, the response will not include the unit characters.

Command	Description	AC Program Mode	AC Manual Mode	DC Program Mode	DC Manual Mode	Unit	
NAME XXXX	MEMORY NAME XXXX	XXXX=1~10 BYTES					
NAME?	MEMORY NAME?						
SAG XXXX	START ANGLE XXXX	XXXX=0-359				°	
SAG?	START ANGLE?	0-359				°	
EAG XXXX	END ANGLE XXXX	XXXX=0-359				°	
EAG?	END ANGLE?	0-359				°	
MC XXXX	MEMORY CYCLE XXXX	XXXX=0~9999, 0=Continue, 1=OFF		XXXX=0~9999, 0=Continue, 1=OFF			
MC?	MEMORY CYCLE?	0-9999		0-9999			
MEMORY X	MEMORY X	X=1-50					
MEMORY?	MEMORY?	1-50					
STEP X	STEP X	X=1-9		X=1-5			
STEP?	STEP?	1-9		1-5			
VOLT XXX.X	VOLTAGE XXX.X	XXXX=0.0~300.0		XXXX=5.0~420.0 or 5.0~210.0		V	
VOLT?	VOLTAGE?	0.0~300.0		5.0~420.0 or 5.0~210.0		V	
RANG X	RANG X	X=0-1, 0=HIGH,1=AUTO		X=0-1, 0=HIGH,1=LOW			
RANG?	RANG?	0-1					
FREQ XXXX	FREQUENCY XXXX	XXXX=40.0~1000				Hz	
FREQ?	FREQUENCY?	40.0~1000				Hz	
SD X	TRANSIENT X	X=0~1, 0=OFF,1=ON					
SD?	TRANSIENT?	0~1					
SDVOLT XXXX	TRANSIENT-VOLT XXXX	XXXX=0.0~300.0				V	
SDVOLT?	TRANSIENT- VOLT?	0.0~300.0				V	
SDLT XX.X	TRANSIENT-SITE XX.X	XX.X=0.0~25.0				ms	
SDLT?	TRANSIENT-SITE?	0.0~25.0				ms	
SDHT XX.X	TRANSIENT-TIME XX.X	XX.X=0.0~25.0				ms	
SDHT?	TRANSIENT- TIME?	0.0~25.0				ms	
SDCT XXXX	TRANSIENT- CYCLE XXXX	X=0~9999, 0=CONT,1=OFF					
SDCT?	TRANSIENT- CYCLE?	0~9999					
RAMPUP XXXX	RAMP UP TIME XXXX	XXX.X=0.1~999.9		XXX.X=0.1~999.9		s	
RAMPUP?	RAMP UP TIME?	0.1~999.9		0.1~999.9		s	
TUNIT X	TIME UNIT X	X=0- 2,0=Second,1=Minute,2= Hour		X=0- 2,0=Second,1=Minute ,2=Hour			
TUNIT?	TIME UNIT?	0-2		0-2			



DELAY XXXX	DELAY TIME XXXX	XXX.X=0.1~999.9		XXX.X=0.1~999.9		s/m/h
DELAY?	DELAY TIME?	0.1~999.9		0.1~999.9		s/m/h
DWELL XXXX	DWELL TIME XXXX	XXXX=0.0~999.9 ,0=Const		XXXX=0.0~999.9 ,0=Const		s/m/h
DWELL?	DWELL TIME?	0.0~999.9		0.0~999.9		s/m/h
RAMPDOWN XXXX	RAMP DOWN TIME XXXX	XXX.X=0.1~999.9		XXX.X=0.1~999.9		s
RAMPDOWN?	RAMP DOWN TIME?	0.1~999.9		0.1~999.9		s
SC XXXX	STEP CYCLE XXXX	XXXX=0~9999 ,0=Cont,1=OFF		XXXX=0~9999 ,0=Cont,1=OFF		
SC?	STEP CYCLE?	0-9999		0-9999		
PS X	PHASE SET X	(3Ø4W) X=0-2,0=RØ,1=SØ,2=TØ, (1Ø3W) X=0-1, 0=L1-N, 1=L2-N				
PS?	PHASE SET?	(3Ø4W) 0-2 (1Ø3W) 0-1				
AHI XXXX	A HI XXXX	See Note1	See Note1	See Note2	See Note2	A
AHI?	A HI?					A
ALO XXXX	A LO XXXX					A
ALO?	A LO?					A
PHI XXXX	POWER HI XXX.X	See Note3		See Note3		W
PHI?	POWER HI?					W
PLO XXXX	POWER LO XXX.X					W
PLO?	POWER LO?					W
APHI XX.X	AP HI XX.X	See Note4				A
APHI?	AP HI?				A	
APLO XX.X	AP LO XX.X				A	
APLO?	AP LO?				A	
PFHI XXXX	PF HI X.XXX	XXXX=0.000~1.000				
PFHI?	PF HI?	0.000~1.000				
PFLO XXXX	PF LO XXXX	XXXX=0.000~1.000				
PFLO?	PF LO?	0.000~1.000				
CFHI XX.XX	CF HI XX.XX	X.XX=0.00~10.00				
CFHI?	CF HI?	0.00~10.00				
CFLO XX.XX	CF LO XX.XX	X.XX=0.00~10.00				
CFLO?	CF LO?	0.00~10.00				
VAHI XXXX	VA HI XXXX	See Note3				
VAHI?	VA HI?					
VALO XXXX	VA LO XXXX					
VALO?	VA LO?					
QHI XXXX	Q HI XXXX	See Note3				VAR
QHI?	Q HI?				VAR	
QLO XXXX	Q LO XXXX				VAR	
QLO?	Q LO?				VAR	
PTD	PROMPT DELETE					
PT XXXX	PROMPT XXXXXXXXXXXX	XXXX=1~30 BYTES		XXXX=1~30 BYTES		
PT?	PROMPT?					
CONNECT X	CONNECT X	X=0~1,0=OFF,1=ON		X=0~1,0=OFF,1=ON		

CONNECT?	CONNECT?	0~1		0~1		
-----------------	----------	-----	--	-----	---	--

<p>Note1</p> <p>Voltage Range = Low 310XAC=0.000-9.20 320XAC=0.000-18.40 340XAC=0.00-36.80 360XAC=0.00-55.20</p> <p>Voltage Range = High 310XAC=0.000-4.60 320XAC=0.000-9.20 340XAC=0.00-18.40 360XAC=0.00-27.60</p>	<p>Note2</p> <p>Voltage Range = Low 310XAC=0.000-4.80 320XAC=0.000-9.60 340XAC=0.00-19.20 360XAC=0.00-28.80</p> <p>Voltage Range = High 310XAC=0.000-2.40 320XAC=0.000-4.80 340XAC=0.00-9.60 360XAC=0.00-14.40</p>	<p>Note3</p> <p>310XAC=0.0-1000 320XAC=0.0-2000 340XAC=0-4000 360XAC=0-6000</p>	<p>Note4</p> <p>Voltage Range = Low 310XAC=0.0-36.8 320XAC=0.0-73.6 340XAC=0.0-147.2 360XAC=0.0-220.8</p> <p>Voltage Range = High 310XAC=0.0-18.4 320XAC=0.0-36.8 340XAC=0.0-73.6 360XAC=0.0-110.4</p>
---	---	---	---

9.4.5 System Commands and Companion Queries

These commands are used to modify the system parameters for the instrument. These commands require a parameter value to be included with the command. The companion query command will read the parameter using the same value that is used for setting the parameter.

Command	Description	AC Program Mode	AC Manual Mode	DC Program Mode	DC Manual Mode	Unit
AR X	AUTO RUN X	X=0~1,0=PROGRAM,1=MANUAL				
AR?	AUTO RUN?	0~1				
OM X	OUT MODE X	X=0~1,0=AC,1=DC				
OM?	OUT MODE?	0~1				
SS X	SINGLE STEP X	X=0~1, 0=OFF,1=ON	/	X=0~1,0=OFF,1=ON	/	
SS?	SINGLE STEP?	0~1	/	0~1	/	
ALARM X	ALARM X	X=0~9, 0=OFF,9=high				
ALARM?	ALARM?	0~9				
CONTRAST X	CONTRAST X	X=1~9, 9=high				
CONTRAST?	CONTRAST?	1~9				
PUP X	POWER UP X	X=0-2,0=OFF,1=ON,2=LAST				
PUP?	POWER UP?	0-2				
LC XXXX	LOOP CYCLE XXXX	XXXX=0~9999 ,0=Cont,1=OFF	/	XXXX=0~9999 ,0=Cont,1=OFF	/	
LC?	LOOP CYCLE?	0-9999	/	0-9999	/	
VHI XXXX	VOLT HI XXXX	/	XXXX=5.0~300.0	/	XXXX=5.0~420.0	V
VHI?	VOLT HI?	/	5.0~300.0	/	5.0~420.0	V
VLO XXXX	VOLT LO XXXX	/	XXXX=5.0~300.0	/	XXXX=5.0~420.0	V
VLO?	VOLT LO?	/	5.0~300.0	/	5.0~420.0	V
FHI XXXX	FREQ HI XXXX	/	XXXX=40.0~1000	/		Hz

FHI?	FREQ HI?		40.0~1000			Hz
FLO XXXX	FREQ LO XXXX		XXXX=40.0~1000			Hz
FLO?	FREQ LO?		40.0~1000			Hz
SAG XXXX	START ANGLE XXXX		XXXX=0-359			°
SAG?	START ANGLE?		0-359			°
EAG XXXX	END ANGLE XXXX		XXXX=0-359			°
EAG?	END ANGLE?		0-359			°
RESULTS X	RESULTS X	X=0-2, 0=ALL,1=P/F,2=LAST				°
RESULTS?	RESULTS?	0-2				°
OF X	OC Fold X	X=0~1, 0=OFF,1=ON				
OF?	OC Fold?	0~1				
SD X	TRANSIENT X		X=0~1,0=OFF,1=ON			
SD?	TRANSIENT?		0~1			
LOCK X	LOCK X	X=0~1, 0=OFF,1=ON				
LOCK?	LOCK?	0-1				
MEMLOCK X	MEMLOCK X	X=0~1, 0=OFF,1=ON				
MEMLOCK?	MEMLOCK?	0-1				
VS X	VOLT SENSE X	X=0~1, 0=INT,1=EXT				
VS?	VOLT SENSE?	0~1				
FUNCTION X	FUNCTION X	Two units link X=2 3, Three units link X=1 2		Two units link X=2 3, Three units link X=2		
FUNCTION?	FUNCTION?	1=3Ø4W, 2=Parallel, 3=1Ø3W				
SSI X	SYNC SIGNAL X	X=0~2, 0=OFF,1=START,2=EVEN		X=0~2, 0=OFF,1=START,2=EVENT		
SSI?	SYNC SIGNAL?	0~2		0~2		

9.4.6 IEEE 488.2 Common Commands

These commands are required by the IEEE-488.2 standard with the exception of *PSC, *PSC?. Most of these commands are not available over the USB/RS-232 bus except for the *IDN? command which can be used to retrieve the instrument identification information, and the four status reporting commands *ESR?, *ESE, *ESE? and *STB?.

Command	Name	Description
*IDN?	Identification Query	Company, Model Number, Serial Number, Firmware Revision
*RST	Reset Command	Resets Unit
*TST?	Self-Test Query	00H=OK 01H=TEST EEPROM ERROR
*CLS	Clear Status Command	Clear Standard Event Status Register Clear Service Request

	Register
--	----------

Command	Name	Description
*OPC	Operation Complete Command	When TEST command ok setting ESR BIT0 =1
*OPC?	Operation Complete Query	0 = Test in Process 1 = Test Complete OK
*WAI	Wait for next command	
*ESR?	Standard Event Status Register Query	BIT 0 ,01H, (1) Operation Complete
		BIT 1 ,02H, (2) Not Used
		BIT 2 ,04H, (4) Query Error
		BIT 3 ,08H, (8) Device Error
		BIT 4 ,10H,(16) Execution Error
		BIT 5 ,20H,(32) Command Error
		BIT 6 ,40H,(64) Not Used
		BIT 7 ,80H,(128) Power On
*ESE <value>	Standard Event Status Enable Command	value=0~255
*ESE?	Standard Event Status Enable Query	0 - 255
*STB?	Read Status Byte Query	BIT 0 ,01H,(1) All PASS
		BIT 1 ,02H,(2) FAIL
		BIT 2 ,04H,(4) ABORT
		BIT 3 ,08H,(8) Process
		BIT 4 ,10H,(16) Message Available
		BIT 5 ,20H,(32) Standard Event (ESB)
		BIT 6 ,40H,(64) Request Service (MSS)
		BIT 7 ,80H,(128) Prompt
*SRE <value>	Service Request Enable	value=0~255
*SRE?	Service Request Enable Query	0 - 255
*PSC {1 0}	Power-On Status	1 = Power-on clear enable registers 0 = Power-on load previous enable registers
*PSC?	Power-On Status Query	returns value = 0 or 1

***IDN?**

Read the instrument identification string. Company = APT.

***RST**

Reset the instrument to original power on configuration. Does not clear Enable register for Standard Summary Status or Standard Event Registers. Does not clear the output queue. Does not clear the power-on-status-clear flag.

***TST?**

Performs a self test of the instrument data memory. Returns 0 if it is successful or 1 if the test fails.

***CLS**

Clears the Status Byte summary register and event registers. Does not clear the Enable registers.

***OPC**

Sets the operation complete bit (bit 0) in the Standard Event register after a command is completed successfully.

***OPC?**

Returns an ASCII "1" after the command is executed.

***WAI**

After the command is executed, it prevents the instrument from executing any further query or commands until the no-operation-pending flag is TRUE.

***ESR?**

Queries the Standard Event register. Returns the decimal value of the binary-weighted sum of bits.

***ESE <value>**

Standard Event enable register controls which bits will be logically OR'd together to generate the Event Summary bit 5 (ESB) within the Status Byte.

***ESE?**

Queries the Standard Event enable register. Returns the decimal value of the binary-weighted sum of bits.

***STB?**

Read the Status Byte. Returns the decimal value of the binary-weighted sum of bits.

***SRE <value>**

Service Request enable register controls which bits from the Status Byte should

be used to generate a service request when the bit value = 1.

***SRE?**

Queries the Service Request enable register. Returns the decimal value of binary-weighted sum of bits.

***PSC {1|0}**

Sets the power-on status clear bit. When set to 1 the Standard Event Enable register and Status Byte Enable registers will be cleared when power is turned ON. 0 setting indicates the Enable registers will be loaded with Enable register masks from non-volatile memory at power ON.

***PSC?**

Queries the power-on status clear setting. Returns 0 or 1.

10. Calibration Procedure

All Associated Power Technologies, Inc. instruments have been calibrated at the factory prior to delivery. The recommended calibration cycle for all APT instruments is every 12 months.

10.1 Hardware Verification and Calibration Procedure

This instruction sheet covers the hardware calibration procedure for the 300XAC series power supply. This procedure should be used before standard software calibration if hardware verification procedure fails. All Tests should be performed at 60Hz. If the hardware verification does not require adjustment proceed to **10.2 Software Calibration Procedure**.

Required Measurement Standard

- DVM capable of measuring millivolts DC and 115VAC, 400VDC
- Oscilloscope

Required Measurement Equipment

- 475k Ω , ¼ watt resistor
- 11 Ω , 1125Watt (minimum) resistor (310XAC)
- 5.5 Ω , 2250Watt (minimum) resistor (320XAC)
- 2.75 Ω , 4500Watt (minimum) resistor (340XAC)
- 1.8 Ω , 6750Watt (minimum) resistor (360XAC)
- 10 μ F, 110V non-polarized capacitor
- Potentiometer adjustment tool
- Inductor adjustment tool

10.2 Activate Non-Calibration Mode

- Press the “0” and “7” keys while simultaneously powering the instrument ON.

10.3 Adjust Control Circuit Power Voltage

1. Connect the DVM to the “+15V” and “G” points on the FLY61000 board and set to DC volts.
2. Press the “0” and “7” number keys while simultaneously powering the instrument ON.
3. Adjust the VR1 on the FLY61000 board so that DVM measures “+15V” volts +/- 0.1V.

4. Power the instrument OFF then disconnect the DVM.

Note: APT adjusts the control voltage before the instrument leaves our factory. The control voltage value is stable for a long time, so we don't suggest our customers adjust it.

10.4 Adjust the Amplifier Inverter DC Bus Voltage

1. Connect the DVM to the TP6(+) and TP7(-) points on the DDC61000 board and set to DC volts.
2. Power ON the instrument without load.
3. Adjust the VR1 on the DDC61000 board so that DVM measures "+320V" volts +/- 0.3V
4. Power the instrument OFF then disconnect the DVM.

Note: We will adjust the DC Bus voltage before leaving our factory. The DC Bus voltage value is stable for a long time, so we don't suggest our customers adjust it.

10.5 Clear the Output High Frequency Noise* (Only applies to instruments with adjustable L4 inductor located on OPT61000 Output board)

1. Connect the output of the instrument to the Oscilloscope.
2. Adjust the Oscilloscope to approximately 200mV/10us. This will allow viewing of the high frequency noise.
3. Set the output voltage to "0" volts in the low voltage range and activate the output of the instrument.
4. Adjust Inductor L4 on the OPT61000 Output board so that the output high frequency waveform is set to minimum and displayed on the Oscilloscope is $\leq 3000\text{mV P-P}$.
5. Disconnect the Oscilloscope and power the instrument OFF.

10.6 Adjust the "0" Volts and "110" Volts DC Offset

1. Use the jumper to short the JP1 on the ANG66000 board.
2. Press the "0" and "7" number keys while simultaneously powering the instrument ON.
3. Connect the DVM to the output of the instrument and set to DC millivolts.
4. Set the output voltage to "0" volts in the low voltage range and activate the

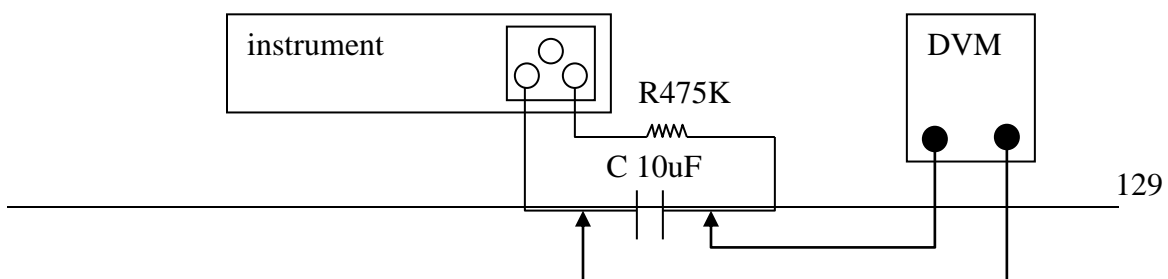

- output of the instrument.
5. Adjust VR4 on the ANG66000 board so that the DVM measures “0” volts \pm 10mV.
 6. Remove the DVM from the output.
 7. Connect the 475k Ω resistor in series with the 10 μ f capacitor and connect the DVM and load to the instrument as illustrated in the following diagram:
 8. Set the DVM to read DC millivolts.
 9. Set the output voltage to “115” volts in the low voltage range and activate the output of the instrument.
 10. Adjust VR2 on the CON61000 board so that the DVM measures “0” volts \pm 10mV.
 11. Disconnect the load and the DVM.
 12. Powering the instrument off then remove the JP1 jumper on the ANG66000 board.

Note1: The hardware function can Auto correct the output DC offset to near 0 volts. You need to disable this hardware circuit function when manually adjusting the DC offset. We have designed the JP1 on the ANG66000 board to disable this hardware circuit function now.

Note2: We will adjust the DC Offset voltage before leaving our factory. The DC Offset value is stable for a long time, so we don’t suggest our customers adjust it.

10.7 Adjust Wattmeter Offset

1. Press the “0” and “7” number keys while simultaneously powering the instrument ON.
2. Set the output voltage to “61” volts in the high voltage range and activate the output of the instrument.
3. Take note of the reading on the Wattmeter.
4. Set the output voltage to “300” volts and activate the output of the instrument.
5. Adjust VR1 on the ANG66000 board so that the reading of the wattmeter matches the value that was noted at “61” volts.

Note: The wattmeter gain is different when the output voltage range is at 0~60V and 61~300V. We must use the same range wattmeter gain to adjust the wattmeter offset. The 61V is the lowest voltage when output voltage range at 61~300V, so we use the 61V to take note of the reading on the wattmeter.

10.8 Adjust Hardware OCP Set Point

1. Connect the load resistor to the output of the instrument.

Model	Resistance
310XAC	11 Ω , 1125Watt (minimum) resistor
320XAC	5.5 Ω , 2250Watt (minimum) resistor
340XAC	2.75 Ω , 4500Watt (minimum) resistor
360XAC	1.8 Ω , 6750Watt (minimum) resistor

2. Rotate VR1 of the CON61000 board fully clockwise.
3. Set the output voltage to “105” volts in the low voltage range and activate the output of the instrument.
4. Using the Rotary knob to adjust the voltage up until the following value is displayed on the current meter:

Model	Value
310XAC	9.85 amps
320XAC	19.70 amps
340XAC	39.40 amps
360XAC	59.10 amps

5. Wait 15 seconds.
6. Rotate VR1 of the CON61000 board counter levorotary until the LCD meter displays OCP.
7. Disconnect the resistor load.

10.9 Exit Non-Calibration Mode

Exit Non-Calibration mode for normal operation. Reset the instrument by powering it off and then back on for standard operation mode.

10.10 Software Calibration Procedure

The software calibration is recommended to be performed after the hardware verification and hardware calibration has been completed.

Required Measurement Standard

- 0-40 Amp AC True RMS Ammeter
- 0-300 VAC True RMS Voltmeter
- 4000 W Wattmeter

Required Measurement Equipment

- 100 Ω /50 W Resistor & 24 Ω /400 W Resistor for 310XAC Model
- 50 Ω /100 W Resistor & 12 Ω /1000 W Resistor for 320XAC Model
- 25 Ω /200 W Resistor & 6 Ω /2000 W Resistor for 340XAC Model
- 12 Ω /4000 W Resistor & 3 Ω /2000 W Resistor for 360XAC Model

10.11 Enter Calibration Mode

To enter the calibration mode power on the unit while holding the 4 key on the numeric keypad. When in the calibration mode the display will look as follows:



Use the up or down arrow soft keys to navigate to the parameter that you would like to calibrate. The parameters available for calibration are Voltage 150.0V, Voltage 300.0 V, Current xx.xxA, Power xxxW, and A-Peak xx.xA. The actual values for the Current, Power, and A-Peak will change according to the model number. For example if you are calibrating the 340XAC the readings will be Current 2.0A, Current 36.00A, Power 4000W, and A-Peak 52.0A. Use the Select soft key to select the parameter for calibration. If you press the Exit soft key from this screen you will be kicked out of the Calibration mode and returned to the set screen.

10.12 Calibration of Voltage 150.0V

Use the up or down arrow soft keys to navigate to the Voltage 150.0V parameter and press the Select soft key.

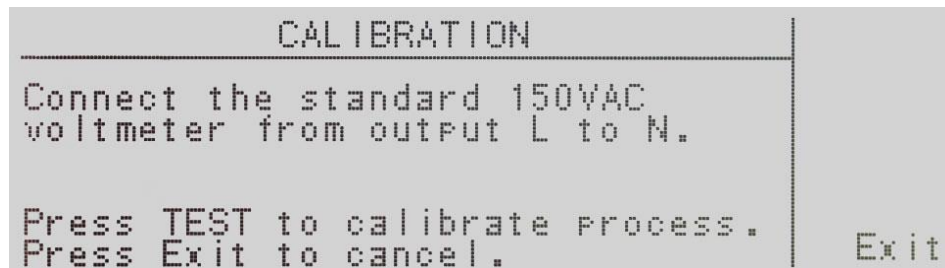

Follow the prompt message provided on the display, and press the Test/Reset button to move into the calibration screen for voltage. If you press the Exit soft key at this screen you return to the calibration mode screen.

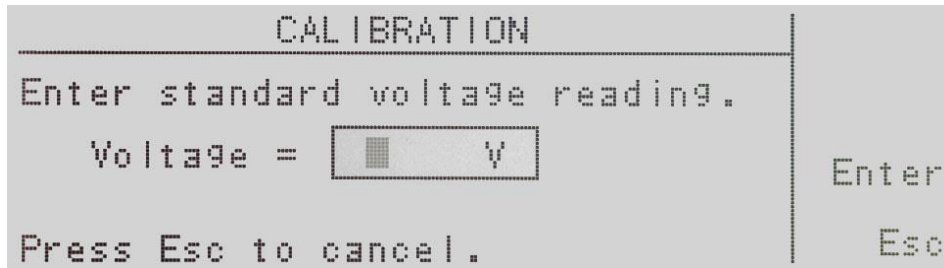

Enter the voltage reading from the voltmeter with the numeric keypad. When the value has been selected press the Enter soft key and you will be moved to the next calibration parameter Voltage 300.0V. If you press the Esc soft key you will be returned to the calibration mode screen.

10.13 Calibration of Voltage 300.0V

Use the up or down arrow soft keys to navigate to the Voltage 300.0V parameter and press the Select soft key.



Follow the prompt message provided on the display, and press the Test/Reset button to move into the calibration screen for voltage. If you press the Exit soft key at this screen you return to the calibration mode screen.

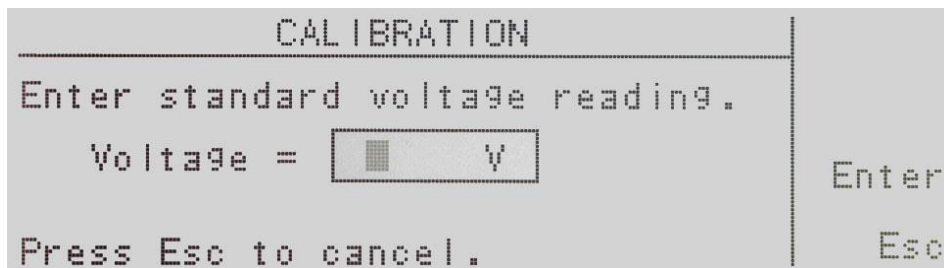

Enter the voltage reading from the voltmeter with the numeric keypad. When the value has been selected press the Enter soft key and you will be moved to the next calibration parameter Current xx.xA. If you press the Esc soft key you will be returned to the calibration mode screen.

10.14 Calibration of High and Low Current Range

Use the up or down arrow soft keys to navigate to the Current x.xxxA, or Current xx.xxA parameter and press the Select soft key.

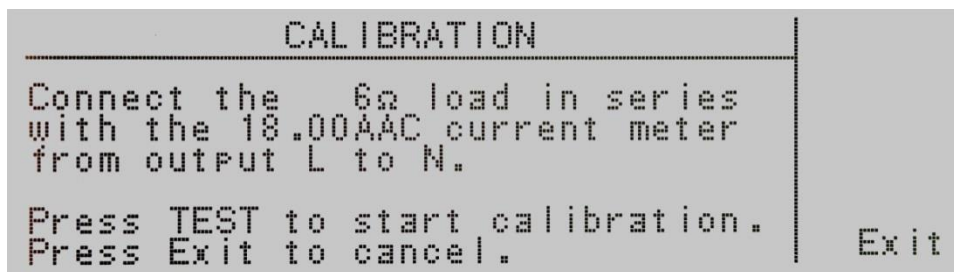

Follow the prompt message provided on the display, and press the Test/Reset button to move into the calibration screen for current. If you press the Exit soft key at this screen you return to the calibration mode screen.

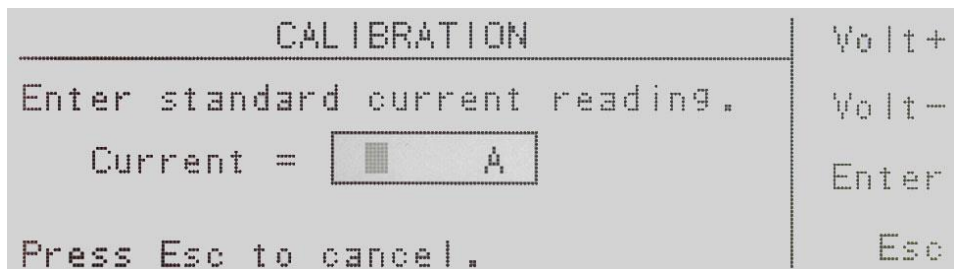

Enter the current reading from the ammeter with the numeric keypad. When the value has been selected press the Enter soft key and you will be moved to the next calibration parameter. The soft keys Volt+ and Volt- are available, if needed, to adjust the voltage output of the instrument to set a proper current value if a non-recommended load is used. If you press the Esc soft key you will be returned to the calibration mode screen.

10.15 Calibration of High and Low Power Range

Use the ^, v soft keys to navigate to Power xx.xW, or Power xxxW parameter and press the Select soft key.

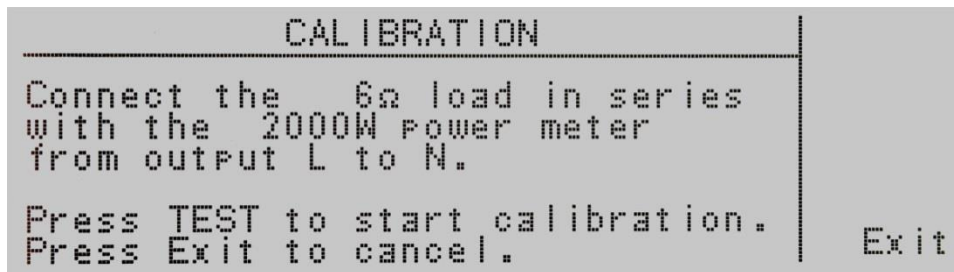

Follow the prompt message provided on the display, and press the Test/Reset button to move into the calibration screen for wattage. If you press the Exit soft key at this screen you return to the calibration mode screen.

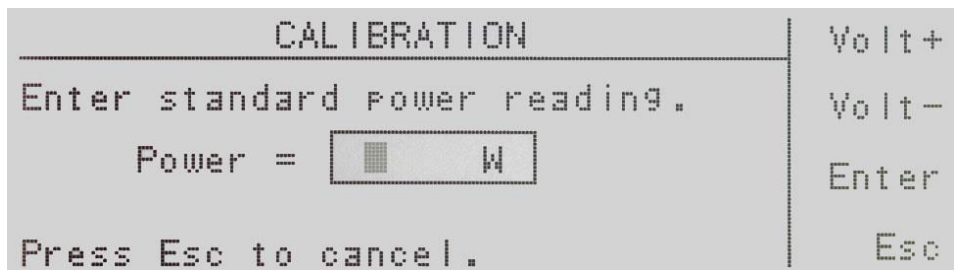

Enter the power reading from the wattmeter with the numeric keypad. When the value has been selected press the Enter soft key and you will be moved to the next calibration parameter. The soft keys Volt+ and Volt- are available, if needed, to adjust the voltage output of the instrument to set a proper wattage value if a non-recommended load is used. If you press the Esc soft key you will be returned to the calibration mode screen.

10.16 Calibration of Peak Current

Use the \wedge , \vee soft keys to navigate to the A-Peak xx.xA parameter and press the Select soft key.

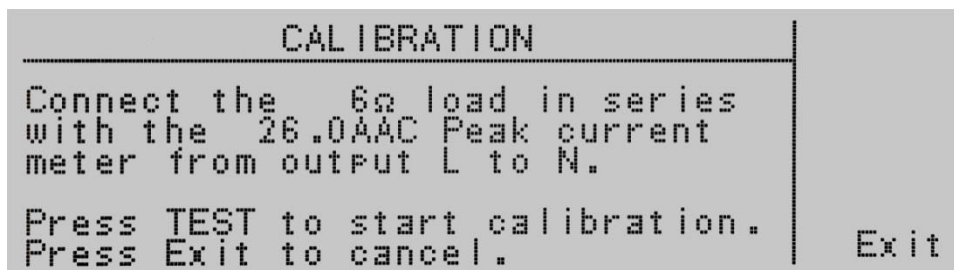

Follow the prompt message provided on the display, and press the Test/Reset button to move into the calibration screen for current. If you press the Exit soft

key at this screen you return to the calibration mode screen.

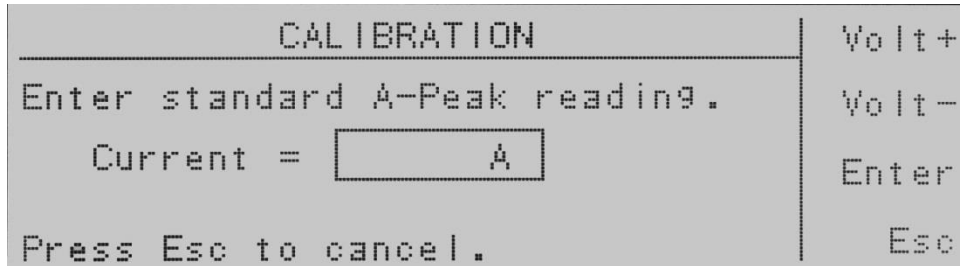

Enter the current reading from the ammeter with the numeric keypad. When the value has been selected press the Enter soft key and you will be moved to the next calibration parameter Volt 150.0V. The soft keys Volt+ and Volt- are available, if needed, to adjust the voltage output of the instrument to set a proper peak current value if a non-recommended load is used. If you press the Esc soft key you will be returned to the calibration mode screen.

11. Options

11.1 Opt. 02 – Grounded Neutral

This option allows for a grounded return on the neutral output. It is ideal for looking to reduce overall leakage current that can result from the instrument itself in normal applications. This option is ideal for the medical industry.

11.2 Opt. 03 – GPIB Card

This option provides the GPIB interface card in place of the standard USB/RS-232 interface.

11.3 Opt. 04 – 7 Remote Memories Select

This option allows the instrument to be interconnected to the Associated Research line of electrical safety testers to automatically recall memory locations within the AC power source. This option replaces the standard USB/RS-232 interface.

11.4 Opt. 06 – Ethernet Card

The Ethernet Card option provides RS-232 and Ethernet communication interfaces, as well as barcode scanning capability.

The Ethernet Card has three input/output ports, shown in the following figure:

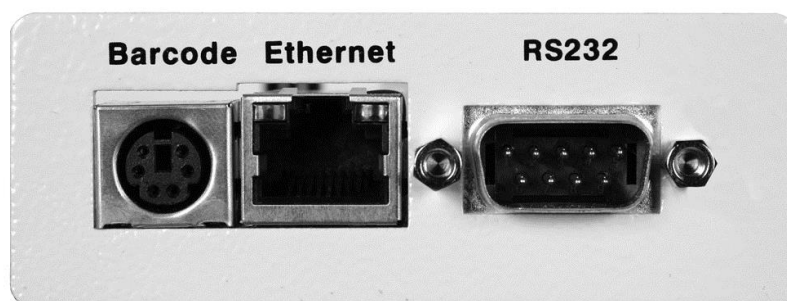

The port labeled “Barcode” is a PS/2-type connector that is used for the connection of a barcode scanner. The Ethernet port is for use with a standard CAT-5 Ethernet cable and may be connected to any compatible PC. The 9-pin D-type subminiature connector labeled “RS232” is for connection of the APT

300XAC to an RS-232 communication bus.

RS-232 Interface

The protocol for interfacing and communicating using the RS-232 interface can be found in section **9. Bus Remote Interface USB/GPIB/RS-232** of this manual.

Ethernet Interface

The Ethernet interface provides all of the function control of the standard USB/RS-232 interface. Some commands are only exclusive to GPIB control.

Default Settings

The default settings for the Ethernet interface are as follows:

IP Setup: AUTO
IP Address: 010.000.000.000
Gateway IP: 000.000.000.000
Subnet Mask: 255.000.000.000

The source port number for the Ethernet Card in TCP connections is 10001.

11.4.1 Ethernet Card Setup

In order to setup the Ethernet card, the operator will need information from the local network administrator. Please have your network administrator fill out the required information on the next page and keep it for your records:

**Associated Power Technologies, Inc.
Ethernet Card Communications Information
(To be completed by Network Administrator)**

Ethernet Card Address: _____:_____:_____:_____:

Device Name: _____

Device IP Address: _____.

Gateway IP Address: _____.

Subnet Mask: _____.

11.4.2 Saving New Settings

Upon startup, the Ethernet Card will take a few seconds to initialize. The following message will be displayed:

```

M 1-1 20.0s F: 60.0Hz Ap: 0.0A | Memory
Set P: | Step
      | Edit
      | <more>
  
```



Any time the user edits one of the Ethernet Card parameters and exits the Ethernet Card Settings menu, the following message will be displayed:

```

IF Setup          AUTO
IP Address
Gateway |
Subnet Ma  SAVING NEW
Device Na  SETTINGS...
MAC Addre
Barcode |
Autostart | Exit
  
```



The Ethernet Card will attempt to re-establish a connection with the server anytime the user modifies a parameter and exits the Ethernet Card Parameters Menu or uses the command set at the end of this option description. Thus, if the IP Setup is set to AUTO, the Ethernet Card will request a new IP Address every time a parameter is edited and, as a result, the “Requesting IP Address. . .” message will appear.

11.4.3 Power Up

The Ethernet Card will be installed with the default options listed above. After the APT 300XAC initially powers up, the following pop-up message will appear:

```

M 1-1 20.0s F: 60.0Hz Ap: 0.0A |
Set P: |
      |
      | IP ADDRESS:
      | Requesting...Please
      | wait, or press EXIT
      | to cancel.
      |
      | Exit
  
```

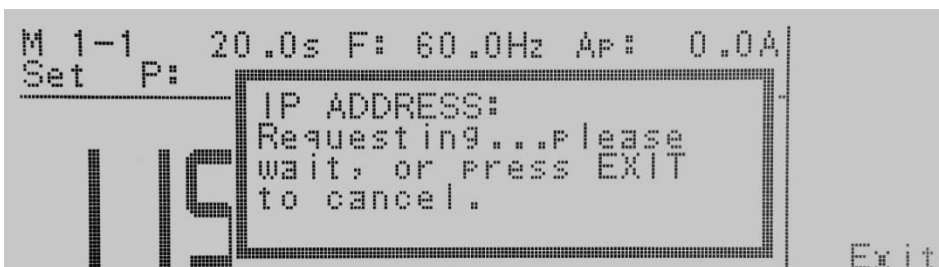

Note: The “Requesting IP Address...” pop-up message only appears at power up when the Ethernet Card has its IP Setup configured to AUTO.

There are two options to choose from this screen. Press the Exit soft key to escape from this screen and stop the APT 300XAC from requesting an IP address or allow the APT 300XAC to request an IP address automatically from the network to which it is connected.

The Ethernet Card will wait for an IP Address for approximately 20 seconds. If the APT 300XAC successfully receives an IP Address from the server the following pop-up message will be displayed:

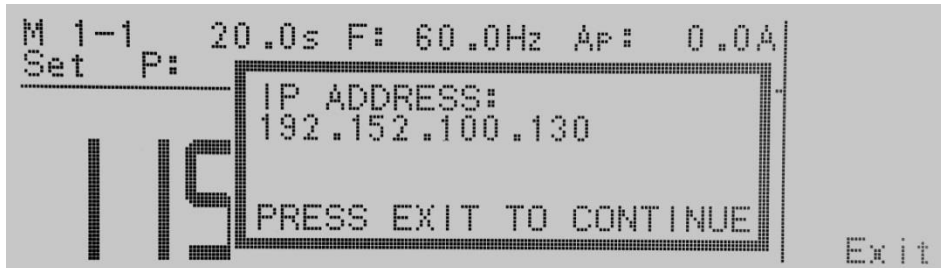

If the APT 300XAC fails to receive an IP Address after approximately 20 seconds, the following pop-up message will be displayed:

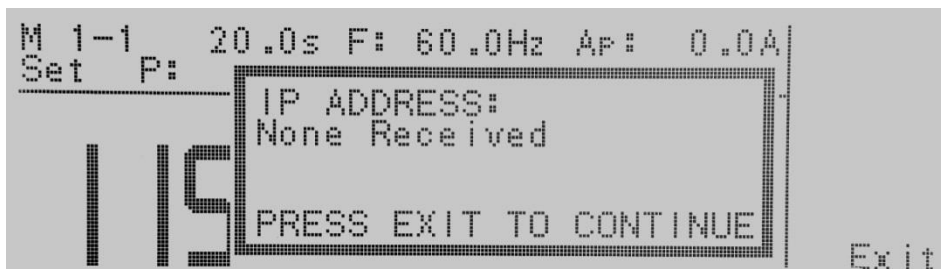

Press the Exit soft key to remove the pop-up message and return to the APT 300XAC's Perform Tests screen.

11.4.4 Ethernet Card Menu

When the Ethernet Card option is installed, the ENET soft key will appear in the Perform Tests screen as shown below:



To access the Ethernet Card Menu, press the <more> soft key at the Perform Tests screen. Press the ENET soft key to display the Ethernet Card Parameters screen:

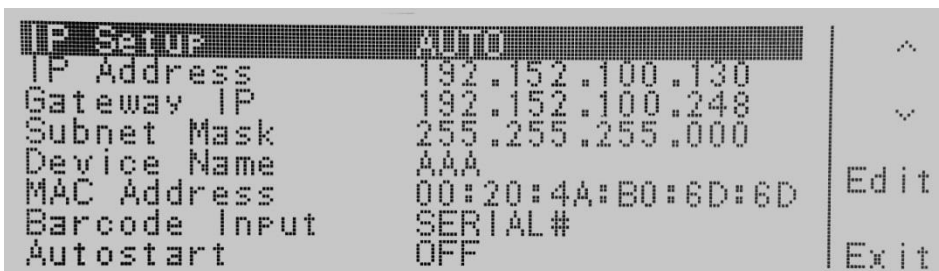

11.4.5 IP Setup

Highlight the IP Setup parameter using the ^, v soft keys. When the IP Setup parameter is highlighted, press the Edit soft key.

IP Setup is used to determine how the APT 300XAC will request an IP address from the server to which it is connected. When AUTO is selected, the APT 300XAC will attempt to automatically request an IP Address from the server upon power up. To resolve the IP Address automatically, the APT 300XAC will use DHCP or BOOTP protocols. When MANUAL is selected, the APT 300XAC will request a specific IP Address from the server. The IP Address that will be requested must be entered in the subsequent IP Address parameter field.

Use the Change soft key to select how you would like the APT 300XAC to resolve an IP address. Press the Enter soft key to accept the new setting or the Exit soft key to cancel and return to the original setting.

11.4.6 IP Address

Highlight the IP Address parameter using the \wedge , \vee soft keys. When the IP Address parameter is highlighted, press the Edit soft key.

A specific IP Address must be entered into this field if the IP Setup parameter is configured to MANUAL. Enter the IP Address that you wish using the numeric keypad. The IP Address must be entered in the following format: XXX.XXX.XXX.XXX. A valid IP Address must be entered. Users may not use the following IP Addresses:

255.255.255.255
000.000.000.000

Enter the preceding IP Addresses will cause the following error message to be displayed:

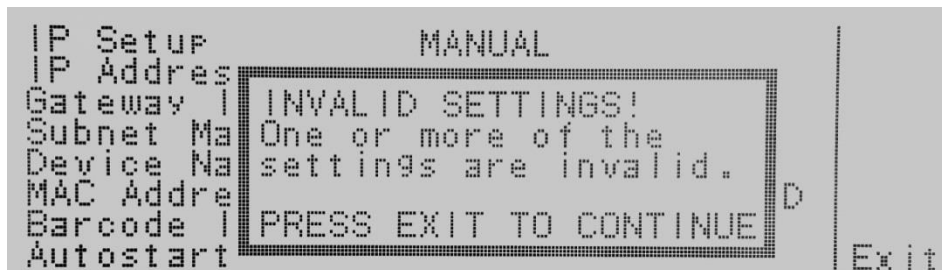

Press the Exit soft key to save the new settings. If the IP Setup parameter is set to AUTO, you do not need to enter an IP Address manually.

11.4.7 Gateway IP

Highlight the Gateway IP parameter using the \wedge , \vee soft keys. When the Gateway IP parameter is highlighted, press the Edit soft key.

A specific Gateway IP must be entered into this field if the IP Setup parameter is configured to MANUAL. Enter the Gateway IP using the numeric keypad. The Gateway IP must be entered in the following format: XXX.XXX.XXX.XXX.

Press the Enter soft key to save the new settings. If the IP Setup parameter is set to AUTO, you do not need to enter a Gateway IP manually.

11.4.8 Subnet Mask

Highlight the Subnet Mask parameter using the \wedge , \vee soft keys. When the Subnet Mask parameter is highlighted, press the Edit soft key.

A specific Subnet Mask must be entered into this field if the IP Setup parameter is configured to MANUAL. Enter the Subnet Mask using the numeric keypad. The Subnet Mask must be entered in the following format: XXX.XXX.XXX.XXX. If an invalid Subnet Mask is entered the following error message will be displayed:

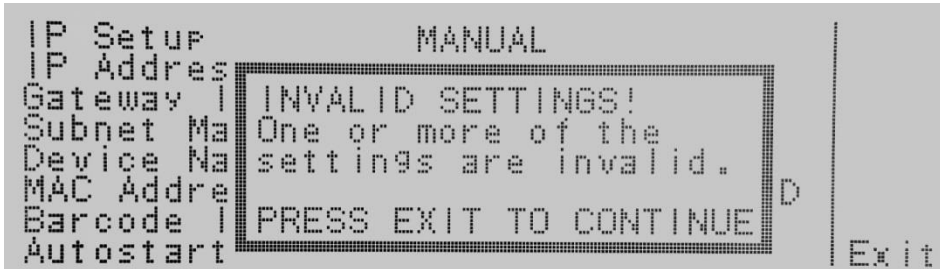

Press the Enter soft key to save the new settings. If the IP Setup parameter is set to AUTO, you do not need to enter a Subnet Mask manually.

11.4.9 Device Name

Highlight the Device Name parameter using the \wedge , \vee soft keys. When the Device Name parameter is highlighted, press the Edit soft key.

The Device Name screen will appear as follows:



From this screen you may enter a Device Name for the APT 300XAC. The Device Name is used to identify the APT 300XAC on your server and may be used in place of a dedicated IP Address. Use the arrow keys to highlight a letter and press the Select soft key to select the highlighted letter. The Device Name may be a maximum of eight characters and MUST start with a letter. If the Device Name does not start with a letter the following error message will be displayed:

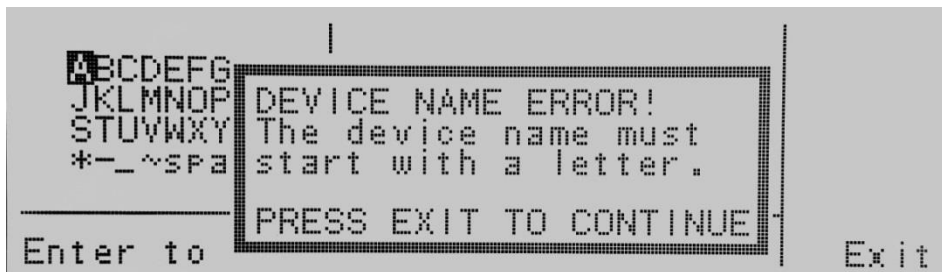

When the Device Name has been entered, press the Enter soft key to save the new settings. The Device Name parameter is only active when the IP Setup is set to AUTO.

11.4.10 MAC Address

View the MAC address of the Ethernet Card here. This parameter is not adjustable.

11.4.11 Barcode Input

Highlight the Barcode INPUT parameter using the \wedge , \vee soft keys. When the Barcode INPUT parameter is highlighted, press the Edit soft key.

The Barcode INPUT parameter can be set to SERIAL#, PRODUCT#, SER/PROD, OFF or RUN FILE.

When the setting is SERIAL#, PRODUCT# or SER/PROD, the user can scan barcodes in the Perform Tests screen before the test is started. When a barcode is scanned, one of the following messages will appear on the display.

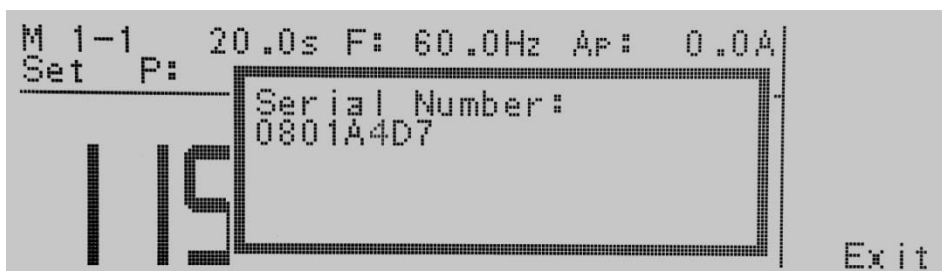

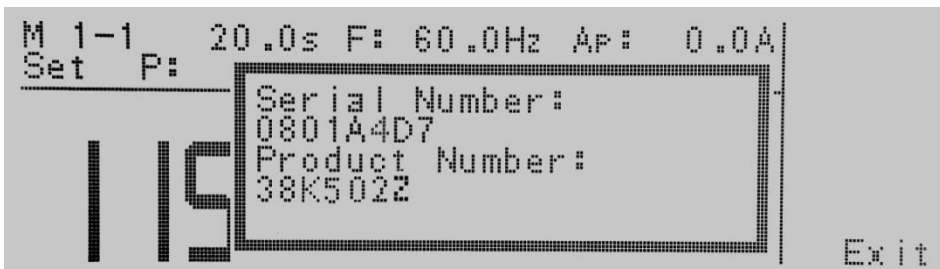
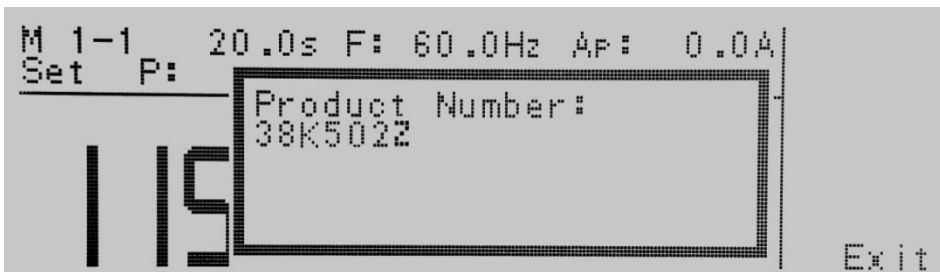

After the barcodes are scanned, press Test to initiate the test sequence. Pressing Reset will abort the test sequence.

The Ethernet Card permits re-scanning of barcodes if the previously scanned barcode was incorrect. Re-scanning is only available in the SERIAL#, PRODUCT# and SER/PROD modes. If the user decides to re-scan barcodes when the Barcode INPUT setting is set to SER/PROD, the Ethernet Card will first replace the data in the Serial Number field, and if the user re-scans another barcode, the Ethernet Card will replace the data in the Product Number field.

The RUN FILE selection gives the user the ability to automatically load and execute a test file based on what barcode is scanned from the Perform Tests screen. In order for this feature to work, the user must name the desired test file with the exact alpha-numeric code that is on the product's barcode label. For example, if Product A has barcode "123456789", then the test file that the user would like to run when testing Product A should be named "123456789". When the product's barcode is scanned, the APT 300XAC will immediately execute the test associated with that barcode. The test file name is limited to 10 characters. However, if the user names a test file with the maximum 10 characters, this function will still initiate a test when a product's barcode begins with those first 10 characters even if the barcode has more than 10 characters.

WARNING

Using the RUN FILE feature will enable the instrument's output once the barcode is scanned. Do not touch the DUT at any time when using this feature in order to avoid potential shock or serious injury.

For all types of tests two fields are added to the end of the standard response when the Barcode INPUT setting is set to SERIAL#, PRODUCT# or SER/PROD. The first field contains the Serial Number information and the second field contains the Product Number information. Both fields are included regardless of which of these three modes are selected. The Ethernet Card will substitute a “0” for the field if it is not applicable to the setting. For example, if a user had their Barcode INPUT setting set to SERIAL#, and scanned a Serial Number with the value “123456789”, the TD? response for a test could be:

1,1,Pass,60.0,115.2,0.306,24.7,0.9,0.632,20.0,123456789,0

Note that there is a “0” in the Product Number field because the Barcode INPUT setting is SERIAL#.

When the Barcode INPUT setting is RUN FILE or OFF, these fields are not included in the TD? and RD x? responses.

Use the Change soft key to select the Barcode INPUT. Press the ENTER key to accept the new setting or the EXIT key to cancel and return to the original setting.

11.4.12 Autostart

Highlight the Autostart parameter using the ^, v soft keys. When the Autostart parameter is highlighted, press the Edit soft key.

When Autostart is enabled, the test will execute as follows:

If the Barcode INPUT is set to PRODUCT#, scan the barcode once to input it into the APT 300XAC. The APT 300XAC will then search for a test file name that matches the product number barcode string. If the APT 300XAC finds a match, it will load the file into RAM.

WARNING

When the same product number barcode is scanned a second time, the test will be executed automatically. If APT 300XAC does not find a file name that matches the barcode string, the unit will beep – notifying the user that it did not find a matching file name. The test file name is limited to 10 characters. However, if the user names a test file with the maximum 10 characters, this function will still load a test file if the first 10 characters of the product number match the file name.

If the Barcode INPUT is set to SER/PROD, scan the serial number once to input it into the APT 300XAC. Next, scan the product number. From this point, APT 300XAC will operate the same as when the Barcode INPUT setting is set to

PRODUCT#.

The Autostart feature will not work with the SERIAL# setting.

The Autostart feature will enable the instrument's output once the product number barcode is scanned a second time when in the PRODUCT# and SER/PROD modes. Do not touch the DUT at any time when using this feature in order to avoid potential shock or serious injury.

Use the Change soft key to select the Autostart setting. Press the Enter soft key to accept the new setting or the Exit soft key to cancel and return to the original setting.

11.4.13 Ethernet Card Settings Commands and Companion Queries

Command	Name	Value
SIM {1 0} SIM?	Set IP Mode	1=Manual, 0=Auto (DHCP/BOOTP)
SIA <value> SIA?	Set IP Address	Dotted decimal form. Ex. 192.168.1.50
SGA <value> SGA?	Set Gateway IP Address	Dotted decimal form
SSM <value> SSM?	Set Subnet Mask	Dotted decimal form
SDN <value> SDN?	Set Device Name	8 character max, must start with a letter
MAC?	MAC Address Query	Example response: 00:20:4A:8B:B4:30
SBI {4 3 2 1 0} SBI?	Set Barcode Input	0=Off, 1=Serial# and Product#, 2=Serial# Only, 3=Product# Only, 4=Run File
SAS {1 0} SAS?	Set Autostart	1=On, 0=Off

Communication Considerations

- All of the above commands (excluding the query commands) will respond with the 06 hex (6 decimal) Acknowledge (ACK) ASCII control code if the transfer was recognized by the instrument.
- If there was an error with the command string, the instrument will respond with 15 hex (21 decimal), the Not Acknowledge (NAK) ASCII control code.

- However, the presence of this response does not mean that the instrument (in the case of these commands only) completed the command. These commands require a restarting of the hardware that controls the Ethernet Protocols. Because of this, the user must wait before the Ethernet Card will respond to another command. See the table below for the approximate wait times necessary after one of the commands in the table is sent. In addition, the current socket connection between the user's terminal and the Ethernet Card is no longer valid, and the user will need to close their current connection and establish a new one.

11.4.14 Ethernet Card Settings Command Wait Times

IP Mode	Command	Wait Time After Command is Sent*
Manual	SIA, SGA, SSM	8 seconds
	SIM 0	14 seconds
Auto	SDN	14 seconds
	SIM 1	8 seconds

*Wait times are approximate and can vary based on the user's network.

11.5 Opt. 08 – Linking Card

This option enables the instrument to interconnect to up to two (2) other 300XAC instruments for Parallel and Polyphase operation. For detailed information setting up an instrument to run in Parallel and Polyphase modes refer to section **6. Multiple Instrument Operation.**

12. Service and Maintenance

User Protection

To avoid electrical shock do not dismantle the cover of the instrument. When any abnormal symptom happens with the instrument, please contact Associated Power Technologies, Inc. or the authorized distributor for assistance.

Consistency of Service

The instrument's internal circuits and all related parts are required to be checked and calibrated at least once every year. This is to protect the user in terms of safety and to insure a high accuracy of operation and measurement of this instrument at all times.

User Modification

Modification by the user of the instrument's internal circuits and all related parts is not recommended. All warranties will be void if any modifications have been conducted by the user. Associated Power Technologies, Inc. reserves the right to convert the original circuitry to its original state if any modifications have been made to the instrument. The customer will be responsible for any charges associated with bring the instrument to its original state.

13. Replacement Parts List

Rev: C, ECO5763 05/27/2015

Part Number	Qty.	Ref. Designator	Description
Supplied Accessories			
38787	2	-	3U Rack Mount Handle
38788	2	-	3U Rack Mount Bracket (310XAC, 320XAC)
39172	2	-	6U Rack Mount Bracket (340XAC)
39173	2	-	9U Rack Mount Bracket (360XAC)
39174	4	-	Screw for Rack Mount Handle to Rack Mount Bracket
39066	1	-	USB Cable AB Type 1.8m
39140	1	-	Linking Cable 0.8m with 15-pin DSUB
39177	3	-	Shorting Bar for Input 3-phase 3-wire Delta connection. (360XAC)
39178	1	-	Shorting Bar for Input 3-phase 4-wire [Y] or 1-phase 2-wire connection. Part does not include screw 39243. (360XAC)
39179	1	-	Shorting Bar for Input 1-phase 2-wire connection (together with 39178). Part does not include screw 39243. (360XAC)
39243	2	-	Screw for Shorting Bars 39178, 39179
Panel Components			
37793	1	-	Panel Bezel Plastic 3U
38109	1	SW1	Power Switch 2P 10A/250V
39220	1	EVR1	Rotary Encoder
38973	1	-	Rotary Knob
38274	12	-	Button Keypad Rect. 9.8 x 8.0mm
38275	6	-	Button Keypad Rect. 9.8 x 4.9mm
38101	1	-	Feet Kit w/o Rubber Inserts (310XAC, 320XAC, 340XAC)
38102	4	-	Rubber Insert for Feet (310XAC, 320XAC, 340XAC)

Part Number	Qty.	Ref. Designator	Description
39664	2	-	Front Wheel with brake 3.5" (360XAC)
39665	2	-	Rear Wheel 3.5" (360XAC)
38916	1	-	Graphic LCD Display
38021	2	-	Diode LED Red Square
39168	1	-	Output Terminal Block 75A, 3 positions (340XAC, 360XAC)
39169	1	-	Sense Terminal Block 20A, 2 positions (340XAC, 360XAC)
39170	1	-	Input Terminal Block 30A, 3 positions (340XAC, 360XAC)
39171	1	-	Input Terminal Block 30A, 4 positions (360XAC)
39189	1	CN1	Output Terminal Block 30A, 5 positions. Part mounted on the PCB OPT61000 (310XAC, 320XAC)
39209	1	CN3	Input Terminal Block 30A, 3 positions. Part mounted on the PCB PFC61000 (310XAC, 320XAC)
PCB Assemblies			
38967	1	KEY6700	Keypad Board
39063	1	USB/RS232	USB/RS232 Interface Board
38779	1	REM6700	Remote Input Board
38305	1	CGP-03	GPIB Interface Board
38819	1	38818	Ethernet Card
39119	1	CON61000	Main Control Board
39120	1	ANG66000	Analog Board
39121	1	AMP61000	Amplifier Board (310XAC)
39122	1-(320XAC) 2-(340XAC) 3-(360XAC)	AMP61000	Amplifier Board (320XAC, 340XAC, 360XAC)
39123	1	DDC61000	DC to DC Converter Board (310XAC)
39124	1-(320XAC) 2-(340XAC) 3-(360XAC)	DDC61000	DC to DC Converter Board (320XAC, 340XAC, 360XAC)
39125	1	PFC61000	PF Correct Board (310XAC)
39126	1	PFC61000	PF Correct Board (320XAC)
39127	1	PFC61000	PF Correct Board (340XAC)

39128	3	PFC61000	PF Correct Board (360XAC)
39129	1	FLY61000	FLY Back Board (310XAC, 320XAC)
39130	1	FLY61000	FLY Back Board (340XAC, 360XAC)
39131	1	FLY61040	FLY Back Board (340XAC, 360XAC)
Part Number	Qty.	Ref. Designator	Description
39132	1	OPT61000	Output Board (310XAC)
39133	1	OPT61000	Output Board (320XAC)
39134	1	OPT6660	Output Board (340XAC)
39135	1	OPT6660	Output Board (360XAC)
39136	1	EPP66000	Linking Card
Internal Components			
39114	1	IC 34	EEPROM 39SF020A
38802	1	IC 41	Microcontroller W77LE516P-25JC
38452	3	-	Fan 24VDC 240mm (340XAC, 360XAC)
39263	2-(310XAC, 320XAC) 3-(340XAC) 5-(360XAC)	-	Fan 24VDC 120mm
38808	1	-	Fan 24VDC 60mm (360XAC)
37923	1	F1	Fuse 2A Slow 20mm for FLY61000
39180	2	F1, F2	Fuse 4A Slow 30mm for DDC61000 (310XAC)
39181	1	F2	Fuse 5A Slow 30mm for PFC61000 (310XAC)
39182	2	F1, F2	Fuse 8A Slow 30mm for DDC61000 (320XAC, 340XAC, 360XAC)
39183	1-(320XAC) 3-(360XAC)	F2	Fuse 10A Slow 30mm for PFC61000 (320XAC, 360XAC)
39037	1	F2	Fuse 20A Slow 30mm for PFC61000 (340XAC)
39187	1-(310XAC) 3-(360XAC)	F1	Fuse 15A Fast 38mm for PFC61000 (310XAC, 360XAC)
39188	1	F1	Fuse 30A Fast 38mm for PFC61000 (320XAC, 340XAC)