



# INSTRUCTION & OPERATIONS MANUAL



## **AQ EXPERT** PORTABLE MULTIFUNCTIONAL INDOOR AIR QUALITY MONITOR



**E Instruments International LLC**  
402 Middletown Blvd, Suite 216  
Langhorne, PA, USA 19047  
Phone (215) 750-1212  
Fax (215) 750-1399  
**Info@E-Inst.com**  
**www.E-Inst.com**



## TABLE OF CONTENTS

CHAPTER 1.....	3
TECHNICAL SPECIFICATIONS & SAFETY GUIDELINES.....	3
CHAPTER 2.....	8
INTRODUCTION.....	8
CHAPTER 3.....	12
BASIC INSTRUMENT OPERATION.....	12
CHAPTER 4.....	15
POWER REQUIREMENTS.....	15
CHAPTER 5.....	16
SENSORS - TECHNICAL.....	16
CHAPTER 6.....	22
AQ EXPERT SETUP.....	22
CHAPTER 7.....	25
INTERNAL DATA STORAGE.....	25
CHAPTER 8.....	27
WIRELESS REMOTE PRINTER.....	27
CHAPTER 9.....	29
ZERO & SPAN CALIBRATION.....	29
CHAPTER 10.....	37
AQ GAS SOFTWARE™.....	37
CHAPTER 11.....	43
MAINTENANCE.....	43
CHAPTER 12.....	46
AQ EXPERT OPTIONS.....	46
CHAPTER 13.....	49
BASIC TROUBLESHOOTING.....	49
CHAPTER 14.....	51
REPLACEMENT PARTS.....	51

---

## CHAPTER 1

---

### TECHNICAL SPECIFICATIONS & SAFETY GUIDELINES

#### AQ EXPERT - AIR QUALITY MONITOR

##### 1. PHYSICAL:

Material: White ABS plastic case with internal aluminum shielding

Dimensions (monitor): 11.42" X 10.24" X 4.88"

Weight: (monitor): 7.6 lbs. / 3.5 kg

Shipping Dimensions & Weight (monitor & all accessories): 15 lbs. / 7 kg

19" x 17" x 15" / 48.2 cm x 43.1 cm x 38.1 cm

##### 2. POWER:

12 Volt, 8 AH rechargeable Li-Ion battery pack

Operating time: 6 – 8 hours continuous use

110/240 VAC input, 12 V/2.5A fast charger

Charging time: 3 hours maximum

##### 3. DISPLAY:

2.6" x 1.4" 128 x 64 graphic, chip on glass (white backlit) LCD display.

Rotating display depending on monitor case orientation

Small and large fonts, plus inverted background color for help messages

Battery condition & charger operation indicator

##### 4. WIRELESS REMOTE PRINTER

2" high resolution, high speed, graphic thermal printer, with charger, prints:

A. current set of data

B. stored data

C. periodic data printouts

D. calibration history and external messages

##### 5. INSTRUMENT PUMP

Continuous Air sample pump: high quality diaphragm pump with long life motor

##### 6. STORAGE

1000 Internal memory storage tags, each tag stores one complete set of data

##### 7. COMMUNICATIONS

Bluetooth wireless: Class 1 (100m)

USB Cable

##### 8. SOFTWARE

AQ GAS™ Windows PC Software

## SENSORS

### 1. AIR QUALITY SENSORS – ELECTROCHEMICAL

SENSOR		RANGE	RES.	ACCURACY
CARBON MONOXIDE (CO)	<b>Std Range</b>	0 - 200 ppm	0.1 ppm	+/- 1 ppm of rdg, +/- 0.2 ppm
CARBON MONOXIDE (CO)	High Range	0 - 2000 ppm	1 ppm	<300ppm, 10ppm To 2000ppm, 4%
OXYGEN (O <sub>2</sub> )	<b>Std Range</b>	0 – 25%	0.1%	0.1% Vol.
NITRIC OXIDE (NO)	<b>Std. Range</b>	0 - 250 ppm	0.1 ppm	+/- 2 ppm of rdg
NITRIC OXIDE (NO)	High Range	0 - 2000 ppm	1 ppm	<100ppm, 5ppm To 2000ppm, 4%
NITROGEN DIOXIDE (NO <sub>2</sub> )	<b>Std. Range</b>	0 - 20 ppm	0.1 ppm	+/- 0.5 ppm of rdg
NITROGEN DIOXIDE (NO <sub>2</sub> )	High Range	0 - 1000 ppm	1 ppm	<100ppm, 5ppm To 1000ppm, 4%
SULFUR DIOXIDE (SO <sub>2</sub> )	<b>Std. Range</b>	0 - 20 ppm	0.1 ppm	+/- 0.5 ppm of rdg
SULFUR DIOXIDE (SO <sub>2</sub> )	High Range	0 - 2000 ppm	1 ppm	<100ppm, 5ppm To 2000ppm, 4%
HYDROGEN SULPHIDE (H <sub>2</sub> S)	<b>Std. Range</b>	0 - 100 ppm	1 ppm	+/- 4 % of rdg, +/- 0.5 ppm
OZONE (O <sub>3</sub> )	<b>Std. Range</b>	0 - 5 ppm	1 ppb	
FORMALDEHYDE (CH <sub>2</sub> O)	<b>Std. Range</b>	0 - 10 ppm	1 ppb	2% ± 30 ppb

*\*Note: All Accuracies indicated above are under Laboratory Conditions*

### 2. AIR QUALITY SENSORS – NON-DISPERSIVE INFRARED (NDIR) SENSORS

SENSOR		RANGE	RESOLUTION	ACCURACY
CARBON DIOXIDE (CO <sub>2</sub> )	<b>Std Range</b>	0 – 5000 ppm	10 ppm	2% of Rdg. ± 10 ppm
CARBON DIOXIDE (CO <sub>2</sub> )	High Range	0.0% - 20.0%	0.1%	± 3% rdg.

### 3. AIR QUALITY SENSORS – PHOTO IONIZATION DETECTOR (PID) SENSORS

<b>SENSOR</b>		<b>RANGE</b>	<b>RESOLUTION</b>	<b>Min Detection</b>	<b>ACCURACY</b>
VOCs	<b>Std Range</b>	0 – 20 ppm (0-46 mg/m <sup>3</sup> )	1 ppb (2.3 µg/m <sup>3</sup> )	5 ppb	10% of Rdg. ± 20 ppb
VOCs	High Range	0 – 200 ppm	1 ppb	25 ppm	10% of Rdg. ± 50 ppb

### 4. OTHER SENSORS

<b>SENSOR</b>	<b>RANGE</b>	<b>RESOLUTION</b>	<b>ACCURACY</b>
Temperature Type K (T1)	0 – 2000 °F (0 – 1100°C)	0.1 °F (0.1 °C)	+/- 0.5 °C 0-100°C +/- 5% >100°C
Ambient Temperature	-40 – 257 °F (-40 – 125 °C)	0.1 °F (0.1 °C)	+/- 0.4 °C (0-60 C)
Barometric Pressure	260 – 1260 mbar	1 mbar	+/- 2 mbar
Relative Humidity	0 -100 %	0.1%	+/- 2% RH
Pressure	+/- 80 mbar	0.1 mbar	+/- 2 mbar
Air Velocity	0 – 300 ft/sec	1 ft/sec	

## MODEL AQ EXPERT – SAFETY GUIDELINES

This section provides general rules which must be followed for product safety, avoiding personal injury, damage to equipment and preserving the manufacturer's warranty. Please take care to carefully observe the following instructions.

### A. PRODUCT SAFETY INSTRUCTIONS:

**NOTE: Please take special care when performing Span Calibration of the monitor. You cannot revert back to the factory setting after any adjustments!**

**NOTE: CO<sub>2</sub> should ALWAYS be Calibrated or Zeroed with a Cylinder of ZERO AIR. Do Not Use Ambient Air for CO<sub>2</sub> sensor calibration.**

- Follow the instructions in the AQ Expert Manual
- Do not operate the instrument outside of the parameters specified in the technical specifications
- Never use the instrument without the disposable fiber soot line filter or the condensation disk filter, which are located inside the monitor connected to the "Sample In" input. Operating the instrument without the filters will put the monitor at high risk to damage the pump and sensors. These filters should be replaced as needed. See maintenance chapter for filter changing.
- It is recommended to keep the AQ Expert horizontal using the included swivel handle as its stand with the LCD display facing the user
- Do not use or store the instrument together with any solvents
- Do not block the exhaust port in the back of the instrument
- Do not expose the monitor to extreme hot or cold temperatures outside of the stated range in this manual
- Do not abuse the charger cord. Do not use power cord for carrying, pulling. Keep cord away from heat, oil, sharp edges, or moving parts. Damaged or entangled cords can increase risk of electric shock
- Only use the supplied, appropriate AC Charger
- If the monitor enclosure is ever unscrewed and taken apart, avoid over-tightening the screws that hold the two main enclosure pieces together.
- Do not store or operate in dusty, dirty areas
- Always use the monitor with care and use the instrument properly
- Do not use force when disconnecting and reconnecting the Black external Temp, RH and Pressure Sensor (see photo below)
- Do not use instrument in the rain or high moisture areas to prevent water droplets on the black external Temp, RH, and Pressure Sensor.
- Remember to have the monitor checked and calibrated at least once a year to ensure sensor accuracy and compliance with existing standards

- **DO NOT LIFT OR HANDLE THE INSTRUMENT BY THE BLACK EXTERNAL TEMP, RH, PRESSURE SENSOR HOUSING! See photo below**

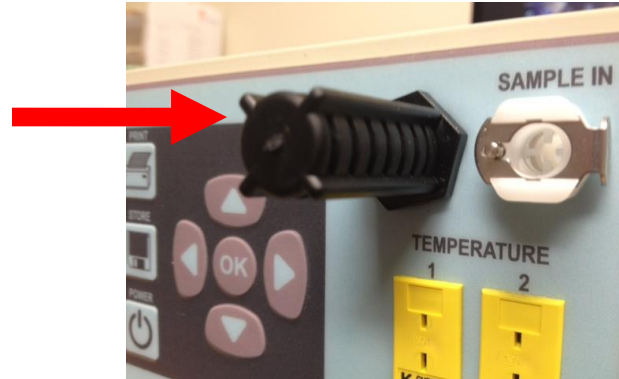

## B. ELECTROMAGNETIC COMPATIBILITY

Complies with EN61326-1, Portable Equipment

The E Instruments AQ EXPERT Indoor Air Quality Monitor is a battery operated Portable device designed to be used by a qualified engineer/technician to make measurements in buildings and residential facilities. For long-term testing, you may operate the unit connected to the supplied charger by carefully following the product safety instructions in Section A above.

## C. ESD Protection

In extreme cases or abnormal applications, Electrostatic Discharge can potentially cause serious and immediate damage to the electronic circuits of the instrument.

## D. BATTERY DISPOSAL & RECYCLING



Recycle all applicable material properly. Take faulty/depleted batteries to proper collection/recycling centers



Dispose of batteries and the monitor according to statutory regulations. Do not dispose of with regular household items. After the monitor's useful life, please return to your local authorized E Instruments' distributor or send back to E Instruments directly. We will ensure that it is disposed of in an environmentally friendly manner

## CHAPTER 2

### INTRODUCTION

#### A. UNPACKING THE INSTRUMENT

Every E INSTRUMENTS AQ EXPERT includes as standard equipment:

- IAQ Monitor Model AQ Expert with CO<sub>2</sub>, Temp, %RH, DPt, WBT, BP, Velocity, Differential Pressure and Differential Temperature
- Internal Continuous Sampling Pump
- Swivel Handle
- Battery charger / AC adaptor for the monitor
- USB Thumb Drive includes:
  - AQ GAS™ Software for Windows™
  - Instruction Manual
- USB Cable for Software Kit
- Internal Wireless Bluetooth
- Bluetooth Dongle for PC
- Calibration Certificate

The instrument can have up to six (6) electrochemical gas sensors, one (1) infrared gas sensors and one (1) PID sensor installed. The AQ Expert has three temperature sensors in total. All sensor readings are single range readings with ranges listed in Chapter 1.





## B. INSTALLING/REMOVAL OF SWIVEL HANDLE INSTRUCTIONS

1. Depress BOTH of the Grey Push-Release buttons on the Left & Right circular ends of the handle (Photo B)
2. With the handle angled *AWAY* from the front face of the instrument and with the buttons depressed, position the circular ends *OVER* the Gray circular holders ON the side of the instrument until it falls into place (Photos C & D)
3. Depress the Grey Push-Release buttons and rotate the Handle down below the Front Face (Photo E) of the instrument until it locks into place under the instrument holding it upright in place. (Photo F)
4. To Remove the handle, repeat steps 1-3 in reverse

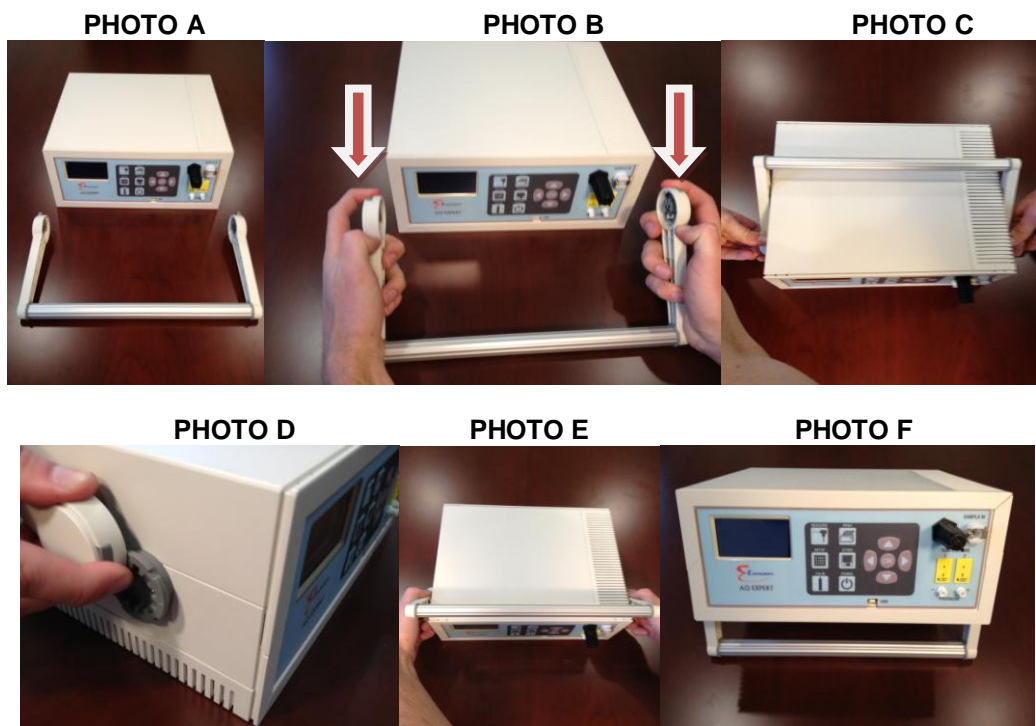

## C. REPACKING UNIT IN OPTIONAL VINYL CARRYING CASE

1. With the AQ Expert powered OFF, turn the instrument on its side with the FRONT FACE of the unit to the LEFT. See photo A below.
2. Place the carrying case on a supported surface (desk, floor, etc) with the Front Logo facing the user.
3. With the AQ Expert powered OFF, turn the instrument on its side with the FRONT FACE of the unit to the LEFT. See photo A below.
4. Carefully place the AQ Expert in the Case, taking SPECIAL PRECAUTION to NOT damage the External Temp, RH, Pressure sensor. See Photo B below

PHOTO A



PHOTO B



**INSTRUCTIONS: DO NOT LIFT OR HANDLE THE INSTRUMENT BY THE BLACK EXTERNAL TEMP, RH, PRESSURE SENSOR HOUSING!**

#### D. AQ EXPERT STARTING INSTRUCTIONS

1. Make sure the instrument is in a clean-air, room-temperature environment and turn it on by pressing the **POWER** key on the keypad. The instrument will begin to draw in air from the SAMPLE IN inlet at a rate of about 500 cc/minute.
2. If needed or in doubt of the contaminants in the Ambient Air, you can initiate the ZERO CAL on ALL of the GAS sensors on the AQ Expert. Please refer to CHAPTER 8 of this manual for ZERO & SPAN calibration on the AQ Expert.
3. Press the **MEASURE** key to view the ambient temperature, barometric pressure, relative humidity and dew point. The toxic gas readings are also displayed: CO, CO<sub>2</sub>, NO, NO<sub>2</sub>, SO<sub>2</sub>, H<sub>2</sub>S, O<sub>3</sub>, & VOCs.
4. If, at the end of the ZERO countdown, if the display shows an error message for a particular sensor, see the troubleshooting table in section D of this chapter. The instrument will measure correctly all sensors that do not show an error message.

## LIST OF ABBREVIATIONS

### PARAMETERS

<b>CO<sub>2</sub></b>	Carbon Dioxide – NDIR measurement
<b>CO</b>	Carbon Monoxide
<b>Ta</b>	Ambient (room) Air Temperature
<b>RH</b>	Percentage of Relative Humidity
<b>DPt</b>	Dew Point Temperature
<b>WBT</b>	Wet Bulb Temperature
<b>BP</b>	Barometric Pressure
<b>O<sub>2</sub></b>	Oxygen
<b>O<sub>3</sub></b>	Ozone
<b>VOCs</b>	Volatile Organic Compounds
<b>FMH</b>	Formaldehyde
<b>H<sub>2</sub>S</b>	Hydrogen Sulfide
<b>NO</b>	Nitric Oxide
<b>NO<sub>2</sub></b>	Nitrogen Dioxide
<b>NO<sub>x</sub></b>	Oxides of Nitrogen
<b>SO<sub>2</sub></b>	Sulfur Dioxide
<b>VEL</b>	Air / Gas Velocity (measurement with pitot tube)
<b>ΔP</b>	Differential Pressure (with Velocity Probe turned OFF)
<b>T1</b>	Thermocouple Type K Temperature (T1 Input)
<b>T2</b>	Thermocouple Type K Temperature (T2 Input)
<b>BAT</b>	Battery Life / Voltage
<b>NA</b>	Parameter Not Available

### UNITS

<b>PPM</b>	Parts (of pollutant) per million
<b>PPB</b>	Parts (of pollutant) per billion
<b>mg/m<sup>3</sup></b>	Milligrams per Cubic meter
<b>µg/m<sup>3</sup></b>	Micrograms per Cubic meter
<b>°F</b>	Temperature Measurement in Fahrenheit
<b>°C</b>	Temperature Measurement in Celsius
<b>"WC</b>	Inches of water (pressure measurement)
<b>mmHg</b>	Millimeters of Mercury (pressure measurement)
<b>"Hg</b>	Inches of Mercury (pressure measurement)
<b>PSI</b>	Pounds per Square Inch (pressure measurement)
<b>mmWC</b>	Millimeters of water (pressure measurement)
<b>kPa</b>	KiloPascals (pressure measurement)
<b>mbar</b>	Millibars (pressure measurement)
<b>FPS</b>	Feet per second (gas / air velocity measurement)
<b>MPS</b>	Meters per second (gas / air velocity measurement)
<b>CMM</b>	Cubic meters per minute (gas / air velocity measurement)
<b>CFM</b>	Cubic feet per minute (gas / air velocity measurement)
<b>V</b>	Voltage (battery)

---

## CHAPTER 3

---

### BASIC INSTRUMENT OPERATION

The AQ EXPERT is operated by the 11 button keyboard located on the front of the monitor.

- The **POWER** key turns the instrument on and off.
- The **MEASURE** key shows the currently measured parameters.

Displays the monitor's currently measured data in either of two (2) fonts:

- A. Small fonts (all data displayed simultaneously plus range indicated, battery condition and time)
- B. Large fonts (four data parameters displayed simultaneously)

**Note:** The AQ Expert allows the user to **ZOOM** in and out of the screen by changing from Small to Large Fonts using the **MEASURE** key.

- Four keys will bring up a menu: **SETUP**, **CALIB**, **STORE**, & **PRINT**.
  - SETUP** Controls all customization parameters, such as measurement units, for the monitor
  - CALIB** Controls calibration settings and zeroing of the monitor's sensors.
  - STORE** Controls operation of the monitor's internal data storage
  - PRINT** Executes print commands for the monitor's optional remote Bluetooth printer
- The menus are navigated with the **UP**, **DOWN**, **LEFT**, **RIGHT**, & **OK** keys.



## INSTRUMENT OPERATION OVERVIEW

1. Turn the AQ Expert on by pressing the **POWER** key. The instrument's internal pump will immediately turn on and the E INSTRUMENTS logo will appear.
2. If applicable, attach the optional probe and sampling line to the monitor.
3. Press the **MEASURE** key and check the unit's battery condition.





CO <sub>2</sub> : 520 <sub>PPM</sub>	O <sub>2</sub> : 20.9%
CO: 0 <sub>PPM</sub>	NO <sub>2</sub> : 0 <sub>PPM</sub>
Ta: 79.1°F	SO <sub>2</sub> : 0 <sub>PPM</sub>
RH: 46.9%	H <sub>2</sub> S: 0 <sub>PPM</sub>
D <sub>Pt</sub> : 57.0°F	O <sub>3</sub> : 0 <sub>PPB</sub>
BP: 1012mb	VOC: 0 <sub>PPB</sub>
Sampling  12:45:00	

*NOTE: Depending on the options enabled for your AQ EXPERT some of the entries in one or more of the displays shown above will be blank if that option is not available.*

The **MEASURE** key allows the user to toggle between a small font and a large font screen. Select the small font screen.

The battery icon is displayed in the middle of the bottom line of the display. Its condition is marked by the shaded fraction of the icon. If the unit is powered by the battery charger a small “plug” icon will replace the battery icon.

**NOTE:** When connecting the battery charger to the monitor make sure that the “plug” icon appears on the **MEASURE** screen. This ensures a proper power connection and charging of the batteries.

-  Battery Full
-  Battery Empty
-  Battery Charger Connected
-  Fast-Charge Mode

APR 1 '14	12:45:00
Temperature Units:	F
Measure Units:	PPM
Pressure Units:	inWC
Pumps:	AUTO 1000cc/m
Velocity Probe:	OFF
Velocity Units:	FPS
Duct Size:	0 in2
Display Contrast:	24
Baudrate:	115 kbps
Version:	1.00Li

4. If you are using the monitor for the first time, press the **SETUP** key to set the appropriate parameters (i.e.: measurement units) for your application. See Chapter 5 for an explanation of each parameter.
5. All sensor readings shown on the screen indicate Ambient measurements. To ZERO the gas sensors, please see Maintenance Chapter 11 of this manual.
6. To obtain a printout of the data displayed, press the **PRINT** key. The cursor (reverse color) will point to:

Print Test Record

Press the **OK** key to execute a printout on the AQ Expert's optional remote printer.

7. Measured data can be stored in the monitor's internal memory. Please refer to Chapter 7 for more details about data storage.
8. When you are finished with your measurements allow the monitor to draw clean ambient air for several minutes before turning the monitor off. If you are using the optional probe, please disconnect and let the instrument run in clean ambient air before turning the instrument off.

---

## CHAPTER 4

---

### POWER REQUIREMENTS

The AQ Expert can run off of AC power or the internal Li-Ion rechargeable battery pack. It is recommended to run the AQ Expert off AC power as often as possible for maximum operating time.

Power is supplied by a Li-Ion rechargeable battery pack. The battery pack will supply power to the monitor for approximately 6-8 hours of continuous operation.

A 110 – 240 Volt AC charger having a 12 Volt DC / 2.5A output is supplied with the instrument. The battery charger will fully charge the battery pack in three hours.

You can check the condition of the batteries at any time:

1. By pressing the **MEASURE** key, (small font screen) and observing the battery icon, located at the bottom of the display.



Battery Full



Battery Empty



Battery Charger Connected



Fast-Charge Mode

2. By pressing the **MEASURE** key, (large font screen), the user can scroll all the way to the end using the **DOWN** arrow key to observe the battery life shown in voltage. When the unit is operating on its internal batteries, the voltage displayed will vary from an initial 8.0 to 8.4 volts (fully charged) dropping slowly to approximately 7 volts (batteries nearly empty). When the battery voltage drops to 7.1 volts a “low battery” warning will appear on the display. Within a few minutes later the instrument will automatically turn off, to preserve the remaining battery power for the sensor bias voltages.

## CHAPTER 5

### SENSORS - TECHNICAL

The great versatility of the AQ Expert Air Quality monitor is partly due to the large number of sensors available within a single monitor.

These sensors are primarily gas sensors and can be grouped into four categories based on their principle of operation:

1. Six (6) electrochemical gas sensors\*
2. One (1) NDIR (infrared gas sensors) – CO<sub>2</sub>
3. One (1) Photo ionization detector (PID gas sensor) - VOC
4. Non-gas sensors (Temperature, Velocity, Humidity, Pressure, and Barometric pressure) sensors

**\*NOTE:** When O<sub>3</sub> (Ozone) sensor is installed the AQ Expert can include O<sub>3</sub> + NO<sub>2</sub> **OR** O<sub>3</sub> + SO<sub>2</sub>. The unit can **NOT** have all three (3) sensors (O<sub>3</sub> + NO<sub>2</sub> + SO<sub>2</sub>) together simulatenously.

The main section of the monitor that houses all the electrochemical, NDIR, and PID gas sensors, battery pack, and PC board. On the face of the unit, the external sampling system or Ambient Temperature, Relative Humidity, and Barometric Pressure.

The figure below shows the location of the gas sensors on their housing:

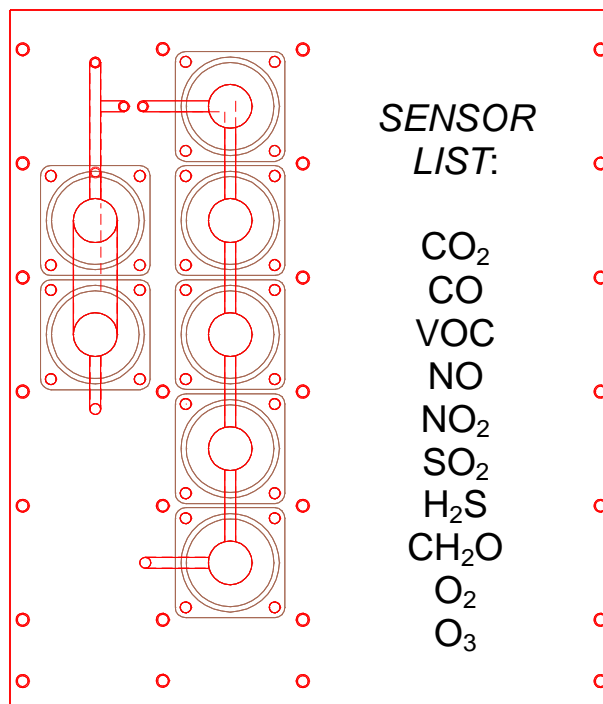



## 1. ELECTROCHEMICAL SENSORS

All electrochemical sensors are mounted on bayonet style fittings for easy removal.

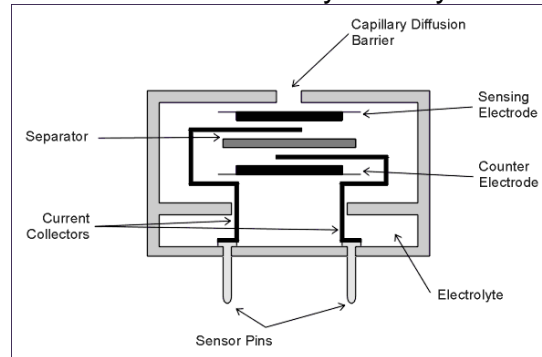

The electrochemical sensors are described below:

### A. Nitrogen Dioxide sensor (NO<sub>2</sub>)

This is a three electrode sensor that responds to nitrogen dioxide gas. Nitrogen dioxide is a “sticky” gas and this sensor’s response is usually the slowest of all sensors.

### B. Sulfur Dioxide sensor (SO<sub>2</sub>)

It is a three electrode sensor that responds to sulfur dioxide gas. It is equipped with an inboard filter to remove interference from H<sub>2</sub>S gas and other acidic gases.

### C. Nitric Oxide sensor (NO sensor)

This is also a three electrode sensor that responds to nitric oxide. It is equipped with an inboard filter to remove any interference from other acidic gases.

The nitric oxide sensor requires a constant bias-voltage for proper operation. This is supplied by the monitor’s battery. If the battery voltage drops below a certain value the monitor will turn off automatically to maintain the sensor bias. If, however, the battery voltage further drops to near zero, one must wait 24 hours after connecting the battery charger, for the sensor bias to recover.

### D. Oxygen sensor (O<sub>2</sub> sensor)

This sensor measures the oxygen concentration in the sample. It is a two-electrode electrochemical cell. It has a silver cathode and a lead anode. Oxygen diffuses through a tiny hole and reacts with the lead anode. The reaction produces an electric current. The unit software linearizes the current vs. oxygen response. The cell becomes exhausted when all the lead is consumed.

### E. Hydrogen Sulfide sensor. (H<sub>2</sub>S)

This is a 4-series three-electrode micro sensor with low methanol interference. It measures the concentration of hydrogen sulfide, which is a highly toxic gas. Special precautions must be taken during calibration.

### F. Carbon Monoxide sensor (CO)

This is also a three electrode sensor that responds to carbon monoxide. It is equipped with an inboard filter to remove any interference from other acidic gases.

The optional High Range CO sensor has four electrodes. One measures the concentration of carbon monoxide gas and the other the concentration of any interfering hydrogen gas (It is hydrogen compensated).

### G. Ozone sensor (O<sub>3</sub>)

This is also a three electrode sensor that responds to ozone.

### H. Formaldehyde Sensor (CH<sub>2</sub>O)

This is also a three electrode sensor that responds to formaldehyde. It is equipped with an inboard filter to remove any interference from other acidic gases.

## 2. NDIR (INFRARED) SENSOR (CO<sub>2</sub>)

A non-dispersive infrared (or NDIR) sensor is a simple spectroscopic device most commonly used to measure CO<sub>2</sub> in indoor air quality applications. The main components are an infrared source (lamp), a sample chamber or light tube, a wavelength sample chamber, and the CO<sub>2</sub> gas concentration is measured electro-optically by its absorption of a specific wavelength in the infrared (IR).

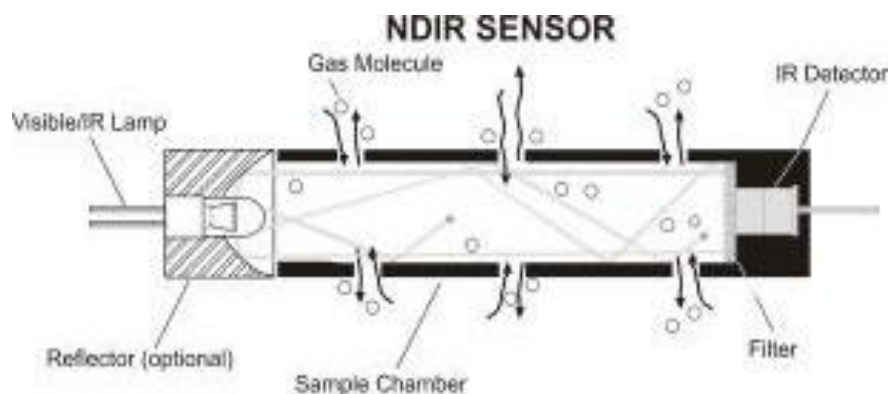

The AQ Expert Air Quality Monitor is equipped with one standard NDIR infrared sensor capable of CO<sub>2</sub> measurement (standard range: 0 – 5000 ppm). This infrared sensor can be substituted for higher CO<sub>2</sub> ranges upon special request.

The NDIR options have the following specifications:

<b>GAS</b>	<b>RANGE</b>	<b>ACCURACY</b>
CARBON DIOXIDE (CO <sub>2</sub> )	0 – 5000 ppm	2% of reading ± 10 ppm
CARBON DIOXIDE (CO <sub>2</sub> )	0.0% - 20.0%	3% of reading

### 3. PHOTO IONIZATION DETECTOR (PID) - VOCs

Photo ionization detectors are the most common method to measure volatile organic compounds (VOCs) and other gases in indoor air quality in concentrations in parts per billion (PPB) and parts per million (PPM).

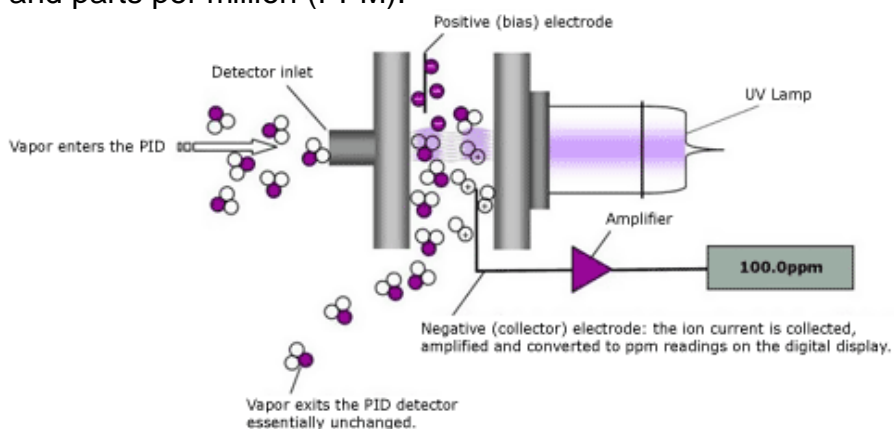

The PID options have the following specifications:

<b>GAS</b>	<b>RANGE</b>	<b>ACCURACY</b>
VOCs*	0 – 20 ppm	± 10 % of reading
VOCs*	0 – 200 ppm	± 10 % of reading

*\*VOC sensor will not measure Formaldehyde. The ionization potential of the sensor is outside of the VOC sensor range. If you need Formaldehyde, you need to use the direct CH<sub>2</sub>O sensor.*

## 4. NON-GAS SENSORS

### A. Ambient Temperature sensor

This is a solid state sensor located on the front panel of the monitor. The ambient temperature is displayed on the **MEASURE** screen in either °F or °C. The dew point is calculated from the ambient temperature and relative humidity. The dew point is displayed on the Small and Large Font **MEASURE** screens as DPt.

### B. Humidity sensor

This is a solid state sensor located on the front panel of the monitor. The relative humidity is displayed on the **MEASURE** screen in %RH (% Relative Humidity). The Wet Bulb is calculated from the ambient temperature, relative humidity, and barometric pressure. The wet bulb is displayed on the Large Font **MEASURE** screen only as WBT.

### C. Barometric Pressure sensor

This is a solid state sensor located at the front panel of the monitor. The barometric pressure is displayed on the Small and Large Font **MEASURE** screens as BP.

### D. External temperature sensor (T1 & T2)

The thermocouple is located at the tip of any optional or separate Type K thermocouple probe and/or wire. The T1 & T2 temperature measurements are displayed on the Large Font **MEASURE** screen only as T1, T2.

### E. Differential Pressure / Air Velocity sensor.

If the monitor comes with the Differential Pressure option and/or the air velocity option (optional separate S-type pitot tube and pressure tubing), the internal pressure sensor is a very low range pressure sensor. The Velocity measurements are displayed on the **MEASURE** screen only as VEL. Differential Pressure are displayed on the **MEASURE** screen only as  $\Delta P$ .

**Connecting Differential Pressure Hoses:**

1. Connect White Connector to either P+ or P- Connection as shown in photo below



2. Once connected, turn White Connector CLOCKWISE to lock. Do NOT Over tighten.

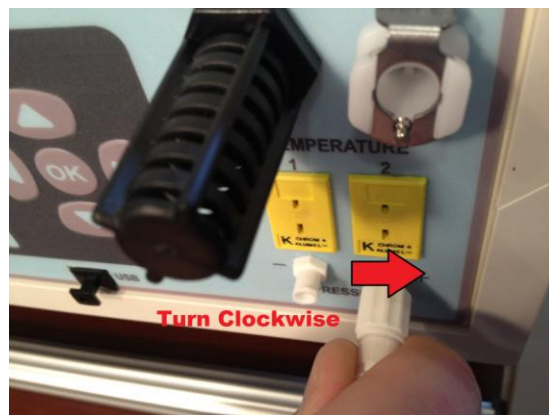

3. To Disconnect, turn White Connector COUNTER-CLOCKWISE to unlock and pull hose off to remove

---

## CHAPTER 6

---

### AQ EXPERT SETUP

The SETUP MENU allows the operator to change the instrument's parameters.

APR 1 '14 12:45:00
Temperature Units: F
Measure Units: PPM
Pressure Units: mbar
Pumps: AUTO 1000cc/m
Velocity Probe: OFF
Velocity Units: FPS
Duct Size: 0 in <sup>2</sup>
Display Contrast: 24
Baudrate: 115 kbps
Version: 1.00Li

Every parameter listed on the SETUP MENU screen can be changed as follows:

- a. Use the **UP / DOWN** keys to move the highlighted line to the parameter you wish to change.
- b. Press **OK** to edit the value. The arrow will disappear as the current line shifts to the left by one character and a cursor appears over the value. This indicates that you are in edit mode.
- c. Use the **UP / DOWN** keys (keys displaying the triangles) until the desired value of the selected parameter appears on the display.
- d. Press the **OK** key to execute the change.

A more detailed explanation of each parameter follows:

- 1) **DATE & TIME:** The monitor's internal clock is displayed in the format month-day-year, hour-minute-second. Hours are always displayed using a 24-hour clock format.
- 2) **TEMPERATURE UNITS:** The **UP / DOWN** keys toggle between °F (Fahrenheit) and °C (Celsius). Stack temperature and ambient temperature will be displayed, printed, and saved in the selected units.

- 3) GAS MEASURING UNITS: When the cursor is blinking on this line, you can select any of the following units of measurement for the toxic gas sensors:
- PPM : Parts per million (volumetric)
  - PPB : Parts per billion (volumetric)
  - MGM: Milligrams per cubic meter (weight)
  - $\mu$ GM: Micrograms per cubic meter (weight)

Note: Formaldehyde, Ozone and VOCs will always read in PPB (parts per billion)

- 4) PRESSURE UNITS: Pressure measurements can be shown in millibar (mbar), inches of water (inWC), millimeters of water (mmWC), millimeters of mercury (mmHG), inches of mercury (inHG), pounds per square inch (psi) or kilopascal (kPa).

1 mbar = 0.10 kPa = 0.40 inWC = 10.2 mmWC = 12.95 inHg = 0.75 mmHg = 1.45 PSI

- 5) VELOCITY UNITS: (Velocity Option) Select between feet per second (FPS), meters per second (MPS), cubic feet per minute (CFM), or cubic meter per minute (CMM).

**AIR VELOCITY AND DIFFERENTIAL PRESSURE CAN NOT BE MEASURED SIMULTANEOUSLY. USER MUST CHOOSE ONE OR THE OTHER.**

To change the selection, hit the **SETUP** key. Using the **DOWN** arrow key, scroll Down to **VELOCITY PROBE** and hit **OK**. The **OFF/ON** selection will be highlighted. Use the Up & Down arrow keys to change the selection from OFF to ON or vice versa. With the Velocity Probe Selection **OFF**, the AQ Expert will measure **Differential Pressure ( $\Delta P$ )** automatically. With the Velocity Probe Selection **ON**, the AQ Expert will measure **Air Velocity (VEL)** automatically. When you have your selection chosen, hit the **OK** button and the entire Velocity Probe will be highlighted again. Hit the **MEASURE** Button to get back to the Main Measurement screen once you are complete.

- 6) DUCT SIZE: (Velocity Option). Estimate the cross-section area of your Ducts in square inches ( $\text{in}^2$ ) and set this value to obtain automatic & accurate Air Flow measurements in CFM or CMM.

**NOTE: When using the Velocity Feature on the AQ Expert it is recommended to ZERO the readings BEFORE using the Pitot tube to ensure proper Velocity measurements. See Chapter 9 for instructions on Zeroing the AQ Expert. (Zero Gas Sensors)**

**Connecting Pitot Tube:** In air conditioning, heating and ventilating work, it is helpful to understand the techniques used to determine air velocity. In this field, *air velocity* (distance traveled per unit of time) is usually expressed in feet per minute (FPM). By multiplying air velocity by the cross section area of a duct, you can determine the air volume flowing past a point in the duct per unit of time. *Volume flow* is usually measured

in cubic feet per minute (CFM). To make Air Velocity measurements using the AQ Expert, you will need to use the *Optional* 12" Pitot tube. Follow Steps #5 & #6 above to (1) turn the Velocity Probe option ON (VEL will appear on the unit's main screen) and (2) set up your Duct Size. Connect the supplied hoses from the Pitot tube to the WHITE (-) and/or (+) PRESSURE connections on the Front of the AQ Expert.

- 7) PUMP: Pump status is displayed:
  - a) AUTO - Automatic sample mode is selected
  - b) OFF – The internal Pump is turned off.
- 8) DISPLAY CONTRAST: Select the best value for viewing the LCD screen.
- 9) BAUDRATE: The communication speed for both the USB port and the Bluetooth connection is set here. The default setting is 115 kbps.



---

## CHAPTER 7

---

### INTERNAL DATA STORAGE

The STORE MENU allows the operator to store data and manage the internal storage tags.

Store Current Buffer
Select Buffer
Start Average Test
Start Periodic Store
Select Interval: 1m
Review Buffer
Name Buffers
Erase Buffers
00: TAG#00

The AQ Expert has 1000 internal storage tags. Each tag stores one complete set of air quality data. There are two ways to store air quality data to the monitor's buffer. You can either store data by selecting the option STORE CURRENT DATA after pressing the **STORE** key, or alternatively you can make use of the monitor's capability of storing data automatically on a periodic basis. You can set the time period between data storage. The STORAGE MENU shows the relevant display lines for the storage options.

1. **STORE CURRENT BUFFER:** The monitor will store one set of data into the tag currently selected. The index number and the name of this tag appear at the bottom of the screen.
2. **SELECT BUFFER:** Selecting this item will display an index of the monitor's 1000 internal storage tags. Tags that are used have an icon next to their index number. The selected storage tag is indicated by the reverse color line. When data is stored, this pointer will automatically advance to the next available tag. If you want to store data in a different location, use the UP, DOWN, & OK keys to select a new tag. As you scroll up and down, tags containing data show their date and time at the bottom of the display. Empty tags show the word *empty*.
3. **START AVERAGE TEST:** This will begin a period of data averaging, with the average values stored periodically in successive memory tags. The interval between each storage cycle is displayed below and can be set by the user. Once enabled, this line will read: STOP AVERAGE TEST.
4. **START PERIODIC:** This will turn on the periodic store function. In this mode, the unit will continuously store data at an interval displayed on the next line. Once enabled, this line will read: STOP PERIODIC.

5. **SELECT INTERVAL:** The time between each store is set here. This can range from 10 seconds to 60 minutes.
6. **REVIEW BUFFER:** This choice allows you to view previously saved data. Press **OK**. The display will switch to the data screen, with the data in the first tag displayed. The time and date when the data was saved will appear at the bottom of the display. Use the **UP / DOWN** keys to scroll through the tags.
7. **NAME BUFFERS:** This choice will take you to another screen where you can rename one or more tags. This is useful if you use several tags together to form a test series. Select the starting test index with the **UP / DOWN / LEFT / RIGHT** keys and press **OK**. Next, select the ending test index. The cursor will move to the first character of the first tag's name, and the alphanumeric keyboard will appear. Use the **UP / DOWN / LEFT / RIGHT** keys to navigate around the keyboard, and press **OK** to select the letter or number. For lower-case letters, highlight `shift` and press **OK**, for symbols, highlight `sym` and press **OK**. The arrows in the corner will move the cursor forward or backward through the tag's name.

*** NAME BUFFERS ***										
Starting Tag: 00										
Ending Tag: 00										
Name:xxxxxxxxxxxxxxxxxx										
1	2	3	4	5	6	7	8	9	0	◀
A	B	C	D	E	F	G	H	sym	▶	
I	J	K	L	M	N	O	P	shift		
Q	R	S	T	U	V	W	X	Y	Z	
8. **ERASE BUFFER:** This option is used to erase stored data. Data that has been stored in the monitor's memory will be retained even after the instrument has been shut off and its batteries removed. To erase the contents of a specific tag, use the **UP / DOWN** keys to move the arrow to the desired tag. As you scroll up and down, tags containing data show their date and time at the bottom of the display. Empty tags show the word `empty`. If you wish to erase all 1000 of the monitor's stored data, move the arrow to the entry `ALL TAGS` and press **OK**.

## CHAPTER 8

### WIRELESS REMOTE PRINTER

The AQ Expert uses a wireless Bluetooth remote printer. The printer is powered by a rechargeable battery. An AC charger is supplied with the printer. The printer is optional with the AQ Expert.



First you must turn the printer on. Then press **PRINT** to scan and connect with your wireless printer to establish communications between the monitor and the printer.

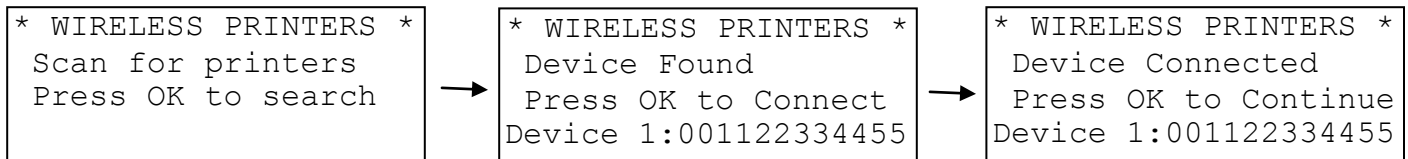

When you have connected successfully the printer's green status light will turn on. Pressing the **PRINT** key will now display the PRINT MENU.

The PRINT MENU allows the user to print test records.

```

Print Test Record
Start Test Log
  Log Interval: 60s
Print Buffer
Configure Record
Edit Customer Name
Calibration Record
Paper Feed On/Off
Mobile Printer...
    
```

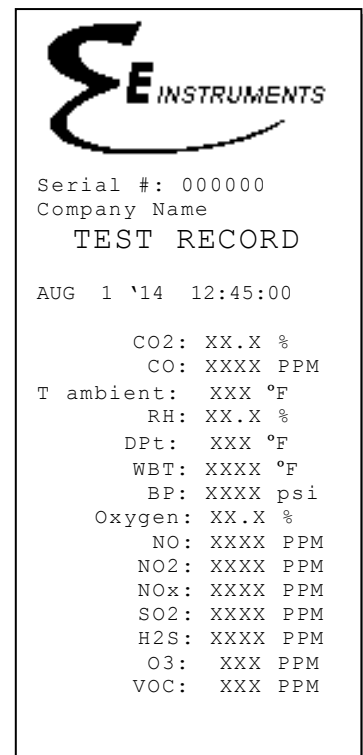

**PRINT TEST RECORD:** This option will print a test record of the current air quality parameters.

**PRINT TEST LOG:** This option begins a log of the following air quality parameters: CO<sub>2</sub>, Temperature, %RH, Wet Bulb, Dew Point, Barometric Pressure, Oxygen, Carbon Monoxide, VOCs, etc.

**LOG INTERVAL:** This selects the interval between each log

entry. The interval can be set between 1 and 60 seconds.

**PRINT BUFFER:** This option is used to print data stored in the monitor's memory. Each line corresponds to one storage tag. Tags containing data show an icon next to the index number. When you scroll up and down, the date (mm/dd) and time (hh/mm) when the data was stored appear at the bottom; empty tags show the word "empty". To print the contents of a specific tag, use the **UP / DOWN** keys to move the arrow to the desired tag and press **OK**. If you wish to print the entire monitor's stored data in sequence, move the arrow to the entry `ALL TAGS` and press **OK**.

**CONFIGURE RECORD:** This option allows the user to add, delete, or change the order of the parameters that appear on the paper print out.

**EDIT CUSTOMER NAME:** This will display a screen where you can change the information printed at the top of each printout. Usually the customer's name or the operator's name appears here. To edit this information, use the **UP / DOWN / LEFT / RIGHT** keys to navigate around the keyboard, and press **OK** to select the letter or number. For lower-case letters, highlight `shift` and press **OK**, for symbols, highlight `sym` and press **OK**. The arrows in the corner will move the cursor forward or backward through the name.

** EDIT HEADER INFO *										
E INSTRUMENT AQ EXPERT										
1	2	3	4	5	6	7	8	9	0	◀
A	B	C	D	E	F	G	H	sym	▶	
I	J	K	L	M	N	O	P	shift		
Q	R	S	T	U	V	W	X	Y	Z	

**CALIBRATION RECORD:** This option will print a record of each sensor's last calibration, including the date of calibration and span gas value used.

**PAPER FEED:** This toggles the printer's motor on and off, advancing the paper out the top of the printer as needed. The motor will not turn on if there is no paper present.

**MOBILE PRINTER:** The `WIRELESS PRINTERS` screen will appear. You can disconnect your current Bluetooth connection and connect to another printer in range.

---

## CHAPTER 9

---

### ZERO & SPAN CALIBRATION

**NOTE: CO<sub>2</sub> should ALWAYS be Span Calibrated or Zeroed with a Cylinder of ZERO AIR. Do Not Use Ambient Air for CO<sub>2</sub> sensor calibration.**

Every instrument must occasionally be tested against some known value or standard in order to make sure that its accuracy has not deteriorated. If the instrument is reading outside of the stated accuracies in this manual, the unit should be calibrated by following the procedures described in this chapter.

This chapter will contain all of the information on calibrating and adjusting the AQ Expert IAQ Monitor. The term Span Calibration means comparing the AQ Expert's readings to a standard concentration (i.e.: calibrated gas bottles) and adjusting/changing the AQ Expert's individual sensor's readings to match the standard concentration for the most accurate measurements. The term ZERO calibration refers to the user's ability to calibrate each sensor with zero concentration of the targeted gas. See Chapter 11, Maintenance, for recommended frequencies of each procedure.

If the unit is returned to E Instruments for Span Calibration, the unit will be shipped back after Calibration with a new Calibration Certificate valid for one (1) year. If the unit is Span Calibrated in the field, the original calibration certificate is no longer valid.

**NOTE: Please take special care when performing Calibration of the monitor. You cannot revert back to the factory setting after any adjustments!**

```
**** CALIBRATION ****
Zero Gas Sensors
Zero CO2 Sensor
Zero Thermocouples
Zero Errors
Zero Time: 60sec
Span Time: 120sec
** Span Lockout **
Sensor History
Span CO: xxxx PPM
Span H2: xxxx PPM
Span CO2: xxxx PPM
Span NO: xxxx PPM
Span NO2: xxxx PPM
Span SO2: xxxx PPM
Span H2S: xxxx PPM
Span FMH: xxxx PPB
Span Ozone: xxxx PPB
Span VOC: xxxx PPB
Span Velocity: xx "
Span ΔP: xx "
Span AmbT: xx.x C
Span BP: xxxx mbar
Span RH: xx.x %
Cal Thermcple1: xxxF
Cal Thermcple2: xxxF
```

The CALIBRATION MENU lets you set span calibration values for each sensor and performs all sensor calibrations. The CALIBRATION MENU is shown below

A brief explanation of the parameters shown follows below:

**ZERO GAS SENSORS:** This will set the zero point of CO, NO, NO<sub>2</sub>, SO<sub>2</sub>, H<sub>2</sub>S, CH<sub>2</sub>O, O<sub>2</sub>, VOCs, Pressure & Velocity values.

**ZERO CO<sub>2</sub> SENSOR:** This will set the zero point of CO<sub>2</sub>.

**ZERO THERMOCOUPLE:** This calibrates the external thermocouple input (T1) to ambient temperature.

**ZERO ERRORS:** This will display a list of sensors that were out of the monitor's acceptable range during the last zero countdown.

**ZERO TIME:** This is the countdown time for the zero procedure. The zero cycle time should set at 20-60 seconds.

**SPAN TIME:** When carrying out a span calibration, you must introduce the span gas for an appropriate amount of time before the monitor executes the span calibration. This setting, which is the same for all sensors, controls this time interval. The span time is indicated in seconds.

**SPAN LOCKOUT:** This controls access to the remaining span calibration menu options. Span lockout prevents accidental or mistaken calibrations. Span lockout is enabled and disabled by entering a 4-digit code.

**SENSOR HISTORY:** The date that each sensor was installed is displayed, along with the date the sensor was last calibrated and the span gas concentration used.

**SPAN XXXX:** The remaining lines of the CALIBRATION MENU are used for carrying out span calibrations of the CO, CO<sub>2</sub>, NO, NO<sub>2</sub>, SO<sub>2</sub>, H<sub>2</sub>S, Ozone, Formaldehyde, VOCs, and Velocity sensors. For detailed use of these settings, please refer below.

## A. ZEROING THE AQ EXPERT

Select **CALIB** key to go into Calibration Mode

There are two (2) methods to Field-Calibrate the GAS & CO<sub>2</sub> Sensors on the AQ Expert.

- (i) ZERO Gas Sensors using the ZERO AIR Cylinder (to zero all gas sensors)
- (ii) Using Outside fresh Air to Calibrate the gas sensors (except the CO<sub>2</sub> sensor)

### 1. ZEROing ALL GAS Sensors using a certified Cylinder of ZERO AIR

If you have a gas cylinder/bottle of ZERO AIR you can use this for Zeroing ALL of the gas sensors in the AQ Expert. If you do not have this cylinder, please contact E Instruments to purchase our optional Calibration Kit consisting of ZERO AIR & regulator for proper calibration of the AQ Expert (part #: AQCAL).

**ZERO GAS SENSORS:** This will set the zero point of CO, NO, CH<sub>2</sub>O, NO<sub>2</sub>, SO<sub>2</sub>, H<sub>2</sub>S, O<sub>2</sub>, and VOCs values. Connect Cylinder to the "A" inlet connection on the bottom of the AQ Expert using the optional accessories included in the CALIBRATION KIT (Part #: AQCAL). See CALIBRATION APPARATUS section below for how to connect.

Have the cursor (reverse color) point to the line:

Zero Gas Sensors

Press the **OK** key to execute a zero cycle of all the gas sensors. This procedure should last 60 seconds.

At the end of the zero period, the AQ Expert reads the output of all gas sensors (with the exception of the CO<sub>2</sub> sensor) and sets them all to zero, and the Oxygen (O<sub>2</sub>) that it sets to 20.9%.

If no error messages appear at the end of the countdown, proceed with your measurements.

**ZERO CO<sub>2</sub>:** This will set the zero point of CO<sub>2</sub>. **You must use cylinder of ZERO AIR for CO<sub>2</sub> ZERO CALIBRATION.** Connect Cylinder to the "A" inlet connection on the bottom of the AQ Expert using the optional accessories included in the CALIBRATION KIT (Part #: AQCAL). See CALIBRATION APPARATUS section below for how to connect.

Scroll down using down arrow key and have the cursor (reverse color) point to the line

Zero CO<sub>2</sub> Sensors

Press the **OK** key to execute a zero cycle of the CO<sub>2</sub> Sensor. This procedure should last 60 seconds.

If no error messages appear at the end of the countdown, proceed with your measurements.

## **2. ZEROing Sensors using OUTDOOR FRESH AIR (with the exception of CO<sub>2</sub>)**

If you are *not* using bottled ZERO AIR, it is important to select a location where the ambient environment of the monitor is clean from traces of carbon monoxide or other toxic gases. The user should be at least 20-30 feet (6-10 meters) away from any buildings, parking lots, highways, and any other possible exhaust sources. If in doubt of the ambient air, please use the ZERO AIR cylinder.

When you turn the instrument on in clean ambient air, wait at least one (1) minute to allow the monitor to warm up before carrying out the zero calibration.

**ZERO GAS SENSORS:** This will set the zero point of CO, NO, CH<sub>2</sub>O, NO<sub>2</sub>, SO<sub>2</sub>, O<sub>2</sub>, H<sub>2</sub>S, and VOCs values based on the clean ambient conditions.

Have the cursor (reverse color) point to the line:

Zero Gas Sensors

Press the **OK** key to execute a zero cycle of all the gas sensors. This procedure should last 60 seconds.

At the end of the zero period the AQ Expert reads the output of all gas sensors (with the exception of the CO<sub>2</sub> sensor) and sets them all to zero, with the exception of the Oxygen (O<sub>2</sub>) that it sets to 20.9%.

If no error messages appear at the end of the countdown, proceed with your measurements.

**ZERO THERMOCOUPLE:** This calibrates the one external thermocouple input (T1) to ambient temperature.

Be sure the Thermocouples being testing are at room temperature before Calibrating

To start the zero procedure, press the **CALIB** key and select ZERO Thermocouples.

## B. SPAN CALIBRATION

E Instruments recommends performing a span calibration of the instrument once every 6 months for maximum accuracy, or at a minimum of once per year. The parameters that require a span calibration are: carbon monoxide, carbon dioxide, nitric oxide, nitrogen dioxide, sulfur dioxide, hydrogen sulfide, oxygen, formaldehyde, and VOCs. You can carry out all span calibrations in sequence.

NOTE: You must always span calibrate the instrument when a sensor is replaced.
--

### Span calibration using your own gas

If you wish to use your own span gas to perform span calibrations you must take certain precautions and follow the instructions below carefully in order to calibrate the sensors properly.

Notice that you will need a number of certified gas cylinders. Make sure that you use a bypass flow meter as shown below in the CALIBRATION APPARATUS section, in order to supply an adequate flow of span gas without developing excessive or insufficient pressure on the sensors.

Make sure the concentration of the calibration gas is within the range of each sensor.  
Do not use gas that will over-range the sensor.



The CO span gas can be in the range of 30 - 200 PPM, 2% accuracy with balanced nitrogen, preferably.

The NO span gas can be in the range of 10 - 200 PPM, 2% accuracy with balanced nitrogen, required.

The NO<sub>2</sub> span gas can be in the range of 10 - 20 PPM, 2% accuracy with balanced nitrogen or air.

The SO<sub>2</sub> span gas can be in the range of 10 - 20 PPM, 2% accuracy, with balanced nitrogen, preferably.

The VOC (Isobutylene) span gas can be in the range of 0 - 10 PPM, 2% accuracy with balanced air.

The CH<sub>2</sub>O (Formaldehyde) span gas can be in the range of 0 - 2 PPM, with balance nitrogen, preferably.

The H<sub>2</sub>S span gas can be in the range of 10 - 20 PPM, 2% accuracy, with balance nitrogen, preferably.

The CO<sub>2</sub> span gas can be in the range of 2500 PPM, 2% accuracy, with balance air

**Make sure the concentration of the calibration gas is within the range of each sensor. Do not use gas that could over-range the sensor.**

**For greatest accuracy, it is recommended that you use a span gas value close to the gas concentration you expect to measure.**

### C. CALIBRATION APPARATUS

**TO SPAN CALIBRATE THE MONITOR, IT IS BEST TO USE ONLY SINGLE GAS MIXTURES WITH EITHER NITROGEN OR AIR BALANCE.**

During calibration an adequate flow of span gas must be supplied without developing excessive pressure on the sensors. A compressed cylinder of span gas must be equipped with a primary pressure regulator. Connect the regulator of the bottled gas to the AQ Expert "Sample In". A simple way to feed the span gas to your monitor is by an open T-connection that will ensure that gas is fed at ambient pressure. The regulator valve is used to control the flow of gas to the monitor. To ensure that the span gas is fed properly and as efficiently as possible, connect a bypass flow-meter at the outlet. Adjust the regulator to maintain approximately 750 cc/min of flow at the outlet.

You must not feed gas to the AQ EXPERT under pressure and you must not starve the AQ EXPERT's pump for gas. When feeding the gas, you must maintain a reasonably constant pressure, near ambient pressure.

**Gas Calibration Fixture**

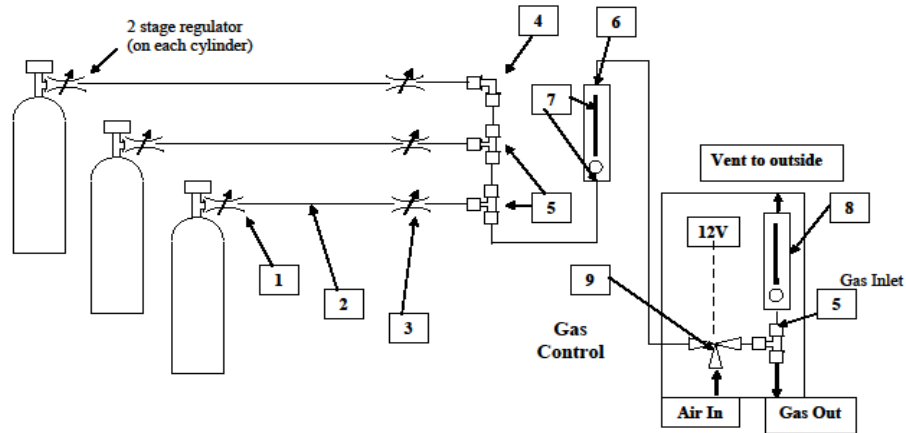

1. Fitting, adaptor, 1/4" MPT x 1/4" O.D. tube, 316 SS
2. Tubing, Parker Parflex, 1/4" O.D. x .040 wall.
3. Ball Valve, 1/2" O.D., 316 SS.
4. Elbow, 1/4" O.D., 316 SS.
5. Tee, 1/4" O.D., 316 SS.
6. Flow meter, 1-10 lpm, Dwyer #127420SV (set @ 4 lpm)
7. Fitting, Adaptor, 1/8" mpt x 1/4" O.D. tube
8. Flow meter 0-1 lpm
9. Solenoid, 3 way

**ZERO AIR Gas Bottle Calibration:**



**D. CALIBRATION PROCEDURE**

The following page illustrates the sequence of key strokes to carry out a span calibration of the AQ Expert. It is assumed that the instrument has been zeroed and there have been no error messages.

### Electrochemical Gas & PID VOC Sensors

1. Turn the AQ Expert on and press OK to perform a zero. Allow the instrument to warm up for 15 minutes, and repeat the zero.
2. Connect the outlet from the tee fitting of the gas calibration fixture to the connector on the front of the monitor labeled "SAMPLE IN" using the set up shown on the following figure:

**NOTE: Please take special care when performing Calibration of the monitor. You cannot revert back to the factory setting after making any adjustments!**

3. Turn on the gas flow and observe the gas readings on the instrument. If the gas reading for the sensor being calibrated does not increase after a few seconds, turn off the gas flow until the problem is found. Otherwise, press OK.
4. Press the key labeled "**CALIB**" to enter the calibration menu.
5. Scroll down to the **SPAN TIME** and set the value to *20 seconds*.
6. Scroll down to the sensor to be calibrated. If the calibration lock is on, enter the password **1315**.
7. Use the arrow keys to enter the span value printed on the calibration cylinder. Press OK.
8. Turn on the gas flow and observe gas readings. If the gas reading for the sensor being calibrated does not increase after a few seconds, turn off the gas flow until the problem is found. Otherwise, press OK.
9. When the countdown reaches 3 seconds, there will be a series of beeps. Verify that the reading for the sensor being calibrated matches the value entered in the calibration menu, and that the reading for all of the other sensors is zero. Turn off the gas flow.
10. Repeat this procedure for each electrochemical sensor to be calibrated.
11. After all of the sensors are calibrated, turn the unit off and back on again, and perform a zero.

### Temperature, Humidity and Barometric Pressure

Please contact E Instruments for proper Calibration Procedure

### Pressure and Air Velocity Calibration Procedure

1. Connect a pressure calibration standard to the pressure (+) connector on the front of the instrument.
2. In the SETUP menu, make sure the velocity sensor is off.
3. Press the "CALIB" key to enter the calibration menu.
4. Scroll down to SPAN  $\Delta P$  and press OK.
5. Using the calibration standard, generate a pressure value near the maximum stated value for the scale being used, for instance 80 mbar if using the mbar range.

6. Enter the value generated as the span value using the arrow keys, and press the enter key.
7. Verify that the reading on the instrument matches the reading on the calibration standard.

---

## CHAPTER 10

---

# AQ GAS SOFTWARE™

## 1. COMMUNICATIONS

The AQ Expert Monitor communicates with a PC either using the USB cable or wirelessly using its internal Bluetooth (BT) module. If your computer does not have internal BT capabilities, use the external BT module that is supplied with the AQ Expert

The communication protocol is as follows:

BAUD RATE: 115000 baud  
FORMAT: 8 bits, 1 stop bit, no parity  
HANDSHAKE: None

### USB CONNECTION

For USB connections, use the A-to-B type USB cable supplied with the instrument. To establish a USB connection, the FTDI USB driver must first be installed on your computer. The USB drivers for Windows computers are located on the E INSTRUMENTS USB Thumb Drive:

- When you plug the USB cable from the computer to the monitor, you should hear a small “da-ding” sound indicating that the USB connection has been made.
- If you have the FTDI USB driver already installed in your computer the computer will know and will NOT initialize the “New Hardware Wizard”.
- If the New Hardware Wizard appears you need to install the FTDI USB driver. To install this driver:
  1. Locate the FTDI USB driver on the CD or download it from the E INSTRUMENTS website and save it to your desktop.
  2. The downloaded file is zipped. Double-click the zipped folder and choose Extract All Files. Extract the files to a folder on the Desktop. The driver files are in the FTDI\_USB folder.
  3. Follow the instructions in the New Hardware Wizard
  4. You will have to go through the wizard **twice**, once to install the ftdiport.inf file and once for the ftdibus.inf file.

### BLUETOOTH CONNECTION

For Bluetooth connections, the connection process varies with different Bluetooth devices. Follow your manufacturer’s instructions for adding a device. The E INSTRUMENTS’ Bluetooth modem is a Class 1 device, with a maximum range of 100m. Obstacles such as walls and equipment will reduce the effective range.

The AQ Expert is supplied with a Bluetooth Dongle to make connections to PC’s without internal Bluetooth capabilities.

1. Connect the USB Bluetooth Dongle adapter to your PC, the drivers will begin to install automatically.
2. In order to establish communications between the PC and your E Instruments' monitor, navigate to the following path:  
Start → Control Panel → Hardware and Sound → Add a Bluetooth device (listed in Devices & Printers area)
3. Turn your instrument on, and it will appear on the screen after a few moments. Select it from the list and click Next.

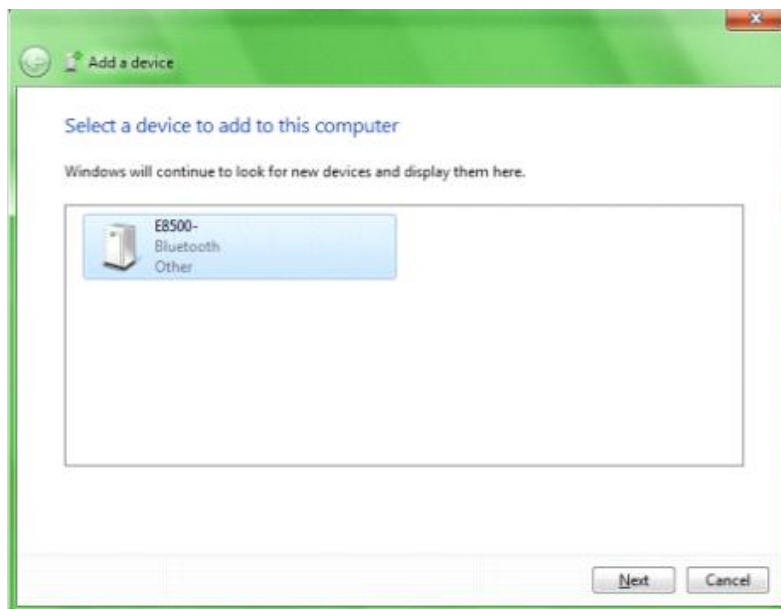

4. On the next screen, select “Enter the device’s pairing code” and click Next.

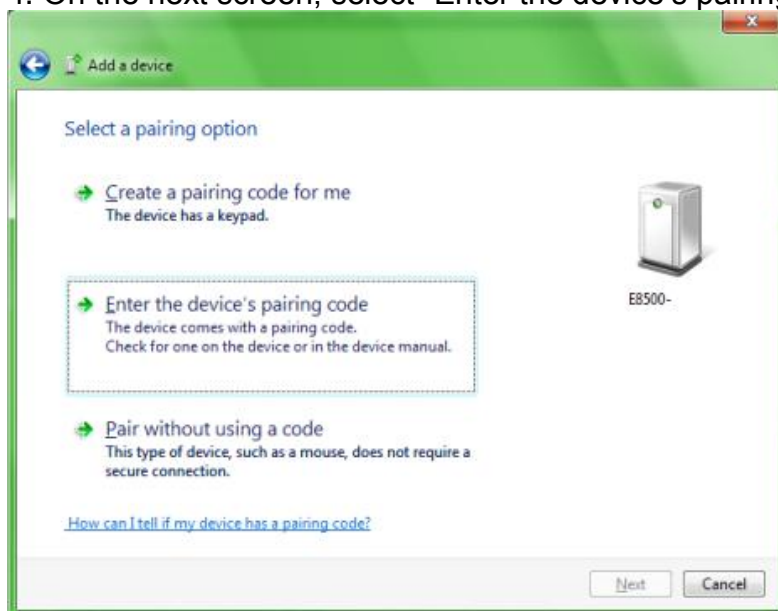

5. Enter the pairing code “0000” (four zeros) into the empty field and click Next.



6. Pairing will complete and the PC to instrument communication drivers will be automatically installed.



## ALL CONNECTIONS

When you connect your monitor to your computer for the first time, the connection will be assigned a unique *comport* number. Remember the *comport* number as it will be needed to open an AQ GAS session.

You can find the *comport* associated with your E INSTRUMENTS in the Windows Device Manager.

To open the Device Manager:

- Go to the Windows “START” menu, click “RUN” and type **devmgmt.msc** (Or go to the Control Panel, choose the System icon, then the Hardware tab, and click the Device Manager Key).
- A window will open that will list “PORTS” among other items. Click on “PORTS”.
- The *comport* will be listed as:
  - USB Serial Port (**USB**)
  - Standard Serial over Bluetooth link (**Bluetooth**)

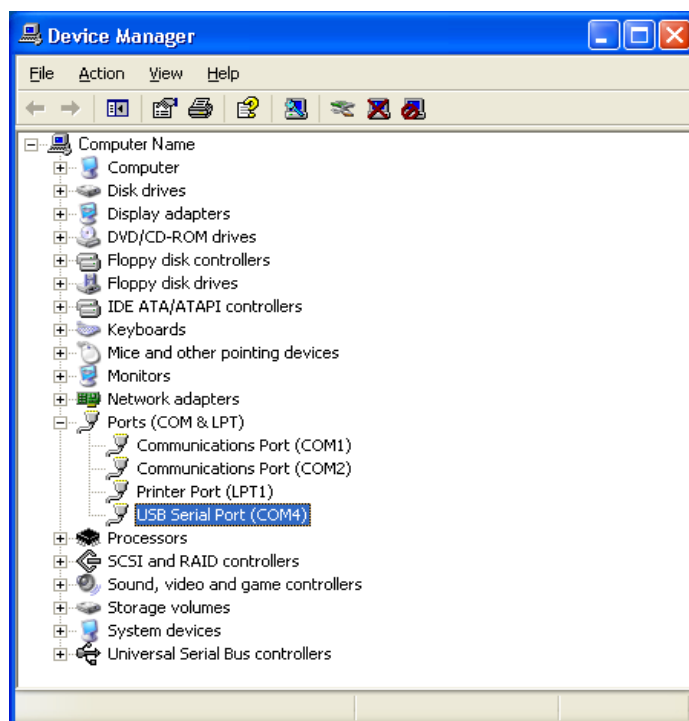

## AQ GAS SOFTWARE

You can enhance the performance and versatility of the E INSTRUMENTS AQ EXPERT by using the AQ GAS software program. AQ GAS is available for most Windows operating systems.

The AQ GAS software is a robust package that allows you to:

1. Monitor all Air Quality parameters.
2. Record maximum, minimum, average for all Air Quality parameters.
3. Select a variety of saving and printing options.
4. Retrieve stored data.

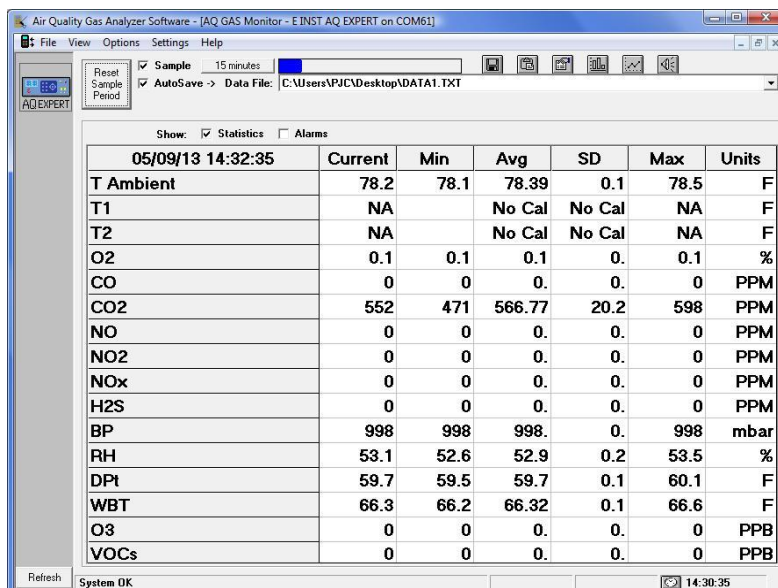



5. Set alarms for every air quality parameter including recording the time duration that alarms have been exceeded.
6. Plot bar graphs and time plots of all air quality parameters.

**The AQ GAS software can be downloaded from the included USB Thumb Drive.**

**Windows 8 users may have to load drivers from the following link:**

<http://www.makeuseof.com/tag/how-can-i-install-hardware-with-unsigned-drivers-in-windows-8/>

Consult the AQ GAS manual for details on installing and operating the program. The manual can be accessed by clicking on “Help” and then “How Do I...” in the AQ GAS software program

## **STARTING AQ GAS**

- 1 Before starting AQ GAS, have your monitor turned on and connected via USB or Bluetooth.
- 2 Start AQ GAS. If you have connected before, the monitor icon will appear. If this is the first time you are connecting you will need to add a new port.
- 3 On the AQ GAS window click on “Connections”, then click on “Add Port”.

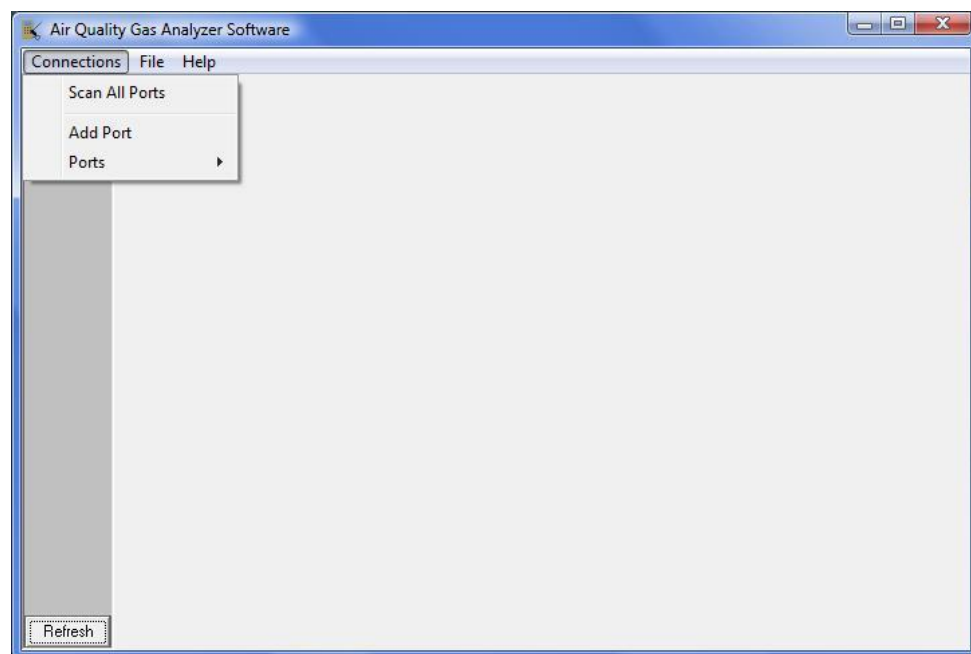

- 4 Enter the COM port number which appeared in the Device Manager, and click “OK”.

- 5 The COM port with its number should appear on the left side of the AQ GAS window. AQ GAS will look for a monitor on this port. After a moment the E INSTRUMENTS monitor icon should appear. You are now connected to your monitor.
- 6 Click on the E INSTRUMENTS icon. A menu will appear. Choose “Monitor” from the menu. *(Follow the AQ GAS manual for further instructions).*

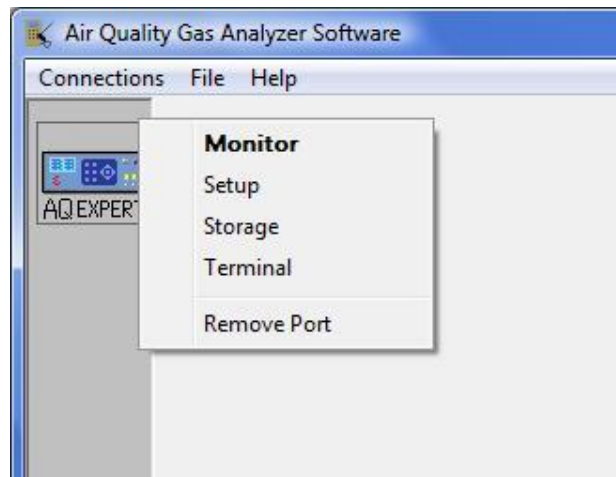

## CHAPTER 11

### MAINTENANCE

The AQ Expert Indoor Air Quality Monitor is a sophisticated analytical instrument designed to perform accurate air quality measurements. However, because the monitor is a portable, field/lab used instrument that can be used in many environments, care must be taken to prevent physical and environmental abuse to help maintain trouble-free operation.

There are some of the components that will require periodic inspection or replacement. These are:

1. The disposable fiber line filter for particulates, located inside the of the monitor
2. The disposable round disk condensation filter for moisture, also located inside the of the monitor
3. Gas sensor periodic replacement / Calibration
4. Printer paper replacement (separate optional wireless printer)

<b>INTERVAL</b>	<b>ITEM</b>	<b>PROCEDURE</b>
Weekly	ZERO Check of ALL Gas Sensors	Perform using ZERO AIR
Weekly	ZERO Check of the CO <sub>2</sub> Sensor	Perform using ZERO AIR
6 Months	Inlet & Moisture Filters	Check and/or Replace
Annually	SPAN Calibration of ALL Gas Sensors	Perform or send to Factory

*\*Note: These stated intervals are dependent on the unit's usage and applications*

#### A. Fiber Line Filter and Condensation Disk Filter Replacement

The disposable fiber line filter is located inside the monitor located right in line with the sampling pump. Its function is to prevent dirt & dust particles from reaching the monitor's pump and sensors. The disk condensation filter is also located in the same area directly behind the fiber line filter. Its function is to prevent any residual water/moisture from penetrating into the sensor area.

You must replace the filters when they become discolored or show any signs of cracks. **Never operate the AQ Expert without these filters.**

Frequency of filter replacement depends on the application this instrument is being used in and the hours of active use.

To replace the filters, remove the top section of the instrument case (see section B below for more details on how to remove top section of the instrument) and disconnect the two pieces of flexible tubing that hold the respective filters in place. If you are replacing the disk filter make sure that the filter's lettering is facing the front face of the instrument.

## B. Sensor Replacement

This should be an infrequent operation, since the sensors have a typical life of a few years.

If you receive an error message for one of the sensors during instrument operation you may have to replace the sensor. Please contact E Instruments for replacement sensors. The user can send the unit back to the factory for sensor installation and re-calibration of the instrument or the sensors can be replaced in the field. The replacement sensors will be supplied with installation instructions.

**NOTE: You must always span calibrate the instrument every time you replace a sensor.**

**NOTE: CO<sub>2</sub> should ALWAYS be Calibrated or Zeroed with a Cylinder of ZERO AIR. Do Not Use Ambient Air for CO<sub>2</sub> sensor calibration.**

To access the sensor compartment you must remove the top section of the instrument case. The top section of the monitor case is held to the bottom section by a total of four retaining screws. With both hands, slide off the vent covers on each side. Use a Philips screwdriver to remove both pairs of retaining screws (one pair on each side of the case). It is best to remove the bottom pair of screws first. Carefully lift the top of the instrument case together with the attached aluminum mounting shielding plate especially since the top & bottom cases pieces are connected with cables/wires. When the plastic case is open, be careful when near the main board because some of the resistors on the board can get significantly hot. The location of the gas sensors on the manifold is shown in the figure in Chapter 5.

To replace a sensor locate its correct position on the manifold. Carefully lift the small PC board that is mounted on top of the sensor. Grab the sensor with your fingers and lift it twisting it out of its bayonet fitting.

Take a new sensor. Remove any springs that may be shorting the sensor pins. Install it on its mount and connect the small PC board on top of it.

Replace the top section of the case and secure it with the four screws.

Wait 30 minutes before zeroing the monitor:

Span calibrate the sensor as explained in Chapter 8. If you are installing a pre-calibrated sensor, use the following procedure:

- 1) While holding the **SETUP** key, press the **MEASURE** key three times. The display will show the sensor factors.
- 2) Press the **DOWN** key until you reach the appropriate sensor then press **OK**.
- 3) Use the **UP / DOWN** keys to enter the correct factor, digit by digit starting with the hundreds digit, press **OK** to move through the tens, ones, and tenths digits.

### C. Printer Paper Replacement

The external printer uses a high quality 2" thermal paper. Keep any spare paper rolls in a cool dark place to prevent paper discoloration.

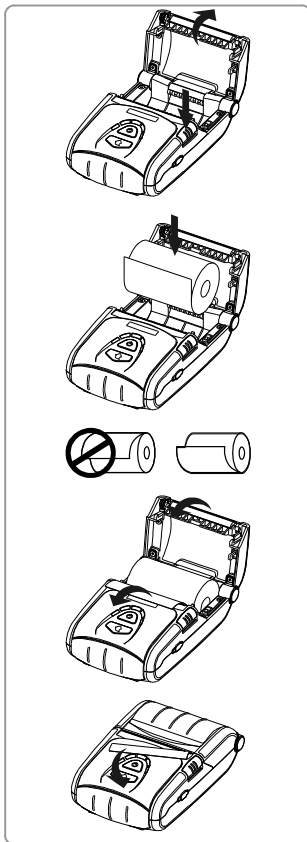

- 1) Press the open key on the printer to open the paper cover
- 2) Insert the paper as shown in the image. Remove any remaining core of a used paper roll.
- 3) Make sure to align the paper roll properly.
- 4) Pull the paper out as shown in the image, and close the cover.
- 5) Tear off any excess paper in the direction of the side of the printer.

---

## CHAPTER 12

---

### AQ EXPERT OPTIONS

The E INSTRUMENTS' AQ EXPERT is an extremely versatile Indoor Air Quality (IAQ) measurement system that meets practically all Air Quality measurement requirements. It has been designed as a modular system, permitting the installation, in the field, of most of the various available options. This manual describes the complete instrument equipped with all the options.

The AQ Expert's standard capabilities include (1) NDIR CO<sub>2</sub> sensor (0-5,000 ppm), Ambient Temperature, Relative Humidity, Wet Bulb, Dew Point, Barometric Pressure, two (2) separate Type K (TCK) thermocouple temperature measurement inputs, Air Velocity measurements, differential pressure measurements, 1000 internal storage tags, Bluetooth wireless PC communications, REAL-TIME Data Logging capabilities using the included AQ GAS Windows™ software, USB Cable, and extensive user-friendly help screens. The available additional gas sensor options and accessories are:

#### 1. AIR QUALITY MONITOR SENSORS\*

- Carbon Dioxide (CO<sub>2</sub>) – non-dispersive infrared (NDIR) sensor (0-20%)
- Carbon Monoxide (CO) – electrochemical sensor (0-200 ppm OR 0-2000 ppm)
- Oxygen (O<sub>2</sub>) - electrochemical sensor (0-25%)
- Nitrogen Dioxide (NO<sub>2</sub>) - electrochemical sensor (0-20 ppm OR 0-1000 ppm)
- Nitrogen Oxide (NO) - electrochemical sensor (0-250 ppm OR 0-2000 ppm)
- Sulfur Dioxide (SO<sub>2</sub>) – electrochemical sensor (0-20 ppm OR 0-2000 ppm)
- Hydrogen Sulfide (H<sub>2</sub>S) – electrochemical sensor (0-100 ppm)
- Formaldehyde (FMH-CH<sub>2</sub>O) – electrochemical sensor (0-10 ppm)
- Ozone (O<sub>3</sub>) – electrochemical sensor (0-5 ppm)
- Isobutylene (VOC) sensor – Photo ionization detector (PID Sensor) (0-20 ppm)
- Isobutylene (VOC) sensor – Photo ionization detector (PID Sensor) (0-200 ppm)

**\*Note:** When O<sub>3</sub> (Ozone) sensor is installed the AQ Expert can include O<sub>3</sub> + NO<sub>2</sub> **OR** O<sub>3</sub> + SO<sub>2</sub>.  
The unit can *NOT* have all three (3) sensors (O<sub>3</sub> + NO<sub>2</sub> + SO<sub>2</sub>) together simultaneously.

#### 2. OPTIONAL EXTERNAL MEASURING PROBE

Certain applications might have the need for the optional probe (12" long stainless steel probe with 10' ft long hose) for hard to reach places, separate areas, etc. The probe consists of the stainless steel extraction probe, the sampling line and a Type K thermocouple for external temperature measurements with the probe.



This standard probe (Part # AACSF22) is suitable for temperatures up to 800°C/1470°F.

The end of the probe's sampling line connects to the SAMPLE IN quick disconnect connector of the AQ Expert and the thermocouple connector connects to either of the yellow TEMPERATURE 1 or 2 inputs on the AQ Expert.

### 3. OPTIONAL VINYL CARRYING CASE (part #: E858140)



### 4. OPTIONAL PITOT TUBES

**Pitot tube** – This optional L-shaped pitot tube consists of stainless steel tubing with the tips open and bent at a certain angle to properly measure air and/or gas velocities. The Pitot tube must always be oriented with the open tips parallel to the direction of the air flow. The end of the Pitot tube assembly is connected by means of two flexible hoses to a very accurate pressure transducer located inside the monitor.



### 5. OPTIONAL DIFFERENTIAL PRESSURE HOSES (Part #: AACKP01)

This optional PRESSURE HOSES consist of two (2) clear hoses for either (1) single positive pressure connection, one (1) single negative pressure connection, or (2) hoses for differential pressure using both connections simultaneously. The hoses connect to the (-) and/or (+) PRESSURE connections on the Front face of the AQ Expert.



## 6. OPTIONAL WIRELESS REMOTE PRINTER (Part #: E852110)

The AQ Expert uses a wireless Bluetooth remote printer. The printer is powered by a rechargeable battery. An AC charger is supplied with the printer. The printer is optional with the AQ Expert. See Chapter 7 for more information



## 7. OPTIONAL CALIBRATION KIT (ZERO AIR) (Part #: AQCAL)

The AQ Expert uses a bottled Cylinder of ZERO AIR for ZERO Calibration.

Part #: **AQCAL** comes with (1) 17L ZERO AIR Cylinder & (1) Regulator

Part #: **AQAIR** is replacement (1) 17L ZERO AIR Cylinder only





## CHAPTER 13

### BASIC TROUBLESHOOTING

ZERO ERRORS		
Channel	Possible Causes	Resolution
(Electrochemical sensors) CO NO NO <sub>2</sub> SO <sub>2</sub> H <sub>2</sub> S CH <sub>2</sub> O O <sub>2</sub> O <sub>3</sub>	Sensor has been recently exposed to gas and has not yet returned to zero.	Purge for 10 minutes with fresh air, monitor sensor voltage, and re-zero.
	Insufficient Warm Up	Allow the sensors to warm up after 10 minutes
	Incorrect ZERO calibration	Repeat ZERO cal in fresh air or with ZERO AIR cylinder
	Pump Failed	Check pump flow, if pump failed replace
	Battery was dead, sensor has destabilized.	Charge battery, wait up to 24 hours for sensors to stabilize, and re-zero.
	Sensor cell life has expired.	Call E INSTRUMENTS for replacement.
(PID sensors) VOC	Sensor has been recently exposed to gas and has not yet returned to zero.	Purge for 10 minutes with fresh air, monitor sensor voltage, and re-zero.
	Battery was discharged, sensor has destabilized.	Charge battery, wait up to 24 hours for sensors to stabilize, and re-zero.
	Sensor cell life has expired.	Call E INSTRUMENTS for replacement.
Temperature Thermocouple	Thermocouple is not connected	Check electrical connections running to the probe
Infrared CO <sub>2</sub>	No response from infrared system	Zero period must be at least 45 seconds. <b>Zero the instrument again with a cylinder ZERO AIR.</b>
	Infrared system is reporting error code	Infrared system may need maintenance.
Velocity	Velocity probe/Pitot Tube is not connected	Check probe and connections.
Bluetooth connection failure	Connection Failed	Redo connection process

<b>TROUBLESHOOTING</b>		
<b>Symptoms</b>	<b>Possible Causes</b>	<b>Resolution</b>
Monitor will not turn on. (Screen is off)	Battery is discharged.	Plug in the charger. Monitor should turn on.
	Battery is not charging.	Check the charger and jack. Check the case for excessive heat.
	Internal initialization problem.	Reset the monitor.
Monitor turns on but screen is blue or faded.	Internal initialization problem.	Reset the monitor.
	Monitor is overheating.	Unplug charger. Check internal fan. Turn on & off to reinitialize.

## CHAPTER 14

### REPLACEMENT PARTS

<b>PART NUMBER</b>	<b>DESCRIPTION</b>
E85-9078	Printer Paper Roll
EE650072	Line Filter
EE650077	Condensation Disk Filter
AAA32-240	O <sub>2</sub> Sensor (0 - 25%)
AQ CO-200	CO Sensor (0-200 ppm)
AQ CO-2000	CO Sensor (0-2000 ppm)
AQ NO-250	NO Sensor (0-250 ppm)
AQ NO-2000	NO Sensor (0-2000 ppm)
AQ NO2-20	NO <sub>2</sub> Sensor (0-20 ppm)
AQ NO2-1000	NO <sub>2</sub> Sensor (0-1000 ppm)
AQ SO2-20	SO <sub>2</sub> Sensor (0-20 ppm)
AQ SO2-2000	SO <sub>2</sub> Sensor (0-2000 ppm)
AQ H2S-100	H <sub>2</sub> S Sensor (0-100 ppm)
AQ O3-5	O <sub>3</sub> Sensor (0-5 ppm)
AQ CO2-5000	NDIR CO <sub>2</sub> Sensor (0-5000 ppm)
AQ CO2-20	NDIR CO <sub>2</sub> Sensor (0-20 %)
AQ VOC-20	PID VOC Sensor (0-20 ppm)
AQ VOC-200	PID VOC Sensor (0-200 ppm)
AQ FMH	Formaldehyde Sensor (0-10 ppm)
E852010	Rechargeable Battery Pack
E852020	AC Charger, 100-240VAC/50-60Hz with 12V Output
E852130	Bluetooth Adapter/Dongle
AQCAL	Calibration KIT – ZERO AIR Cylinder w/ Regulator
AQAIR	Replacement ZERO AIR Cylinder ONLY
E858140	Vinyl Carrying Case with Shoulder Strap
E852110	Remote Bluetooth Wireless Printer w/ AC Charger
AACSF22	12" Probe and 10' hose
AACKP01	Differential Pressure Hoses



**E Instruments International LLC**

402 Middletown Blvd, Suite 216

Langhorne, PA, USA 19047

Phone (215) 750-1212

Fax (215) 750-1399

**Info@E-Inst.com**

**www.E-Inst.com**

