



GEDORE Tools Inc. Torque Products

Products and Solutions for Assembly

GEDORE



About ASG

We are personally committed to understanding and exceeding the requirements of our internal and external customers and all other interested parties. We are committed to continuously improving our products, processes, and services.

We are dedicated to delivering products, services, and solutions on time and at a competitive value.

ASG, Division of Jergens, Inc. is an ISO 9001:2015 certified manufacturer, provider, and service center for products and solutions focused around assembly. Since the 1970s, we have developed a first-class reputation unrivaled in the industry offering a wide range of world class products through our various world wide locations.

We offer a wide selection of products including: electric, pneumatic and manual torque control screwdrivers; torque and angle control precision fastening systems; automatic screw feeders and screw presenters; torque testers and calibration services; custom designed automation equipment as well as a full line of accessories.

ASG also offers a selection of value-added products and solutions including engineering and consulting services, financing, and extended protection and maintenance plans.



Industry Commitment

ASG is committed to the highest quality standards, ensuring that all processes and procedures are followed to produce the best products for our customers. We maintain ISO 9001 certification for the manufacture, distribution, and service of assembly tools. Maintaining membership in key industry organizations in order to stay abreast of the most current industry trends and information is vital to serving our customers.



ASG Assembly

Reliable Performance



ASG Assembly features a wide range of products and solutions for general assembly. Featured in this product group: HIOS® premium brand electric torque control screwdrivers and accessories, ASG brand torque control screwdrivers and accessories, coordinating accessories, and general assembly workstation aides. In 2018, ASG formed a partnership with GEDORE Tools Inc. and now offer their manual tool product line. With unsurpassed error-proofing, high reliability, durability and repeatability, ASG Assembly products ensure long life and ease of use.

GEDORE Tools Inc.



The 28,000 square feet Gedore Torque site has been at the forefront of UK Torque tool design and manufacture since 1937. Located in the United Kingdom, GEDORE, formerly TorqueLeader, is a leading manufacturer of industrial torque tools. GEDORE's high quality tools offer the broadest torque range in the industry. Their extensive line of torque wrenches, torque screwdrivers, torque multipliers, and a variety of end fittings are designed and built with the operator in mind. These tools increase efficiency and decrease operator fatigue.

Table of Contents

About ASG	2
ASG Assembly Product Group	3
GEDORE Tools Inc.....	3
Section 1: GEDORE Torque Wrenches	4
Section 2: GEDORE Torque Screwdrivers	15
Section 3: Other GEDORE Torque Tools	21
RTU Torque Limiters	21
Weld Stud Test Tools.....	22
Section 4: GEDORE Torque Multipliers.....	23
Section 5: GEDORE Torque Accessories	26
Section 6: Warranty and Calibration Information	39

Section 1: GEDORE Torque Wrenches

Preset Torque Wrenches



TSN 55



TSN 10/90

TSN Preset Slipping Torque Wrenches

High quality tools that have been designed and precision-engineered to meet the stringent demands of manufacturing businesses in most industries.

- Unique slipping mechanism prevents under and over tightening
- Most models are EPA compliant for use in electro-statically sensitive areas; ideal for safe electronic component assembly
- Improved production efficiency — the adjusting system reduces the likelihood of warranty and rework by assuring process control through accurate and repeatable torque
- Process control can be further enhanced by using the Switch Operated Signal Torque versions (Sw) to confirm correct torque has been applied to a particular fastener
- High quality, robust design



Working principle of the Gedore Torque Slipping Wrenches

ASG Number	Model Number	Torque Range		Drive Type	Accuracy	Weight		Length		ISO 6789 Class	EPA Compliant
		Metric	Imperial			kg	lb.	mm	in.		
011301	TSN 5/45	1-5 N.m	10-45 lbf.in	1/4" Male Square	±6%	0.19	0.4	185	7.3	2C	Yes
011401	TSN 10/90	2-10 N.m	20-90 lbf.in	1/4" Male Square	±6%	0.19	0.4	185	7.3	2C	Yes
011017	TSN 25 D	5-25 N.m	4-18 lbf.ft	1/4" Male Square	±4%	0.34	0.7	216	8.5	2C	Yes
011019	TSN 25 A	5-25 N.m	4-18 lbf.ft	3/8" Male Square	±4%	0.34	0.7	216	8.5	2C	Yes
011035	TSN 55	15-55 N.m	10-40 lbf.ft	3/8" Male Square	±4%	0.8	1.8	324	12.8	2C	No
011055	TSN 125	40-125 N.m	30-90 lbf.ft	1/2" Male Square	±4%	1.36	3	460	18.1	2C	No



GEDORE Torque Wrenches

Preset Torque Wrenches



TBN 135 and TBN 2

TBN Preset Breaking Torque Wrenches

TBN preset breaking torque wrenches are robust production tools that reduce the chance of over-tightening. They can be used for a wide range of applications with a choice of compatible interchangeable end fittings. Their durable yet compact design makes them easy to use in any manufacturing or maintenance environment.

- Unique breaking mechanism prevents under and over tightening
- Compact, slimline, ergonomic design maximizes productivity in restricted areas and increases operator comfort
- High quality, robust design
- TBN 2 and TBN 10: supplied with a calibration certificate when ordered with an attached end fitting and preset
- Some models are EPA compliant

ASG Number	Model Number	Torque Range		Drive Type	Accuracy	Weight		Length		ISO 6789 Class	EPA Compliant
		Metric	Imperial			kg	lb.	mm	in.		
011100	TBN 2	0.4-2.0 N.m	3.5-18 lbf.in	Captive Pin	±6%	0.11	0.24	105	4.1	2C	Yes
011110	TBN 2 G	0.4-2.0 N.m	3.5-18 lbf.in	9x12mm Female	±6%	0.13	0.29	133	5.2	2C	Yes
011200	TBN 10	1-10 N.m	9-89 lbf.in	Captive Pin	±6%	0.13	0.29	105	4.1	2C	Yes
011210	TBN 10 G	1-10 N.m	9-89 lbf.in	9x12mm Female	±6%	0.15	0.33	133	5.2	2C	Yes
050000	TBN 25	5-25 N.m	4-18 lbf.ft	16mm Round Male	±4%	0.41	0.9	265	10.4	2C	No
050010	TBN 25 G	5-25 N.m	4-18 lbf.ft	9x12mm Female	±4%	0.41	0.9	265	10.4	2C	No
050100	TBN 65	10-65 N.m	7-48 lbf.ft	16mm Round Male	±4%	0.75	1.7	302	11.9	2C	No
050110	TBN 65 G	10-65 N.m	7-48 lbf.ft	9x12mm Female	±4%	0.75	1.7	302	11.9	2C	No
050200	TBN 135	27-135 N.m	18-100 lbf.ft	16mm Round Male	±4%	1.03	2.3	408	16	2C	No
050210	TBN 135 G	27-135 N.m	18-100 lbf.ft	9x12mm Female	±4%	1.03	2.3	408	16	2C	No
050300	TBN 200	40-200 N.m	29-147 lbf.ft	16mm Round Male	±4%	1.4	3.1	520	20.5	2C	No
050310	TBN 200 G	40-200 N.m	29-147 lbf.ft	14x18mm Female	±4%	1.4	3.1	520	20.5	2C	No



GEDORE Torque Wrenches

Preset Torque Wrenches



TSN 25 A Sw and TBN 25 Sw



Signal Delay Unit
ASG #C12870



Universal Switch Module
ASG #B25900

Switch Operated Signal Torque Wrenches

Switch operated signal torque wrenches are process control tools that provide absolute confidence that the correct level of torque has been applied. In addition to the breaking/slipping mechanism that reduces the risk of incorrect tightening, the tool also sends a signal each time the wrench achieves its preset torque value. This makes these tools suitable for production line control or to provide a counting function, as they can be connected to the customers production systems.

- Unique slipping and breaking mechanisms prevent under and over tightening
- Easy to use
- Confirm that the tightening process has been performed by validating that the torque wrenches have operated at a preset torque value. A signal is sent upon each successful activation of the wrench.
- Can be easily integrated into most production lines. Output signal is a switch opening and closing.
- Signal Delay Unit can be used to reduce the risk of missing wrench activations
- Universal switch module is connected via cable to the production line control system

ASG Number	Model Number	Torque Range		Drive Type	Accuracy	Weight		Length		ISO 6789 Class
		Metric	Imperial			kg	lb.	mm	in.	
056093	TSP 5 Sw	1-5 N.m	10-45 lbf.in	1/4" Male Square	±6%	0.53	1.2	335	13.2	2C
056103	TSP 10 Sw	2-10 N.m	20-90 lbf.in	1/4" Male Square	±6%	0.53	1.2	335	13.2	2C
011003	TSN 25 D Sw	5-25 N.m	4-18 lbf.ft	1/4" Male Square	±4%	0.68	1.5	366	14.4	2C
011013	TSN 25 A Sw	5-25 N.m	4-18 lbf.ft	3/8" Male Square	±4%	0.68	1.5	366	14.4	2C
011033	TSN 55 Sw	15-55 N.m	10-40 lbf.ft	3/8" Male Square	±4%	1.14	2.5	474	18.7	2C
011053	TSN 125 Sw	40-125 N.m	30-90 lbf.ft	1/2" Male Square	±4%	1.7	3.7	610	24	2C
011103	TBN 2 Sw	0.4-2.0 N.m	3.5-18 lbf.in	Captive Pin	±6%	0.45	1.0	255	10	2C
011113	TBN 2 G Sw	0.4-2.0 N.m	3.5-18 lbf.in	9x12mm Female	±6%	0.13	0.3	133	5.2	2C
011203	TBN 10 Sw	1-10 N.m	9-89 lbf.in	Captive Pin	±6%	0.47	1.0	255	10	2C
011213	TBN 10 G Sw	1-10 N.m	9-89 lbf.in	9x12mm Female	±6%	0.15	0.33	133	5.2	2C
050003	TBN 25 Sw	5-25 N.m	4-18 lbf.ft	16mm Round Male	±4%	0.75	1.7	415	16.3	2C
050013	TBN 25 G Sw	5-25 N.m	4-18 lbf.ft	9x12mm Female	±4%	0.75	1.7	415	16.3	2C
050103	TBN 65 Sw	10-65 N.m	7-48 lbf.ft	16mm Round Male	±4%	1.09	2.4	452	17.8	2C
050113	TBN 65 G Sw	10-65 N.m	7-48 lbf.ft	9x12mm Female	±4%	1.09	2.4	452	17.8	2C
050203	TBN 135 Sw	27-135 N.m	18-100 lbf.ft	16mm Round Male	±4%	1.68	3.7	558	22	2C
050213	TBN 135 G Sw	27-135 N.m	18-100 lbf.ft	9x12mm Female	±4%	1.68	3.7	558	22	2C
050303	TBN 200 Sw	40-200 N.m	29-147 lbf.ft	16mm Round Male	±4%	1.74	3.8	670	26.4	2C
050313	TBN 200 G Sw	40-200 N.m	29-147 lbf.ft	14x18mm Female	±4%	1.74	3.8	670	26.4	2C

GEDORE Torque Wrenches

Preset Torque Wrenches

50V Insulated Preset Torque Wrenches

Precision engineered tools providing accuracy and user safety during electrical assembly and maintenance. The unique breaking and slipping mechanisms eliminate the risk of incorrect tightening and the compact tool design provides protection where there are electrically live components, up to 50V.



TBN 10 50V

- Unique breaking and slipping mechanisms prevent under and over tightening
- Small and compact design combined with insulated body is ideal for use in restricted space where there are electrically live components
- Improved production efficiency — eliminates the possibility of product failure due to shorting, arcing, or other electrical damage
- Designed for use in low voltage and other battery applications where protection up to 50V is required. Double layer non-conductive PVC insulation provides protection against low voltage shorting.
- Tool is pre-set at point of order

ASG Number	Model Number	Torque Range		Drive Type	Accuracy	Weight		Length	
		Metric	Imperial			kg	lb.	mm	in.
011108	TBN 2 50V	0.4-2.0 N.m	3.5-18 lbf.in	1/4" Male Square	±6%	0.17	0.4	105	4.1
011208	TBN 10 50V	1-10 N.m	9-89 lbf.in	1/4" Male Square	±6%	0.17	0.4	105	4.1
011062	TSN 25 D 50V	5-25 N.m	4-18 lbf.ft	1/4" Male Square	±4%	0.4	0.9	220	8.7
011072	TSN 25 A 50V	5-25 N.m	4-18 lbf.ft	3/8" Male Square	±4%	0.4	0.9	220	8.7

Torcofix Production Clicker Torque Wrenches

Versatile production tools with a wide range of interchangeable end fittings, designed for accurate and repeated torque application. An audible click provides tightening process control.

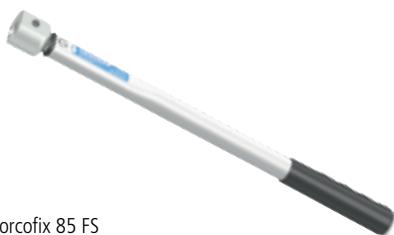

Torcofix 85 FS

- Risk of under and over tightening reduced as click can be heard and felt when the preset torque is reached
- Versatile design allowing the use of a range of end fittings and ratchets
- High quality, robust design

ASG Number	Model Number	Torque Range		Drive Type	Accuracy	Weight		Length		ISO 6789 Class
		Metric	Imperial			kg	lb.	mm	in.	
7601960	Torcofix 25 FS	5-25 N.m	3.7-18 lbf.ft	9x12mm Female	±4%	0.21	0.5	180	7.1	2C
7602180	Torcofix 50 FS	10-50 N.m	7.5-37.5 lbf.ft	9x12mm Female	±4%	0.27	0.6	240	9.4	2C
7602850	Torcofix 85 FS	17-85 N.m	12.5-65 lbf.ft	9x12mm Female	±4%	0.34	0.75	320	12.6	2C
7603580	Torcofix 200 FS	40-200 N.m	30-150 lbf.ft	14x18mm Female	±4%	0.75	1.7	400	15.7	2C

GEDORE Torque Wrenches

Adjustable Torque Wrenches

ATB Adjustable Breaking Torque Wrenches



ATB 10 G



ATB 25

EPA compliant, compact, versatile, and lightweight tools engineered to reduce the risk of under and over tightening in production, service, and repair. Calibrated scale allows for pre-setting of torque.

- Unique breaking technology prevents under and over tightening
- Visible micrometer style scale allows user to adjust the torque setting quickly and easily
- Compact design allows for use in restricted areas
- Some models are EPA compliant for use in electro-statically sensitive areas
- High quality, durable and ergonomic design and construction
- Reduces the likelihood of warranty and rework by assuring process control through accurate and repeatable torque

ASG Number	Model Number	Torque Range		Scale Graduations		Drive Type	Accuracy	ISO 6789 Class	EPA Compliant
		Metric	Imperial	Metric	Imperial				
050520	ATB 2.5	50-250 cN.m		1.25 cN.m		8mm Round Male	±6%	2A	Yes
050525	ATB 2.5		4.5-22.5 lbf.in		0.1 lbf.in	8mm Round Male	±6%	2A	Yes
050527	ATB 2.5 G	50-250 cN.m		1.25 cN.m		9x12mm Female	±6%	2A	Yes
050532	ATB 2.5 G		4.5-22.5 lbf.in		0.1 lbf.in	9x12mm Female	±6%	2A	Yes
050500	ATB 5	1-5 N.m		0.025 N.m		8mm Round Male	±6%	2A	Yes
050505	ATB 5		10-45 lbf.in		0.25 lbf.in	8mm Round Male	±6%	2A	Yes
050507	ATB 5 G	1-5 N.m		0.025 N.m		9x12mm Female	±6%	2A	Yes
050512	ATB 5 G		10-45 lbf.in		0.25 lbf.in	9x12mm Female	±6%	2A	Yes
050550	ATB 10	2-10 N.m		0.05 N.m		8mm Round Male	±6%	2A	Yes
050555	ATB 10		20-90 lbf.in		0.5 lbf.in	8mm Round Male	±6%	2A	Yes
050557	ATB 10 G	2-10 N.m		0.05 N.m		9x12mm Female	±6%	2A	Yes
050562	ATB 10 G		20-90 lbf.in		0.5 lbf.in	9x12mm Female	±6%	2A	Yes
Right Angle Square Drive Models									
050636	ATB 25 D	5-25 N.m		0.1 N.m		1/4" Male Square	±4%	2A	No
050641	ATB 25 D		50-250 lbf.in		1 lbf.in	1/4" Male Square	±4%	2A	No
050646	ATB 25 D		4-20 lbf.ft		0.1 lbf.ft	1/4" Male Square	±4%	2A	No
050638	ATB 25 A	5-25 N.m		0.1 N.m		3/8" Male Square	±4%	2A	No
050643	ATB 25 A		50-250 lbf.in		1 lbf.in	3/8" Male Square	±4%	2A	No
050648	ATB 25 A		4-20 lbf.ft		0.1 lbf.ft	3/8" Male Square	±4%	2A	No
050685	ATB 50	10-50 N.m		0.25 N.m		3/8" Male Square	±4%	2A	No
050690	ATB 50		120-440 lbf.in		2 lbf.in	3/8" Male Square	±4%	2A	No
050695	ATB 50		7-37 lbf.ft		0.125 lbf.ft	3/8" Male Square	±4%	2A	No
050735	ATB 100	20-100 N.m		0.5 N.m		1/2" Male Square	±4%	2A	No
050740	ATB 100		240-880 lbf.in		4 lbf.in	1/2" Male Square	±4%	2A	No
050745	ATB 100		14-74 lbf.ft		0.25 lbf.ft	1/2" Male Square	±4%	2A	No

GEDORE Torque Wrenches

Adjustable Torque Wrenches

TSC Adjustable Slipping Torque Wrenches



TSC 10

Compact, versatile, and lightweight tools which eliminate over tightening in a wide range of industrial applications.

- Bearings are extremely wear resistant, utilizing self-lubricating polymer material, which offers a heightened level of performance, while at the same time reducing the weight to improve the user experience.
- Incorporates a micrometer style fine adjustment with a positive locking system, providing fast, easy, and accurate setting
- Glass filled Nylon 66, non-slip grip for durability with anti-static properties
- EPA compliant for use in electro-statically sensitive areas
- $\pm 6\%$ accuracy

ASG Number	Model Number	Torque Range		Scale Graduations		Drive Type	Weight		Length		ISO 6789 Class	EPA Compliant
		Metric	Imperial	Metric	Imperial		kg	lb.	mm	in.		
059020	TSC 5	1-5 N.m		0.05 N.m		1/4" Male Square	0.235	0.5	195	7.7	2A	Yes
059040	TSC 10	2-10 N.m		0.1 N.m		1/4" Male Square	0.235	0.5	195	7.7	2A	Yes
059060	TSC 45		10-45 lbf.in		0.5 lbf.in	1/4" Male Square	0.235	0.5	195	7.7	2A	Yes
059080	TSC 90		20-90 lbf.in		1.0 lbf.in	1/4" Male Square	0.235	0.5	195	7.7	2A	Yes



GEDORE Torque Wrenches

Adjustable Torque Wrenches



Industrial Adjustable Breaking Torque Wrenches

Designed and precision-engineered to meet the needs of the most demanding industries and toughest working conditions. The BIW Adjustable Breaking Torque Wrench can be used for applications from assembly and manufacture to maintenance, repair, and service.

- Robust construction allows tools to function to the most stringent and exacting requirement
- Unique breaking technology prevents under and over tightening
- Visible micrometer style scale allows user to adjust the tool quickly and easily
- Dual scaled; N.m and lbf.ft
- High quality, durable and robust design. All steel construction and corrosion-resistant finish.
- Reduces the likelihood of warranty and rework by assuring process control through accurate and repeatable torque
- Tested to the requirements of ISO 6789 and supplied with calibration certificate and storage case



BIW Industrial Wrench

ASG Number	Model Number	Torque Range		Output Drive Type	Accuracy	Dimensions LxWxH		ISO 6789 Class
		Metric	Imperial			mm	in.	
3022854	BIW 700	150-700 N.m	100-500 lbf.ft	3/4" Female Square	±4%	1250 x 100 x 60	49.2 x 3.9 x 2.4	2F
3022862	BIW 800	200-800 N.m	150-600 lbf.ft	3/4" Female Square	±4%	1250 x 100 x 60	49.2 x 3.9 x 2.4	2F
3022870	BIW 1000	300-1000 N.m	200-750 lbf.ft	3/4" Female Square	±4%	1470 x 100 x 60	57.9 x 3.9 x 2.4	2F

GEDORE Torque Wrenches

Adjustable Torque Wrenches



Torcofix 100 K



Torcofix 100 Z



Interchangeable 1/4" and 3/8" Square Drive

Push Through 1/2" Square Drive

Torcofix K, Z, and SE Adjustable Clicker Torque Wrenches

The Torcofix series are adjustable tools for service and repair and are ideal for covering a wide number of tasks. An audible click informs the operator the correct torque has been applied.

- Risk of under and over tightening reduced as click can be heard and felt when the preset torque is reached
- Clear scale design making it quick and easy to adjust torque setting
- High quality, robust design and construction
- Choice of drives available for Torcofix K models: interchangeable 1/4" and 3/8" square drive, and push through 1/2" square drive
- Z and SE model design allows for the use of 16mm spigot, 9x12 end fittings and ratchets for multiple industrial applications
- $\pm 4\%$ accuracy

ASG Number	Model Number	Torque Range		Scale Graduations	Drive Type	Weight		Length		ISO 6789 Class
		Metric	Imperial	Metric		kg	lb.	mm	in.	
2201429	Torcofix 5 K	1-5 N.m	0.75-3.7 lbf.ft	0.25 N.m	1/4" Male Square	0.32	0.7	224	8.8	2A
1545132	Torcofix 25 K	5-25 N.m	3.7-18 lbf.ft	1 N.m	1/4" Male Square	0.45	1	285	11.2	2A
1545140	Torcofix 50 K	10-50 N.m	7.5-37 lbf.ft	2.5 N.m	3/8" Male Square	0.54	1.2	335	13.2	2A
7601530	Torcofix 100 K	20-100 N.m	15-75 lbf.ft	5 N.m	1/2" Male Square	0.9	2	394	15.5	2A
7601610	Torcofix 200 K	40-200 N.m	30-150 lbf.ft	10 N.m	1/2" Male Square	1.1	2.4	485	19	2A
7601880	Torcofix 300 K	60-300 N.m	45-220 lbf.ft	10 N.m	1/2" Male Square	1.4	3.1	577	22.7	2A
7674330	Torcofix 400 K	80-400 N.m	60-300 lbf.ft	10 N.m	3/4" Male Square	2.0	4.4	686	27	2A
7674760	Torcofix 550 K	110-550 N.m	80-405 lbf.ft	10 N.m	3/4" Male Square	3.8	8.4	957	37.7	2A
1521365	Torcofix 750 K	150-750 N.m	110-550 lbf.ft	10 N.m	3/4" Male Square	4.8	10.6	1236	48.7	2A
1646168	Torcofix 25 Z	5-25 N.m	3.7-18 lbf.ft	1 N.m	16mm Round Male	0.5	1.1	280	11	2A
1646176	Torcofix 50 Z	10-50 N.m	7.5-37 lbf.ft	2.5 N.m	16mm Round Male	0.6	1.3	330	13	2A
7097270	Torcofix 100 Z	20-100 N.m	15-75 lbf.ft	5 N.m	16mm Round Male	0.6	1.3	375	14.8	2A
7097350	Torcofix 200 Z	40-200 N.m	30-150 lbf.ft	10 N.m	16mm Round Male	0.8	1.8	465	18.3	2A
7097430	Torcofix 300 Z	60-300 N.m	45-220 lbf.ft	10 N.m	16mm Round Male	1.2	2.6	565	22.2	2A
7094090	Torcofix 400 Z	80-400 N.m	60-300 lbf.ft	10 N.m	16mm Round Male	1.5	3.3	650	25.6	2A
1646192	Torcofix 25 SE	5-25 N.m	3.7-18 lbf.ft	1 N.m	9x12mm Female	0.5	1.1	280	11	2A
1646206	Torcofix 50 SE	10-50 N.m	7.5-37 lbf.ft	2.5 N.m	9x12 mm Female	0.6	1.3	330	13	2A
7600210	Torcofix 100 SE	20-100 N.m	15-75 lbf.ft	5 N.m	9x12 mm Female	0.6	1.3	375	14.8	2A
7600990	Torcofix 200 SE	40-200 N.m	30-150 lbf.ft	10 N.m	14x18 mm Female	0.8	1.8	465	18.3	2A
7601020	Torcofix 300 SE	60-300 N.m	45-220 lbf.ft	10 N.m	14x18 mm Female	1.2	2.6	565	22.2	2A
7604120	Torcofix 400 SE	80-400 N.m	60-300 lbf.ft	10 N.m	14x18 mm Female	1.5	3.3	650	25.6	2A

GEDORE Torque Wrenches

Dial Measuring Torque Wrenches

ADS, BDS, CDS, DDS, EDS Dial Measuring Torque Wrenches



BDS 80 E and ADS 25 S



The Gedore dial measuring torque wrenches are designed to verify or monitor torque in order to ensure process conformity, product safety, and absolute reliability. The main pointer on the dial captures the finishing torque applied to a fastener with a memory pointer.

- Dial provides effective measurement in metric and imperial torque units in both directions
- Used for maintenance, assembly, repair, and quality control
- High quality construction and robust design
- Recessed dial minimizes damage to the dial display
- Double ended ratchet as standard (except EDS models)
- ADS models are EPA compliant
- Signal versions available
- $\pm 3\%$ accuracy

ASG Number	Model Number	Torque Range		Scale Graduations		Drive Type	ISO 6789 Class	Signal Version	EPA Compliant
		Metric	Imperial	Metric	Imperial				
010100	ADS 4	0.8-4.0 N.m	7-35 lbf.in	0.1 N.m	1 lbf.in	1/4" Male Square	1B	No	Yes
010108	ADS 4 S	0.8-4.0 N.m	7-35 lbf.in	0.1 N.m	1 lbf.in	1/4" Male Square	1B	Yes	Yes
010120	ADS 8	1.6-8.0 N.m	14-75 lbf.in	0.25 N.m	1 lbf.in	1/4" Male Square	1B	No	Yes
010128	ADS 8 S	1.6-8.0 N.m	14-75 lbf.in	0.25 N.m	1 lbf.in	1/4" Male Square	1B	Yes	Yes
010140	ADS 12 D	2.4-12 N.m	24-120 lbf.in	0.5 N.m	2 lbf.in	1/4" Male Square	1B	No	Yes
010148	ADS 12 DS	2.4-12 N.m	24-120 lbf.in	0.5 N.m	2 lbf.in	1/4" Male Square	1B	Yes	Yes
010160	ADS 12 A	2.4-12 N.m	24-120 lbf.in	0.5 N.m	2 lbf.in	3/8" Male Square	1B	No	Yes
010168	ADS 12 AS	2.4-12 N.m	24-120 lbf.in	0.5 N.m	2 lbf.in	3/8" Male Square	1B	Yes	Yes
010180	ADS 25	5-25 N.m	48-240 lbf.in	1 N.m	10 lbf.in	3/8" Male Square	1B	No	Yes
010188	ADS 25 S	5-25 N.m	48-240 lbf.in	1 N.m	10 lbf.in	3/8" Male Square	1B	Yes	Yes
010200	ADS 25 F	5-25 N.m	4-20 lbf.ft	1 N.m	0.5 lbf.ft	3/8" Male Square	1B	No	Yes
010208	ADS 25 FS	5-25 N.m	4-20 lbf.ft	1 N.m	0.5 lbf.ft	3/8" Male Square	1B	Yes	Yes
010220	ADS 40	8-40 N.m	72-360 lbf.in	1 N.m	10 lbf.in	3/8" Male Square	1B	No	Yes
010228	ADS 40 S	8-40 N.m	72-360 lbf.in	1 N.m	10 lbf.in	3/8" Male Square	1B	Yes	Yes
010240	ADS 40 F	8-40 N.m	6-30 lbf.ft	1 N.m	1 lbf.ft	3/8" Male Square	1B	No	Yes
010248	ADS 40 FS	8-40 N.m	6-30 lbf.ft	1 N.m	1 lbf.ft	3/8" Male Square	1B	Yes	Yes

Continued on page 13

GEDORE Torque Wrenches

Dial Measuring Torque Wrenches

ADS, BDS, CDS, DDS, EDS Dial Measuring Torque Wrenches (Continued)

ASG Number	Model Number	Torque Range		Scale Graduations		Drive Type	ISO 6789 Class	Signal Version	EPA Compliant
		Metric	Imperial	Metric	Imperial				
010300	BDS 80 A	16-80 N.m	12-60 lbf.ft	2 N.m	1 lbf.ft	3/8" Male Square	1B	No	No
010380	BDS 80 AS	16-80 N.m	12-60 lbf.ft	2 N.m	1 lbf.ft	3/8" Male Square	1B	Yes	No
010320	BDS 80 E	16-80 N.m	12-60 lbf.ft	2 N.m	1 lbf.ft	1/2" Male Square	1B	No	No
010400	BDS 80 ES	16-80 N.m	12-60 lbf.ft	2 N.m	1 lbf.ft	1/2" Male Square	1B	Yes	No
010410	BDS 100 EF	20-100 N.m	14-70 lbf.ft	2 N.m	2 lbf.ft	1/2" Male Square	1B	No	No
010415	BDS 100 E	20-100 N.m	168-840 lbf.in	2 N.m	24 lbf.in	1/2" Male Square	1B	No	No
010340	BDS 160	32-160 N.m	24-120 lbf.ft	2.5 N.m	2 lbf.ft	1/2" Male Square	1B	No	No
010420	BDS 160 S	32-160 N.m	24-120 lbf.ft	2.5 N.m	2 lbf.ft	1/2" Male Square	1B	Yes	No
010360	BDS 200	40-200 N.m	30-160 lbf.ft	5 N.m	5 lbf.ft	1/2" Male Square	1B	No	No
010440	BDS 200 S	40-200 N.m	30-160 lbf.ft	5 N.m	5 lbf.ft	1/2" Male Square	1B	Yes	No
010520	CDS 400 S	80-400 N.m	60-300 lbf.ft	10 N.m	10 lbf.ft	3/4" Male Square	1B	Yes	No
010620	DDS 800 S	160-800 N.m	120-600 lbf.ft	20 N.m	20 lbf.ft	3/4" Male Square	1B	Yes	No
010700	EDS 1400 S	280-1400 N.m	200-1000 lbf.ft	25 N.m	25 lbf.ft	1" Male Square	1B	Yes	No
010720	EDS 2000 S	400-2000 N.m	300-1500 lbf.ft	50 N.m	50 lbf.ft	1" Male Square	1B	Yes	No



GEDORE Torque Wrenches

Digital Torque Wrenches

Torcotronic Digital Torque Wrenches with Angle

Torcotronic digital wrenches provide highly accurate and controlled bi-directional tightening, suitable for production, quality auditing, research and development, and maintenance and repair applications. These microprocessor-controlled tools have built in memory which stores data for download to analysis software.



Torcotronic 350 with Angle

- High level of accuracy, $\pm 1\%$ of reading between 10% and 100% of full scale
- Reversible ratchet supplied as standard for bi-directional tightening
- Five programmable preset values
- Built-in memory can store 2,000 data points ready for download to analysis software
- High quality construction and robust design
- Easy to use PC software supplied as standard – available in 11 languages
- Torque and angle capability ensures suitability for a broad range of applications
- Tools integrate with 9x12mm and 14x18mm wrench fittings

ASG Number	Model Number	Torque Range		Drive Type	Adapters	Accuracy	Weight		Length		ISO 6789 Class
		Metric	Imperial				kg	lb.	mm	in.	
021640	Torcotronic 120	10-120 N.m	7-88 lbf.ft	1/2" Male Square	9x12mm Female	$\pm 1\%$	1.01	2.2	565	22.2	1C
021650	Torcotronic 350	70-350 N.m	51-258 lbf.ft	1/2" Male Square	14x18mm Female	$\pm 1\%$	1.18	2.6	701	27.6	1C



Section 2: GEDORE Torque Screwdrivers

Preset Torque Screwdrivers

Pro Preset Torque Screwdrivers



Pro Series



Pro Series ESD



Pro 450 and Pro 1350 with T-Bar



Prime 450

The preset torque screwdriver range has been designed to complement traditional accuracy, durability, and quality with the benefits of a molded plastic body and enhanced ergonomic design. These tools are durable, versatile, and lightweight. The models in this range include ESD, Prime, and Pro.

Pro and ESD Preset Torque Screwdrivers:

- Unique slipping mechanism prevents under and over tightening
- Accurate torque application reduces the likelihood of warranty and rework
- Dual formed molded ergonomic hand grip provides comfort and grip to the operator
- High quality construction and robust design
- Ideal for many applications with a wide torque range and one way slipping action
- Colored end caps are available in packs of 4 (ASG #065800) to allow easy identification of what tool is set to what torque value— End Cap Colors: Blue, Green, Red, Black
- Calibration stickers can be easily applied to the nose
- 1/4" female hexagon pro range proves versatile with a quick conversion to 1/4" male square drive by using a converter (ASG #029200)
- Tool presetting service available, contact ASG
- ESD safe and EPA compliant models available - ideal for safe electronic component assembly

Prime Preset Torque Screwdrivers

- Specifically designed to provide a low cost product that is suitable for light, occasional use or one-off applications
- Can be used up to 2,000 cycles
- No certification and not intended for regular or heavy use

ASG Number	Model Number	Torque Range		Drive Type	Accuracy	ISO 6789 Class	T-Bar Included	EPA Compliant
		Metric	Imperial					
065400	Pro 25 FH	0.05-0.25 N.m	0.45-2.2 lbf.in	1/4" Female Hex	±6%	2F	No	No
065500	Pro 150 FH	0.2-1.5 N.m	1.8-13 lbf.in	1/4" Female Hex	±6%	2F	No	No
065600	Pro 450 FH	0.5-4.5 N.m	4.5-40 lbf.in	1/4" Female Hex	±6%	2F	Yes	No
065700	Pro 1350 FH	2.5-13.5 N.m	22-120 lbf.in	1/4" Female Hex	±6%	2F	Yes	No
065405	ESD 25 FH	0.05-0.25 N.m	0.45-2.2 lbf.in	1/4" Female Hex	±6%	2F	No	Yes
065505	ESD 150 FH	0.2-1.5 N.m	1.8-13 lbf.in	1/4" Female Hex	±6%	2F	No	Yes
065605	ESD 450 FH	0.5-4.5 N.m	4.5-40 lbf.in	1/4" Female Hex	±6%	2F	Yes	Yes
065705	ESD 1350 FH	2.5-13.5 N.m	22-120 lbf.in	1/4" Female Hex	±6%	2F	Yes	Yes
065100	Prime 150 FH	0.2-1.5 N.m	1.8-13 lbf.in	1/4" Female Hex	±10%	—	No	No
065200	Prime 450 FH	0.5-4.5 N.m	4.5-40 lbf.in	1/4" Female Hex	±10%	—	No	No

GEDORE Torque Screwdrivers

Preset Torque Screwdrivers

TLS Preset Torque Screwdrivers



The TLS Series is a range of compact aluminum preset torque screwdrivers that deliver the correct torque accurately and repeatedly. Screwdrivers are all 1/4" Hex and are supplied with a quick converter adapter to 1/4" male square drive (0022 models excluded).

- Unique slipping mechanism prevents under and over tightening
- Accurate torque application reduces the likelihood of warranty and rework
- Lightweight aluminum construction and smooth reset action of the tools increase production efficiency by reducing operator fatigue
- High quality, robust construction
- Versatile tools ideal for a wide range of applications, with wide torque range and one way slipping action
- ISO 6789 Class 2F
- ±6% accuracy
- Supplied with pack of four interchangeable colored end caps (ASG #015999) to allow easy identification of what tool is set to what torque value (0022 models excluded) — End Cap Colors: Blue, Green, Red, Yellow
- Clockwise and counter-clockwise IFR models available, contact ASG for additional information

TLS Preset Clean Room Torque Screwdrivers

Designed specifically for use in clean rooms to protect precision products from contamination during assembly utilizing PTFE impregnated sealed anodized aluminum handles. External steel components are either high grade stainless steel or coated to inhibit corrosion.

- Unique slipping mechanism prevents under and over tightening
- Easy to use
- Increased operator comfort from the soft reset action of the tool
- T-Bar supplied with CRS 100-1360 FH



CRS 100-0135 FH and CRS 100-0022 FH



TLS 0022 Micro and
TLS 0022 FH



Standard TLS FH



TLS 1360 FH

GEDORE Torque Screwdrivers

Preset Torque Screwdrivers

TLS Preset Torque Screwdriver (Continued)

ASG Number	Model Number	Torque Range		Drive Type	Color	Previous Male SD Number*
		Metric	Imperial			
0022 Micro						
015000	TLS 0022 Micro FH	4-22 cN.m	5.7-32 ozf.in	1/4" Female Hex	Blue	—
3111636	TLS 0022 Micro - Red	4-22 cN.m	5.7-32 ozf.in	1/4" Female Hex	Red	—
015080	TLS 0022 FH	2-22 cN.m	2.8-32 ozf.in	1/4" Female Hex	Blue	—
3111652	TLS 0022 - Green	2-22 cN.m	2.8-32 ozf.in	1/4" Female Hex	Green	—
3111644	TLS 0022 - Gold	2-22 cN.m	2.8-32 ozf.in	1/4" Female Hex	Gold	—
015085	TLS 0022 FH O/W	2-22 cN.m	2.8-32 ozf.in	1/4" Female Hex	Blue	—
Minor						
015200	Minor FH	14-135 cN.m	1.2-12 lbf.in	1/4" Female Hex	Blue	015100
015205	Minor FH O/W	14-135 cN.m	1.2-12 lbf.in	1/4" Female Hex	Blue	015205
015215	IFR MINOR FH - Blue	14-135 cN.m	1.2-12 lbf.in	1/4" Female Hex	Blue	—
015220	Minor FH - Green	14-135 cN.m	1.2-12 lbf.in	1/4" Female Hex	Green	015120
015240	Minor FH - Red	14-135 cN.m	1.2-12 lbf.in	1/4" Female Hex	Red	015140
015260	Minor FH - Gold	14-135 cN.m	1.2-12 lbf.in	1/4" Female Hex	Gold	015160
Standard						
015600	Standard FH	50-400 cN.m	4.4-36 lbf.in	1/4" Female Hex	Blue	015500
015605	Standard FH O/W	50-400 cN.m	4.4-36 lbf.in	1/4" Female Hex	Blue	015505
015615	IFR STD BLUE FH	50-400 cN.m	4.4-36 lbf.in	1/4" Female Hex	Blue	—
015620	Standard FH - Green	50-400 cN.m	4.4-36 lbf.in	1/4" Female Hex	Green	015520
015640	Standard FH - Red	50-400 cN.m	4.4-36 lbf.in	1/4" Female Hex	Red	015540
015660	Standard FH - Gold	50-400 cN.m	4.4-36 lbf.in	1/4" Female Hex	Gold	015560
TLS 1360						
015890	TLS 1360 FH	2.5-13.6 N.m	22-120 lbf.in	1/4" Female Hex	Blue	015840
015895	TLS 1360 FH O/W	2.5-13.6 N.m	22-120 lbf.in	1/4" Female Hex	Blue	015845
015860	TLS1360 FH Green	2.5-13.6 N.m	22-120 lbf.in	1/4" Female Hex	Green	015810
015870	TLS1360 FH Red	2.5-13.6 N.m	22-120 lbf.in	1/4" Female Hex	Red	015820
015920	TLS 1360 FH Black	2.5-13.6 N.m	22-120 lbf.in	1/4" Female Hex	Black	015900
TLS Cleanrom Certified						
015089	CRS 100-0022 FH	2-22 cN.m	6-32 ozf.in	1/4" Female Hex	Grey	—
015209	CRS 100-0135 FH	14-135 cN.m	0.9-12 lbf.in	1/4" Female Hex	Grey	—
015609	CRS 100-0406 FH	50-400 cN.m	4.4-36 lbf.in	1/4" Female Hex	Grey	—
015939	CRS 100-1360 FH	2.5-13.6 N.m	22-120 lbf.in	1/4" Female Hex	Grey	—

* NOTE: For reference only. All screwdrivers are 1/4" Female Hex and are supplied with a quick converter adapter to 1/4" Male Square Drive (0022 models excluded).

GEDORE Torque Screwdrivers

Adjustable Torque Screwdrivers

Ergo Quickset Adjustable Torque Screwdrivers

Ergo quickset adjustable torque screwdrivers are calibrated scale tools that can be used for the accurate and consistent application of torque in manufacturing, engineering, or servicing environment. They are EPA compliant and ergonomically designed for enhanced operator comfort. Their adjustability and wide range of torque make them suitable for a broad range of applications.



QSN 120 FH



QSN 600 FH



- Unique slipping technology prevents under and over tightening
- Easy to use
- A visible scale allows the user to adjust the tool to their desired torque setting, enabling a range of different torque settings to be applied
- Fast and accurate to set, using the quick and clear to read micrometer style setting scale with unique locking feature
- EPA compliant, ideal for safe electronic component assembly
- Smooth reset action and ergonomic handle design provides operator comfort
- High quality, robust construction
- Optional lock on T-Bar (ASG #P29530)



Optional Lock On T-Bar (ASG #P29530)

ASG Number	Model Number	Torque Range		Scale Graduations		Drive Type	Accuracy	ISO 6789 Class	EPA Compliant
		Metric	Imperial	Metric	Imperial				
060700	QSN 40 FH	8-40 cN.m		1 cN.m		1/4" Female Hex	±6%	2D	Yes
060740	QSA 60 FH		12-60 ozf.in		1 ozf.in	1/4" Female Hex	±6%	2D	Yes
060720	QSA 4 FH		0.8-4 lbf.in		0.1 lbf.in	1/4" Female Hex	±6%	2D	Yes
060100	QSN 120 FH	20-120 cN.m		1 cN.m		1/4" Female Hex	±6%	2D	Yes
060140	QSA 160 FH		20-160 ozf.in		1 ozf.in	1/4" Female Hex	±6%	2D	Yes
060120	QSA 12 FH		2-12 lbf.in		0.1 lbf.in	1/4" Female Hex	±6%	2D	Yes
060300	QSN 600 FH	1-6 N.m		0.1 N.m		1/4" Female Hex	±6%	2D	Yes
060320	QSA 50 FH		10-50 lbf.in		1 lbf.in	1/4" Female Hex	±6%	2D	Yes
060500	QSN 900 FH	4-9 N.m		0.1 N.m		1/4" Female Hex	±6%	2D	Yes
060520	QSA 80 FH		30-80 lbf.in		1 lbf.in	1/4" Female Hex	±6%	2D	Yes

GEDORE Torque Screwdrivers

Adjustable Torque Screwdrivers

Quickset Adjustable Torque Screwdrivers



Quickset 6 FH



Quickset adjustable torque screwdrivers are calibrated scale tools that can be used for the accurate and consistent application of torque in manufacturing, engineering, or servicing environments. Their adjustability and wide range of torque make them suitable for a broad range of applications.

- Unique slipping technology prevents under and over tightening
- A visible scale allows the user to adjust the tool to their desired torque setting, enabling a range of different torque settings to be applied
- Fast and accurate to set using the quick and clear to read micrometer style setting scale
- Smooth reset action and ergonomic handle design provides operator comfort
- High quality, robust construction
- Dual scale quickset screwdrivers available
- Optional lock on T-Bar (ASG #P29530)

ASG Number	Model Number	Torque Range		Scale Graduations		Drive Type	Accuracy	ISO 6789 Class	EPA Compliant
		Metric	Imperial	Metric	Imperial				
016040	Quickset Minor Metric FH	20-120 cN.m		1 cN.m		1/4" Female Hex	±6%	2D	No
016060	Quickset Minor Imp FH		20-120 ozf.in		1 ozf.in	1/4" Female Hex	±6%	2D	No
016070	Quickset Minor lbf.in FH		2-12 lbf.in		0.1 lbf.in	1/4" Female Hex	±6%	2D	No
016500	Quickset 6 FH	1-6 N.m		0.1 N.m		1/4" Female Hex	±6%	2D	No
016600	Quickset 50 FH		5-50 lbf.in		1 lbf.in	1/4" Female Hex	±6%	2D	No
016700	Quickset 9 FH	4-9 N.m		0.1 N.m		1/4" Female Hex	±6%	2D	No
016800	Quickset 80 FH		30-80 lbf.in		1 lbf.in	1/4" Female Hex	±6%	2D	No
016011	Quickset Minor DS - Dual Scale	20-120 cN.m	20-120 ozf.in	1 cN.m	1 ozf.in	1/4" Female Hex	±6%	2D	No
016550	Quickset 6 DS - Dual Scale	1-6 N.m	5-50 lbf.in	0.1 N.m	1 lbf.in	1/4" Female Hex	±6%	2D	No

GEDORE Torque Screwdrivers

Dial Measuring Torque Screwdrivers

TT Dial Measuring Torque Screwdrivers



TT 100 FH



The dial measuring torque screwdriver is designed for torque evaluation and torque verification in order to ensure process conformity, product safety, and absolute reliability. These low cost and versatile tools provide accuracy, reliability, and economy in a wide range of maintenance and repair, quality control, research and development, and assembly operations in engineering or manufacturing environments.

- Unique torsion bar mechanism to ensure total precision
- Dial provides efficient measurement in metric and imperial torque units in both directions, delivering flexibility and minimizing tool investment
- Unique memory function enables these tools to carry out the break loose quality auditing test
- Overload protection system with unique positive contact mechanism reduces risk of tool damage
- Torque can be measured as it is applied (track mode) or when the maximum torque value has been recorded (peak mode)

ASG Number	Model Number	Torque Range		Scale Graduations		Drive Type	Accuracy	ISO 6789 Class	EPA Compliant
		Metric	Imperial	Metric	Imperial				
017400	TT 50 FH	10-50 cN.m	14-70 ozf.in	2 cN.m	2 ozf.in	1/4" Female Hex	±6%	1D	Yes
017500	TT 100 FH	20-100 cN.m	28-140 ozf.in	4 cN.m	4 ozf.in	1/4" Female Hex	±6%	1D	Yes
017600	TT 250 FH	50-250 cN.m	4-20 lbf.in	10 cN.m	0.5 lbf.in	1/4" Female Hex	±6%	1D	Yes
017700	TT 500 FH	100-500 cN.m	8-40 lbf.in	20 cN.m	1 lbf.in	1/4" Female Hex	±6%	1D	Yes

Section 3: Other GEDORE Torque Tools

RTU Dynamic Torque Limiters

RTU dynamic torque limiters allow conventional hand and power tools to be easily converted into versatile pre-set torque tools, giving reliable torque limited fastening to joints. Rotary torque units (RTU) proved a wide range of potential applications where conventional torque screwdrivers or wrenches might not be appropriate. They are well suited for manufacturing industries as they offer accuracy and repeatability.



RTU 14



RTU 1

- Unique slipping technology prevents under and over tightening
- Easy to use - simply install the RTU to the end of a traditional power tool or hand tool converting it to a torque tool
- Range of heavy duty torque limiters creates tools that are suitable for any occasion
- Powered assembly applications can be performed accurately and quickly, including tightening of bottles, caps, and lids
- ISO 6789 Class 2F
- $\pm 6\%$ accuracy

ASG Number	Model Number	Torque Range		Input Drive Type	Output Drive Type	Speed
		Metric	Imperial			
018100	RTU 170	20-170 cN.m	1.8-15 lbf.in	3/8" Female Square	3/8" Male Square	0-500 RPM
018120	RTU 170 HEX	20-170 cN.m	1.8-15 lbf.in	1/4" Male Hex	1/4" Female Hex	0-500 RPM
018200	RTU 450	1-4.5 N.m	9-40 lbf.in	3/8" Female Square	3/8" Male Square	0-500 RPM
018220	RTU 450 HEX	1-4.5 N.m	9-40 lbf.in	1/4" Male Hex	1/4" Female Hex	0-500 RPM
018300	RTU 1000	4-10 N.m	36-88 lbf.in	3/8" Female Square	3/8" Male Square	0-250 RPM
018320	RTU 1000 HEX	4-10 N.m	36-88 lbf.in	1/4" Male Hex	1/4" Female Hex	0-250 RPM
019100	RTU 1	0.1-1 N.m	0.9-8.8 lbf.in	3/8" Female Square, 1/4" Male Hex	1/4" Male Square, 1/4" Female Hex	0-500 RPM
019200	RTU 4	0.6-4.5 N.m	5.5-39.8 lbf.in	3/8" Female Square, 1/4" Male Hex	1/4" Male Square, 1/4" Female Hex	0-500 RPM
019400	RTU 14	2-14 N.m	18-123.8 lbf.in	3/8" Female Square, 1/4" Male Hex	1/4" Male Square, 1/4" Female Hex	0-125 RPM



Other GEDORE Torque Tools

Weld Stud Test Tools

Weld stud test tools are used during the production of sheet metal products. They are designed for a quick and easy controlled test of the strength and integrity of welds holding threaded welding studs onto sheet metal. They are most often used for quality control in the automotive and appliance industries.



WSTT 20



WSTT 10

- Enable quick go/no go tests for weld study integrity to be carried out quickly and efficiently
- Unique breaking technology reduces risk of damage to the fastener
- Intuitive and bi-directional T-shaped handle for easy operation
- Range of interchangeable end fittings available
- High quality, robust design
- All WSTT tools are supplied with a calibration certificate when ordered with an attached end fitting
- Calibration Adapter (ASG #A25880) is compatible with all WSTT models
- Metric and imperial end fittings available

ASG Number	Model Number	Torque Range		Weight		Length	
		Metric	Imperial	kg	lb.	mm	in.
055005	WSTT 2	0.4-2.0 N.m	3.5-18 lbf.in	0.215	0.5	120	4.7
055000	WSTT 10	1-10 N.m	9-90 lbf.in	0.215	0.5	120	4.7
055010	WSTT 20	4-20 N.m	35-180 lbf.in	0.32	0.7	220	8.7

WSTT Metric End Fittings

ASG Number	Weld Stud Thread x Max. Length	Use With
055020	M2.5 x 25	WSTT 10
055025	M3 x 50	WSTT 10
055030	M4 x 50	WSTT 10
055035	M5 x 50	WSTT 10
055040	M6 x 50	WSTT 10
055045	M8 x 50	WSTT 10
055050	M5 x 50	WSTT 20
055055	M6 x 50	WSTT 20
055060	M8 x 50	WSTT 20
055065	M10 x 75	WSTT 20
055070	M12 x 75	WSTT 20

WSTT Imperial End Fittings

ASG Number	Weld Stud Thread x Max. Length	Use With
055075	4-40 x 1.5"	WSTT 10
055080	6-32 x 2"	WSTT 10
055085	8-32 x 2"	WSTT 10
055090	10-32 x 2.5"	WSTT 10
055095	10-24 x 2.5"	WSTT 10
055100	1/4-20 x 4"	WSTT 10
055105	10-32 x 2.5"	WSTT 20
055110	10-24 x 2.5"	WSTT 20
055115	1/4-20 x 4"	WSTT 20
055120	5/16-18 x 4"	WSTT 20
055125	3/8-16 x 4"	WSTT 20

Section 4: GEDORE Torque Multipliers

Torque Multipliers



LDA Series

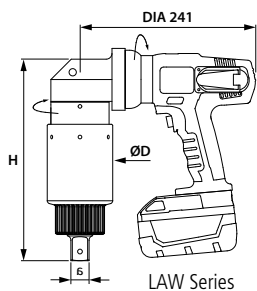

LAW Series

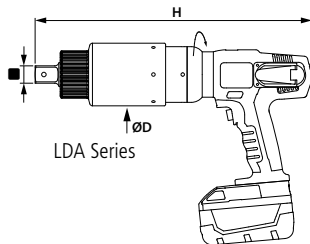

LDA Series

LDA/LAW Series Cordless Torque Wrench

The Gedore high-torque cordless torque wrench delivers accurate torque, wherever you need it. This powerful tool is capable of generating precise torque up to 6,000 N.m without slip coupling and impact mechanism. The powerful lithium ion battery means that the tool can be used independently and flexibly at great heights or in confined spaces. The Gedore cordless torque wrench is available as straight (LDA series) or angled (LAW series).

- Built to a high standard of precision to ensure accurate and consistent torque
- Powerful lithium ion batteries, operate with uniform peak performance until they are fully discharged
- Ergonomic soft grip, non-slip and fatigue free handle
- Battery can be inserted from two sides
- Braking 360° rotating drive unit with fixed arm provides safety to the operator when used in confined spaces
- Patented microprocessor electronics increase and regulate the battery voltage. This increases the running time of the battery and maintains the torque at a constant level
- Microprocessor prevents gear damage when loosening hard bolted connections. An active release function ensures that the wrench automatically releases after work is complete.
- Supplied with: reaction arm, 3x lithium ion battery, charger, tool box, operating manual, tool box, factory calibration certificate

ASG Number	Model Number	Torque Range		Max. RPM	Drive Type	D		H		Weight	
		Metric	Imperial			mm	in.	mm	in.	kg	lb.
LDA Series – Straight											
39100.000	LDA-05	90-500 N.m	60-370 lbf.ft	46	3/4" Male Square	80	3.1	255	10.0	3.3	7.3
39140.000	LDA-07	120-700 N.m	80-520 lbf.ft	29	3/4" Male Square	80	3.1	287	11.3	3.9	8.6
39190.000	LDA-12	200-1200 N.m	150-890 lbf.ft	20	3/4" Male Square	80	3.1	287	11.3	3.9	8.6
39250.000	LDA-15	250-1500 N.m	180-1110 lbf.ft	15	1" Male Square	88	3.5	303	11.9	5.0	11.0
39350.000	LDA-22	300-2200 N.m	220-1630 lbf.ft	10	1" Male Square	90	3.5	321	12.6	5.6	12.3
39450.000	LDA-32	400-3200 N.m	290-2360 lbf.ft	7	1" Male Square	88	3.5	344	13.5	6.1	13.4
39500.000	LDA-40	500-4000 N.m	370-2950 lbf.ft	5.5	1" Male Square	88	3.5	344	13.5	6.1	13.4
39550.000	LDA-60	700-6000 N.m	510-4430 lbf.ft	3.5	1.5" Male Square	102	4	359	14.1	7.8	17.2
LAW Series – Angled											
39191.000	LAW-12	200-1200 N.m	150-890 lbf.ft	20	3/4" Male Square	80	3.1	223	8.8	5.2	11.5
39361.000	LAW-22	300-2200 N.m	220-1630 lbf.ft	10	1" Male Square	90	3.5	255	10.0	6.9	15.2
39461.000	LAW-32	450-3200 N.m	340-2360 lbf.ft	7	1" Male Square	88	3.5	279	11.0	7.3	16.1
39561.000	LAW-40	500-4000 N.m	370-2950 lbf.ft	5.5	1" Male Square	88	3.5	279	11.0	7.3	16.1

NOTE: Min Torque is in second gear, max torque is in first gear. Weight does not include battery (740g/1.6lb)

GEDORE Torque Multipliers

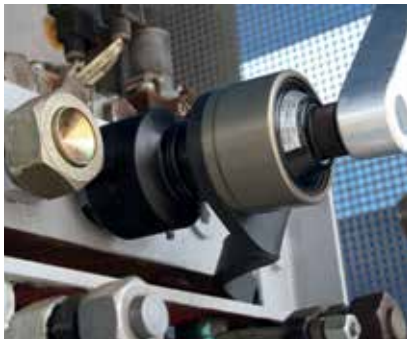

DVV/DVI Series Torque Multipliers

Gedore Torque DVV/DVI series of torque multipliers enables existing torque wrenches to deliver a much wider range of torque output, accurately and consistently. With a DVV/DVI torque multiplier, a single torque tool can be used for a greater number of applications. For the user, this means greater flexibility, fewer tools to carry around, and enhanced capabilities from smaller and lighter tools. For your company, this means increased efficiency and reduced inventory costs.

- For use with a torque wrench
- Mechanical hand torque multiplier for controlled screw tightening and loosening screw connections
- Planet gear
- RS models have anti-wind-up ratchet
- High performance aluminum housing
- $\pm 3\%$ accuracy
- Output square with drill hole for impact sockets with safety pin and ring
- DVV-540RS model equipped with fixture for welding on a reaction arm
- DVV models: Z-form offset reaction arm depending on model made of chrome-vanadium steel
- DVV models only: Non-destructive “slipper” overload safety mechanism for gear protection – clockwise and counter-clockwise; Can be optionally retrofitted with L-form straight reaction arm with adjustable reaction arm of lightweight metal
- DVI-Z models: Z form, offset reaction arm of chrome vanadium steel;
DVI-L models: L form straight reaction arm with adjustable reaction square, of lightweight metal

ASG Number	Model Number	Max. Input Torque		Output Torque Range		Ratio	Input Drive Type	Output Drive Type
		Metric	Imperial	Metric	Imperial			
2653087	DVV-40Z	300 N.m	220 lbf.ft	500-4000 N.m	400-2930 lbf.ft	1:16	1/2" Female Square	1" Male Square
2653109	DVV-40ZRS	310 N.m	230 lbf.ft	500-4000 N.m	400-2930 lbf.ft	1:16	1/2" Female Square	1" Male Square
2653117	DVV-60ZRS	400 N.m	300 lbf.ft	650-6000 N.m	500-4400 lbf.ft	1:18	3/4" Female Square	1.5" Male Square
2653125	DVV-80ZRS	420 N.m	310 lbf.ft	800-8000 N.m	600-5870 lbf.ft	1:22	3/4" Female Square	1.5" Male Square
2653133	DVV-100ZRS	410 N.m	305 lbf.ft	1000-10000 N.m	700-7330 lbf.ft	1:28.5	3/4" Female Square	1.5" Male Square
2653141	DVV-130ZRS	380 N.m	280 lbf.ft	1320-13000 N.m	1000-9530 lbf.ft	1:39	3/4" Female Square	1.5" Male Square
2653168	DVV-540RS	380 N.m	280 lbf.ft	5500-54000 N.m	4000-40330 lbf.ft	1:175	3/4" Female Square	2.5" Male Square
2653370	DVV-13Z	270 N.m	200 lbf.ft	50-1300 N.m	40-950 lbf.ft	1:5	1/2" Female Square	3/4" Male Square
2653249	DVI-20L	580 N.m	430 lbf.ft	100-2000 N.m	70-1500 lbf.ft	1:4	3/4" Female Square	1" Male Square
2653265	DVI-20Z	580 N.m	430 lbf.ft	100-2000 N.m	70-1500 lbf.ft	1:4	3/4" Female Square	1" Male Square
2653257	DVI-28L	550 N.m	410 lbf.ft	500-2800 N.m	400-2050 lbf.ft	1:5.5	3/4" Female Square	1" Male Square
2653273	DVI-28Z	550 N.m	410 lbf.ft	500-2800 N.m	400-2050 lbf.ft	1:5.5	3/4" Female Square	1" Male Square

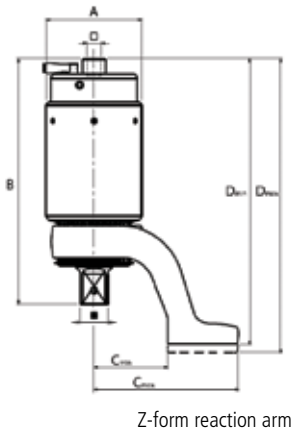

Z-form reaction arm

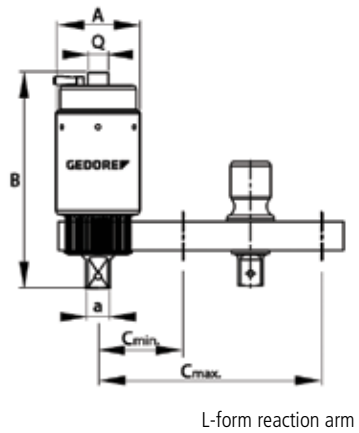

L-form reaction arm

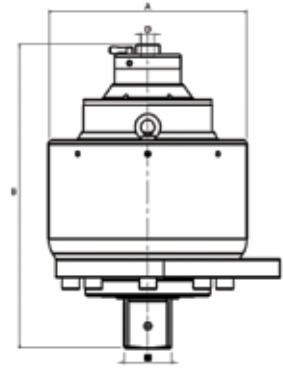

DVV-540RS

	A		B		Cmin		Cmax		Dmin		Dmax		Weight	
	mm	in.	mm	in.	mm	in.	mm	in.	mm	in.	mm	in.	kg	lb.
	ø88	ø3.5	212	8.3	71	2.8	136	5.4	250	9.8	256	10.1	5.4	11.9
	ø88	ø3.5	227	8.9	71	2.8	136	5.4	264	10.4	270	10.6	5.7	12.6
	ø102	ø4	257	10.1	110	4.3	190	7.5	316	12.4	324	12.8	10.5	23.1
	ø128	ø5	277	10.9	110	4.3	190	7.5	338	13.3	342	13.4	13.4	29.5
	ø142	ø5.6	292	11.5	120	4.7	216	8.5	350	13.8	356	14.0	13.9	30.6
	ø175	ø6.9	306	12	126	5.0	229	9.0	372	14.6	379	14.9	20.9	46.1
	ø270	ø10.6	415	16.3	—	—	—	—	—	—	—	—	64.6	142.4
	ø80	ø3.1	133	5.2	56	2.2	95	3.7	165	6.5	173	6.8	1.9	4.2
	ø88	ø3.5	131	5.2	73	2.9	152	6.0	—	—	—	—	3.0	6.6
	ø88	ø3.5	131	5.2	100	3.9	150	5.9	—	—	—	—	2.9	6.4
	ø106	ø4.2	146	5.7	83	3.3	199	7.8	—	—	—	—	4.1	9.0
	ø106	ø4.2	146	5.7	100	3.9	150	5.9	—	—	—	—	3.9	8.6

Section 5: GEDORE Torque Accessories

Torque Wrench End Fittings: Captive Pin

Metric and imperial accessories compatible with TBN preset breaking torque wrenches, models TBN 2 and TBN 10.

- Ring end supplied as bi-hex or 6pt hex
- Setting Adapter: 1/4" Square drive for use with calibration analyzers. Maximum torque of setting adapters is 25 N.m



Open End



Ring End



Flared End



Setting Adapter

Metric End Fittings

Size	ASG Number			
	Open End	Ring End	Flared End	Setting Adapter
3.2 mm	012000	012250	—	012700
4 mm	012005	012255	—	012700
5 mm	012010	012260	—	012700
5.5 mm	012015	012265	—	012700
6 mm	012020	012270	—	012705
7 mm	012025	012275	—	012705
8 mm	012030	012280	012505	012705
9 mm	012035	012285	012510	012705
10 mm	012040	012290	012515	012710
11 mm	012045	012295	012520	012710
12 mm	012050	012300	012525	012710
13 mm	012055	012305	012530	012710
14 mm	012060	012310	012535	012715
15 mm	012065	012315	012540	012715
16 mm	012070	012320	012545	012715
17 mm	012075	012325	012550	012715
18 mm	012080	012330	—	012720
19 mm	012085	012335	012555	012720
20 mm	012090	012340	—	012720
21 mm	012095	012345	—	012720
22 mm	012100	012350	012560	012722
23 mm	012105	012355	—	012722
24 mm	012110	012360	012565	012722
25 mm	012115	012365	—	012722

Imperial End Fittings

Size	ASG Number			
	Open End	Ring End	Flared End	Setting Adapter
5/32"	012150	012400	—	012725
3/16"	012155	012405	—	012725
7/32"	012160	012410	—	012725
1/4"	012165	012415	012600	012725
5/16"	012175	012420	012605	012730
3/8"	012185	012425	012610	012730
7/16"	012195	012430	012615	012730
1/2"	012200	012435	012620	012730
9/16"	012205	012440	012625	012735
5/8"	012210	012445	012630	012735
11/16"	012215	012450	—	012735
3/4"	012220	012455	012635	012735
13/16"	012225	012460	—	012740
7/8"	012230	012465	012640	012740
15/16"	012235	012470	—	012740
1"	012240	012475	012645	012740

GEDORE Torque Accessories

Torque Wrench End Fittings: Captive Pin (Continued)

Convert TBN 2 and 10 to 1/4" Square Drive



ASG Number	Type	Center
A36340	1/4" Fixed	27mm
A73640	1/4" Ratchet	27 mm

Hex Key Adapters and Hex Key Setting Adapters



ASG Number	Hex Key Sizes	Type
A37610	1.0-2.5mm	Adapter
A37620	3.0-5.0mm	Adapter
A38350	6.0-8.0mm	Adapter
A45271	1.0-2.5mm	Setting Adapter
A45272	3.0-5.0mm	Setting Adapter
A45273	6.0-8.0mm	Setting Adapter

Blank End (for making specials)



ASG Number	Center
A64440	12mm
A64450	34mm

GEDORE Torque Accessories

Torque Wrench End Fittings: 8mm Spigot Type

Metric and imperial accessories compatible with ATB Adjustable Breaking Torque Wrenches, models ATB 2.5, ATB 5, and ATB 10

- Ring end supplied as bi-hex or 6pt hex



Open End



Ring End



Flared End

Metric End Fittings

Size	ASG Number		
	Open End	Ring End	Flared End
3.2 mm	049000	049250	—
4 mm	049005	049255	—
5 mm	049010	049260	—
5.5 mm	049015	049265	—
6 mm	049020	049270	—
7 mm	049025	049275	—
8 mm	049030	049280	049505
9 mm	049035	049285	049510
10 mm	049040	049290	049515
11 mm	049045	049295	049520
12 mm	049050	049300	049525
13 mm	049055	049305	049530
14 mm	049060	049310	049535
15 mm	049065	049315	049540
16 mm	049070	049320	049545
17 mm	049075	049325	049550
18 mm	049080	049330	—
19 mm	049085	049335	049555
20 mm	049090	049340	—
21 mm	049095	049345	—
22 mm	049100	049350	049560
23 mm	049105	049355	—
24 mm	049110	049360	049565
25 mm	049115	049365	—

Imperial End Fittings

Size	ASG Number		
	Open End	Ring End	Flared End
5/32"	049150	049400	—
3/16"	049155	049405	—
7/32"	049160	049410	—
1/4"	049165	049415	049600
5/16"	049175	049420	049605
3/8"	049185	049425	049610
7/16"	049195	049430	049615
1/2"	049200	049435	049620
9/16"	049205	049440	049625
5/8"	049210	049445	049630
11/16"	049215	049450	—
3/4"	049220	049455	049635
13/16"	049225	049460	—
7/8"	049230	049465	049640
15/16"	049235	049470	—
1"	049240	049475	049645

Convert 8mm Spigot Type to 1/4" Square Drive



ASG Number	Type	Center
A29071	1/4" Fixed	25mm
A28990	1/4" Ratchet	25mm

GEDORE Torque Accessories

Torque Wrench End Fittings: 16mm Spigot Type

Metric and imperial accessories compatible with:

- TBN Preset Breaking Torque Wrenches, models TBN 25, TBN 65, TBN 135, and TBN 200
- Torcofix Adjustable Clicker Torque Wrenches (Torcofix Z models)



Open End



Ring End



Flared End

Metric End Fittings

Size	ASG Number		
	Open End	Ring End	Flared End
7 mm	026020	027220	028190
8 mm	026040	027240	028200
9 mm	026060	027260	028210
10 mm	026080	027280	028220
11 mm	026100	027300	028240
12 mm	026120	027320	028260
13 mm	026140	027340	028280
14 mm	026160	027360	028300
15 mm	026180	027380	028320
16 mm	026200	027400	028340
17 mm	026220	027420	028360
18 mm	026240	027440	028380
19 mm	026260	027460	028400
20 mm	026280	027480	028420
21 mm	026300	027500	028440
22 mm	026320	027520	028460
23 mm	026340	027540	028480
24 mm	026360	027560	028500
25 mm	026380	—	—
26 mm	026400	027600	—
27 mm	026420	027620	028520
30 mm	026440	—	—
32 mm	026460	—	—

Imperial End Fittings

Size	ASG Number		
	Open End	Ring End	Flared End
5/16"	026620	027720	—
3/8"	026640	027740	028600
7/16"	026650	027750	028620
1/2"	026660	027760	028640
9/16"	026680	027780	028660
5/8"	026690	027790	028680
11/16"	026700	027800	028700
3/4"	026710	027810	028710
13/16"	026720	027820	028720
7/8"	026740	027840	028740
15/16"	026750	027850	028750
1"	026760	027860	028760
1-1/16"	026770	027880	028770
1-1/8"	026780	—	028780
1-3/16"	026800	027920	028800
1-1/4"	026820	—	—

GEDORE Torque Accessories

Torque Wrench End Fittings: 16mm Spigot Type (Continued)

Metric and imperial accessories compatible with:

- TBN Preset Breaking Torque Wrenches, models TBN 25, TBN 65, TBN 135, and TBN 200
- Torcofix Adjustable Clicker Torque Wrenches (Torcofix Z models)

Hex Key Adapters



ASG Number	Hex Key Sizes	Type
A38940	2.5-5.0mm	Adapter
A38950	6.0-8.0mm	Adapter

Convert 16mm Spigot Type to Square Drive



ASG Number	Type
029040	3/8" Fixed
029060	1/2" Fixed
029010	3/8" Ratchet
029030	1/2" Ratchet

Blank End



ASG Number	Type
A55230	Blank End

GEDORE Torque Accessories

Torque Wrench End Fittings: 9x12 Rectangular End Fittings

Metric and imperial accessories compatible with:

- Torcofix Production Clicker Torque Wrenches (Torcofix FS models)
- Torcofix Adjustable Clicker Torque Wrenches, models 25SE, 50SE, and 100SE
- TBN Preset Breaking Torque Wrenches, models 2G, 10G, 25G, 65G, and 135G
- Torcotronic 120 Digital Torque Wrench
- ATB Adjustable Breaking Torque Wrenches, models 2.5G, 5G, and 10G



Open End



Ring End



Flared End

Size	ASG Number		
	Open End	Ring End	Flared End
7 mm	7688390	7691340	—
8 mm	7688550	7691420	—
9 mm	7679050	—	—
10 mm	7688630	7691690	7685290
11 mm	7688980	7691770	7685370
12 mm	7679560	7677940	7699590
13 mm	7689010	7691930	7679210
14 mm	7689360	7692230	7679480
15 mm	7689440	7692580	—
16 mm	7679990	7678080	—
17 mm	7689600	7692740	7685880
18 mm	7684560	7678160	7679640
19 mm	7689790	7692820	7686260
20 mm	—	—	—
21 mm	—	7678240	—
22 mm	—	7693040	7679720

GEDORE Torque Accessories

Torque Wrench End Fittings: 9x12 Rectangular End Fittings (Continued)

Metric and imperial accessories compatible with:

- Torcofix Production Clicker Torque Wrenches (Torcofix FS models)
- Torcofix Adjustable Clicker Torque Wrenches, models 25SE, 50SE, and 100SE
- TBN Preset Breaking Torque Wrenches, models 2G, 10G, 25G, 65G, and 135G
- Torcotronic 120 Digital Torque Wrench
- ATB Adjustable Breaking Torque Wrenches, models 2.5G, 5G, and 10G

Reversible Ratchet Head and Fixed Square Head

ASG Number	Type
7672710	9x12 Rectangular — 1/4" Reversible Ratchet Head
7686500	9x12 Rectangular — 3/8" Reversible Ratchet Head
7687230	9x12 Rectangular — 1/2" Reversible Ratchet Head
7672630	9x12 Rectangular — 1/4" Fixed Head Square
7679800	9x12 Rectangular — 3/8" Fixed Head Square
7687900	9x12 Rectangular — 1/2" Fixed Head Square

Hexagon Nut Sockets

Metric and imperial accessories compatible with standard and insulated torque wrenches.

1/4" Square Drive Hexagon Nut Sockets

ASG Number	Type	Size
030500	NS 4	4mm
030520	NS 4.5	4.5mm
030540	NS 5	5mm
030560	NS 5.5	5.5mm
030580	NS 6	6mm
030600	NS 7	7mm
030620	NS 8	8mm
030640	NS 9	9mm
030660	NS 10	10mm
030680	NS 11	11mm
030700	NS 12	12mm
030720	NS 13	13mm
030740	NS 14	14mm

ASG Number	Type	Size
030800	NS 187	3/16"
030820	NS 219	7/32"
030900	NS 281	9/32"
030920	NS 312	5/16"
030940	NS 344	11/32"
030960	NS 375	3/8"
030980	NS 437	7/16"
031000	NS 500	1/2"



GEDORE Torque Accessories

Hexagon Nut Sockets (Continued)

Metric and imperial accessories compatible with standard and insulated torque wrenches.

1/4" Square Drive Metric Insulated Nut Sockets

ASG Number	Size
030620A11030	8mm
030660A11030	10mm
030700A11030	12mm
030720A11030	13mm
030740A11030	14mm

Torque Screwdriver Accessories

Metric and imperial accessories compatible with standard and insulated torque wrenches.

Special Crowsfoot Spanner Ends



ASG Number	Size
C62890	3/8"
C62891	1/2"
C62898	6mm
C62892	8mm

Lock on T-Bar



ASG Number
P29530

Screwdriver End Caps



ASG Number	For use with
015999	TLS Screwdriver Preset Screwdrivers (Except 0022 Series) End Cap Colors: ●●●●
065800	Pro, ESD Preset Screwdrivers End Cap Colors: ●●●●

Converters and Adapters For Screwdrivers

Inline Freewheel Adapter



Absorbs unwanted shock loads by transmitting torque in one direction and freewheeling in the opposite. Roller clutch for minimal backlash and drag. To convert drive tool to:

ASG Number	Model	Torque	Freewheel
A8842R	FWA-R	Clockwise	Counter-clockwise
A8422L	FWA-L	Counter-clockwise	Clockwise

GEDORE Torque Accessories

Converters and Adapters For Screwdrivers (Cont.)

Converters and Adapters

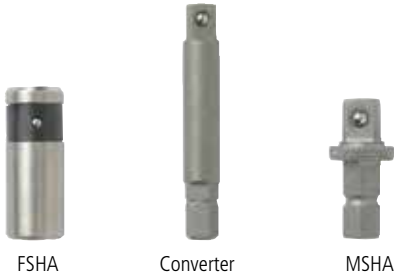

ASG Number	Model	Convert Drive From	Convert Drive To	Length
				mm
A35640	FSHA	1/4" Male Square	1/4" Female Hex	30
029200	Converter	1/4" Female Hex	1/4" Male Square	50
A25420	MSHA	1/4" Female Hex	1/4" Male Square	25

Converters and Adapters For Screwdrivers and Wrenches

Socket Blanks



Socket Blanks for manufacturing special extensions for use with square drive tools.

ASG Number	Type	Square Drive (A)	Diameter (B)	Length (C)
A15720	SB2	1/4	5/8	7/8
A16200	SB3	3/8	13/16	1 1/8
A16210	SB4	1/2	1	1 1/4
A14790	SB5	3/4	1 1/2	2 5/16
A14800	SB6	1	2	2 9/16

Converters



ASG Number	To Convert Drive Tool From	To Convert Drive Tool To
031320	1/4" Male Square	3/8" Male Square
031300	3/8" Male Square	1/4" Male Square
031340	3/8" Male Square	1/2" Male Square
031360	1/2" Male Square	3/8" Male Square
031380	1/2" Male Square	3/4" Male Square
031400	3/4" Male Square	1/2" Male Square
031420	3/4" Male Square	1" Male Square
031440	1" Male Square	3/4" Male Square

GEDORE Torque Accessories

Converters and Adapters For Screwdrivers and Wrenches (Continued)

Hexagon Key Bits

IB Bits will require 1/4" FSHA Adapter (ASG #A35640) unless your tool is already a 1/4" female hex drive. G Type bits are integral 1/4" square drive hex key adapter.

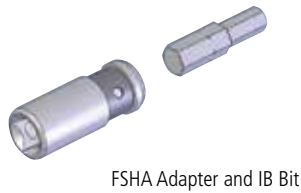

FSHA Adapter and IB Bit



G Type

ASG Number	Type	Size (A/F)	Length
			mm
030100	IB 1.5	1.5mm	25mm
030120	IB 2	2mm	25mm
030140	IB 2.5	2.5mm	25mm
030160	IB 3	3mm	25mm
030180	IB 4	4mm	25mm
030200	IB 5	5mm	25mm
030220	IB 6	6mm	25mm
030240	IB 7	7mm	25mm
030260	IB 8	8mm	25mm
030300	IB 093	3/32"	25mm
030310	IB 109	7/64"	25mm
030320	IB 125	1/8"	25mm
030330	IB 141	9/64"	25mm
030340	IB 156	5/32"	25mm
030360	IB 187	3/16"	25mm
030380	IB 281	7/32"	25mm
030400	IB 250	1/4"	25mm
030410	IB 312	5/16"	25mm
B1607A	G2	.035"	35mm
B1607B	G3	.050"	35mm
B1607C	G4	.062"	35mm
B1607D	G5	5/64"	35mm

GEDORE Torque Accessories

Special Extension Spanners and Adapters (Dial Measuring)

Special extension spanners can be manufactured when design or space limitations preclude the use of a dial measuring wrench and a standard nut socket. These allow access and enable you to apply torque in awkward spaces.



To Order a Special Extension Spanner, please provide the following information:

- Square drive size
- Centered distance between the square drive and the spanner end fitting
- A/F size of spanner end
- End type: ring, open, or flared
- Maximum torque to be applied
- Fully dimensional drawing

Example of a ring end type extension spanner

Effective Wrench Lengths Across our Range: Special extension spanners are not recommended for ADS 4 and 8.

Model Ranges	Effective Length
ADS 12/25/40	190
BDS 80	368
BDS 160/200	445
CDS	635
DDS	850
EDS	1727

Effective Adapters for ADS and BDS wrenches where space is restricted: Measure dimension of adapter and end fitting for E (see diagram below).

ASG Number	Adapter Model	Drive Type	
A96102	16mm Spigot	3/8" Female Square	
A96103	16mm Spigot	1/2" Female Square	
A96112	German 9x12	3/8" Female Square	
A96113	Cavity Fitting	1/2" Female Square	
A96122	Wedge Fitting	3/8" Female Square	
A96123	Wedge Fitting	1/2" Female Square	

How to Calculate the True Torque when using Extension Spanners

When using extension spanners, the dial reading will not display the correct torque being applied. To ensure true torque, see the diagram and formula.



$$\text{True Torque} = \frac{\text{DR} \times (\text{E} + \text{L})}{\text{L}}$$

GEDORE Torque Accessories

Torque Multiplier Accessories

Optional Accessories for DVV-40Z and DVV-40ZRS

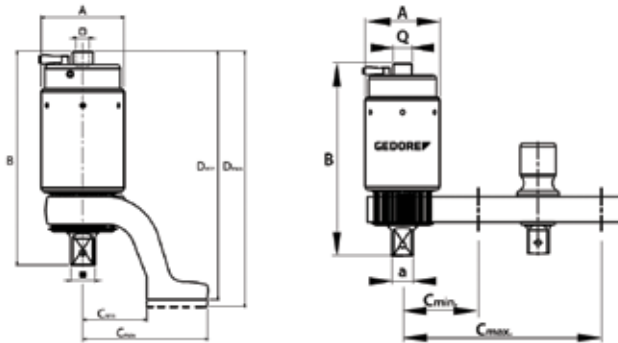

Model Number	ASG Number	Description	A		B		Cmin		Cmax	
			mm	in.	mm	in.	mm	in.	mm	in.
RZ-DVV40	2653176	Reaction arm Z-Form offset for DVV40	88	3.5	212	8.3	71	2.8	136	5.4
RL-DVV40	2653184	Reaction arm L-Form offset for DVV40, 1"	88	3.5	212	8.3	86	3.4	234	9.2

Optional Accessories for DVV-60ZRS, DVV-80ZRS, DVV-100ZRS, and DVV-130ZRS

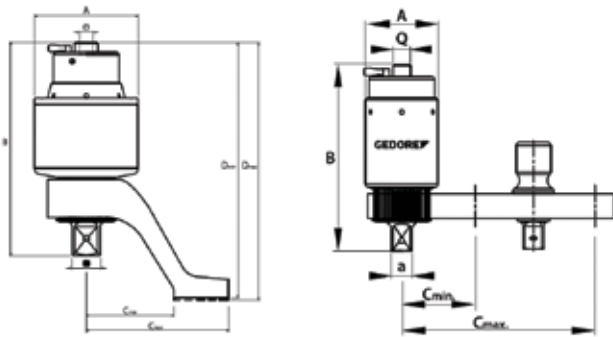

Model Number	ASG Number	Description	A		B		Cmin		Cmax	
			mm	in.	mm	in.	mm	in.	mm	in.
RZ-DVV60	2653192	Reaction arm Z-form offset for DVV60	102	4.01	257	10.1	110	4.3	190	7.5
RZ-DVV80	2653206	Reaction arm Z-form offset for DVV80	128	5.0	277	10.9	110	4.3	190	7.5
RZ-DVV100	2653222	Reaction arm Z-form offset for DVV100	142	5.6	242	9.5	120	4.7	216	8.5
RZ-DVV130	2653230	Reaction arm Z-form offset for DVV130	175	6.9	306	12.0	126	5.0	229	9.0
RZ-DVV60-80	2654091	Reaction arm L-form straight for DVV60-80, 1.5"	102/128	4.0/5.0	256.2/276.5	10.0/10.9	120/120	4.7/4.7	315/315	12.4/12.4

GEDORE Torque Accessories

Torque Multiplier Accessories (Continued)

Optional Accessories for DVV-13Z

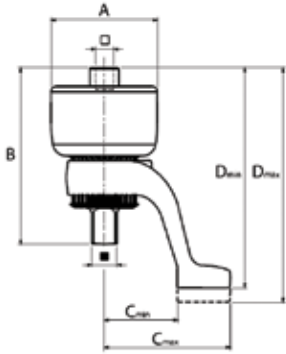

Model Number	ASG Number	Description	A		B		Cmin		Cmax	
			mm	in.	mm	in.	mm	in.	mm	in.
RL-DVV13	2653400	Reaction arm L-form straight for DVV-13, 3/4"	80	3.14	133	5.2	60	2.4	159	6.3
RZ-DVV13	2653397	Reaction arm L-form offset for DVV-13	80	3.14	133	5.2	56	2.2	95	3.7
E-S-DVV13	2684233	Sun gear for DVV-13	—	—	—	—	—	—	—	—

Optional Accessories for DVI-20L, DVI-20Z, DVI-28L, DVI-28Z

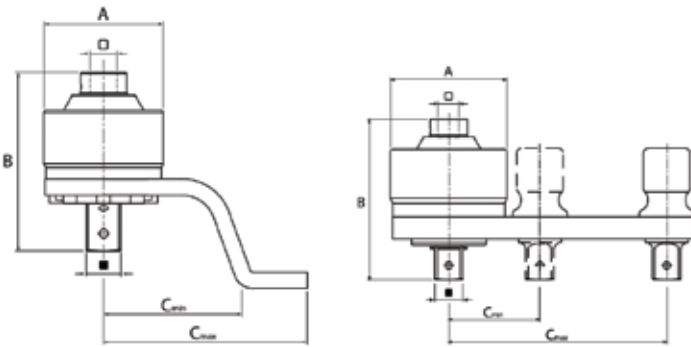

Model Number	ASG Number	Description
RZ-DVI20	2653281	Reaction arm Z-form offset for DVI20
RL-DVI20	2653303	Reaction arm L-form straight for DVI20, 1"
E-VKT-DVI20	2653346	Spare square 1" for DVI20
RZ-DVI28	2653311	Reaction arm Z-form offset for DVI28
RL-DVI28	2653338	Reaction arm L-form straight for DVI28, 1"
E-VKR-DVI28	2670526	Spare square 1" incl. ring for DVI28

Section 6: GEDORE Warranty and Calibration Information

GEDORE Warranty

GEDORE warrants to Customers who purchase a Product from the GEDORE catalogue, website or an authorized GEDORE dealer for use in their profession that the Product will be free from defects in workmanship and materials. GEDORE brand torque control tools are warranted for twenty-four (24) months from date of purchase and up to 5,000 torque cycles (where after GEDORE recommends re-calibration). Consumable Products are warranted only against defects in workmanship or materials that prevent their use. For purposes of this Warranty, Consumable Products are defined as those Products which are reasonably expected to be used up or damaged during use, including without limitation drill bits, saw and knife blades, grinding and sanding discs, knife blades, files, sensors and batteries.

This Warranty extends only to the original Customer and may not be transferred or assigned to any third party.

Service and Preventative Maintenance

At ASG, Division of Jergens, Inc., we strive to provide you with the best technical repair and calibration services as fast as possible. Our staff includes a team of experienced technicians who can provide service assistance with nearly any tool. We can repair products that we sell and calibrate most brands of torque meters and torque control screw drivers. Whether the need is repair, preventative maintenance, reconditioning or calibration and certification, ASG is committed to providing service to the highest quality standards.

In order to maintain optimal performance of your torque tools, ASG recommends that preventative maintenance tasks be carried out according to a regular schedule based upon monitoring the number of cycles per day along with the total number of hours that the tool is used. ASG offers full preventative maintenance services on all of our torque tools to help customers optimize tool performance and reduce unexpected downtime.

No matter what type of assembly is being manufactured, accurate torque measurement is essential to a quality product. ASG recommends that all torque products be calibrated on a regular basis to maintain quality operation and avoid unnecessary disruptions to your business. ASG offers calibration services, performed and traceable to NIST standards, and issues a paper Calibration Certificate.

ASG in-house technicians provide live technical and troubleshooting assistance from our Cleveland location at (888) 486-6163, Monday through Friday from 8 a.m. to 5 p.m. (Eastern) excluding holidays. The service department can also be reached via email at asginfo@asg-jergens.com.

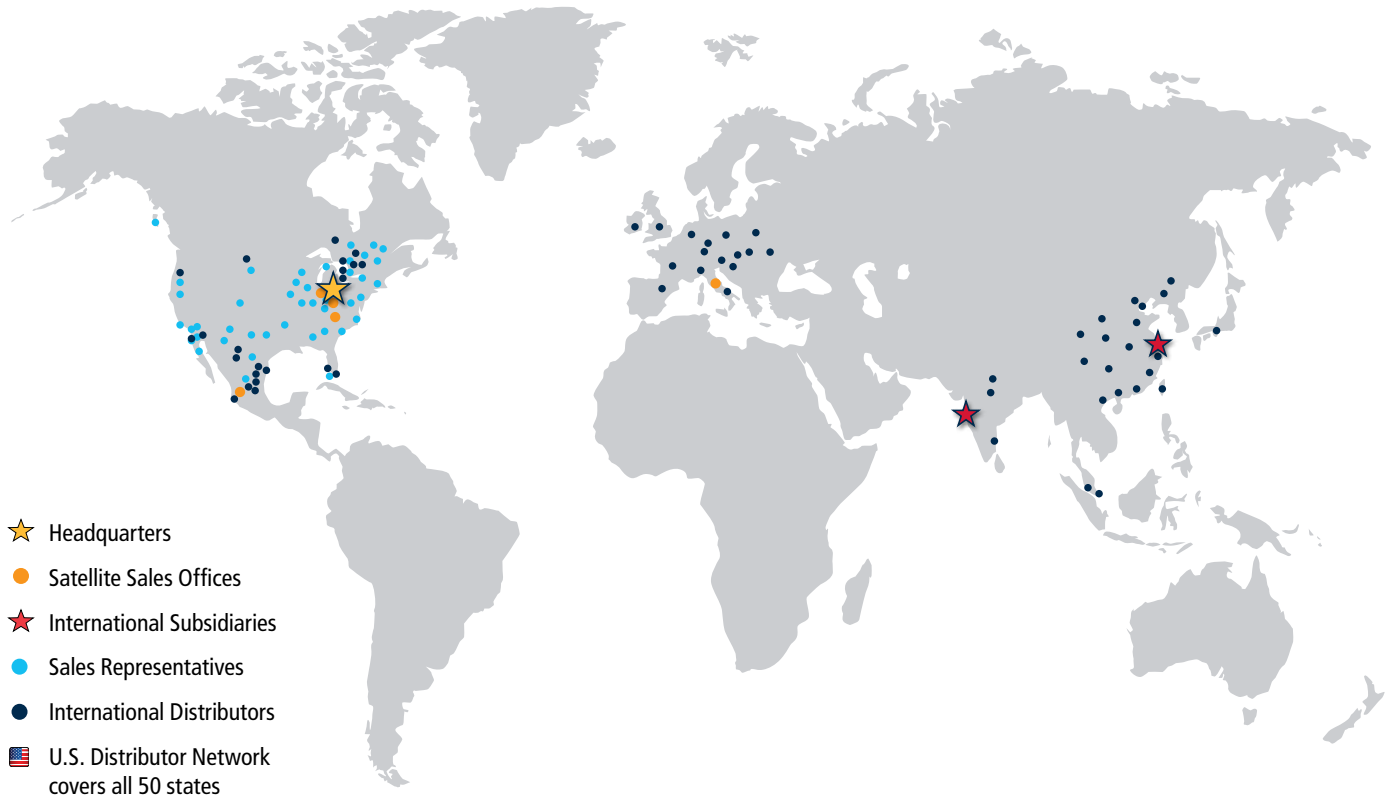

Global Support

Our footprint covers the globe!

ASG employs a team of technical experts to provide support, repair, calibration and preventative maintenance services. We welcome the opportunity to provide assistance by telephone or online chat Monday through Friday, 8 a.m. to 5 p.m. (U.S. Eastern Time) excluding holidays.

ASG maintains subsidiaries in Shanghai, China and Mumbai, India, and sales offices in Mexico and Europe to provide direct support to our international customers. We work together with our global Field Sales Representative and Distributor Network to help customers standardize their assembly equipment and processes around the world.

Distributor:



Products and Solutions for Assembly

January 2019

ASG USA Headquarters
 Jergens Way, 15700 S. Waterloo Road
 Cleveland, OH 44110-3898 USA
 Phone: (216) 486-6163
 Toll-free USA: (888) 486-6163
 Fax: (216) 481-4519
 Email: asginfo@asg-jergens.com

ASG China Subsidiary
 Unit 301 Level 3, Block A
 A-REIT City at Jinqiao, 200 Jinsu Road,
 Shanghai, Pudong 201206 CHINA
 Phone: +86 21 58209175
 Fax: +86 21 58353696
 Email: rafael.qi@asg-jergens.com

ASG India Subsidiary
 B-607, Mahaavir Icon,
 Plot No. 89, Sector 15, C.B.D. Belapur
 Navi Mumbai-400 614, Maharastra INDIA
 Phone: +91 22 27572998
 Mobile: +91 98 334 04986
 Email: jpk@asg-jergens.com