

5101TP-L/R & 5102TP Worktops for PD51 Station

This document shows how to **dismount existing worktop** and mount the optional 5101TP-L/R and 5102TP worktops on the PD51 Mobile Station. As well as how to **dismount the folding side shelf**.

Note: If you cannot understand these instructions or are concerned about safety of the installation contact a qualified contractor or contact AVFI at 1-877-834-3876

Tools required

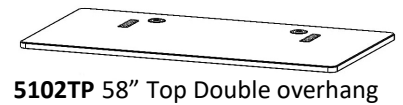
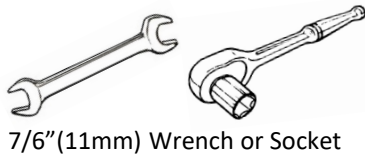

1 Dismount console by removing bolts from both sides.

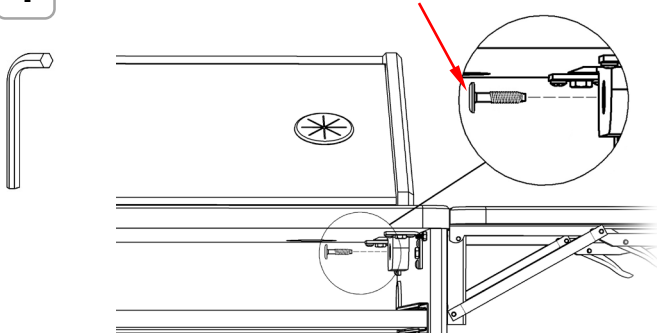

2

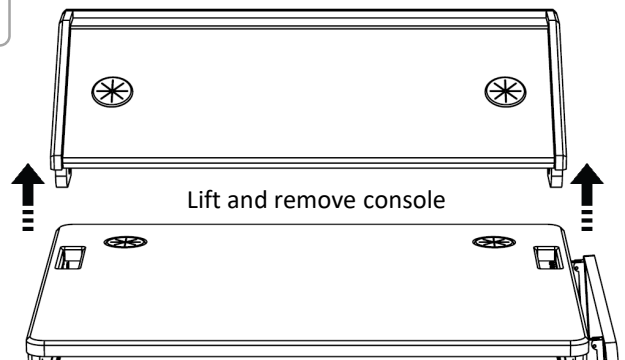

3 Dismount Folding side shelf by removing the 8 screws.

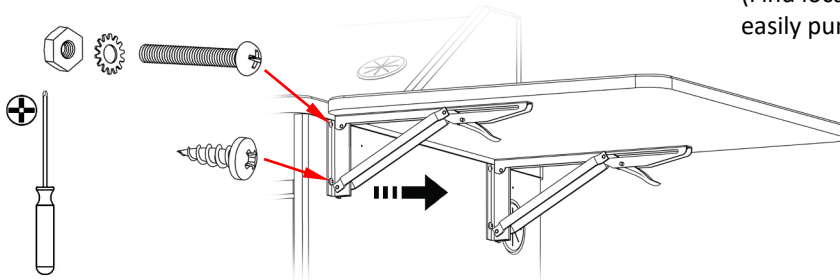

NOTE: When using 5101TP-L or 5101TP-R worktops, folding side shelf can be mounted on the other side.

(Find location holes covered by the thermowrap film, this film can be easily punctured with a screwdriver to allow screw go through)

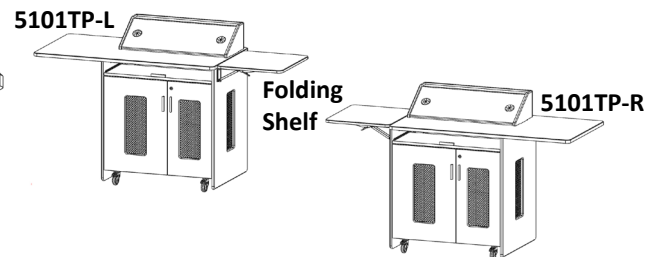

4

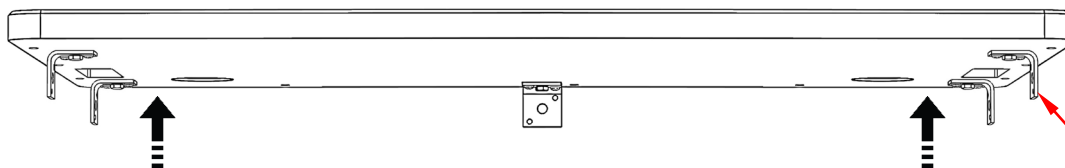

Remove screws and bolts that hold the corner braces from the side and back panels to dismount existing worktop

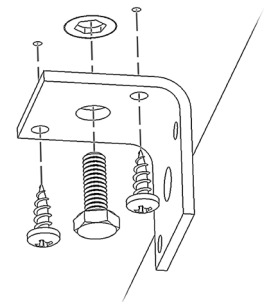

Remove the 5 corner braces and install them on the new worktop.

Mount the new worktop, and console if desired, in the same manner.