

Maximum load rating: 200 lbs

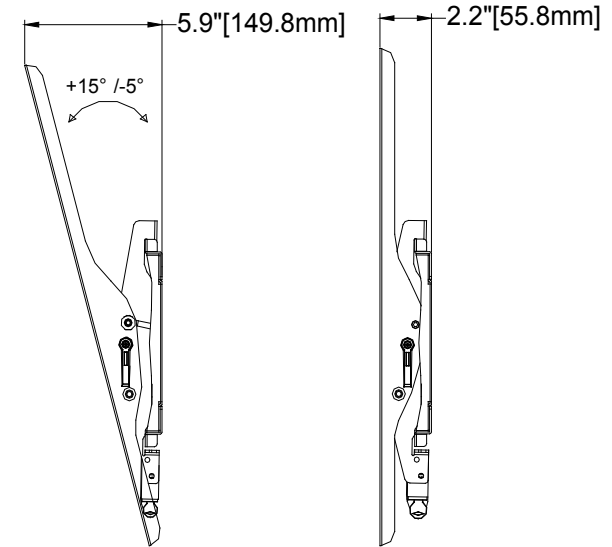

THE INFORMATION CONTAINED IN THIS DRAWING IS THE SOLE PROPERTY OF CRIMSON AV LLC. ANY REPRODUCTION IN PART OR AS A WHOLE WITHOUT THE WRITTEN PERMISSION OF CRIMSON AV LLC IS PROHIBITED

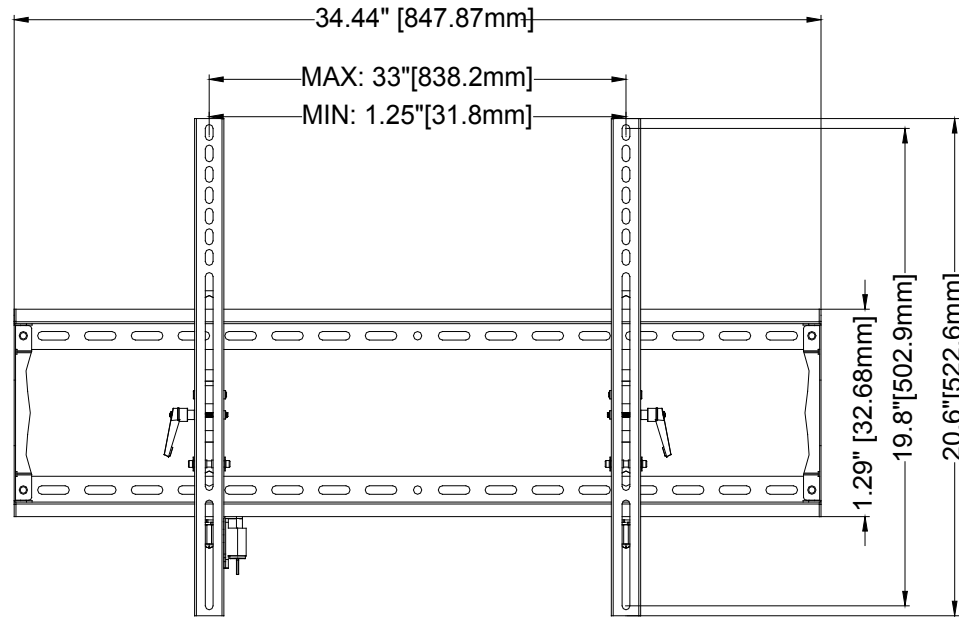
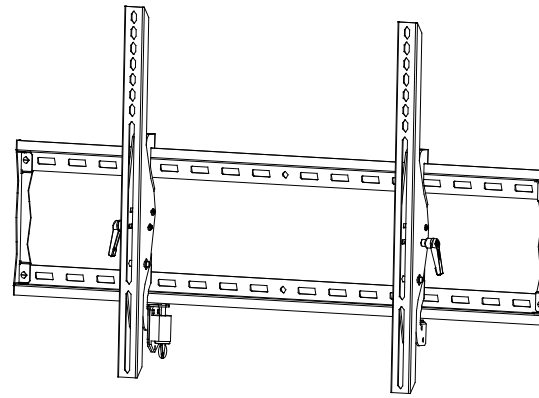

CRIMSON AV LLC.

PRODUCT ORDER NUMBER: **T63L**
PHONE: 1-866-668-6888

Scale=1:1

Crimson AV LLC.
www.crimsonav.com

TITLE:
T63L

SIZE B DWG.N.O.
T63L