

MW9600 Microplate Washer

User Manual

Version 1.1



**Accuris Instruments is a division of
Benchmark Scientific.**

Thank you for purchasing our MW9600 Microplate Washer. This user manual describes how the instrument functions, and also includes an operation guide and important safety information, please read it carefully before operating and keep this manual for future reference.

Initial check

Upon receipt, please check the outer package for damage, and check all parts inside the package to make sure all parts and components are included and in proper condition. If anything is missing or damaged, please contact your distributor or Benchmark Scientific immediately.

Packaging

Please keep the box and packaging material for your microplate washer. In the event that service is required, the box will be needed for shipping the instrument to our Service Department.

Safety warning and guidelines

1 Important guidelines



In order to avoid injury, please read this manual completely before operating the instrument. Pay special attention to all safety tips.



This instrument is intended for research only.

2 Safety



This product is for indoor use only.

Warning: Risk of biological contamination. All samples used for testing, quality control or calibration should be considered potentially infectious, and any parts of the instrument that contact the samples should also be considered at potentially infectious. Always wear gloves and appropriate safety gear when operating this device.



This instrument should only be operated by trained laboratory personnel.

Never place a hand on or near any moving parts when the instrument is running.



Do not attempt to repair the instrument without receiving specific instructions from Bechmark Scientific's Service Personnel. Please contact your distributor or Benchmark Scientific to arrange service or repair.



Always make sure to use the correct input voltage. If the power cable is damaged, replace it with same type.



This instrument should be operated in a low humidity, low dust environment, away from direct sunlight, heat and magnetic fields.

Turn off the power and unplug the instrument if not being used for a long period of time. All bottles should and tubing should be rinsed and emptied. When storing, cover the instrument to protect it from dust.

Shut off the power immediately if any of the following occur and then contact your distributor of Benchmark Scientific's Service Department:



- ★ Fluid enters into the instrument
- ★ The instrument is exposed to rain or water
- ★ There are any unusual noises or smells coming from the instrument
- ★ The instrument is dropped or the outer housing is broken
- ★ There are any obvious malfunctions

3 Maintenance

The plate holder and platform should be cleaned regularly with alcohol to remove any dried solutions or debris.

The Rinse function should be used to wash the tubing and wash heads. If the wash head's metal tubed become clogged, they can be cleared using the included cleaning tool.

CONTENTS

Chapter 1 Introduction.....	1
Chapter 2 Specifications.....	2
Chapter 3 Instrument Overview.....	3
Chapter 4 Installation.....	5
Chapter 5 Start Up and Software.....	8
Chapter 6 Preparing Wash and Waste Bottles.....	17
Chapter 7 Creating a new wash protocol.....	18
Chapter 8 Running a wash protocol.....	22
Chapter 9 Importing, Exporting and Deleting Programs.....	25
Chapter 10 Power Off.....	28
Chapter 11 Maintenance.....	29
Chapter 12 Trouble Shooting.....	30
Appendix: MW9600 diagram.....	31

Chapter 1 Introduction

The MW9600 Microplate Washer is an accessory to a Microplate Reader, and is designed for accurate and efficient washing and preparation of ELISA plates prior to reading. The MW9600 is compatible with standard 96-well, SBS-footprint microplates.

Features:

- 4.3 inch LCD display for easy programming and operating.
- Reliable, high efficiency liquid pump
- 8 and 12-needle wash heads, suitable for micro plates with Flat, U, V, and C type well bottoms.
- Wash head positions are accurately controlled to +/- 0.1mm.
- Multiple wash programs can be set up, stored and selected.
- Program allows selecting specific rows for washing.
- Pause function allows pausing the currently running program.
- Wash bottles include clearly marked volume graduations to visually monitor liquid levels.
- Automatic monitoring and warnings when wash liquid levels are low or if waste liquid level is high.
- Efficient aspiration of liquid from plate wells, remaining liquid per well: $\leq 1\mu\text{L}$.
- Plate platform includes a beveled spill well. Any spilled or leaked fluid is extracted automatically to avoid cross contamination.

Chapter 2 Specifications

Operating conditions

Operating temperature range: 4°C ~ 45°C

Operating relative humidity: ≤70%

Power supply: AC 90-240V 50/60Hz

Parameters and features

Parameters \ Model	MW9600
Wash heads	8 channel or 12 channel
Wash modes	1 point, 2 point, or 3 point aspiration
Compatible Micro plates	96 wells, standard SBS dimensions
Compatible Well bottoms	Flat, U, V, C bottom
Residual liquid volume	≤1uL(each well)
Dispensing Volume Range	50uL~2000uL
Wash cycles	1~99
Programs	100
Rinse function time range	00:00~03:59 (mm: ss)
Soak and shaking time range	00:00~99:00 (mm: ss)
Wash bottle level warning	Yes, sensors included in wash and rinse bottles
Wash solution channels	3 bottles
Waste bottle level warning	Yes, sensor detects when bottle is full
Waste aspiration	Yes
Dimensions (WXDXH)	345 x 460 x 200mm / 13.5 x 18 x 8.5 inches
Net weight	11.5kg / 25.3 Lbs

Chapter 3 Instrument Overview

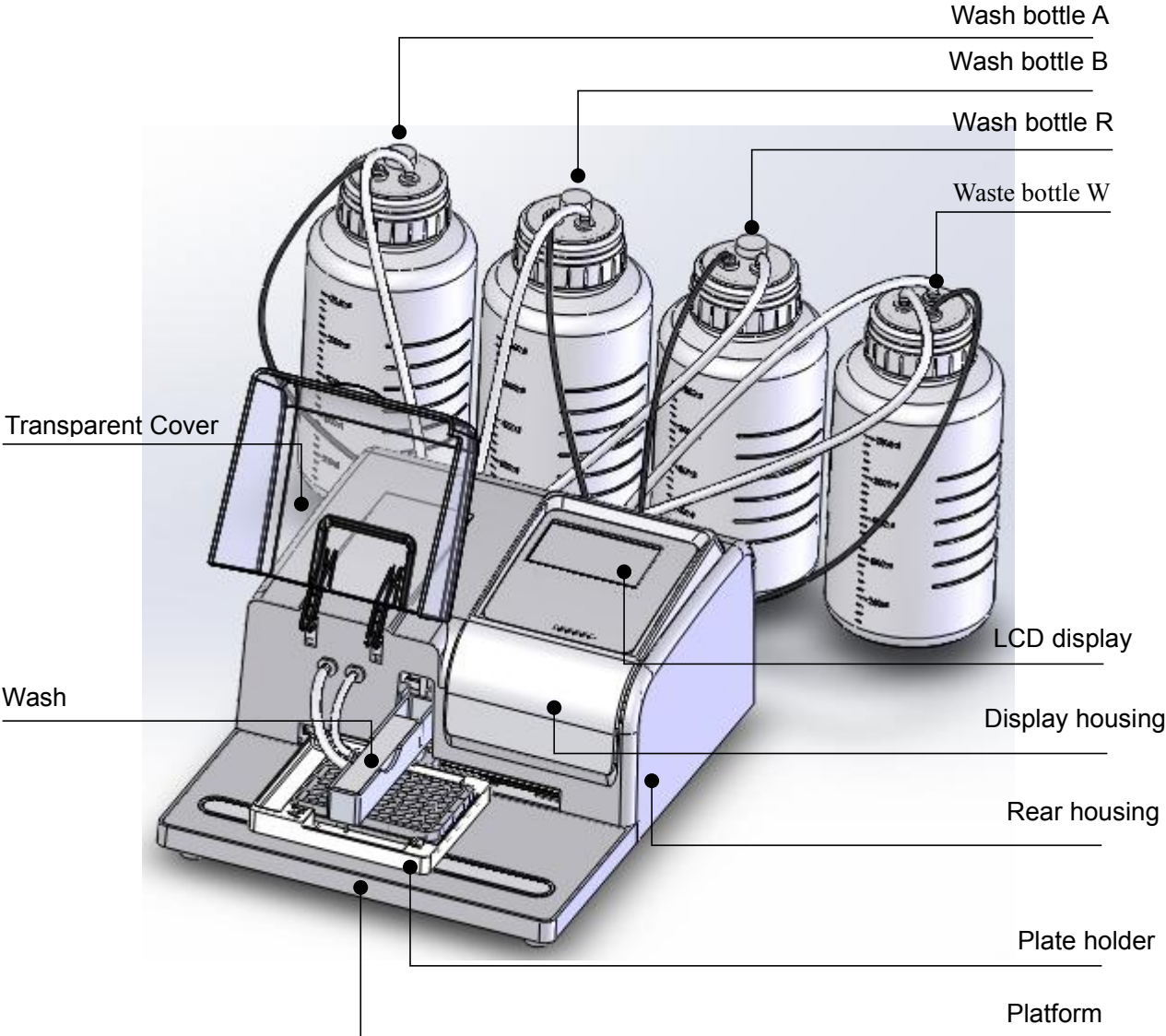

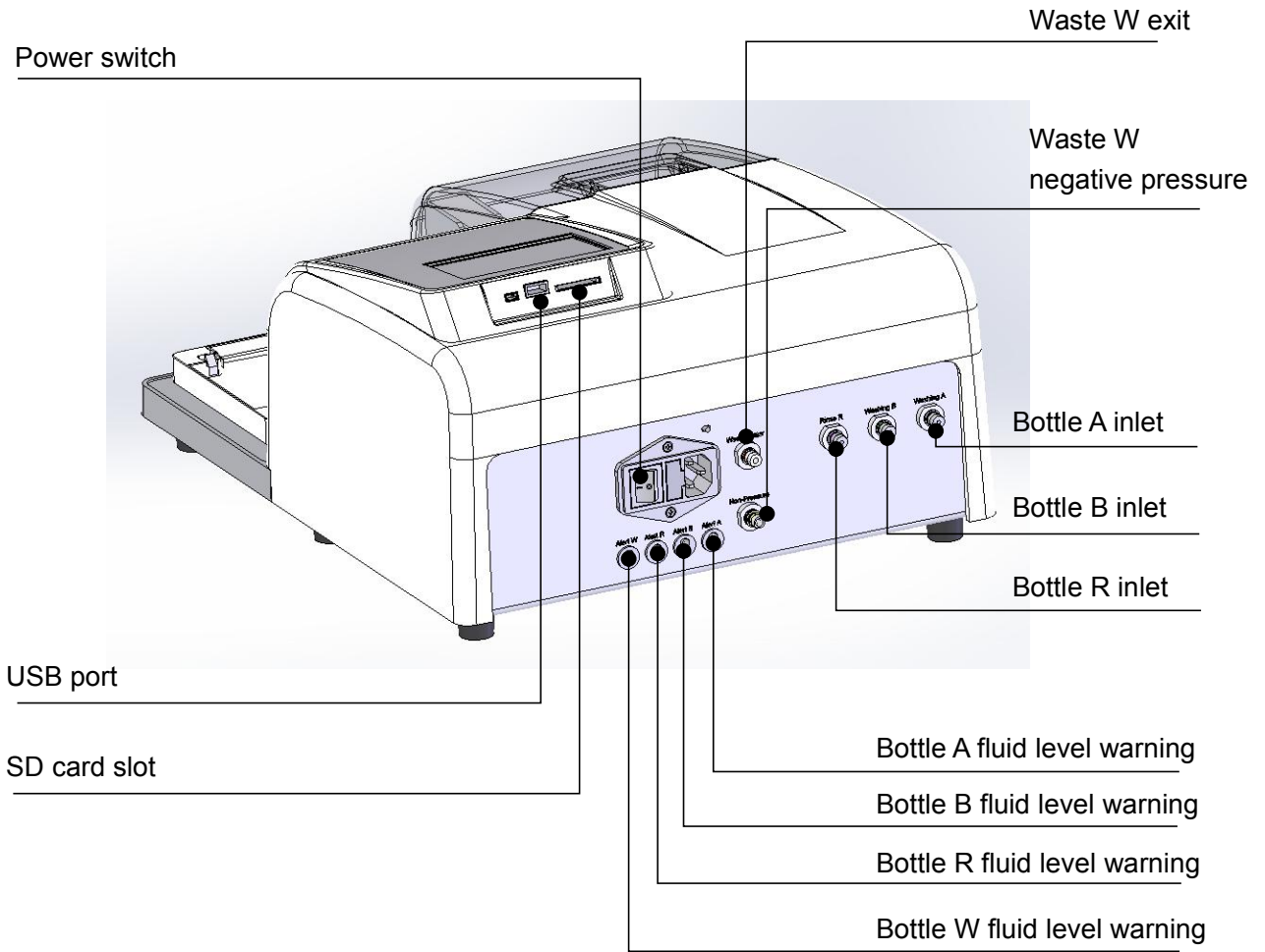

USB port

Connect a flash drive to the USB port to transfer programs between different MW9600 washers.

Wash head

2 wash heads available: 1X8 channel and 1X12 channel:

1X8 channel wash head

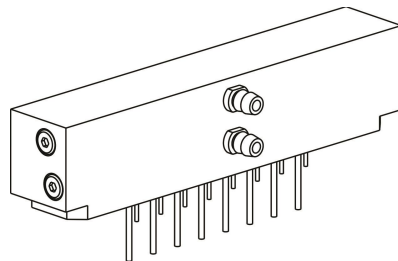

1X12 channel wash head

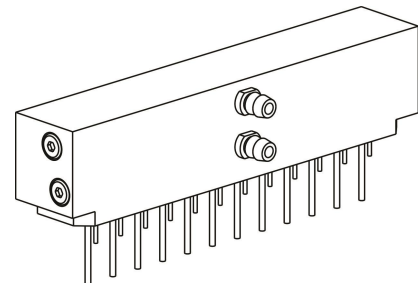

Chapter 4 Installation

Initial Inspection

Thoroughly check the package and instrument upon receipt. Please contact your distributor or Benchmark Scientific immediately if:

- The package has been damaged or deformed during shipping.
- The packaging is wet.
- Any parts or accessories are missing (compare to the packing list). Make sure all ordered items are included.
- There is any damage to the Microplate Washer or accessories.

Installation steps

- Open the package, remove the four bottles, wash heads, power supply and the instrument and place in onto a sturdy, flat and level desk or lab bench.



Attention: Remove the shipping safety lock before operating.

Unscrew the allen screw on the wash head rack using the included allen key.

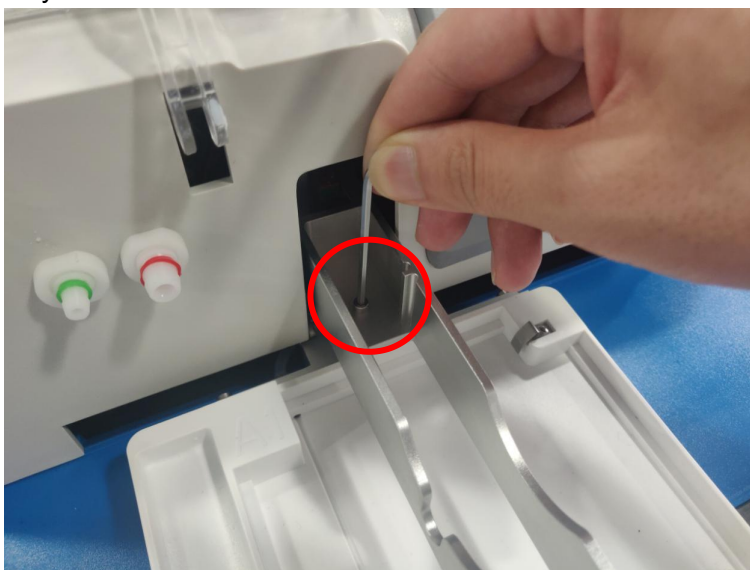

Wash head installation

Connect the silicone tubes per the following picture:

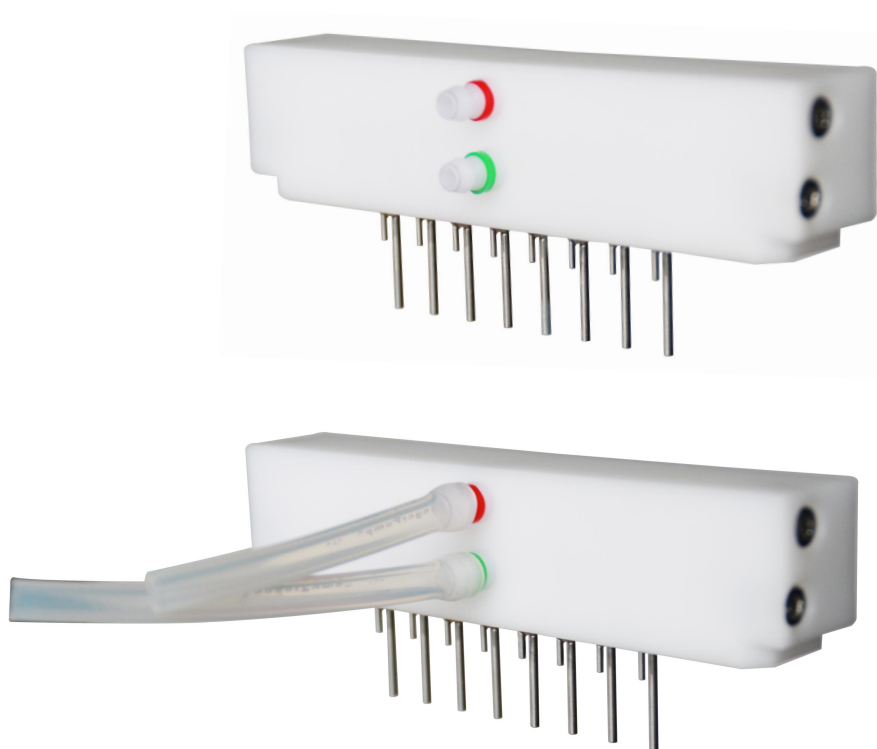

Insert the wash head into the rack and connect the silicone tubing to instrument as pictured below. (1X8 and 1X12 wash heads are installed in the same manner).

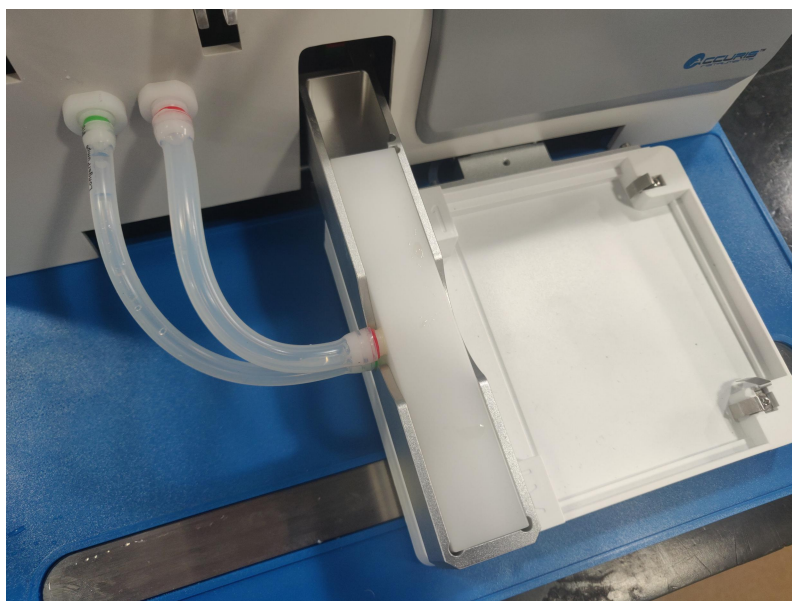

Wash bottles connections: Connect bottle tubing and level detection lines according to the charts:

Silicone Tube from:	Instrument Connection Port	Color
Bottle W non-pressure output tube	Non-pressure	Yellow
Bottle A fluid output	Washing A	Black
Bottle B fluid output	Washing B	Green
Bottle R fluid Output	Rinse R	Purple
Bottle W fluid input	Waste	Red

Level detection line:	Instrument Connection Port
Bottle A fluid level warning	Alert A
Bottle B fluid level warning	Alert B
Bottle R fluid level warning	Alert R
Bottle W fluid level warning	Alert W

The standard included accessories are 3pcs wash bottles (2.5L) and 1pc waste bottle (2.5L) and silicone tubing A, B, R and W.

The names of the wash bottles are Wash Solution A, Wash Solution B, Rinse Solution R and Waste.

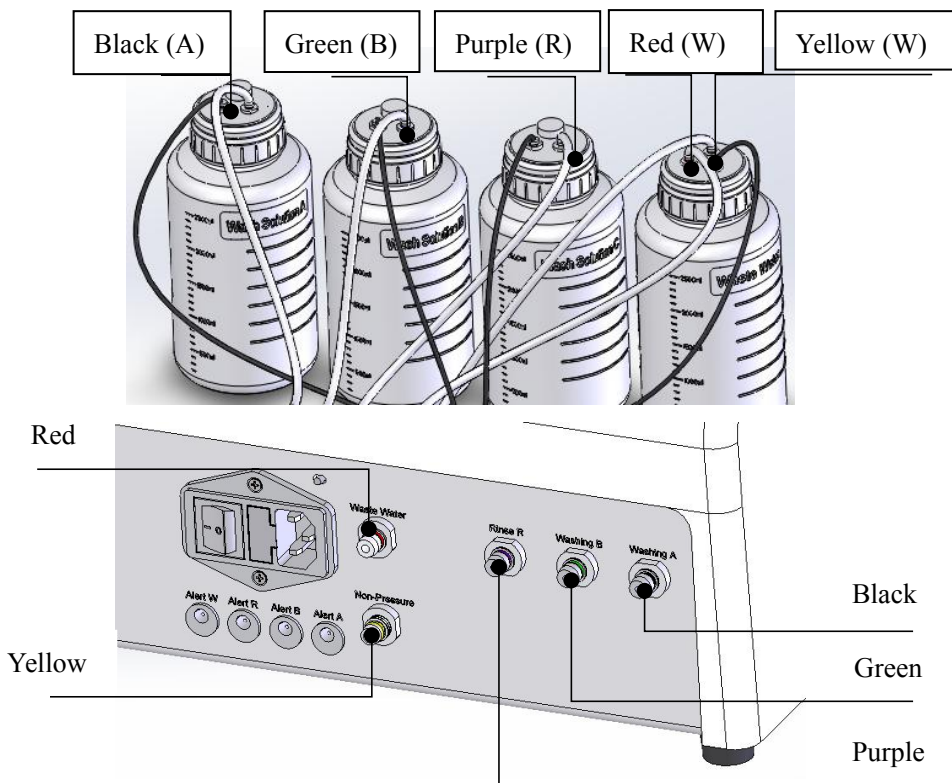

Power supply connection : Connect the Washer to the appropriate AC power source

Chapter 5 Start Up and Software

Start Up Self-Test

When the power is first turned on, the system will perform a quick self-test. Do not turn off the power, or insert or remove a flash drive during the self-test.

Do not touch the wash head, wash head rack or plate holder when running.

An alert sound and warning will be displayed if the Waste Bottle W is full or if A, B or R are empty, or any of the sensors are not properly connected.

In the event of this type of start-up warning, check the liquid levels and sensor connections. Then push OK or F4 to cancel the warning.

Main Interface

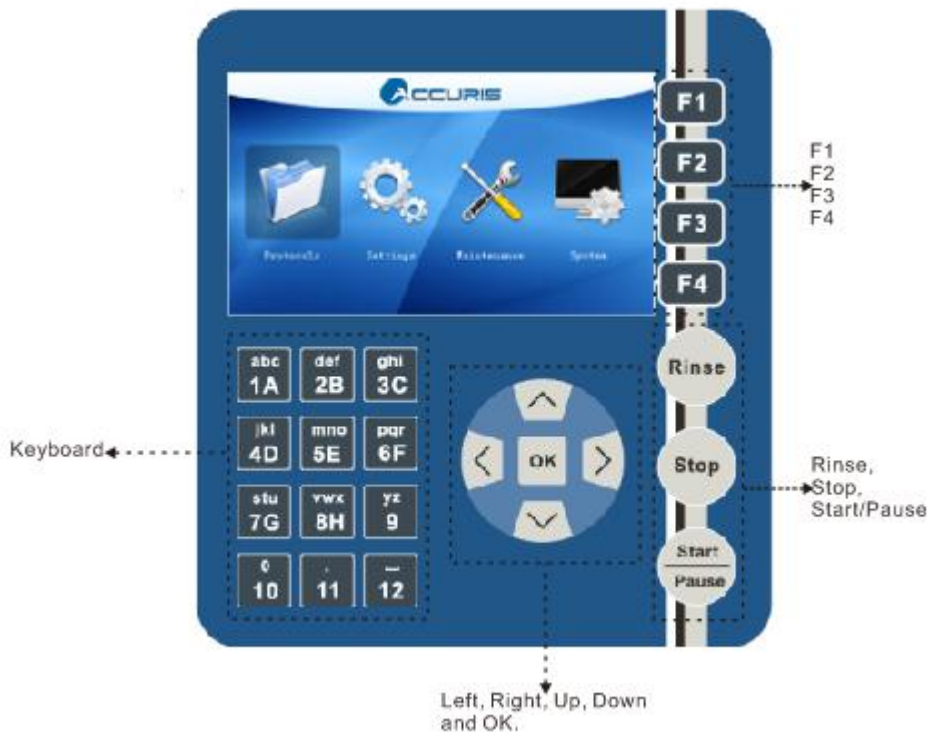

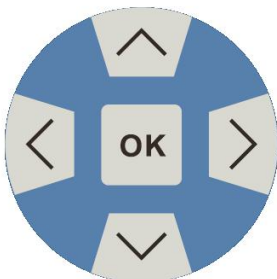

Browse with the direction keys.
Push and hold any key for the cursor to move faster in the direction you choose.



F1, F2, F3, F4 are shortcut keys.



Push the start/Pause button in the main menu, it will start to run the program; push again, it will pause the program.



Push Rinse button in the “Wash” interface to rinse or prime the tubing. Pressing a second time will pause the priming. Press F4 key to cancel.



The stop button is used to stop a program during operation.

abc 1A	def 2B	ghi 3C
jkl 4D	mno 5E	pqr 6F
stu 7G	vwx 8H	yz 9
0 10	. 11	— 12

The bold numbers and letters on the keypad correspond to the columns of wells on the ELISA plate when selecting the columns to be washed. Numbers 1-12 are used for the 1x8 head, letters A to H when using the 1x12 head).

The lower cap letters are used when naming protocols.

Main menu



1. Protocols Choose the protocols icon by pressing the UP, DOWN, LEFT, RIGHT buttons to highlight the icon, and then push OK to confirm. The Protocol File List will open.

Protocol File List

Use the UP, DOWN, and OK buttons to highlight an existing saved protocol, and press OK to select it. Or use the function keys F1 to F4 to select New, Delete, Import/Export, or Back.

Num	Name	Wash Head	Well Type	Date Modified
1	demo	1x12/96	U	2020/06/28
2	6	1x8/96	Flat	2020/06/27
3	a	1x8/96	Flat	2020/06/28
4	5	1x8/96	Flat	2020/06/28
5	66	1x8/96	Flat	2020/06/28
6	5685	1x8/96	Flat	2020/06/28
7	n	1x8/96	Flat	2020/06/28

See Chapter 7 for Creating a wash program and Chapter 8 for Running a wash program



2. Settings: Setting options include: Purge volume setting, sensor setting, injection index, beeper switch setting, and purge at power on.

Purge Volume (mL)	50	Modify
Liquid Level Sensors		
Injection Index	1.00	Save
Beeper Switch	Off	Back
Purge at Power On	Multiple	

Purge Volume setting: Choose “Purge Volume” in the menu, then press “OK”. This allows setting of the volume of the solution which will be purged through the tubing during the start of a protocol run. Volume can be adjusted from 5ml to 100ml by 5 ml increments. The default purge volume is 50ml.

Note: When a protocol is selected that uses a different wash bottle than used in the previously run protocol, the purge function will run before the washing steps. This purge function will replace the liquid in the dispensing tubes and wash heads with the appropriate buffer for the current wash protocol. When a wash protocol is repeated, the purge function does not run, because the tubing and wash heads will already contain the appropriate solution.

Liquid Sensor: This allows turning on or off the sensors A, B, and R.



Note: Sensor W for Waste Liquid Level cannot be set to off.

Injection Index: This is for calibrating the set dispensing volume. The range of the Injection Index is 0-2.00, and can be adjusted in increments ± 0.01 . The default value is 1.00.

Beeper switch: The audible beep for indicating an alarm or warning can be turned on or off.

Purge at Power On: When the first wash protocol is run *after* the instrument is powered on, the purge function will run to remove bubbles and prime the dispensing tubes and wash heads. This can be set for “Single” or “Multiple”.

“Single” setting: Only the single wash solution that is selected in the protocol will purge through the tubes and wash head prior to washing.

“Multiple” setting: All of the active wash solutions (Solutions A, B, R, when liquid level sensors are enabled) will purge through the dispensing tubing and wash heads.



3. Maintenance: This menu includes the Rinse setting, 1X8 channel calibration and 1X12 channel calibration.

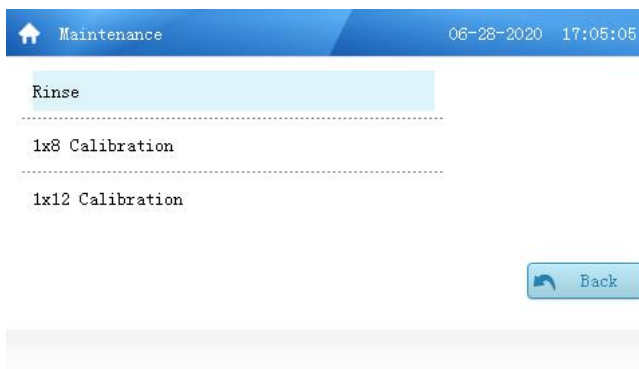

Rinse: The rinse function can be used for priming the dispensing tubes (removing air bubbles) and also for rinsing out the dispensing tubes and wash head. It is

recommended that wash solution bottle R is filled with distilled water, and this is used for rinsing after using the microplate washer. It is recommended to use the rinse function before powering off the instrument if it will not be used for a while.

Select which tubing line is to be rinsed, and rinse time.

- Select tubing line from bottle A, B or R
- Set the rinse time: 00:01-03:59 (mm:ss), the default time is 2:00.

Rinse		06-28-2020 17:05:16
Tubing for rinse(bottle)	B	Modify
Rinse time	2:00	
Save		
Back		



The rinse function can be activated by pressing the “Rinse” button.

1X8 Calibration and 1x12 Calibration:

- It's recommended to calibrate the position of the wash head before use, although it has been calibrated in the factory with standard micro plates.
- Vertical and horizontal positioning can be adjusted in increments of 0.1mm
- Choose 1x8 or 1x12 channel wash head, depending on which is used, press OK to enter into the calibration interface.



Attention! Confirm that the proper wash head is selected before calibration.

1x8 Calibration		06-28-2020 17:05:39
Left Deviation	68.7	Modify
Right Deviation	166.8	
Top Deviation	2.4	
Bottom Deviation	15.4	
Save		
Back		

Left deviation: Left deviation means the distance between the starting position of the dispensing needle to the center of the left row of wells of the micro plate.

Choose the left deviation function in the calibration menu, then push OK button. The plate will move so that the wash head needles are aligned above the left row of wells. Use the UP or DOWN arrow buttons to move the needles left or right, respectively, to position the needles directly above the center of the wells. Push OK button to confirm and save the setting.

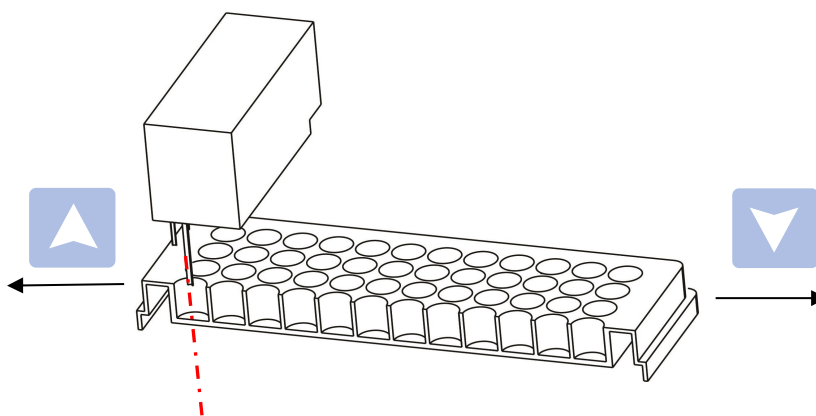

Right deviation: Right deviation means the distance from the starting position of the needles to the center of the right row of wells. Adjust the position using the up and down arrows so the needles are centered above the right most row of the microplate.

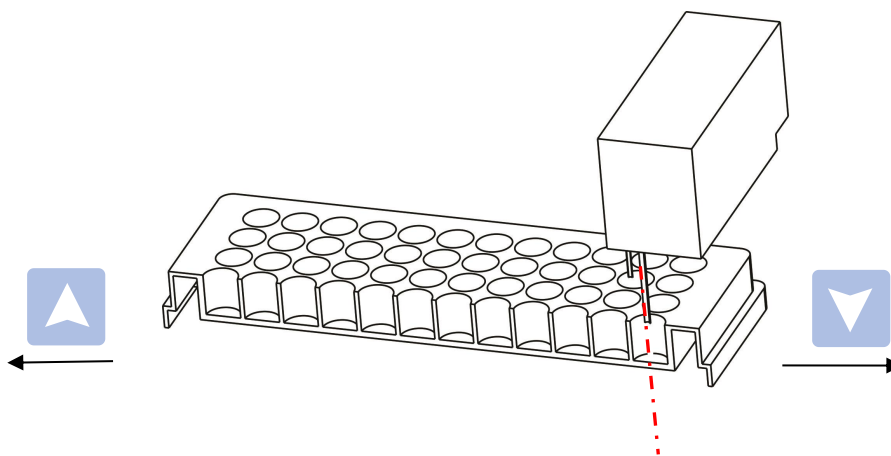

Top deviation allows adjusting the distance between the wash head bottom to the photoelectric switch.

Choose the top deviation function in the calibration menu, then push OK button to enter. Push UP and DOWN to adjust the distance.

The distance between the needle bottom and the top of the micro plate should be approximately 2-3mm.

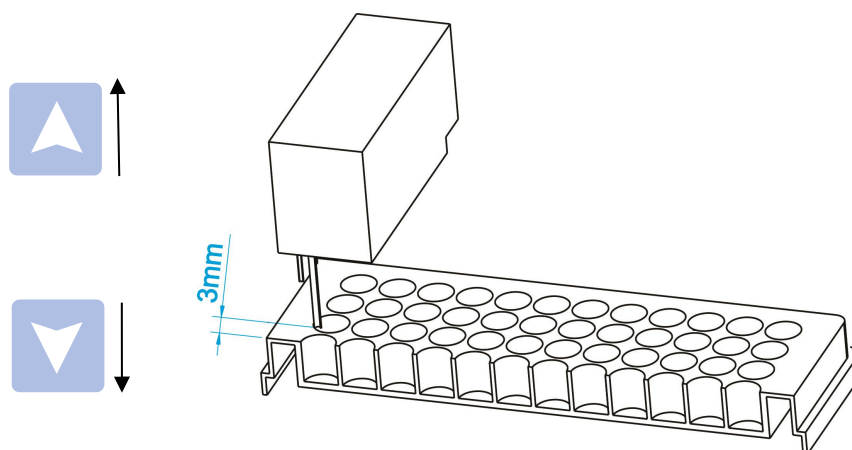

Bottom deviation is the distance between the wash head bottom to the photoelectric switch.

Choose the top deviation function in the calibration menu, then push OK button to enter. Push UP and DOWN to adjust the distance.

The distance between the needle bottom to the bottom of the microplate well should be about 0.5-1mm.

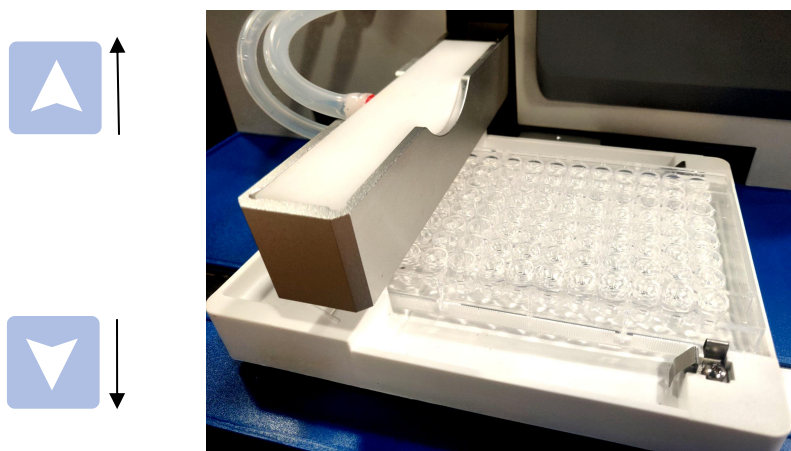



4. System: The System Menu includes date & time settings, language setting, reset and system upgrade.

Available languages: English and Chinese.



Reset: All settings will be restore factory settings if press “Reset” ,except calibration interface,Time&Date,and languages setting .



System Upgrade:

MCU Upgrade: for hardware updating by USB flash drive.

Soft Upgrade: for software updating by USB falsh drive.

Picture Upgrade : the start up image and home page image can be changed by USB flash drive.

Chapter 6 Preparing Wash and Waste Bottles

Filling, washing, and connecting bottles

- Unscrew the bottle caps, fill or empty the bottles with appropriate solutions as required.
- Screw the caps firmly onto each bottle, and securely connect the tubing to the bottles and appropriate ports on the instrument.
- Use the Rinse function as needed to purge the tubing and remove bubbles before running a program.
- Make sure there is enough solution in the bottles A, B, R, and there is space in the W (Waste) bottle, before running the program.
- Note: The system will detect the fluid level automatically. Check the fluid level warning icons during a run to determine if any bottles need to be filled or emptied.

Chapter 7 Creating a new wash protocol

Starting from the Protocol File List interface, press the function button F1 to choose “New” to create a new wash protocol. It is also possible to open an existing protocol from the list, and then modify it as needed.

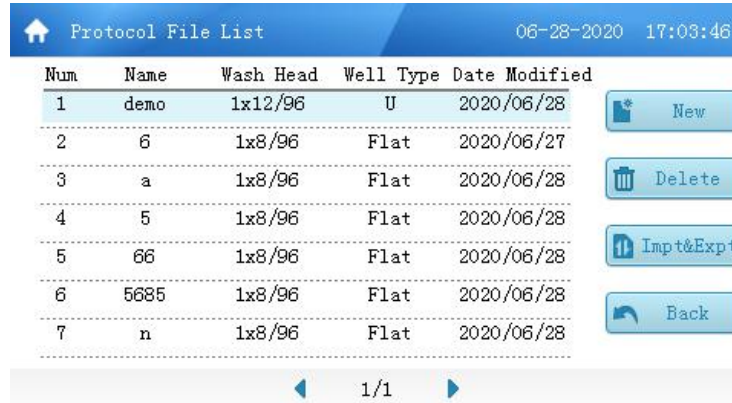

Protocol File Interface

Enter a name for the new wash protocol using the number/letter keyboard, then press OK to save it.

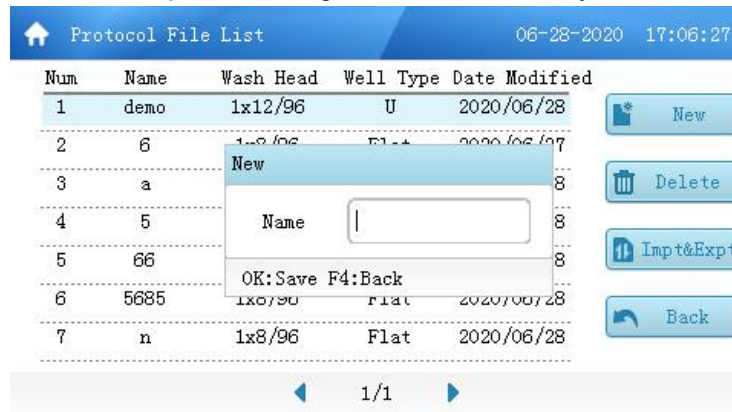

The Protocol Programming Interface will be displayed, and using the UP, DOWN, and OK buttons, the program can be customized.



Well Type: can be set per the shape of the well bottoms on the microplate to be used.

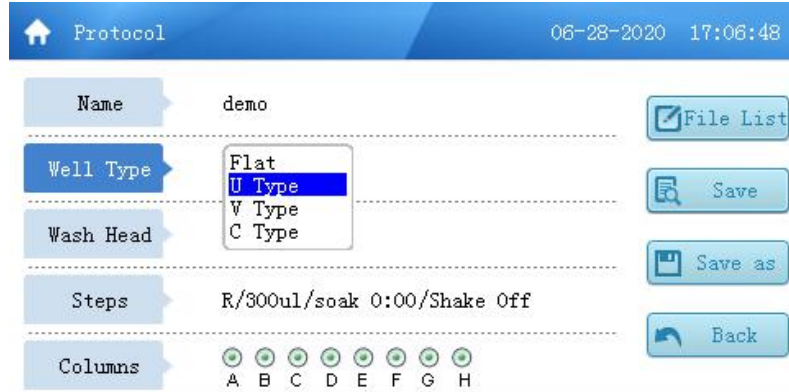

Wash Head: Choose the wash head that is installed (1x8 or 1x12 channel)



Steps: Selecting the “Steps” button will open the Step Programming interface.

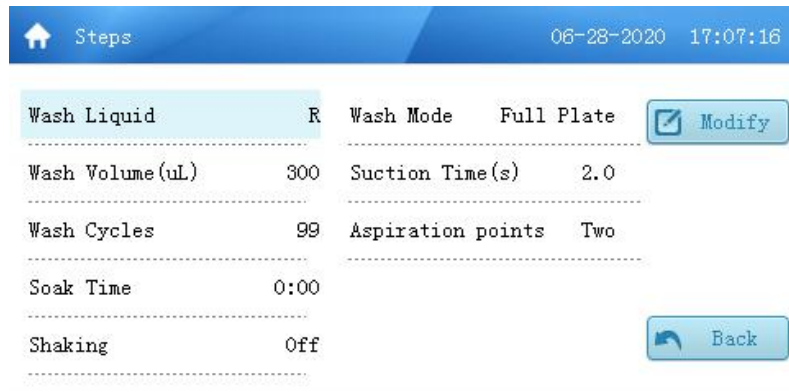

Step Programming Interface

- **Wash Liquid:** Choose the wash liquid from bottle A, B, or R, the default is B.
- **Wash Volume (µL):** Set the wash solution volume to be dispensed per well, from 50 µl to 2000 µl, in increments of step by 50 µl. The default is 300ul.
- **Wash Cycles:** Select the number of times the plate will be washed, from 1 to 99. The default is 2.
- **Soak Time:** Set the interval time between each wash step. The default is 0, the maximum is 99 minutes. Set in increments of 1 second.
- **Shaking:** This can be set to Off, Slow, Medium or Fast. The default is OFF. The shaking speed can only be set when the soak time > 0.

Shaking speed	amplitude	speed
slow	8mm	1Hz
medium	8mm	5Hz
fast	8mm	10Hz



Note: Set the shaking speed considering the volume and viscosity of the liquid in the wells, take care that the solution will not splash out of the wells during shaking.

- **Wash Mode:** Set the wash mode for Full Plate or Column. The default is Full Plate.
 - **Full Plate:** In Full Plate mode, liquid will be dispensed into all selected columns across the plate, there will be a pause for the soak/shake, then liquid will be aspirated from all selected columns.
 - **Column:** In Column mode, selected columns will be washed individually. Liquid will be dispensed and then aspirated from each selected column, and repeated on that selected column if multiple wash cycles are set, then the washing will advance to the next column.
- **Suction Time:** Set from 0s to 10s, in 0.1s increments. The default is 2s. If the Suction Time is set to 0, the plate wells will be left full of wash solution (there will be no aspiration of the liquid at the end of the run).
- **Aspiration Points:** This can be set for 1 position, 2 positions or 3 positions to maximize the aspiration of liquid in the wells. The default mode is based

on the well type selected.

One position: There is one aspiration position in the center of the well.

Two positions: There are two positions, left and right on the well bottom.

Three positions: There are three positions, left middle and right.

Well type	Aspiration Point Settings		
	One Position	Two Positions	Three Positions
Flat type	Optional	Default	Optional
U type	Default	Not Optional	Not optional
V type	Default	Not Optional	Optional
C type	Default	Not Optional	Not optional

- **Columns:** Use the number buttons on the keyboard to choose the plate columns which need to be washed.
 - When using the 1X8 channel wash head use numbers 1 to 8 to select the columns for washing.
 - When using 1X12 channel wash head, use letters A to H to select the columns for washing.
 - Pressing the number or letter for a row a second time will cancel the selection.

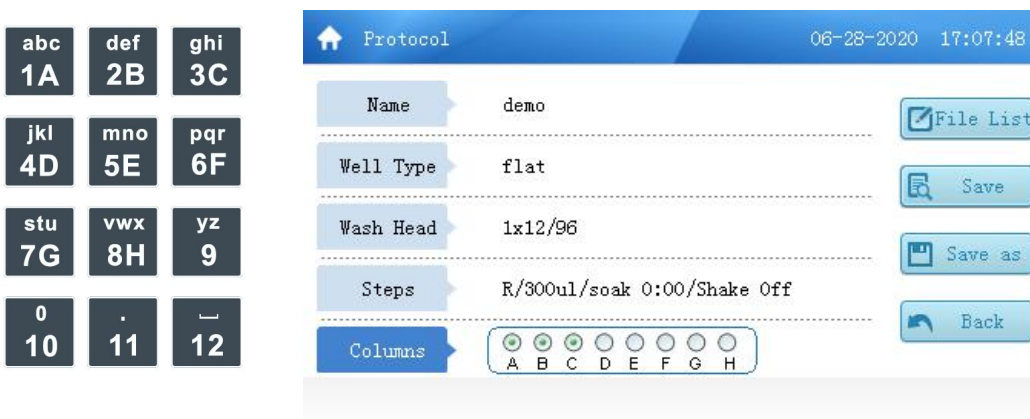

- **Save:** Press the F3 button to **Save** the new program.

Chapter 8 Running a wash protocol

Note: Before running a wash protocol, make sure that the dispensing lines and washing heads are properly purged and free of bubbles. Use the Rinse function to purge the dispensing lines to be used.

Also make sure that the Purge Volume in the settings menu is set appropriately. Make sure that all bottles to be used have their sensors enabled, and if different protocols will be used for washing from multiple bottles, set the Purge at Power On to “multiple”.

- Select a protocol from the Protocol file list (see Chapter 5, Protocol File List) or setup a New Protocol (see Chapter 7, Creating a new wash protocol)
- Install the 96 wells plate on the plate holder, make sure the position and orientation matches the wash head setting.
- When using the 1×8 wash head, the A1 position on the plate should be to the left upper corner and when using the 1×12 wash head, the A1 position on the plate should be too the left lower corner.

Wash head type	Plate type	Plate Orientation
1X8 channel	96 wells	Horizontal
1X12 channel	96 wells	Vertical

- Select the rows to wash (if required to change)
- Push the Start/Pause button.

The Washing screen will appear and show the status of the running wash protocol

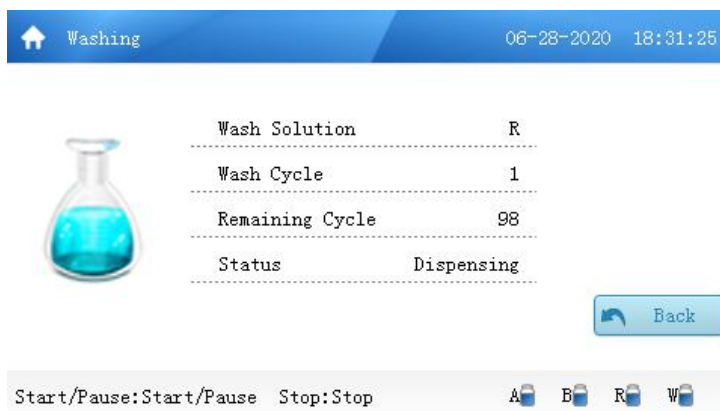

Cancel a run

If any errors occur during a wash run, the instrument will automatically stop, and an error warning will appear on the display. Pressing the “Stop” button will also stop the instrument.

Fluid level warning

During a programmed run, a warning window at the bottom of the display shows fluid level status of each bottle (A,B,R and W), the sensors in the bottle can detect fluid level automatically when the program is running. If the relevant icon turns red, please empty or fill the bottle as needed.



Fluid Detection for Bottles A, B, and R

- When bottles are full, the icon is blue
- When bottles are empty or the sensor is disconnected, the icon is red
- If the sensor is turned off in the settings menu, the icon is yellow

Fluid level detection for Waste Bottle W

- When the waste bottle becomes full, the icon is red
- When the waste bottle has space, the icon is blue

A wash protocol run can be stopped at any time by pushing F4 “Back” button, or the run can be paused by pressing the Start/Pause button.

- At the end of the wash protocol the micro plate can be removed.
- It's recommended to rinse/purge the tubing after use.

Priming:

At the start of a new wash program run, the instrument will initiate a purge to clear out the tubing, remove air bubbles, and fill the dispensing tubing and wash heads with the buffer selected for the wash program.

The purge volume can be set in the Setting menu (see Chapter 5). The default is 50ml.

When the instrument and tubing is first connected, additional priming may be required to eliminate all of the air bubbles. This can be done using the Rinse function:

Using Rinse function to prime the tubing and wash heads

Starting from the Maintenance/Wash interface, press the Rinse button on the panel. This will initiate a priming rinse of the selected tubing (from bottle A, B, or R) and will run for the selected time. It may be necessary to run the Rinse function with all of the solutions used to fully purge the tubing.

Pressing the “Rinse” button from the Protocol interface will open the Maintenance/Wash interface. Press the “Rinse” button again to initiate the rinse.

Chapter 9 Importing, Exporting and Deleting Programs

Import programs from a USB flash drive

- Insert the USB flash drive



- From the Program File List interface, press the F3 button (Impt&Expt). The below dialog box will be displayed.

Num	Name	Wash Head	Well Type	Date	Modified
1	demo	Impt&Expt			
2	6				
3	a				
4	5				
5	66				
6	568	F1:Import F2:Export F4:Back			
7	n	1x8/96	Flat	2020/06/28	

- Push the F1 button on the panel to enter the import interface. Protocols files stored on the USB drive will be displayed.

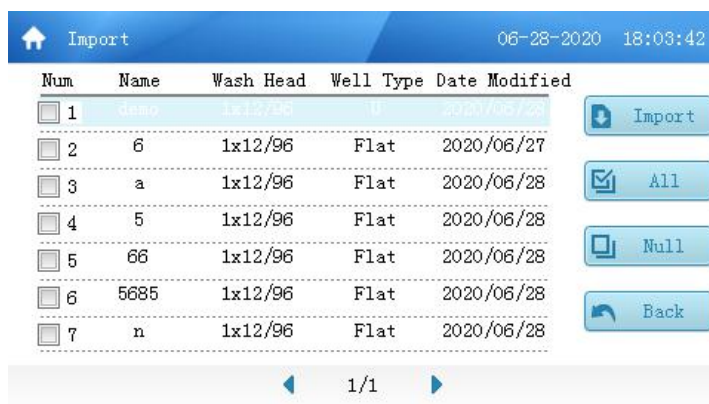

Num	Name	Wash Head	Well Type	Date Modified
1	demo	1x12/96	0	2020/06/28
2	6	1x12/96	Flat	2020/06/27
3	a	1x12/96	Flat	2020/06/28
4	5	1x12/96	Flat	2020/06/28
5	66	1x12/96	Flat	2020/06/28
6	5685	1x12/96	Flat	2020/06/28
7	n	1x12/96	Flat	2020/06/28

- Select the protocol to import, and then press F1 to import.

Export protocol

- Insert a USB flash drive



- From the Program File List interface, press the F3 button (Impt&Expt) on the panel and a dialog box will open stating "USB Drive Found".
- Press the F2 to enter the export interface, and the programs stored in internal memory will be displayed.

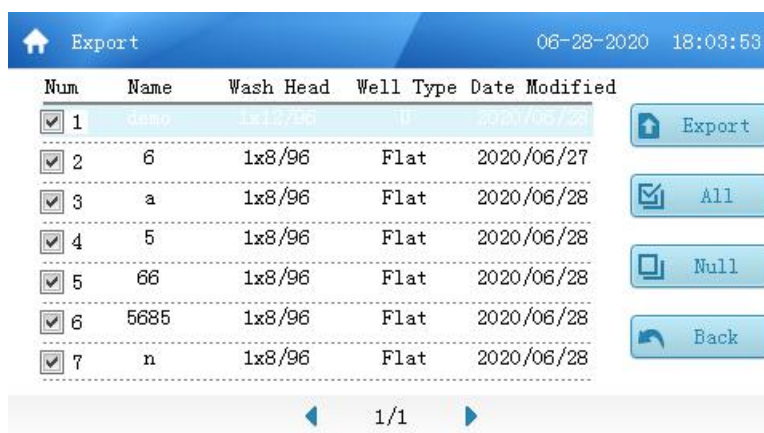

- Select the protocols to export, then press F1 to complete the export to the USB flash drive.

Delete programs

- From the Program File List interface, highlight a protocol to delete, and press the F2 button (Delete) to delete the file. Demo protocols cannot be deleted.

Chapter 10 Power Off

Steps for powering off

- Remove the plate from the plate holder.
- Rinse the tubing with rinse solution (it is recommended to use bottle R for rinsing, and this bottle to be filled with distilled water). From the Protocol interface, press “Rinse”, and select rinsing from bottle R.
- It is always recommended to run the rinse program when work with the instrument is finished and before powering off. This will keep the wash channels clean and prevent clogging.



Attention: If the wash head is not cleaned regularly between uses, the thin dispensing tubes on the wash heads can become clogged, and repair or replacement may be required. The included cleaning tool may also be used to clear clogged tubes.

- If the machine will not be used for a long time, it is recommended to run the Rinse cycle, disconnect the tubing from the bottles and the instrument, and run the machine to clear the liquid out of the internal tubing lines.
- Turn off the power using the power switch on the rear of the instrument.
- If any buffers or infectious liquid has come in contact with the external surfaces of the instrument, it is recommended to clean and sterilize using 70% alcohol.



Warning: The wash head and surfaces of the plate holder may be contaminated once instrument has been used.

Warning: When handling the waste solution, please wear gloves, goggles and protective clothing to avoid skin contact.

Chapter 11 Maintenance

Tubing maintenance

- The Rinse function can be used to clean out the tubing.

Wash head maintenance and cleaning

- Remove the wash head and detach the silicone tubing, remove the sealing screws at the ends of the wash head, submerge the wash head into 75% alcohol to water solution. Use the included cleaning tool to clear out any debris in the suction needles (long) and dispensing needles (short). Alcohol can be pushed through the wash head openings using a syringe. Or use a soft brush to clean the inside of the openings.

Filter cleaning

- The circular filter assembly at the bottom of each dip tube in the reagent bottles can be removed for cleaning. Disconnect the silicone tubing from the filter assembly, unscrew the top portion of the assembly, and all parts can be cleaned using alcohol.

Plate Holder

- The base of the plate holder has a drain with a liquid collection tube. Distilled water can be added into the plate holder after use, and the liquid will be drained out automatically to the waste bottle during a Rinse procedure. Take care not to allow any solid materials or debris to enter the drain hole, or the drain could be blocked.

Chapter 12 Trouble Shooting

No.	Faulty phenomenon	Possible Causes	Solution
1	Display not lit when powered on	Power connection	Check the power connection
		Fuse blown	Replace the fuse
		Switch damaged	Change the switch
		Screen damaged	Contact Service
2	Buttons not reacting	Control panel damaged	Contact Service
3	One of the rows over filling with liquid	Wash head blocked	clean the wash head with included cleaning tool
4	Plate wells over filling	Wash head blocked or pipeline aged.	replace the pipe or clean the needle
5	Noisy operation	Bearing damage	contact Service
6	Wash head needles touching the plate	Position settings for wash head not correct	calibrate the wash head in the maintenance setting
7	Liquid dispensed into the plate holder	Plate is not positioned correctly per wash head selected	Adjust the direction of the plate
		The wash head is not positioned correctly	Check the wash head, make sure the correct wash head matches the program.
8	Liquid dispensing or suction problem	Pump is broken Air pipe is not well connected Solenoid valve broken	Insert the air pipe again, screw the bottle cap tightly, or replace the cap seal.
9	No liquid suction	Pump is damaged Tubing is not well connected Air leakage from the bottles	Insert the air pipe again, screw the bottle caps tightly, or replace the cap seal.
10	Liquid splashing out of the plate	The liquid volume is set too high or shaking speed is too fast.	reduce the liquid volume or lower the shaking speed

Appendix: MW9600 diagram

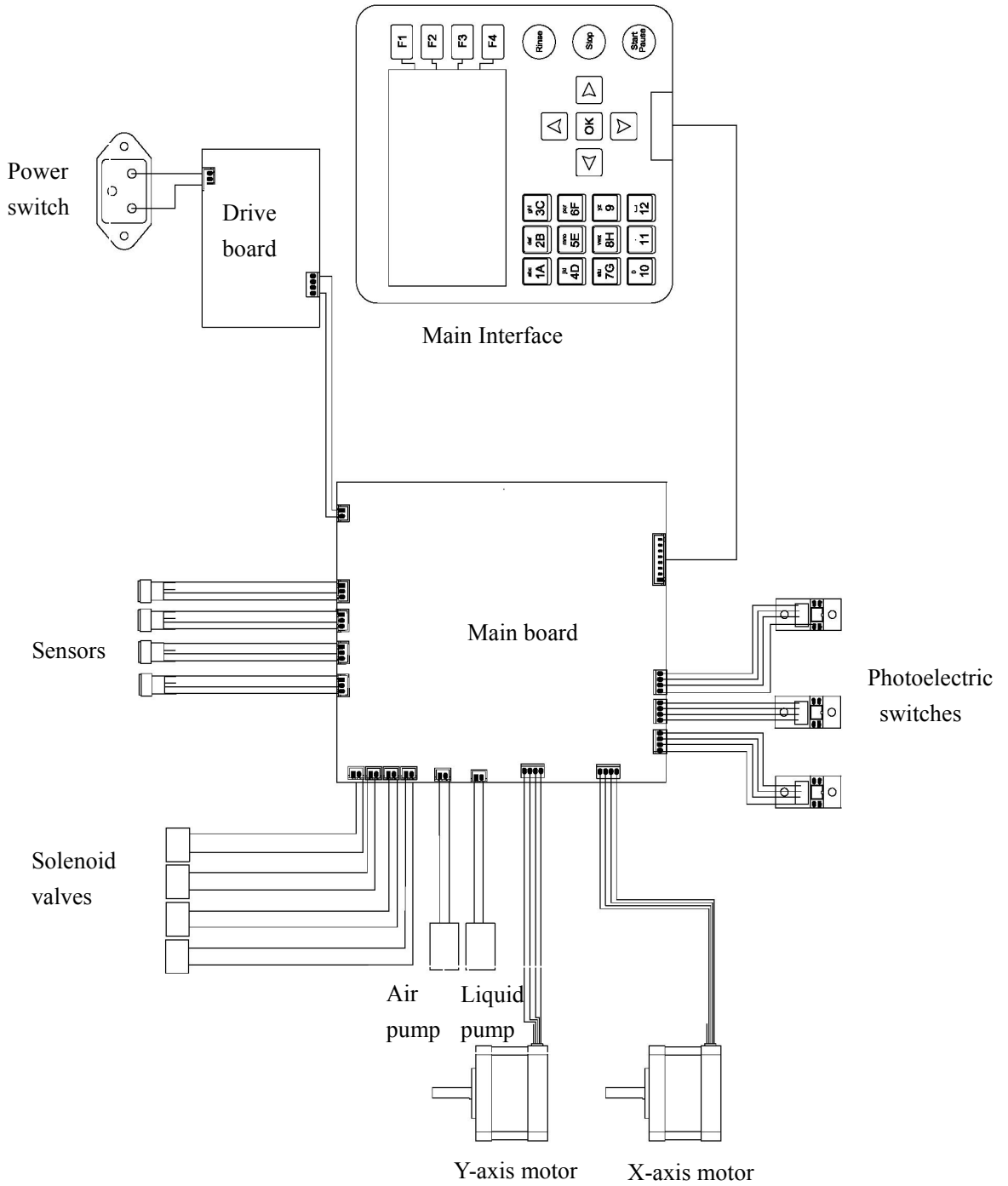

Note