

**WBW SERIES  
WBW..M EC and WBW..aM NTEP  
Type Approved**  
(P.N. 303669031, Revision E4, May 2013)



# CONTENTS

1.0	INTRODUCTION .....	3
2.0	SPECIFICATIONS .....	4
3.0	INSTALLATION .....	6
3.1	UNPACKING .....	6
3.2	LOCATING .....	6
3.3	SETTING UP .....	7
4.0	KEYPAD .....	8
4.1	NUMERIC ENTRY METHOD .....	8
5.0	DISPLAY .....	9
6.0	SYMBOLS AND INDICATORS .....	9
7.0	BATTERY OPERATION .....	10
8.0	BACKLIGHT .....	10
9.0	AUTO POWER OFF .....	10
10.0	OPERATIONS .....	11
10.1	ZEROING .....	11
10.2	TARING .....	11
10.3	WEIGHING .....	12
10.4	CHECK-WEIGHING .....	12
10.5	LIMITS STORED IN MEMORY .....	13
11.0	RS-232 INTERFACE .....	13
12.0	CALIBRATION .....	14
12.1	WBW-M APPROVED SCALES, CALIBRATION PROCEDURE .....	14
12.2	SECURITY SEALS .....	14
12.3	CALIBRATION COUNTER .....	15
12.4	WBW SERIES , NOT APPROVED .....	15
13.0	PARAMETER SETTING .....	17
13.1	CHECK WEIGHING PARAMETERS .....	17
13.2	SCALE PARAMETERS .....	18
14.0	ERROR CODES .....	19
15.0	REPLACEMENT PARTS AND ACCESSORIES .....	20
16.0	SERVICE INFORMATION .....	20
17.0	WARRANTY INFORMATION .....	21



## 1.0 INTRODUCTION

- The **WBW** range provides accurate, fast and versatile general purpose weighing scales with check-weighing functions.
- There are four series within the range- **WBW..M**, **WBW..**, **WBW..a** and **WBW..aM**
- The **WBW..M** scales are configured at the factory for compliance with EN 45501, OIML R-76. Type Approval Number T7476/TC7477.
- The **WBW..aM** are NTEP approved. NTEP certificate 10-082. Approved scales have different capacities and readabilities from the standard WBW series.
- The **WBW** series are similar to the **WBWa** series except the **WBW** scales are usually set for metric units, whereas for the **WBWa** series are usually set for imperial units. However, the user can change the setting as explained in section 13.2.
- All have stainless steel weighing platforms on an ABS plastic base assembly which is sealed to IP 65, making it water-proof.
- All scales have sealed keypads with colour coded membrane switches and the displays are large easy to read liquid crystal type displays (LCD) supplied with a backlight. The scales can be supplied with an optional rear display.
- The scales include automatic zero tracking, audible alarm for pre-set weights and semi-automatic tare.



## 2.0 SPECIFICATIONS

### EC Type Approved Models (Type Approval Number T7476/TC7477)

	WBW 3M	WBW 6M	WBW 15M
<b>Kilograms</b>			
Max	3 kg	6 kg	15 kg
e =	0.001 kg	0.002 kg	0.005 kg
<b>Grams</b>			
Max	3000 g	6000 g	15000 g
e =	1 g	2 g	5 g

### NTEP Type Approved Models (Type Approval number 10-082)

	WBW 6aM	WBW 15aM	WBW 30aM
<b>Pounds</b>			
Max	6 lb	15 lb	30 lb
e =	0.002 lb	0.005 lb	0.01 lb
<b>Grams</b>			
Max	3 kg	6 kg	15 kg
e =	0.001 kg	0.002 kg	0.005 kg

	WBW 2 / 5a	WBW 4 / 9a	WBW 8 / 18a	WBW 16 / 35a
<b>Kilograms</b>				
Maximum Capacity	2.000 kg	4.000 kg	8.000 kg	16.000 kg
Tare Range	-2.000 kg	-4.000 kg	-8.000 kg	-16.000 kg
Readability	0.0002 kg	0.0005 kg	0.001 kg	0.002 kg
Repeatability (S.D.)	0.0002 kg	0.0005 kg	0.001 kg	0.002 kg
Linearity (±)	0.0004 kg	0.001 kg	0.002 kg	0.004 kg
<b>Grams</b>				
Maximum Capacity	2000 g	4000 g	8000 g	16000 g
Tare Range	-2000 g	-4000 g	-8000 g	-16000 g
Readability	0.2 g	0.5 g	1 g	2 g
Repeatability (S.D.)	0.2 g	0.5 g	1 g	2 g
Linearity (±)	0.4 g	1 g	2 g	4 g
<b>Pounds</b>				
Maximum Capacity	5 lb	9 lb	18 lb	35 lb
Tare Range	-5 lb	-9 lb	-18 lb	-35 lb
Readability	0.0005 lb	0.001 lb	0.002 lb	0.005 lb
Repeatability (S.D.)	0.0005 lb	0.001 lb	0.002 lb	0.005 lb
Linearity (±)	0.001 lb	0.002 lb	0.004 lb	0.01 lb
<b>Ounces</b>				
Maximum Capacity	80 oz	144 oz	288 oz	560 oz
Readability	0.01 oz	0.02 oz	0.05 oz	0.1 oz
Repeatability (S.D.)	0.01 oz	0.02 oz	0.05 oz	0.1 oz
Linearity (±)	0.02 oz	0.04 oz	0.1 oz	0.2 oz

<b>Pounds:Ounces</b>				
Maximum Capacity	5 lb: 0.00 oz	9 lb:0.00 oz	18 lb:0.0 oz	35 lb: 0.0 oz
Readability	0.01 oz	0.02 oz	0.1 oz	0.1 oz
Repeatability (S.D.)	0.01 oz	0.02 oz	0.1 oz	0.1 oz
Linearity (±)	0.02 oz	0.04 oz	0.2 oz	0.2 oz

## OTHER SPECIFICATIONS

Units of measure	WBW..M    kg, g WBW..aM    lb, kg, <b>g, oz</b> WBW/WBW..a    kg, g, lb, oz, lb:oz
Tare	Full range
Stabilisation Time	2 seconds typical
Operating Temperature	-10°C to 40°C
Power supply	12 VDC, 800 mA Through an external Power Supply Module
Battery	Internal rechargeable battery (~50 hours operation)
Calibration	Automatic External
Display	6 digits LCD digital display with capacity tracker and symbols for units
Scale Housing	IP 65 Sealed ABS Plastic housing with Stainless Steel pan
Pan Size	210 x 173 mm
Overall Dimensions (wxdxh)	231 x 265 x 153 mm
Net Weight	3.3 kg / 7.26 lb
Applications	Weighing Scales
Functions	Weighing, Check weighing

**WARNING:** The **WBW..M** and **WBW..aM** scales should not be calibrated by the user. Calibration of the scales may make it illegal to use the scales. The scales are sealed to prevent unauthorised access to the circuit boards inside the scale. Any modifications done to the mechanisms inside by breaking the security seals may make it illegal to use the scale. If the seals are broken or tampered with, the scale needs to be re-verified by an authorised certification body and re-sealed, before it is used legally. Contact your local metrology standards office for further assistance.

## 3.0 INSTALLATION

### 3.1 UNPACKING

Remove the scale from the packing carefully. Inside the box you will find everything needed to start using the scale-

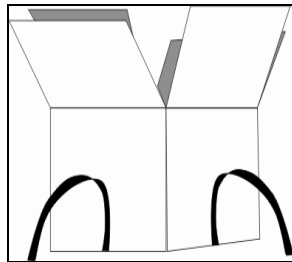

- ✓ Pre-assembled scale
- ✓ Stainless steel top pan
- ✓ Power Supply Module
- ✓ Operators Manual

### 3.2 LOCATING

	<ul style="list-style-type: none"><li>• The scales should not be placed in a location that will reduce the accuracy.</li><li>• Avoid extremes of temperature. Do not place in direct sunlight or near air conditioning vents.</li></ul>
	<ul style="list-style-type: none"><li>• Avoid unsuitable tables. The table or floor must be rigid and not vibrate.</li><li>• Avoid unstable power sources. Do not use near large users of electricity such as welding equipment or large motors.</li></ul>
	<ul style="list-style-type: none"><li>• Do not place near vibrating machinery.</li><li>• Avoid air movement such as from fans or opening doors. Do not place near open windows or air-conditioning vents.</li></ul>
	<ul style="list-style-type: none"><li>• Keep the scales clean. Do not stack material on the scales when they are not in use.</li></ul>



### 3.3 SETTING UP

- The WBW Series comes with a stainless steel pan. Place it on the top if already not installed.
- **Do not** press with excessive force as this could damage the load cell inside.
- Level the scale by adjusting the four feet. The scale should be adjusted such that the bubble in the spirit level is in the centre of the level and the scale is supported by all four feet.

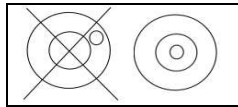

- Attach the power supply module to the bottom of the scale and plug into the mains.

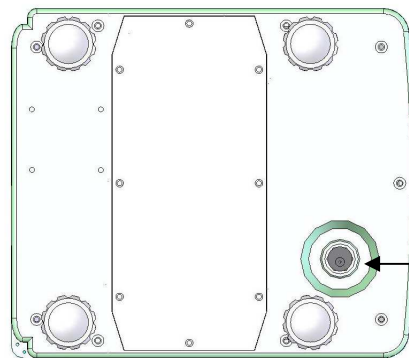

Attach Power Supply module here

- Press the **[O/I]** key to start. The scale will first display the software revision, followed by a self-test.

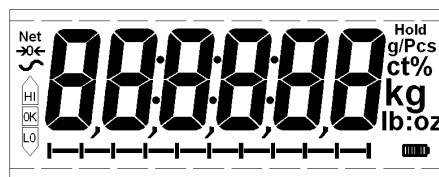

- At the end of the self-test it will display zero weight, if the zero condition has been achieved and the weighing unit that was in use last. A stable and zero symbol indicators are also displayed.

## 4.0 KEYPAD

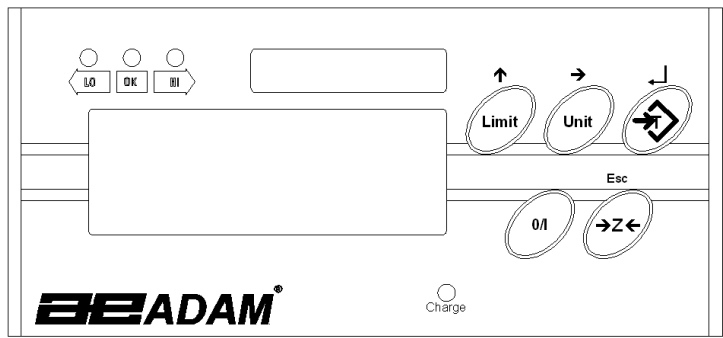

KEYS	PRIMARY FUNCTION	SECONDARY FUNCTION
[0/I]	Switches the scale on or off	
[Zero]	Sets the zero point for all subsequent weighing. The display shows zero.	Escapes from a parameter or an option without changing the value.
[Tare]	Tares the scale and stores the current weight in memory as a tare value, subtracts the tare value from the total weight and shows the results. This is the net weight.	Enters the selected parameter or value for setting.
[Unit]	Selects the weighing units from a preset list of available units.	Shifts the flashing digit to the next digit when entering a value.
[Limit]	Sets the limits for check weighing and allows setting of either the low limit or the high limit or both.	Increments the flashing digit or moves to the next option during setting.

### 4.1 NUMERIC ENTRY METHOD

To set a value when required, use the keys as given below-

- [Limit] key to increase the flashing digit,
- [Unit] key to move to the next digit and
- [Tare] key to accept the value

## 5.0 DISPLAY

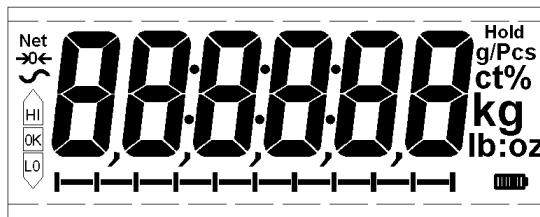

The LCD will display a decimal point in the **WBW..a** and **WBW..aM** models or a comma as shown in the **WBW** and **WBW..M** models.

## 6.0 SYMBOLS AND INDICATORS

The LCD has unique symbols to indicate the following:

→0←	The display is at Zero
S	The scale is Stable
Net	Net weight- The scale has been tared
kg / g / lb / oz / lb:oz	Symbols shown for the units
	Capacity Tracker- A bar graph indicating the proportion of the scale capacity being used by the weight on the pan
bAt LO	Low battery
■■■■	Indicates full battery strength. Will show less number of bars for weaker strength.
HI, OK, LO	The scale is in Check weighing mode
:	The colons “:” are used to separate pounds from ounces

Above the LCD to the left, there are three LED’s that indicates when the weight is below, within or over the pre-set limits during check weighing.

Weight	LED	LCD
Below the low limit	Red	LO
Within the limits	Green	OK
Above the high limit	Amber	HI

## 7.0 BATTERY OPERATION

- The scales can be operated from the battery, if desired. The battery life is approximately 50 hours.
- When the battery needs charging a symbol on the display will turn on. The battery should be charged when the symbol is on. The scale will still operate for about 20 minutes after which it will automatically switch off to protect the battery.
- To charge the battery, simply attach the power supply module to the scale and plug in. The scale does not need to be turned on.
- The battery should be charged for 12 hours for full capacity.
- Below the display is a LED to indicate the status of battery charging. When the scale is plugged into the mains power the internal battery will be charged. If the LED is green the battery is being charged. If it is red it is nearly discharged and yellow indicates the battery is increasing the charge level. Continue to charge overnight for a complete re-charge.

## 8.0 BACKLIGHT

The backlight for the LCD can be set by the user to always off, always on or automatic (on only when the scale is in use or a key is pressed). See setting of the parameter “**S2 bl**” in section 13.2.

## 9.0 AUTO POWER OFF

The auto power off can be set by the user to disable the feature or to a pre-set time interval. See setting of the parameter “**S3 Aof**” in section 13.2.

## 10.0 OPERATIONS

### 10.1 ZEROING

- You can press the **[Zero]** key at any time to set the zero point from which all other weighing and counting is measured. This will usually be necessary when the platform is empty. When the zero point is obtained the display will show the zero indicator.



- The scale has an automatic re-zeroing function to account for minor drifting or accumulation of material on the platform. However you may need to press **[Zero]** to re-zero the scale if small amount of weight is still shown when the platform is empty.

### 10.2 TARING

- Zero the scale by pressing **[Zero]**. The zero indicator will be on. Place a container on the pan and its weight will be displayed.
- Press **[Tare]** when the reading is stable. The weight that was displayed is stored as the tare value and it is subtracted from the display, leaving zero on the display. The stable and **Net** indicator will be on.



- As a product is added only the weight of the product will be shown. The scale could be tared a second time if another type of product was to be added to the first one. Again only the weight that is added after taring will be displayed.



## **NOTE:**

When the container is removed a negative value will be shown. If the scale was tared just before removing the container, this value is the gross weight of the container plus all products which were removed. The zero indicator will also be on as the platform is back to the same condition it was when **[Zero]** was pressed last.

Press **[Tare]** or **[Zero]** to remove the tare value and display zero. The **Net** indicator will disappear.

## **10.3 WEIGHING**

To determine the weight of a sample, first tare an empty container if used, then place the sample in the container. The display will show the weight and the unit of weight currently in use.





To change the weighing unit press the **[Unit]** key. The available weighing units are the ones that are enabled by the user in the parameters section. See section 13.2.

## **10.4 CHECK-WEIGHING**

Check-weighing is a procedure to show a display or cause a beeper to sound when the weight on the scale meets or exceeds the values stored in memory. The memory holds values for a high limit and a low limit. Either or both the limits can be used.

## **NOTE:**

1. The beeper and the LEDs can each be set to OFF (See section 13.1). The LCD display will indicate whenever the weight is within or exceeds the limits by showing '**OK**', '**HI**' or '**LO**'.

	Mass on the balance is above the high limit
	Mass is between the limits
	Mass is below the low limit

2. The limits can be locked by the manager. A Limit Password must be used to change the limits or recall other limits from memory.
3. If Limit Password is enabled then enter the password which will allow you to change the limits or the operation of the beeper or bargraph.

### Setting up Check-weighing

- Press the **[Limit]** key. It will show the last used high limit.
- The user will be asked for the password if the current check-weighing password is anything other than “0000”. See the parameter “**F4 PS**” in section 13.1. Enter the correct password using the numeric entry method as mentioned in section 4.1. If the password is “0000” it will display the last used high limit. The “HI” symbol will appear on the display.
- Press **[Tare]** to accept the displayed high limit or enter the new high limit using the numeric entry method (see section 4.1). When the desired value is entered press **[Tare]** to accept the value. The “LO” symbol will be on. Display will show the last used low limit. Set the low limit in the same way the high limit was set.
- Pressing the **[Tare]** key will return the scale to weighing, with the Check-weighing function enabled.

**NOTE:** The limits are displayed in the weighing unit in use. The decimal point is fixed at the position that is used for the current weighing unit. If the weighing unit is pounds:ounces, the limits are entered in pounds and decimal parts of pounds. i.e. 6,0125 lb.

## 10.5 LIMITS STORED IN MEMORY

If the scale is turned off it stores the last high and low limits in the memory along with information about the weighing unit in use when the limits were stored. If the scale is turned on again, the limits and the weighing unit will be active.

## 11.0 RS-232 INTERFACE

The RS-232 is not available in WBW scales.

## 12.0 CALIBRATION

### 12.1 WBW..M and WBW..aM APPROVED SCALES, CALIBRATION

The scales are sealed to prevent unauthorised access to the circuit boards and load cell.

One method calibration of the WBW-M scale is accomplished by breaking the security seals to gain access to the circuit boards inside. See the figures on the security seal as given below.

**WARNING:** BREAKING OF THE SEALS MAY MAKE IT ILLEGAL TO USE THE SCALES FOR SALES OF GOODS. CONTACT YOUR TRADING STANDARDS OFFICE FOR FURTHER ASSISTANCE.

### 12.2 SECURITY SEALS

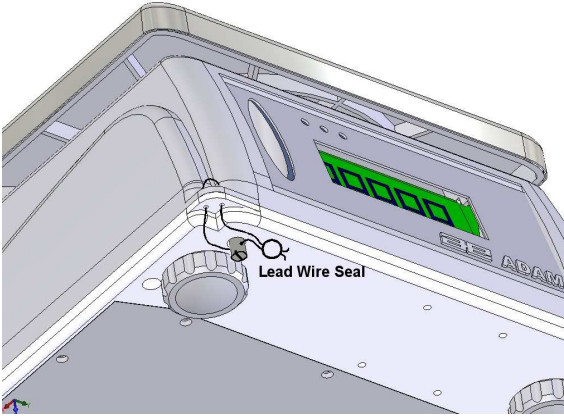
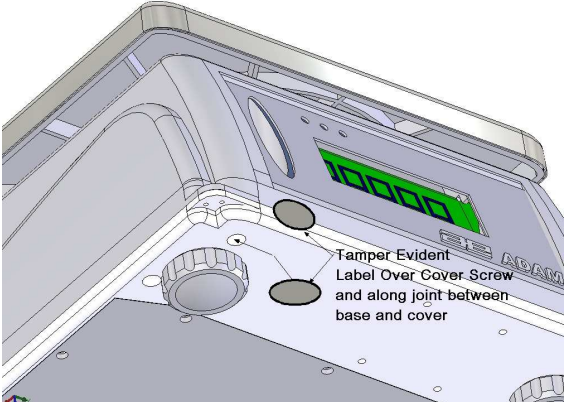
<p>Method of sealing</p>  <p>Lead Wire Seal</p>	<p>The scale has got metallic loops on the base and the cover, located at the right rear corner as shown here. A metal pin or wire can be passed through the loops and sealed using a lead-wire seal. Ensure the seal is secured enough to prevent removing the cover without breaking the seal or damaging the enclosure.</p>
<p>Alternative method</p>  <p>Tamper Evident Label Over Cover Screw and along joint between base and cover</p>	<p>An alternative method would be to use tamper-evident labels over the screw on the bottom cover and over the joint between the top and the bottom cover as shown in the adjacent figure.</p> <p>Metrology labels and additional security measures may be added to the scale as required by the national legislation.</p>

**NOTE:** IF THIS SEAL IS BROKEN THE SCALE MUST BE RE-SEALED BY THE RELEVANT AUTHORITIES USING EITHER THE LEAD WIRE SEAL OR AN ACCEPTABLE SEAL BETWEEN THE COVER AND THE BASE.



**WBW..aM SECURITY SEALS:** The device is equipped with a Category 1 Audit Trail. In addition a lead & wire and/or a paper security seal may be installed. To access the audit trail press the **[Zero]** button for 3 seconds. The display will flash the calibration counter and the configuration counter.

### 12.3 CALIBRATION COUNTER

The scales are sealed to prevent unauthorised calibration. However it is possible to calibrate the scales as the software includes a counter to keep track of how many times the scale has been calibrated and this value is recorded on the scale so that future inspections can see if the scale has had the counters incremented.

Refer to the WBW-M Service Manual for details of calibration procedures.

### 12.4 WBW SERIES , NOT APPROVED

The **WBW** non-approved scales are calibrated using metric weights when the weighing unit selected is either kilograms or grams and using pound masses when the weighing unit selected is either pounds, ounces or pounds:ounces.

#### Method

- To start the calibration turn the scale off and then turn it on again. Press **[Tare]** during the self-test. Scale will show "P- - - ". Enter code number "**0000**" using the numeric entry method (see section 4.1) and press **[Tare]**. This will take you directly to the calibration section.
- Display will show "**UnLoAd**".
- Remove all weight from the pan and then press the **[Tare]** key when the scale is stable.
- After the Zero point is set, the display will show "**Ld xx**". Place the suggested calibration mass on the pan. It is best to use a weight close to the full capacity of the scale. If the mass is different from the displayed value, enter the value of the mass in whole numbers using the numeric entry method (see section 4.1). The kg or the lb symbol will be on to show the active unit.

- Press the [**Tare**] key when the stable indicator is on.
- The scale will calibrate to the mass and then return to weighing.
- Remove the calibration weight as soon as calibration is complete.

**NOTE:** If an error message “**FAIL H**” or “**FAIL L**” is shown during calibration, re-check the calibration and repeat, if necessary. If the error cannot be corrected contact your dealer or Adam Equipment for advice.

## 13.0 PARAMETER SETTING

This section allows the user to access the parameters for customising the scale. The parameters are split into 2 groups-

1. Check weighing Parameters
2. Scale Parameters

In the following sections use the **[Limit]** key to scroll through the options, the **[Tare]** key to accept the option and the **[Zero]** key to return to weighing. Wherever numeric values are required to be entered, use the **[Limit]** and **[Unit]** keys to increment the flashing digits as explained in section 4.1.

### 13.1 CHECK WEIGHING PARAMETERS

To enter this section press and hold the **[Limit]** key for 4 seconds. You will be asked for the password if the current check-weighing password is anything other than "0000". See the parameter "**F4 PS**" in this section. Enter the correct password using the numeric entry method as mentioned in section 4.1. If the password is "0000" it will go directly to "**F1 LLK**".

Parameter	Description	Options	Default setting
<b>F1 LLK</b>	Limit Lock will prevent a normal user from changing the check weighing limits. To change the limits, this parameter must be disabled by setting it to off or the user must enter the password.	<b>on</b> <b>off</b>	<b>off</b>
<b>F2 Led</b>	Setting the LED	<b>on</b> <b>off</b>	<b>on</b>
<b>F3 bEP</b>	This parameter sets the Beeper to off or on. If set to on, the beeper can further be set to sound when the weighing result is within or outside the check-weighing limits.	<b>bP off</b> - Off <b>bP inL</b> - Within limits <b>bP otL</b> - Outside limits (>20d)	<b>bP inL</b>
<b>F4 PS</b>	This parameter allows setting of a new Check weighing password, If the old parameter is "0000" enter the new password twice when " <b>P1</b> ___" & " <b>P2</b> ___" are displayed. When complete, it will display	To be entered manually.	<b>0000</b>

	<p><b>“doneE”</b>. If the old parameter is other than “0000”, enter the old one when <b>“P _ _ _ _”</b> is displayed and then enter the new password twice when asked. When complete, it will display <b>“doneE”</b>.</p>		
--	---	--	--

## 13.2 SCALE PARAMETERS

To enter this section press and hold the **[Unit]** key for 4 seconds. The display will go directly to **“S1 Un”**.

These parameters are used to control the operation of the scale.

Parameter	Description	Options	Default setting
<b>S1 Un</b>	Enable or disable weighing units, will not allow to disable all units, at least one has to be enabled.	<b>kg</b> <b>g</b> <b>lb</b> <b>oz</b> <b>lb:oz</b>	<b>kg</b>
<b>S2 bl</b>	Backlight set to always on, always off or automatic on whenever a weight is placed or a key is pressed.	<b>EL off</b> <b>EL on</b> <b>EL AU</b>	<b>EL AU</b>
<b>S3 AoF</b>	Auto Off- Disable or set time increment to turn off scale.	<b>SLP 0</b> <b>SLP 1</b> <b>SLP 5</b> <b>SLP 10</b>	<b>SLP 0</b>
<b>S4 diS</b>	Display all weights or only when stable	<b>ALL</b> <b>StAb</b>	<b>ALL</b>
<b>S5 Fi</b>	Filter setting to slow, normal or fast	<b>Slow</b> <b>nor</b> <b>FAST</b>	<b>nor</b>
<b>S6 AZr</b>	Auto Zero range,	<b>0.5d</b> <b>1.0d</b> <b>1.5d</b>	<b>0.5d</b>

## 14.0 ERROR CODES

During the initial power-on testing or during operation, the scale may show an error message. The meaning of the error messages is described below.

If an error message is shown, repeat the step that caused the message. If the error message is still shown then contact your dealer for support.

ERROR CODE	DESCRIPTION	POSSIBLE CAUSES
<b>Err 4</b>	Initial Zero is greater than allowed (4% of maximum capacity) when power is turned on or when <b>[Zero]</b> is pressed.	Weight on the pan when turning the scale on. Excessive weight on the pan when zeroing the scale. Platform is not installed. Improper calibration of the scale. Damaged load cell. Damaged Electronics.
<b>Err 6</b>	A/D count is not correct when turning the scale on.	Load cell is damaged. Electronics is damaged.
<b>Err 8</b>	High limit input error	Low limit is set first, then the high limit is set lower than the low limit and high limit not equal to zero.
<b>Err 9</b>	Low limit input error	High limit is set first, then the low limit is set higher than the high limit and low limit not equal to zero.
<b>FAIL H</b> or <b>FAIL L</b>	Calibration error	Improper calibration (should be within $\pm 10\%$ of the factory calibration). The old calibration data will be retained until the calibration process is complete.

## 15.0 REPLACEMENT PARTS AND ACCESSORIES

If you need to order any spare parts and accessories, contact your supplier or Adam Equipment. A partial list of such items is as follows-

- **Power Supply Module**
- **Replacement Battery**
- **Stainless Steel Pan**

## 16.0 SERVICE INFORMATION

This manual covers the details of operation. If you have a problem with the scale that is not directly addressed by this manual then contact your supplier for assistance. In order to provide further assistance, the supplier will need the following information which should be kept ready:

### **A. Details of your company**

- Name of your company:
- Contact person's name:
- Contact telephone, e-mail, fax or any other methods:

### **B. Details of the unit purchased**

(This part of information should always be available for any future correspondence. We suggest you to fill in this form as soon as the unit is received and keep a print-out in your record for ready reference.)

<b>Model name of the scale:</b>	<b>WBW</b> _____
<b>Serial number of the unit:</b>	
<b>Software revision number (Displayed when power is first turned on):</b>	
<b>Date of Purchase:</b>	
<b>Name of the supplier and place:</b>	

### **C. Brief description of the problem**

Include any recent history of the unit. For example:

- Has it been working since it's delivered
- Has it been in contact with water
- Damaged from a fire
- Electrical Storms in the area
- Dropped on the floor, etc.

## 17.0 WARRANTY INFORMATION

Adam Equipment offers Limited Warranty (Parts and Labour) for the components failed due to defects in materials or workmanship. Warranty starts from the date of delivery.

During the warranty period, should any repairs be necessary, the purchaser must inform its supplier or Adam Equipment Company. The company or its authorised Technician reserves the right to repair or replace the components at any of its workshops depending on the severity of the problems. However, any freight involved in sending the faulty units or parts to the service centre should be borne by the purchaser.

The warranty will cease to operate if the equipment is not returned in the original packaging and with correct documentation for a claim to be processed. All claims are at the sole discretion of Adam Equipment.

This warranty does not cover equipment where defects or poor performance is due to misuse, accidental damage, exposure to radioactive or corrosive materials, negligence, faulty installation, unauthorised modifications or attempted repair or failure to observe the requirements and recommendations as given in this User Manual. Additionally rechargeable batteries (where supplied) are not covered under warranty.

Repairs carried out under the warranty does not extend the warranty period. Components removed during the warranty repairs become the company property.

The statutory right of the purchaser is not affected by this warranty. The terms of this warranty is governed by the UK law. For complete details on Warranty Information, see the terms and conditions of sale available on our web-site.



Adam Equipment

ADAM EQUIPMENT, BOND AVENUE, DENBIGH EAST INDUSTRIAL ESTATE, MILTON KEYNES, MK1 1SW, U.K.

Tel: (01908) 274545 Fax: (01908) 641339
Intl Tel: -44 1908 -274545 Intl Fax: -44 1908 641339
E-Mail Address: info@Adamequipment.co.uk

Table with CE mark and multilingual Declaration of Conformity text: Declaration of Conformity, Verklaring van overeenstemming, Dichiarazione di Conformità, Declaración de Conformidad.

The non-automatic weighing instrument
Die nicht-automatischen Wägeapparate
L'instrument de pesage à fonctionnement non automatique

Het niet-automatische weegwerktuig
Strumento per pesatura non automatico
Instrumento para pesaje non automatico



Large table with 6 columns and 7 rows, containing manufacturer details, type (WBW..M), certificate number (T7476/TC7477), and technical specifications in multiple languages.

Large table with 6 columns and 7 rows, containing manufacturer details, type (WBW..M), certificate number (T7476/TC7477), and technical specifications in multiple languages.

Signature
Unterschrift
Signature
Handtekening
Firma
Firma

J.S. Cumbach
Technical Manager

Date
Datum
Date
Datum
Date
Fache
22 July 2011



# Parameter Layout for WBW Scales

Keys (general description of the key functions while in this section):

**[Tare]** - enter a parameter / accept changed value

**[Limit]** - move to next parameter

**[Zero]** - return to previous / return to normal weighing (may not save changes)

\_\_\_\_\_ (Check weighing Parameters) \_\_\_\_\_ (Scale Parameters)

(Press the **[Limit]** key for 4 seconds while in the normal weighing to enter this section)

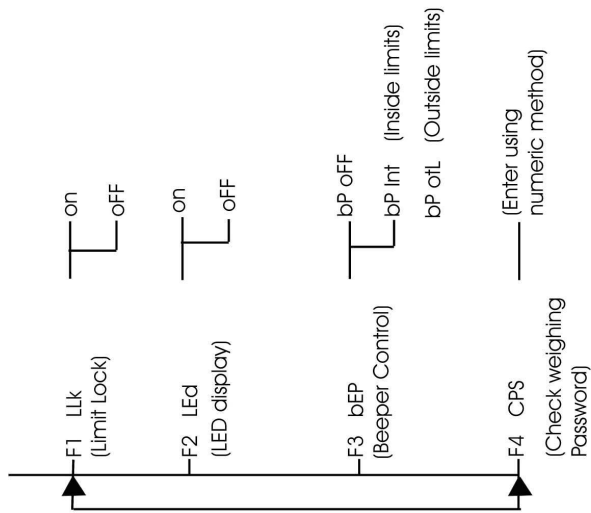

(Press the **[Unit]** key for 4 seconds while in the normal weighing to enter this section)

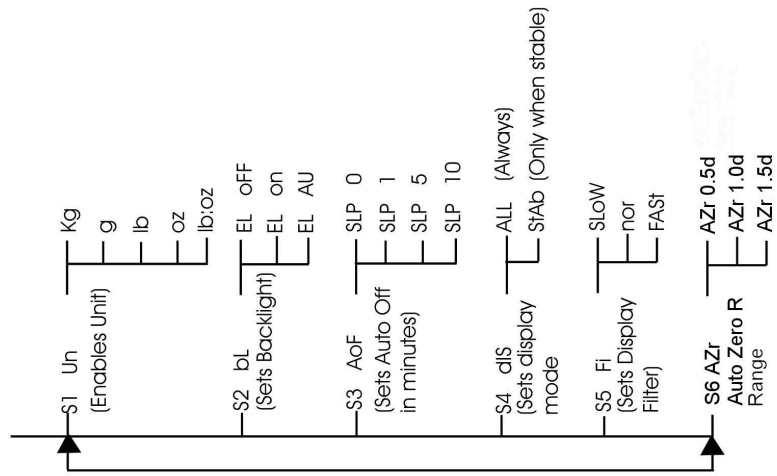





### Manufacturer's Declaration of Conformity

This product has been manufactured in accordance with the harmonised European standards, following the provisions of the below stated directives:

2011/65/EC (RoHS) Restriction of the use of certain hazardous substances in electrical and electronic equipment

Electro Magnetic Compatibility Directive 2004/108/EC

Low Voltage Directive 2006/95/EC

Adam Equipment Co. Ltd.,  
Maidstone Road, Kingston,  
Milton Keynes, MK10 0BD  
United Kingdom

### FCC COMPLIANCE

This equipment has been tested and found to comply with the limits for a Class A digital device, pursuant to Part 15 of the FCC Rules. These limits are designed to provide reasonable protection against harmful interference when the equipment is operated in a commercial environment. The equipment generates, uses, and can radiate radio frequency energy and, if not installed and used in accordance with the instruction manual, may cause harmful interference to radio communications. Operation of this equipment in a residential area is likely to cause harmful interference in which case the user will be required to correct the interference at his own expense.

Shielded interconnect cables must be employed with this equipment to insure compliance with the pertinent RF emission limits governing this device.

Changes or modifications not expressly approved by Adam Equipment could void the user's authority to operate the equipment.

### WEEE COMPLIANCE

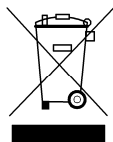

Sealed Lead Acid  
Battery  
Must be recycled  
Properly

Any Electrical or Electronic Equipment (EEE) component or assembly of parts intended to be incorporated into EEE devices as defined by European Directive 2002/95/EEC must be recycled or disposed using techniques that do not introduce hazardous substances harmful to our health or the environment as listed in Directive 2002/95/EC or amending legislation. Battery disposal in Landfill Sites is more regulated since July 2002 by regulation 9 of the Landfill (England and Wales) Regulations 2002 and Hazardous Waste Regulations 2005. Battery recycling has become topical and the Waste Electrical and Electronic Equipment (WEEE) Regulations are set to impose targets for recycling.

**ADAM EQUIPMENT** is an ISO 9001:2008 certified global company with more than 40 years experience in the production and sale of electronic weighing equipment.

Adam products are predominantly designed for the Laboratory, Educational, Health and Fitness, retail and Industrial Segments. The product range can be described as follows:

- Analytical and Precision Balances
- Compact and Portable Balances
- High Capacity Balances
- Moisture analysers / balances
- Mechanical Scales
- Counting Scales
- Digital Weighing/Check-weighing Scales
- High performance Platform Scales
- Crane scales
- Health and Fitness Scales
- Retail Scales for Price computing

For a complete listing of all Adam products visit our website at  
[www.adamequipment.com](http://www.adamequipment.com)

© Copyright by Adam Equipment Co. All rights reserved. No part of this publication may be reprinted or translated in any form or by any means without the prior permission of Adam Equipment.

Adam Equipment reserves the right to make changes to the technology, features, specifications and design of the equipment without notice.

All information contained within this publication is to the best of our knowledge timely, complete and accurate when issued. However, we are not responsible for misinterpretations which may result from the reading of this material.

The latest version of this publication can be found on our Website.

[www.adamequipment.com](http://www.adamequipment.com)