



# Additel 680 DIGITAL PRESSURE GAUGE

**Additel** ADT 680 Digital Pressure Gauge

————— **User's Manual**

[Version No.: 1612V14]



**Additel Corporation**

# CONTENTS

1. Introduction.....	1
2. Basic structure.....	1
3. Keypad.....	2
4. Display .....	3
5. Start-up screen.....	3
6. Menu setup and configuration.....	4
7. Calibration.....	8
8. Troubleshooting.....	12
9. Custom Unit Entry.....	13
10. Specifications.....	15
11. Warning.....	19
12. FCC Declaration of Conformity.....	20
13. Battery installation.....	22
14. Ordering information.....	23
15. Appendix I– Data logging.....	24

## 1 Introduction

The ADT680 digital pressure gauge is a rugged wireless data logging pressure gauge that can log in real time, or data which can be stored and downloaded later via wireless communication. The compact industrial design and advanced technology makes the ADT680 as an ideal pressure measurement tool. The ADT680 combines a variety of accuracy levels with a robust IP67 water-and-dust proof casing. It can be used either as a pressure reference or an applications where high accuracy measurement is required.

## 2 Basic structure

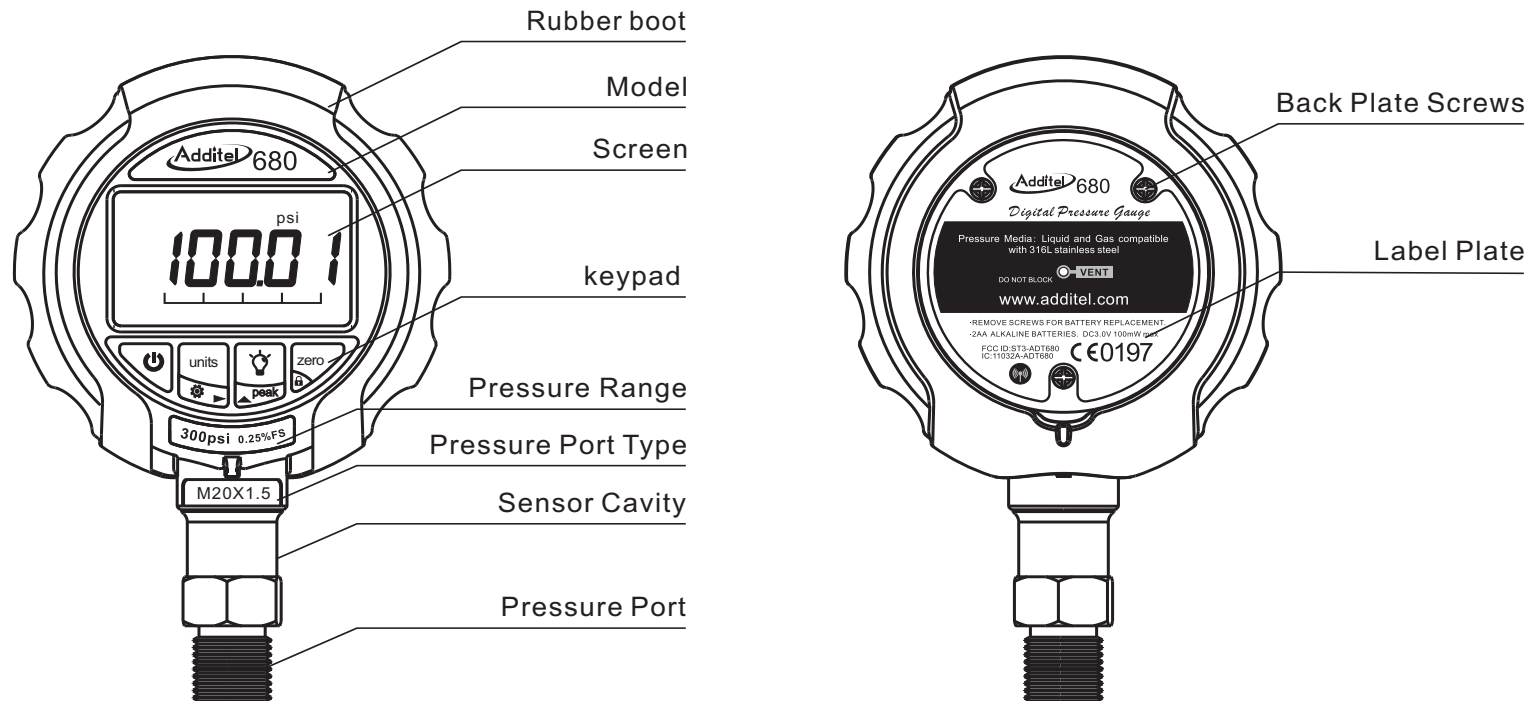

### 3 keypad

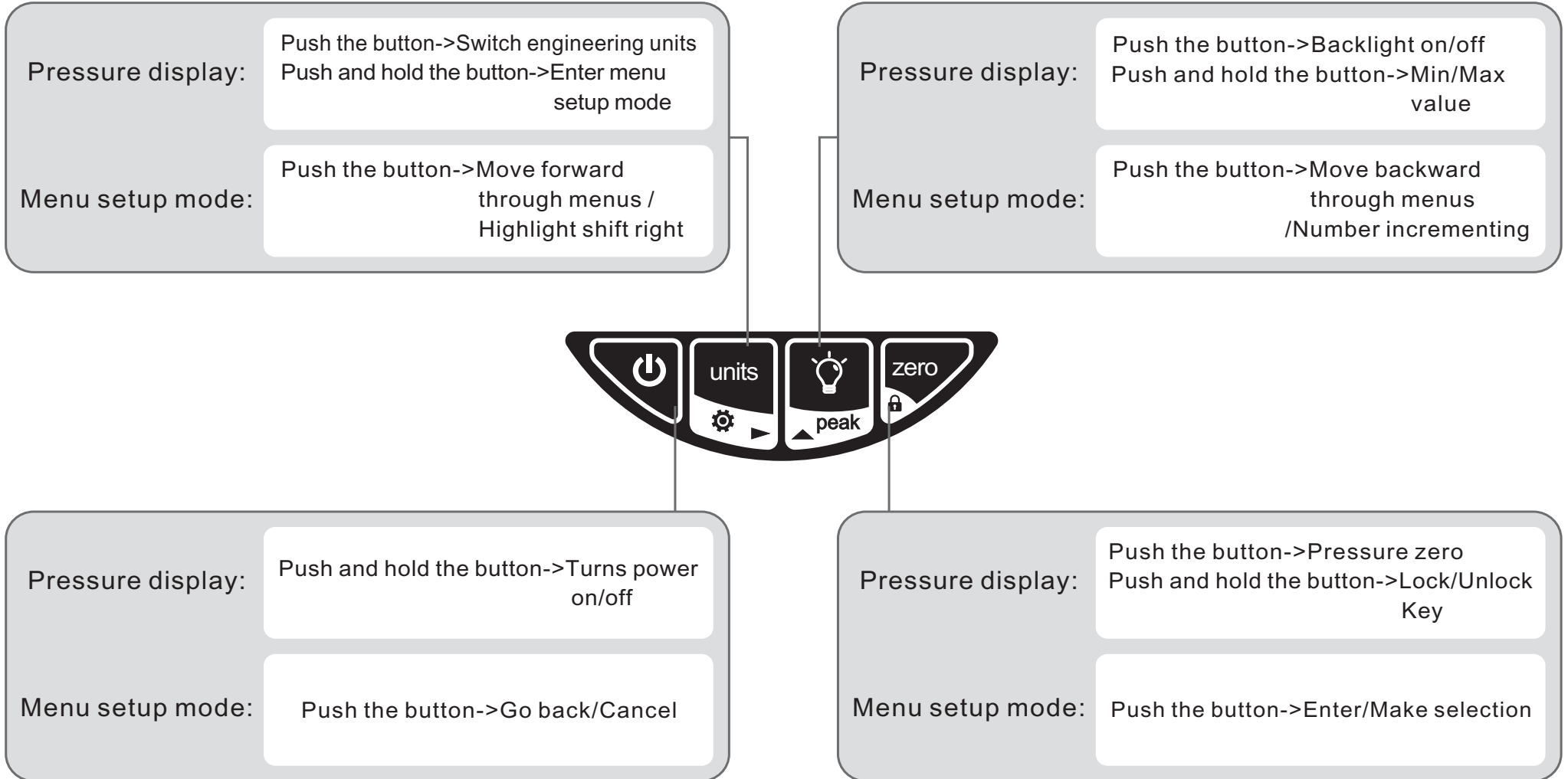

### 4 Display

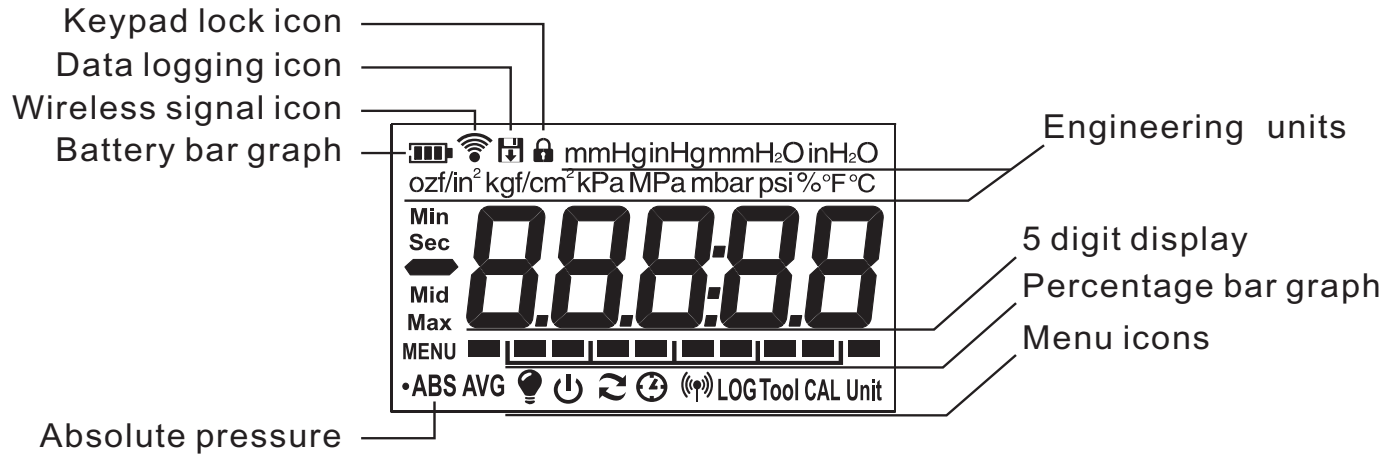

### 5 Start-up screen

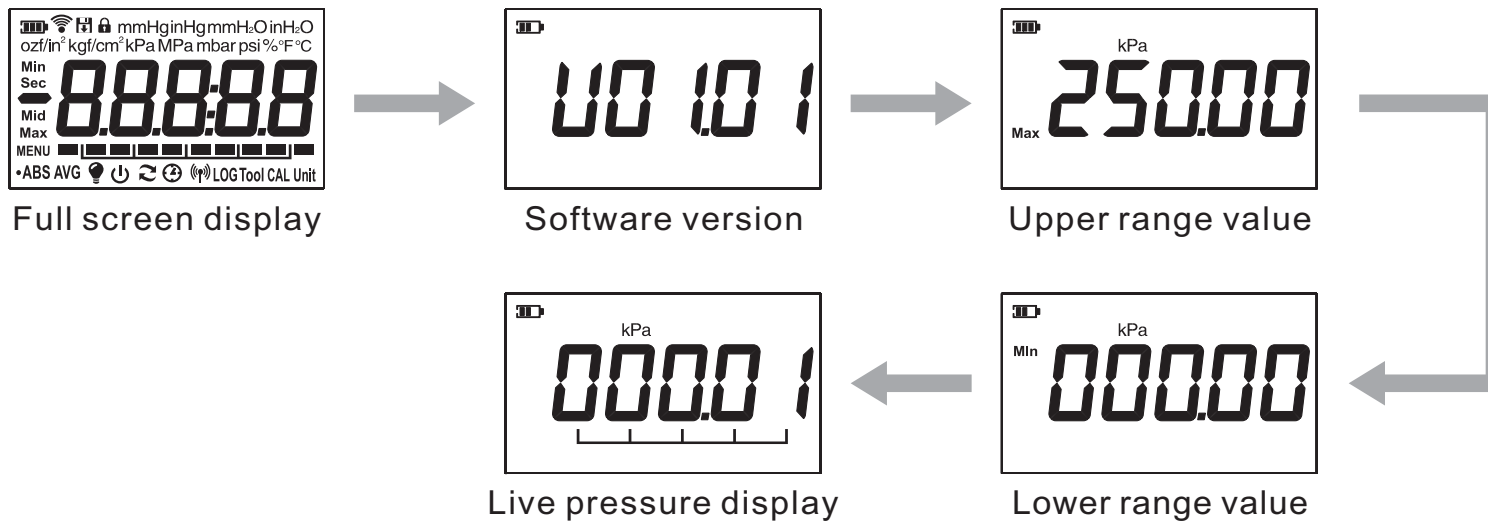

## 6 Menu setup and configuration

### 6.1 Menu structure

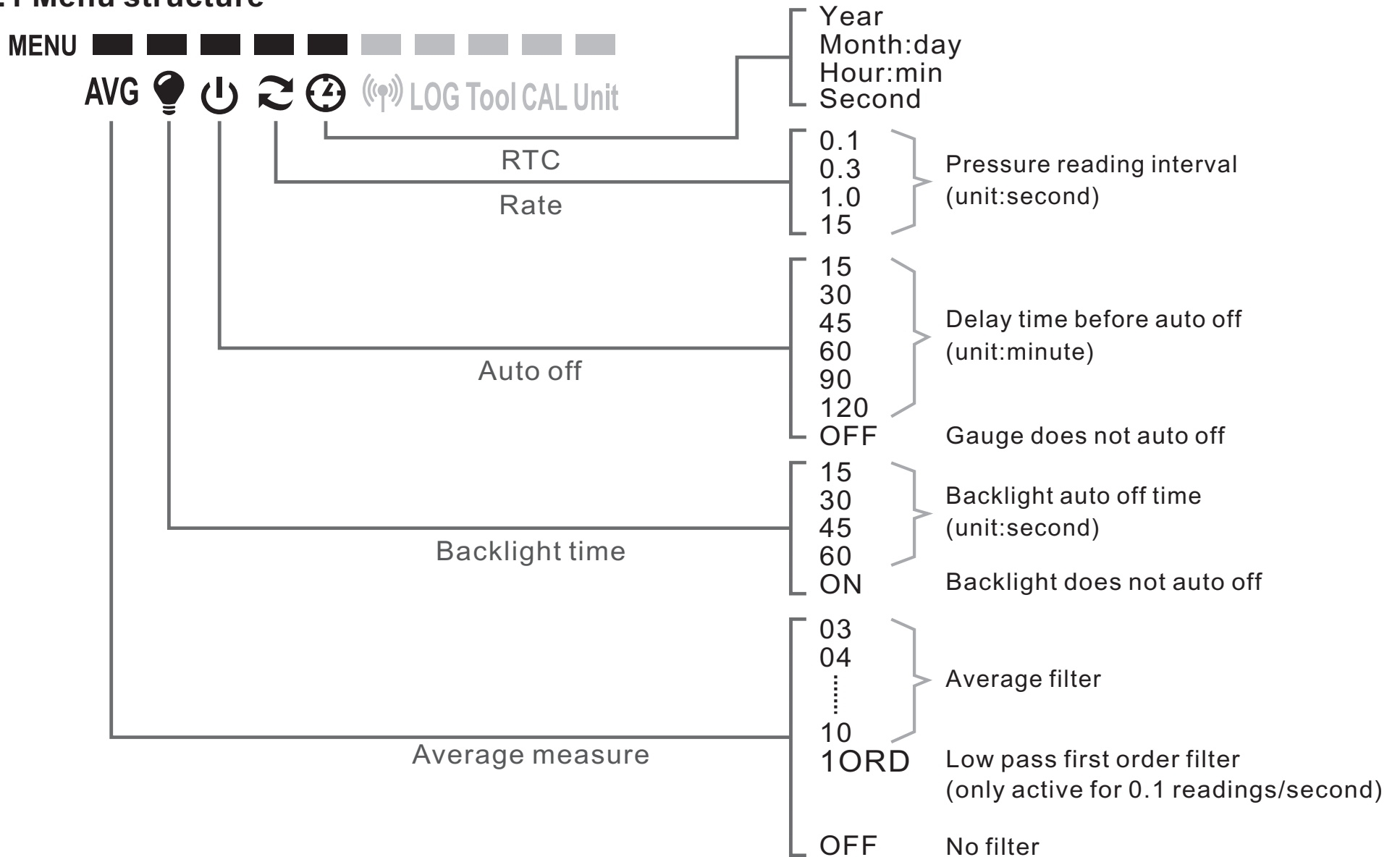

MENU ■ ■ ■ ■ ■ ■ ■ ■ ■ ■

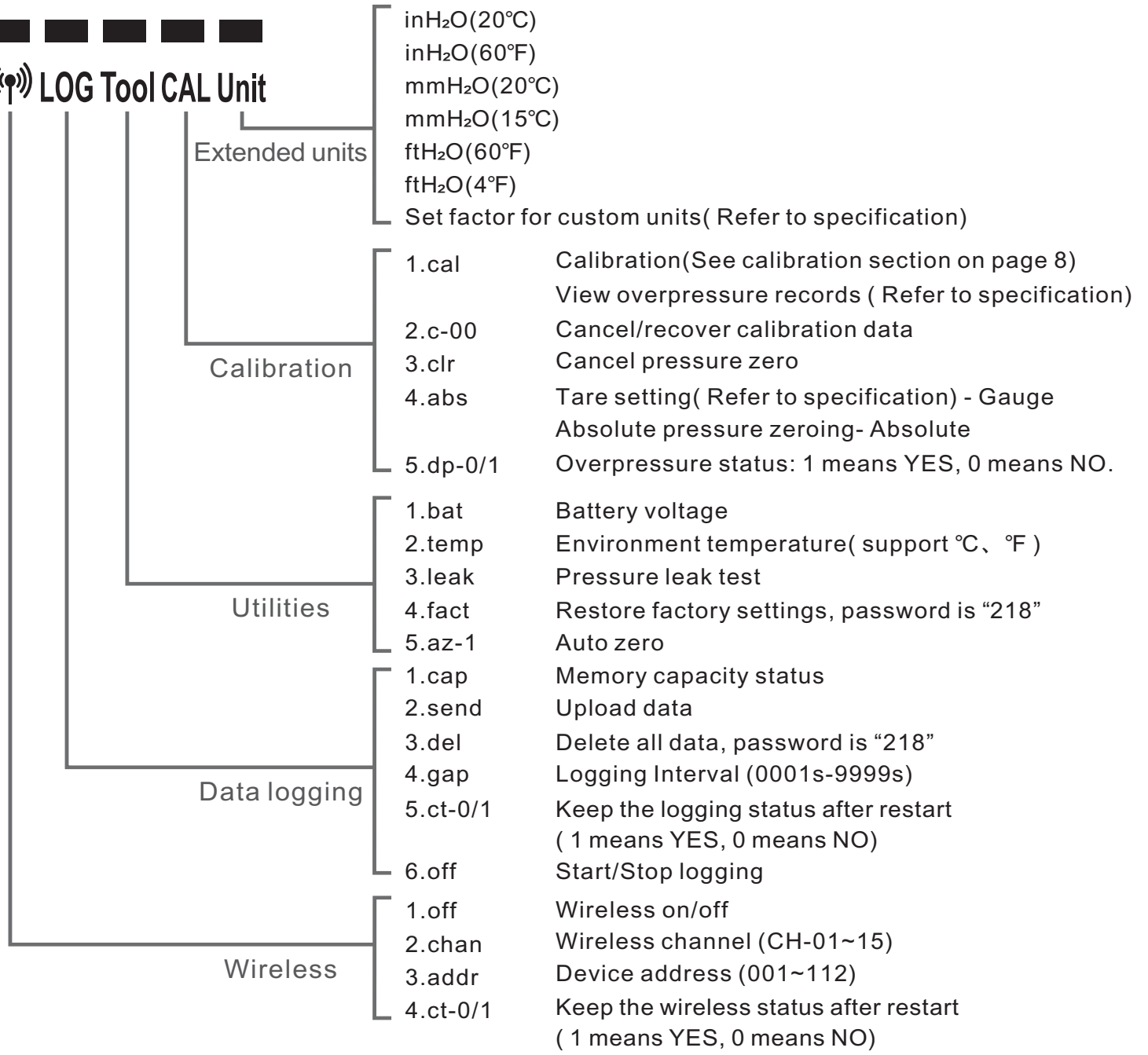

AVG      LOG Tool CAL Unit





## 6.2 Menu operation

### 6.2.1 Enter /Return

Push and hold  button in the pressure display mode to enter menu setup mode.  
Push  button in menu setup mode to return to previous menu.

**Example:**

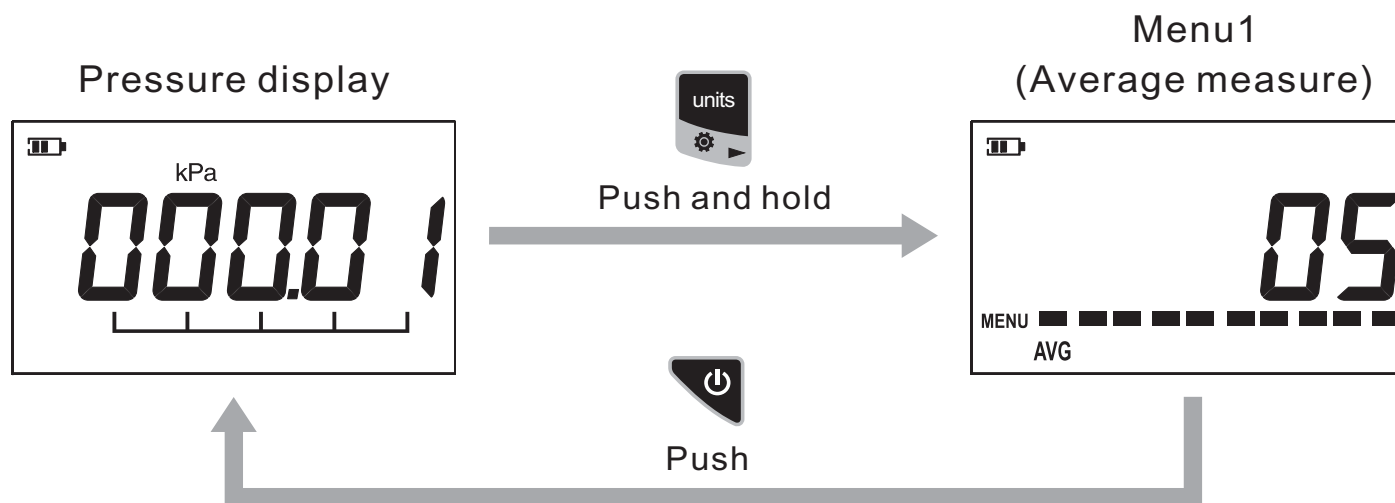

### 6.2.2 Switch menu item

Push  and  button to move forward or backward through the menus:

MENU          

AVG      LOG Tool CAL Unit

**Example:**



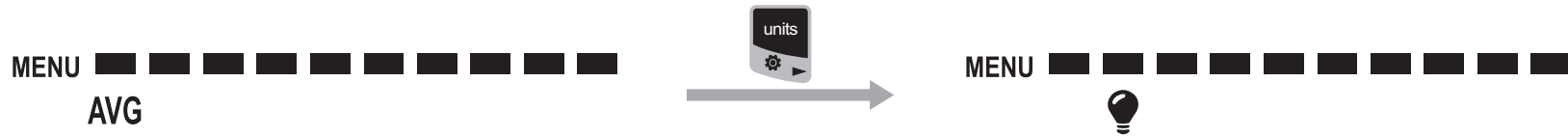

Move menu1(Average measure) forward to menu2(Backlight setup)

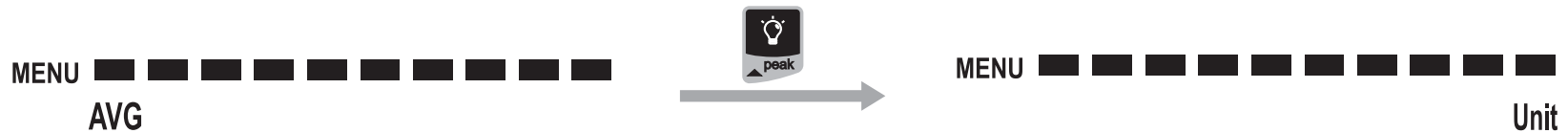

Move menu1(Average measure) backward to menu10(Extended units)





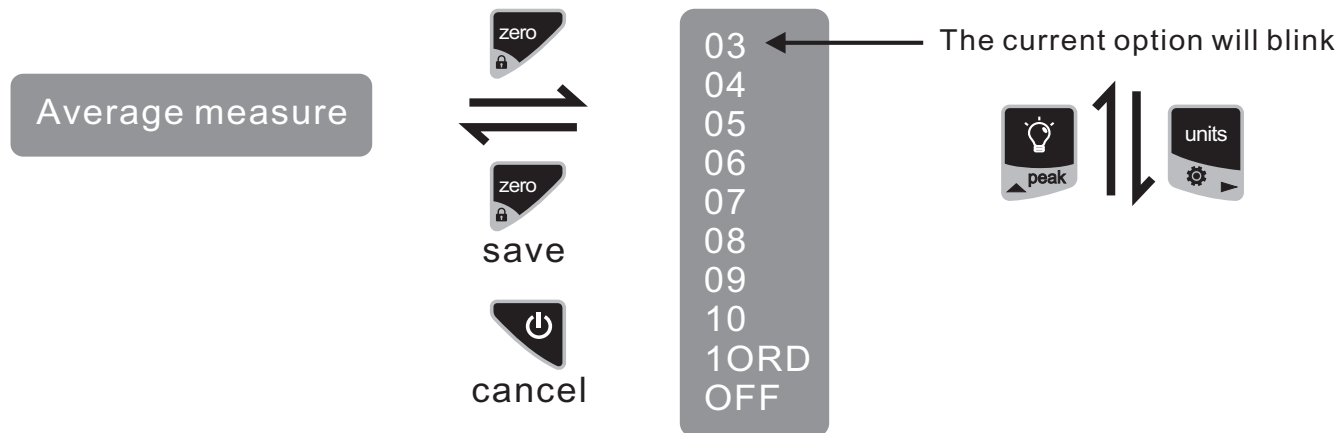

6.2.3 Submenu setup

Push  to access submenu setup, push  or  to view options, then push  to select an option, or push  to recover former option.

**Example:**



### 6.2.4 Number inputting introduction

-  Highlight shift right
-  If number incrementing exceeds the maximum display, it will return to 0
-  Confirm the inputted number
-  (ESC)Cancel the inputted number

If need to input minus sign "-", push and hold  button.

## 7 Calibration

It is recommended that the ADT680 be calibrated annually in a lab traceable to national standards. We recommend finding a lab that can offer uncertainties 4 times better than the accuracy of the gauge being tested. We also recommend that, in order to achieve the best calibration results and prior to calibrate the ADT680, it should be pressurized to full scale and back to zero three times.

### 7.1 Calibration conditions

Note: Please make sure during calibration the following conditions are met.

(1) Environment: Temperature:  $20^{\circ}\text{C} \pm 2^{\circ}\text{C}$ ; Relative humidity: (45-75) %;

Atmosphere pressure: (86~106) kPa.

(2) Equipment: Standard pressure source and indicator have a test uncertainty ratio (TUR) of 4:1 or better.

## 7.2 Calibration Points

- (1) Single scale gauge: We recommend at least two pressure calibration points should be used when calibrating the 680 gauge. Usually at 0 and 100% of full scale (Vacuum gauge should use vacuum point).
- (2) Compound pressure gauge: We recommend at least a three points calibration. Usually points will include low end vacuum point, 0 and 100% of full scale.

The calibration points can be changed to meet your requirements, only if it meets the following conditions:

- (1) The first point should be smaller than the second point.
- (2) The second point should be smaller than the third point.

### 7.3 Calibration Process

For a calibration example we will use a (0~100) kPa gauge.



- (1) Access the calibration menu in Menu setup mode (refer to Menus operation section), Figure 1 will display on the screen. Next push  button to enter Menu setup, Figure 2 will be displayed. Input password "218" (refer to Number inputting introduction section) as in Figure 3, and push  button to continue, Figure 4 will be shown.



Figure1





Figure2

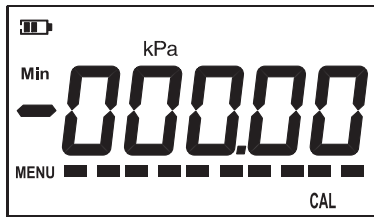

Figure3



Figure4

- (2) Select **1 CAL** and push , the screen will display the lower range of this gauge as shown in Figure 5. The first digit will blink which allows the user to configure the calibration point by inputting the desired pressure value. If no adjustment is needed, just push  to continue;



Flashing, input new calibration point

Figure 5

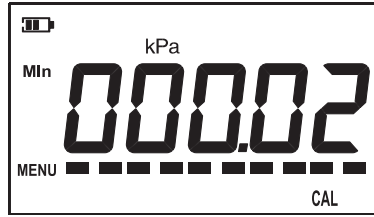

The actual pressure measurement value

Figure 6

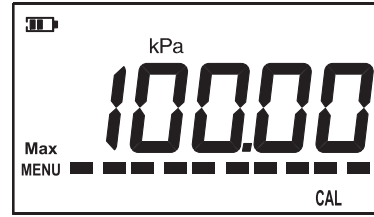

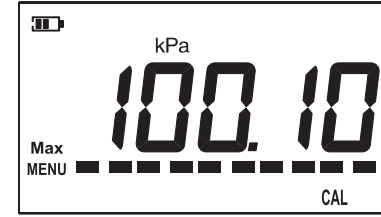

Flashing, input new calibration point

Figure 7



The actual pressure measurement value

Figure 8

(3) To calibrate the lower range point: Use the pressure source to control the lower range pressure, for this example 0 kPa is the lower point. After the reading is stable, push  to confirm, then the screen will prompt the user for the next calibration point, which in this example is 100kPa (the upper range), as shown in Figure 7. User can also change this calibration point by inputting the desired value. If there is no need to adjust, push  to continue.

(4) To calibrate upper range point: Use the pressure source to control the upper range pressure, 100 kPa. After the reading is stable push  to confirm, then the screen should be shown as in Figure 9, which means the calibration procedure is completed.

**Remark: To calibrate a compound pressure gauge, use almost the same procedures as the above. There is one more point need. When checking zero, the icon **Mid** will be displayed on the screen.**

### 7.4 Cancel Calibration

Access the second function **20-11** of the calibration menu, as shown in Figure 9. Then push the button , the screen should be shown as Figure 10, which means the calibration has been canceled.

Means have been calibrated      Means calibration take effect

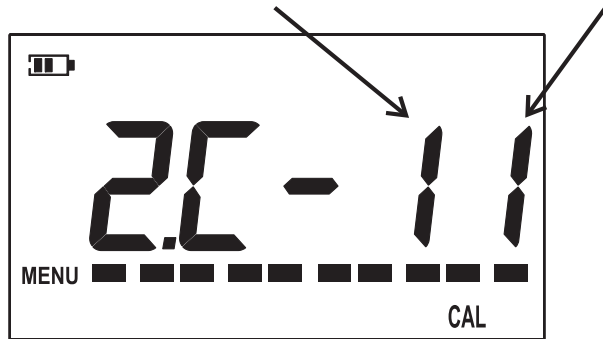

Figure9

Means have been calibrated      Means calibration has been canceled

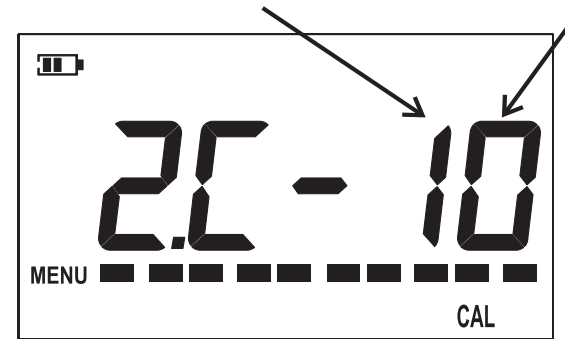

Figure10









## 8 Troubleshooting

ERR1 displayed: Beyond zeroing range of 2%FS

ERR2 displayed: Sensor data out of limit, contact Additel Corporation

ERR3 displayed: Sensor damaged, contact Additel Corporation







## 9 Custom Unit Entry

- (1) Press and hold  key to enter the menu.
- (2) Press  key until you see TOOL at the bottom. Then press  to enter the TOOL menu.
- (3) Press  key until you see 5.COE and press . Now you should see the custom factor (Number x kPa). The default number is 1.
- (4) Press  again to adjust the number. Now you should see 00001 with the first zero flashing. The flashing number is what can be adjusted. Note that at this point we are not modifying the decimal, just the main integers (i.e. ones, tens, etc). The decimal adjustment will be step 6.
- (5) Use  key to scroll to the desired number. Then use the BACK LIGHT key to sequence the number up. When you have the desired number press  to enter the value.
- (6) Now you will see 0.0000 with the first decimal flashing. Adjust the number in the same way as step 5 and press  to accept the value.
- (7) Now you should see the adjusted value on the display. This is the custom unit factor.

**Important Note:** If the value returns to the default number of 1, then it is likely the value you tried to enter is not supported by the 5-digit resolution of the gauge. For example, the



resolution is only 5 digits, so the max any gauge can display is 99999. If you have a 100 kPa (GP15) gauge and put a custom unit of 900 then the custom will be accepted because the max pressure of this gauge would display as 90000 (100 kPa x 900). But if you try and program 1000 as my custom unit it will not be accepted because the max value would be above the 5 digit resolution (100 kPa x 1000 = 100000 kPa).

- (8) To display the custom unit exit back to the main display. Press and hold  key to enter the menu and scroll over to  menu. Press  to enter the menu. By pressing  key you can cycle through the engineering units available. When you reach your custom unit, the whole number will be flashing. To accept this press  and exit out to the main display.
- (9) Press  key to cycle through the unit selections available. The custom unit is indicated by the Unit icon in the bottom right of the display.

## 10 Specifications

### Pressure Ranges

Gauge Pressure					
P/N	Pressure range (psi) <sup>1</sup>	Pressure range (bar)	Media <sup>2</sup>	Accuracy (%FS)	Burst Pressure
V15	-15	-1.0	G, L	0.05 (0.1, 0.25)	3X
GP15	15	1.0	G, L	0.05 (0.1, 0.25)	3X
GP30	30	2.0	G, L	0.05 (0.1, 0.25)	3X
GP100	100	7.0	G, L	0.05 (0.1, 0.25)	3X
GP300	300	20	G, L	0.05 (0.1, 0.25)	3X
GP500	500	35	G, L	0.05 (0.1, 0.25)	3X
GP1K	1,000	70	G, L	0.05 (0.1, 0.25)	3X
GP3K	3,000	200	G, L	0.05 (0.1, 0.25)	3X
GP5K	5,000	350	G, L	0.05 (0.1, 0.25)	3X
GP10K	10,000	700	G, L	0.05 (0.1, 0.25)	2X
GP15K	15,000	1,000	G, L	0.05 (0.1, 0.25)	2X
GP25K	20,000	1,600	G, L	0.1(0.25)	1.5X
GP30K	30,000	2,000	G, L	0.1(0.25)	1.5X
GP36K	36,000	2,500	G, L	0.1(0.25)	1.5X
Compound Pressure					
P/N	Pressure range (psi) <sup>1</sup>	Pressure range (bar)	Media <sup>2</sup>	Accuracy (%FS)	Burst Pressure
CP15	15	1	G	0.05 (0.1, 0.25)	3X
CP30	-15 to 30	-1 to 2	G	0.05 (0.1, 0.25)	3X

Note: [1]. Sealed gauge pressure for above 1,000 psi

[2]. G=Gas, L=Liquid (please specify media type when placing order)

Performance	
Recommended calibration period	One year
Update rate	10/Sec, 3/Sec (default), 1/Sec, 1/15Sec
Operating temperature	-10°C~50°C Guaranteed accuracy
Overload pressure	1.2X
Power Supply	
Battery	2 x AA alkaline (LR6) batteries Recommend: Duracell MX1500 , EnergizerE91, Panasonic LR6, GP 15AU
Battery life	10/Sec:1,500 Hours, 3/Sec:3,000 Hours, 1/Sec:6,000 Hours, 1/15Sec:12,000 Hours
Rated Power	
Rated	3.0 VDC I <sub>max</sub> =30 mA P <sub>max</sub> =90 mW
Material	
Wetting parts	Wetted surface: All wetted surfaces are 316L stainless steel with welded design for gauges ≤10,000 psi (no O-ring, thread tape, epoxy, or sealant on any part of the sensor assembly), and copper O-ring design for gauges > 10,000 psi.
Case	PC+ABS
Protecting cover	Silicone Rubber

Display	
LCD specification	FSTN-LCD, Visual scope 36 x 61 mm; Full 5 digit, 15.2 mm High; 7-segment analog bargraph scaled to 0~100% of FS
Backlight	White
Wireless Communication(optional)	
Wireless frequency	2.4G ISM Bands, 20 meter range
Number of channels	15
Software	Additel/Land software available for free download at <a href="http://www.additel.com">www.additel.com</a> . Additel/Log II Wireless available for purchase.
Storage	
Storage capacity	140,000 records, recorded contents include time, pressure and temperature
Storage interval	1~9999Sec, user selectable
Certificates	
Certificates	CE R&TTE, FCC ID, IC ID
Protection level	IP67
Vibration	5g ( 20~2,000Hz )
Shock resistance	100g/11ms

Others	
Dimensions	Φ100 mm x 40 mm, total height: 157 mm (4" x 1.6" x 6.2")
Weight	500 g (1.1 lbs)
Fitting	1/4 NPT, 1/2 NPT, 1/4BSP, M20 1.5, autoclave (male or female) or custom-made
Additional functions	
Auto off	Disabled, 15, 30, 45, 60, 90, 120 minutes , user selectable.
Filtering	Averaging (3 to 10 samples) or low-pass first-order filter.
Engineering units	Pa, kPa, mPa, bar, mbar, psi, kgf/cm <sup>2</sup> , mmH <sub>2</sub> O, mmHg, inH <sub>2</sub> O, inHg, ozf/in <sup>2</sup> , %, °C, °F Extend units: inH <sub>2</sub> O(20°C), inH <sub>2</sub> O(60°F), mmH <sub>2</sub> O(20°C), mmH <sub>2</sub> O(15°C), ftH <sub>2</sub> O(60°F), ftH <sub>2</sub> O(4°C) This allows users to set a multiplier factor to be multiplied by the kPa measured pressure. For example: 2 kPa=0.02 bar (2*0.01) , factor : 0.01 , a 2 kPa pressure will display as 0.02. (ADT680 can be set by the factory or via the Land/Wireless software) )
Backlight duration	Disable auto off, 15,30,45,60 seconds , user selectable
Max/Min data capture	Capture the Max and Min data during pressure measurement
Key lockout	To avoid mis-operations. When the gauge is in auto-storing status, buttons will be locked automatically.
Overpressure alarm	Display will flash over 120%FS
Battery voltage measurement	To measure and display the battery voltage. When the battery voltage is too low, gauge will be power-off automatically.

Additional functions	
Overpressure records	View the 5 most recent over pressure records by inputting pass word “888” in the Calibration menu, when screen is shown as Figure 2, Page10.
Leakage test	Detect pressure leakage over a period of time. The gauge will auto-record beginning pressure value, ending pressure value and leakage $\Delta P$ .
Factory reset	Reset all the settings back to factory default settings, except for the calibration parameter.
Automatic zeroing	Once automatic zeroing function is activated, the measured value is less than 0.01% of full scale, and this situation maintains more than 10 seconds, the gauge will automatically zero.
Tare/Offset reading	This function can be used to subtract a constant value from the measured pressure. For example: If the tare or offset point is set to 50 psi, and the measured pressure is 80 psi, then 30 psi will be displayed.

### 11 Warning

- Remaining battery life is displayed, if the gauge automatically power off, please replace a new battery
- To prevent a dangerous pressure release, isolate and bleed the system before disconnecting a pressure connection.
- Do not change the any of the components or inside structure of this gauge;
- To prevent damage, do not use ADT680 for long periods of time in an over pressure condition;

## 12 FCC Declaration of Conformity

Changes or modifications not expressly approved by the party responsible for compliance could void the user's authority to operate the equipment.

This device complies with part 15 of the FCC rules. Operation is subject to the following two conditions:

- (1) This device may not cause harmful interference, and
- (2) this device must accept any interference received, including interference that may cause undesired operation

FCC & IC Radiation Exposure Statement: this equipment complies with FCC radiation exposure limits set forth for an uncontrolled environment and meets the exemption from the routine evaluation limits in section 2.5 of RSS 102.

This device complies with Industry Canada license-exempt RSS standard(s). Operation is subject to the following two conditions:

- (1) this device may not cause interference, and
- (2) this device must accept any interference, including interference that may cause undesired operation of the device.

Le présent appareil est conforme aux CNR d'Industrie Canada applicables aux appareils radio exempts de licence. L'exploitation est autorisée aux deux conditions suivantes :

- (1) l'appareil ne doit pas produire de brouillage, et
- (2) l'utilisateur de l'appareil doit accepter tout brouillage radioélectrique subi, même si

This equipment has been tested and found to comply with the limits for a Class B digital device, pursuant to part 15 of the FCC rules.

These limits are designed to provide reasonable protection against harmful interference in a residential installation.

This equipment generates, uses and can radiate radio frequency energy. If not installed and used in accordance with the instructions, may cause harmful interference to radio communications. However, there is no guarantee that interference will not occur in a particular installation.

If this equipment does cause harmful interference to radio or television reception, which can be determined by turning the equipment off and on, the user is encouraged to try to correct the interference by one or more of the following measures:

- Reorient or relocate the receiving antenna.
- Increase the separation between the equipment and receiver.
- Connect the equipment into an outlet on a circuit different from that to which the receiver is connected.
- Consult the dealer or an experienced radio/TV technician for help.

This device complies with part 15 of the FCC rules. Operation is subject to the following two conditions:

- (1) This device may not cause harmful interference, and
- (2) this device must accept any interference received, including interference that may cause undesired operation.



### 13 Battery installation

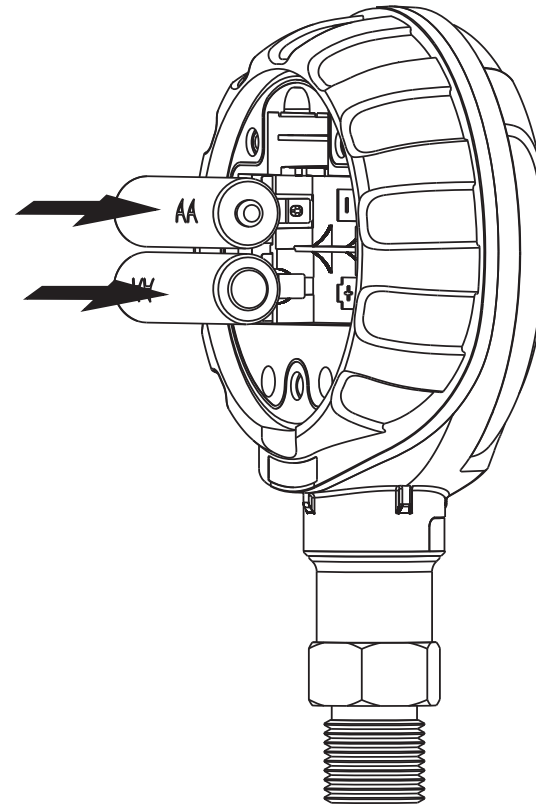
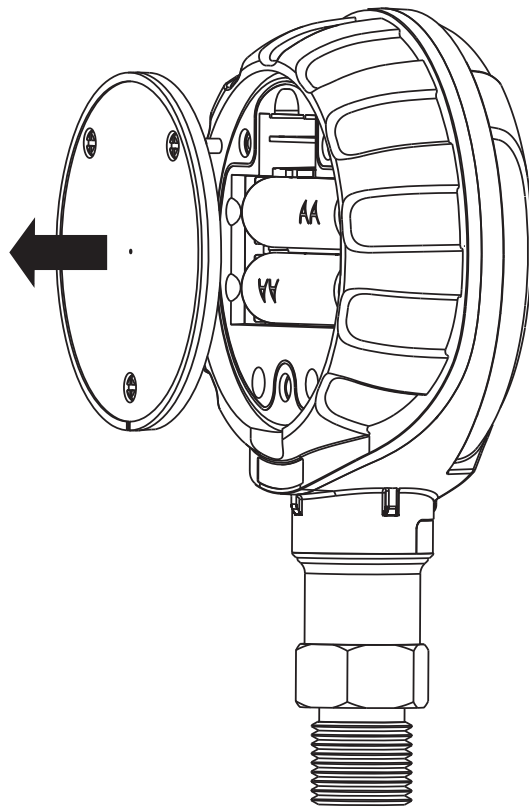

## 14 Ordering information

Model Number

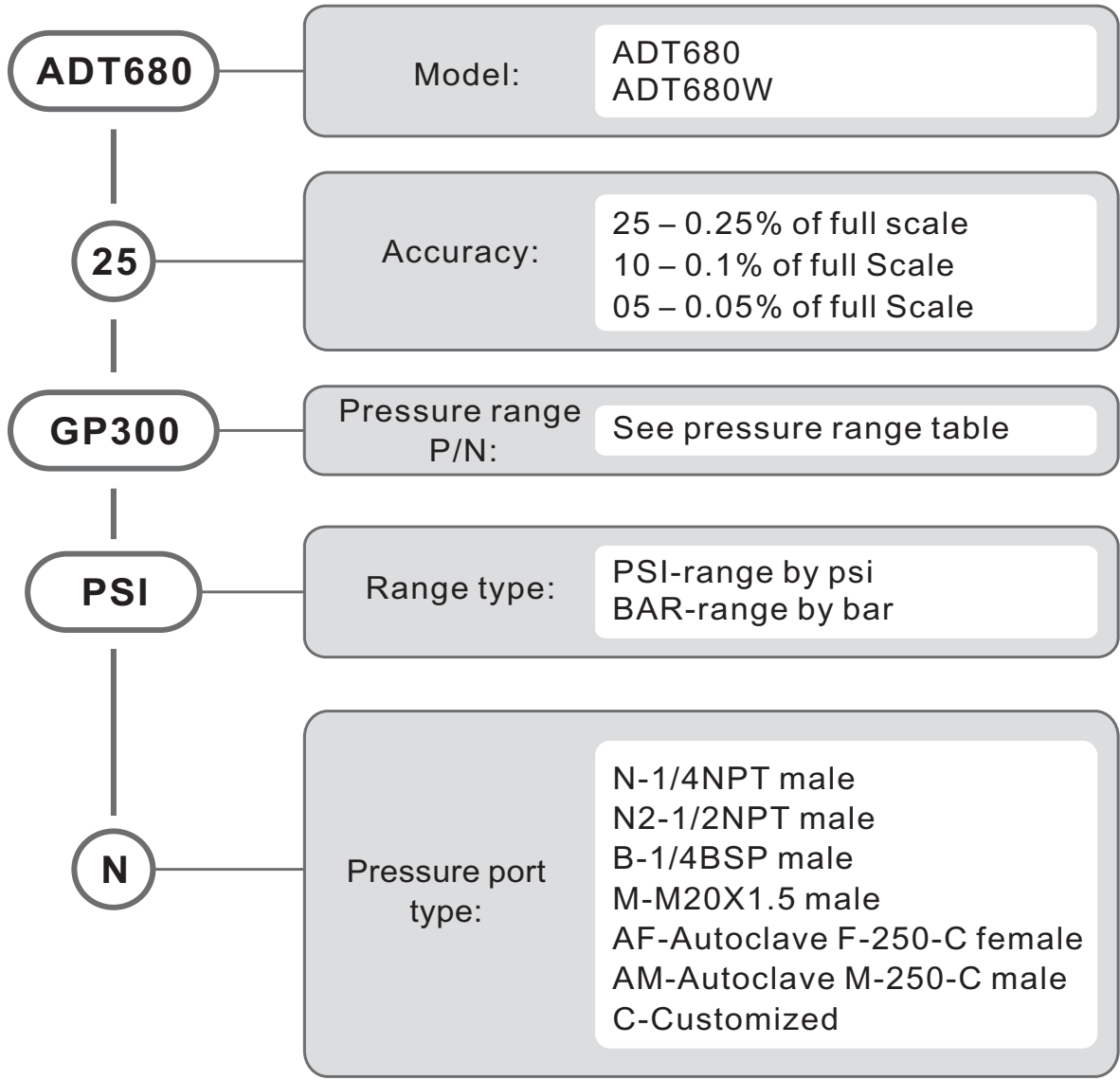

**NOTE:**  
**ADT680W with wireless and data logging**

### Accessories(included)



- AA alkaline(LR6)battery(2 pc)
- Manual
- NIST traceable calibration certificate
- Model 9253 Rubber protective boot
- Additel/Land Wireless software for 680W (free download at [www.additel.com](http://www.additel.com))

### Optional Accessories

Model number	Description
9503	Additel/Log II Wireless real time data logging and graphical software for 680W
9030	Spare wireless master device (USB dongle) for ADT 680W gauge.

## 15 Appendix I– Data logging

### Data logging introduction

- (1) Push and hold  button to access to menu setup mode and move to log function.
- (2) If the data logging is ongoing, the gauge screen will show "ON" and the  icon, otherwise "OFF" will be shown.
- (3) Data logging menu structure as shown in the figure below

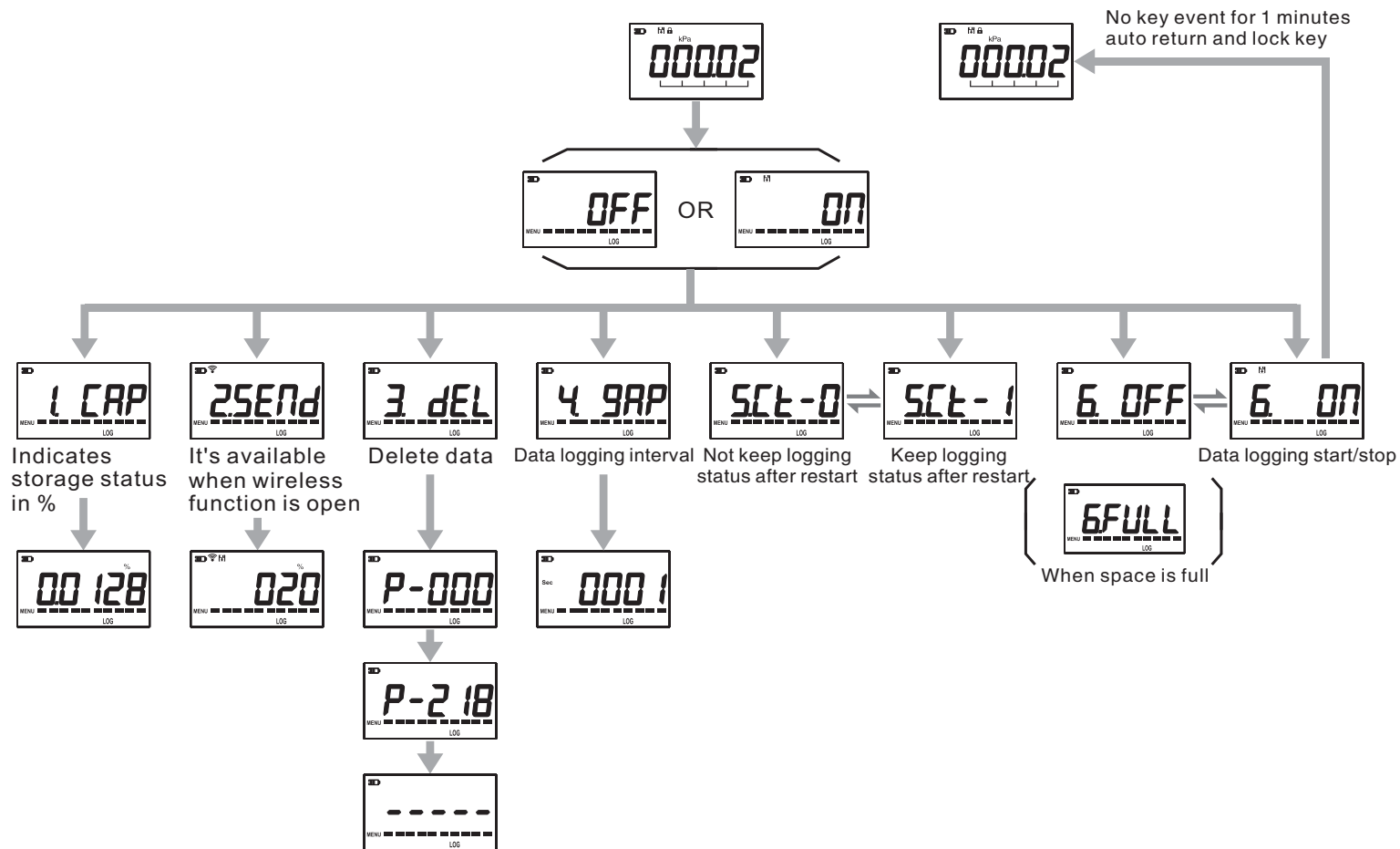



## **Additel Corporation**

2900 Saturn St #B

Brea, CA 92821, USA

Phone: 714-998-6899

Email: [service@additel.com](mailto:service@additel.com)

website: [www.additel.com](http://www.additel.com)